

**** Note:**

Two assemblies are required; one for each side of the ramp, showing those services in each particular direction from the ramp terminal.

Ramp mounted signs shall be installed to avoid conflict with existing signs and in no case should they be placed within 100' of another sign.

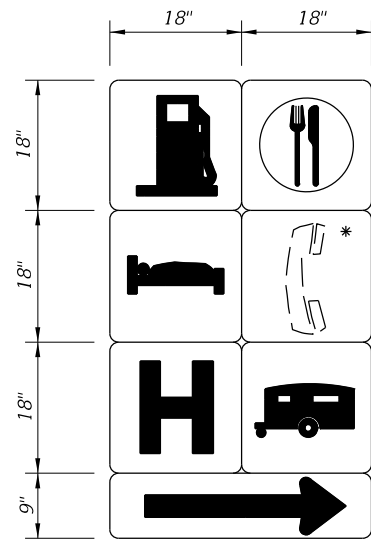

DETAIL "D"

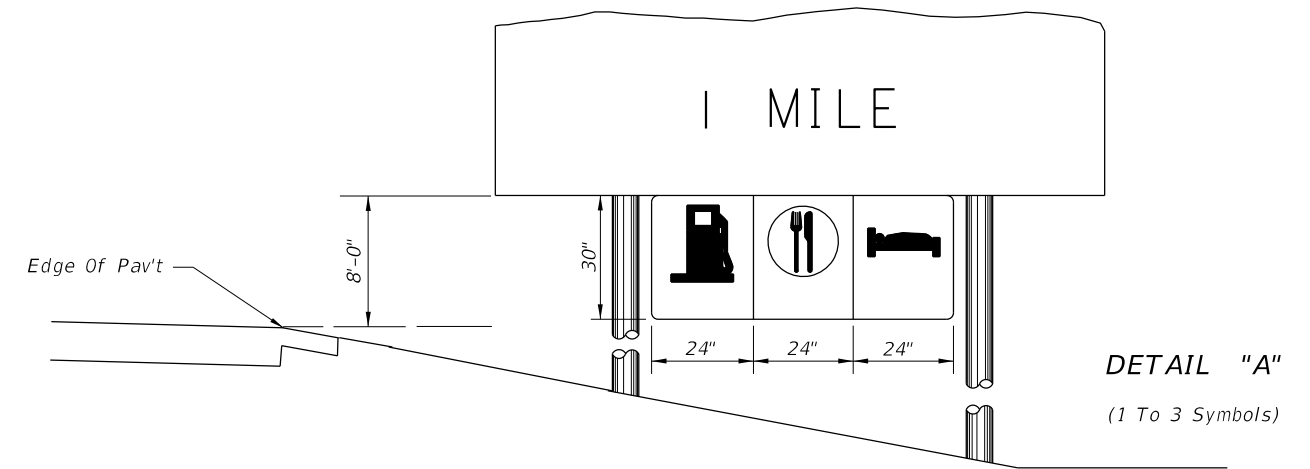

DETAIL "A"
(1 To 3 Symbols)

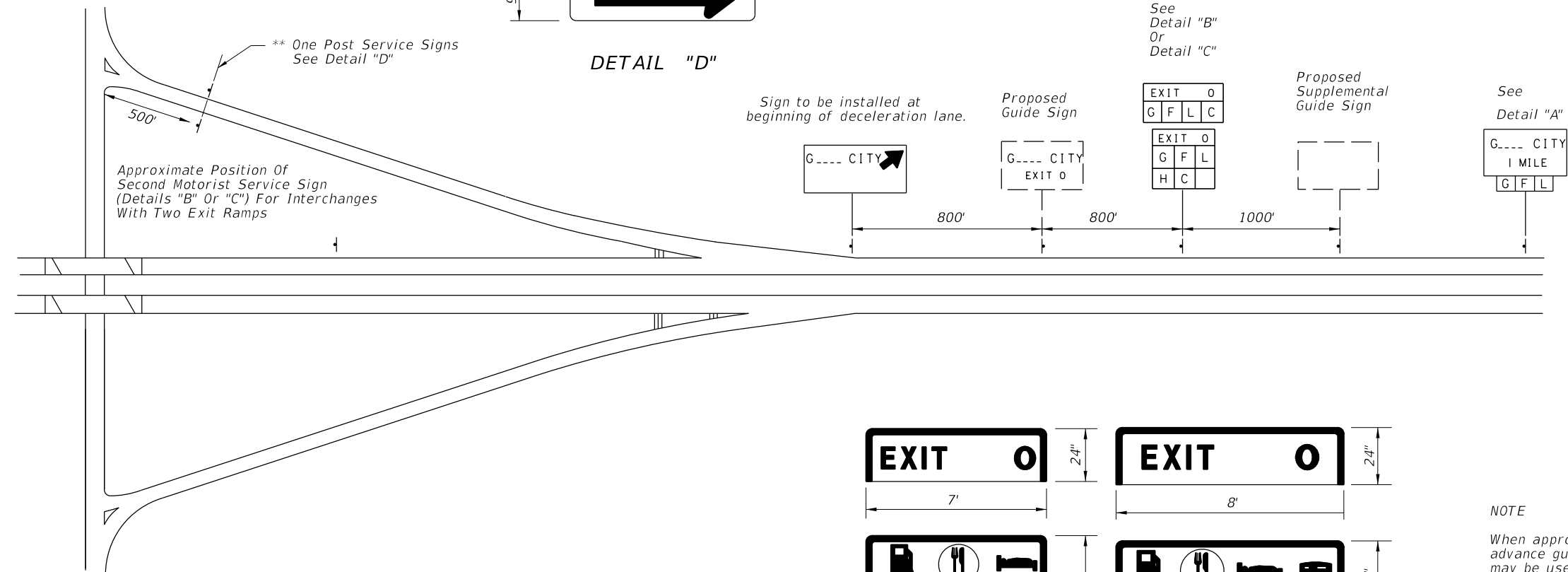

GENERAL NOTES

1. Only those services meeting criteria established by the Department and approved by the State Traffic Operations Engineer for each interchange shall be shown. Symbol signs for motorist services shall always appear in the following order reading from left to right and top to bottom: Gas, Food, Lodging, Phone *, Hospital, Camping.
* The phone symbol shall not be shown whenever any Gas, Food, Lodging or Camping symbol appears.
2. Symbols shall appear consecutively on the sign with no positions left blank or reserved for intermediate symbols not currently approved for a particular interchange.
3. All motorist service signs to have White Legend and Border with Blue Background.
4. For mounting details see Index 700-020 for Type "A" breakaway or Index 700-010 for Type "C" Frangibility.

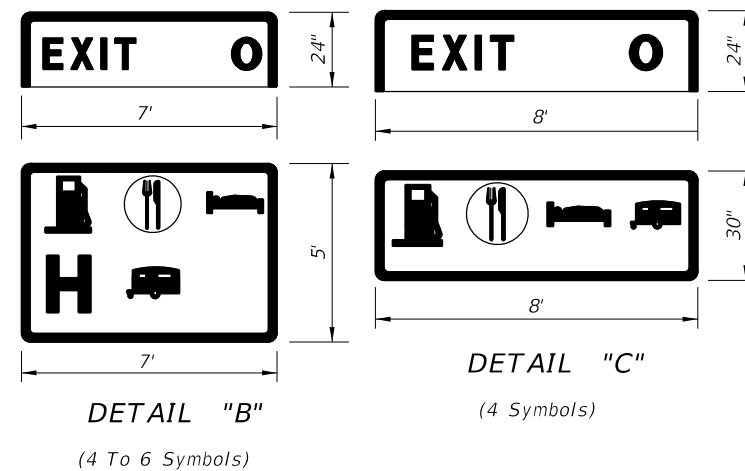

DETAIL "B"
(4 To 6 Symbols)

DETAIL "C"
(4 Symbols)

NOTE

When approved for attachment to the advance guide signs, up to 3 services may be used for an exit. The symbol signs shall be suspended from the guide sign panel or existing wind beams. Symbol signs are not to be connected to existing sign posts.

The mounting height of the advance guide sign shall be increased, where necessary, to provide 8' between the level of the pavement edge and the bottom of the guide sign, prior to mounting the supplementary panel.

9/19/2018 1:30:00 PM

LAST REVISION 11/01/17	REVISION	DESCRIPTION:		FY 2019-20 STANDARD PLANS	SIGNING FOR MOTORIST SERVICES	INDEX 700-104	SHEET 1 of 1
---------------------------	----------	--------------	--	------------------------------	-------------------------------	------------------	-----------------