

**GENERAL NOTES:**

1. Install conduit in accordance with Specification 630.
7. When installing conduit under sidewalk by open trench, replace the entire sidewalk slab.
3. Trench not to be open more than 250' at a time when construction area is subject to vehicular or pedestrian traffic.
4. Sawcut asphalt at the edges of the trench to leave neat lines.

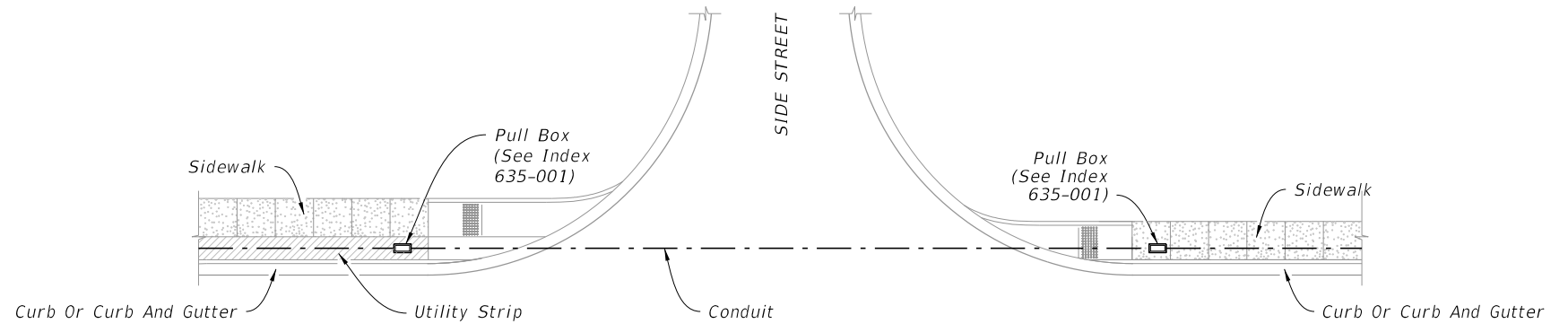

PLAN

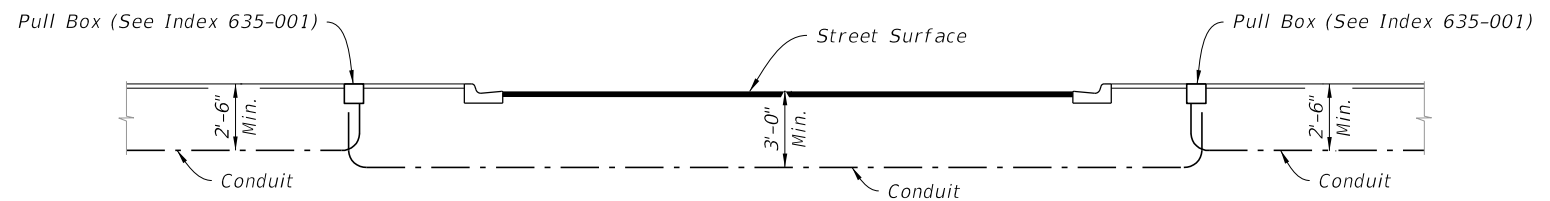

ELEVATION

=====**CURB AND GUTTER**=====

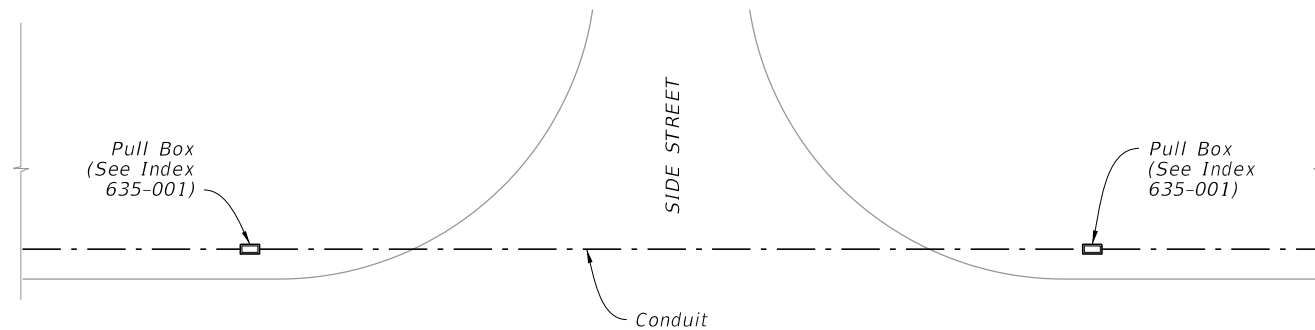

PLAN

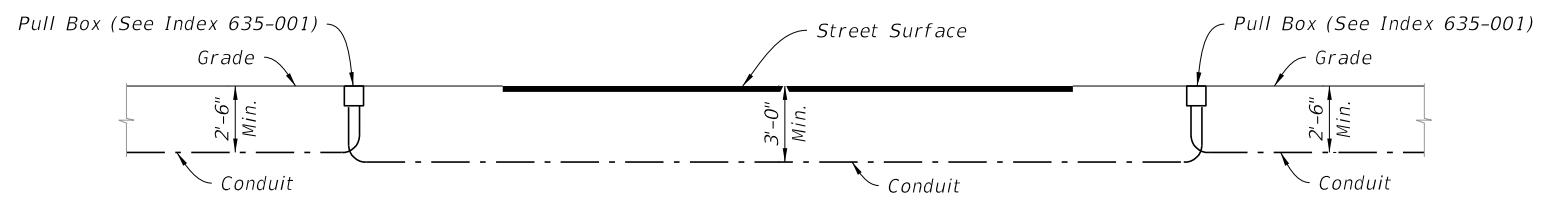

ELEVATION

=====**FLUSH SHOULDER**=====

10/18/2018 11:48:34 AM

LAST REVISION 11/01/18	REVISION	DESCRIPTION:	 <b>FY 2019-20 STANDARD PLANS</b>	<b>CONDUIT INSTALLATION DETAILS</b>	INDEX <b>630-001</b>	SHEET <b>1 of 4</b>
------------------------------	----------	--------------	-------------------------------------------------------------------------------------------------------------------------------	-------------------------------------	-------------------------	------------------------

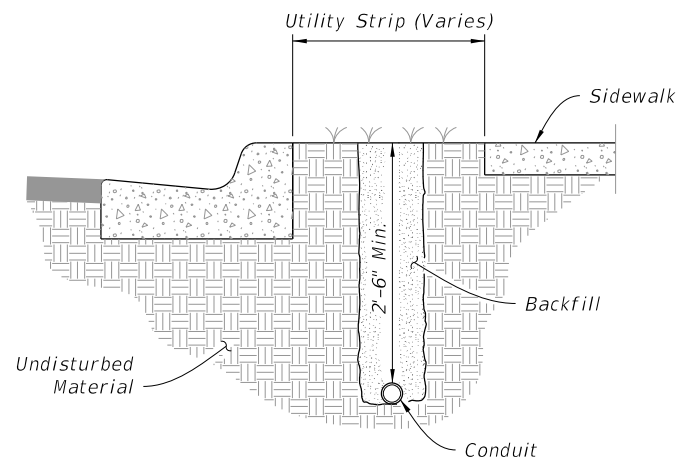

PLACEMENT WITHIN THE UTILITY STRIP

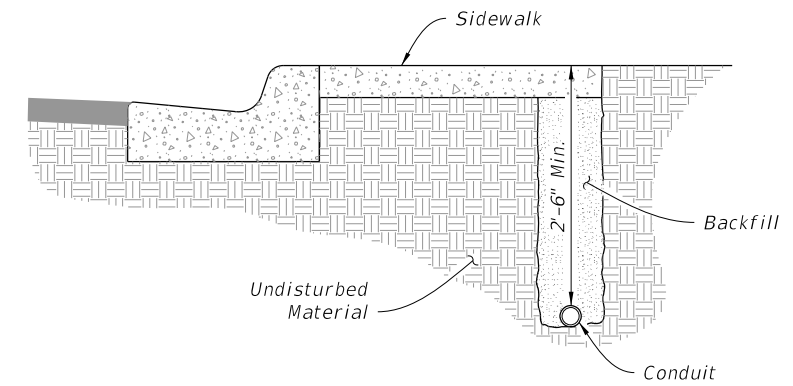

PLACEMENT UNDER SIDEWALK

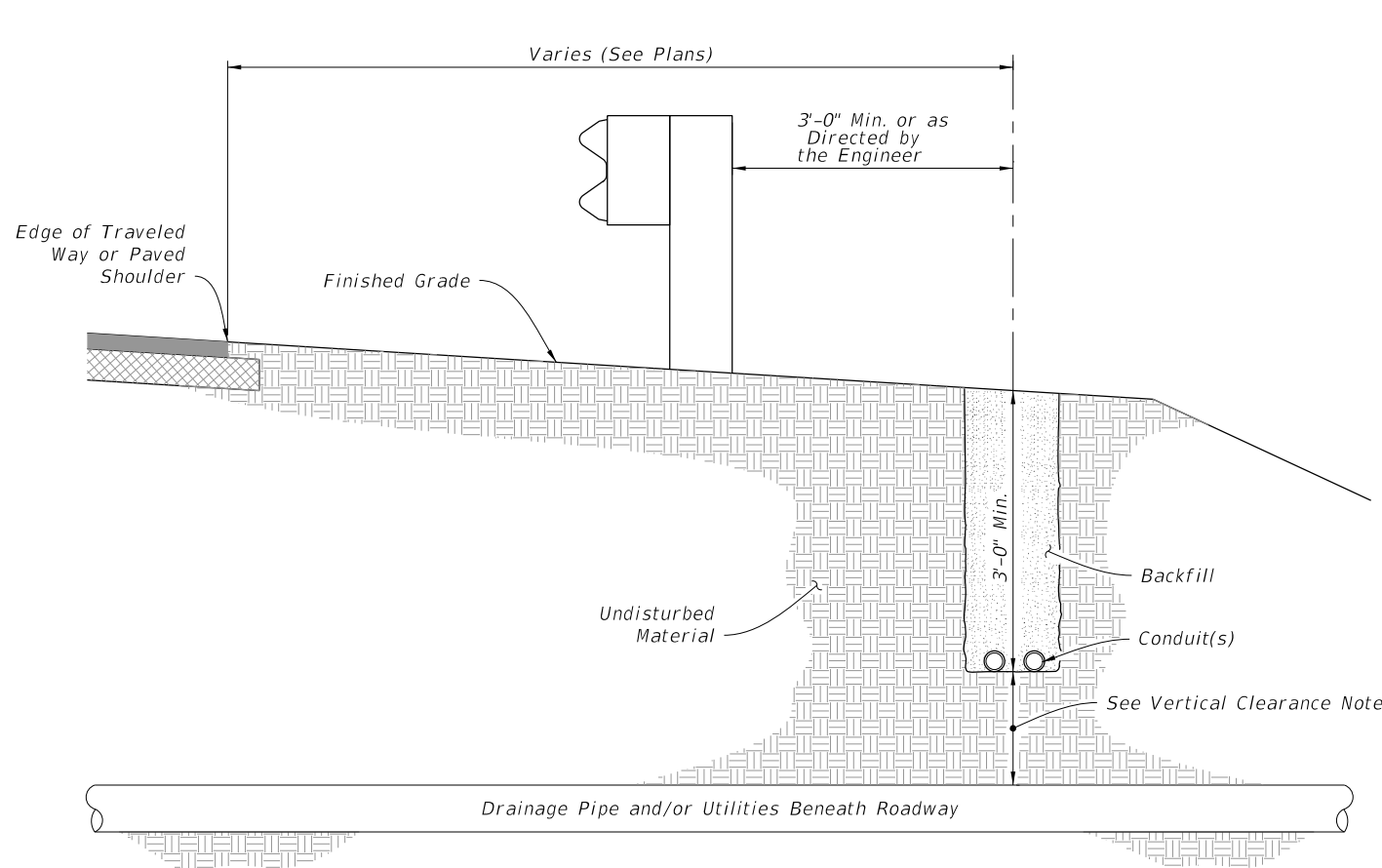

PLACEMENT BEHIND GUARDRAIL

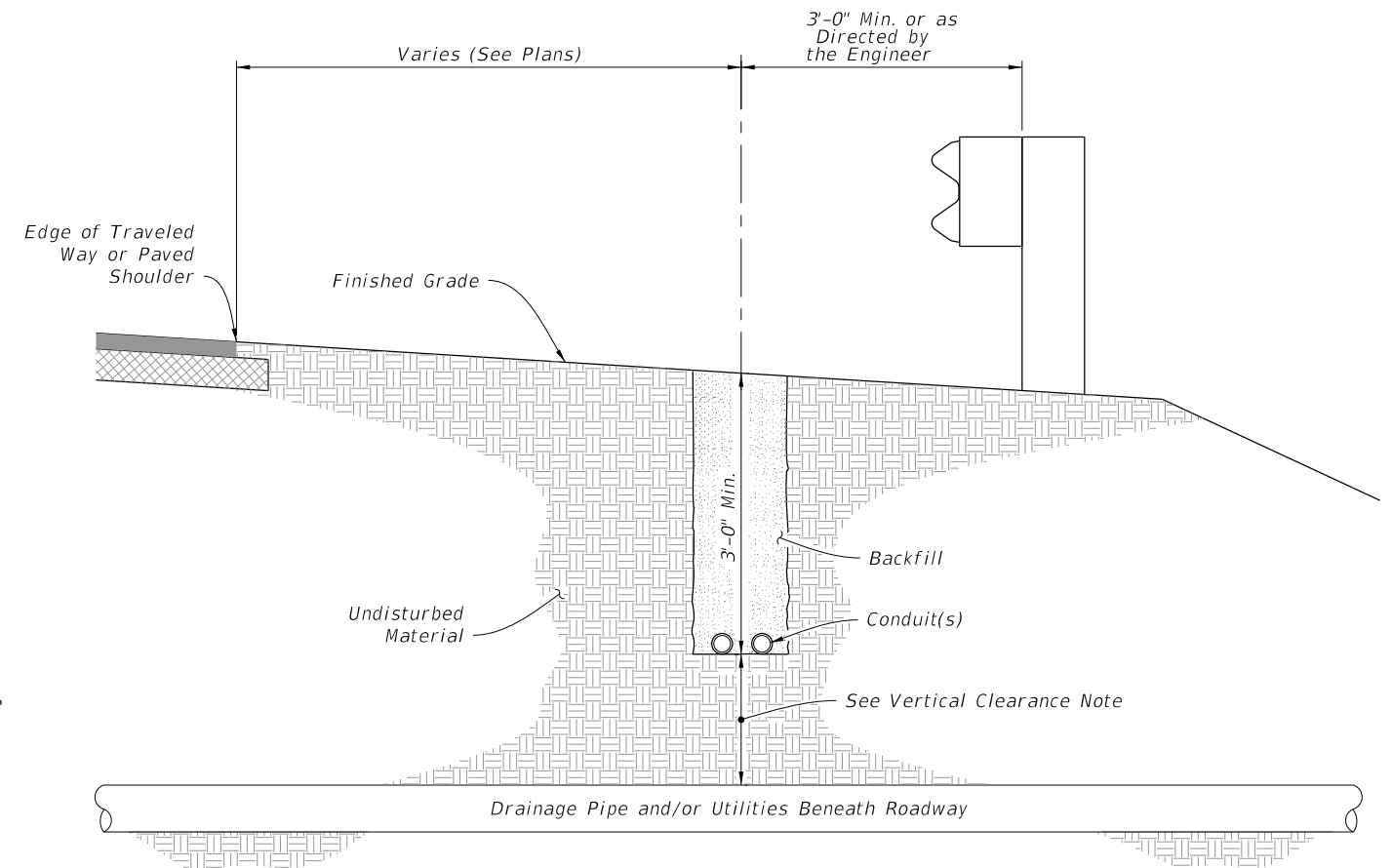

PLACEMENT IN FRONT OF GUARDRAIL

**VERTICAL CLEARANCE NOTE:**

Maintain 1'-0" minimum vertical clearance when crossing over pipe and or utilities.  
If minimum vertical clearance cannot be maintained, conduit is to be routed under pipe maintaining 1'-0" minimum vertical clearance.

10/18/2018 11:48:35 AM

LAST REVISION 11/01/18	DESCRIPTION:	 FY 2019-20 STANDARD PLANS	CONDUIT INSTALLATION DETAILS	INDEX 630-001	SHEET 2 of 4
---------------------------	--------------	--------------------------------------------------------------------------------------------------------------------	------------------------------	------------------	-----------------

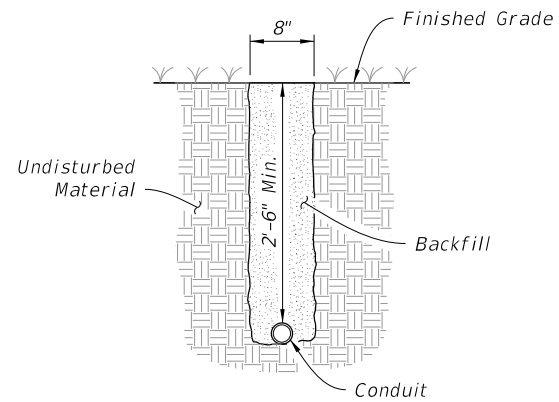

PLACEMENT NOT EXPOSED  
TO VEHICULAR TRAFFIC

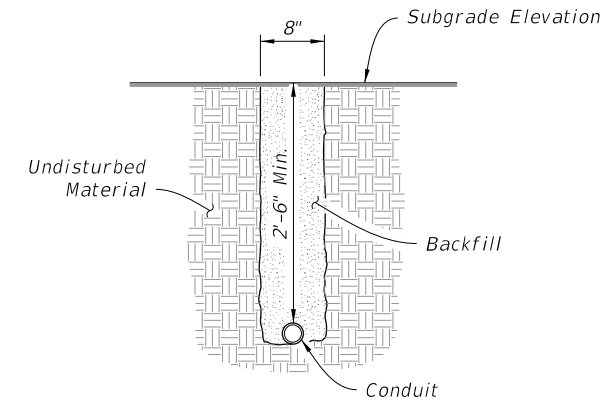

PLACEMENT UNDER NEW ROADWAY  
PRIOR TO INSTALLATION OF  
BASE AND PAVEMENT

**NOTES:**

1. Pavement Removal: The removal and replacement of the additional pavement width (i.e., 6" Width either side of trench) will not be required when the trench can be constructed without disturbing the asphalt surface on either side.
2. Placement Under Existing Pavement: Place conduit prior to installation of base and pavement, unless otherwise shown in the Plans or approved by the Engineer.

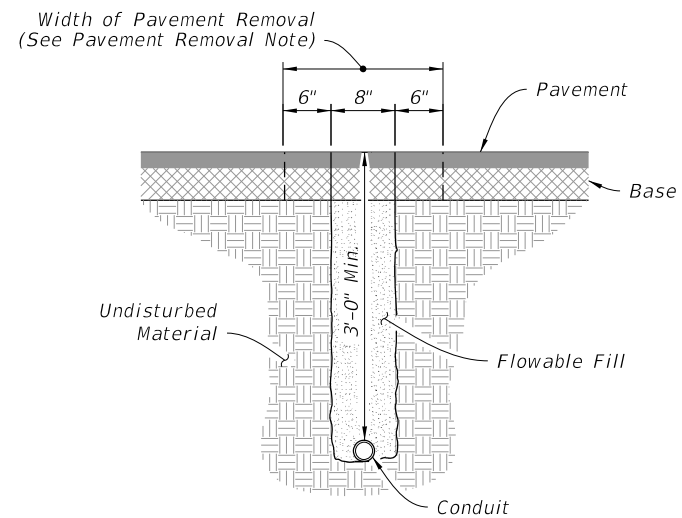

PLACEMENT UNDER EXISTING PAVEMENT  
NOT ADJACENT TO GUTTER

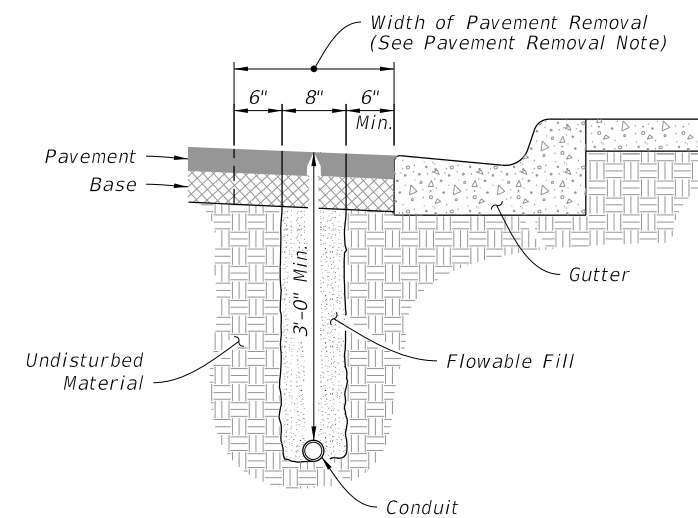

PLACEMENT UNDER EXISTING PAVEMENT  
ADJACENT TO GUTTER

10/18/2018 11:48:36 AM

LAST REVISION 11/01/18	REVISION	DESCRIPTION:	 FY 2019-20 STANDARD PLANS	CONDUIT INSTALLATION DETAILS	INDEX 630-001	SHEET 3 of 4
---------------------------	----------	--------------	-----------------------------------------------------------------------------------------------------------------------	------------------------------	------------------	-----------------

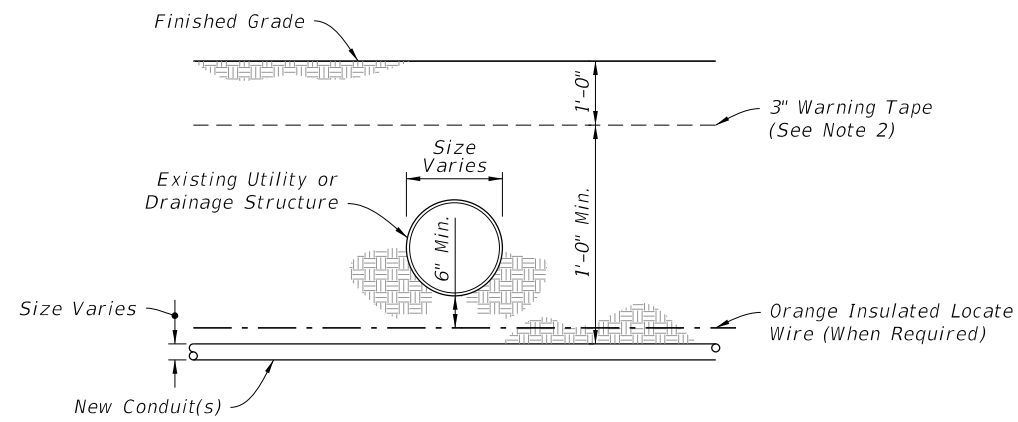

BELOW EXISTING

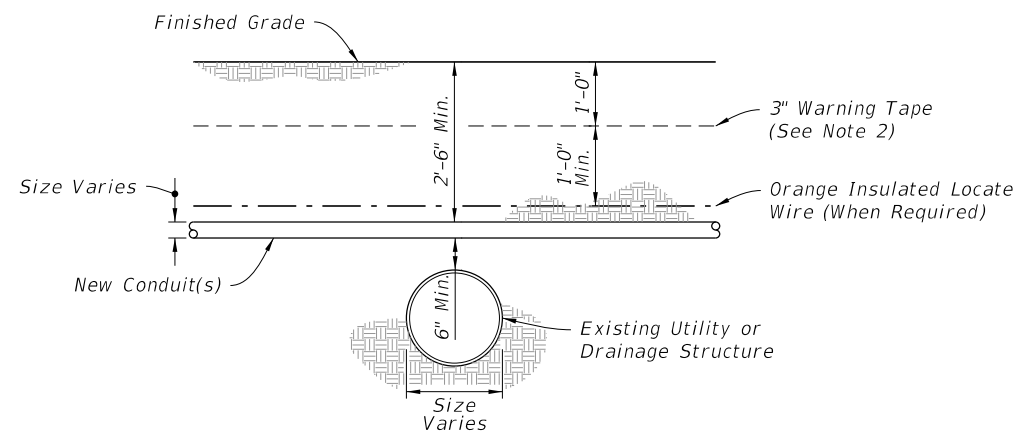

ABOVE EXISTING - DEPTH 2'-6" OR GREATER

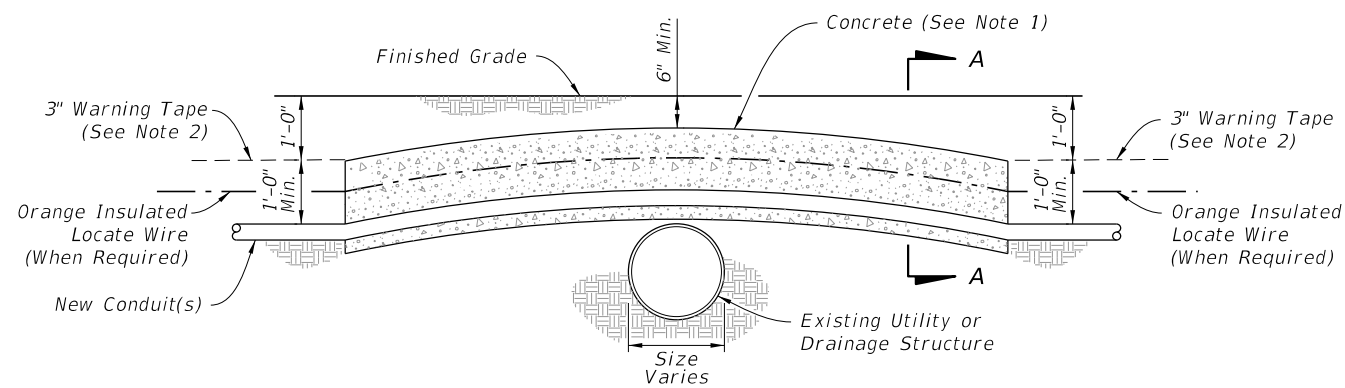

ABOVE EXISTING - DEPTH 2'-6" OR LESS

PLACEMENT ACROSS EXISTING DRAINAGE PIPES OR UTILITIES

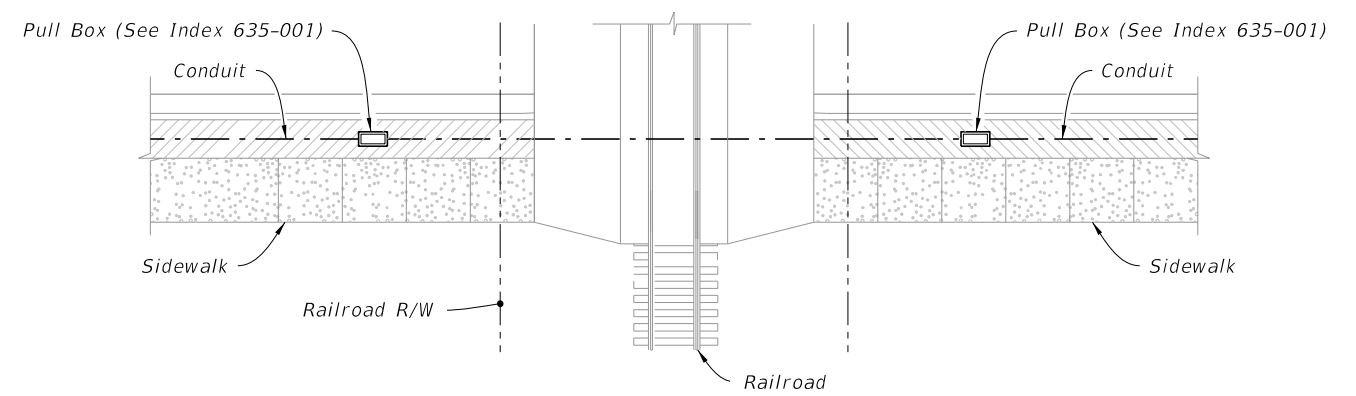

PLAN

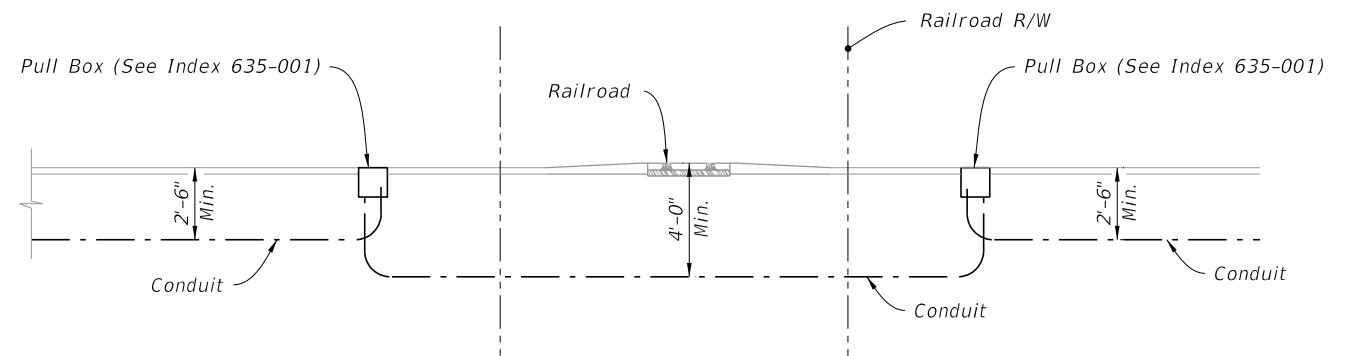

PLACEMENT UNDER RAILROAD

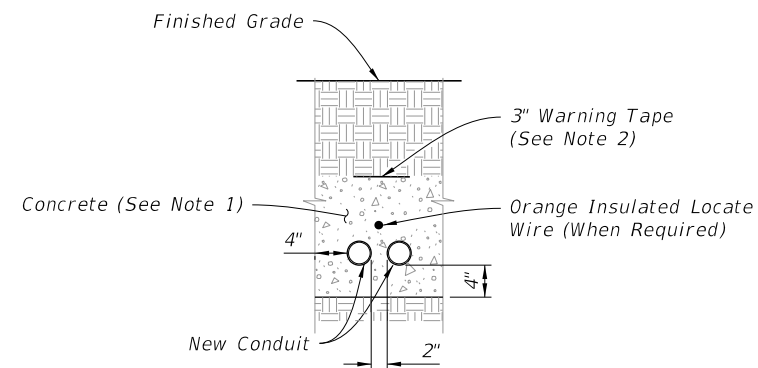

SECTION A-A

NOTES:

1. Where conduits are to be installed over existing underground structures (e.g., drainage pipes or utility lines) which are less than 2'-6" deep, encase the conduit in Class NS concrete for the entire length of conduit that is installed at a depth of less than 2'-6".
2. Place 3" Warning Tape when new conduit is installed at a depth of 1'-6" or greater, and the new conduit is not encased in concrete.

5/20/2020 7:36:36 AM

LAST REVISION 11/01/18	DESCRIPTION:	 FY 2019-20 STANDARD PLANS	CONDUIT INSTALLATION DETAILS	INDEX 630-001	SHEET 4 of 4
---------------------------	--------------	-----------------------------------------------------------------------------------------------------------------------	------------------------------	------------------	-----------------