

GENERAL NOTES

1. This fence to be provided generally in rural areas. For supplemental information see Specifications 550.
2. Fabric shall be woven wire, either galvanized steel, meeting the requirements of ASTM A116, No. 9 Grade 60, Design Number 1047-6-9, with Class 3 zinc coating; No. 12 1/2 Grade 175, Design Number 1047-6-12 1/2, with a 10 1/2 gage top and bottom wire and with Class 3 zinc coating; or aluminum coated steel, meeting the requirements of ASTM A584, No. 9 Farm, Design Number 1047-6-9, with a minimum coating weight of 0.40 oz./ft.². For additional information see payment note below.
3. Fence shall be installed with wire side to private property except on horizontal curves greater than 3° the fence shall be installed so as to pull against all posts.
4. Posts may be either timber, steel, recycled plastic or concrete. Unless a specific post material is called for in the plans, the Contractor may elect to use either a single material or a combination of timber, steel, recycled plastic or concrete materials, but must comply with the electrical grounding requirements in Specifications 550. Line posts of one material may be used with corner, pull and end post assemblies of a different material. Line posts of only one optional material and pull post assemblies of only one optional material will be permitted between corner and end post assemblies. Within individual corner and end post assemblies only one optional material will be permitted.
5. Timber posts shall meet the material requirements of Specification 954. Timber line posts are to be minimum 4" diameter. Timber corner, pull, approach and end posts are to be a minimum 5" diameter. Timber braces are to be minimum 4" diameter.
 - (A) Staples for line posts to be 1 1/4" minimum length; for approach, corner and pull posts 1 1/2" minimum length. At approach, corner and pull posts, staple every line wire in top half and alternate line wires in bottom half. Staples shall be driven diagonally across the line wire with the points in separate grains.
 - (B) Connections between timber posts and braces to be provided by dowels as shown in fastener details.
 - (C) Wire to be wrapped and tied, as shown in the splice details, at the following locations:
 - (a) All end posts, (b) Corner post, including the assemblies at vertical breaks of 15° or more and (c) Pull posts where the wire is not spliced and pulled through the assembly; see General Note 18.
6. Steel posts and braces shall be standard steel posts, galvanized at the rate of 2 oz./ft.², together with necessary hardware and wire clamps and meeting the following requirements:
 - (A) Line posts: 8' long; 1.33 lbs./ft.; roll formed studding; anchor plate attached, ASTM A702 (18 in.²).
 - (B) Approach posts: 2 1/2"x2 1/2"x1/4" angles, 8' long; fabricated for attaching brace; with necessary hardware, clamps, etc.
 - (C) Pull, end and corner posts: 2 1/2"x2 1/2"x1/4" angles, 8' long; fabricated for attaching brace; with necessary hardware, clamps, etc.
 - (D) Braces: 2"x2"x1/4" angles with necessary hardware and fabricated for attaching to post.
 - (E) The pull, corner, approach and end posts are to be set in concrete as per detail. (Also see General Note 15)
7. Recycled plastic posts shall meet the following material requirements: Line posts shall have a minimum section of 4" round or 4" square. Plastic posts shall not be used as corner, pull, end or approach posts unless such use is specifically detailed in the plans. The straightness of the post shall comply with Specification 954 for timber post. The flexural strength shall meet the requirements of the latest edition of the Southern Pine Inspection Bureau's Standard Grading Rules for Southern Pine Lumber for No. 2SR Stress Rated Grade Timber. Plastic posts can be set by either digging and tamped backfill or by driving into full depth preformed holes 1/4" to 1/2" smaller than cross section of post. Staples for fabric and barbed wire connection to plastic line posts shall be the same size, count and location as that for timber posts.
8. The Contractor, at his option, may use any suitable precast or prestressed concrete posts; however, approval by the Engineer, of posts not shown on this index, will be required prior to construction of the fence. Precast posts shall be Class I concrete. Prestressed posts shall be Class III concrete. Lengths of concrete post to be as indicated for timber posts.
9. Aluminum post, braces and accessory framing hardware shall not be used unless the plans specifically detail their application or the Engineer specifically approves their incorporation in fence construction or repair. Aluminum framed gates are permitted as described in General Note 19.
10. The woven wire shall be attached to steel and concrete posts by a minimum of five tie wires. The single wire ties shall be applied to the top, bottom and three intermittent line wires. The ends of each tie wire shall have a minimum of two tight turns around the line wire. Tie wires shall be steel wire not less than 0.120" diameter, zinc coating Class 3, soft temper, in accordance with ASTM A641.
11. Steel Barbed Wire can be either of the following types:
 - Type I: This type shall conform to the requirements of ASTM A121, with two strands of 12 1/2 gage wire; four-point barbs, wire size 14 gage, twisted around both line wires; and, Class 3 coating, Design No. 12-4-5-14R.
 - Type IIA: This type same as Type I except the two strand wires are twisted in alternating directions between consecutive barbs.
 - Type IIB: This type shall conform to the requirements of ASTM A121 with two strands of 15 1/2 gage high tensile wire; four-point barbs, wire size 16 1/2 gage twisted around both line wires; and Class 3 coating, Design No. 15-4-5-16R.
 Aluminum Barbed Wire shall be fabricated of two strands of 0.110-inch wire with 0.08-inch diameter four-point barbs spaced at approximately 5 1/2", and at a maximum spacing of 6". The wire for the strands and for the barbs shall be of ASTM B211M Alloy 5052-H38 or equal.
12. The woven wire shall be stretched only until one-half the tension curl has been pulled out of the line wires.
13. Posts to be set by driving or digging. If by digging, the posts shall be set at the center of the hole and the soil tamped securely on all sides.
14. Longer posts than those indicated above may be required by the plans or for deeper installations.
15. Concrete bases for angular steel posts (pull, corner, end and approach) shall be Class NS in accordance with Specification 347. Materials for Class NS concrete may be proportioned by volume and/or by weight.
16. Pull post assemblies shall be installed at approximately 330' centers except that this maximum interval may be reduced by the Engineer on curves where the radius is less than 3°.
17. Corner post assemblies are to be installed at all horizontal and vertical breaks in fence of 15° or more.
18. A maximum length of 1320' of wire may be installed as a unit. For pulls through a pull post assembly the fabric shall be spliced by crimping sleeves only. Pulls through a corner post assembly will not be permitted.
19. Unless otherwise called for in the plans gates shall be commercially available metal swing gates assembled and installed in accordance with the manufacturer's specifications as approved by the Engineer. Chain link swing gates in accordance with Index 550-002 may be substituted for metal swing gates as approved by the Engineer. Gate size is full opening width whether single leaf or double leaves. Payment for gates shall include the gate, single or double, all necessary hardware for installation and any additional length and/or size for posts at the opening. Gates shall be paid for under the contract unit price for Fence Gates, EA.
20. For construction purposes, assemblies are defined as follows: End post assemblies shall consist of: one end post, one approach post, two braces, four diagonal tension wires and all necessary fittings and hardware. Pull post assemblies shall consist of: one pull post, two braces, four diagonal tension wires and necessary fittings and hardware. Corner post assemblies shall consist of: one corner post, two approach posts, four braces, eight diagonal tension wires and all necessary fittings and hardware.
21. All posts, braces, tension wires, fabric, tie wires, Class NS concrete, and all miscellaneous fittings and hardware to be included in the cost for Fencing, LF. Fencing shall be inclusive of the lengths of pull, end and corner post assemblies, but exclusive of gate widths.

10/30/2018 1:40:38 PM

LAST REVISION 11/01/17	REVISION	DESCRIPTION:	 FY 2019-20 STANDARD PLANS	FENCE TYPE A	INDEX 550-001	SHEET 1 of 3
------------------------------	----------	--------------	---	--------------	------------------	-----------------

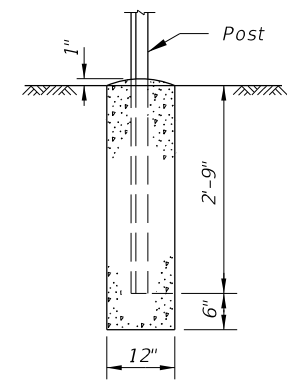
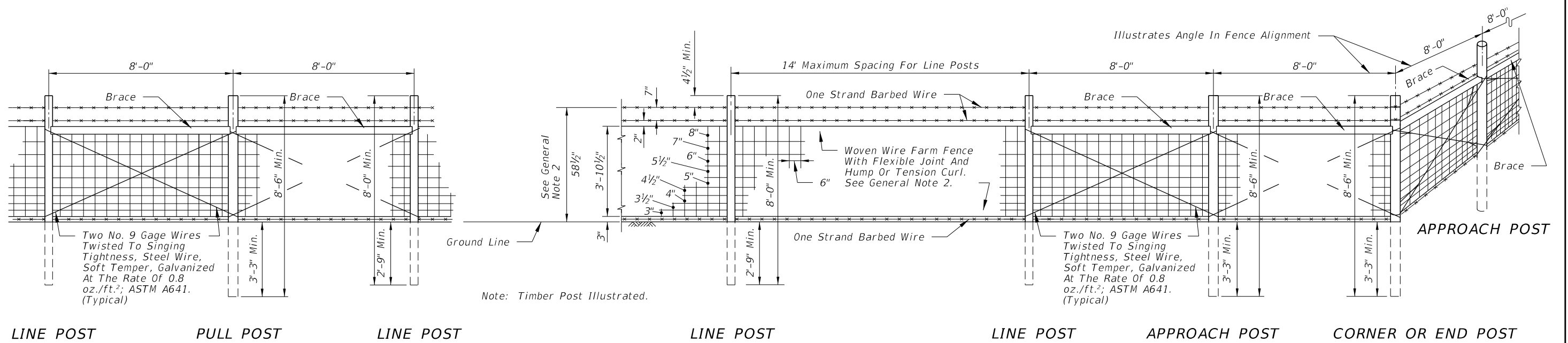

(Pull, Corner, End And Approach Posts)

CONCRETE BASE FOR ANGULAR STEEL POST

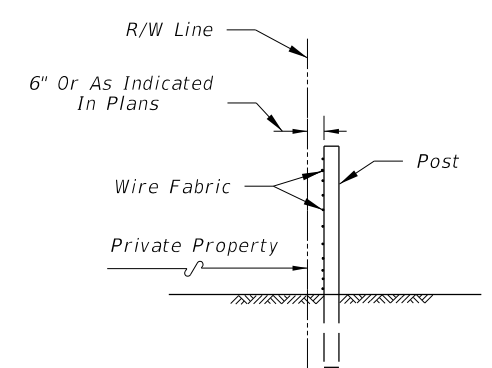

FENCE POSITION AT LOCATIONS WITHOUT FRONTAGE ROADS

(REFER TO DETAIL PLANS FOR FENCE POSITION AT LOCATIONS WITH FRONTAGE ROADS)

DESIGN NOTE

This index details fencing that is constructed with farm fabric 46 1/2" (47" nominal) in height and with specific ground clearance and specific barbed wire spacings. For fencing of different height or installation details, the fence shall be fully detailed in the Contract plans.

10/30/2018 1:40:41 PM

LAST REVISION 11/01/17	REVISION	DESCRIPTION:		FY 2019-20 STANDARD PLANS	FENCE TYPE A	INDEX 550-001	SHEET 2 of 3
---------------------------	----------	--------------	--	--------------------------------------	---------------------	-------------------------	------------------------

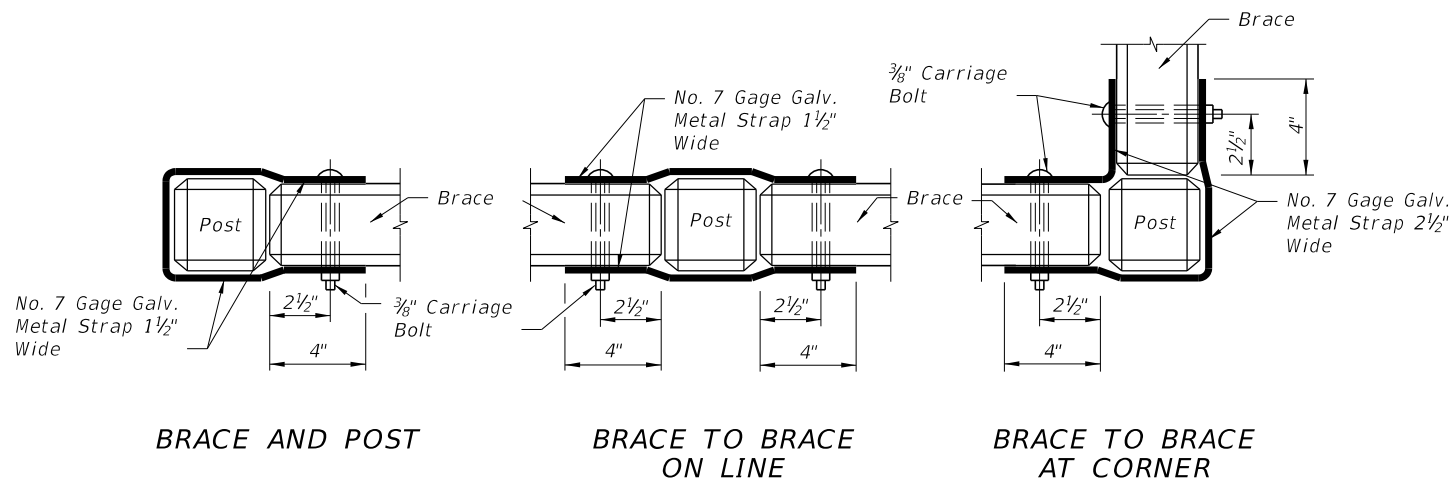

FASTENER FOR CONCRETE POST AND BRACES

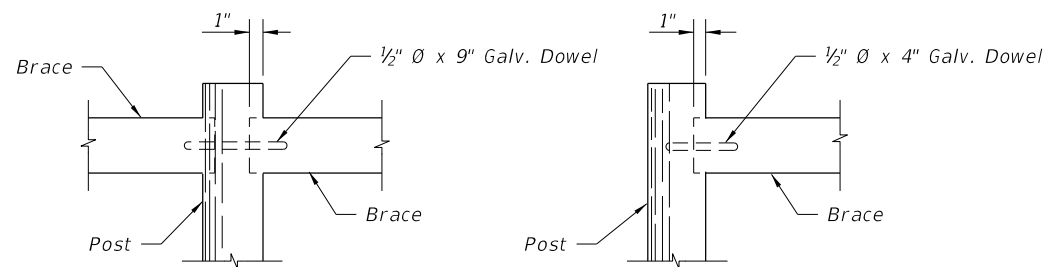

FASTENER FOR TIMBER POST AND BRACE

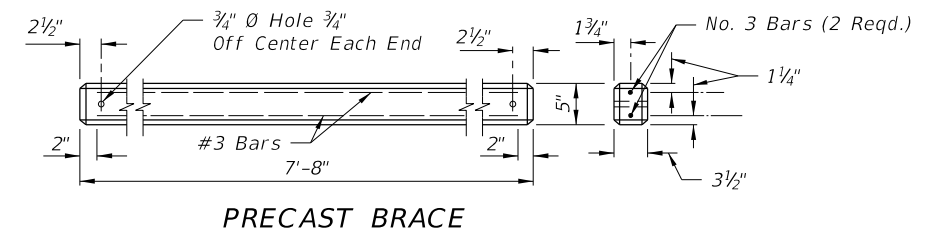
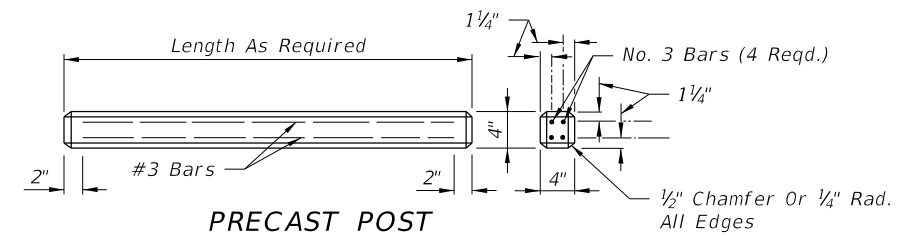
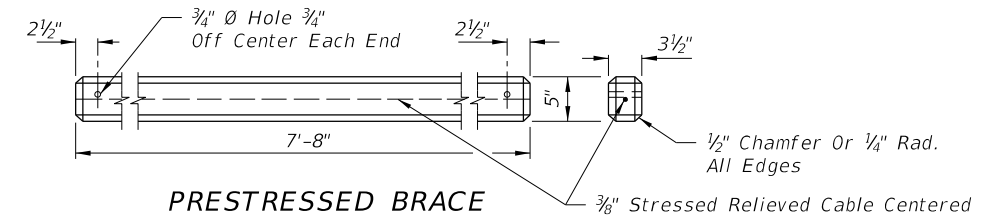
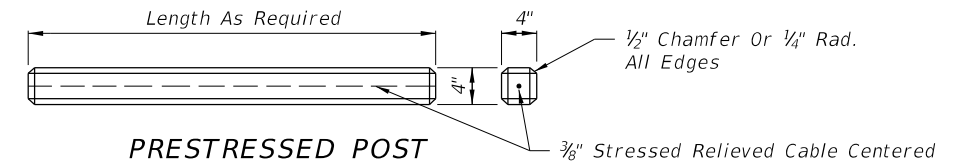

ALTERNATE CONCRETE POSTS AND BRACES

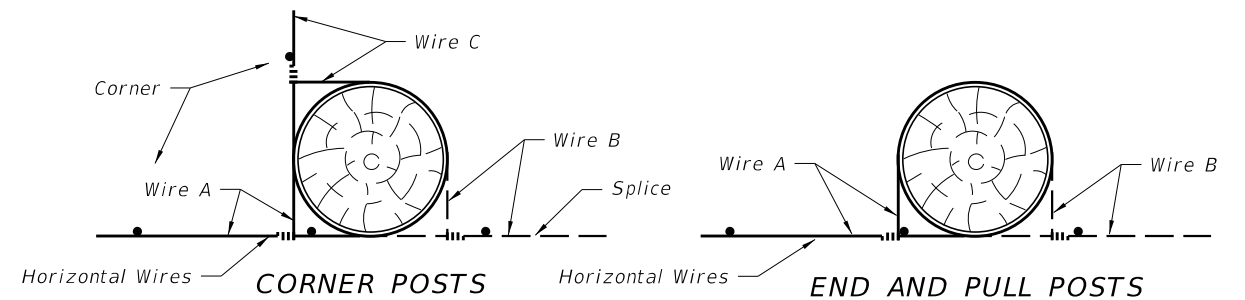

Each horizontal wire to be wrapped around corner, end and pull posts and tied to same wire. See General Notes 5 and 17. Timber post illustrated. These methods also apply to steel and concrete post illustrations.

SPLICES

10/30/2018 1:40:44 PM

LAST REVISION 11/01/17	DESCRIPTION:		FY 2019-20 STANDARD PLANS	FENCE TYPE A	INDEX 550-001	SHEET 3 of 3
---------------------------	--------------	--	------------------------------	--------------	------------------	-----------------