

PARTIAL PLAN OF RAILING

☒ Post Bolts and Match Line (Trailing End) (See Sheets 3 and 4)

☒ Post Bolts and Match Line (Approach End) (See Sheets 3 and 4)

3'-1/2" spacing (Typ. except as noted along bridge, see Note 2)

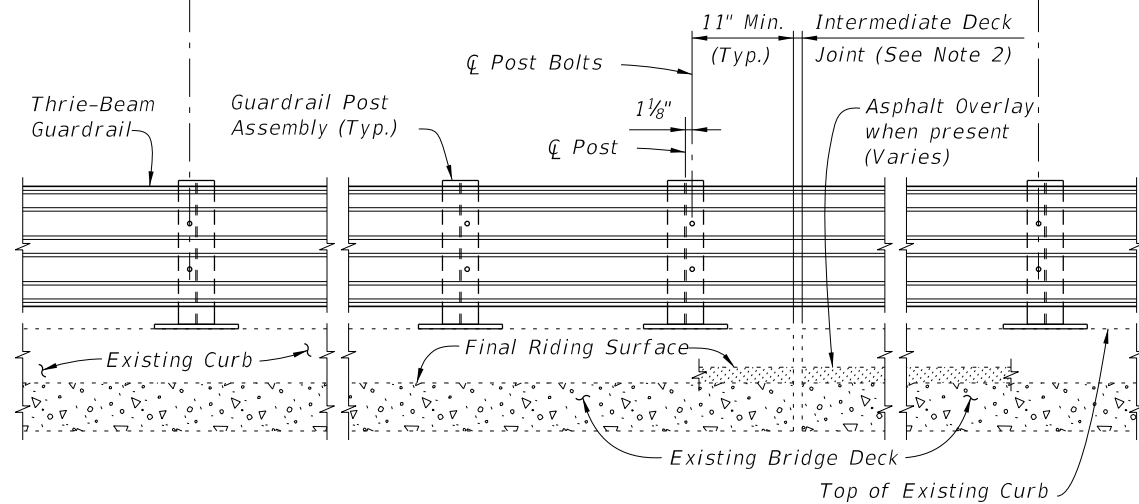

PARTIAL ELEVATION OF INSIDE FACE OF RAILING

==== TYPICAL TREATMENT OF RAILING ALONG BRIDGE ====

NOTES:

1. On approach end provide Index 536-002 (as shown) or other site specific treatment, see Roadway Plans. For treatment of trailing end see Roadway Plans.
2. Actual joint dimension and orientation vary. For Intermediate Deck Joints use the Modified Post Spacing at Intermediate Deck Joints Detail, Index 460-470, Sheet 2, as required.
3. Areas where existing structure has been removed shall match adjoining areas and shall be finished flat by grouting or grinding as required. Exposed existing reinforcing steel shall be burned off 1" below existing concrete and grouted over.

CROSS REFERENCES:

For Section A-A see Sheet 2.  
For Traffic Railing Notes and Details see Index 460-470.

10/23/2018 12:51:36 PM

LAST REVISION 01/01/08	REVISION	DESCRIPTION:	 FY 2019-20 STANDARD PLANS	TRAFFIC RAILING - (THRIE-BEAM RETROFIT) NARROW CURB	INDEX 460-471	SHEET 1 of 4
---------------------------	----------	--------------	---	--	------------------	-----------------

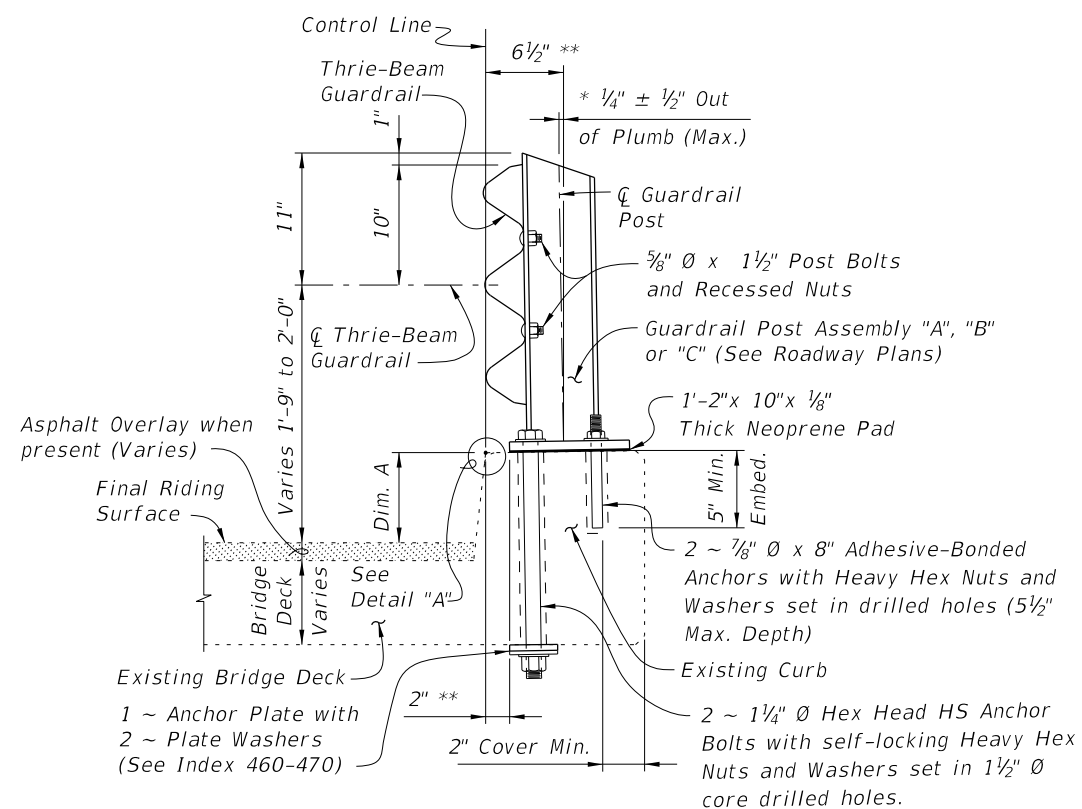

**SECTION A-A**  
TYPICAL SECTION THRU RAILING ON BRIDGE DECK

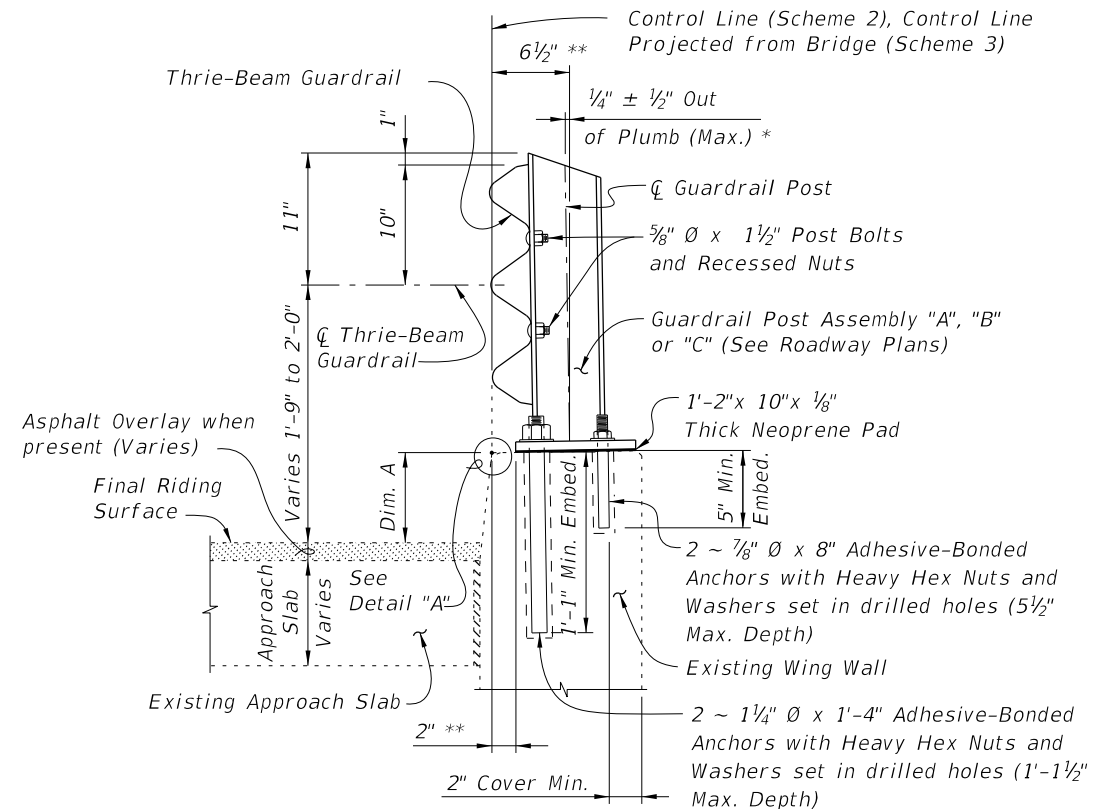

**SECTION B-B**  
TYPICAL SECTION THRU RAILING ALONG APPROACH SLAB  
(SCHEME 2 SHOWN, SCHEME 3 SIMILAR)

\* Shim with washers around Anchors as required to maintain tolerance.  
 \*\* Offset may vary  $\pm 1$ " for Adhesive-Bonded Anchors to clear existing curb reinforcing and provide minimum edge clearance. Offset shall be consistent along length of bridge.

BILL OF REINFORCING STEEL			BAR BENDING DIAGRAMS	
MARK	SIZE	LENGTH		
A	4	AS REQUIRED		
D	4	1'-11"		
L	4	4'-1"		

<p><b>BAR 4A</b></p>	<p><b>Dowel Bar 4D</b> (Standard 180° Hook)</p>
<p>NOTES:</p> <ol style="list-style-type: none"> <li>All bar dimensions are out to out.</li> <li>The 1'-2" vertical dimension shown for Bar 4D is based on a curb height of 9". If curb height is less or more than 9", decrease or increase this dimension by an amount equal to the difference in curb height.</li> </ol>	<p><b>DOWEL BAR 4L</b></p>

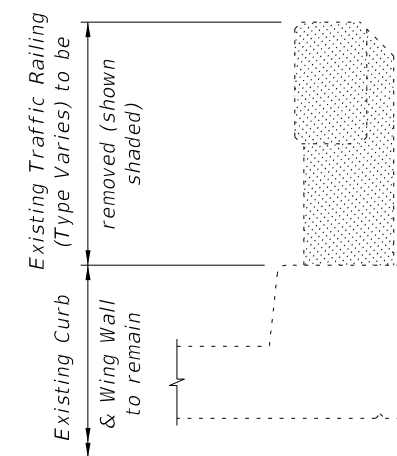
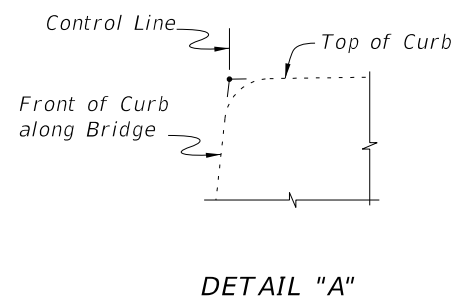

**TYPICAL SECTION THRU EXISTING TRAFFIC RAILING SHOWING LIMITS OF REMOVAL (BRIDGE DECK SHOWN, WING WALL SIMILAR)**

CROSS REFERENCES:  
 For location of Section A-A see Sheets 1, 3 & 4.  
 For location of Section B-B see Sheets 3 & 4.  
 For application of Dim. A see Post Dimension Table on Index 460-470, Sheet 3.

10/23/2018 12:51:36 PM

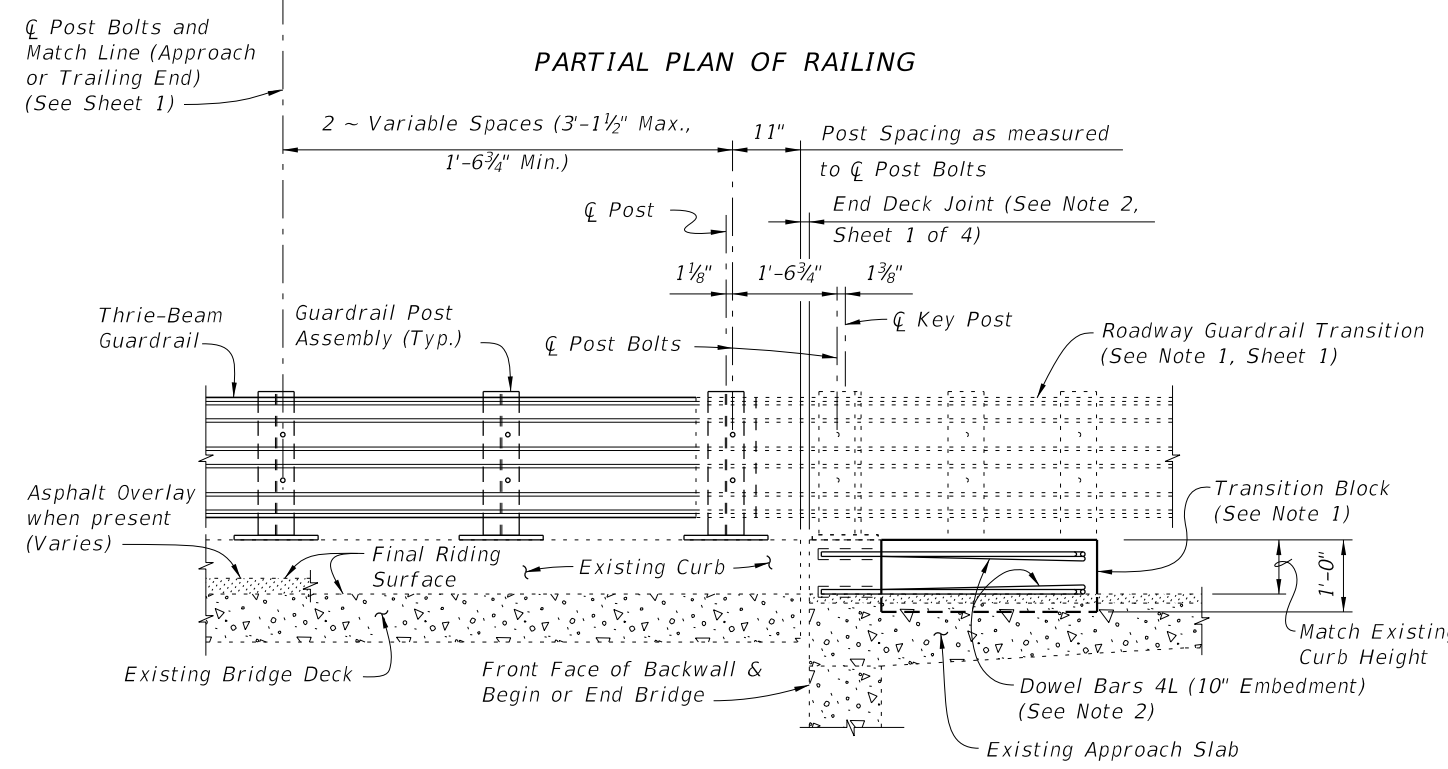
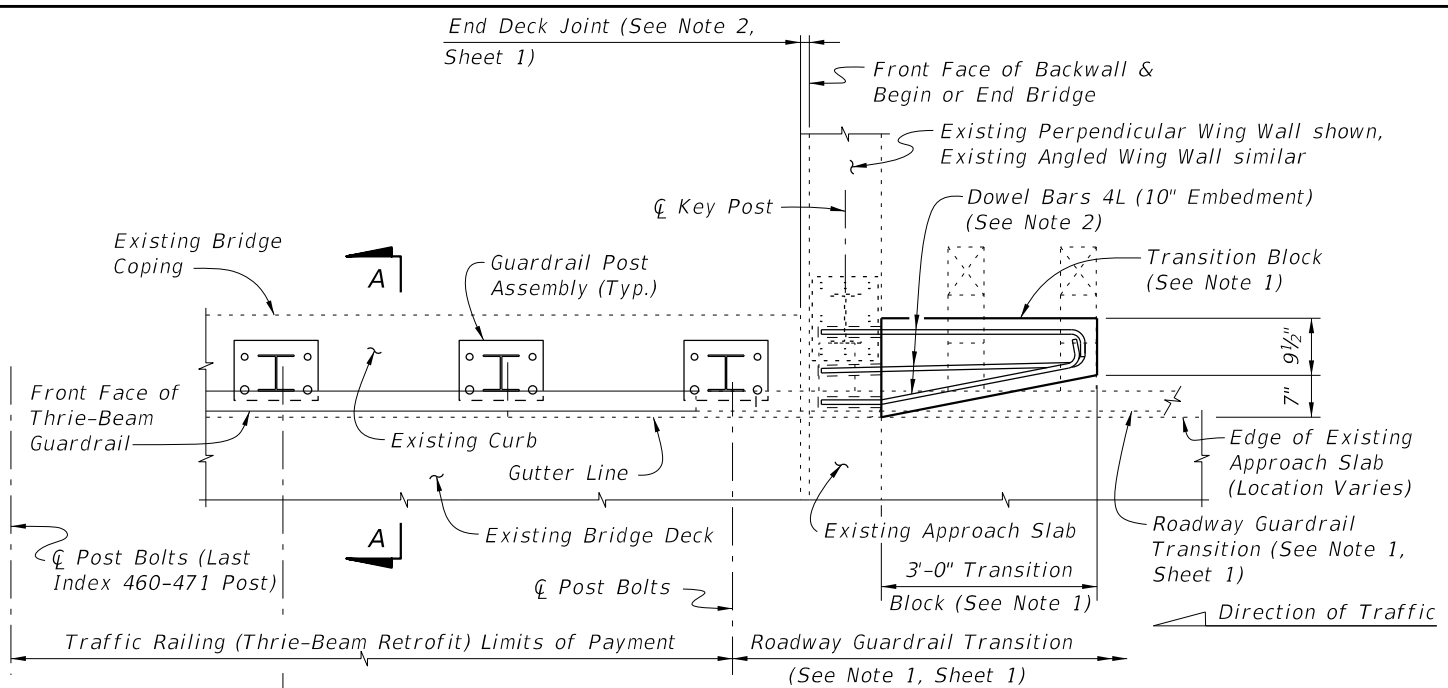

**PARTIAL ELEVATION OF INSIDE FACE OF RAILING**

**SCHEME 1**

**RAILING END TREATMENT FOR PERPENDICULAR OR ANGLED WING WALLS**

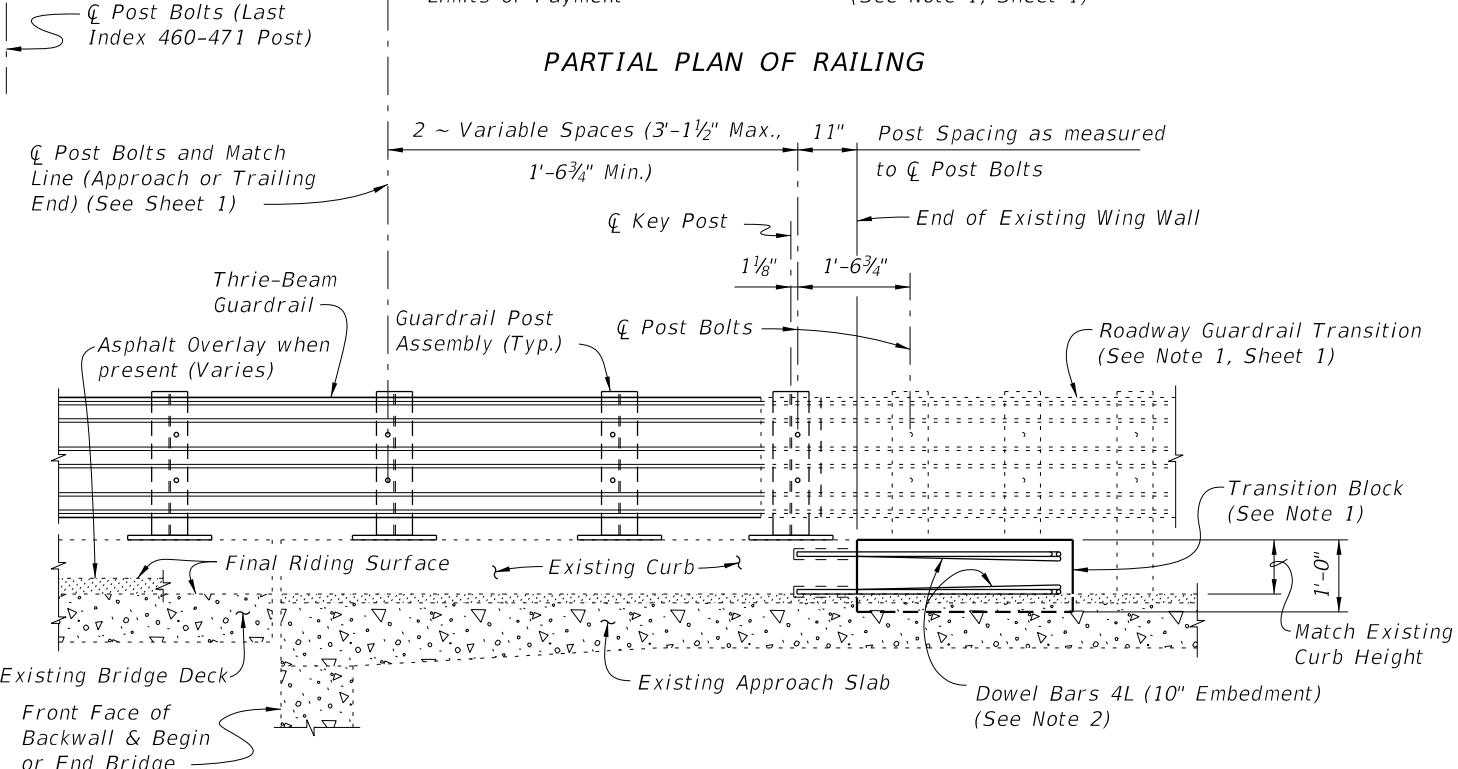
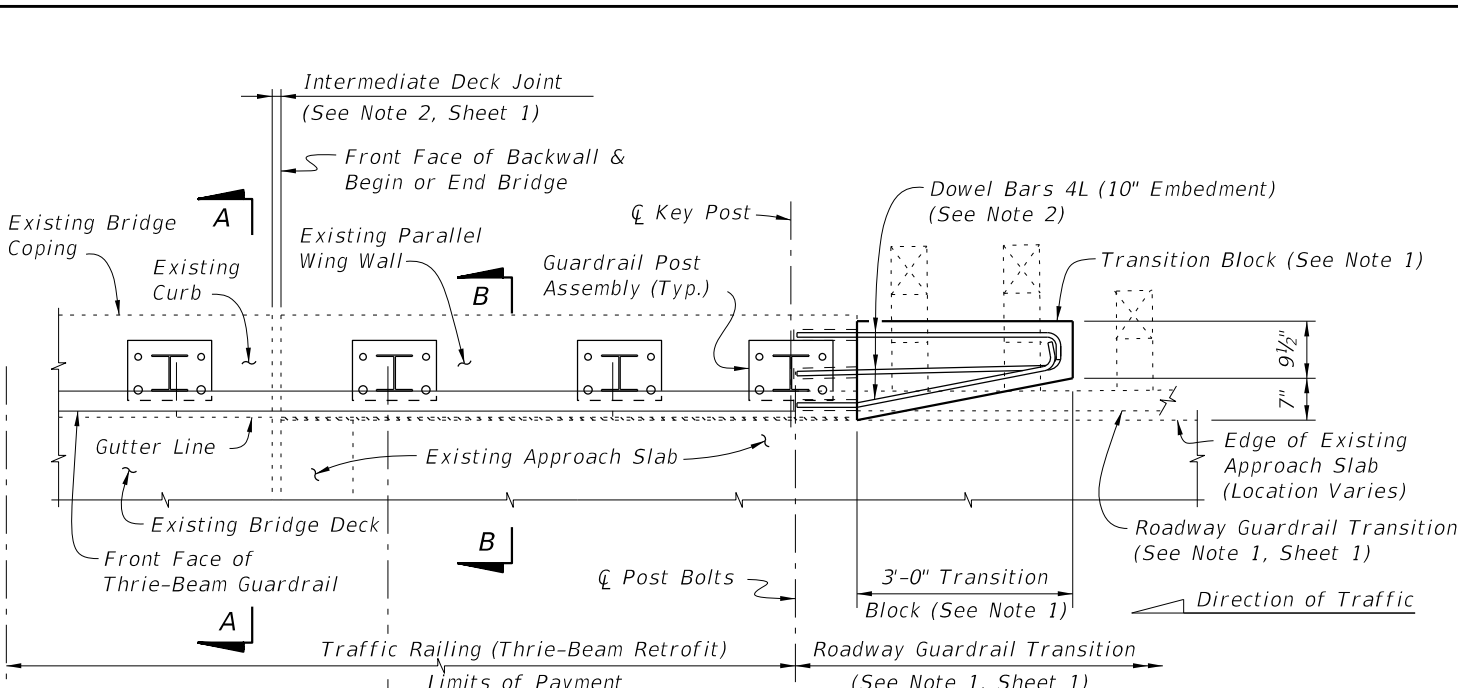

**PARTIAL ELEVATION OF INSIDE FACE OF RAILING**

**SCHEME 2**

**RAILING END TREATMENT FOR PARALLEL WING WALLS**

**SCHEME 1 NOTES:**

1. Provide Transition Block (as shown) or Curb if existing Approach Slab does not have a curb, see Roadway Plans. Shape and height of Transition Block or Curb shall match existing bridge curb. Transition Block may be omitted on trailing ends with no opposing traffic.
2. Field bend Dowel Bars 4L within Transition Block as required to maintain 2" top and side clearance and 3" bottom clearance.

**SCHEME 2 NOTES:**

1. Provide Transition Block (as shown) or Curb if existing Approach Slab does not have a curb, see Roadway Plans. Shape and height of Transition Block or Curb shall match existing bridge curb. Transition Block may be omitted on trailing ends with no opposing traffic.
2. Field bend Dowel Bars 4L within Transition Block as required to maintain 2" top and side clearance and 3" bottom clearance.

10/23/2018 12:51:37 PM

LAST REVISION 01/01/08	REVISION	DESCRIPTION:	 <b>FY 2019-20 STANDARD PLANS</b>	<b>TRAFFIC RAILING - (THRIE-BEAM RETROFIT) NARROW CURB</b>	INDEX 460-471	SHEET 3 of 4
---------------------------	----------	--------------	--	--	------------------	-----------------

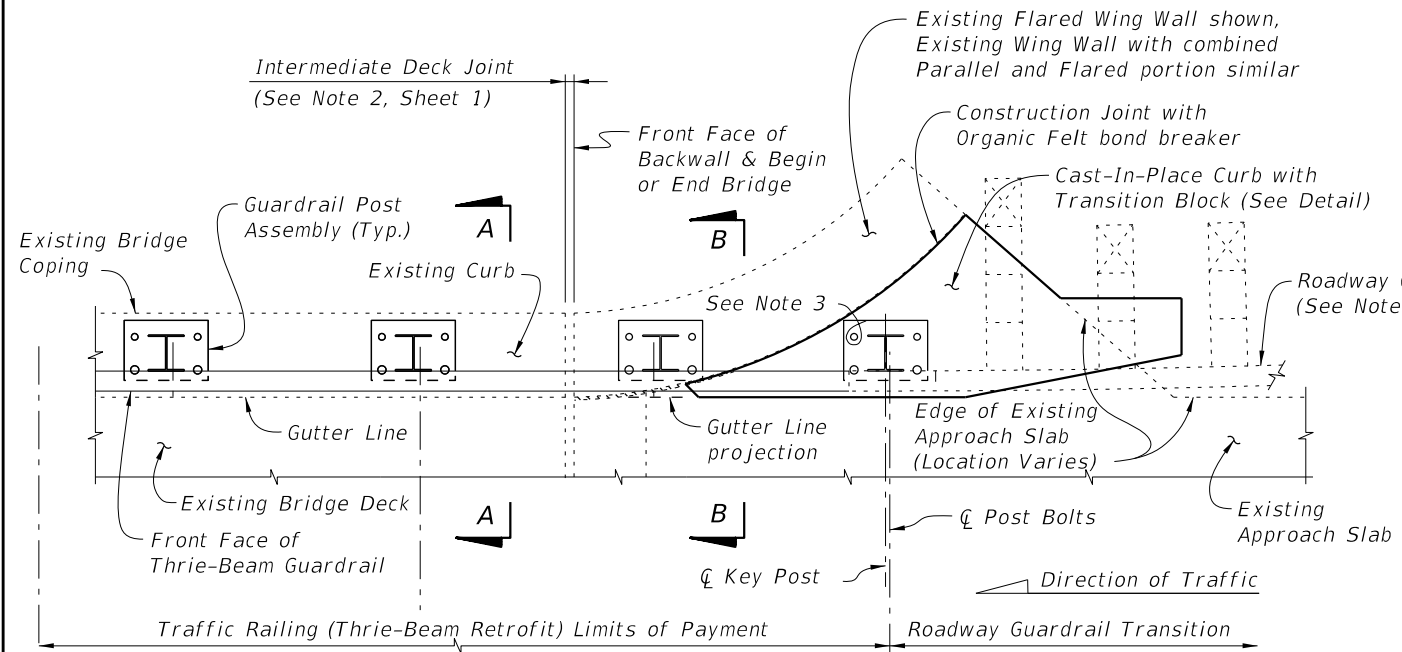

**PARTIAL PLAN OF RAILING**

**PLAN OF CAST-IN-PLACE CURB & TRANSITION BLOCK DETAIL**  
(Approach End with Transition Block Shown, Trailing End without Transition Block Similar)

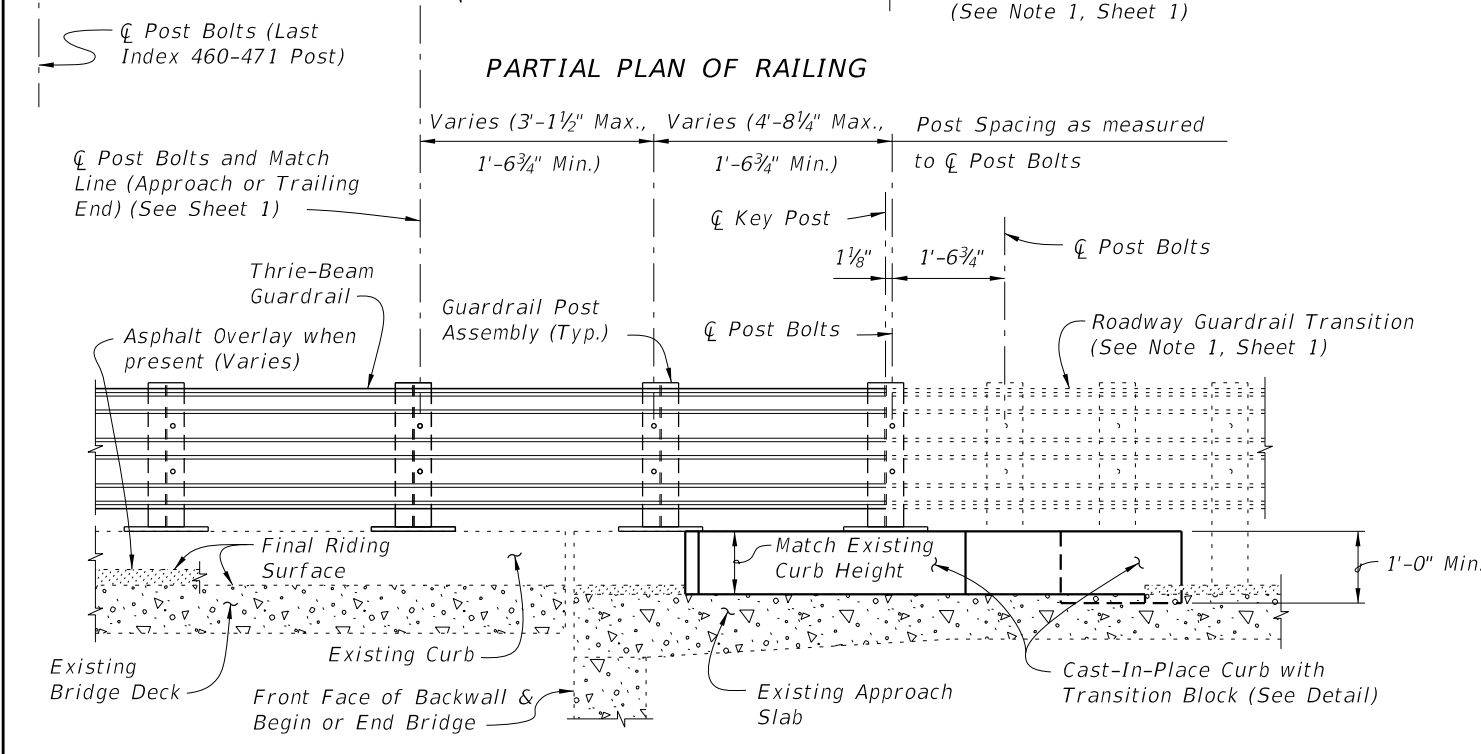

**PARTIAL ELEVATION OF INSIDE FACE OF RAILING**

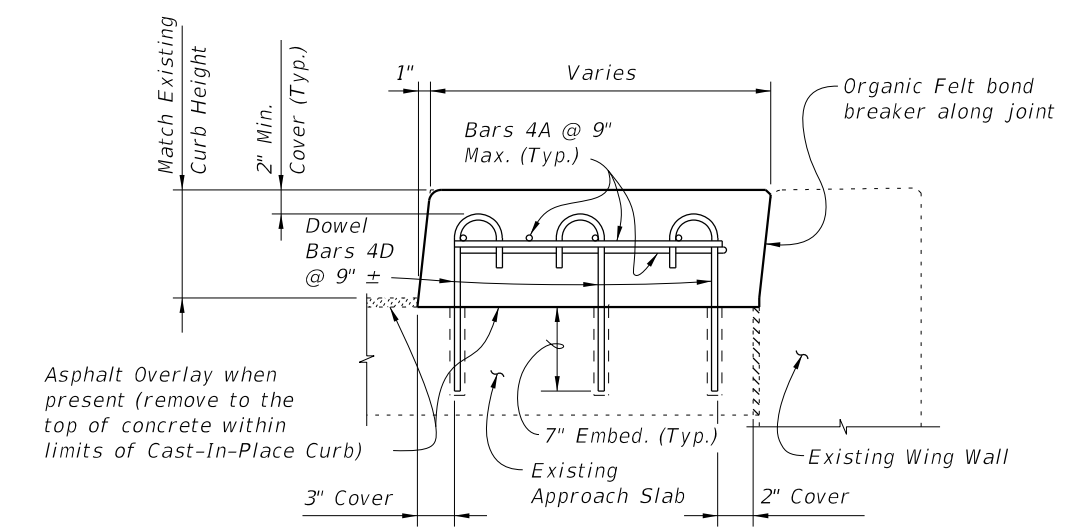

**SECTION C-C**

**SCHEME 3**  
**RAILING END TREATMENT FOR FLARED WING WALLS**

**SCHEME 3 NOTES:**

1. Provide Cast-In-Place Curb as shown. Shape and height of Transition Block and Curb shall match existing bridge curb. Transition Block may be omitted on trailing ends with no opposing traffic.
2. Field cut and bend Bars 4A and rotate Dowel Bars 4B within Curb and Transition Block as required to maintain 2" top and side clearance and 3" bottom clearance.
3. A single 7/8" Ø x 8" Adhesive-Bonded Anchor may be omitted as shown when 2" clear cover cannot be provided.

10/23/2018 12:51:38 PM

LAST REVISION 11/01/16	REVISION	DESCRIPTION:	 FY 2019-20 STANDARD PLANS	<b>TRAFFIC RAILING - (THRIE-BEAM RETROFIT)</b> <b>NARROW CURB</b>	INDEX <b>460-471</b>	SHEET <b>4 of 4</b>
---------------------------	----------	--------------	--	--	-------------------------	------------------------