

WITH OVERBURDEN - HALF SECTION

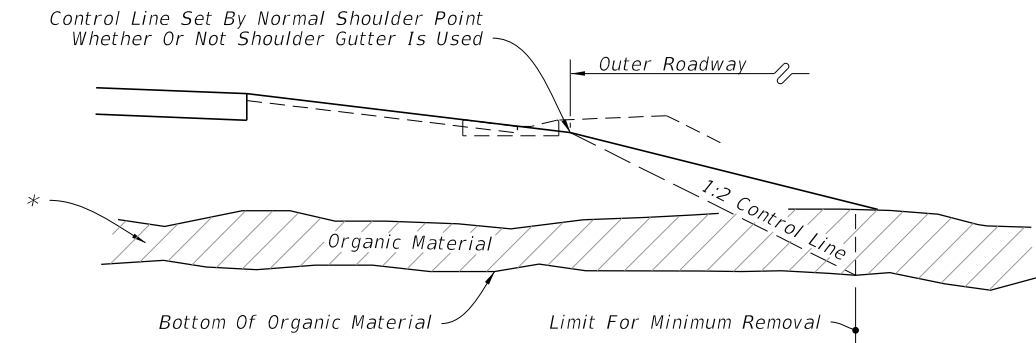

WITHOUT OVERBURDEN - HALF SECTION

CONSTRUCTION OF FLUSH SHOULDER ROADWAY

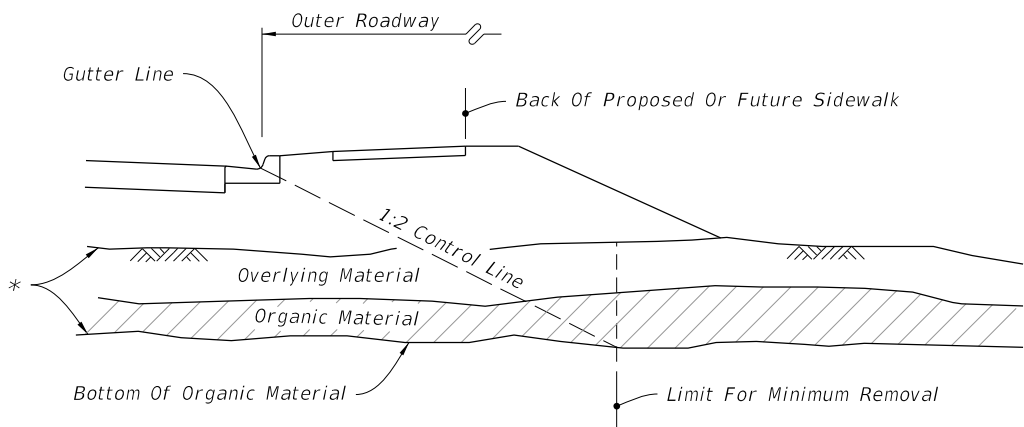

WITH OVERBURDEN - HALF SECTION

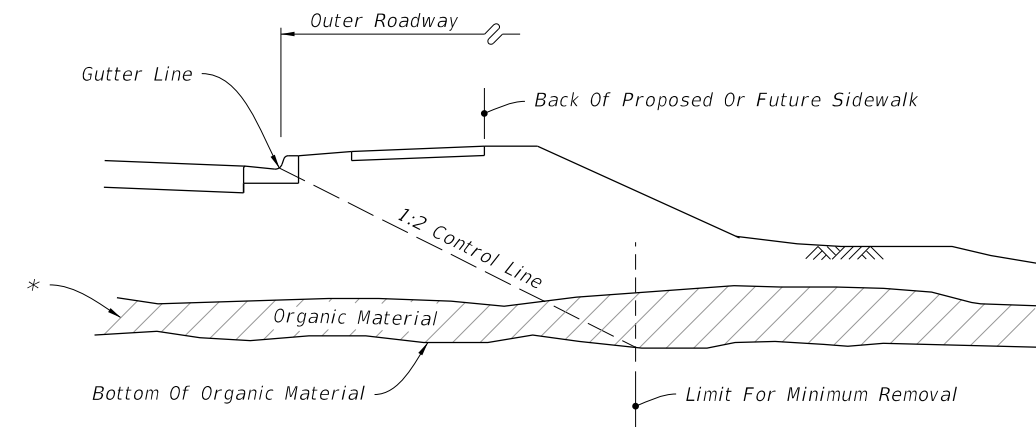

WITHOUT OVERBURDEN - HALF SECTION

CONSTRUCTION OF CURBED ROADWAY

* Remove overlying material and organic material within the limits shown and backfill in accordance with Index 120-001, unless approved otherwise by the District Geotechnical Engineer; The limits include full median width when applied to divided facilities with median widths up to 64'; When median width is greater than 64' and for bifurcated roadways the organic material removal limits will be set by a 1:2 control line complimentary to the outer roadway that will accommodate one future median lane on each roadway unless specified otherwise by the plans.

GENERAL NOTES:

1. All details shown on this Index for removal of organic and plastic materials apply unless otherwise shown on the plans.
2. Utilize excavated materials in accordance with Index 120-001.
3. Where organic or plastic material is undercut, backfill with suitable material in accordance with Index 120-001, unless otherwise shown on the plans.
4. The term "Plastic Material" used in this Index in conjunction with removal of plastic soil is as defined under soil classifications for Plastic (P) and High Plastic (H) on Index 120-001.
5. See Index 160-001 for miscellaneous earthwork details.

6. The term "Organic Material" as used on this Index is defined as any soil which has an average organic content greater than five (5.0) percent, or an individual organic content test result which exceeds seven (7.0) percent. Remove organic material as shown on this Index and the plans unless directed otherwise by the District Geotechnical Engineer. Determine the average organic content from the test results from a minimum of three randomly selected samples from each stratum. Perform tests in accordance with AASHTO T267 on the portion of a sample passing the No. 4 sieve.
7. In areas of curbed roadway, where underdrain is to be constructed beneath the proposed pavement, the grade of the underdrain filter material will not extend above the bottom of the stabilized section of the subgrade. Gradation of the filter material must conform to Standard Specifications. The minimum grade of underdrain pipe is ~~0.2%~~

CORRECTED: 0.2%

GENERAL NOTES AND REMOVAL OF ORGANIC MATERIAL

10/18/2018 10:21:28 AM

LAST REVISION 11/01/17	DESCRIPTION:	 FY 2019-20 STANDARD PLANS	SUBSOIL EXCAVATION	INDEX 120-002	SHEET 1 of 2
---------------------------	--------------	--	--------------------	------------------	-----------------

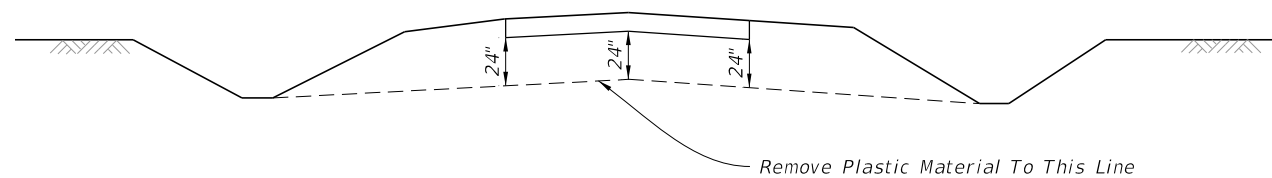

TYPICAL CUT SECTION ON TANGENT

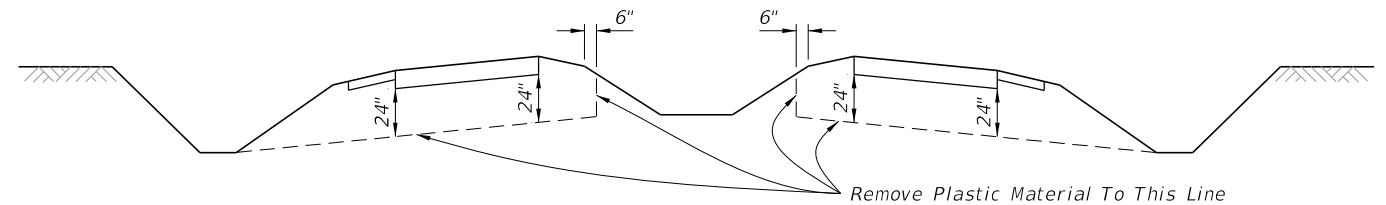

TYPICAL CUT SECTION ON TANGENT

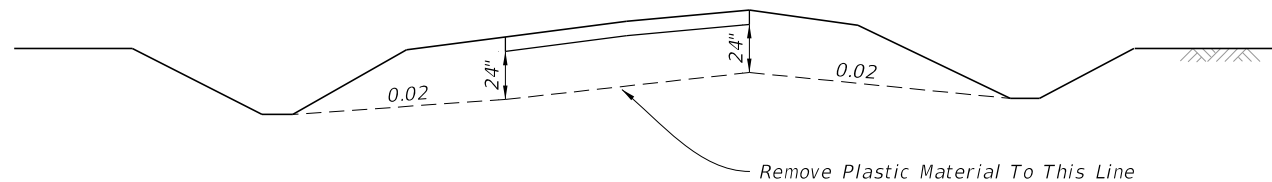

TYPICAL CUT SECTION ON SUPERELEVATION

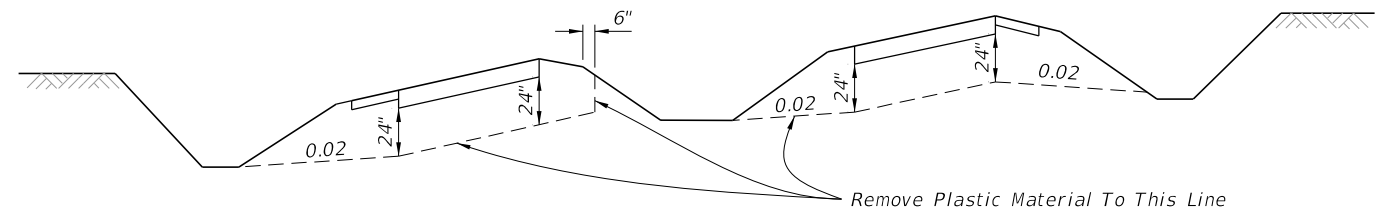

TYPICAL CUT SECTION ON SUPERELEVATION

=====**DIVIDED FREEWAYS, ARTERIALS, MAJOR COLLECTORS HAVING FLUSH MEDIAN, ON UNDIVIDED ARTERIALS AND MAJOR COLLECTORS**=====

=====**INTERSTATE FACILITIES, FREEWAYS, DIVIDED ARTERIALS AND MAJOR COLLECTORS HAVING DEPRESSED MEDIAN**=====

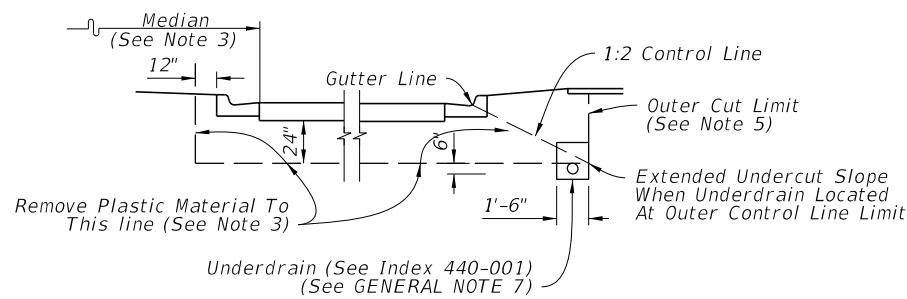

PREFERABLE REMOVAL

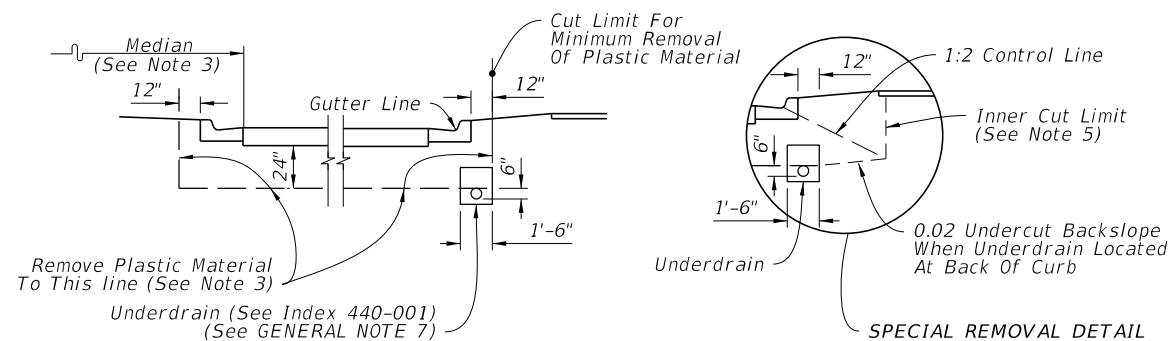

MINIMUM REMOVAL

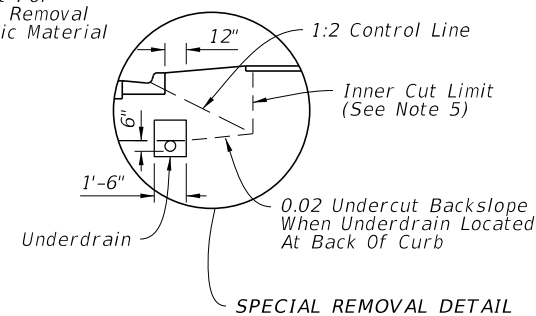

SPECIAL REMOVAL DETAIL

NOTES:

1. See Sheet 1 for the GENERAL NOTES.
2. When the typical cut details are applied to minor collectors and local facilities, the undercut may be reduced from 24" to 18".
3. Where frequency of median breaks indicates that it is impractical to leave plastic material in the median, the designer may elect to indicate total removal of this material. If during construction it becomes apparent, due to normal required construction procedures, that it is impractical to leave the plastic material in the median, total removal of this material shall be approved by the Engineer.
4. Refer to roadway cross sections to determine whether minimum or preferable removal is used.
5. Where the Preferable Removal method is shown in the plans and it is impossible to place the underdrain at the Outer Cut Limit due to conflict with storm drain trunk lines, remove to Inner Cut Limit and place underdrain at location shown for Minimum Removal. (See Special Removal Detail)
6. Cross slopes of 0.02 shown above are minimums. Follow the cross slope of the pavement to the extent possible.

=====**CONSTRUCTION AND LOCATION OF UNDERDRAIN IN CURBED ROADWAY**=====
(See Note 4)

REMOVAL OF PLASTIC MATERIAL

10/18/2018 10:21:29 AM

LAST REVISION 11/01/17	REVISION	DESCRIPTION:		FY 2019-20 STANDARD PLANS	SUBSOIL EXCAVATION	INDEX 120-002	SHEET 2 of 2
---------------------------	----------	--------------	--	------------------------------	--------------------	------------------	-----------------