

PLANS PREPARATION MANUAL

VOLUME 1

DESIGN CRITERIA AND PROCESS

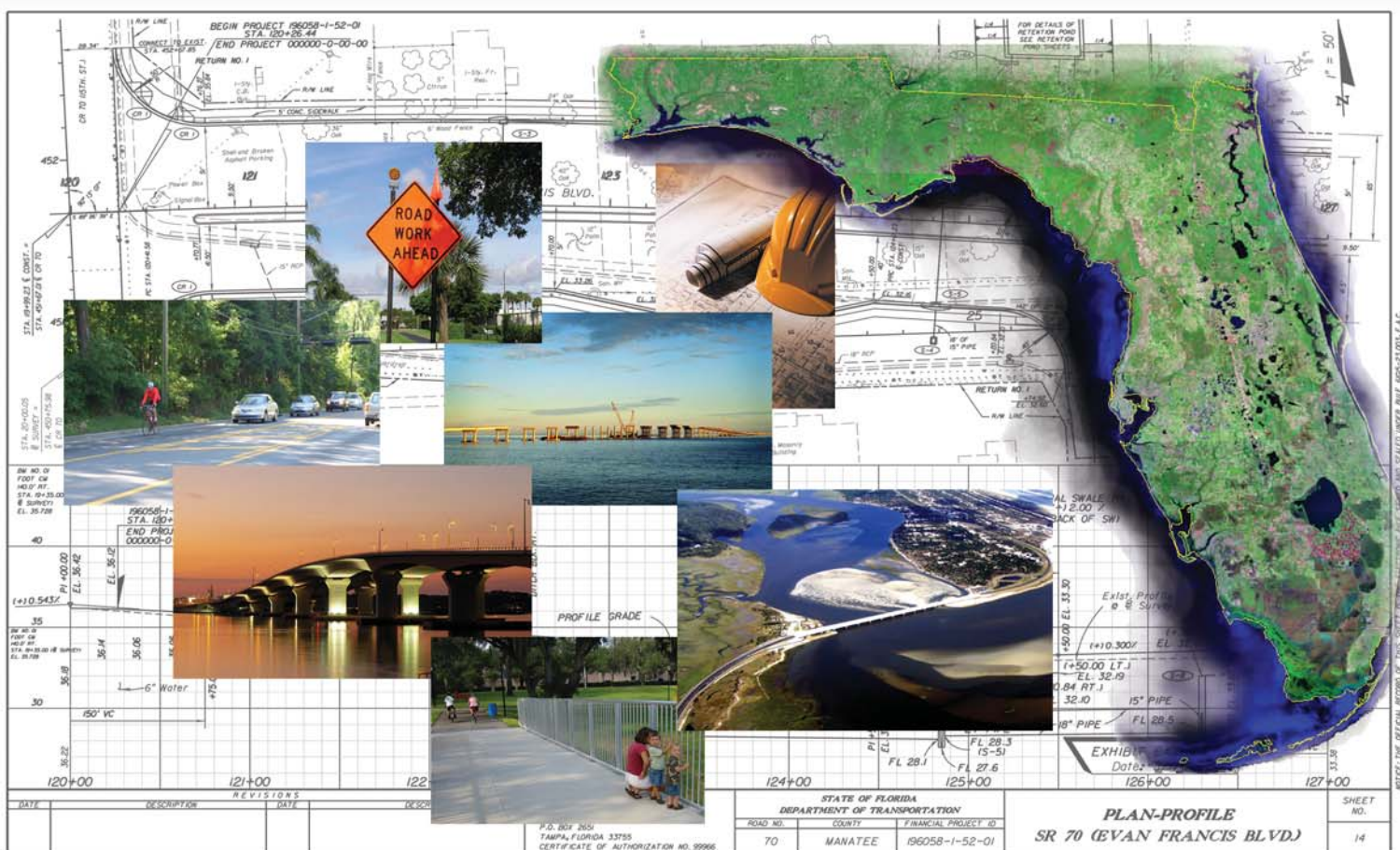

FDOT



DESIGN



January 2009

Revised

January 1, 2010

PLANS PREPARATION MANUAL

VOLUME

1

DESIGN CRITERIA & PROCESS



PLANS PREPARATION MANUAL

VOLUME 1

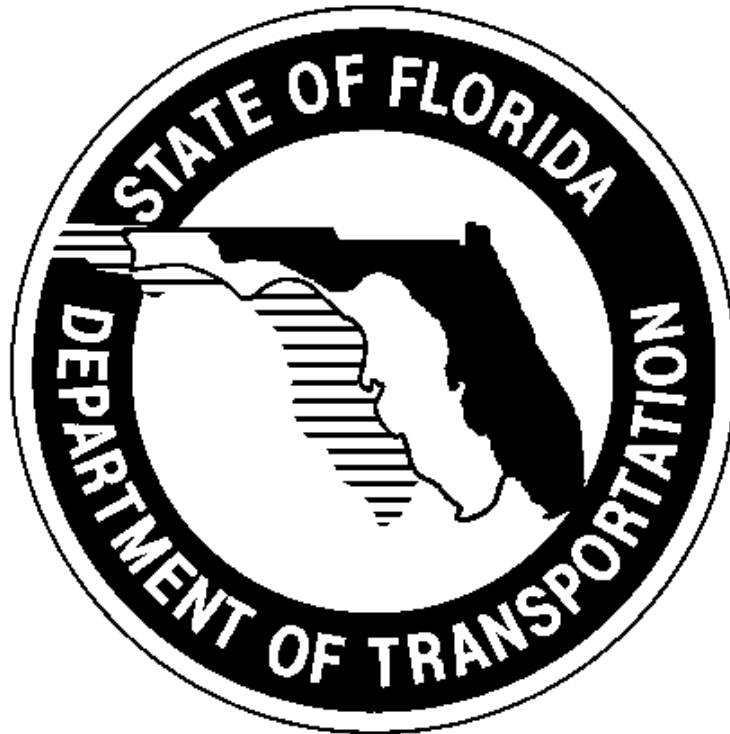

ROADWAY DESIGN OFFICE

TALLAHASSEE, FLORIDA

JANUARY 1, 2010 EDITION

<http://www.dot.state.fl.us/rddesign/PPMManual/PPM.shtm>

THIS PAGE LEFT BLANK INTENTIONALLY

PLANS PREPARATION MANUAL

REGISTRATION

The Department of Transportation has created a new contact database that will enable the Department to e-mail important information to registered users on topics selected by each user. The database is will allow a user to update their e-mail address, topics of interest and any other information in their profile at any time. The information users provide will not be shared with any other company or agency.

All PPM users (and other Roadway Design manual users) must register their e-mail addresses in this contact database in order to receive future updates, notices, design memos, or other important information concerning the Department's design manuals. **The old database of PPM users is no longer in use, and registrations of current PPM users in the old database were not automatically imported into the new contact database.** PPM users who have not already done so must register in the new contact database at the following link:

<http://www2.dot.state.fl.us/contactmanagement/>

THIS PAGE LEFT BLANK INTENTIONALLY

STATE OF FLORIDA DEPARTMENT OF TRANSPORTATION

**SUGGESTIONS AND COMMENTS
PLANS PREPARATION MANUAL**

**NAME OF FIRM OR
FDOT DEPARTMENT:**

PHYSICAL ADDRESS:

**NAME OF PERSON
RESPONSIBLE FOR
SUGGESTIONS OR
COMMENTS:**

EMAIL ADDRESS:

TELEPHONE NO.:

FAX NO.:

**SUGGESTIONS
OR COMMENTS:**

(Comments or Suggestions may be attached as marked up copies of pages from the manual)

Please complete the requested information on a copy of this sheet and return to:

**FLORIDA DEPARTMENT OF TRANSPORTATION
ROADWAY DESIGN OFFICE
MAIL STATION 32
605 SUWANNEE STREET
TALLAHASSEE, FLORIDA 32399-0450
FAX NUMBER (850) 414-5261**

THIS PAGE LEFT BLANK INTENTIONALLY

Table of Contents

Introduction	Plans Preparation Manual, Volume 1
Chapter 1	Design Controls
Chapter 2	Design Geometrics and Criteria
Chapter 3	Earthwork
Chapter 4	Roadside Safety
Chapter 5	Utilities
Chapter 6	Railroad Crossing
Chapter 7	Traffic and ITS Design
Chapter 8	Pedestrian, Bicycle and Public Transit Facilities
Chapter 9	Landscape
Chapter 10	Transportation Management Plan
Chapter 11	Stormwater Pollution Prevention Plan
Chapter 12	Right of Way
Chapter 13	Initial Engineering Design Process
Chapter 14	Final Engineering Design Process
Chapter 15	Update Engineering Design Process
Chapter 16	Design Submittals
Chapter 17	Engineering Design Estimate Process
Chapter 18	Quality Assurance and Quality Control
Chapter 19	Sealing Design Documents
Chapter 20	Plans Processing and Revisions
Chapter 21	Transportation Design for Livable Communities
Chapter 22	Lump Sum Project Guidelines
Chapter 23	Exceptions and Variations
Chapter 24	Federal Aid Project Certification
Chapter 25	Florida’s Design Criteria for Resurfacing, Restoration and Rehabilitation (RRR) of Streets and Highways
Chapter 26	Bridge Project Development
Chapter 27	Hydraulic Data and U.S. Coast Guard Permits
Chapter 28	Shop and Erection Drawings
Chapter 29	Structural Supports for Signs, Luminaires, and Traffic Signals
Chapter 30	Retaining Walls
Chapter 31	Geosynthetic Design
Chapter 32	Sound Barriers
Chapter 33	Reinforced Concrete Box and Three-Sided Culverts

THIS PAGE LEFT BLANK INTENTIONALLY

Introduction

Plans Preparation Manual, Volume 1

PURPOSE:

This *Plans Preparation Manual, Volume 1* sets forth geometric and other design criteria, as well as procedures, for Florida Department of Transportation (FDOT) projects. The information contained herein applies to the preparation of contract plans for roadways and structures.

AUTHORITY:

Sections 20.23(3)(a) and 334.048(3), Florida Statutes.

SCOPE:

This procedure impacts anyone preparing roadway and structures construction plans for the Department.

GENERAL INFORMATION:

Chapter 334 of the *Florida Statutes*, as part of the *Florida Transportation Code*, establishes the responsibilities of the State, counties, and municipalities for the planning and development of the transportation systems serving the people of Florida, with the objective of assuring development of an integrated, balanced statewide system. The Code's purpose is to protect the safety and general welfare of the people of the State and to preserve and improve all transportation facilities in Florida. Under **Section 334.048(3)**, the Code sets forth the powers and duties of the Department of Transportation including to adopt rules, procedures and standards for the conduct of its business operations and the implementation of any provisions of law for which the Department is responsible.

PROCEDURE:

The criteria in this manual represent requirements for the State Highway System which must be met for the design of FDOT projects unless approved exceptions or variations are obtained in accordance with procedures outlined in this manual.

Roadway and structures design is primarily a matter of sound application of acceptable engineering criteria and standards. While the criteria contained in this manual provide a basis for uniform design practice for typical roadway design situations, precise standards which would apply to individual situations must rely on good engineering practice and analyses.

Situations will exist where these criteria will not apply. The inappropriate use of and adherence to these criteria does not exempt the engineer from the professional responsibility of developing an appropriate design. The engineer is responsible for identifying those criteria which may not apply to a particular design, and for obtaining the necessary exception or variation to achieve proper design.

1. PLANS PREPARATION MANUAL, VOLUME 1 - MANUAL ORGANIZATION

a. Background

The Florida Department of Transportation *Plans Preparation Manual (PPM)* was published in the current format in January 1998. The criteria in the 1998 PPM were given in metric units.

b. Organization

The *Plans Preparation Manual* is a two-volume manual. **Volume 1** contains the design criteria and process and **Volume 2** contains material concerning plans preparation and assembly.

2. DISTRIBUTION

This document is available electronically on the PPM web page:

<http://www.dot.state.fl.us/rddesign/PPMManual/PPM.shtm>

PPM users can register to receive notification of updates and *Roadway Design Bulletins* online through the Department's Contact Management Database at:

<http://www2.dot.state.fl.us/contactmanagement/>

For information on updates and *Roadway Design Bulletins*, contact:

Roadway Design Office, Mail Station 32

Telephone (850) 414-4310

FAX Number (850) 414-5261

<http://www.dot.state.fl.us/rddesign/>

3. REVISIONS AND UPDATES

Plans Preparation Manual users are encouraged to submit comments and suggestions for changes to the manual to the Roadway Design Office. When ideas or suggestions are received they will be reviewed by appropriate Roadway and/or Structures Design staff in a timely manner and will be coordinated with other offices affected by the proposed change. Items warranting immediate change will be made with the approval of the State Roadway Design Engineer and/or State Structures Design Engineer in the form of a **Design Bulletin**.

Roadway Design Bulletins are numbered based on the two digit calendar year and bulletin number (YY-##). Notices are sent to all users who are registered to receive notifications for **Roadway Design Bulletins** and updates to the **Plans Preparation Manual**. Design Bulletins affecting the **Plans Preparation Manual** will remain effective until either:

1. An official manual revision is published; or
2. The **Design Bulletin** is made void.

Roadway Design Bulletins are posted online at:

<http://www.dot.state.fl.us/rddesign/updates/files/updates.shtm>

Structures design issues, which are subject to modification and revision, will be processed in coordination with the Structures Design Office.

Proposed revisions are distributed in draft form to the District Design Engineers (DDE). The DDE coordinates the review of the proposed revisions with other affected district offices such as Structures Design. The goal is to obtain a majority opinion before revisions are made.

The Roadway Design Office will also coordinate proposed revisions or additions with affected offices within the Central Office. Substantive revisions that result in policy change will be coordinated with the Executive Committee for concurrence.

Revisions are voted on jointly by the District Design Engineers and the State Roadway Design Engineer (for Roadway Design issues) or the State Structures Design Engineer (for Structures Design issues). Each district will have one vote and the central office will have two votes; for a total of ten votes. Requirements mandated by FHWA or State Rules will not be subject to this majority vote.

All revisions and updates will be coordinated with the Forms and Procedures Office prior to publishing to ensure conformance with and incorporation into the Department's Standard Operating System.

Notification of the adopted revisions and addenda will be distributed to registered users of the manual through the Department's Contact Management Database.

TRAINING:

None required.

FORMS ACCESS:

Documents marked as **Exhibits** provide only a starting point allowing users to change or alter the document as needed to fit specific situations. These Exhibits are not official forms of the Department. Templates for these documents are available online at:

<http://www.dot.state.fl.us/rddesign/PPMManual/NForms/PPMForm.shtm>

GLOSSARY OF TERMS:

In the application of the criteria in this manual, the following definitions are assigned for consistency of understanding and interpretation.

1. **Arterials:** Divided or undivided, relatively continuous routes that primarily serve through traffic, high traffic volumes, and long average trip lengths. Traffic movement is of primary importance, with abutting land access of secondary importance. Arterials include expressways without full control of access, US numbered routes and principal state routes. May be classified as urban or rural.
2. **Auxiliary Lane:** The designated widths of roadway pavement marked to separate speed change, turning, passing and climbing maneuvers from through traffic. They may also provide short capacity segments.
3. **Bicycle Lane:** A bicycle lane (bike lane) is a portion of a roadway (either with curb and gutter or a flush shoulder) which has been designated by striping, special pavement markings, and signing for the preferential use by bicyclists.
4. **Bicycle Way:** Any road, path or way which by law is open to bicycle travel, regardless of whether such facilities are signed and marked for the preferential use by bicyclists or are to be shared with other transportation modes. Examples include bicycle lanes, paved shoulders, shared use paths, and traffic lanes.
5. **C-D Roads:** Collector-Distributor Roads are limited access roadways provided within a single interchange, or continuously through two or more interchanges on a freeway segment. They provide access to and from the freeway, and reduce and control the number of ingress and egress points on the through freeway. They are similar to continuous frontage roads except that access to abutting property is not permitted.
6. **Collectors:** Divided or undivided routes which serve to link arterial routes with local roads or major traffic generators. They serve as transition link between mobility needs and land use needs. Collectors include minor state routes, major county roads, and major urban and suburban streets.
7. **Florida Intrastate Highway System (FIHS):** An interconnected statewide system of limited access facilities and controlled access facilities developed and managed by the Department to meet standards and criteria established for the FIHS. It is part of the State Highway System, and is developed for high-speed and high-volume traffic movements. The FIHS also accommodates High-Occupancy Vehicles (HOVs), express bus transit and in some corridors, interregional and high speed intercity passenger rail service. Access to abutting land is subordinate to movement of traffic and such access must be prohibited or highly regulated.

8. **Freeways:** Divided arterial highways, with full control of access. Movement of traffic free of interference and conflicts is of primary importance. Essential elements include medians, grade separations, interchanges, and, in some cases, collector-distributor roads and frontage roads. Freeways include Interstate, toll road and expressway systems. May be classified as urban or rural.
9. **High Speed:** Descriptive term used to summarize all conditions governing the selection of Design Speeds 50 mph and greater.
10. **HOV Lane:** Special designated widths of pavement marked to provide travel lanes for high occupancy vehicles (HOV). They may be directly adjacent to other travel lanes or separated.
11. **Local Roads:** Routes which provide high access to abutting property, low average traffic volumes, short average trip lengths and on which through traffic movements are not of primary importance. Local roads include minor county roads, minor urban and suburban subdivision streets, and graded or unimproved roads.
12. **Low Speed:** Descriptive term used to summarize all conditions governing the selection of Design Speed of less than 50 mph.
13. **Low Volume and High Volume:** Descriptive terms used to describe certain operating characteristics and driver expectancy on highways. Criteria for some elements are selected according to these qualifying controls. Standards for these controls are given in the table following this section.
14. **Pedestrian Way:** A space for pedestrian travel separated from traffic lanes. Sidewalks, shared use paths, footpaths and shoulders are considered to be pedestrian ways. However, footpaths and shoulders are not accessible facilities, since they lack specific improvements or provisions to accommodate or encourage walking.
15. **Ramp:** A turning roadway that connects two or more legs at an interchange. The components of a ramp are a terminal at each leg and a connecting road. The geometry of the connecting road usually involves some curvature and a grade.
16. **Roadway:** The portion of a highway, including shoulders, for vehicular use. A divided highway has two or more roadways.
17. **Rural Areas:** Places outside the boundaries of concentrated populations that accommodate higher speeds, longer trip lengths and freedom of movement, and are relatively free of street and highway networks. Rural environments are surroundings of similar characteristics.

18. **Strategic Intermodal System (SIS):** A transportation system comprised of facilities and services of statewide and interregional significance, including appropriate components of all modes. The highway component includes all designated SIS Highway Corridors, Emerging SIS Highway Corridors, SIS Intermodal Connectors, and Emerging SIS Highway Intermodal Connectors.
19. **Streets:** The local system which provides direct access to residential neighborhoods and business districts, connects these areas to the higher order road systems and offers the highest access to abutting property; sometimes deliberately discouraging through-traffic movement and high speeds.

Note: Local roads and streets are not generally a part of the State Highway System and therefore, may not be governed by the FDOT roadway design criteria, but by the *Manual of Uniform Minimum Standards for Design, Construction and Maintenance for Streets and Highways* and/or criteria established by the local government.
20. **Traffic Lane/Traveled Way:** The designated widths of roadway pavement, exclusive of shoulders and bicycle lanes, marked to separate opposing traffic or vehicles traveling in the same direction. Traffic lanes include through travel lanes, auxiliary lanes, turn lanes, weaving, passing, and climbing lanes. They provide space for passenger cars, trucks, buses, recreational vehicles and, in some cases, bicycles.
21. **Travel Lane:** The designated widths of roadway pavement marked to carry through traffic and to separate it from opposing traffic or traffic occupying other traffic lanes. Generally, travel lanes equate to the basic number of lanes for a facility.
22. **Truck Traffic:** When significant, heavy, substantial, high percent, etc. truck traffic is used as a qualifying control, it shall mean 10% of the AADT or 10% of the daily count (24 hr.)
23. **Urban Area:** A geographic region comprising as a minimum the area inside the United States Bureau of the Census boundary of an urban place with a population of 5,000 or more persons, expanded to include adjacent developed areas as provided for by Federal Highway Administration (FHWA) regulations. The FHWA Urban Boundary maps are available online at:
<http://www.dot.state.fl.us/rddesign/PPMManual/BM/BufferMaps.shtm> .
24. **Urbanized Area:** A geographic region comprising as a minimum the area inside an urban place of 50,000 or more persons, as designated by the United States Bureau of the Census, expanded to include adjacent developed areas as provided for by Federal Highway Administration regulations. Urban areas with a population of fewer than 50,000 persons which are located within the expanded boundary of an urbanized area are not separately recognized.

STANDARDS FOR LOW AND HIGH VOLUME HIGHWAYS IN ANNUAL AVERAGE DAILY VOLUMES

HIGHWAY TYPE	LOW VOLUME AADT	HIGH VOLUME AADT
FREEWAY - URBAN		
4-LANE FACILITY	57,000	69,000
6-LANE FACILITY	86,000	103,000
8-LANE FACILITY	114,000	138,000
FREEWAY - RURAL		
4-LANE FACILITY	46,000	56,000
6-LANE FACILITY	69,000	83,000
8-LANE FACILITY	92,000	111,000
ARTERIALS - URBAN		
2-LANE FACILITY	16,000	20,000
4-LANE FACILITY	37,000	43,000
6-LANE FACILITY	55,000	64,000
8-LANE FACILITY	69,000	80,000
ARTERIALS - RURAL		
2-LANE FACILITY	9,000	14,000
4-LANE FACILITY	38,000	47,000
6-LANE FACILITY	58,000	71,000
COLLECTOR - URBAN		
2-LANE FACILITY	11,000	16,000
4-LANE FACILITY	37,000	45,000
COLLECTOR - RURAL		
2-LANE FACILITY	8,000	13,000
4-LANE FACILITY	30,000	38,000

LOW VOLUME FACILITIES ARE HIGHWAY TYPES WITH PROJECTED DESIGN YEAR **AADT** VOLUME EQUAL TO OR LESS THAN THE LOW VOLUME VALUES SHOWN.

HIGH VOLUME FACILITIES ARE HIGHWAY TYPES WITH PROJECTED DESIGN YEAR **AADT** VOLUME EQUAL TO OR GREATER THAN THE HIGH VOLUME VALUES SHOWN.

Chapter 1

Design Controls

1.1	General	1-1
1.2	Traffic	1-1
1.3	Capacity and Level of Service.....	1-3
1.4	Roadway Functional Classification	1-4
1.5	RRR Design	1-5
1.6	Design Consistency and Driver Expectancy	1-6
1.7	Transportation Design for Livable Communities (TDLC).....	1-8
	1.7.1 Policy Statement	1-8
	1.7.2 Aesthetics	1-8
1.8	Access Management.....	1-10
1.9	Design Speed.....	1-14
	1.9.1 Design Speed Coordination and Approvals	1-14
1.10	Public Involvement	1-17
1.11	Context Sensitive Solutions in Design	1-18
1.12	Design Vehicle	1-19

Tables

Table 1.8.1	Freeway Interchange Spacing	1-12
Table 1.8.2	Arterial Access Management Classifications & Standards.....	1-12
Table 1.8.3	Interim Standards (Newly constructed or transferred roads).....	1-13
Table 1.9.1	Design Speed State Highway System - Non-FIHS/SIS Facilities	1-15
Table 1.9.2	Minimum Design Speed FIHS/SIS	1-16

Figures

Figure 1.12.1	Florida Interstate Semitrailer (WB-62FL)	1-19
---------------	--	------

Chapter 1

Design Controls

1.1 General

Designs for highway and street projects are normally based on established design controls for the various elements of the project such as width of roadway, side slopes, horizontal and vertical alignment, drainage considerations and intersecting roads. Selection of the appropriate criteria and standards is influenced by traffic volume and composition, desired levels of service, functional classification, terrain features, roadside developments, environmental considerations and other individual characteristics.

The identification of applicable design controls is basic to providing the desired level of service, optimum safety, and cost effectiveness.

1.2 Traffic

It is the Department's responsibility to provide for an interconnected transportation system to insure the mobility of people and goods. In order to achieve these objectives, designers must determine if the proposed improvements will satisfy future needs by comparing the forecast directional hourly volume with the traffic handling capacity of an improved facility. Project traffic forecasts and capacity are used to establish the number of through lanes, length of auxiliary lanes, signalization timings, right of way requirements, etc., so that the facility will operate at an acceptable level of service through the design year.

Roadway geometric design shall be based on project traffic for the design year. The design year for new construction and reconstruction projects should be 20 years after the project is opened to traffic. The Design Hourly Volume (DHV) shall be the 30th highest hour.

Also, the traffic forecast is used in pavement design to determine the vehicular loadings on the pavement. The proposed pavement design must provide structural strength through the pavement's service life. On pavement rehabilitation, the design year for pavement design varies from 8 to 20 years based on the type of construction. The pavement design manuals provide guidance.

Traffic forecasts are developed during the Project Development and Environmental (PD&E) study of a project. A Traffic Report is generally required. When a PD&E study is not conducted, traffic forecasts must be prepared during the plans design process. Project traffic used for design must be attested to as shown in **Chapter 19** of this volume.

The following traffic information should be available to the designer prior to or very early in the design process:

1. AADT for the current year, opening year (completion of construction) and design year.
2. Existing hourly traffic volumes over minimum of 24-hour period, including peak hour turning movements and pedestrian counts.
3. Directional distribution factor (D_{30}).
4. 30th highest hour factor (K_{30}).
5. Truck factors (T) for daily and peak hour.
6. Design speed and proposed posted speed.
7. Design vehicle for geometric design.
8. Turning movements and diagrams for existing and proposed signalized intersections.
9. Special or unique traffic conditions, including during construction.
10. Crash history, including analyses at high crash locations within the project limits.
11. Recommendations regarding parking or other traffic restrictions.

1.3 Capacity and Level of Service

The AASHTO publication *A Policy on Geometric Design of Highways and Streets* and the Transportation Research Board *Highway Capacity Manual* provide the detailed analysis and calculation guides necessary for the number and configurations of lanes required and the resulting levels of service provided. As illustrated in those texts, gradients, roadside developments, number, spacing and types of crossings and intersections, traffic volumes, and signalization patterns all greatly influence capacity and level of service. Those factors, in addition to the roadway functional classification, have a direct influence on the design speed to be adopted at the preliminary design level.

Design of signalized intersections should ensure an adequate Level of Service through the design year of the facility, especially when right of way acquisition is being considered. The capacity of an at-grade arterial or collector is primarily controlled by its ability to move traffic through signalized intersections, rather than the mid-block through lane capacity.

The planning and the operational analysis methods in the *Highway Capacity Manual* may be used for design of signalized intersections. The planning analysis method generates a projection of the intersection capacity and an approximate signal timing plan. The designer must provide information or assumptions on basic intersection geometrics, lane utilization, movement-specific traffic volumes, etc. The primary output of the operational analysis method is Level of Service at a signalized intersection; however, this method can alternatively output geometric requirements, signal timing or service flow volumes.

It is emphasized that signal timing is interactive with geometric design. That is, changes to geometrics, such as adding a turn lane, must consider changes to the signal timing simultaneously. Department approved software, including the *Highway Capacity Software*, should be used to simulate the operation of independent or interconnected signals. Output from these programs can be used for the analysis and evaluation of proposed designs.

1.4 Roadway Functional Classification

The AASHTO publication *A Policy on Geometric Design of Highways and Streets* presents an excellent discussion on highway functional classifications. *Florida Statutes, Title XXVI, Chapters 334, 335 and 336* give similar definitions, and establish classifications for road design in the State of Florida.

The Systems Planning Office, in compliance with *Rule Chapter 14-97* and the *Florida Statutes*, has developed a comprehensive Access Management Classification system for all segments of the State Highway System. The purpose is to enhance the functional integrity of the State Highway System, protect public safety and provide improved mobility of goods and people.

Functional and Access Management classification and the standards required by them are predetermined controls over which the designer has little choice.

These standards are minimum values, and values above the minimum should be used where possible and practical.

1.5 RRR Design

Design criteria applicable for the State Highway System facilities are contained in **Chapter 25** of this volume, ***Florida's Design Criteria for Resurfacing, Restoration and Rehabilitation (RRR) of Streets and Highways***.

1.6 Design Consistency and Driver Expectancy

Design consistency is achieved when the geometric features of the roadway are consistent with the operational characteristics expected by the driver. Inconsistencies normally relate to:

1. Changes in design speed.
2. Changes in cross section.
3. Incompatibility in geometry and operational requirements.

Changes in design speed may occur on a given stretch of roadway because portions of the highway were built as separate projects over an extended period of time. Inconsistencies may be due to a number of factors: changes in standards or FDOT policy, reclassification of the facility, and lack of necessary funding.

There are two major types of design inconsistencies relative to cross section. These are point inconsistencies and a general incompatibility between cross section and alignment. A point inconsistency may be, for example, the narrowing of lane widths, a narrow bridge, a lane drop, or a change from multilane section to two lanes.

A cross sectional inconsistency is usually the result of upgrading a highway cross section without upgrading the alignment. Sometimes pavements are widened and shoulders added on an older two lane highway. The wider cross section on an old alignment might convey a conflicting message to the driver and lead to an inappropriate expectancy based on the visual aspects of the cross section, because cross section features can be more apparent than the alignment.

Of course, this is not to say that widening creates unsafe conditions. Widening alone can measurably improve the safety characteristics of a road, particularly on very narrow, low-volume roads. Designers should, however, be aware of potential inconsistencies that frequently can be overcome with relatively low cost treatments. In the case of widened roads on old alignments, pavement markings, warning signs, and delineation devices can be very helpful to the driver.

Inconsistencies may also relate to incompatibility in geometric and operational requirements. Occasionally elements of the design appear to have been selected for the purpose of fitting together the geometric components conveniently and economically rather than for the purpose of satisfying operational requirements. An example of an inconsistency resulting from the incompatibility is a direct entry ramp that is intended to

permit vehicles to enter the stream of traffic without coming to a complete stop but which, in reality, forces the vehicle to stop when a gap in the traffic stream is not immediately available.

Design inconsistencies can result in driver uncertainty, an increase in response time and an increase in the probability of inappropriate driver response.

Driver expectancy relates to the readiness of the driver to respond to events, situations, or the presentation of information. It can be defined as an inclination, based on previous experience, to respond in a set manner to a roadway or traffic situation. It should be stressed that the initial response is to the expected situation rather than the actual one.

Expectancy can affect the perception and use of information. In most circumstances, the expected and actual conditions are the same. However, when design inconsistencies occur and a driver's expectancy is incorrect, it takes longer to respond properly, there may be no response, or the response may be inappropriate to actual conditions.

There are certain elements in the design of various components of the roadway that particularly affect design consistency, driver expectancy, and vehicular operation. These components include horizontal and vertical alignment, embankments and slopes, shoulders, crown and cross slope, superelevation, bridge widths, signing and delineation, guardrail and placement of utility poles or light supports.

1.7 Transportation Design for Livable Communities (TDLC)

1.7.1 Policy Statement

Designs should consider the incorporation of TDLC features on the State Highway System when such features are desired, appropriate and feasible.

The incorporation of such features is a shared responsibility between the Department and local government. Design criteria for TDLC projects are in **Chapter 21** of this volume.

1.7.2 Aesthetics

Highways are built first and foremost for functional purposes, but the designer should be sensitive to how the highway will be perceived by the users. Designing aesthetic treatments is more than just providing for landscape plantings. The roadway should blend into the landscape, avoiding large cuts and fills, and round side slopes into the existing terrain. Horizontal and vertical alignment should be coordinated so that a driver has an opportunity to gain a sense of the local environment. Combinations of horizontal and crest vertical curves, and broken-back curves should be avoided. Excessively long tangent sections become monotonous. Either curvature or other features should be added to maintain drivers interest.

Application of the clear zone concept discussed in the chapter on Roadside Safety will result in a clean, uncluttered and pleasing roadside. Landscaping of the roadside should be considered early in the design process, so that plantings blend in with the geometric design. **Chapter 9** of this volume discusses landscape design criteria. At times extra right of way may be obtained for treatments if the need is identified early. Retention/detention ponds and other wetlands can be attractive if well designed and placed in a location where they can be viewed from the roadway.

Community Structures placed in the right of way to represent the community are discussed in **Section 9.4** of this volume.

Vistas of exceptional beauty should be accentuated by the roadway geometrics. Ideally, such vistas should be on the outside of horizontal curves, without excessive roadside appurtenances and signs to clutter the view.

"Streetscaping" techniques in urban areas include an emphasis on pedestrian accommodation, trees and other plantings, access control, careful signing, and zoning restrictions on commercial signs. Parkways and other roads specifically intended for pleasing aesthetics should be designed by a multidisciplined team including landscape architects and planners.

Aesthetics and roadway design considerations and methods are discussed in the ***Project Development and Environment Manual (Topic No. 650-000-001), Part 2, Chapter 15.***

1.8 Access Management

Unregulated access to the State Highway System was determined to be one of the contributing factors to congestion and functional deterioration of the system. Regulation of access was necessary to preserve the functional integrity of the State Highway System and to promote the safe and efficient movement of people and goods within the state. Under **F.S. 335.18**, the Legislature authorized the Department to develop rules to administer the "State Highway System Access Management Act." These are **Rule 14-96** and **14-97**. In addition, the Department has adopted the **Median Opening and Access Management Decision Process (Topic No. 625-010-021)**, which further define the principles and processes for the Department to implement the Access Management Statute and Rules.

Each district has established an Access Management Review Committee to guide actions in access management and median decisions through all the Department's processes, and has assigned various offices the responsibility to permit connections and administer other parts of the program. In order to adhere to the program, the designer must be familiar with the statute, the rules, adopted procedures and directives, and the district program. In addition to driveway connections, features such as median openings affect safe and efficient operation. It is critical that the designer know what access classification has been assigned to the highway segment under design and to determine what roadway features and access connection modifications are appropriate to adhere to the program.

During the PD&E phase, a conceptual access management plan is prepared for the preferred alternative. Access management issues are also addressed in the Preliminary Engineering (P.E.) Report. The designer should review these documents and the existing access management classification for information on access management decisions made during the PD&E process.

During the development of construction plans, the designer should evaluate the access connections within the project limits. Driveways and median openings should be considered in the analysis of safety and operational problems. Modifications or closures to access may be the solution in certain cases. **Rule 14-96.003 (3) & (4)** and **14-96.015** gives the Department the authority to alter, relocate or replace connections in order to meet current Department standards. Furthermore, **Rule 14-96.011** allows the FDOT to revoke a permit... "if the connection causes a safety or operational problem on the State Highway System substantiated by an engineering study..."

Rule 14-97 also provides guidance on the treatment of existing features in the highway improvement process:

14-97.003(1)(b)

*(b) For the purpose of the interim standards for the assignment of an access classification to a segment of highway by the Department pursuant to **Rule 14-97.004**, permitted connections and those unpermitted connections exempted pursuant to **Section 335.187(1), Florida Statutes**, existing median openings and signals are not required to meet the interim standards of the assigned classification. Such features will generally remain in place. These features shall be brought into reasonable conformance with the standards of the assigned classification or the interim standards where new connection permits are granted for significant changes in property use, or as changes to the roadway design allow. Applicants issued permits based on the interim standards as set forth in **Rule 14-97.004** shall not have to reapply for a new permit after formal classification of the roadway segment unless significant change pursuant to **Rule Chapter 14-96** and **Rule 14-97.002** has occurred.*

In some cases where revisions are necessary due to operational or safety problems, it may not be possible to totally upgrade a median opening or connection to the newest standards because of existing conditions or constraints. In these cases, the designer should provide the best solution, based on good engineering practice. Early identification of access and median opening location in relation to individual parcels should be completed before the right of way phase. **Median Opening and Access Management Decision Process (Topic No. 625-010-021)** requires the following:

1. Any significant change to driveway access will be shown in plans or the driveway will be replaced in the same location, width and configuration (number of lanes).
2. Access design and impacts to a right of way acquisition parcel should be determined prior to the right of way phase.
3. Changes to access details or decisions must be coordinated with District Right of Way and General Counsel's offices in addition to the Access Management Review Committee.

Every owner of property that abuts a road on the State Highway System has a right to reasonable access to the abutting state highway but does not have a right to unregulated access to such highway. A means of reasonable access cannot be denied except on the basis of safety and operational concerns as provided in **Section 335.184, Florida Statutes**. Nothing in **Section 335.184** limits the Department's authority to restrict the operational characteristics of a particular means of access. Service roads provide reasonable access.

It should be noted that if there are any conflicts between these guidelines and the statute and rules, the statute and rules shall govern.

FLORIDA DOT ACCESS MANAGEMENT GUIDELINES RULE 14-97

Table 1.8.1 Freeway Interchange Spacing

Access Class	Area Type	Segment Location	Interchange Spacing (miles)
1	Area Type 1	CBD & CBD Fringe For Cities In Urbanized Areas	1.0
	Area Type 2	Existing Urbanized Areas Other Than Area Type 1	2.0
	Area Type 3	Transitioning Urbanized Areas And Urban Areas Other Than Area Type 1 or 2	3.0
	Area Type 4	Rural Areas	6.0

Table 1.8.2 Arterial Access Management Classifications & Standards

Access Class	Medians "Restrictive" physically prevent vehicle crossing. "Non-Restrictive" allow turns across at any point.	Connection Spacing (feet)		Median Opening Spacing (feet)		Signal Spacing (feet)
		>45 mph	≤45 mph	Directional	Full	
2	Restrictive with Service Roads	1320	660	1320	2640	2640
3	Restrictive	660	440	1320	2640	2640
4	Non-Restrictive	660	440			2640
5	Restrictive	440	245	660	*2640/ 1320	*2640/1320
6	Non-Restrictive	440	245			1320
7	Both Median Types	125		330	660	1320

* 2640 feet for >45 mph; 1320 feet for ≤45 mph

**Table 1.8.3 Interim Standards
 (Newly constructed or transferred roads)**

Posted Speed (mph)	Connection Spacing (feet)	Median Opening Spacing (feet)		Signal Spacing (feet)
		Directional	Full	
35 mph or less "Special Cases"	125	330	660	1320
35 mph or less	245	660	1320	1320
36 - 45 mph	440	660	1320	1320
Over 45 mph	660	1320	2640	1320

1.9 Design Speed

Design speed is a principal design control that regulates the selection of many of the project standards and criteria used to design a roadway project. The selection of an appropriate design speed must consider many factors. The AASHTO publication, ***A Policy on Geometric Design of Highways and Streets***, has a thorough discussion on design speed and these factors.

1.9.1 Design Speed Coordination and Approvals

As a principal design control, design speed must be selected very early in the design process and must be documented in the project design file. The Engineer of Record must coordinate with the District Design Engineer (DDE), the District Traffic Operations Engineer (DTOE), and the responsible PD&E engineer to discuss the anticipated posted speed. Every effort should be made to **use as high a design speed as practical** to attain a desired degree of safety, mobility and efficiency. However, the design speed shall not be less than the project's proposed posted speed (existing posted speed if no change is proposed) or legal speed limit. On new construction and reconstruction projects, designers shall not include in their plans a posted speed higher than the design speed.

The selected design speed shall be jointly approved by the District Design Engineer and the District Traffic Operations Engineer. This includes joint approval that the expected posted speed will not exceed the selected design speed. This is to be documented on the Typical Section Package as described in **Section 16.2.3**. When agreement between the DDE and DTOE on the Design Speed cannot be reached, the DDE and DTOE will forward the matter to the District Director of Transportation Development and District Director of Transportation Operations for final resolution. Note that in some cases it may be appropriate to select a higher design speed to match an expected posted speed and process Design Exceptions or Variations for those design elements that do not meet the criteria for the higher speed.

The modification of posted speed limits after the construction of a project has been completed is a decision made under the authority of the District Traffic Operations Engineer (***FDOT Procedure No. 750-010-011***). This is based on the 85th percentile speed determined through engineering and traffic investigations described in ***Speed Zoning for Highways, Roads and Streets in Florida, (FDOT Procedure No. 750-010-002)***. The DTOE typically conducts a speed investigation within one year after a new construction or reconstruction project is completed. When it is determined from this speed study that a posted speed higher than the original design speed is warranted, the DTOE working with

the DDE must process Design Exceptions or Variations for those design elements that do not meet the criteria for the higher speed. When agreement between the DDE and DTOE cannot be reached, the DDE and DTOE will forward the matter to the District Director of Transportation Development and District Director of Transportation Operations for final resolution. Further explanation on how posted speed limits are developed can also be found on the State Traffic Operations web page:

<http://www.dot.state.fl.us/trafficoperations/FAQs/SpeedLimitFAQ.shtm>

While the selected design speed will establish minimum geometric requirements (e.g., minimum horizontal curve radius and sight distance), this does not preclude the use of improved geometry (flatter curves or greater sight distances) where such improvements can be provided as a part of economic design. The Engineer of Record is required to document, in a design speed matrix, any design features that were designed to speeds other than the project design speed. Increments of 5 mph should be used when selecting design speeds.

Table 1.9.1 provides a recommended range of design speeds for new construction and reconstruction projects on the State Highway System except for facilities on the Florida Intrastate Highway System (FIHS)/Strategic Intermodal System (SIS). Design Speed for facilities on the FIHS/SIS (including SIS Highway Corridors, Emerging SIS Highway Corridors, SIS Highway Intermodal Connectors and Emerging SIS Highway Intermodal Connectors) shall meet or exceed the values in **Table 1.9.2**.

For design speed on RRR projects on the State Highway System, see **Chapter 25** of this volume. **Chapter 25** may be used for RRR projects on the FIHS/SIS. However, the minimum design speed in **Table 1.9.2** should be used when practicable, consistent with proposed improvements defined for the facility in the **Corridor Management Plan**. See **Topic Number 525-030-250, Procedure for the Development of the Florida Intrastate Highway System**, for requirements.

**Table 1.9.1 Design Speed
 State Highway System - Non-FIHS/SIS Facilities**

Facility		Design Speed (mph)
Freeways	Rural	70
	Urban	50 - 70
Arterials	Rural	55 - 70
	Urban	40 - 60
Collectors	Rural	55 - 65
	Urban	35 - 50
TDLC		30 - 40

**Table 1.9.2 Minimum Design Speed
 FIHS/SIS**

Facility		Minimum Design Speed (mph)
Interstate and Freeways	Rural and Urban*	70
	Urbanized*	60
Arterials	Rural*	65
	Urban and Urbanized*	50

* Terms based on definitions contained in ***FIHS Procedure (Topic No. 525-030-250)***.

Note: For FIHS/SIS facilities (including SIS Highway Corridors and Emerging SIS Highway Corridors,), design speeds less than the above minimums shall be submitted to the Director, Office of Design and approved by the Chief Engineer, following a review by the State Transportation Development Administrator, in accordance with the ***FIHS Procedure (Topic No. 525-030-250)***.

For SIS and Emerging SIS Highway Intermodal Connectors not on the State Highway System, design speeds less than the above outlined minimums shall be approved by the District Design Engineer, following a review by the District Planning (Intermodal Systems Development) Manager in accordance with the ***Development of the SIS Highway Component Directive (Topic No. 525-030-251-a)***. Refer to ***Chapter 2*** of this Volume for design criteria.

1.10 Public Involvement

It is the policy (**Topic No. 000-525-050, Public Involvement Opportunities**) of the FDOT to promote public involvement opportunities and information exchange activities in all functional areas using various techniques adapted to local area conditions and project requirements.

Typically, when a project reaches the design phase, many of the project commitments and community issues have already been identified. However, this is not always true. Design alternatives still need to be reevaluated to determine their implications in relation to community impacts. Any commitments made in previous phases would be communicated to designers, who will be responsible for carrying them out. If constraints arise that require design changes which affect the Department's ability to meet commitments, then the process would require follow-up with the affected community. In such cases, additional public involvement and community impact assessment may be necessary to address public concerns.

Projects may have potential community impacts that are not identified until the design phase, such as, but not limited to:

1. Impacts on public safety, including people with disabilities
2. School crossings or other areas of high pedestrian activity
3. Aesthetic features such as landscaping or tree replacement
4. Medians or access changes
5. Intersections and driveways
6. Audible signalized intersections
7. Accessibility of corridor businesses and neighborhoods
8. Wider sidewalks or improved bicycle facilities
9. Lighting
10. Transit
11. Transportation Design for Livable Communities
12. Maintenance of Traffic
13. Railroad crossings

Each district has developed Community Awareness Plan (CAP) guidelines to be implemented on all design projects for continued efforts in public involvement depending on the level of impact to the community.

1.11 Context Sensitive Solutions in Design

In order to plan, design, construct, maintain and operate the State Transportation System, “Context Sensitive Solutions” should be considered in all projects, not only TDLC projects. This design philosophy seeks transportation solutions that improve mobility and safety while complementing and enhancing community values and objectives. Context sensitive solutions are reached through joint effort involving all stakeholders.

It is recognized that the Department is expected to provide mobility and a quality of life that includes the protection of the natural resources and the cultural and social values of their community, issues such as funding, maintenance, traffic demand, impact on alternate routes, impact on safety and laws, and rules and regulations must be addressed early with key stakeholders.

Context sensitive solutions can be achieved without necessarily reducing criteria. The ability to develop a context sensitive solution requires an understanding of the operational effects of highway geometry. Designers have the challenging task of combining community desires with good highway design practice (design criteria and guidelines) to produce workable, acceptable solutions.

1.12 Design Vehicle

One of the primary design controls for geometric highway design is based on the physical characteristics of vehicles that will utilize the facility. The controlling vehicle for design is called the design vehicle. **AASHTO's A Policy on Geometric Design of Highways and Streets** provides some general guidance on the selection of a design vehicle. **AASHTO** also provides the dimensions and turning characteristics for a variety of standard design vehicles (P, SU, WB-40, WB-62, etc.).

Studies have shown that the WB-50 is no longer a majority in the truck population on Florida's highways. The **Florida Statutes** allow truck-trailer combinations that are similar to the AASHTO WB-62 Interstate Semitrailer with some slight modifications. This modified WB-62 design vehicle used in Florida is defined here as the Florida Interstate Semitrailer (WB-62FL). The WB-62FL is more representative of the truck population on Florida's highways than the WB-50. Therefore, the WB-62FL design vehicle should now be used in situations that previously called for a WB-50. In addition, Florida's Turnpike and other truck routes, allow tandem tractor trailers, therefore the AASHTO WB-109D should be used as the design vehicle for tandem truck routes.

When designing for a WB-62FL at intersections, the design elements (control radii, return radii, etc.) can be based on the criteria tables and figures in **AASHTO** for a WB-62. In addition, when designing features for complex or constrained intersections (roundabouts, multi-lane turns, directional median openings, ramps, etc.) the geometric design elements should be checked against the turning movement of a WB-62FL. The WB-62FL is described in **Figure 1.12.1**.

Figure 1.12.1 Florida Interstate Semitrailer (WB-62FL)

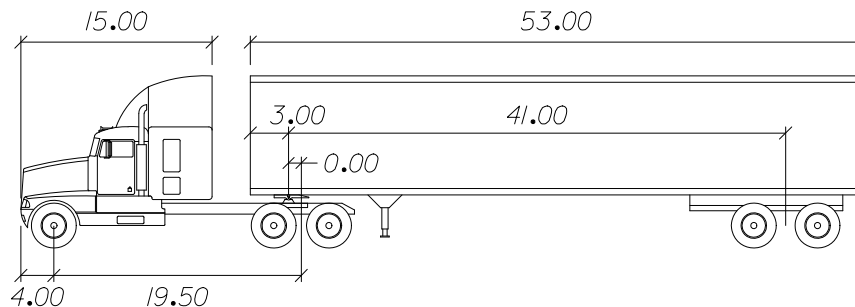

<i>WB-62FL</i>		<i>feet</i>	
<i>Tractor Width :</i>	<i>8.00</i>	<i>Lock to Lock Time :</i>	<i>6.00 seconds</i>
<i>Trailer Width :</i>	<i>8.50</i>	<i>Steering Angle :</i>	<i>28.40 degrees</i>
<i>Tractor Track :</i>	<i>8.00</i>	<i>Articulating Angle :</i>	<i>70.00 degrees</i>
<i>Trailer Track :</i>	<i>8.50</i>		

THIS PAGE LEFT BLANK INTENTIONALLY

Chapter 2

Design Geometrics and Criteria

2.0	General	2-1
2.0.1	Railroad-Highway Grade Crossing Near or Within Project Limits	2-3
2.1	Lanes	2-8
2.1.1	Through or Travel Lanes.....	2-8
2.1.2	Other Lane Widths	2-9
2.1.3	Ramp Traveled Way Widths	2-11
2.1.4	Pedestrian, Bicycle and Public Transit Facilities	2-12
2.1.4.1	Pedestrian Facilities.....	2-12
2.1.4.2	Bicycle Facilities.....	2-12
2.1.4.3	Public Transit Facilities	2-12
2.1.5	Cross Slopes.....	2-13
2.1.6	Roadway Pavement.....	2-16
2.1.6.1	Alternative Roadway Paving Treatments..	2-16
2.1.7	Transitions of Pavement Widths	2-17
2.1.8	Number of Lanes on the State Highway System	2-18
2.2	Medians.....	2-19
2.2.1	Median Width for Roadways	2-19
2.2.2	Multilane Facility Median Policy	2-20
2.2.3	Median Treatments on Bridges	2-20
2.3	Shoulders	2-21
2.3.1	Limits of Friction Course on Paved Shoulders	2-29
2.3.2	Shoulder Warning Devices (Rumble Strips).....	2-29
2.3.3	Use of Curb on High Speed Roadways	2-30

2.4	Roadside Slopes	2-31
2.5	Borders.....	2-32
2.5.1	Limited Access Facilities	2-35
2.6	Grades	2-36
2.7	Sight Distance	2-39
2.8	Curves.....	2-41
2.8.1	Horizontal Curves.....	2-41
2.8.1.1	Supplemental Alignment Control (Mainline)	2-41
2.8.1.2	Supplemental Alignment Control (Intersections)	2-46
2.8.1.3	Roadway Transitions	2-46
2.8.2	Vertical Curves.....	2-47
2.9	Superelevation	2-49
2.10	Vertical Clearance	2-55
2.10.1	Vertical Clearance Over Water	2-63
2.10.2	Airspace Obstructions	2-64
2.11	Horizontal Clearance.....	2-66
2.12	Bridge Railings and Separators.....	2-73
2.13	Intersections	2-83
2.13.1	Circular Intersections (Roundabouts).....	2-83
2.13.2	Queue Length for Unsignalized Intersections	2-83
2.13.3	Offset Left Turn Lanes	2-84
2.14	Interchanges and Median Openings/Crossovers	2-87
2.14.1	Limited Access Right of Way Limits at Interchanges	2-87

2.14.2	Median Openings at Interchanges	2-88
2.14.3	Ramp Widths.....	2-88
2.14.4	Crossovers on Limited Access Facilities	2-90
2.15	Lighting Criteria	2-96
2.16	High-Speed Urban and Suburban Arterial Highways	2-97
2.16.1	Design Speed	2-100
2.16.2	Curbs	2-100
2.16.3	Pedestrian and Bicycle Facilities.....	2-100
2.16.4	Medians	2-100
2.16.5	Shoulders	2-101
2.16.6	Friction Course.....	2-101
2.16.7	Border Width	2-101
2.16.8	Grades	2-101
2.16.9	Horizontal Curves.....	2-102
2.16.10	Superelevation	2-102
2.16.11	Horizontal Clearance.....	2-103

Tables

Table 2.1.1	Lane Widths	2-8
Table 2.1.2	Lane Widths - Special	2-9
Table 2.1.3	Ramp Widths.....	2-11
Table 2.1.4	Maximum Algebraic Difference in Cross Slope at Turning Roadway Terminals	2-15
Table 2.2.1	Median Widths	2-19
Table 2.3.1	Shoulder Widths and Slopes - Freeways	2-23
Table 2.3.2	Shoulder Widths and Slopes - Arterials Divided	2-24
Table 2.3.3	Shoulder Widths and Slopes - Arterials Undivided ...	2-25
Table 2.3.4	Shoulder Widths and Slopes - Collectors Divided and Undivided	2-26
Table 2.4.1	Roadside Slopes	2-31
Table 2.5.1	Highways with Flush Shoulders	2-33
Table 2.5.2	Highways with Curb or Curb and Gutter in Urban Areas.....	2-34
Table 2.5.3	Limited Access Facilities	2-35
Table 2.6.1	Maximum Grades.....	2-37
Table 2.6.2	Maximum Change in Grade Without Vertical Curves.....	2-37
Table 2.6.3	Criteria for Grade Datum.....	2-38
Table 2.6.4	Grade Criteria for Curb and Gutter Sections	2-38
Table 2.7.1	Minimum Stopping Sight Distance	2-39
Table 2.7.2	Minimum Passing Sight Distance.....	2-40
Table 2.8.1a	Maximum Deflections Without Horizontal Curves	2-43
Table 2.8.1b	Maximum Deflection for Through Lanes Through Intersections.....	2-43

Table 2.8.2a	Length of Horizontal Curves.....	2-44
Table 2.8.2b	Arc Length (in feet) of Compound Curves with One-Half/Double Radii - Turning Roadways	2-44
Table 2.8.3	Maximum Curvature of Horizontal Curve (Using Limiting Values of "e" and "f")	2-45
Table 2.8.4	Maximum Horizontal Curvature Using Normal Cross Slopes (-0.02)	2-45
Table 2.8.5	Minimum Lengths of Crest Vertical Curves Based on Stopping Sight Distance.....	2-47
Table 2.8.6	Minimum Lengths of Sag Vertical Curves Based on Stopping Sight Distance and Headlight Sight Distance	2-48
Table 2.9.1	Superelevation Rates for Rural Highways, Urban Freeways and High Speed Urban Highways ($e_{max} = 0.10$)	2-50
Table 2.9.2	Superelevation Rates for Urban Highways and High Speed Urban Streets ($e_{max} = 0.05$)	2-52
Table 2.9.3	Superelevation Transition Slope Rates for Rural Highways, Urban Freeways and High Speed Urban Highways.....	2-54
Table 2.9.4	Superelevation Transition Slope Rates for Urban Highways and High Speed Urban Streets.....	2-54
Table 2.10.1	Vertical Clearances for Bridges.....	2-61
Table 2.10.2	Minimum Vertical Clearances for Signs	2-62
Table 2.10.3	Minimum Vertical Clearances for Signals	2-62
Table 2.10.4	Minimum Vertical Clearances for Overhead Dynamic Message Signs (DMS)	2-62
Table 2.10.5	FAA Notification Requirements	2-65
Table 2.11.1	Horizontal Clearance for Traffic Control Signs.....	2-67
Table 2.11.2	Horizontal Clearance for Light Poles.....	2-67

Table 2.11.3	Horizontal Clearance for Utility Installations.....	2-67
Table 2.11.4	Horizontal Clearance to Signal Poles and Controller Cabinets for Signals	2-68
Table 2.11.5	Horizontal Clearance to Trees	2-68
Table 2.11.6	Horizontal Clearance to Bridge Piers and Abutments	2-68
Table 2.11.7	Horizontal Clearance to Railroad Grade Crossing Traffic Control Devices.....	2-69
Table 2.11.8	Horizontal Clearance to Canal and Drop-off Hazards.....	2-69
Table 2.11.9	Horizontal Clearance to Other Roadside Obstacles	2-69
Table 2.11.10	Horizontal Clearance for ITS Poles and Related Items	2-70
Table 2.11.11	Recoverable Terrain.....	2-71
Table 2.14.1	Ramp Widths - Turning Roadways	2-89

Figures

Figure 2.0.1	Partial Bridge Sections *	2-4
Figure 2.0.2	Bridge Section *	2-5
Figure 2.0.3	Partial Bridge Sections *	2-6
Figure 2.0.4	Bridge Section *	2-7
Figure 2.1.1	Standard Pavement Cross Slopes	2-14
Figure 2.3.1	Shoulder Superelevation.....	2-27
Figure 2.3.2	Typical Paving Under Bridge.....	2-28
Figure 2.9.1	Superelevation Rate For Rural Highways, Urban Freeways and High Speed Urban Highways ($e_{max} = 0.10$)	2-51
Figure 2.9.2	Superelevation Rates for Urban Highways and High Speed Urban Streets ($e_{max} = 0.05$)	2-53
Figure 2.10.1	Clearances – Rural and Urban Interstates (Freeways), Arterials and Collectors, with Projected 20-Year ADT of 1500 or Greater.....	2-55
Figure 2.10.2	Clearances – Rural Arterials and Collectors with Projected 20-Year ADT of Less than 1500	2-56
Figure 2.10.3	Clearances – Urban Arterials and Collectors (Without Curb and Gutter) with Projected 20-Year ADT of Less than 1500.....	2-57
Figure 2.10.4.A	Clearances – Urban Arterials and Collectors (Curb and Gutter) \leq 45 mph – Elevation of Bridge	2-58
Figure 2.10.4.B	Clearances – Urban Arterials and Collectors (Curb and Gutter) \leq 45 mph – Section through Bridge	2-59
Figure 2.10.5	Clearances – Urban Arterials and Collectors (Curb and Gutter) with Traffic Barrier	2-60
Figure 2.11.1	Horizontal Clearance to Guardrail.....	2-72
Figure 2.12.1	Bridge Traffic Railings – "F" Shapes	2-74

Figure 2.12.2	Bridge Traffic Railings – Vertical Shapes.....	2-75
Figure 2.12.3	Bridge Traffic Railings – Other Shapes.....	2-76
Figure 2.12.4	Bridge Traffic Railings – Sound Barrier Combination.....	2-77
Figure 2.12.5	Bridge Railing and Separators – Median Traffic Railing and Separators.....	2-78
Figure 2.12.6	Bridge Fencing for Traffic Railings.....	2-79
Figure 2.12.7	Bridge Railing – Pedestrian / Bicycle Railing	2-80
Figure 2.12.8	Bridge Fencing for Pedestrian Railing.....	2-81
Figure 2.12.9	Enclosed Bridge Fencing for Pedestrian Railing	2-82
Figure 2.13.1	Typical Opposing Left Turns (22’ Median with Negative 10’ Offset)	2-84
Figure 2.13.2	Typical Opposing Left Turns (22’ Median with Negative 1’ Offset)	2-85
Figure 2.13.3	Left Turn Offset Guidelines	2-85
Figure 2.14.1	Crossovers on Limited Access Facilities – 6 or More Lanes	2-93
Figure 2.14.2	Crossovers on Limited Access Facilities – 4 Lanes ..	2-94
Figure 2.14.3	Median Barrier Opening for Crossovers on Limited Access Facilities.....	2-95
Figure 2.16.1	Four-Lane High-Speed Urban and Suburban Section	2-98
Figure 2.16.2	Six-Lane High-Speed Urban and Suburban Section	2-99
Figure 2.16.3	Superelevation Rates for High-Speed Urban and Suburban Sections.....	2-102

Chapter 2

Design Geometrics and Criteria

2.0 General

The implementation of design criteria is outlined in the following text.

1. **Design Criteria:** The design criteria presented in this manual are intended as the principal source of criteria for the design of new construction or major reconstruction projects on the Florida State Highway System.

These criteria are presented by subject for major design elements as fixed values or a range of acceptable values as defined by qualifiers.

Where design criteria appear in the ***Design Standards***, they will be consistent with the criteria in this manual. In addition, some criteria will remain in the other chapters of this manual. When conflicts are discovered, they should be brought to the attention of the State Roadway Design Engineer or State Structures Design Engineer, as applicable, for resolution.

On reconstruction projects, existing project features which were constructed to meet minimum metric design criteria, but are mathematically slightly less than equivalent minimum English design criteria, do not require design exceptions or variations to remain.

Design criteria for Resurfacing, Restoration, and Rehabilitation (RRR) are presented in ***Chapter 25*** of this volume and are applicable only on programmed RRR projects.

Facilities on the Florida Intrastate Highway System (FIHS) and the Strategic Intermodal System (SIS) are subject to special standards and criteria for number of lanes, design speed, access, level of service, and other requirements. These are identified in ***Topic No. 525-030-250, Procedure for the Development of the Florida Intrastate Highway System.***

SIS and Emerging SIS Highway Intermodal Connectors on the State Highway System (SHS) shall be designed in accordance with the FIHS/SIS criteria contained in this manual. SIS and Emerging SIS Highway Intermodal Connectors on the local system (non-SHS) should also be designed in accordance with the FIHS/SIS criteria contained in this manual, but the District may allow the use of the ***Manual of Uniform Minimum Standards for Design, Construction and Maintenance for Streets and Highways*** (commonly known

as the "**Florida Greenbook**"), **Topic No. 625-000-015** depending on project specifics, with approval by the District Design Engineer.

Design Criteria for roads that are not part of the State Highway System should be obtained from the **Florida Greenbook**.

2. **Design Controls:** Design controls are characteristics and conditions that influence or regulate the selection of the criteria for project standards. It is the designer's responsibility to recognize and apply those controls applicable to the project.
3. **Design Standards:** The specific values selected from the design criteria become the design standards for a design project. These standards will be identified and documented by the designer.
4. **Project Parameters:** The properties or specific conditions with limits which require modification of design standards within these limits. The designer is responsible for establishing and documenting any project parameters and their limits, as part of the justification for deviations from project standards.

Many design standard considerations are related directly to the design speed, including vertical and horizontal geometry and required sight distances. The minimum design values are very closely related to traffic safety and cannot be compromised without an approved design exception or design variation. See **Chapter 23** of this volume.

Public facilities constructed or funded by FDOT (parking garages, weigh stations, operation centers, park & ride facilities, etc.) shall comply with the criteria in this manual, **FDOT Design Standards**, and other applicable Department manuals. Roads not on the State Highway System which are impacted by the construction of these public facilities should also be designed in accordance with Department criteria and standards, but the District may allow the use of the **Florida Greenbook** depending on project specifics.

Roadway and bridge typical sections developed for projects must reflect the values and properties outlined in Items 1 - 4 of this section. These typical sections shall include the location and limits of such features as lanes, medians, shoulders, curbs, sidewalks, barriers, railings, etc. **Section 16.2.3** of this volume gives the requirements for approval and concurrence of typical section packages.

Coordination is of primary importance on projects that contain both roadway and bridge typical sections. The Roadway and Structures Offices must address the compatibility of the typical section features mentioned above, and provide for an integrated design and review process for the project.

Example roadway typical sections are included in the exhibits in **Volume 2, Chapter 6**. Partial bridge sections, **Figures 2.0.1 - 2.0.4**, provide criteria regarding lanes, medians, and shoulders for various facilities. Subsequent sections of this chapter contain specific information and criteria regarding these and other typical section elements, as well as geometric features of both roadways and bridges.

2.0.1 Railroad-Highway Grade Crossing Near or Within Project Limits

Federal-aid projects must be reviewed to determine if a railroad-highway grade crossing is in or near the limits of the project. If such railroad-highway grade crossing exists, the project must be upgraded in accordance with **Section 6.2.3**.

Figure 2.0.1 Partial Bridge Sections *

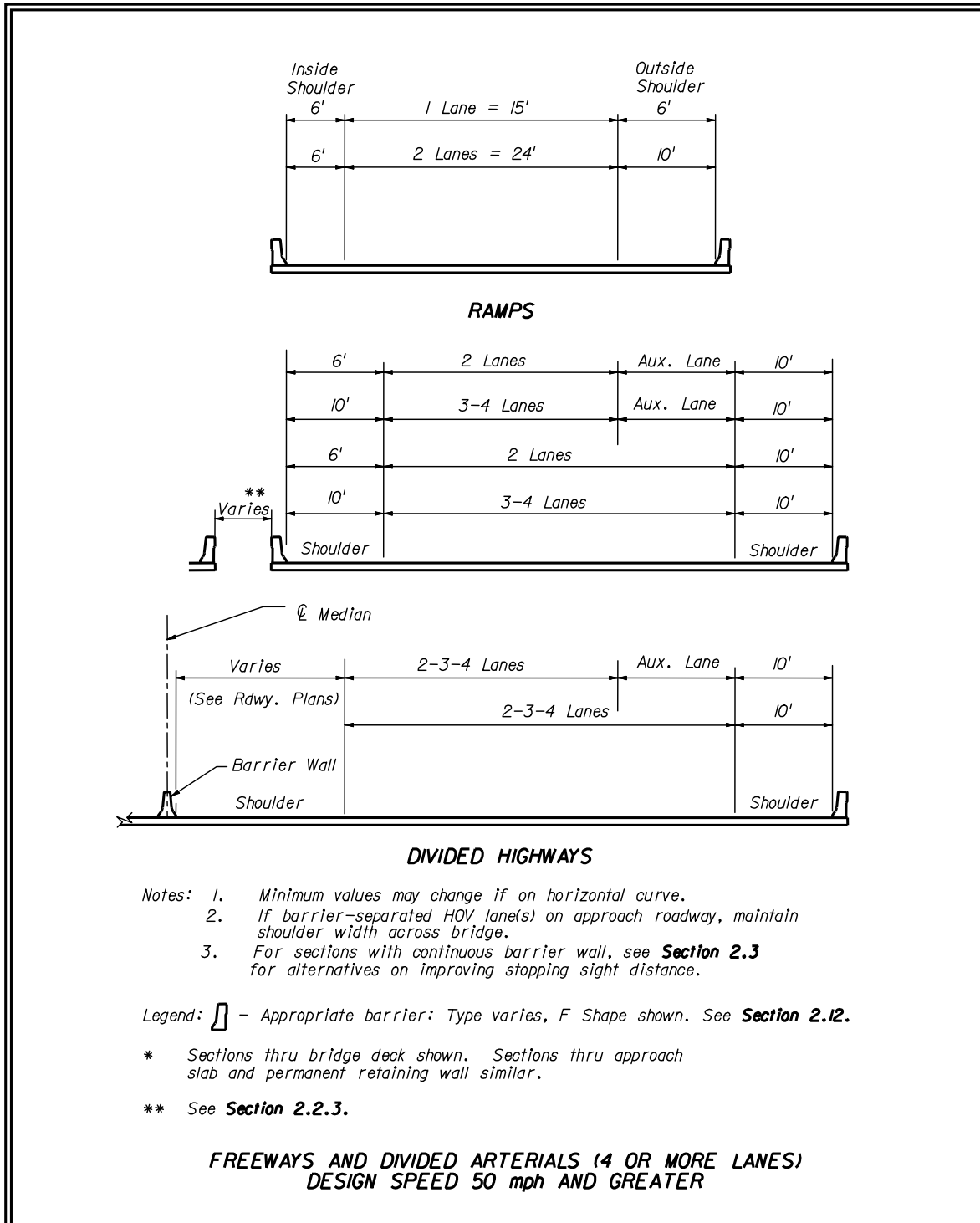

Figure 2.0.2 Bridge Section *

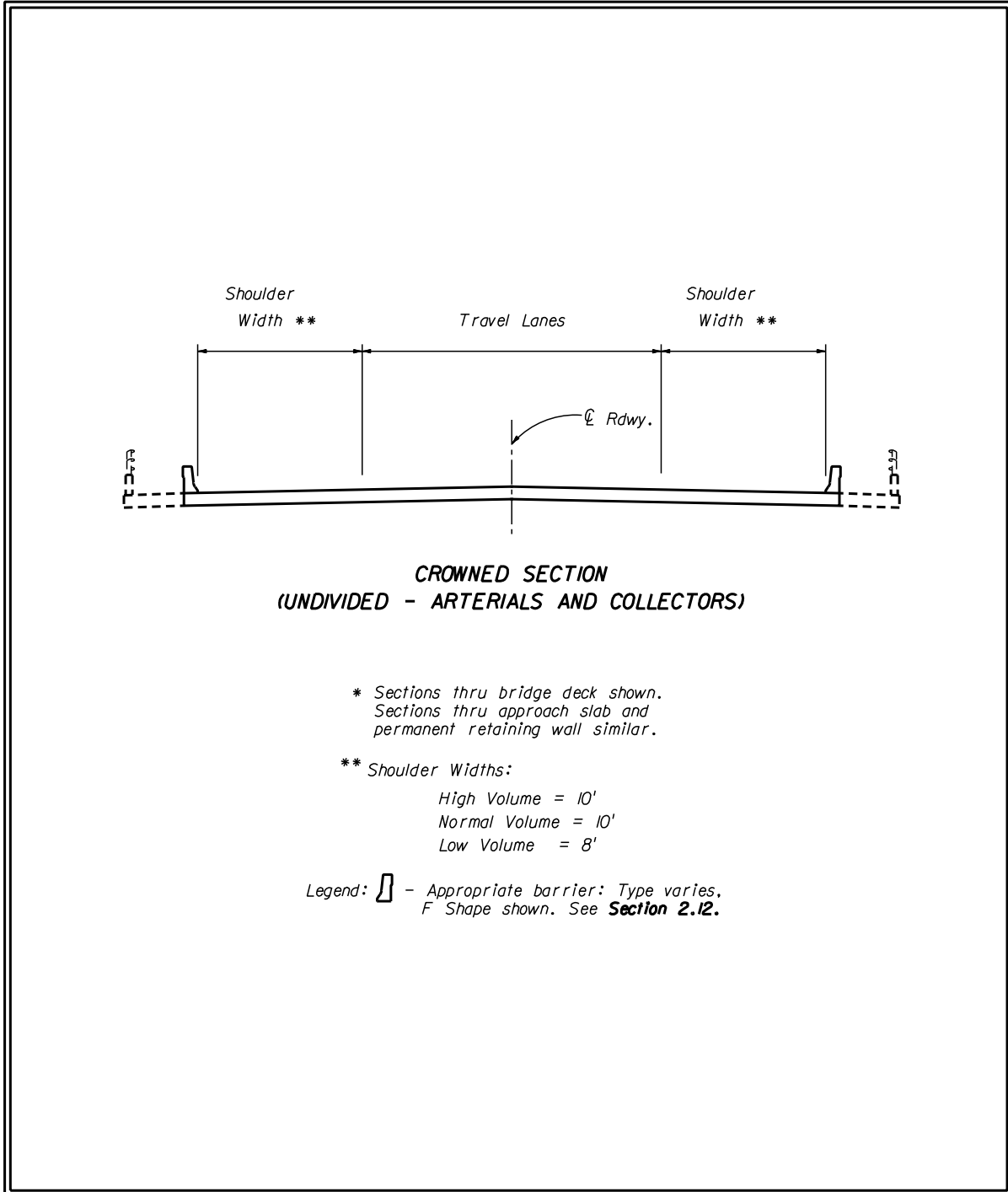

Figure 2.0.3 Partial Bridge Sections *

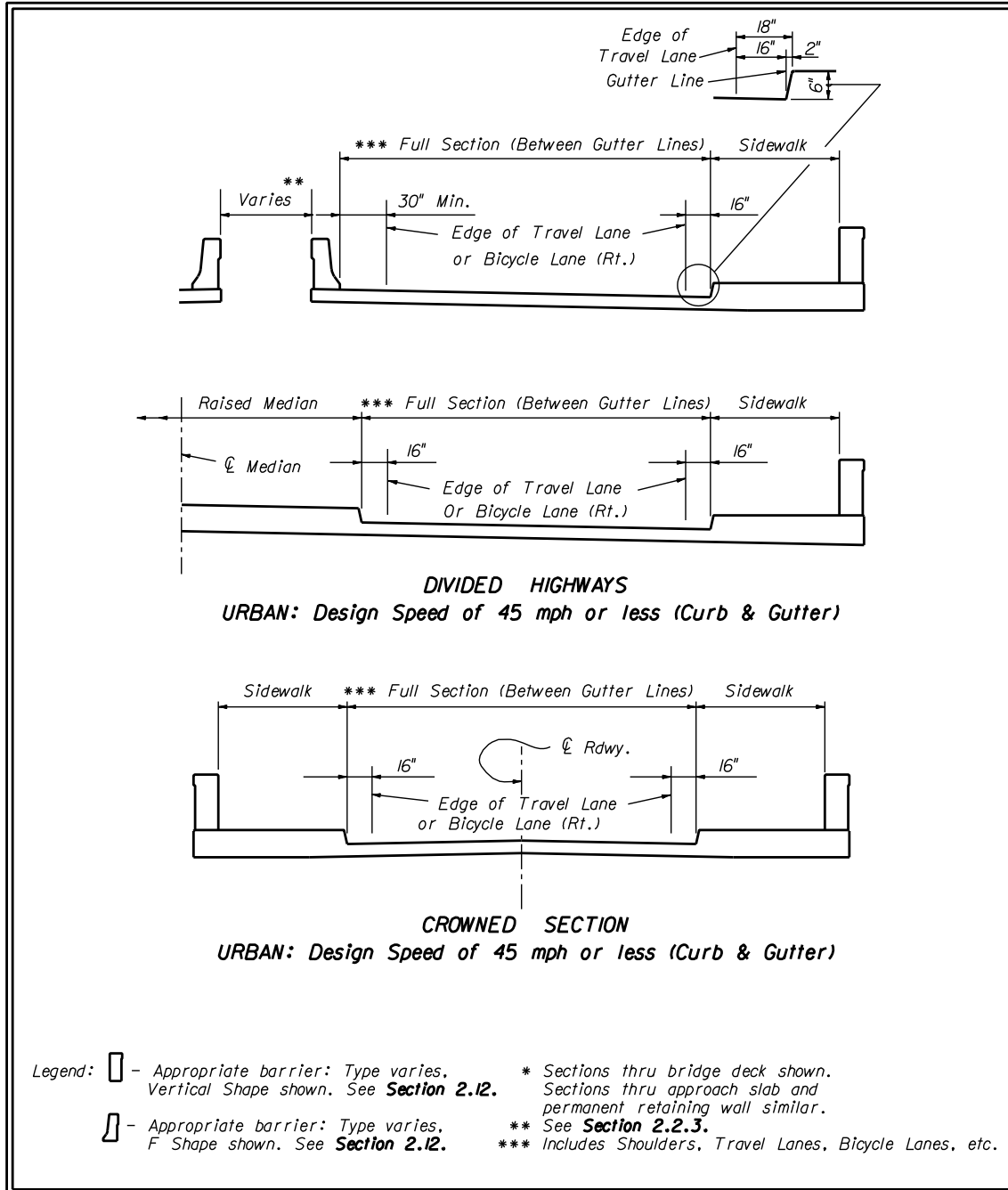
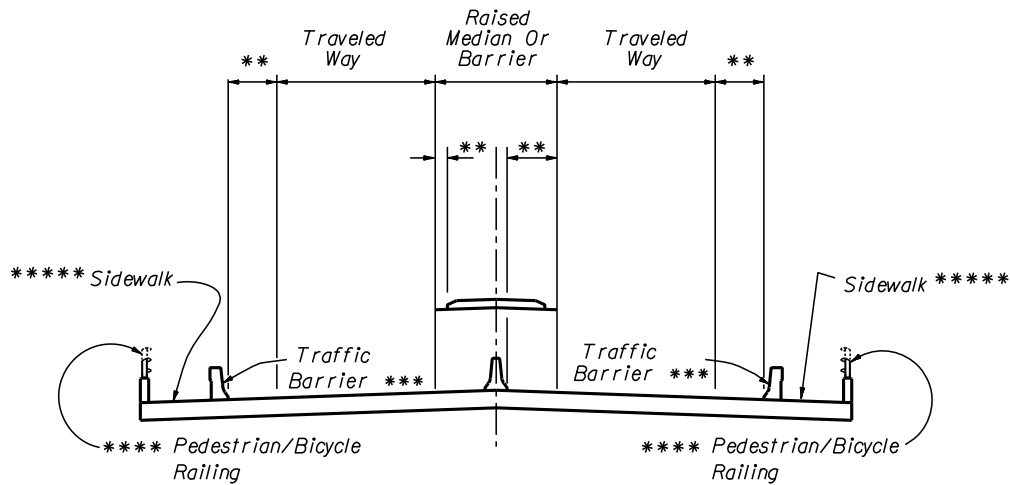

Figure 2.0.4 Bridge Section *



**DIVIDED ARTERIALS AND
 COLLECTORS - URBAN**

- * Sections thru bridge deck shown. Sections thru approach slab and permanent retaining wall similar.
- ** Outside shoulders:
 Standard curb and gutter on approach roadway:
 Use 2.5' minimum, 5.5' (with 4' bike lane), 8' minimum for long bridges (500' or greater) and/or high level bridges.
 Flush shoulder on approach roadway:
 Use 10' minimum.
- Median shoulders:
 Raised median on bridge:
 Use same offset to median as used on the approach roadway.
 Median barrier on bridge:
 Raised median on approach roadway:
 Use 2.5' minimum, and for long bridges (500' or greater) and/or high level bridges use 6' minimum for 2 lanes and 8' minimum for 3 or more lanes.
 Flush shoulder on approach roadway:
 Use 6' minimum for 2 lanes and 10' minimum for 3 or more lanes.
- *** Use traffic barrier between traveled way and sidewalk and separate pedestrian railing at back of sidewalk if heavy pedestrian traffic is anticipated or facility is near a school, or design speeds on the bridge are 50 mph or greater.
- **** Provide either a 42" or 54" pedestrian/bicycle railing as required per Section 8.8.
- ***** Sidewalks shall be a minimum of 5' in clear width and may be located along one side of the bridge only.

2.1 Lanes

Florida Department of Transportation (FDOT) criteria for lane widths and pavement slopes are given by highway type and area, through lanes, auxiliary lanes and other special lanes.

2.1.1 Through or Travel Lanes

Standard practice is to provide lane widths as wide as practical, up to 12 feet. See **Table 2.1.1**.

Table 2.1.1 Lane Widths

LANE WIDTHS (FEET)						
FACILITY		THROUGH OR TRAVEL	AUXILIARY			
TYPE	AREA		SPEED CHANGE	TURNING (LT/RT/MED)	PASSING	CLIMBING
FREEWAY	Rural	12	12	----	----	12
	Urban	12	12	----	----	12
ARTERIAL	Rural	12	12	12	12	12
	Urban	12 ₁	12 ₁	12 _{1,4}	12 ₁	12
COLLECTOR	Rural	12 ₆	11 ₂	11 _{2,4}	11 _{2,5}	12
	Urban	11 ₃	11 ₃	11 _{3,4}	11 ₃	12

1. 11 ft. permitted on non-FIHS/SIS roads if one of these conditions exist:
 - a. R/W and existing conditions are stringent controls
 - b. Facility operates on interrupted flow conditions
 - c. Design speed 40 mph or less
 - d. Intersection capacity not adversely affected
 - e. Truck volume 10% or less
2. 12 ft. lanes for all 2-lane rural.
3. 12 ft. lanes in industrial areas when R/W is available.
4. With severe R/W controls, 10 ft. turning lanes may be used where design speeds are 40 mph or less and the intersection is controlled by traffic signals. Median turn lanes shall not exceed 15 ft.
5. 12 ft. when truck volume more than 10%.
6. 11 ft. for low volume AADT.

2.1.2 Other Lane Widths

Collector-distributor lanes and auxiliary lanes for speed change, turning, storage for turning, weaving and other purposes supplementary to through-traffic movement should be of the same width as the through lanes. See **Table 2.1.2**.

Table 2.1.2 Lane Widths - Special

LANE WIDTHS (FEET)					
FACILITY		SPECIAL			
TYPE	AREA	HOV ₁	BICYCLE	OFF SYSTEM DETOUR	URBAN MULTI- PURPOSE ₄
FREEWAY	Rural	12	----	11 ₃	----
	Urban	12	----	11 ₃	----
ARTERIAL	Rural	12	5	11	----
	Urban	12	4 ₂	11	8 ₅
COLLECTOR	Rural	----	5	11	----
	Urban	----	4 ₂	11	8 ₅

1. Separated or concurrent flow.
2. A minimum width of 5 feet shall be provided when the bicycle lane is adjacent to on-street parking, a right-turn lane, guardrail or other barrier. See **Section 8.4** of this volume.
3. For Freeway detours, at least one 12 ft. lane must be provided in each direction.
4. Urban multi-purpose lanes are usually used as refuge lanes but may be used for loading zones, bus stops, emergency access and other purposes. Parking that adversely impacts capacity or safety is to be eliminated whenever practical. Standard parking width is measured from lip of gutter, with a minimum width of 8 ft. measured from face of curb.
5. 10 ft. to 12 ft. lanes for commercial and transit vehicles.

THIS PAGE LEFT BLANK INTENTIONALLY

2.1.3 Ramp Traveled Way Widths

Ramp widths for tangent and large radii (500 ft. or greater) sections are given in **Table 2.1.3**. Ramp widths in other areas such as terminals are controlled by the curvature and the vehicle type selected as the design control and are given in **Table 2.14.1, Ramp Widths**. Typical details for ramp terminals are provided in the **Design Standards**.

Table 2.1.3 Ramp Widths

RAMP WIDTHS (RAMP PROPER) FOR TANGENT AND LARGE RADII (≥ 500 ft.) SECTIONS	
ONE LANE RAMPS	15 ft.
TWO LANE RAMPS	24 ft.

For ramp widths at turning roadways see **Table 2.14.1**.

2.1.4 Pedestrian, Bicycle and Public Transit Facilities

2.1.4.1 Pedestrian Facilities

Sidewalks and pedestrian crossings shall be considered on all projects. Although the standard sidewalk width is 5 feet, it may be desirable to create wider sidewalks in business districts, near schools, transit stops, or where there are other significant pedestrian attractors. The District Pedestrian/Bicycle Coordinator shall be consulted during planning and design to establish appropriate pedestrian elements on a project-by-project basis. **Chapter 8** of this volume contains additional criteria for the accommodation of pedestrians..

2.1.4.2 Bicycle Facilities

Bicycle facilities shall be provided as required by **Chapter 8** of this volume. Bicycle lanes on the approaches to bridges should be continued across the structure. The District Pedestrian/Bicycle Coordinator shall be consulted during planning and design to establish appropriate bicycle facility elements on a project-by-project basis. **Chapter 8** of this volume contains additional criteria for the accommodation of bicyclists.

2.1.4.3 Public Transit Facilities

Coordinate with the District Modal Development Office and local transit agency for the need for public transit facilities. **Chapter 8** of this volume contains additional guidelines for street side bus stop facilities, location and design.

2.1.5 Cross Slopes

For roadways, the maximum number of travel lanes with cross slope in one direction is three lanes. This maximum may be increased to four lanes for curb and gutter roadways with four travel lanes in the same direction. See **Figure 2.1.1** for standard pavement cross slopes. The algebraic difference in cross slope between adjacent through lanes should not exceed 0.04. The maximum algebraic difference in cross slope between a through lane and an auxiliary lane at a turning roadway terminal is given in **Table 2.1.4**. **Chapter 4** on **Roadside Safety** and **Chapter 8** on **Pedestrian, Bicycle and Public Transit Facilities** (this volume) contain additional procedures and guidelines on slope design.

Cross slopes on bridges shall be on a uniform, straight-line rate, typically 0.02, in each traffic direction, with no break in slope. The straight-line slope shall be applied uniformly over all travel lanes and required shoulders in each direction of travel. Bridges with one-way traffic shall have one, uniform cross slope, while bridges with two-way traffic may be designed with a crowned bridge deck section.

This cross slope criteria applies to all bridge decks whether of cast-in-place concrete, precast concrete, or open steel decking.

Transitions shall be used to adjust for differences in cross slope between the approach roadway section and the required straight-line slope for bridge decks. Whenever possible the transition should be accomplished on the roadway section, outside the limits of the bridge and approach slabs. This will require detailing of the transition(s) in the roadway plans. Coordination between the Roadway, Drainage and Structures designers in the development of transitions is required to ensure compatibility and harmonizing at bridge approaches.

Figure 2.1.1 Standard Pavement Cross Slopes

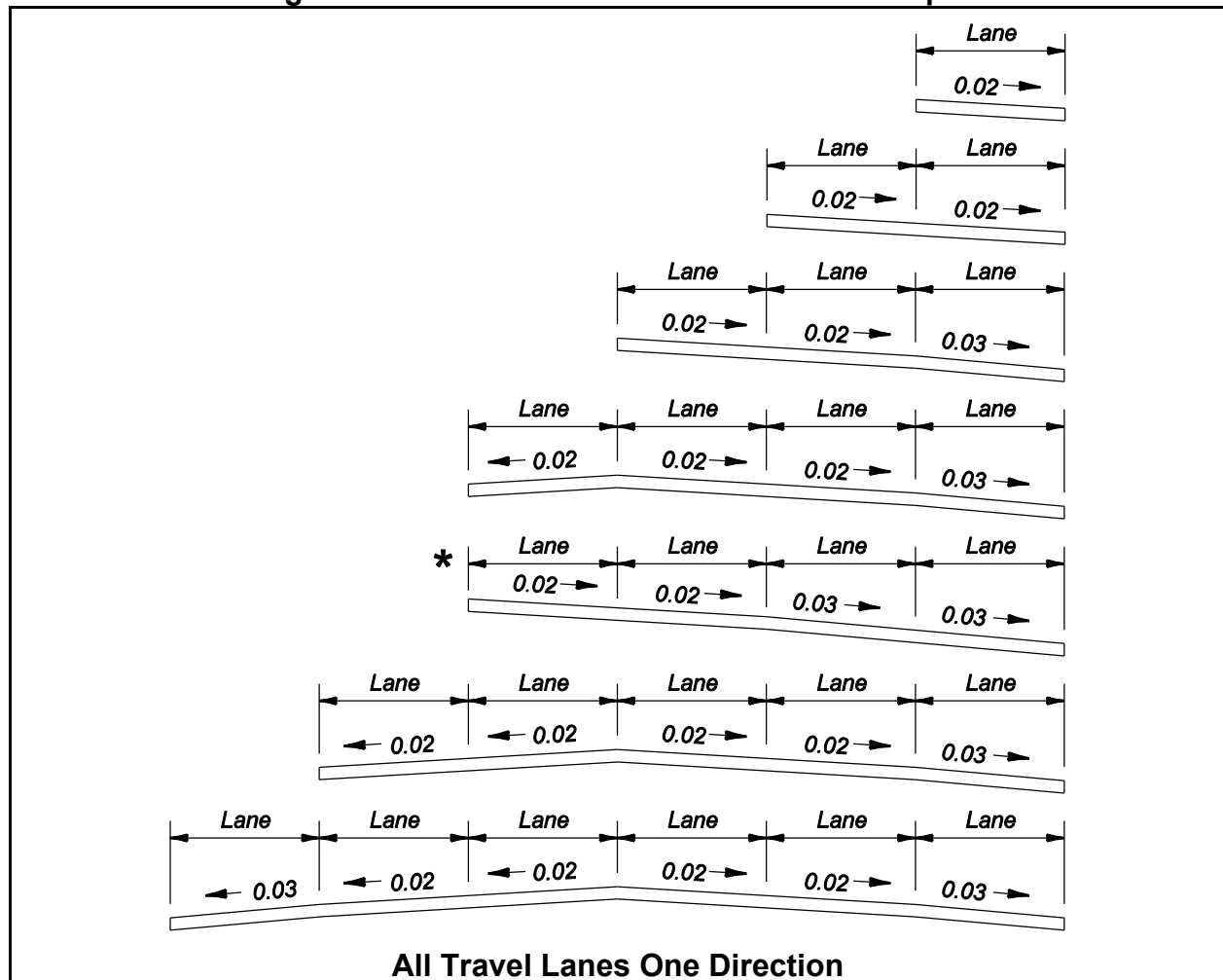

These sections show only the standard slopes for adjoining travel lanes; they do not prescribe needed lanes, lane usage or typical section requirements other than lane slope. These slopes are not applicable to parabolic crowns.

Maximum pavement cross slopes on tangent sections are:

- 0.04 for design speeds of 45 mph or less.
- 0.03 for design speeds greater than 45 mph.

The change in cross slope between adjacent through lanes shall not exceed 0.04.

Slopes on multi-purpose lanes may be 0.03 to 0.05. Portions of multi-purpose lanes that are reserved for parking and access isles for the physically disabled shall have cross slopes not exceeding 1:50 (0.02) in all directions.

*NOTE: Four travel lanes may be sloped in one direction for curb and gutter sections only.

Table 2.1.4 Maximum Algebraic Difference in Cross Slope at Turning Roadway Terminals

Design Speed of Exit or Entrance Curve (mph)	Maximum Algebraic Difference in Cross Slope at Crossover Line (%)
Less than 35	6.0
35 and over	5.0

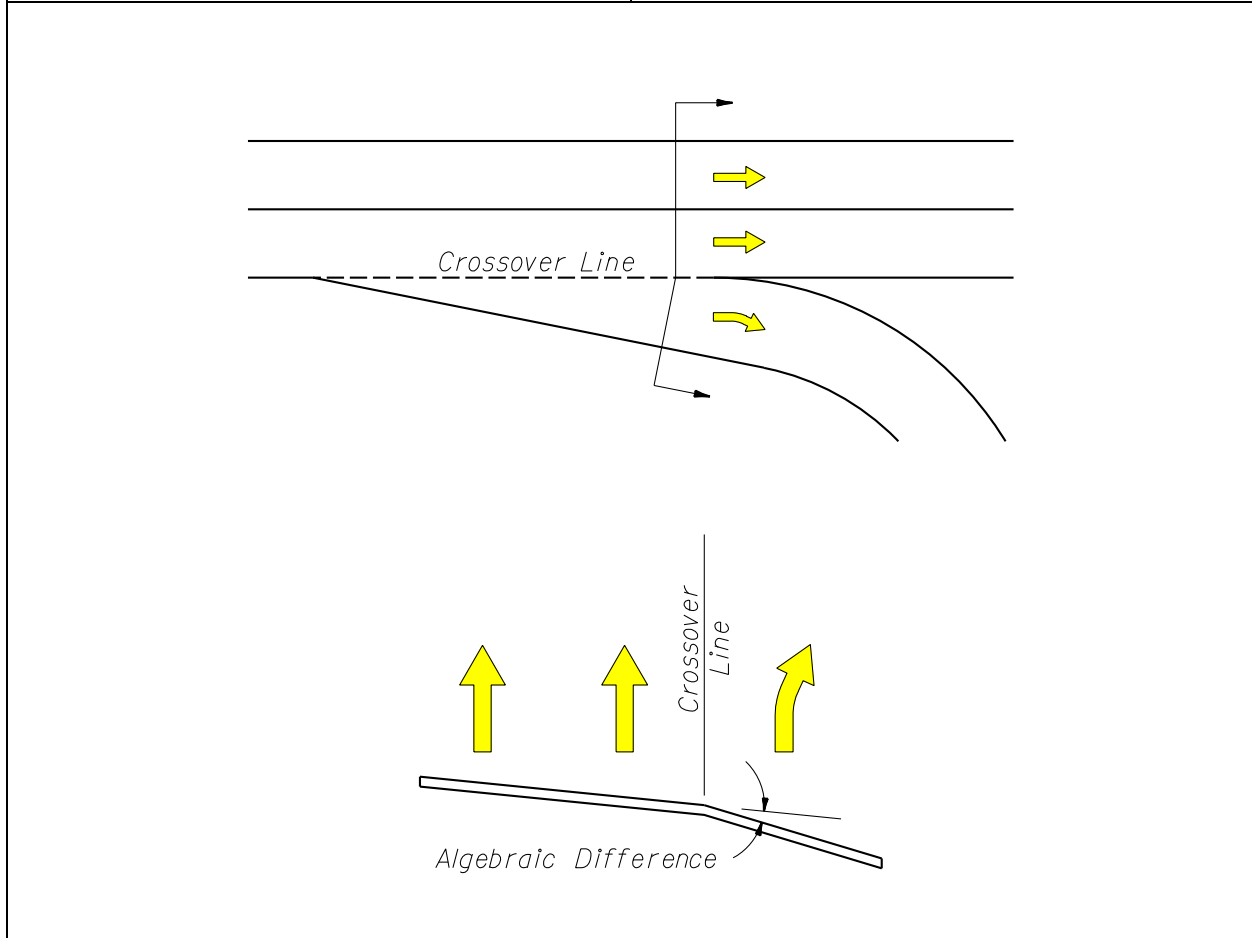

2.1.6 Roadway Pavement

The type of pavement usually is determined by analysis of the volume and composition of traffic, the soil conditions, the availability of materials, the initial cost and the estimated cost of maintenance.

Criteria and procedures for selecting the type of pavement and the structural design of the various surfacing courses are discussed in the Department's pavement design manuals.

2.1.6.1 Alternative Roadway Paving Treatments

When requested by a local community, alternative paving treatments such as patterned/textured pavement and architectural pavers meeting FDOT Specifications may be used for enhancing aesthetics and appearance. Use of either of these paving treatments involves additional construction and maintenance costs not associated with typical roadway pavement. Therefore, when used, appropriate agreements with the local community should be obtained. Maintenance agreements for installations on the State Highway System must include provisions that performance requirements for friction and wear shall be maintained for the duration of the installation. The following restrictions apply:

Architectural Pavers:

1. Shall not be used on the traveled way of the State Highway System.
2. May be used on local side streets (with a design speed of 35 mph or less), non-traffic medians and islands, curb extensions, sidewalks, borders, and other areas not subject to vehicle traffic.
3. ADA requirements must be met in areas subject to pedestrian traffic.

Patterned/textured Pavement:

1. Use on the traveled way of the State Highway System is restricted to areas within marked pedestrian crosswalks where the design speed is 45 mph or less. However, patterned/textured pavement shall not be used on pedestrian crosswalks across limited access roadway ramps. Use on pedestrian crosswalks with heavy truck traffic turning movements ($\geq 10\%$ trucks) should be avoided.
2. May be used on local side streets, non-traffic medians and islands, curb extensions, sidewalks, borders, and other areas not subject to vehicle traffic.
3. ADA requirements must be met in areas subject to pedestrian traffic.

Architectural pavers consist of brick pavers or concrete pavers placed on specially prepared bedding material and are covered under **Section 526** of the **Standard Specifications**. When used, the plans shall identify the location, type, pattern, shape and color, along with details and requirements for edge restraints, bedding material thickness, and base and subbase materials and thicknesses, as appropriate.

Patterned/textured pavement treatments may be applied to asphalt or concrete pavements and are covered under **Section 523** of the **Standard Specifications**. Patterns are defined as visible surface markings while imprinted textures are defined as palpable surface markings. When used, the plans shall identify the location, pattern/texture type (brick, stone, etc.), and coating color.

2.1.7 Transitions of Pavement Widths

When new pavement widths are not substantially greater than the joining pavement, grade differentials are slight and future widening is expected, striped transitions may be considered. An alternative approach is an abrupt change in width, with appropriate pavement markings, reflectors and rumble strips. The **Design Standards** contain additional criteria and details.

2.1.8 Number of Lanes on the State Highway System

For the number of lanes to be provided on the State Highway System, see the ***Florida Intrastate Highway System Program Development Procedure (Topic No. 525-030-255)***, and ***Section 335.02(3)*** of the ***Florida Statutes***.

Nothing in ***s. 335.02(3), F.S.***, precludes a number of lanes in excess of ten lanes. However, before the Department may determine the number of lanes should be more than that, the availability of right of way and the capacity to accommodate other modes of transportation within existing rights of way must be considered.

Exceptions to this Procedure (***Topic No.: 525-030-255; s. 335.02(3), F.S.***) will be addressed on a case-by-case basis, with final approval resting with the Secretary of Transportation.

2.2 Medians

2.2.1 Median Width for Roadways

Median widths for roadways are given in **Table 2.2.1**.

Table 2.2.1 Median Widths

MEDIAN WIDTHS (FEET)	
TYPE FACILITY	WIDTH
FREEWAYS	
Interstate, Without Barrier	64 ¹
Other Freeways, Without Barrier	---
Design Speed ≥ 60 mph	60
Design Speed < 60 mph	40
All, With Barrier, All Design Speeds	26 ²
ARTERIAL AND COLLECTORS	
Design Speed > 45 mph	40
Design Speed ≤ 45 mph	22 ³
Paved And Painted For Left Turns	12 ⁴
<p>Median width is the distance between the inside (median) edge of the travel lane of each roadway.</p> <ol style="list-style-type: none"> 1. 88 ft. when future lanes planned. 2. Based on 2 ft. median barrier and 12 ft. shoulder. 3. On reconstruction projects where existing curb locations are fixed due to severe right of way constraints, the minimum width may be reduced to 19.5 ft. for design speeds = 45 mph, and to 15.5 ft. for design speeds ≤ 40 mph. 4. Restricted to 5-lane sections with design speeds ≤ 40 mph. On reconstruction projects where existing curb locations are fixed due to severe right of way constraints, the minimum width may be reduced to 10 ft. These flush medians are to include sections of raised or restrictive median for pedestrian refuge and to conform to Section 2.2.2 of this volume and the Access Management Rules. 	

2.2.2 Multilane Facility Median Policy

All multilane SIS facilities shall be designed with a raised or restrictive median. All other multilane facilities shall be designed with a raised or restrictive median except four-lane sections with design speeds of 40 mph or less. Facilities having design speeds of 40 mph or less are to include sections of raised or restrictive median for enhancing vehicular and pedestrian safety, improving traffic efficiency, and attainment of the standards of the Access Management Classification of that highway system.

2.2.3 Median Treatments on Bridges

For divided highways, the District will determine the desired distance between structures. **Figures 2.0.1** and **2.0.3** in this chapter, indicate that a full deck is recommended if the open space between the bridges is 20 ft. or less and required when less than 10 ft. For structures with less than 20 ft. of clearance, consult with District Structures Design and Facilities Maintenance before making a final decision.

Each District Office, in deciding on a single structure deck or twin bridges, must take into account the inspection and maintenance capabilities of its personnel and equipment. If the total width for a single structure exceeds the capacity of district maintenance equipment (approximately 60 ft. reach), twin structures may be specified and the open distance between structures determined by the practical capability of the maintenance and inspection equipment. This is particularly important for girder superstructures because those areas that cannot be reached by topside equipment might require catwalks, ladders or other access features. Such features will add to the cost of superstructures and must be accounted for in the initial selection of alternates.

2.3 Shoulders

Roadway shoulder width, slope and superelevation criteria are provided in the criteria tables and figures. Paved outside shoulders, 5 ft. in width, are required on all new construction, reconstruction and lane addition projects for all highways except freeways, which generally require a 10 ft. paved outside shoulder.

Specific widths have also been adopted for interstate, expressway, single and double lane ramps and collector-distributor road shoulders. Total shoulder widths, paved shoulder widths, and widths of paved shoulder separations between through pavement edge and the near edge of any shoulder gutter are given for both right (outside) and left (inside) edges of the roadway. See **Tables 2.3.1 – 2.3.4** and **Figures 2.3.1 – 2.3.2**.

The **Design Standards, Index 104**, provides additional details for paved shoulders.

Figures 2.0.1 and **2.0.2** include criteria for shoulder widths on various bridge sections. Where these widths differ from those required for roadways or ramps, decisions about the final values chosen for the project must be coordinated between the Roadway and Structures Design Offices.

Generally, the outside shoulder width for bridges should be the same width as the approach roadway shoulder up to a maximum of 10 feet. On roadway alignments having 12 ft. shoulders with continuous barrier walls and closely spaced bridges, a 12 ft. bridge shoulder width may be considered. The decision to use 12 ft. bridge shoulder widths should be coordinated with the District Design Engineer.

For shoulder cross slope criteria on bridges see **Section 2.1.5** of this chapter.

It is recommended to pave the median section and a 10 foot outside shoulder under overpass bridges. In addition, miscellaneous asphalt should be placed from the paved shoulder to the slope pavement. This pavement will provide additional safety, enhance drainage, reduce maintenance and improve appearance. See **Figure 2.3.2**.

For paved shoulders at railroad crossings see the **Design Standards, Index 560**.

THIS PAGE LEFT BLANK INTENTIONALLY

Table 2.3.1 Shoulder Widths and Slopes - Freeways

HIGHWAY TYPE		WIDTH (FEET)								SLOPES			
		WITHOUT SHOULDER GUTTER				WITH SHOULDER GUTTER							
		FULL WIDTH		PAVED WIDTH		FULL WIDTH		PAVED WIDTH		NORMAL ₁			
		Outside	Median or Left	Outside	Median or Left	Outside	Median or Left	Outside	Median or Left	Outside	Median or Left		
F R E E W A Y S	4-Lane or More	12	12	10	10	15.5	15.5	8	8	0.06	0.06		
	3-Lane	12	12	10	10	15.5	15.5	8	8		0.05		
	2-Lane	12	8	10	4	15.5	13.5	8	6				
	HOV Lane	N/A ₄	14	N/A ₄	10	N/A ₄	N/A ₄	N/A ₄	N/A ₄	N/A ₄	0.05 ₂		
	1-lane Barrier-Separated HOV Lane ₅	6	4 ₅	6	4 ₅	N/A ₄	N/A ₄	N/A ₄	N/A ₄	Same as Lane	Same as Lane ₅		
	2-lane Barrier-Separated HOV Lane ₅	10	6 ₅	10	6 ₅	N/A ₄	N/A ₄	N/A ₄	N/A ₄	Same as Lane	Same as Lane ₅		
	1-Lane Ramp	6	6	4	2	11.5	11.5	4 ₃	4	0.05	0.05		
	2-Lane Ramp Non-Interstate	10	8	8	4	15.5	13.5	8	6				
	2-Lane Ramp Interstate	12	8	10	4	15.5	13.5	8	6				
	C-D Road 1-Lane	6	6	4	2	11.5	11.5	4	4				
	C-D Road 2-Lane	12	8	10	4	15.5	13.5	8	6				
	C-D Road 3-Lane	12	12	10	10	15.5	15.5	8	8			0.06	0.06
	C-D Road > 3-Lane	12	12	10	10	15.5	15.5	8	8				
	Auxiliary Lane Climbing & Weaving	12	N/A ₄	10	N/A ₄	15.5	N/A ₄	8	N/A ₄			N/A ₄	N/A ₄
	Auxiliary Lane Mainline Terminal:												
1-Lane Ramp	12	N/A ₄	10	N/A ₄	15.5	N/A ₄	8	N/A ₄	N/A ₄			N/A ₄	
2-Lane Ramp	12	N/A ₄	10	N/A ₄	15.5	N/A ₄	8	N/A ₄	N/A ₄	N/A ₄			
Frontage Road	See COLLECTORS Table 2.3.4 . For local roads and streets see the FDOT Manual of Uniform Minimum Standards for Design, Construction and Maintenance for Streets and Highways .												

- Shoulders shall extend 4 ft. beyond the back of shoulder gutter and at a 0.06 slope back toward the gutter.
- 0.06 when 4 lanes or more combined.
- Shoulder pavement less than 6 ft. in width that adjoins shoulder gutter shall be the same type, depth and slope as the ramp pavement.
- This does not mean that a shoulder is unnecessary; rather, shoulder is not typically present at this location (i.e., it is not required when adjacent to the through lane).
- If median side of HOV lane is not barrier-separated, use median shoulder requirements for a standard HOV lane. Refer to AASHTO's *Guide for High-Occupancy Vehicle Facilities* for additional information.

Table 2.3.2 Shoulder Widths and Slopes - Arterials Divided

HIGHWAY TYPE		WIDTH (FEET)								SLOPES		
		WITHOUT SHOULDER GUTTER				WITH SHOULDER GUTTER						
		FULL WIDTH		PAVED WIDTH		FULL WIDTH		PAVED WIDTH		NORMAL ₁		
		Outside	Median or Left	Outside ₂	Median or Left	Outside	Median or Left	Outside	Median or Left	Outside	Median or Left	
ARTERIALS	4-Lane	12	12	5	4	15.5	15.5	8	8	0.06	0.06	
		10	10	5	4	15.5	15.5	8	8			
		8	8	5	4	15.5	13.5	6	6			
	3-Lane	12	12	5	0 ₄	15.5	15.5	8	8		0.05	
		10	10	5	0 ₄	15.5	15.5	8	8			
		8	8	5	0 ₄	13.5	13.5	6	6			
	2-Lane	12	8	5	0 ₄	15.5	13.5	8	6			0.06
		10	8	5	0 ₄	15.5	13.5	8	6			
	8	6	5	0 ₄	13.5	11.5	6	4				
	1-Lane Ramp	6	6	5	2	11.5	11.5	4 ₃	4			
2-Lane Ramp	10	6	5	2	15.5	13.5	8	6				
C-D Road 1-Lane	6	6	5	2	11.5	11.5	4	4				
C-D Road 2-Lane	8	6	5	0	13.5	11.5	6	4				
Auxiliary Lane Climbing & Weaving	Same As Travel Lanes	N/A ₅	Same As Travel Lanes	N/A ₅	Same As Travel Lanes	N/A ₅	Same As Travel Lanes	N/A ₅	N/A ₅			
Auxiliary Lane Mainline Terminal: 1-Lane Ramp 2-Lane Ramp	8	N/A ₅	5	N/A ₅	11.5	N/A ₅	4	N/A ₅	N/A ₅			
	12	N/A ₅	10	N/A ₅	15.5	N/A ₅	8	N/A ₅	N/A ₅			
Auxiliary Lane At-Grade Intersection	Same As Travel Lanes	Same As Travel Lanes	5	0	11.5	N/A ₅	4	N/A ₅	0.05 - 0.06			
Frontage Road	See Collectors Table 2.3.4. For local roads and streets see the FDOT Manual of Uniform Minimum Standards for Design, Construction and Maintenance for Streets and Highways.											

- Shoulders shall extend 4 ft. beyond the back of shoulder gutter and have a 0.06 slope back toward the gutter.
- Shoulder shall be paved full width through rail-highway at-grade crossings, extending a minimum distance of 50 ft. on each side of the crossing measured from the outside rail. For additional information see the **Design Standards, Index No. 560 and 17882.**
- Shoulder pavement less than 6 ft. in width and adjoining shoulder gutter shall be the same type, depth and slope as the ramp pavement.
- Paved 2 ft. wide where turf is difficult to establish. Paved 4 ft. wide (a) in sag vertical curves, 100 ft. minimum either side of the low point, and (b) on the low side of superelevated traffic lanes extending through the curves and approximately 300 ft. beyond the PC and PT.

LEGEND FOR VALUES

X..... High Volume Highways
 X..... Normal Volume Highways
 X..... Low Volume Highways

- This does not mean that a shoulder is unnecessary; rather, shoulder is not typically present at this location (i.e., it is not required when adjacent to through lane).

Table 2.3.3 Shoulder Widths and Slopes - Arterials Undivided

HIGHWAY TYPE		WIDTHS (FEET)				SLOPES
		WITHOUT SHOULDER GUTTER		WITH SHOULDER GUTTER		NORMAL ₁
		FULL WIDTH	PAVED WIDTH ₂	FULL WIDTH	PAVED WIDTH	
ARTERIALS Undivided (lanes Two-Way)	Multilane ₃	12 10 8	5 5 5	15.5 15.5 13.5	8 8 6	0.06
	2-Lane	12 10 8	5 5 5	15.5 15.5 13.5	8 8 6	
	Auxiliary Lane At-Grade Intersections	Same As Travel Lanes	5	11.5	4	
	Frontage Road	See COLLECTORS Table 2.3.4. For local roads and streets see the FDOT Manual of Uniform Minimum Standards for Design, Construction and Maintenance for Streets and Highways.				
<p>1. Shoulders shall extend 4 ft. beyond the back of shoulder gutter and have a 0.06 slope back toward the gutter.</p> <p>2. Shoulder shall be paved full width through rail-highway at-grade crossings, extending a minimum distance of 50 ft. on each side of the crossing measured from the outside rail. For additional information see the Design Standards, Index No. 560 and 17882.</p> <p>3. All multilane facilities shall conform with Section 2.2.2 of this volume.</p> <p>LEGEND FOR VALUES X.....High Volume Highways X.....Normal Volume Highways X.....Low Volume Highways</p>						

Table 2.3.4 Shoulder Widths and Slopes - Collectors Divided and Undivided

HIGHWAY TYPE		WIDTHS (FEET)								SLOPES	
		WITHOUT SHOULDER GUTTER				WITH SHOULDER GUTTER					
		FULL WIDTH		PAVED WIDTH		FULL WIDTH		PAVED WIDTH		NORMAL ₁	
		Outside	Median Or Left	Outside ₂	Median Or Left	Outside	Median Or Left	Outside	Median Or Left	Outside	Median Or Left
C O L L E C T O R S	3-Lane	12	12	5	0 ₃	15.5	15.5	8	8	0.06	0.05
		10	10	5	0 ₃	15.5	15.5	8	8		
		8	8	5	0 ₃	13.5	15.5	6	6		
Divided (Lanes One-Way)	2-lane	12	8	5	0 ₃	15.5	13.5	8	6	0.06	0.05
		10	8	5	0 ₃	15.5	13.5	8	6		
		8	6	5	0 ₃	13.5	11.5	6	4		
C O L L E C T O R S	Multilane ₄	12		5		15.5		8		0.06	
		10		5		15.5		8			
		8		5		13.5		6			
Undivided (Lanes Two-Way)	2-Lane	12		5		15.5		8		0.06	
		10		5		15.5		8			
		8		5		13.5		6			
C O L L E C T O R S	Auxiliary Lane At-Grade Intersection	Same As Travel Lanes	Same As Travel Lanes	5	4	11.5	N/A ₅	4	N/A ₅	0.06	
		Same As Travel Lanes	Same As Travel Lanes	5	4	11.5	N/A ₅	4	N/A ₅		
		Same As Travel Lanes	Same As Travel Lanes	5	4	11.5	N/A ₅	4	N/A ₅		

1. Shoulders shall extend 4 ft. beyond the back of shoulder gutter and have a 0.06 slope back toward the gutter.
2. Shoulder shall be paved full width though rail-highway at-grade crossings, extending a minimum distance of 50 ft. on each side of the crossing measured from the outside rail. For additional information see **Design Standards, Index Nos. 560 and 1782**.
3. The median shoulder may be paved 2 ft. wide in areas of the State where establishing and maintaining turf is difficult; however, shoulders shall be paved 4 ft. wide (a) in sag vertical curves, 100 ft. minimum either side of the low point, and (b) on the low side of superelevated traffic lanes, extending through the curve and approximately 300 ft. beyond the PC and PT.
4. All multilane facilities shall conform with **Section 2.2.2** of this volume.

LEGEND

FOR XHigh Volume Highways

XNormal Volume Highways

VALUES XLow Volume Highways
5. This does not mean that a shoulder is unnecessary; rather, shoulder is not typically present at this location (i.e., it is not required when adjacent to through lane).

Figure 2.3.1 Shoulder Superelevation

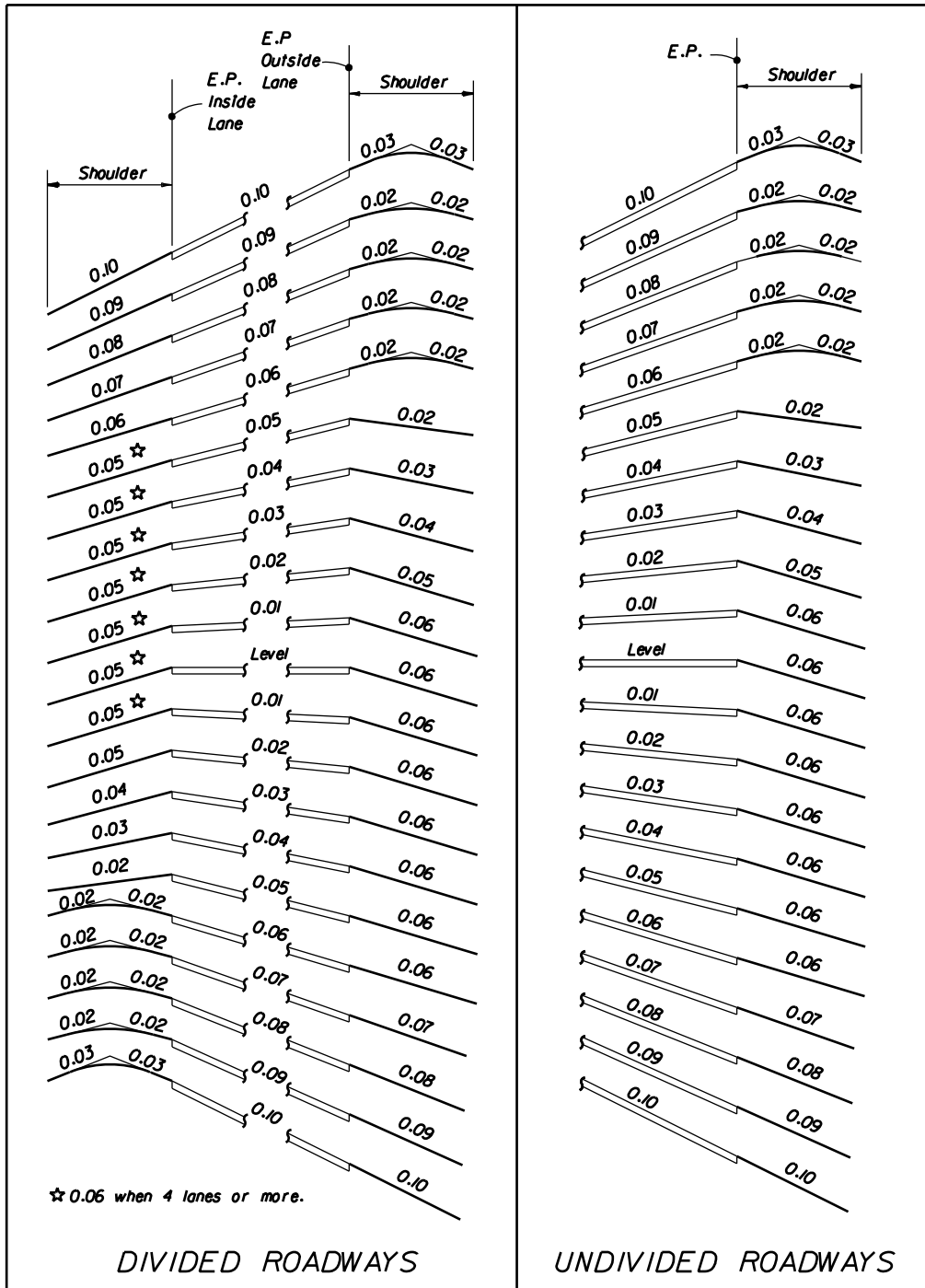
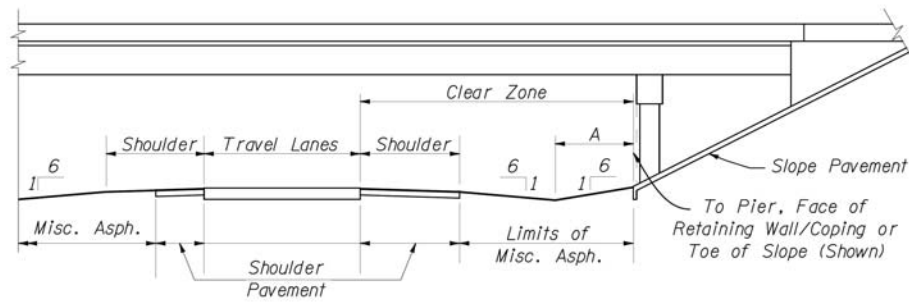
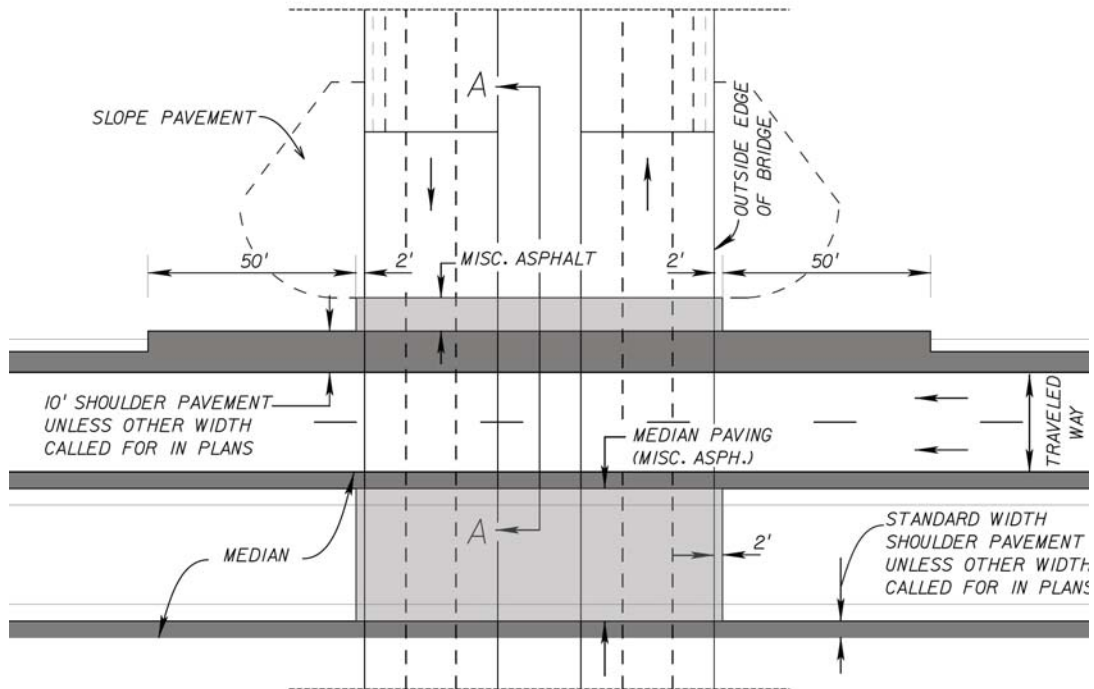

Figure 2.3.2 Typical Paving Under Bridge



SECTION A-A

FACILITY	A
FREWAYS RURAL AND URBAN INTERSTATES (FREEWAYS), ARTERIALS, AND COLLECTORS, WITH PROJECTED 20-YEAR ADT OF 1500 OR GREATER	12'
RURAL ARTERIALS AND COLLECTORS WITH PROJECTED 20-YEAR ADT OF LESS THAN 1500.	8'
URBAN ARTERIALS AND COLLECTORS FLUSH SHOULDER ROADWAYS WITH PROJECTED 20-YEAR ADT OF LESS THAN 1500	6'

2.3.1 Limits of Friction Course on Paved Shoulders

Friction courses on limited access facilities shall be extended 8 inches onto both the median and outside paved shoulders of roadways.

Friction courses shall be extended the full width of the paved shoulder on non-limited access highways to accommodate bicyclist usage.

2.3.2 Shoulder Warning Devices (Rumble Strips)

The safety of freeways and other limited access facilities on the State highway system is to be enhanced by the installation of shoulder warning devices in the form of rumble strips. Projects on limited access facilities shall include the construction of ground-in rumble strips. Several types of applications have been tested. The ground-in strips provide the desired warning to the driver and consistency in application has been possible using this construction process.

These ground-in strips are installed using two patterns. The skip array is the standard array. These are used on both inside and outside shoulders on divided highway sections. The continuous array shall be constructed in advance of bridge ends for a distance of 1000 ft. or back to the gore recovery area for mainline interchange bridges. Other areas may be specified in plans.

Methods and types of application other than described above and in the ***Design Standards, Index 518***, shall not be used unless concurred in by the State Roadway Design Engineer. Approval will be considered only with sufficient documented justification for deviation from the standard.

The ***Design Standards, Index 518***, has been prepared to provide all needed details. This index also gives standards for raised rumble strips for use at structures where the bridge shoulder width is less than the width of the useable shoulder on the approach roadway. Notes for locations of raised rumble strip applications are also included on the index.

2.3.3 Use of Curb on High Speed Roadways

Curbs shall not be used on high speed roadways (Design Speed > 45 mph) except as follows:

1. FDOT Suburban Section
2. FDOT High Speed Urban Section
3. Directional Median Openings
4. Transit Stops

Curbs used on high speed roadways shall be FDOT Type E with the face of the curb placed no closer to the edge of the traveled way than the outside edge of the shoulder. For the Suburban and High Speed Urban Section, special offset widths to curb have been established. See **Section 2.16** for requirements for High-Speed Urban and Suburban Arterial Highways. For directional median openings, see **Index 527**. For transit stops, the curb face shall be no closer to the edge of the traveled way than the outside edge of the approach shoulder.

2.4 Roadside Slopes

Criteria and details for roadside slopes are included in **Table 2.4.1**. Clear zone criteria are included in **Section 2.11** and **Chapter 4** of this volume.

Table 2.4.1 Roadside Slopes

TYPE OF FACILITY	RURAL & URBAN FREEWAYS, RURAL ARTERIALS AND COLLECTORS, WITH PROJECTED 20 YEAR AADT OF 1500 OR GREATER		RURAL ARTERIALS AND COLLECTORS WITH PROJECTED 20 YR. AADT LESS THAN 1500 AND RURAL LOCALS, URBAN ARTERIALS AND COLLECTORS WITHOUT CURB & GUTTER		URBAN ARTERIALS AND COLLECTORS WITH CURB & GUTTER	
	DESIGN SPEED 45 mph OR GREATER		ALL SPEEDS		DESIGN SPEED 45 mph OR LESS	
	Height of Fill (feet) *	Rate	Height of Fill (feet) *	Rate	Height of Fill (feet) *	Rate
Front Slope	0.0 - 5 5 - 10 10 - 20 >20	1:6 1:6 to edge of CZ then 1:4 1:6 to edge of CZ then 1:3 1:2 (with guardrail)	0.0 - 5 5 - 20	1:6 Where R/W is insufficient, 1:6 to edge of CZ then 1:3 1:6 to edge of CZ then 1:3. Where, R/W is insufficient, 1:6 to edge of CZ then 1:2.	All	1:2 or to suit property owner, not flatter than 1:6. R/W cost must be considered for high fill sections in urban areas
Back Slope	All	1:4 or 1:3 with a standard width trapezoidal ditch and 1:6 front slope	All	1:4 when R/W permits or 1:3	All	1:2 or to suit property owner. Not flatter than 1:6.
Transverse Slopes	All	1:10 or flatter (freeways) 1:4 (others)	All	1:4	All	1:4

* Height of Fill is the vertical distance from the edge of the outside travel lane to the toe of front slope.

2.5 Borders

Border widths for new construction or major reconstruction where R/W acquisition is required are as follows:

On highways with flush shoulders, the border is measured from the shoulder point to the right of way line. This border width accommodates (1) roadside design components such as signing, drainage features, guardrail, fencing and clear zone, (2) the construction and maintenance of the facility and (3) permitted public utilities. See **Table 2.5.1**.

On highways with curb or curb and gutter where clear zone is being provided, border width is to be based on flush shoulder requirements, but is measured from the lip of the gutter (or face of curb when there is not a gutter) to the right of way line. This border width accommodates (1) roadside design components such as signing, drainage features, guardrail, fencing and clear zone, (2) the construction and maintenance of the facility and (3) permitted public utilities. See **Table 2.5.1**.

On highways with curb or curb and gutter in urban areas, the border is measured from the lip of the gutter (or face of curb when there is not a gutter) to the right of way line. This border provides space for a buffer between vehicles and pedestrians, sidewalks with ADA provisions, traffic control devices, fire hydrants, storm drainage features, bus and transit features, permitted public utilities and space for aesthetic features such as sod and other landscape items. See **Table 2.5.2**.

On limited access facilities, the border width criteria are provided in **Section 2.5.1**.

Projects involving bridges will require coordination to match the features of the roadway with those of the bridge.

On existing streets and highways where R/W cannot be acquired or where the decision has been made to simply maintain and preserve the facility, the border area must be reserved for the functional and safety needs of the facility. Extraordinary design effort will be required to meet ADA requirements, driveway construction and the other essential features. Spot R/W acquisitions may be required along the corridor to accommodate these essential components. The absolute minimum border under these conditions is 8 feet.

Table 2.5.1 Highways with Flush Shoulders

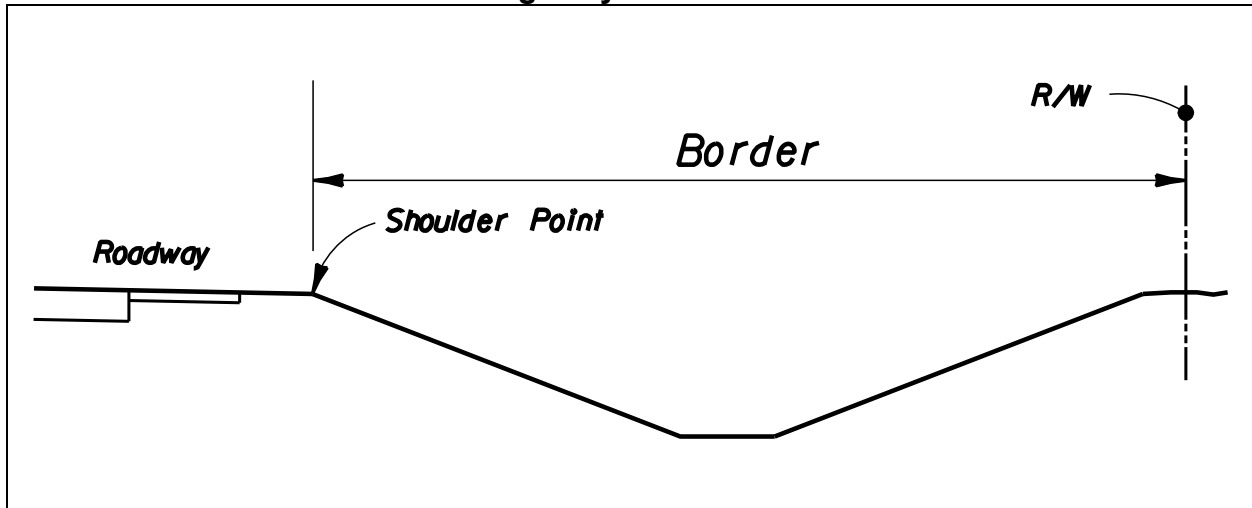

The diagram illustrates a highway cross-section. On the left, a horizontal line represents the 'Roadway'. A vertical line marks the 'Shoulder Point' where the roadway meets the shoulder. A horizontal double-headed arrow labeled 'Border' spans from the shoulder point to a vertical dashed line on the right labeled 'R/W' (Right-of-Way). The ground profile is shown as a trapezoidal shape sloping down from the shoulder point to a flat bottom and then sloping up to the R/W line.

BORDER	
TYPE FACILITY	WIDTH (FEET)
ARTERIALS COLLECTORS Design Speed > 45 mph	40
ARTERIALS COLLECTORS Design Speed ≤ 45 mph	33

Table 2.5.2 Highways with Curb or Curb and Gutter in Urban Areas

The diagram illustrates the cross-section of a highway with a curb or curb and gutter. From left to right, it shows the Right-of-Way (R/W) boundary, a Buffer Strip, a Sidewalk, another Buffer Strip, and the Face of Curb or Lip of Gutter. A horizontal line labeled 'Border' spans from the R/W boundary to the Face of Curb or Lip of Gutter. A vertical dashed line marks the R/W boundary. A vertical solid line marks the Face of Curb or Lip of Gutter. A horizontal arrow points from the R/W boundary to the Face of Curb or Lip of Gutter, labeled 'Border'. A vertical arrow points to the Face of Curb or Lip of Gutter, labeled 'Face of Curb or Lip of Gutter *'. The diagram shows a cross-section of the road surface with a curb and gutter on the right side.

*** Border width measured from lip of gutter (shown) or from face of curb when there is not a gutter.**

BORDER		
TYPE FACILITY	MINIMUM WIDTH (FEET)	
	TRAVEL LANES AT CURB OR CURB AND GUTTER	BICYCLE LANES OR OTHER AUXILIARY LANES AT CURB OR CURB AND GUTTER
ARTERIALS COLLECTORS Design Speed = 45 mph	14	12
ARTERIALS COLLECTORS Design Speed ≤ 40 mph	12	10
URBAN COLLECTOR STREETS Design Speed ≤ 30 mph	10	8

2.5.1 Limited Access Facilities

On limited access facilities, the border is measured from the edge of the outside traffic lane to the right of way line. This width may be reduced in the area of a crossroad terminal, as long as the design meets the requirements for clear zone, horizontal clearance, drainage, maintenance access, etc.

Limited access facilities shall be contained by fencing, or in special cases, walls or barriers. These treatments shall be continuous and appropriate for each location. Treatment height and type may vary under special conditions. The treatment is typically placed at or near the limited access right of way line, but location may be adjusted based on site-specific conditions (i.e., ponds, trees, bridges, etc.). Placement information and additional data is included in the *Design Standards, Indexes 800, 801, and 802*.

Table 2.5.3 Limited Access Facilities

BORDER	
TYPE FACILITY	WIDTH (FEET)
FREEWAYS (INCLUDING INTERCHANGE RAMPS)	94

2.6 Grades

The profile grade line defines the vertical alignment for roadway and bridge construction. As with other design elements, the characteristics of vertical alignment are influenced greatly by basic controls related to design speed, traffic volumes, functional classification, drainage and terrain conditions. Within these basic controls, several general criteria must be considered. See **Tables 2.6.1 – 2.6.4**.

Minimum clearances for structures over railroads are given in **Table 2.10.1**. Additional information, including at-grade crossings, is given in **Chapter 6** of this volume.

The Department's minimum for structure clearance over all highways is given in the criteria tables and figures. Exceptions to this policy shall be permitted only when justified by extenuating circumstances and approved as a variation or exception.

The clearance required for the roadway base course above the Base Clearance Water Elevation is given in the criteria tables and figures.

The relationship between the pavement elevation and the Design Flood Elevation is discussed in **Section 4.4 (3)** of the **FDOT Drainage Manual (Topic No. 625-040-002)**.

Grades for structures over water shall be designed to provide the minimum vertical clearance as stipulated in **Section 2.10** of this chapter.

The **Design Standards** lists minimum covers and maximum fill heights for all types of culverts. For utility clearances, refer to the **Utility Accommodation Manual**.

Table 2.6.1 Maximum Grades

MAXIMUM GRADES IN PERCENT													
TYPE OF HIGHWAY	AREA	DESIGN SPEED (mph)											
		FLAT TERRAIN						ROLLING TERRAIN					
		30	40	45	50	60	70	30	40	45	50	60	70
FREEWAYS ₁	Rural	----	----	4	4	3	3	----	----	----	5	4	4
	Urban	----	----	4	4	3	3	----	----	----	5	4	4
ARTERIALS ₃	Rural	----	5	5	4	3	3	----	6	6	5	4	4
	Urban	8	7	6	6	5	----	9	8	7	7	6	----
COLLECTORS ₃	Rural	7	7	7	6	5	4	9	8	8	7	6	5
	Urban	9	9	8	7	6	5	11	10	9	8	7	6
	Industrial ₂	4	4	4	3	3	----	5	5	5	4	4	----
FRONTAGE ROADS	Require same criteria as Collectors.												
RAMPS	DESIGN SPEED (mph)		< 20		25 to 30		35 to 40		45 to 50				
	GRADES (%)		6 to 8		5 to 7		4 to 6		3 to 5				
One-way descending grades on Ramps may be 2% greater, in special cases.													
1. Interstate designed to 70 mph will be restricted to 3% maximum grade. 2. Areas with significant (10% or more) heavy truck traffic. 3. On 2-lane highways critical length of upgrades shall not be exceeded. Critical lengths are those which reduce the speeds of 200 lb/hp trucks by more than 10 mph.													

Table 2.6.2 Maximum Change in Grade Without Vertical Curves

DESIGN SPEED (mph)	20	30	40	45	50	60	65	70
MAXIMUM CHANGE IN GRADE IN PERCENT	1.20	1.00	0.80	0.70	0.60	0.40	0.30	0.20

Table 2.6.3 Criteria for Grade Datum

CLEARANCE FOR THE ROADWAY BASE COURSE ABOVE THE BASE CLEARANCE WATER ELEVATION	
TYPE FACILITY	REQUIRED CLEARANCE
Freeways and Rural Multilane Mainline	3 ft.
Ramps (proper)	2 ft. ₁
Low Point on Ramps at Cross Roads	1 ft. ₁
Rural Two-lane with Design Year ADT Greater than 1500 VPD	2 ft. ₁
All Other Facilities Including Urban	1 ft. ₁

1. This clearance requires a reduction in the design resilient modulus (see the *Flexible Pavement Design Manual*). Notify the Pavement Design Engineer that the clearance is less than 3 feet.

Table 2.6.4 Grade Criteria for Curb and Gutter Sections

GRADES ON CURB AND GUTTER SECTIONS	
Minimum Distance Required between VPI's	250 ft.
Minimum Grade (%)	0.3 %

(See **Table 2.6.1** for Maximum Grades)

2.7 Sight Distance

Minimum stopping and passing sight distances are given in **Tables 2.7.1 – 2.7.2.**

Table 2.7.1 Minimum Stopping Sight Distance

MINIMUM STOPPING SIGHT DISTANCE (FEET) (For application of stopping sight distance, use an eye height of 3.5 feet and an object height of 0.5 feet above the road surface)														
DESIGN SPEED (mph)	GRADES OF 2% OR LESS													
	Interstate							All Other Facilities						
15	----							80						
20	----							115						
25	----							155						
30	----							200						
35	----							250						
40	----							305						
45	----							360						
50	----							425						
55	570							495						
60	645							570						
65	730							645						
70	820							730						
ADJUSTMENT IN DISTANCE FOR GRADES GREATER THAN 2%														
DESIGN SPEED (mph)	INCREASE IN LENGTH FOR DOWNGRADE (ft.)							DECREASE IN LENGTH FOR UPGRADE (ft.)						
	Grades							Grades						
	3%	4%	5%	6%	7%	8%	9%	3%	4%	5%	6%	7%	8%	9%
15	0	0	1	2	3	4	5	5	5	6	6	7	7	7
20	1	2	3	5	6	8	10	6	7	8	8	10	10	11
25	3	5	7	10	12	15	18	8	9	11	12	13	14	16
30	5	8	11	15	18	22	27	10	12	14	16	18	20	21
35	7	11	16	21	26	31	37	13	16	19	21	24	26	28
40	10	15	21	28	34	41	49	16	20	24	27	30	33	36
45	18	25	32	40	48	57	67	16	21	25	29	33	37	40
50	21	29	39	49	59	70	82	20	26	32	37	42	46	50
55	25	35	46	58	70	84	98	26	33	39	45	52	57	62
60	28	40	53	68	82	99	116	32	40	48	55	62	69	75
65	37	51	67	83	101	120	140	33	43	52	61	69	77	84
70	41	58	76	95	115	137	161	40	52	62	72	82	91	99

Table 2.7.2 Minimum Passing Sight Distance

MINIMUM PASSING SIGHT DISTANCE (FEET) (For application of passing sight distance, use an eye height of 3.5 feet and an object height of 3.5 feet above the road surface)											
DESIGN SPEED (mph)	20	25	30	35	40	45	50	55	60	65	70
2-Lane, 2-Way Facilities	710	900	1090	1280	1470	1625	1835	1985	2135	2285	2480

2.8 Curves

2.8.1 Horizontal Curves

Design speed is the principal factor controlling horizontal alignment. Several geometric standards related to design speed are very specific. Other criteria cannot be defined as specifically and require that judgments be made by designers in consideration of local conditions.

2.8.1.1 Supplemental Alignment Control (Mainline)

On projects which include roadways and bridges, coordination between the Roadway and Structures Design Offices may be necessary for those horizontal alignment issues affecting the location or geometry of the structure(s).

If possible, horizontal curves, PI's and superelevation transitions should not be placed within the limits of a structure or approach slabs. Because of the impact on the structure framing, spiral curves or alignments that result in skews greater than 45 degrees should be avoided. When skews greater than 45 degrees and/or spirals are necessary, specific justification shall be submitted to the District Design Engineer for concurrence, prior to proceeding with the alignment. For alignments that result in skews greater than 45 degrees, alternate framing concepts that relieve the severe skew effect should be considered. This may consist of longer bridges, placing framing members normal to the skew, etc.

Placement of stationing equations within the limits of a structure should be avoided on contract plans. Such equations unnecessarily increase the probability of error in both the design and construction phase.

Further guidelines have been established by the Department for lengths of horizontal curves, maximum deflections without curves, redirection of through lanes at intersections and minimum transition lengths between reverse curves. The criteria given are intended for use in establishing minimum lengths for both rural and urban conditions. See **Tables 2.8.1 – 2.8.4**.

For small deflection angles (5° or less), curves should be suitably lengthened to avoid the distracting appearance of a kink. Curves should be at least 500 ft. long for a central angle of 5° and the minimum increased 100 ft. for each 1° decrease in the central angle

(900 ft. for a 1° central angle). This treatment may not be practical in developed or environmentally sensitive areas or for major modifications of existing facilities.

For design, the aesthetic control given above should be considered where practical, but may be compromised where other considerations warrant such action. Discernment of alignment changes in an urban setting is normally minimal due to the masking effects of development, traffic signs, various items of interest and similar distracting stimuli.

For information on the maximum deflection without a curve, see **Table 2.8.1**.

When superelevation is required for curves in opposite directions on a common tangent, a suitable distance is required between the curves. This suitable tangent length should be determined as follows:

1. 80% of the transition for each curve should be located on the tangent.
2. The suitable tangent length is the sum of the two 80% distances, or greater.
3. Where alignment constraints dictate a less than desirable tangent length between curves, an adjustment of the 80/20 superelevation transition treatment is allowed (where up to 50% of the transition may be placed on the curve).

The use of compound curves in horizontal alignment should be avoided where simple curves can be used. When compound curves are necessary on open highways, the ratio of the flatter radius to the sharper radius should not exceed 1.5:1. For turning roadways and intersections a ratio of 2:1 (where the flatter radius precedes the sharper radius in the direction of travel) is acceptable.

The length of compound curves for turning roadways when followed by a curve of one-half radius or preceded by a curve of double radius should be as shown in **Table 2.8.2b**.

Table 2.8.1a Maximum Deflections Without Horizontal Curves

MAXIMUM DEFLECTION WITHOUT CURVE (DMS)			
TYPE FACILITY		V ≥ 45 mph	V ≤ 40 mph
Freeways		0° 45' 00"	N/A
Arterials and Collectors	Without Curb & Gutter	0° 45' 00"	2° 00' 00"
	With Curb & Gutter	1° 00' 00"	2° 00' 00"
Where V=Design Speed (mph)			

Table 2.8.1b Maximum Deflection for Through Lanes Through Intersections

Design speed (mph)	20	25	30	35	40	45
Maximum Deflection	16° 00'	11° 00'	8° 00'	6° 00'	5° 00'	3° 00'

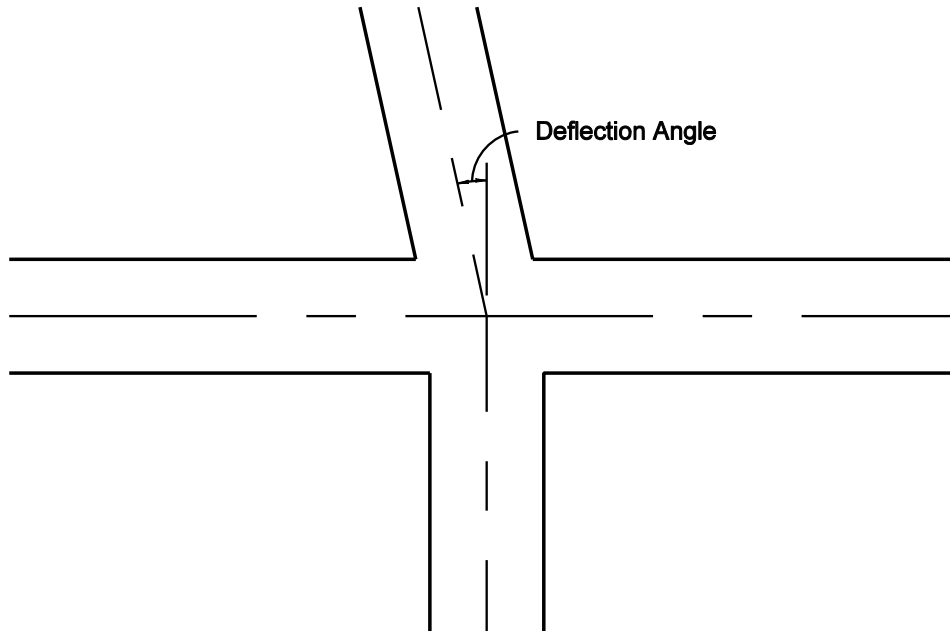

Table 2.8.2a Length of Horizontal Curves

LENGTH OF CURVE (FEET)	
Freeways	30V ₁
Arterials	15V ₂
Collectors	15V ₂
Where V=Design Speed (mph)	
1. When 30V cannot be attained, the greatest attainable length shall be used, but not less than 15V. 2. When 15V cannot be attained, the greatest attainable length shall be used, but not less than 400 ft.	
Curve length shall provide full superelevation within the curve of not less than 200 ft. (Rural) or 100 ft. (Urban).	

Table 2.8.2b Arc Length (in feet) of Compound Curves with One-Half/Double Radii - Turning Roadways

Radius (ft.)	100	150	200	250	300	400	≥ 500
Minimum Length	40	50	65	85	100	115	150
Desirable Length	65	65	100	115	150	180	200

**Table 2.8.3 Maximum Curvature of Horizontal Curve
 (Using Limiting Values of "e" and "f")**

MAXIMUM CURVATURE (Degrees)			
Design Speed (mph)	RURAL ENVIRONMENT (e max=0.10)	URBAN ENVIRONMENT (e max=0.05)	
		Without Curb And Gutter	With Curb And Gutter
30	24° 45'	20° 00'	20° 00'
35	17° 45'	14° 15'	14° 15'
40	13° 15'	10° 45'	10° 45'
45	10° 15'	8° 15'	8° 15'
50	8° 15'	6° 30'	6° 30'
55	6° 30'	5° 00'	---
60	5° 15'	---	---
65	4° 15'	---	---
70	3° 30'	---	---
Interstate: 3° 00' (Maximum Curvature) (e max=0.10)			

**Table 2.8.4 Maximum Horizontal Curvature
 Using Normal Cross Slopes (-0.02)**

MAXIMUM CURVATURE (Degrees)		
Design Speed (mph)	Curvature (e max = 0.10)	Curvature (e max = 0.05)
30	1° 30'	7° 00'
35	1° 30'	5° 00'
40	1° 00'	3° 45'
45	0° 30'	2° 45'
50	0° 30'	2° 00'
55	0° 30'	---
60	0° 15'	---
65	0° 15'	---
70	0° 15'	---

2.8.1.2 Supplemental Alignment Control (Intersections)

For redirection or offset deflection of through lanes through intersections, see the values given in **Table 2.8.1b**. Curves are not required for these angular breaks. However, short curves may be desirable at each end, especially if pavement markings are used through the intersection to provide positive guidance to the motorist.

2.8.1.3 Roadway Transitions

Transition details have been developed and included in the **Design Standards**. Transitions on curved alignment will require special design details in the contract plans.

2.8.2 Vertical Curves

Minimum lengths for crest and sag vertical curves are provided in **Tables 2.8.5 – 2.8.6**. K values for crest vertical curves are based on an eye height of 3.5' and an object height of 6".

**Table 2.8.5 Minimum Lengths of Crest Vertical Curves
 Based on Stopping Sight Distance**

K VALUES FOR CREST CURVES		
Design Speed (mph)	Interstate	All Other Facilities
15	----	5
20	----	10
25	----	19
30	----	31
35	----	47
40	----	70
45	----	98
50	----	136
55	245	185
60	313	245
65	401	313
70	506	401
Length, L = KA Where: L = Minimum Length (feet) K = Constant A = Algebraic Difference In Grades (percent)		
K values for crest vertical curves are based on an eye height of 3.5' and an object height of 6".		
Interstates:	Lengths of crest vertical curves on Interstate mainlines are not to be less than 1000 ft. for open highways and 1800 ft. within interchanges.	
Service Interchanges:	K values for ramp crest vertical curves at interstate terminals are not to be less than the Interstate K values. K values for other ramp crest vertical curves are not to be less than the K values for All Other Facilities.	
System Interchanges:	K values for all crest vertical curves on systems interchanges are not to be less than the K values of the higher system.	
Arterials and Collectors:	The minimum lengths of crest vertical curves for highways with design speeds of 50 mph or greater are as follows:	
Design Speed (mph)	50	55
Minimum Length (ft.)	300	350
	400	450
	500	500
All Facilities:	The lengths of crest vertical curves are not to be less than 3 times the design speed (mph) expressed in feet.	

**Table 2.8.6 Minimum Lengths of Sag Vertical Curves
 Based on Stopping Sight Distance and Headlight Sight Distance**

K VALUES FOR SAG CURVES		
Design Speed (mph)	Interstate	All Other Facilities
15	----	10
20	----	17
25	----	26
30	----	37
35	----	49
40	----	64
45	----	79
50	----	96
55	136	115
60	157	136
65	181	157
70	206	181
Length, L = KA Where: L = Minimum Length (feet) K = Constant A = Algebraic Difference In Grades (percent)		
Interstates:	Lengths of sag vertical curves on Interstate mainlines are not to be less than 800 ft.	
Service Interchanges:	K values for ramp sag vertical curves at interstate terminals are not to be less than the interstate K values. K values for other ramp sag vertical curves are not to be less than the K values for All Other Facilities.	
System Interchanges:	K values for all sag vertical curves on systems interchanges are not to be less than the K values of the higher system.	
Arterials and Collectors:	The minimum lengths of sag vertical curves for highways with design speeds of 50 mph or greater are as follows:	
	Design Speed (mph)	50 55 60 65 70
	Minimum Length (ft.)	200 250 300 350 400
All Facilities:	The lengths of sag vertical curves are not to be less than 3 times the design speed (mph) expressed in feet.	

2.9 Superelevation

Superelevation rates of 0.10 maximum (rural) and 0.05 maximum (urban) are used by the Department on the State Highway System. Charts for these rates are in the criteria tables and figures. Additional data is contained in the ***Design Standards, Indexes 510 and 511.***

The standard superelevation transition places 80% of the transition on the tangent and 20% on the curve. In special situations this treatment can be adjusted to allow up to 50% of the transition to be placed on the curve.

Table 2.9.1 Superelevation Rates for Rural Highways, Urban Freeways and High Speed Urban Highways ($e_{max} = 0.10$)

TABULATED VALUES										
Degree of Curve <i>D</i>	Radius <i>R</i> (ft.)	DESIGN SPEED (mph)								
		30	35	40	45	50	55	60	65	70
0° 15'	22,918	NC	NC	NC	NC	NC	NC	NC	NC	NC
0° 30'	11,459	NC	NC	NC	NC	NC	NC	RC	RC	RC
0° 45'	7,639	NC	NC	NC	NC	RC	RC	0.023	0.025	0.028
1° 00'	5,730	NC	NC	NC	RC	0.021	0.025	0.030	0.033	0.037
1° 15'	4,584	NC	NC	RC	0.022	0.026	0.031	0.036	0.041	0.046
1° 30'	3,820	NC	RC	0.021	0.026	0.031	0.037	0.043	0.048	0.054
	* <i>R</i> _{NC}									
2° 00'	2,865	RC	0.022	0.028	0.034	0.040	0.048	0.055	0.062	0.070
	* <i>R</i> _{RC}									
2° 30'	2,292	0.021	0.028	0.034	0.041	0.049	0.058	0.067	0.075	0.085
3° 00'	1,910	0.025	0.032	0.040	0.049	0.057	0.067	0.077	0.087	0.096
3° 30'	1,637	0.029	0.037	0.046	0.055	0.065	0.075	0.086	0.095	0.100
4° 00'	1,432	0.033	0.042	0.051	0.061	0.072	0.083	0.093	0.099	Dmax = 3° 30'
5° 00'	1,146	0.040	0.050	0.061	0.072	0.083	0.094	0.098	Dmax = 4° 15'	
6° 00'	955	0.046	0.058	0.070	0.082	0.092	0.099	Dmax = 5° 15'		
7° 00'	819	0.053	0.065	0.078	0.089	0.098	Dmax = 6° 30'			
8° 00'	716	0.058	0.071	0.084	0.095	0.100				
9° 00'	637	0.063	0.077	0.089	0.098	Dmax = 8° 15'				
10° 00'	573	0.068	0.082	0.094	0.100					
11° 00'	521	0.072	0.086	0.097	Dmax = 10° 15'					
12° 00'	477	0.076	0.090	0.099						
13° 00'	441	0.080	0.093	0.100						
14° 00'	409	0.083	0.096	Dmax = 13° 15'						
15° 00'	382	0.086	0.098							
16° 00'	358	0.089	0.099							
18° 00'	318	0.093	Dmax = 17° 45'							
20° 00'	286	0.097								
22° 00'	260	0.099								
24° 00'	239	0.100								
		Dmax = 24° 45'								
* NC/RC and RC/e Break Points (Radius in feet)										
Break Points	DESIGN SPEED (mph)									
	30	35	40	45	50	55	60	65	70	
<i>R</i> _{NC}	3349	4384	5560	6878	8337	9949	11709	13164	14714	
<i>R</i> _{RC}	2471	3238	4110	5087	6171	7372	8686	9783	10955	
$e = NC$ if $R \geq R_{NC}$ $e = RC$ if $R < R_{NC}$ and $R \geq R_{RC}$										

NC = Normal Crown (-0.02) RC = Reverse Crown (+0.02)
*R*_{NC} = Minimum Radius for NC *R*_{RC} = Minimum Radius for RC

Rates for intermediate *D*'s and *R*'s are to be interpolated

Figure 2.9.1 Superelevation Rate For Rural Highways, Urban Freeways and High Speed Urban Highways ($e_{max} = 0.10$)

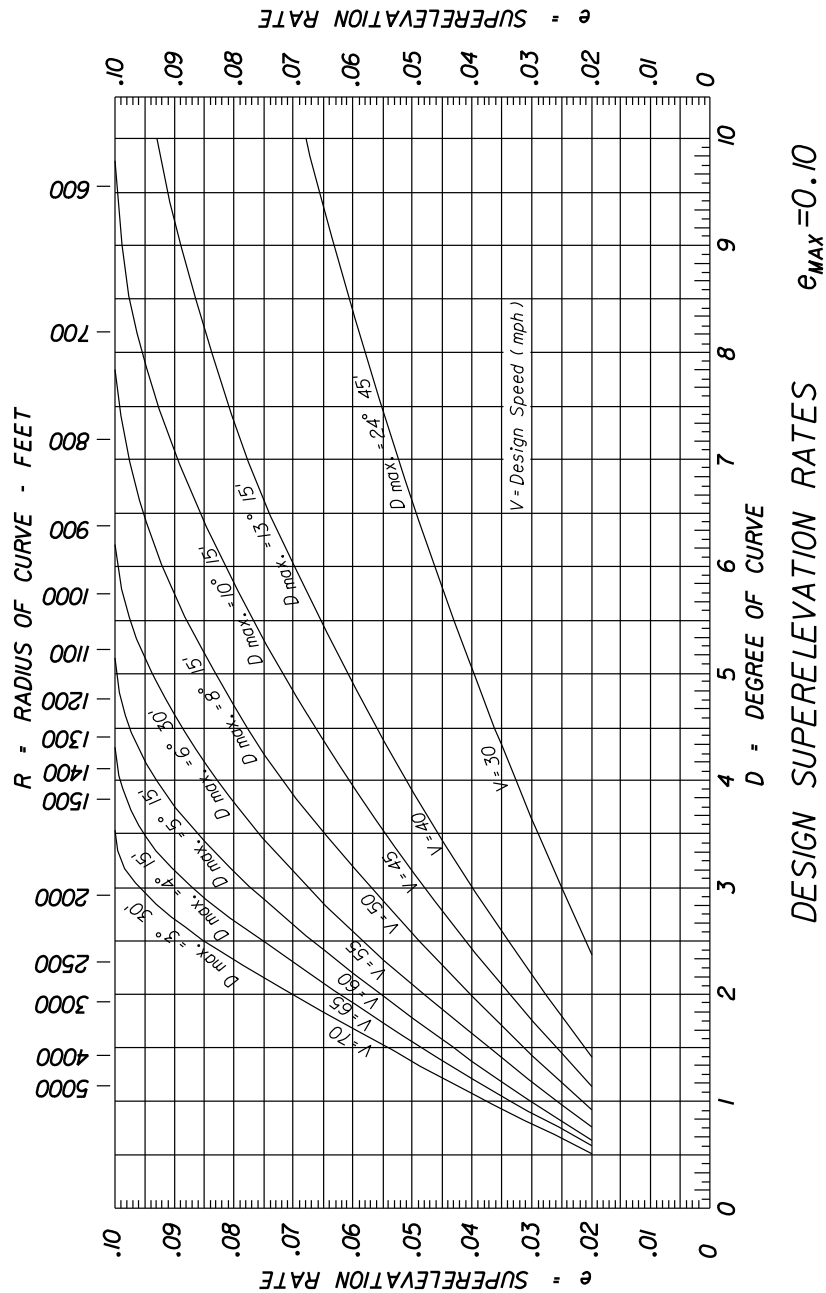

**Table 2.9.2 Superelevation Rates for Urban Highways
 and High Speed Urban Streets ($e_{max} = 0.05$)**

TABULATED VALUES						
Degree of Curve <i>D</i>	Radius <i>R</i> (ft.)	DESIGN SPEED (mph)				
		30	35	40	45	50
2° 00'	2,865	NC	NC	NC	NC	NC
2° 15'	2,546					RC
2° 45'	2,083				NC	
3° 00'	1,910				RC	
3° 45'	1,528			NC		
4° 00'	1,432			RC		
4° 45'	1,206					RC
5° 00'	1,146		NC			0.023
5° 15'	1,091		RC			0.027
5° 30'	1,042					0.030
5° 45'	996					0.035
6° 00'	955				RC	0.040
6° 15'	917				0.022	0.045
6° 30'	881				0.024	0.050
6° 45'	849				0.027	
7° 00'	819	NC			0.030	Dmax = 6° 30'
7° 15'	790	RC			0.033	
7° 30'	764				0.037	
7° 45'	739				0.041	
8° 00'	716			RC	0.045	
8° 15'	694			0.022	0.050	
8° 30'	674			0.025		
8° 45'	655			0.027	Dmax = 8° 15'	
9° 00'	637			0.030		
9° 30'	603			0.034		
10° 00'	573			0.040		
10° 30'	546		RC	0.047		
11° 00'	521		0.023		Dmax = 10° 45'	
11° 30'	498		0.026			
12° 00'	477		0.030			
13° 00'	441		0.036			
14° 00'	409	RC	0.045			
15° 00'	382	0.023				
16° 00'	358	0.027	Dmax = 14° 15'			
17° 00'	337	0.032				
18° 00'	318	0.038				
19° 00'	302	0.043				
20° 00'	286	0.050				
		Dmax = 20° 00'				

NC = Normal Crown (-0.02)

RC = Reverse Crown (+0.02)

Figure 2.9.2 Superelevation Rates for Urban Highways and High Speed Urban Streets ($e_{max} = 0.05$)

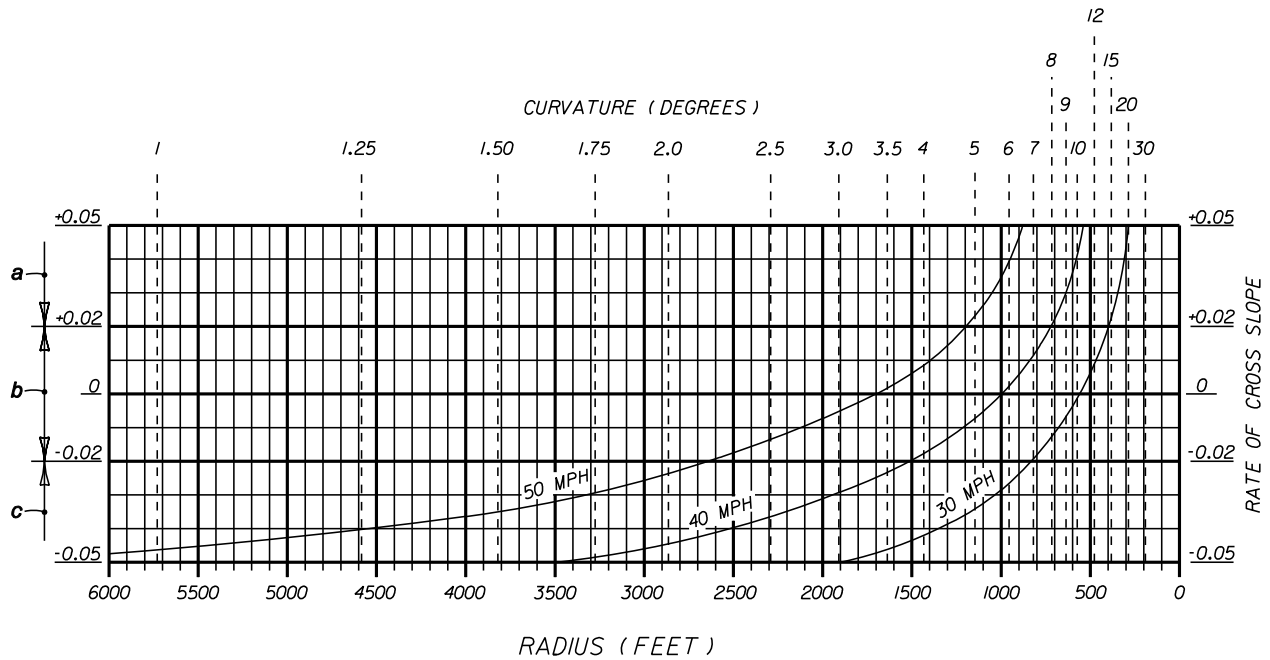

- a. When the speed curves and the degree of curve lines intersect above this line, the pavement is to be superelevated (positive slope) at the rates indicated at the lines intersecting points.
- b. When the speed curves and the degree of curve lines intersect between these limits, the pavement is to be superelevated at the rate of 0.02 (positive slope).
- c. When the speed curves and the degree of curve lines intersect below this line, the pavement is to have normal crown (typically 0.02 and 0.03 downward slopes).

Table 2.9.3 Superelevation Transition Slope Rates for Rural Highways, Urban Freeways and High Speed Urban Highways

SLOPE RATES FOR STRAIGHT LINE SUPERELEVATION TRANSITIONS				
SECTION	Design Speed (mph)			
	35-40	45-50	55-60	65-70
	SLOPE RATES			
2 Lane & 4 Lane	1:175	1:200	1:225	1:250
6 Lane	---	1:160	1:180	1:200
8 Lane	---	1:150	1:170	1:190
<p>The length of superelevation transition is to be determined by the relative slope rate between the travel way edge of pavement and the profile grade, except that the minimum length of transition shall be 100 feet.</p> <p>For additional information on transitions, see the <i>Design Standards, Index 510</i>.</p>				

Table 2.9.4 Superelevation Transition Slope Rates for Urban Highways and High Speed Urban Streets

SLOPE RATES FOR STRAIGHT LINE SUPERELEVATION TRANSITIONS	
30 mph	1:100
40 mph	1:125
45-50 mph ₁	1:150
<p>1. A slope rate of 1:125 may be used for 45 mph under restricted conditions.</p> <p>The length of superelevation transition is to be determined by the relative slope rate between the travel way edge of pavement and the profile grade, except that the minimum length of transition shall be 50 ft. for design speeds under 40 mph and 75 ft. for design speeds of 40 mph or greater. For additional information on transitions, see the <i>Design Standards, Index 511</i>.</p>	

2.10 Vertical Clearance

Minimum vertical clearances, with the exception of structures over water (see **Section 2.10.1**), are contained in the criteria tables and figures.

Figure 2.10.1 Clearances – Rural and Urban Interstates (Freeways), Arterials and Collectors, with Projected 20-Year ADT of 1500 or Greater

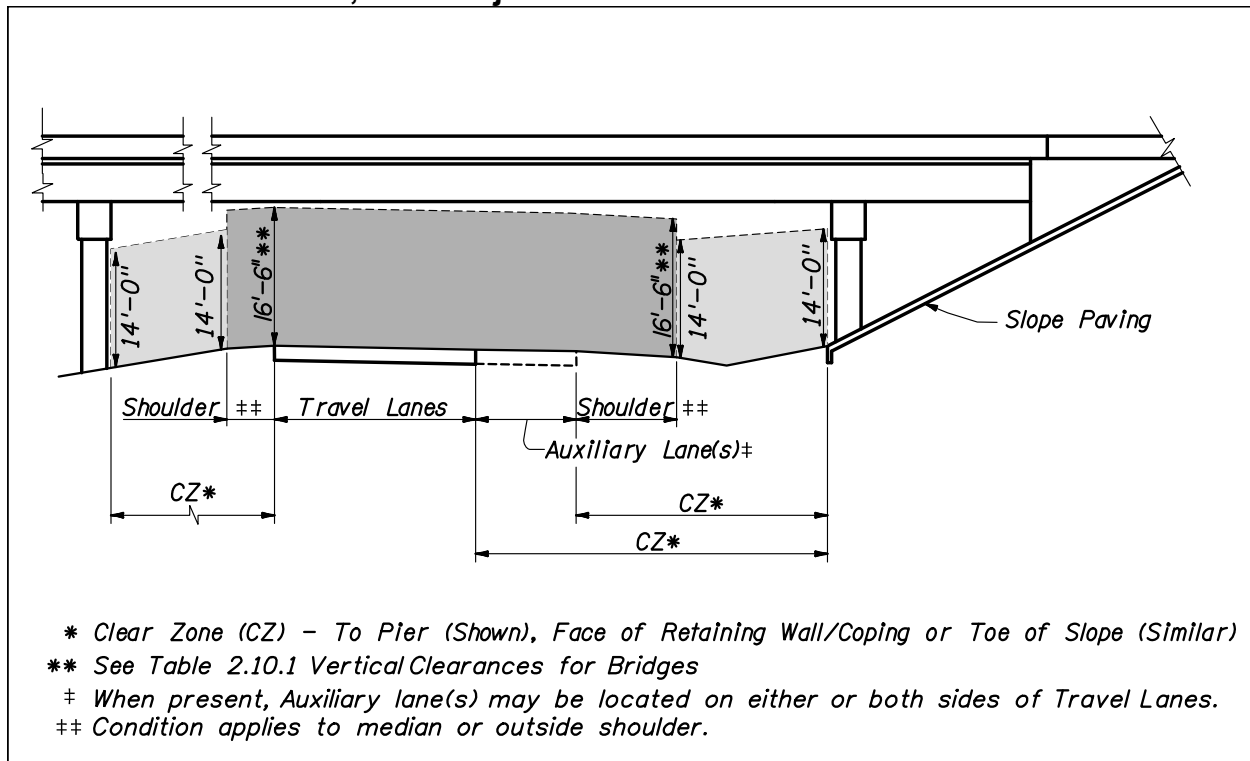
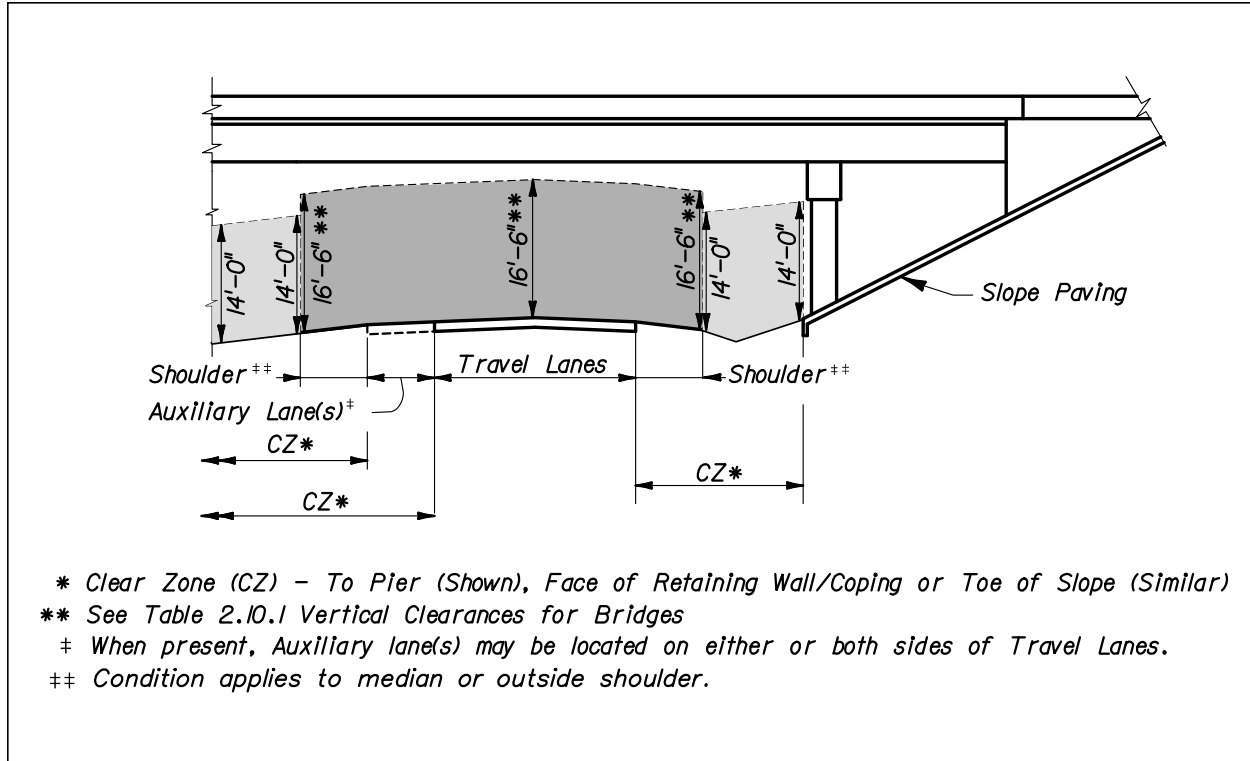
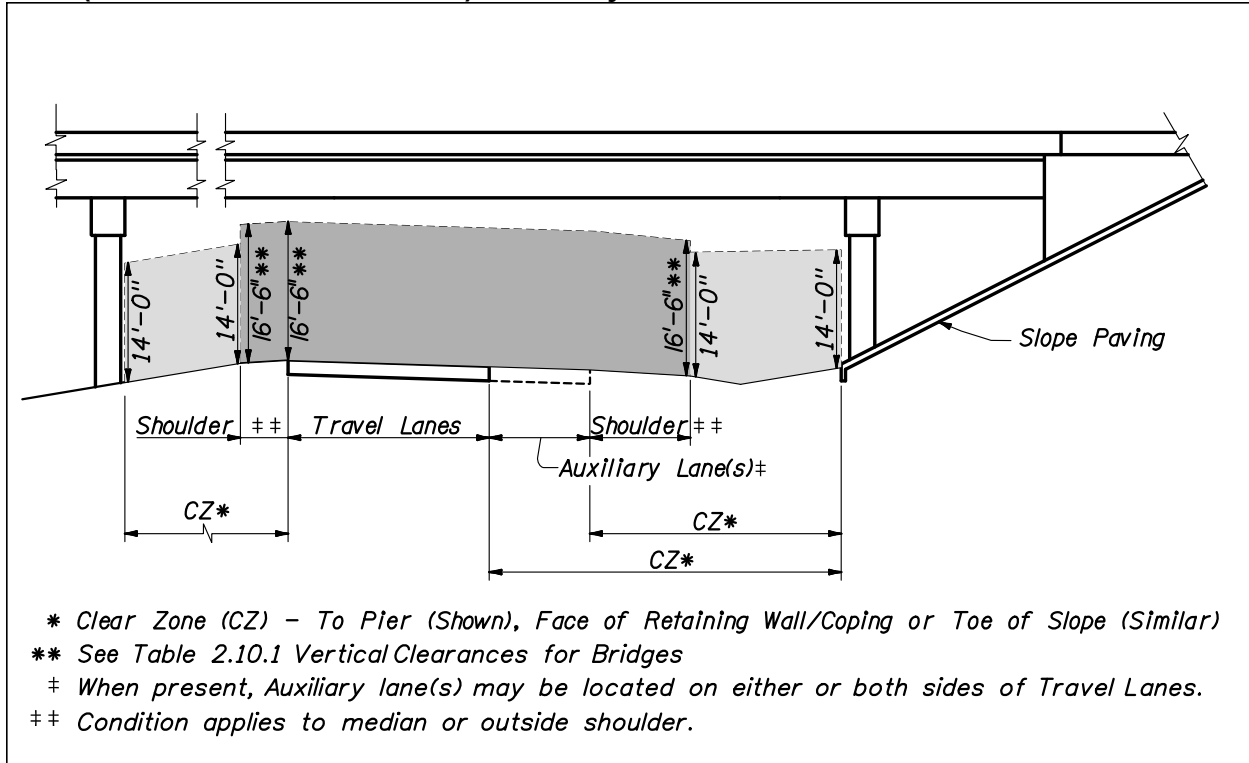

Figure 2.10.2 Clearances – Rural Arterials and Collectors with Projected 20-Year ADT of Less than 1500



**Figure 2.10.3 Clearances – Urban Arterials and Collectors
 (Without Curb and Gutter) with Projected 20-Year ADT of Less than 1500**



**Figure 2.10.4.A Clearances – Urban Arterials and Collectors
(Curb and Gutter) ≤ 45 mph – Elevation of Bridge**

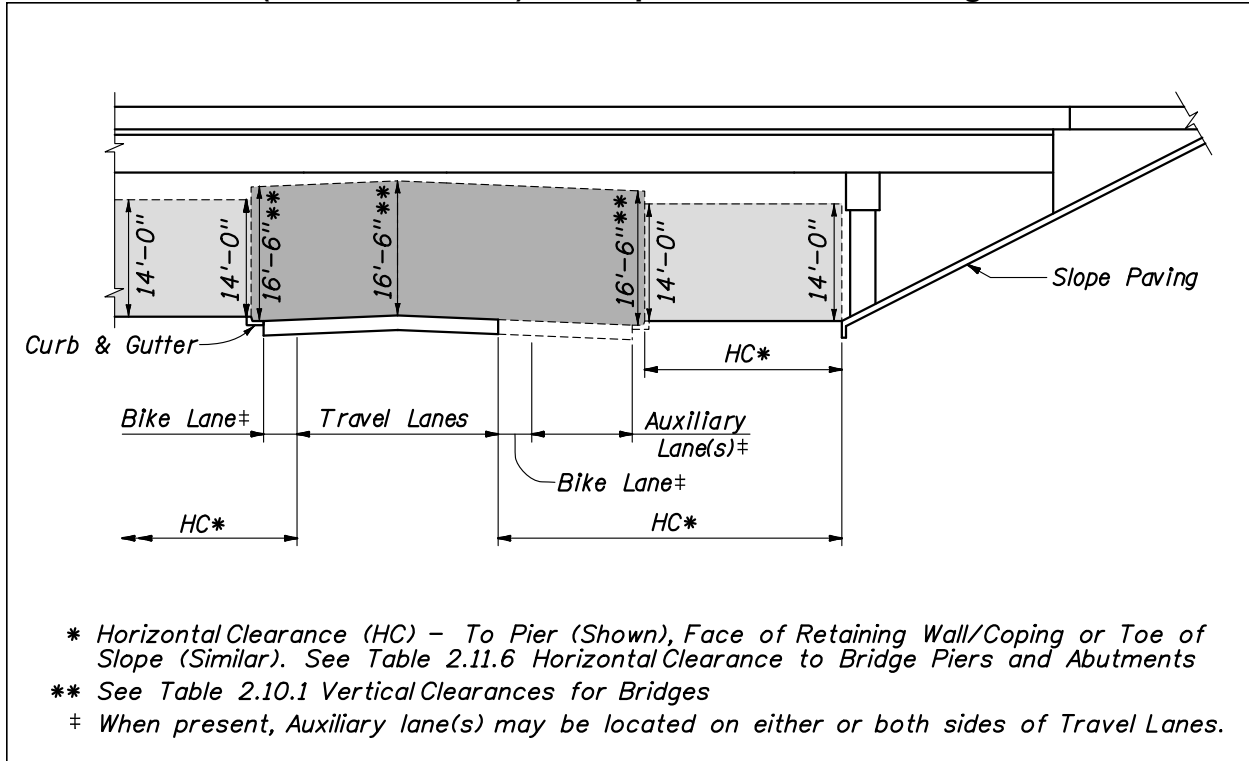

Figure 2.10.4.B Clearances – Urban Arterials and Collectors (Curb and Gutter) ≤ 45 mph – Section through Bridge

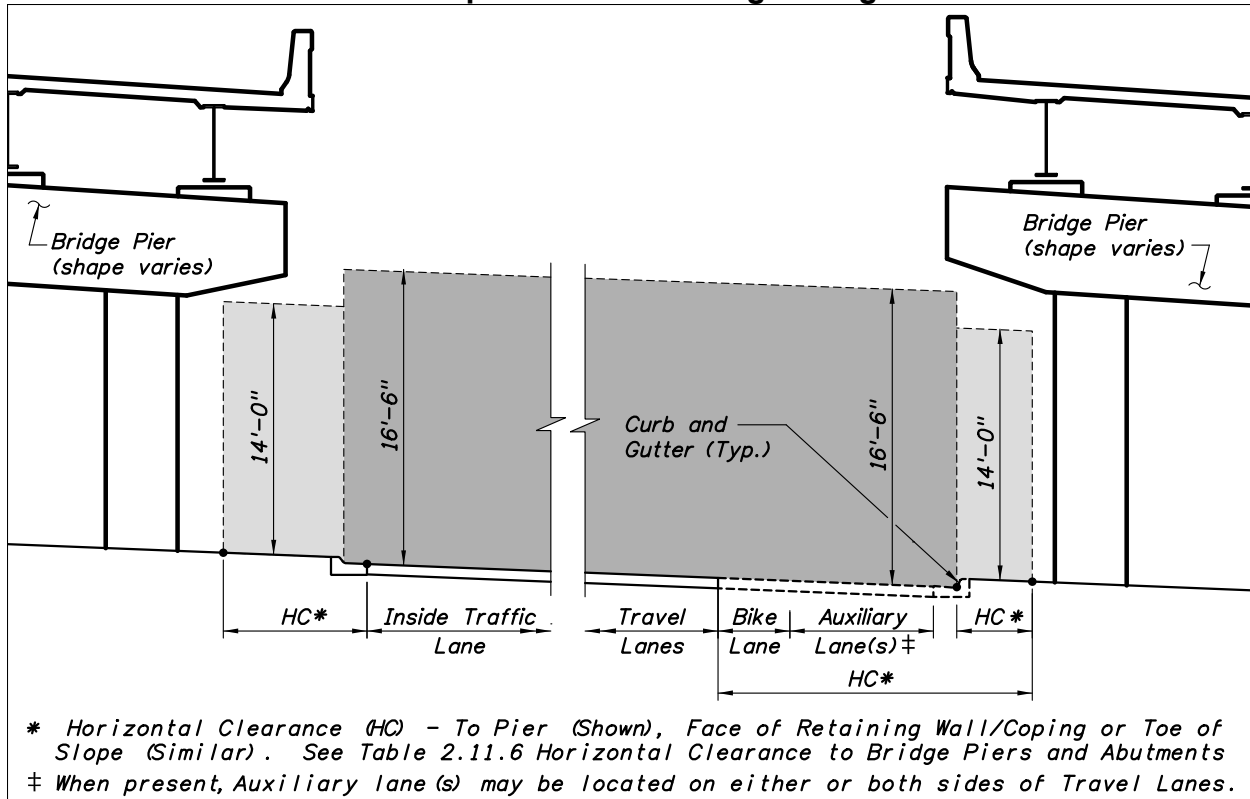

Figure 2.10.5 Clearances – Urban Arterials and Collectors (Curb and Gutter) with Traffic Barrier

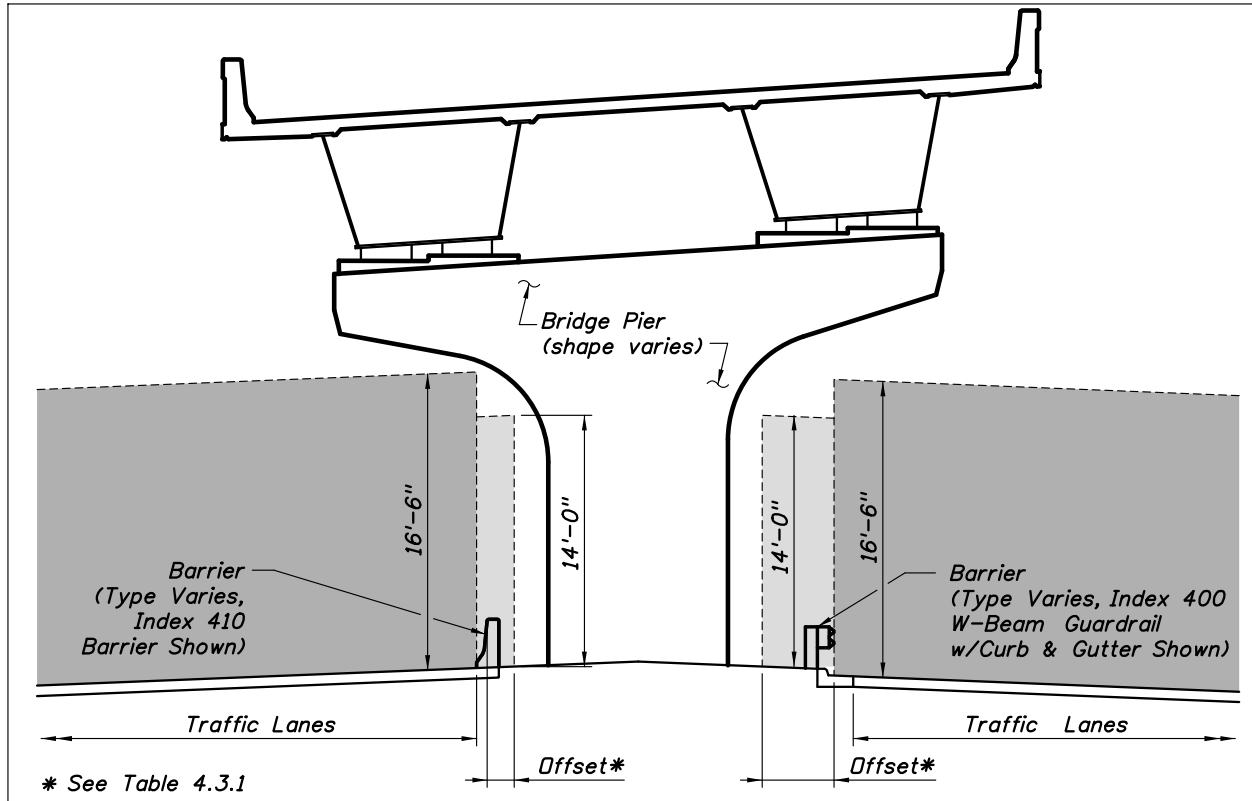

Table 2.10.1 Vertical Clearances for Bridges

FACILITY TYPE	CLEARANCE ^{1, 4, 6} (FEET)			
	Roadway or Railroad Over Roadway ₂	Roadway Over Railroad _{3, 4, 5}	Pedestrian Over Roadway ₂	Pedestrian Over Railroad ₃
Freeways, Arterials Collectors & Others	16'-6"	23'-6"	17'-6"	23'-6"
<p>1. Clearance Measurement: The least vertical distance between the bridge structure and the surface of the roadway (traffic lanes and shoulders) or the top of the highest rail.</p> <p>2. Includes Future Underpass Resurfacing: 6" over pavements.</p> <p>3. Includes Rail Resurfacing (Track Raised): 12" for conventional railroads. Others-see footnotes No. 4 and 5, and Section 6.3.5 of this volume.</p> <p>4. Over High Speed Rail Systems: See Department guidelines and specifications for Intermediate Class Rail Operations entitled Standard Specifications for the Design and Construction of Railways.</p> <p>5. Over Electrified Railroad: The minimum vertical clearance shall be 24 feet 3 inches. This provision is based on FDOT Policy for 25 KV service: South Florida Rail Corridor Clearance (Topic No. 000-725-003).</p> <p>6. Clearance Over Waterways: See Department Drainage Manual, Topic No. 625-040-002, Chapter 4 and Section 2.10.1 of this volume.</p>				

Table 2.10.2 Minimum Vertical Clearances for Signs

SIGNS	CLEARANCE ^{1,2}
Overhead Sign Structures	17'-6" over the entire width of the pavement and shoulder to the lowest sign component.

1. Includes 6" for future resurfacing on rural sections.
2. For cantilever structures, the vertical clearance only applies to the portion of the roadway directly beneath the structure.

Table 2.10.3 Minimum Vertical Clearances for Signals

SIGNALS	CLEARANCE ^{1,2}
Span Wire Mounted	17'-6" between the pavement and the bottom of any signal assembly.
Mast Arm Mounted	17'-6" over the entire width of the pavement and shoulder to the lowest signal or low point of the arm.
Truss Mounted	17'-6" over the entire width of the pavement and shoulders to the lowest signal or lowest member of the horizontal truss.

1. Includes 6" for future resurfacing on rural sections.
2. For cantilever structures, the vertical clearance only applies to the portion of the roadway directly beneath the structure.

Table 2.10.4 Minimum Vertical Clearances for Overhead Dynamic Message Signs (DMS)

SIGNS	CLEARANCE ^{1,2}
Overhead DMS Structures	19'-6" over the entire width of the pavement and shoulder to the lowest sign component.

1. Includes 6" for future resurfacing on rural sections.
2. For cantilever structures, the vertical clearance only applies to the portion of the roadway directly beneath the structure.

2.10.1 Vertical Clearance Over Water

Unless otherwise specifically approved by the District Structures Design Engineer for Category 1 Structures or the State Structures Design Engineer for Category 2 Structures, the minimum vertical clearance over water shall conform to the following criteria:

1. **Environment:**

For concrete superstructures classified as moderately aggressive or extremely aggressive due to chloride content, the minimum vertical clearance is 12 ft. above Mean High Water (MHW).

For steel superstructures, the minimum vertical clearance shall be obtained from the District Maintenance Engineer, but shall not be less than those specified above for the concrete superstructures.

2. **Drainage:**

The minimum vertical clearance requirement shall also conform to the ***FDOT Drainage Manual, Chapter 4 (Topic No. 625-040-002)***.

3. **Navigation:**

The minimum vertical clearance for navigational purposes shall be determined in accordance with the ***FDOT Drainage Manual, Chapter 4***, unless the agency having jurisdiction over the waterway has a more stringent requirement.

Information on the Normal High Water, control water elevation, or Mean High Water can be obtained from the appropriate Drainage Design Engineer.

Widening of existing structures which do not meet the minimum vertical clearance criteria stated above (either before or after the widening) may be justified hydraulically and/or economically. However, the encroachment of vertical clearance criteria may be limited and must be approved by the agency having jurisdiction over the navigable waterway.

2.10.2 **Airspace Obstructions**

Federal, state, and local regulations exist to protect the national airspace system that must be considered when planning and implementing construction that may adversely impact military or public-use aviation facilities (airport, seaport, or heliport), navigational aids, and instrument approach flight procedures in Florida.

FAA Notification:

Federal law, ***Title 14 Code of Federal Regulations (CFR), Federal Aviation Regulations (FAR), Part 77, “Objects Affecting Navigable Airspace”***, requires that prior notification must be given to the Federal Aviation Administration (FAA) regarding any construction or alteration (permanent or temporary) of structures that meet the specific criteria given in ***Table 2.10.5***.

For further guidance on airspace obstructions (notification and permitting) refer to ***Section 13.5.1, FDOT Aviation Office Coordination***, this volume.

Table 2.10.5 FAA Notification Requirements

FAA Notification Requirements for Construction or Alteration of Structures *	
1.	Any structure more than 200 feet above ground level (AGL) at its site.
2.	Any structure that is near an aviation facility and that penetrates an imaginary obstacle surface extending outward and upward at one of the following criteria: <ul style="list-style-type: none"> a. A slope of 100 to 1 (1 foot upward for each 100 feet outward) for a horizontal distance of 20,000 feet from the nearest point of the nearest military or public-use airport runway that is more than 3,200 feet in length (excludes heliports). b. A slope of 50 to 1 (1 foot upward for each 50 feet outward) for a horizontal distance of 10,000 feet from the nearest point of the nearest military or public-use airport runway no more than 3,200 feet in length (excludes heliports). c. A slope of 25 to 1 (1 foot upward for each 25 feet outward) for a horizontal distance of 10,000 feet from the nearest point of the nearest military or public-use heliport landing and takeoff area.
3.	Any highway, railroad, or other traverse way for mobile objects, of a height which, if adjusted upward by the amount shown below, would exceed a standard of paragraph 1 or 2 above: <ul style="list-style-type: none"> a. An adjusted height of 17 feet for an Interstate Highway that is part of the National System of Military and Interstate Highways where over-crossings are designed for a minimum of 17 feet vertical distance. b. An adjusted height of 15 feet for any other public roadway. c. An adjusted height of 10 feet or the height of the highest mobile object that would normally traverse the road, whichever is greater, for a private road. d. An adjusted height of 23 feet for a railroad. e. An adjusted height equal to the height of the highest mobile object that would normally traverse it, for a waterway or traverse way not previously mentioned.
4.	Any structure located directly on a public-use aviation facility property, including any facility that is currently existing, planned, proposed, or under construction.
5.	Any structure that is located in an instrument approach area and available information indicates it might exceed federal obstruction standards, if specifically requested by the FAA.
<p>* Note: Structures may include: Highways, roads, railroads, waterways, traverseways (parking or rest areas), bridges, overpasses, high-mast light poles, utility poles, antenna towers, buildings, signs or billboards, fences, or gates, plus temporary-use construction materials or equipment, including dirt piles and cranes, as well as natural growth, vegetation, and landscaping, depending on location in proximity to an aviation facility, navigational aid, or instrument procedure ground track.</p>	

2.11 Horizontal Clearance

Horizontal clearance is the lateral distance from a specified point on the roadway such as the edge of travel lane or face of curb, to a roadside feature or object. Horizontal clearance applies to all highways. Horizontal clearance requirements vary depending on design speed, whether rural or urban with curb, traffic volumes, lane type, and the object or feature.

Rural highways with flush shoulders and highways with curb or curb and gutter where right of way is not restricted have roadsides of sufficient widths to provide clear zones; therefore, horizontal clearance requirements for certain features and objects are based on maintaining a clear zone wide enough to provide the recoverable terrain in **Table 2.11.11**. The procedure for determining required clear zone widths is described in **Chapter 4** of this volume.

In urban areas, horizontal clearance based on clear zone requirements for rural highways should be provided wherever practical. However, urban areas are typically characterized with lower speed (Design Speed \leq 45 mph), more dense abutting development, closer spaced intersections and accesses to property, higher traffic volumes, more bicyclists and pedestrians, and restricted right of way. In these areas, curb with closed drainage systems are often used to minimize the amount of right of way needed. Highways with curb or curb and gutter in urban areas where right of way is restricted do not have roadsides of sufficient widths to provide clear zones; therefore, while there are specific horizontal clearance requirements for these highways, they are based on clearances for normal operation and not based on maintaining a clear roadside for errant vehicles. It should be noted that curb has no redirection capabilities except at speeds less than the lowest design speeds used on the State Highway System. Therefore curb should not be considered effective in shielding a hazard. Curb is not to be used to reduce horizontal clearance requirements.

Crashworthy objects shall meet or exceed the offset listed in **Tables 2.11.1** through **2.11.10** and objects that are not crashworthy are to be as close to the right of way line as practical and no closer than the requirements listed in **Tables 2.11.1** through **2.11.10**.

For horizontal clearances where roadways overpass railroads refer to **Chapter 6** of this volume.

Table 2.11.1 Horizontal Clearance for Traffic Control Signs

PLACEMENT	Placement shall be in accordance with the <i>Design Standards</i> . Placement within sidewalks shall be such that an unobstructed sidewalk width of 4 feet or more (not including the width of curb) is provided.
SUPPORTS	Supports, except overhead sign supports, shall be breakaway. When practicable, sign supports should be located behind barriers that are justified for other reasons. Overhead sign supports shall be located outside the clear zone unless shielded.

Table 2.11.2 Horizontal Clearance for Light Poles

CONVENTIONAL LIGHTING	<p>Shall not be located in the median except in conjunction with barriers that are justified for other reasons.</p> <p>Supports shall be breakaway, except for median barrier mounted or shielded light poles.</p> <p>Urban Curb or Curb and Gutter (Design Speed ≤ 45 mph): Shall be located no closer than 4 feet from face of curb (may be 2.5 feet from face of curb when all other alternatives are deemed impractical). Placement within sidewalks shall be such that an unobstructed sidewalk width of 4 feet or more (not including the width of curb) is provided.</p> <p>All other facilities: Shall be located no closer than 20 feet from the travel lane or 14 feet from an auxiliary lane (may be clear zone width when clear zone is less than 20 feet).</p>
HIGHMAST LIGHTING	Shall be located outside the clear zone unless shielded.

Table 2.11.3 Horizontal Clearance for Utility Installations

ABOVE GROUND OBJECTS	<p>See the <i>Utility Accommodation Manual (UAM)</i>, (Topic No. 710-020-001) for horizontal clearance criteria for utilities.</p> <p>The <i>UAM</i> is available online at: http://www.dot.state.fl.us/rddesign/utilities/</p>
-----------------------------	---

Table 2.11.4 Horizontal Clearance to Signal Poles and Controller Cabinets for Signals

Shall not be located in medians

Shall be located outside the clear zone except as follows:

Urban Curb or Curb and Gutter (Design Speed \leq 45 mph):

Shall be located no closer than 4 feet from face of outside curbs and outside the sidewalk. However, when necessary, signal poles may be located within sidewalks such that an unobstructed sidewalk width of 4 feet or more (not including the width of curb) is provided.

Table 2.11.5 Horizontal Clearance to Trees

Trees, where the diameter is or is expected to be greater than 4 inches (measured 6 inches above the ground), shall be located outside the clear zone except as follows:

Urban Curb or Curb and Gutter where Design Speed \leq 45 mph and where right of way is restricted, shall be located no closer than:

- 4 feet from face of outside curbs,
- 6 feet from edge of inside traffic lane.

Table 2.11.6 Horizontal Clearance to Bridge Piers and Abutments

Bridge Piers and Abutments shall be located outside the clear zone (see also **Figures 2.10.1** thru **2.10.3**) except as follows:

Urban Curb or Curb and Gutter (Design Speed \leq 45 mph), shall be located no closer than:

- 16 feet from the edge of the travel lane; or
- 4 feet from face of outside curbs or
- 6 feet from the edge of inside traffic lane:

whichever provides the greater setback. See also **Figures 2.10.4.A** thru **2.10.4.B**.

Rural and Urban with Roadside Barriers:

The minimum barrier offset as shown in **Table 4.3.1** measured from the face of the barrier. See also **Figure 2.10.5**.

- Notes:
1. Pier protection and design shall comply with the requirements provided in **Structures Design Guidelines, Section 2.6**.
 2. Locate piers outside of clearance envelopes as shown. Additional clearance may be required for sidewalks, shared use paths, intersection sight distance and future widening of the lower roadway.
 3. Evaluate the potential for widening of a lower roadway at a given location based on adjacent geometric constraints, (e.g. other bridge piers, MSE walls, significant water features, etc.).

**Table 2.11.7 Horizontal Clearance to Railroad Grade Crossing
Traffic Control Devices**

Shall be located in accordance with the *Design Standards*.

Table 2.11.8 Horizontal Clearance to Canal and Drop-off Hazards

See *Chapter 4* of this Volume for horizontal clearance criteria for canal and drop-off hazards.

Table 2.11.9 Horizontal Clearance to Other Roadside Obstacles

Shall be located outside the clear zone except as follows:

Urban Curb or Curb and Gutter (Design Speed \leq 45 mph):
Shall be located no closer than 4 feet from face of curb (may be 2.5 feet from face of curb when all other alternatives are deemed impractical).

Note: Horizontal clearance to mailboxes is specified in the construction details contained in the *Design Standards, Index No. 532*.

Note: Transit and school bus shelters shall be placed in accordance with *Rule Chapter 14-20.003, Florida Administrative Code*. Transit bus benches shall be located in accordance with *Rule Chapter 14-20.0032, F.A.C.*

Table 2.11.10 Horizontal Clearance for ITS Poles and Related Items

POLES AND OTHER ABOVE-GROUND FIXED OBJECTS	<p>Shall not be located in the median except in conjunction with barriers that are justified for other reasons.</p> <p>Shall be located outside the clear zone (as close as practical to the right of way line without aerial encroachments onto private property) except as follows:</p> <p>Urban Curb or Curb and Gutter (Design Speed \leq 45 mph): Shall be located as close to the right of way line as practical; no closer than 4 feet from face of curb. Placement within sidewalks shall be such that an unobstructed sidewalk width of 4 feet or more (not including the width of curb) is provided.</p> <p>May be located behind barriers that are justified for other reasons.</p>
EQUIPMENT SHELTERS AND TOWERS	<p>Shall not be located within the limited-access right of way, except as allowed by <i>Policy No. 000-625-025, Telecommunications Facilities on Limited Access Rights of Way.</i></p>
BREAKAWAY OBJECTS	<p>Shall be located as close to the right of way line as practical, except as follows:</p> <p>Urban Curb or Curb and Gutter (Design Speed \leq 45 mph): Shall be located no closer than 4 feet from the face of curb (may be 2.5 feet from face of curb when all other alternatives are deemed impractical).</p>

Table 2.11.11 Recoverable Terrain

DESIGN SPEED (mph)	≥ 1500 AADT ⁽¹⁾		< 1500 AADT ⁽¹⁾	
	TRAVEL LANES & MULTILANE RAMPS (feet)	AUXILIARY LANES & SINGLE LANE RAMPS (feet)	TRAVEL LANES & MULTILANE RAMPS (feet)	AUXILIARY LANES & SINGLE LANE RAMPS (feet)
< 45	18	10	16	10
45	24	14	20	14
50	24	14	20	14
55	30	18	24	14
> 55	36	24	30	18

(1) AADT=Mainline 20 years projected annual average daily traffic.

The above values are to be used in the process for determining the clear zone width as described in **Chapter 4** of this volume.

Figure 2.11.1 Horizontal Clearance to Guardrail

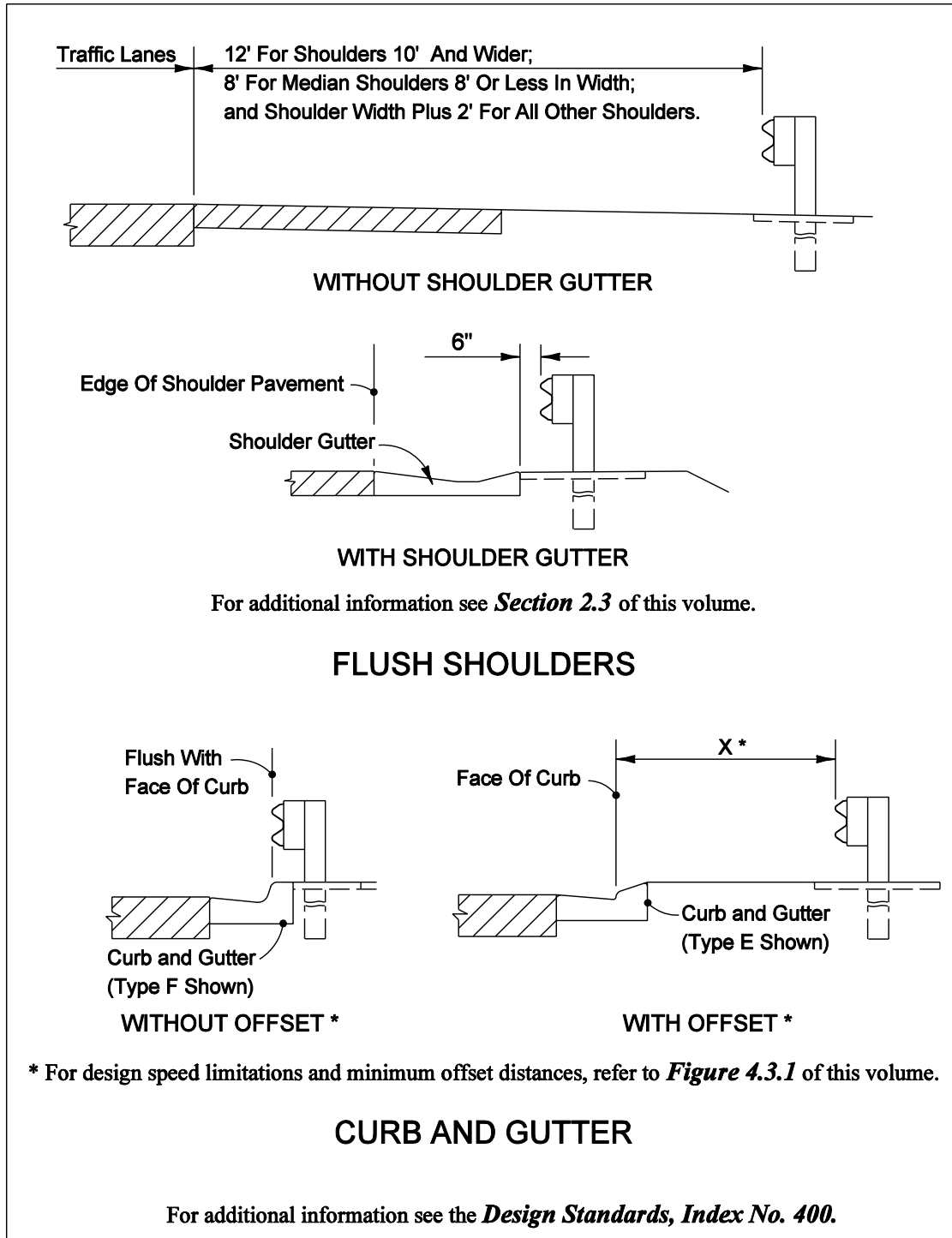

2.12 Bridge Railings and Separators

Bridge railings and separators on new and reconstruction projects shall be designed in accordance with the ***Structures Design Guidelines***. On reconstruction projects, where an existing bridge is to remain, existing bridge railings must be replaced or upgraded unless the railing meets criteria for new traffic railings. All superseded FDOT Standard New Jersey Shape and F Shape Traffic Railings conforming to the designs shown in the ***Structures Manual, Volume 3, “Existing FDOT Traffic Railing Details”***, are both structurally and functionally adequate.

All other former FDOT bridge traffic railings not listed above, and any other traffic railings that are not based on crash tested designs, are inadequate and shall be replaced, retrofitted or excepted, as appropriate, using the criteria included in the ***Structures Design Guidelines***.

Details and typical applications of various bridge rails and separators are given in ***Figures 2.12.1 – 2.12.9***.

Figure 2.12.1 Bridge Traffic Railings – "F" Shapes

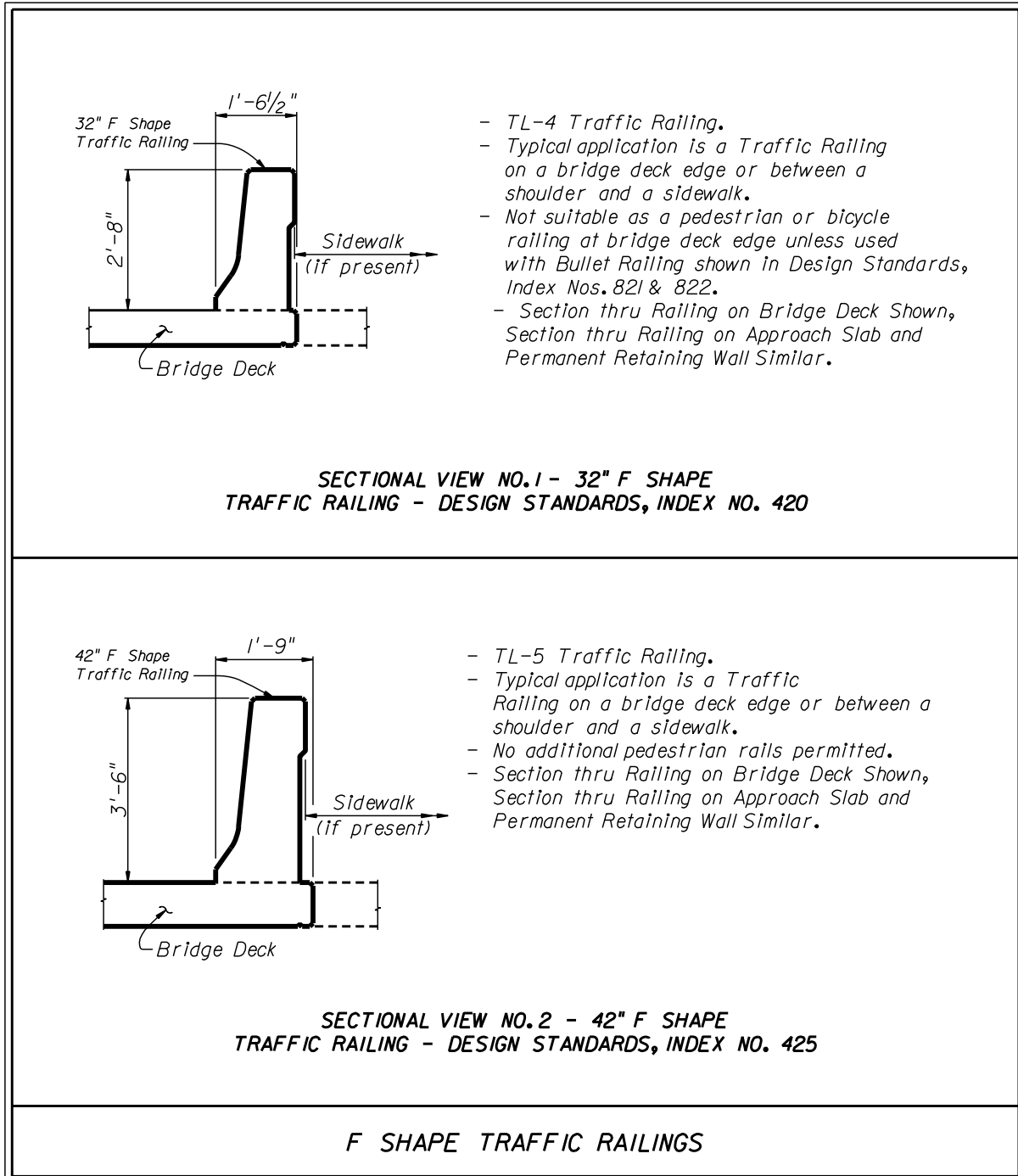

Figure 2.12.2 Bridge Traffic Railings – Vertical Shapes

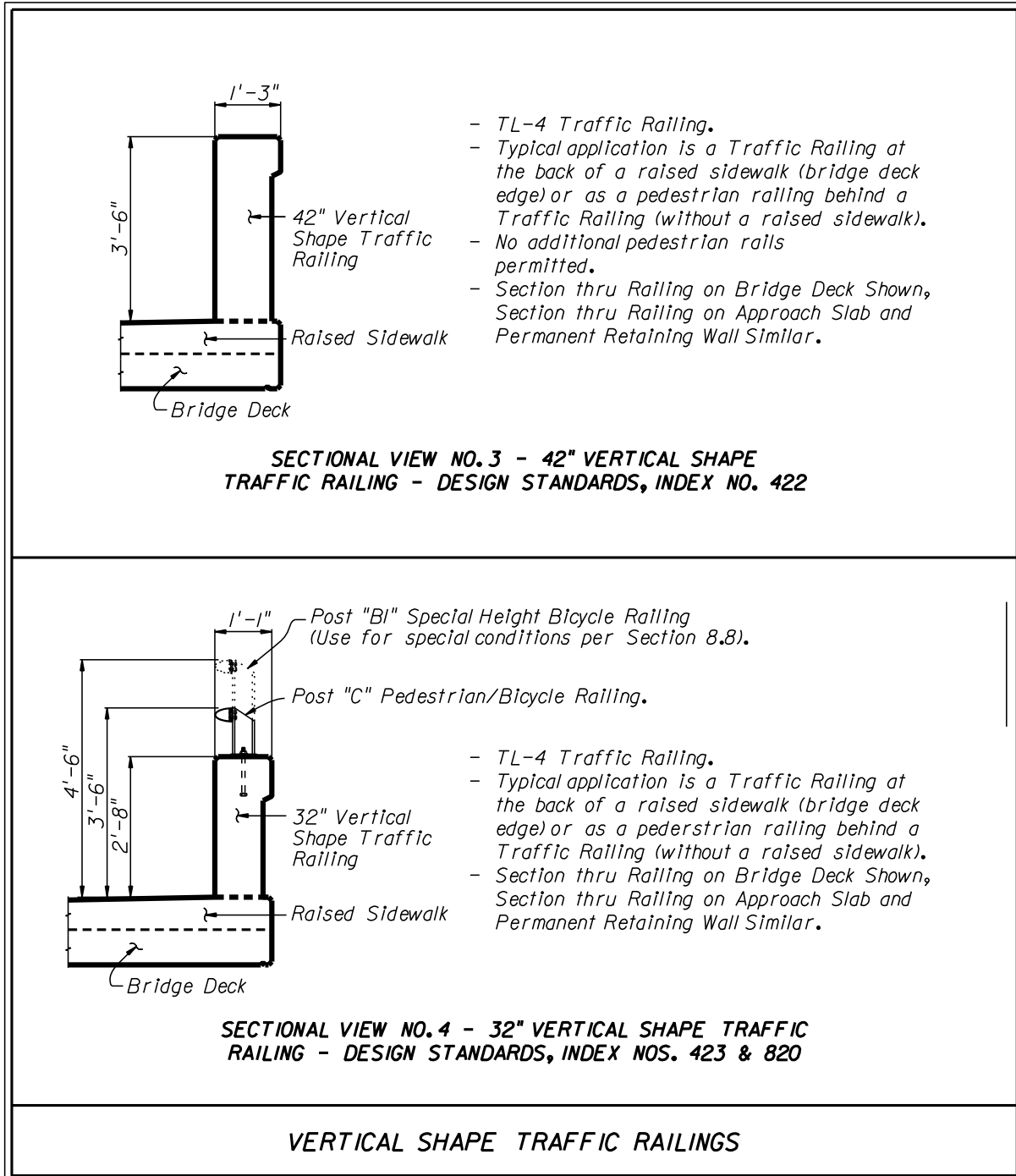

Figure 2.12.3 Bridge Traffic Railings – Other Shapes

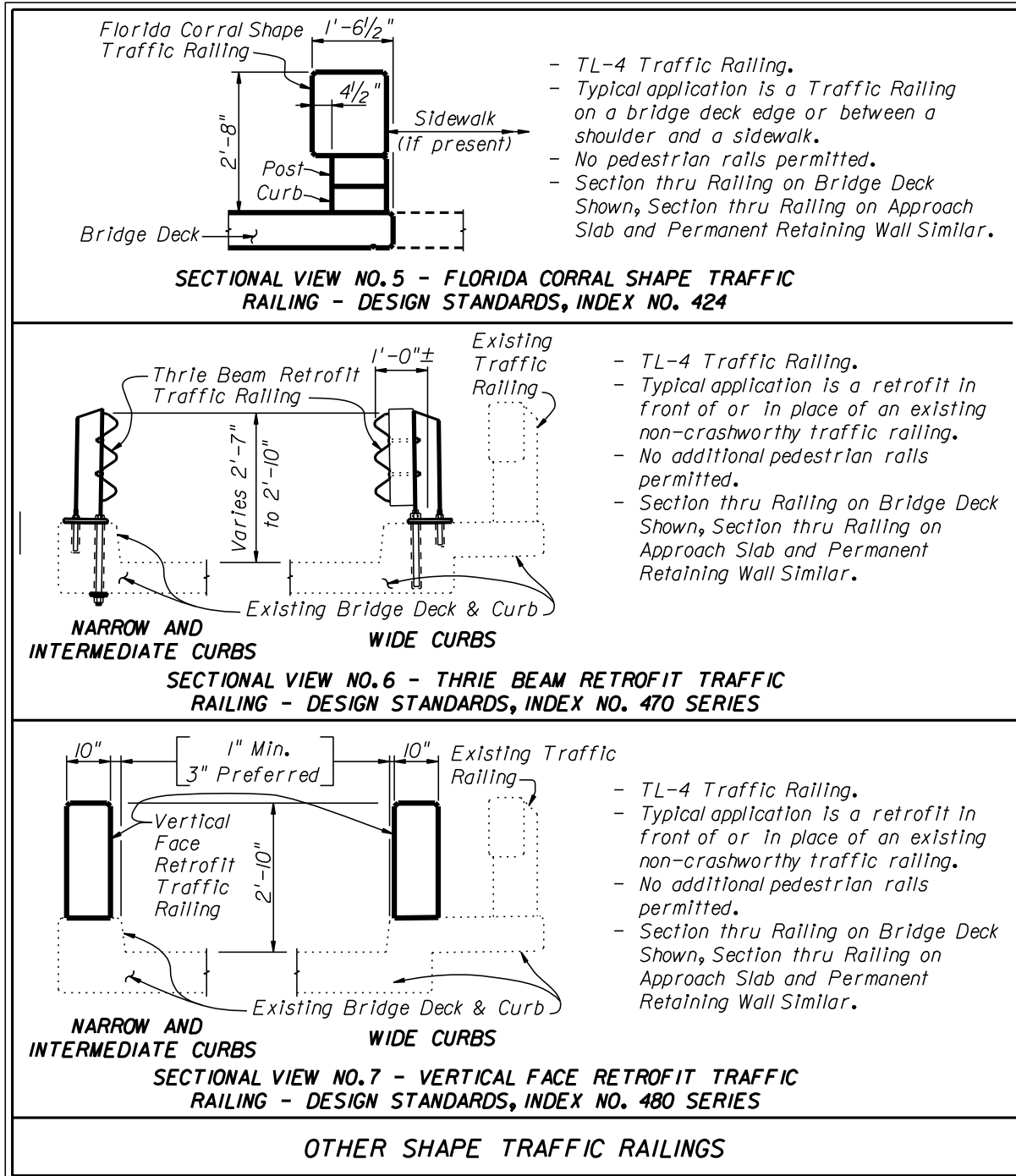
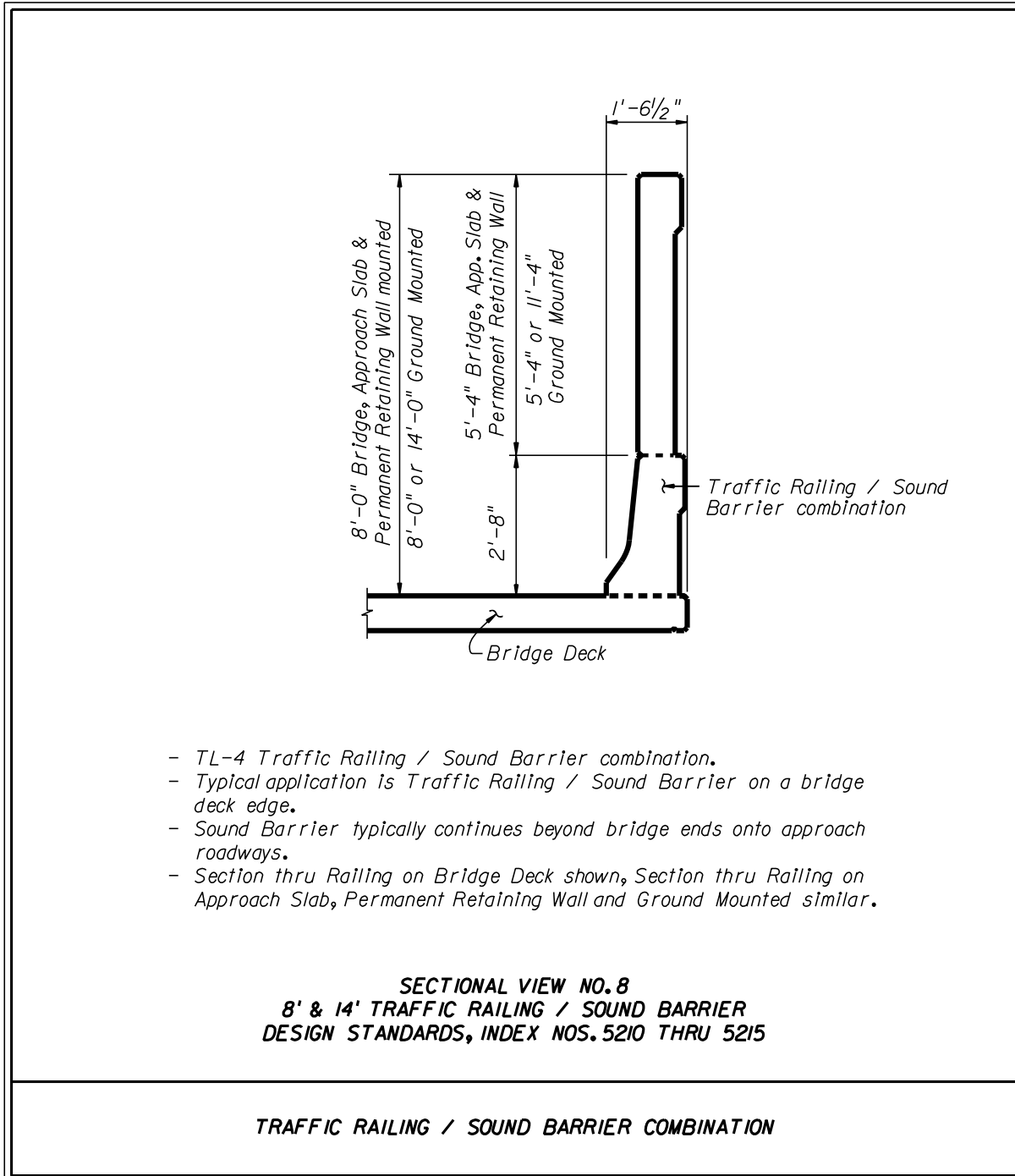

Figure 2.12.4 Bridge Traffic Railings – Sound Barrier Combination



- TL-4 Traffic Railing / Sound Barrier combination.
- Typical application is Traffic Railing / Sound Barrier on a bridge deck edge.
- Sound Barrier typically continues beyond bridge ends onto approach roadways.
- Section thru Railing on Bridge Deck shown, Section thru Railing on Approach Slab, Permanent Retaining Wall and Ground Mounted similar.

Figure 2.12.5 Bridge Railing and Separators – Median Traffic Railing and Separators

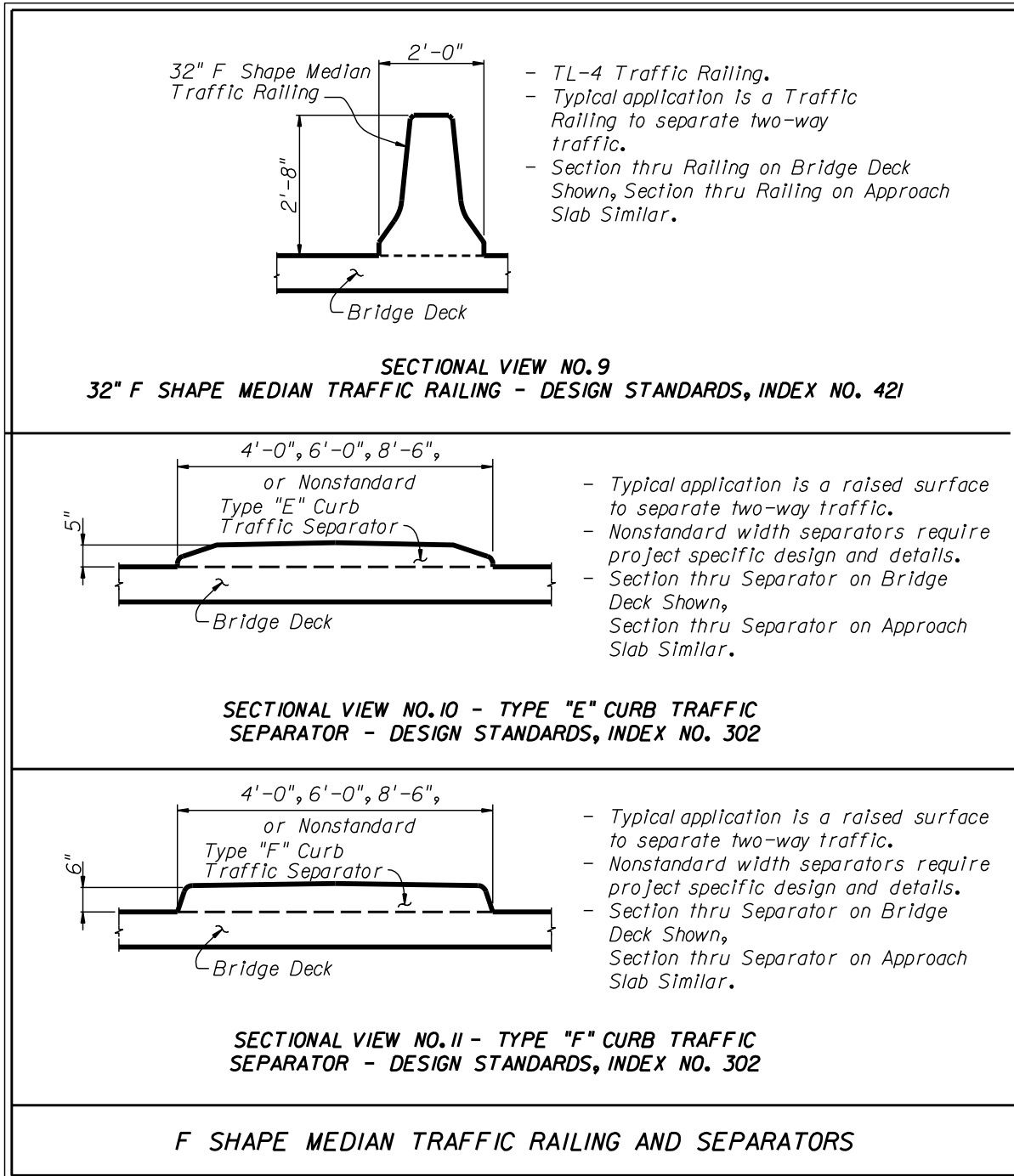

Figure 2.12.6 Bridge Fencing for Traffic Railings

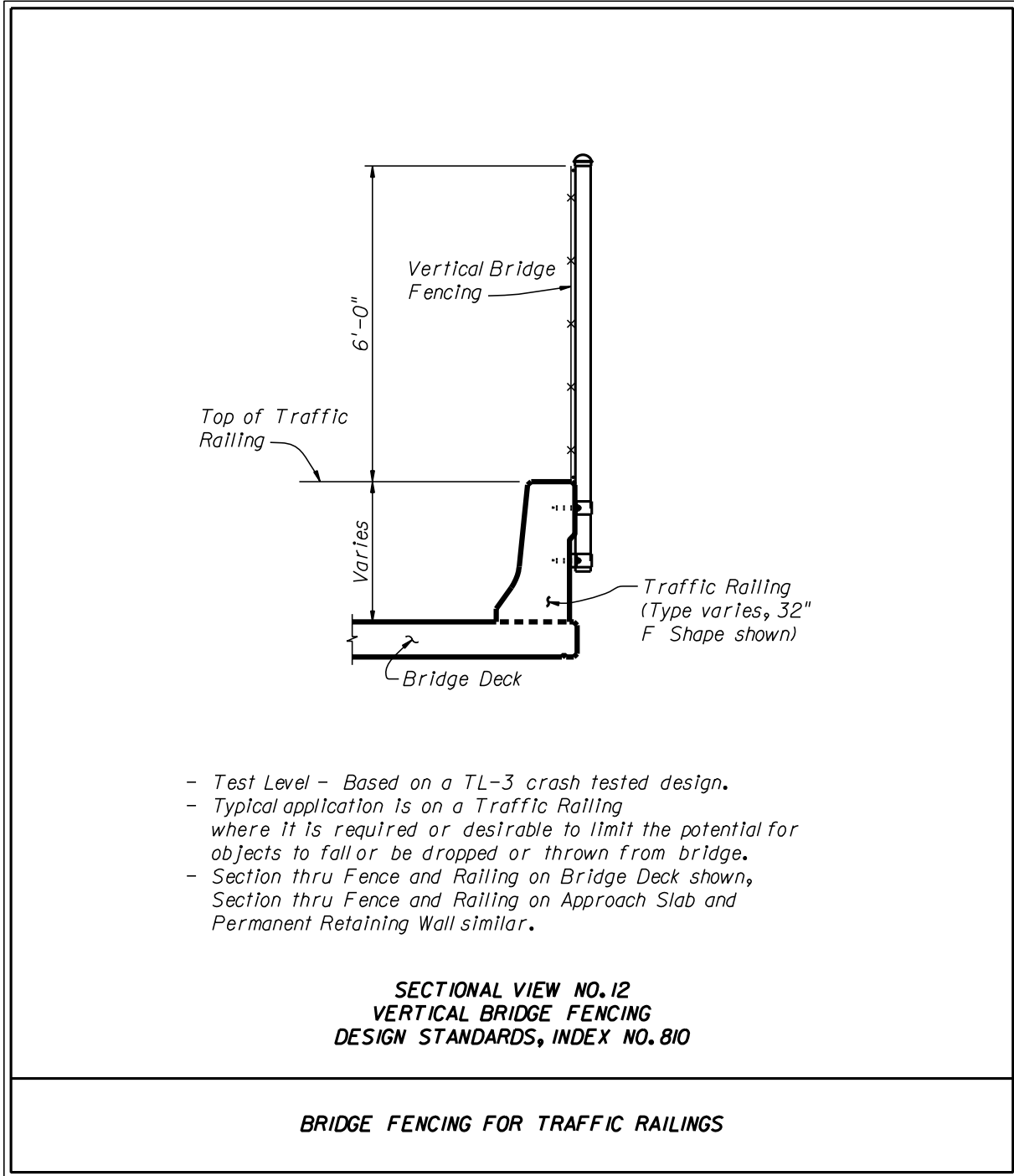

Figure 2.12.7 Bridge Railing – Pedestrian / Bicycle Railing

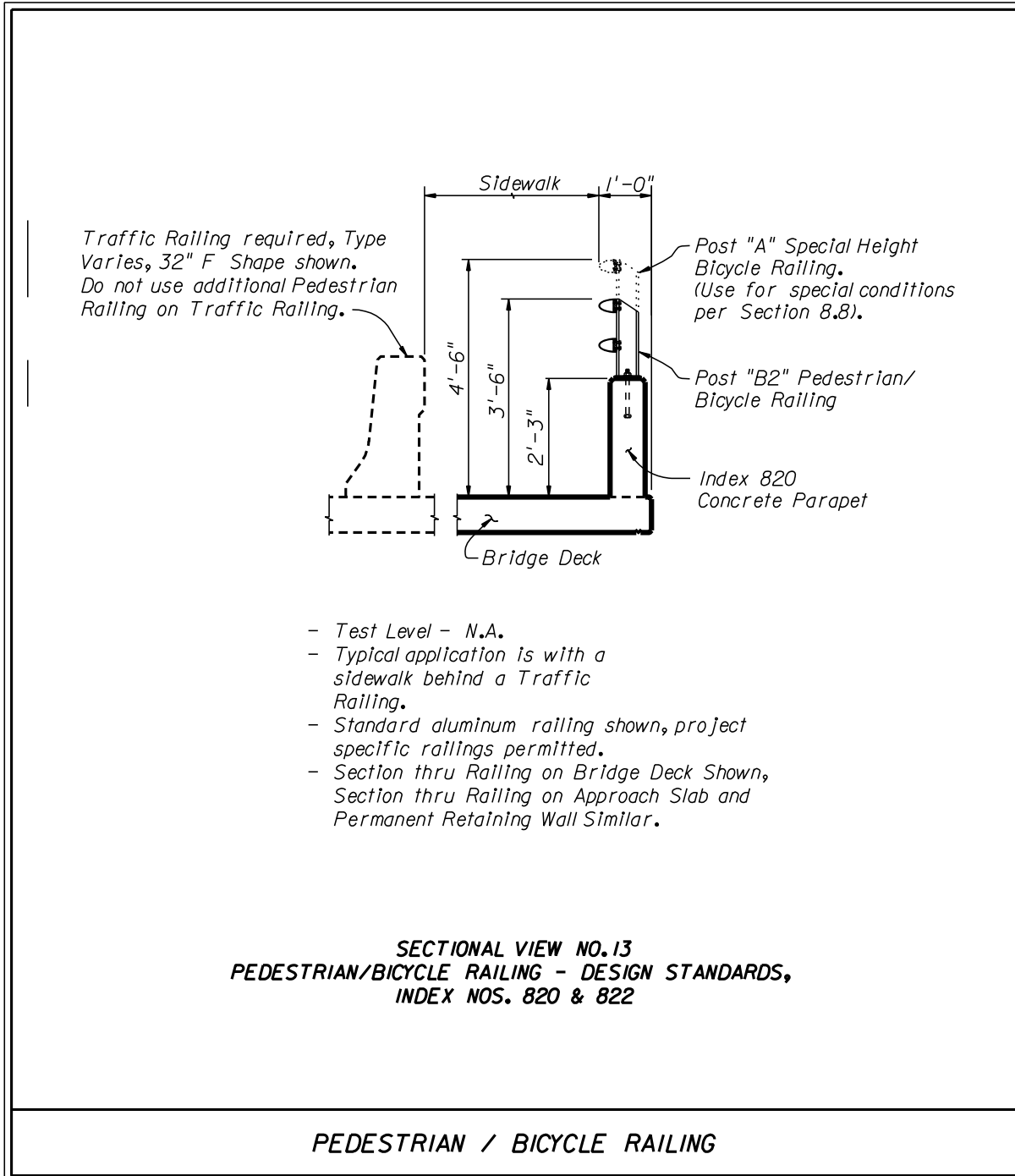

Figure 2.12.8 Bridge Fencing for Pedestrian Railing

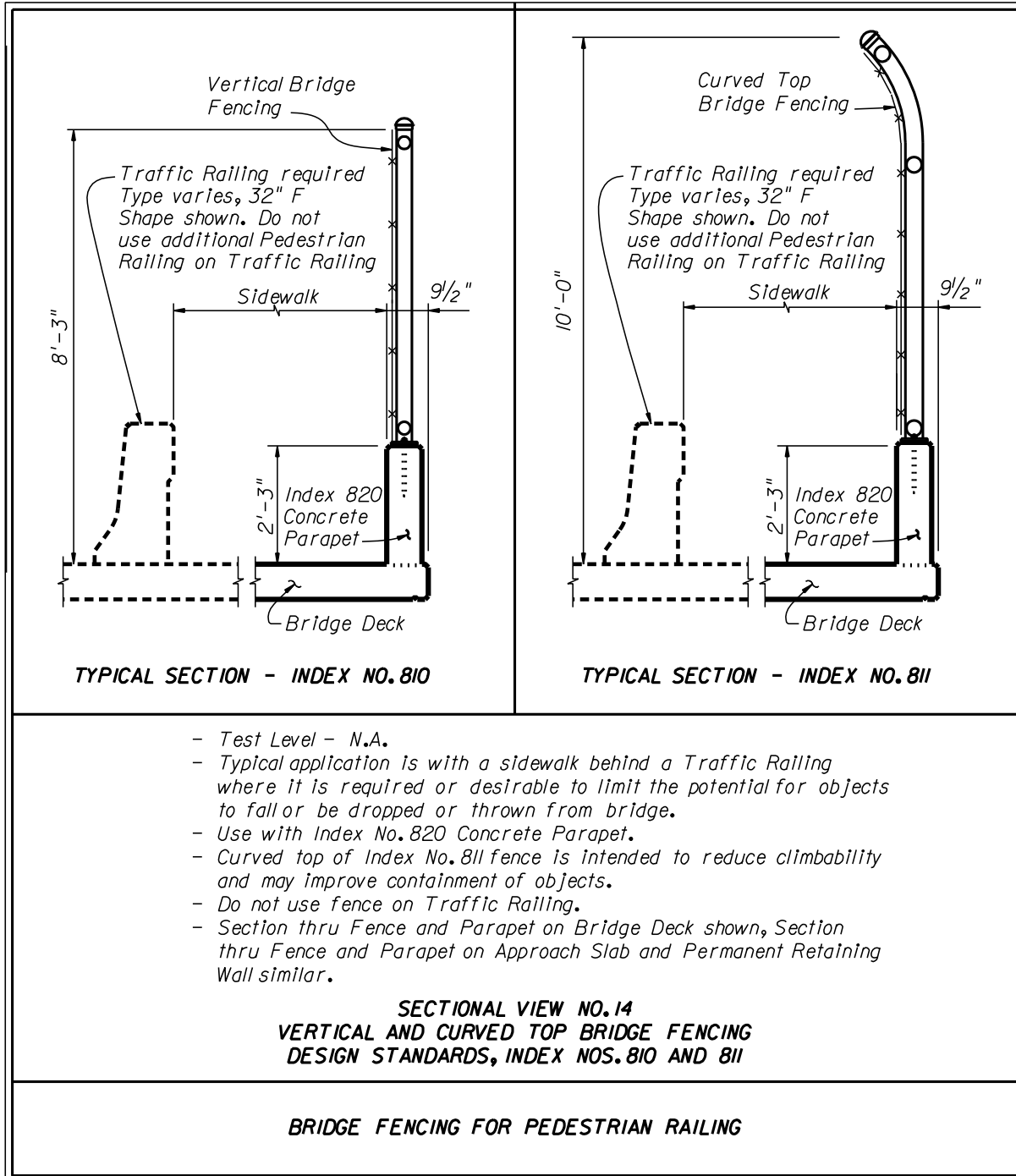
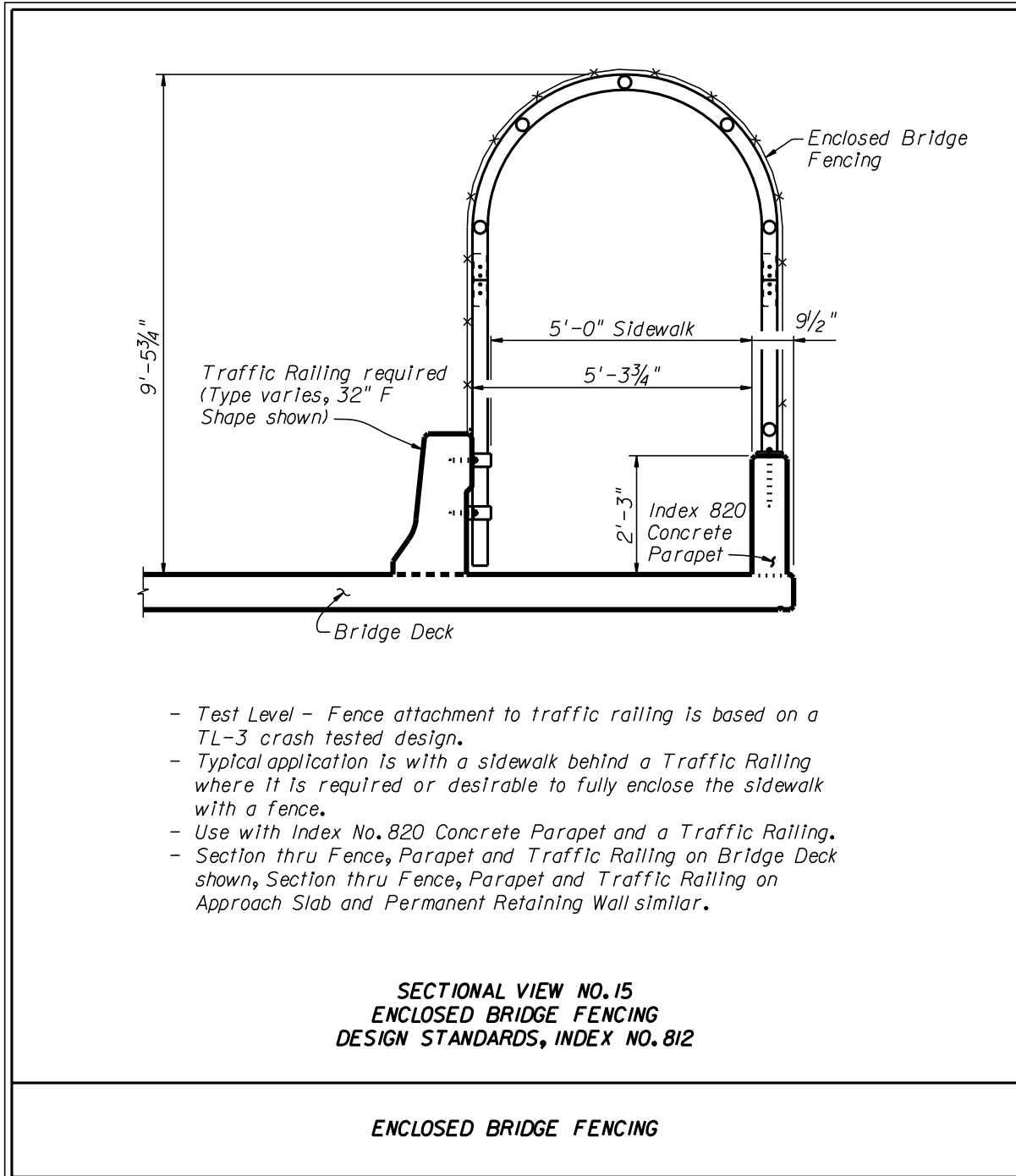

Figure 2.12.9 Enclosed Bridge Fencing for Pedestrian Railing



2.13 Intersections

Design guides and criteria presented heretofore are also applicable to the proper design of intersections.

2.13.1 Circular Intersections (Roundabouts)

The circular intersection with all yield control is another design concept for the designer to consider. Two critical elements of the small circular traffic pattern with a central island are as follows:

1. Entry is by gap acceptance by having a yield condition at all entry legs.
2. Speeds through the intersection are 25 mph or less.

The use of this design is best for low speed facilities. Its use should be documented by a complete intersection analysis and study, including alternate types of design.

The ***Florida Roundabout Guide*** (available through FDOT Maps and Publications Sales) presents a methodology for identifying appropriate roundabout sites and estimating roundabout capacity and delay. It describes the design principles and standards to which roundabouts installed on state roadways must conform and offers guidelines for operational features such as signing, marking, lighting, landscaping, etc.. Additional guidance is available in the ***FDOT Traffic Engineering Manual***.

All roundabout designs must be approved by the State Roadway Design Engineer.

2.13.2 Queue Length for Unsignalized Intersections

Turn lanes should comply with the ***Design Standards, Index 301*** to the extent practical. The available queue length provided should be based on a traffic study.

For low volume intersections where a traffic study is not justified, a minimum queue length of 50 ft. (2 vehicles) should be provided for rural areas and small urban areas; for other urban areas, a minimum queue length of 100 ft. (4 vehicles) should be provided.

2.13.3 Offset Left Turn Lanes

The alignment of opposing left-turn lanes and the horizontal and vertical curvature on the approaches are the principal geometric design elements that determine how much sight distance is available to a left-turning driver. Operationally, vehicles in the opposing left-turn lane waiting to turn left can also restrict the left-turning driver's view of oncoming traffic in the through lanes. The level of blockage depends on how the opposing left-turn lanes are aligned with respect to each other, as well as the type/size of vehicles in the opposing queue and their position in the opposing lane.

The offset distance is defined as the distance between the left edge of the turn lane and the right edge of the opposing turn lane. If the offset distance is to the left of the turn lane it is considered a negative offset, and if it is to the right of turn lane it is considered a positive offset.

The conventional method of designing left turn lanes is to place the left turn lanes adjacent to the through lanes. This design creates a negative offset which severely restricts the sight distance of the left-turning driver's view of oncoming traffic when another vehicle is in the opposing turn lane. **Figure 2.13.1** indicates the negative offset when the conventional design is used.

Figure 2.13.1 Typical Opposing Left Turns (22' Median with Negative 10' Offset)

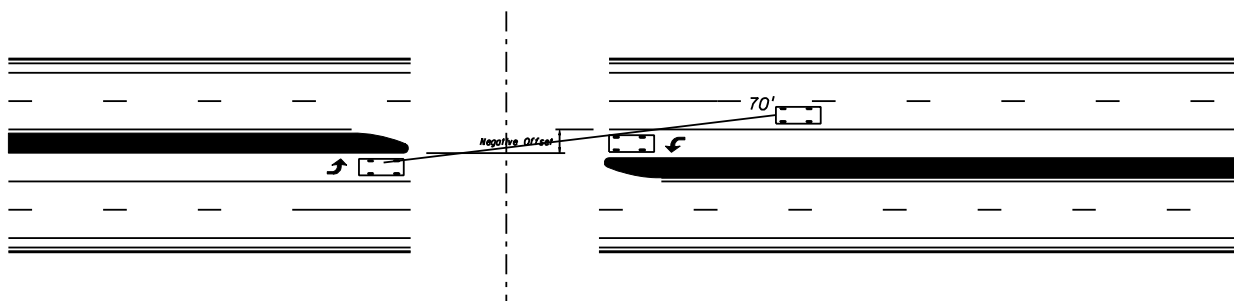

On all urban designs offset left-turn lanes should be used with median widths greater than 18 feet. A four foot traffic separator should be used when possible to channelize the left turn and provide separation from opposing traffic. On rural intersections where high turning movements are involved, offset left-turn lanes should also be considered. On median widths 30 feet or less, an offset turn lane parallel to the through lane should be used and the area between the left turn and traffic lane where vehicles are moving in the same direction should be striped out. On medians greater than 30 feet, a tapered offset should be considered. **AASHTO Exhibit 9-98** illustrates the design of parallel and tapered left turn lanes. **Figure 2.13.2** indicates an offset left turn.

Figure 2.13.2 Typical Opposing Left Turns (22' Median with Negative 1' Offset)

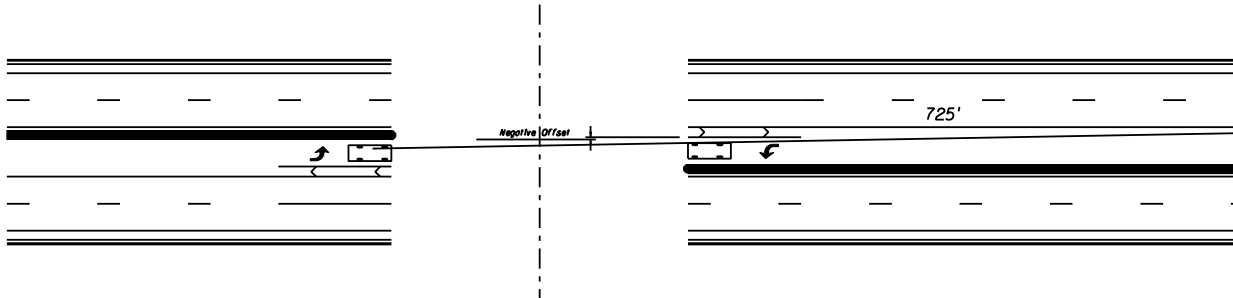

As illustrated in **Figure 2.13.2**, the sight distance is improved significantly by utilizing the offset left turn design even when a positive offset is not achieved. The graph in **Figure 2.13.3** is taken from the *Older Driver Highway Design Handbook*, and gives the left turn offset guidelines that may be considered for various design speeds and vehicle types.

Figure 2.13.3 Left Turn Offset Guidelines

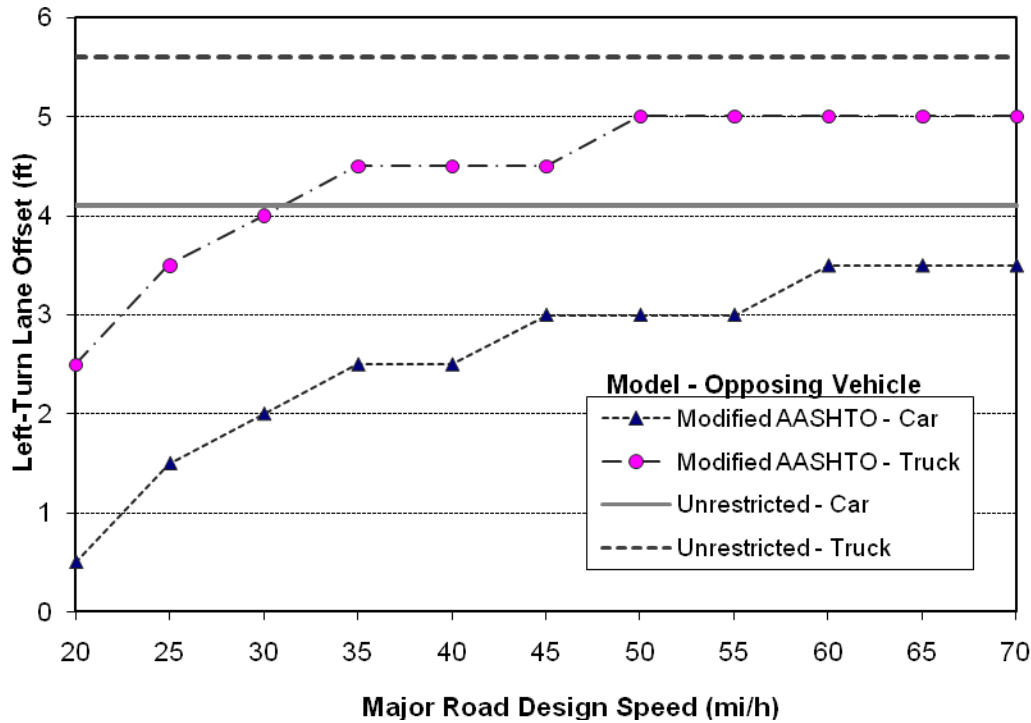

THIS PAGE LEFT BLANK INTENTIONALLY

2.14 Interchanges and Median Openings/Crossovers

Design guides and criteria presented heretofore and in the *Design Standards* are also applicable to the proper design of interchanges with their inherent ramps, speed change, merging and weaving lanes. Where diamond ramps and partial cloverleaf arrangements intersect the crossroad at grade, an at-grade intersection is formed. In urbanized areas, high speed ramps, weaving areas and acceleration lanes are not appropriate. These ramp terminals should be designed as intersections consistent with the design speed and character of the roadway.

2.14.1 Limited Access Right of Way Limits at Interchanges

The following criteria will be used in establishing limited access limits along crossroads at interchanges:

1. For rural interchanges, limited access will extend along the crossroad to a point 300 ft. minimum beyond the end of the acceleration or deceleration taper. In the event these points are not opposite, the point most remote from the project will be the control and the limited access on both sides will end at that station along the crossroad. Where no taper is used, the limited access will be carried to a point 300 ft. minimum beyond the radius point of the return. In this case also, the radius point most remote from the project will control.
2. For interchanges in urban areas, the criteria given above will apply except that the limited access will end a minimum of 100 ft. beyond the end of taper or the radius point of the return.
3. For unsymmetrical interchanges such as half-diamonds and partial clover leaves, etc., the limited access right of way along the crossroad on that side having no ramp will extend to a point opposite that point controlled by the ramp.
4. Limited access along crossroads overpassing limited access facilities (with no interchange) shall be extended approximately 200 feet, measured from the mainline right of way line, along the crossroad. This distance may be reduced or omitted if the crossroad profile provides for adequate sight distance for existing or proposed driveways. The fence is generally tied into the crossroad structure end bent unless required along the crossroad.
5. Any reduction in the values shown above for limited access limits must be approved by FHWA for interstate projects and by the District Design Engineer for non-interstate limited access facilities.

Access Management Rule 14-97 standards (**14-97.003(1)j**) regulate the location of

driveway connections and median openings in interchange areas on arterial roads. This standard should be applied in accordance with the District procedures for implementing the Rule, and should not be confused with minimum requirements for limited access right of way.

2.14.2 Median Openings at Interchanges

Median opening locations at interchanges on arterial roads must consider **Access Management Rule 14-97 (14-97.003(1)(j)2)** which states “The minimum distance to the first median opening shall be at least 1320 feet as measured from the end of the taper of the egress ramp.” This standard is to be applied in accordance with the FDOT median opening decision process. As a minimum, for all crossroad facilities at interchanges in both rural and urban areas, a median opening may be centered no less than 50 ft. beyond the end of limited access except that a minimum distance of 660 ft. to the ramp median opening will be required. In no case should access be permitted between the interchange proper and the median opening as established by these criteria.

2.14.3 Ramp Widths

Ramp widths for interchange ramp terminal design are given in **Table 2.14.1**.

Table 2.14.1 Ramp Widths - Turning Roadways

RAMP WIDTHS			
RADIUS To Inside of Curve (FEET)	1-LANE₃		2-LANE
	Traveled Way Width₁ Case I-C₂ One-lane, one-way operation – no provision for passing a stalled vehicle	Traveled Way Width₁ + Outside Paved Shoulder Width Case II-B₂ One-lane, one-way operation – with provision for passing a stalled vehicle	Traveled Way Width₁ Case III-A₂ Two-lane operation – either one-way or two-way
	FEET		
50	23	26	29
75	20	23	27
100	18	22	26
150	17	21	24
200	16	20	24
300	15	20	24
400	15	19	24
≥ 500	15	19	24

For widths on the ramp proper, see **Table 2.1.3**.

For case application, see **AASHTO** and the **Design Standards, Index No. 525**.

1. AASHTO adjustments do not apply.
2. Note: A = Predominantly P vehicles, but some consideration for SU trucks.
 B = Sufficient SU vehicles to govern design, but some consideration for semitrailer combination trucks.
 C = Sufficient bus and combination trucks to govern design.
3. Where accommodation of future resurfacing is a factor, consideration should be given to increasing the minimum width to 24 ft. where practical.

2.14.4 Crossovers on Limited Access Facilities

Permanent crossovers on freeways are sometimes necessary to avoid excessive travel distances for emergency vehicles, law enforcement vehicles, and maintenance vehicles. Median crossings shall be allowed only when there is a clear documented request and need for such a feature; however they shall be limited in number and very carefully located. The location of crossovers used for maintenance purposes should consider the needs of emergency and law enforcement vehicles and vice versa. Permanent crossovers should conform to the recommendations of **AASHTO's "Geometric Design of Highways and Streets"** (see Rural Freeway Medians). The location of all crossovers requires approval of the District Design Engineer. Note, this criteria does not apply to contra flow crossovers placed for facilitating hurricane evacuation, nor does it apply to temporary construction crossovers. For temporary construction crossovers, please see **Design Standards, Index Numbers 630 and 631**.

The following AASHTO crossover recommendations are requirements on FDOT's Limited Access Facilities:

1. Not spaced closer than 3.0 miles apart.
2. Located only in areas with above-minimum stopping sight distance and without superelevated curves.
3. Not located within 1,500 feet of the end of a speed-change taper (of a ramp or facility widening/narrowing) or any structure (bridge, overpassing facility or overhead sign).
4. Not located where the median width is less than 25 feet.

Crossover locations that do not meet the above criteria require approval by the State Roadway Design Engineer and FHWA (FHWA on Interstate facilities only).

The following additional criteria are also placed on crossovers designed for FDOT's Limited Access Facilities:

1. Not located within 1.5 miles of any interchange.
2. Not located where the median width is less than 40'.
3. Not located in urban areas
4. Where continuous median barrier is present, openings for crossovers should not be greater than 5.0 miles apart between Interchanges.

Crossovers that do not meet these additional criteria require approval by the District Design Engineer.

Typical layouts for the design of median crossovers are provided in **Figures 2.14.1, 2.14.2 and 2.14.3**. These typical layouts will not cover all situations, but are provided as a guide for developing site-specific designs. Designs should accommodate the types of emergency vehicles expected to use the crossover. Law enforcement vehicles and typical ambulance sized vehicles can usually be easily accommodated. The typical layouts in **Figures 2.14.1, 2.14.2 and 2.14.3** will accommodate an SU design vehicle. To the extent practical, designs should accommodate larger emergency response vehicles such as fire trucks. This will require acquiring information from local emergency responders on the size and configuration of vehicles used. Except where median widths are wider than normal, fire trucks and other larger vehicles will likely not be able to make u-turns without encroaching or crossing travel lanes. As a minimum, designs should provide for the necessary minimum radii and width to allow the largest design vehicle to enter the crossover and stop as close to perpendicular to traffic as practical. All designs should be tested by superimposing the turning path of the design vehicle to insure the crossover will operate as expected.

On Interstate facilities, the Federal Highway Administration directs that median shoulders approaching the crossover utilize the standard shoulder width, or existing shoulder width. The FHWA believes the safety benefits derived by making the crossovers appear less conspicuous outweigh the benefits obtained by providing paved shoulders to accommodate acceleration and deceleration lanes for emergency vehicles, law enforcement, or other authorized vehicles.

The profile of the crossover shall conform as close as practical with travel way shoulder slopes and median side slopes so that the crossover is inconspicuous as possible to traffic. The paved width of the crossover should not be any wider than that necessary to provide for the largest design vehicle. Shoulder width for the crossover should be 8' minimum. Side slopes of the crossover (parallel with the mainline travel way) shall be 1V:10H or flatter. However, side slopes may be transitioned to match the slope of a pipe culvert safety end treatment where a culvert crossing underneath the crossover is necessary to provide for proper median drainage.

In locations where a median barrier is present, the length of the barrier opening should be minimized to the extent practical. As shown in **Figure 2.14.3**, the barrier ends on each side of the opening should be offset to the extent practical. Crashworthy end treatments or crash cushions to shield the barrier ends shall be provided when the ends are within the clear zone and fall within the departure angle used to set length of need.

Crashworthy end treatments or crash cushions shall also be provided whenever the angle between barrier ends is less than 30 degrees measured from the direction of mainline travel (see **Figure 2.14.3**).

Drainage requirements must be determined for each location and appropriate provisions made. The drainage culvert shown in the figures are for example only. Either a mitered end section (1:4) or preferably a u-endwall with grate (1:6) should be used for culverts parallel with the mainline. Note that in some cases existing median ditches are shallow and there will be minimal clearances available for even small size culverts. This requires that site-specific vertical and horizontal geometry be developed for each location rather than use a typical drawing.

A pavement design equivalent to a Limited Access shoulder pavement should be provided (1-1/2" Structural Course, Base Group 1 with a 12" Stabilized Subgrade).

Signing for permanent crossovers shall consist of a "No U-turn" sign (R3-4) with an "Official Use Only" plaque (FTP-66-04). In accordance with **MUTCD Section 3D.03**, a double yellow delineator should be placed on the left side of the through roadway on the far side of the crossover for each roadway (see figures). To improve nighttime visibility for approaching emergency responders, install yellow RPM's placed outside the yellow edge line in advance of the crossover using the following pattern and spacing: 3 spaced 4" apart @ 1500', 2 spaced 4" apart @ 1000', and 1 @ 500' in advance of the crossover.

On reconstruction and RRR projects, the location of existing crossovers shall be evaluated for conformance to the above criteria. Those that do not meet this criterion must be removed as a part of the project unless approved by the State Roadway Design Engineer and FHWA (FHWA approval on Interstate only).

Figure 2.14.1 Crossovers on Limited Access Facilities – 6 or More Lanes

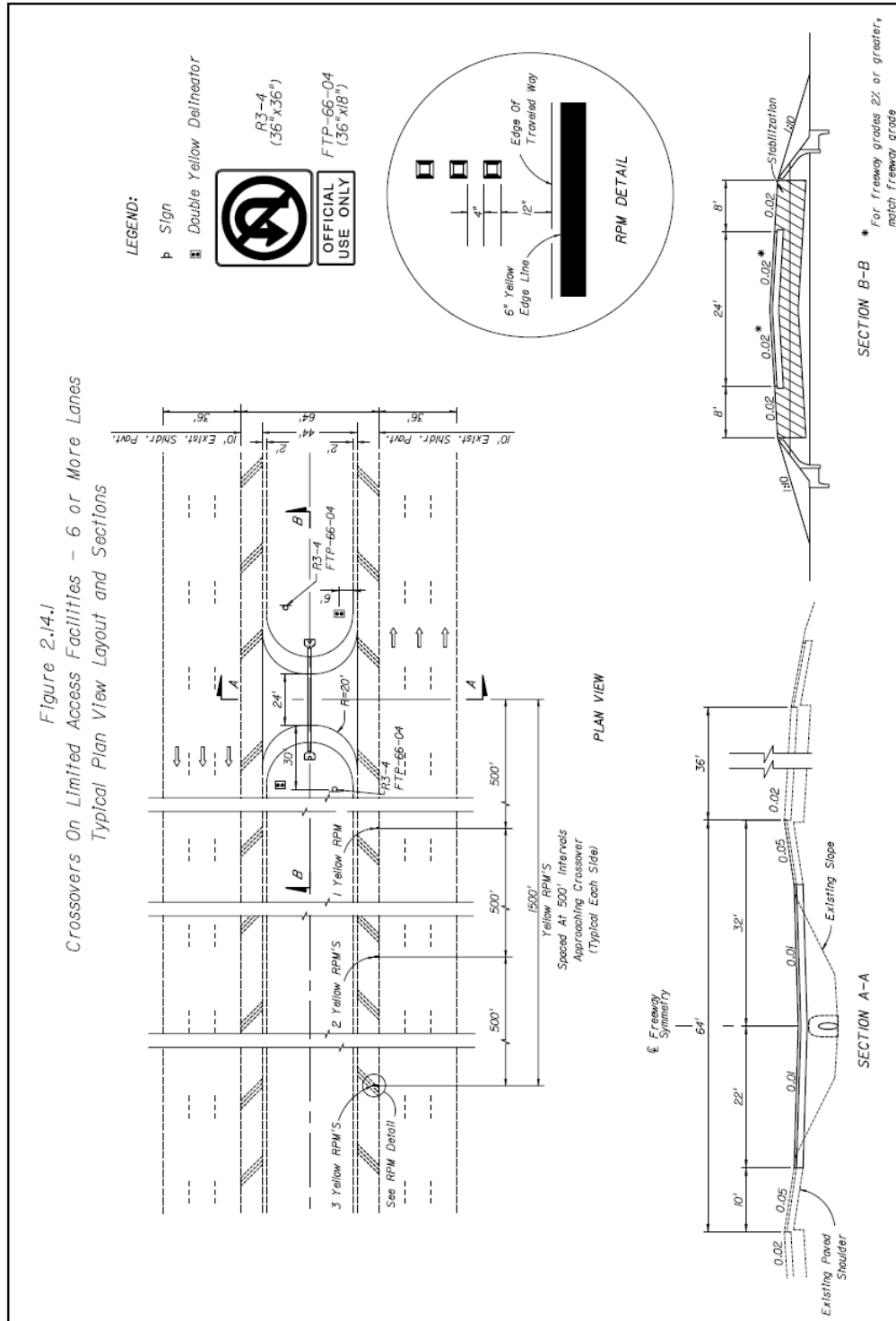

Figure 2.14.2 Crossovers on Limited Access Facilities – 4 Lanes

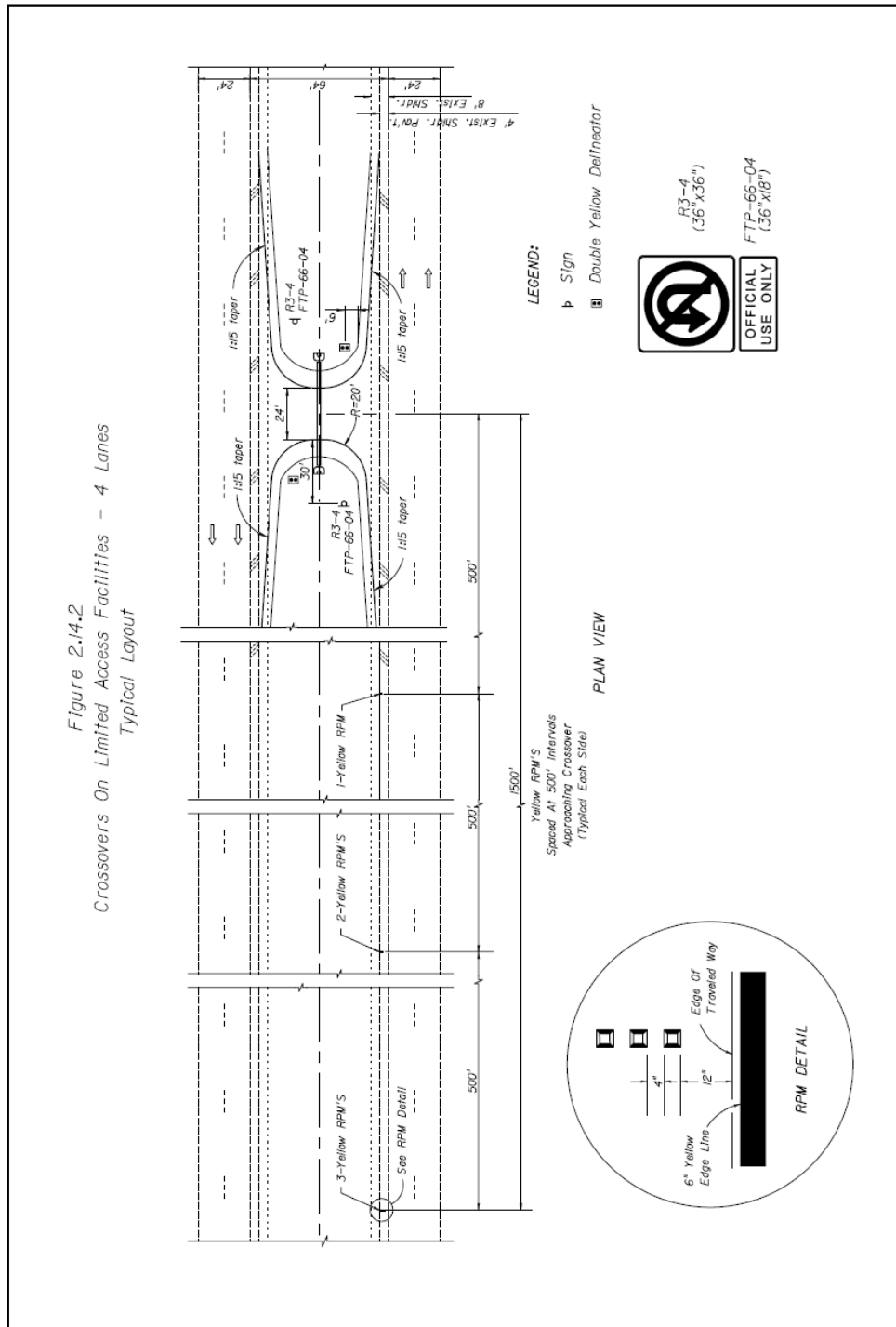
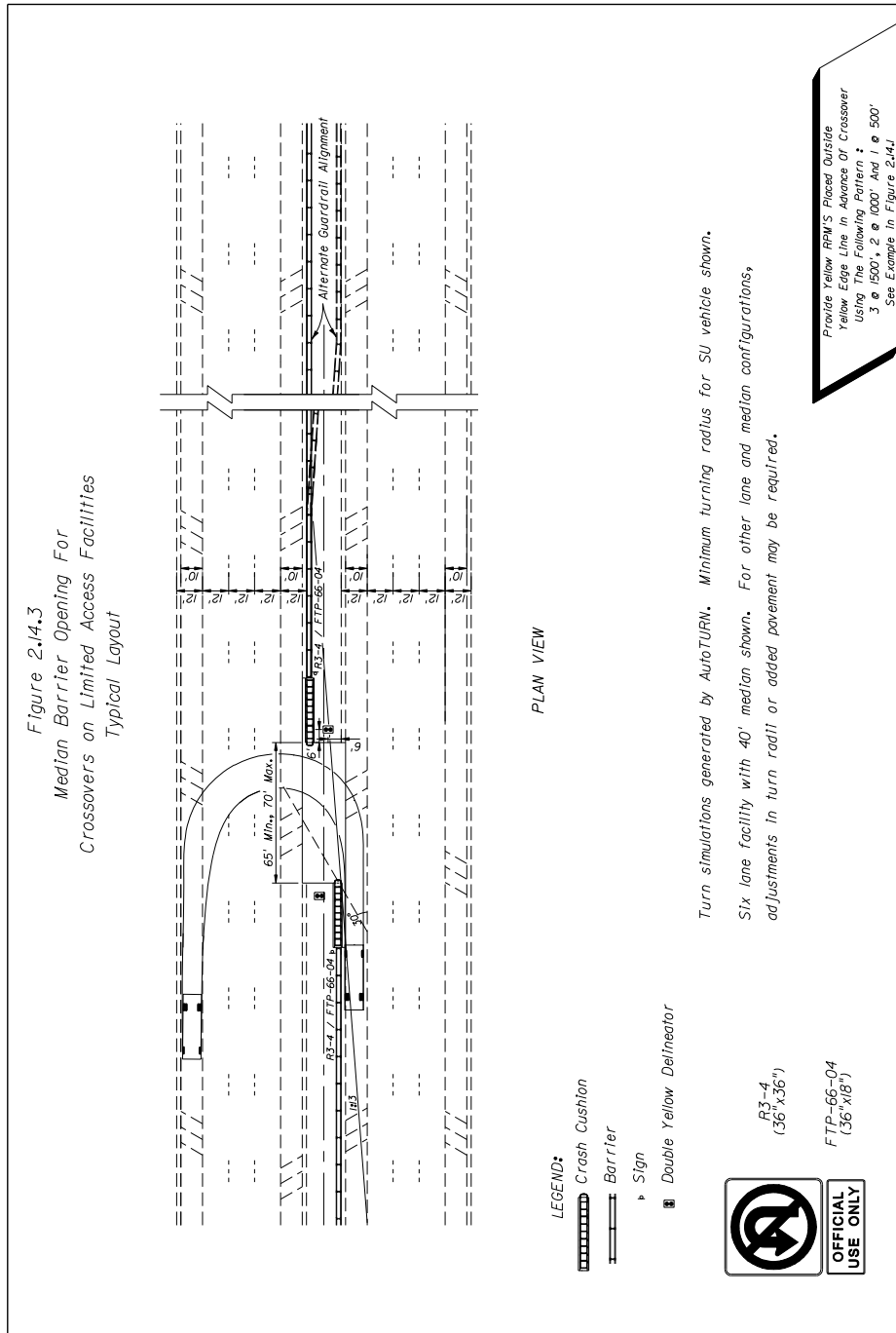

Figure 2.14.3 Median Barrier Opening for Crossovers on Limited Access Facilities



2.15 Lighting Criteria

Lighting Criteria is contained in **Chapter 7** of this volume.

2.16 High-Speed Urban and Suburban Arterial Highways

The two classifications of rural and urban are generally sufficient for the design of Florida's arterial highways; however, there are some areas that do not lend themselves to these classifications. These are transitional areas where conditions along the highway change from rural to urban or from urban to rural. Also, there are urban arterial highways where the anticipated operating speeds are higher than standard urban design speeds. Because of the undesirable effects of having curb and gutter on high speed highways, four-lane and six-lane high speed urban and suburban arterial highway typical sections have been developed to insure that these highways are designed consistently and to minimize the need to process design exceptions and variations. These typical sections are found in **Exhibit TYP-13** and **TYP-14** of **Chapter 6, Volume 2**

Special design criteria in this section have been developed for these four-lane and six-lane high-speed urban and suburban arterial highways. For criteria and other guidance not listed below, the designer is to use the values that are commensurate with either a four-lane or six-lane rural arterial highway having the same design speed and traffic volumes. The use of these special criteria is restricted to facilities within FHWA Urban or Urbanized boundaries where right of way is constrained.

The design of the initial four-lane facility should also take into consideration the ultimate six-lane section that these roadways will have in the future. If an ultimate high speed six-lane section is planned, consideration should be made to acquire a minimum of 80 feet of right of way on each side and construction of 6.5-foot shoulders adjacent to the median as shown in the six-lane section. This can avoid future widening and curb relocation in the median as well as future right of way acquisition to obtain proper border and clear zone. In addition, special attention to the ultimate location of drainage structures, sidewalk offset and elevation, superelevation and curve radii can minimize the amount of reconstruction of these elements as well. To illustrate two possible scenarios, **Figure 2.16.1** and **Figure 2.16.2** show examples of four-lane and six-lane high-speed suburban arterial sections with the future six-lane low-speed urban arterial typical section superimposed. A six-lane high-speed urban typical section is found in **Exhibit TYP-16** of **Chapter 6, Volume 2**. A four-lane high-speed urban typical section differs from the six-lane section in median shoulder width as discussed in **Section 2.16.5**.

Figure 2.16.1 Four-Lane High-Speed Urban and Suburban Section

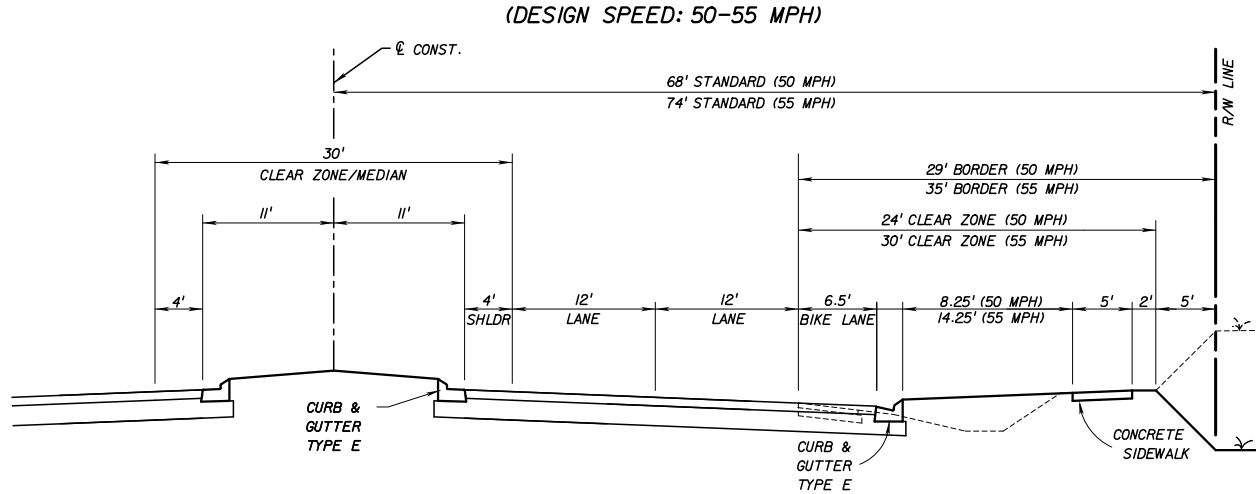
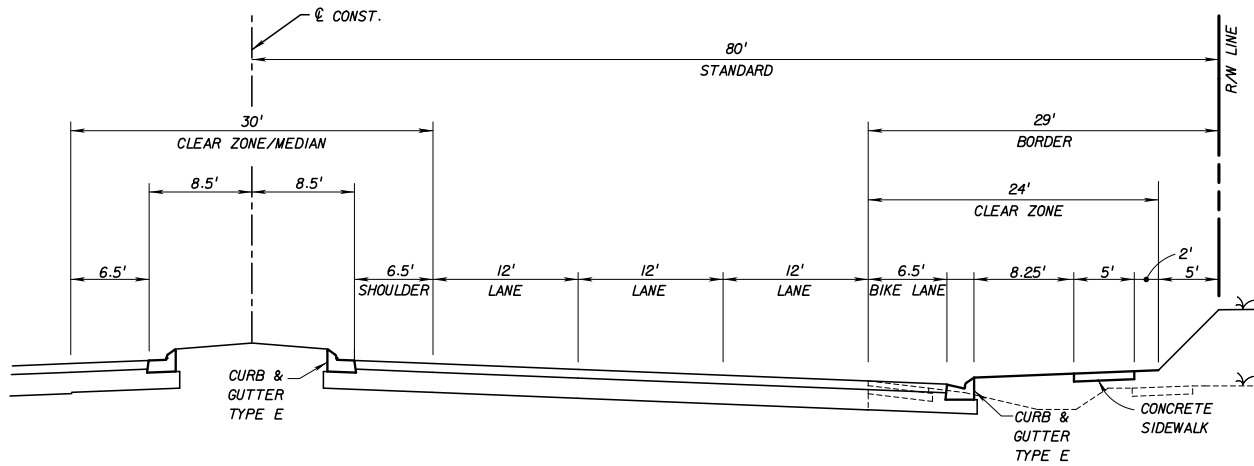

Figure 2.16.2 Six-Lane High-Speed Urban and Suburban Section

(DESIGN SPEED: 50 MPH)



2.16.1 Design Speed

The maximum design speed of four-lane high-speed urban and suburban arterial highways is 55 mph. The maximum design speed of six-lane high-speed urban and suburban arterial highways is 50 mph.

2.16.2 Curbs

To minimize right of way requirements, the high-speed urban and suburban arterial highway typical section incorporates the use of curbs and a closed drainage system. The type of curb used within the clear zone on this section is restricted to the FDOT Type E shape (sloping curb not greater than 5 inches in height above adjacent pavement). This applies to both median and outside shoulder locations. Flush shoulders can be utilized on the outside as long as clear zone and other criteria requirements can be maintained.

2.16.3 Pedestrian and Bicycle Facilities

Four-lane and six-lane high-speed urban and suburban arterial highways shall have sidewalks which provide accommodations for pedestrians and bicycle lanes which provide accommodations for bicyclists. See **Section 2.16.5** and **Chapter 8** for additional information.

2.16.4 Medians

The minimum median width for four-lane and six-lane high-speed urban and suburban arterial highways may be reduced to 30 feet (inclusive of median shoulders) as opposed to 40 feet minimum required in **Table 2.2.1**. A 30-foot median provides sufficient width for a 30-foot clear zone. This median width also allows space at intersections for dual left turn lanes (11-foot lanes with 4-foot traffic separator), and directional median openings using 4-foot traffic separators. When this is done neither a design exception nor design variation is required.

2.16.5 Shoulders

The minimum median shoulder width for four-lane high speed urban and suburban arterial highways is 4 feet measured to the lip of the gutter. This provides for 5.5 feet of usable median shoulder to the curb face. The minimum median shoulder width for six-lane high-speed urban arterial highways is 6.5 feet measured to the lip of the gutter. This provides for 8 feet of usable median shoulder to the curb face. Under special circumstances (i.e., dual left turn lanes, directional median openings, etc.) it may be necessary to encroach into the median shoulder. In these locations only, the minimum median shoulder width may be reduced to 4 feet (measured to face of curb or separator) while maintaining the same median width.

The minimum outside shoulder width for four-lane and six-lane high speed urban and suburban arterial highways is 6.5 feet measured to the lip of the gutter. This provides for 8 feet of usable outside shoulder to the curb face. As a minimum, the outside shoulder shall be marked as a bicycle lane. The bicycle lane to the left of right turn lanes shall be 5 feet wide.

2.16.6 Friction Course

Because of the higher speeds and the associated risk of hydroplaning, FC-5 friction course is to be provided to reduce surface water. The FC-5 friction course should be placed at the lip of the gutter in accordance with the *Design Standards, Index 300*.

2.16.7 Border Width

The border width for all high-speed urban and suburban arterial highways is measured from the outside edge of the traveled way to the right of way line. For a design speed of 55mph, the minimum border width is 35 feet. For a design speed of 50mph, the minimum border width is 29 feet.

2.16.8 Grades

The maximum grade for four-lane and six-lane high-speed urban and suburban arterial highways is 6% for a 50 mph design speed, or 5% for a 55 mph design speed.

2.16.9 Horizontal Curves

The maximum deflection without horizontal curvature is commensurate with rural new construction and comparable design speeds.

2.16.10 Superelevation

When these urban and suburban typical sections are superelevated, the superelevation rates are based on the $e_{max} = 0.10$ calculations, however the maximum superelevation rate that may be used is 0.05 (See **Figure 2.16.3**). Superelevation transition rates are to be commensurate with those for rural highways with 50 or 55 mph design speeds.

Figure 2.16.3 Superelevation Rates for High-Speed Urban and Suburban Sections

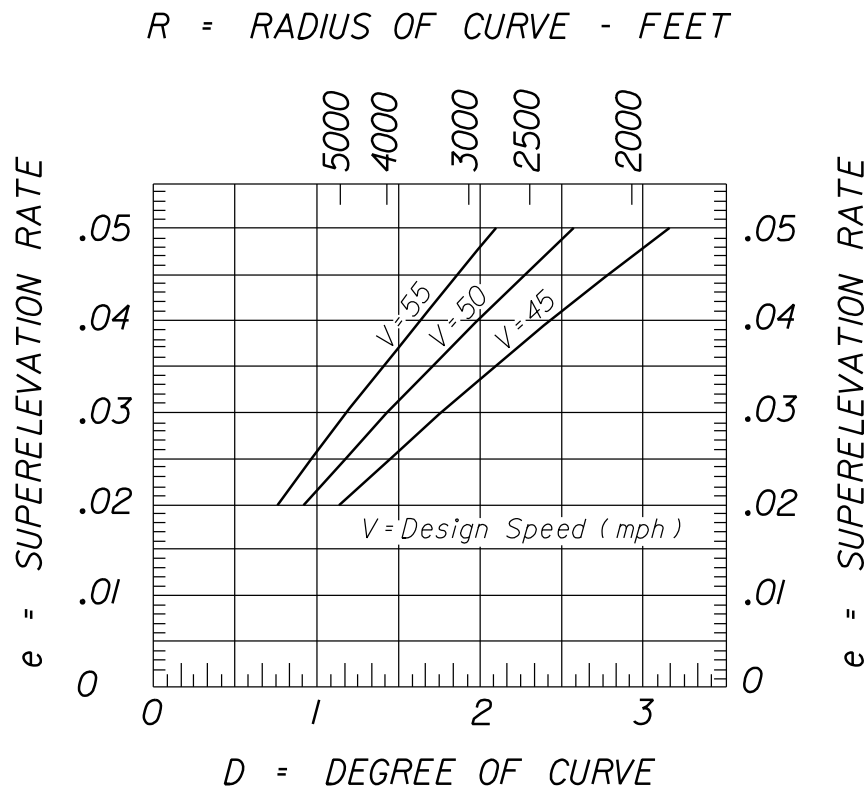

MAXIMUM DESIGN SUPERELEVATION RATE = 0.05
 (BASED ON $e_{max} = 0.10$)

2.16.11 Horizontal Clearance

Horizontal Clearance requirements are to be commensurate with new construction conditions for flush shoulder highways.

THIS PAGE LEFT BLANK INTENTIONALLY

Chapter 3

Earthwork

3.1	General Introduction.....	3-1
3.1.1	General	3-2
3.2	Classification of Soils	3-4
3.3	Cross Sections - A Design Tool	3-5
3.4	Earthwork Quantities.....	3-7
3.4.1	Method of Calculating	3-7
3.4.2	Earthwork Tabulation	3-7
3.4.3	Earthwork Accuracy	3-8
3.4.3.1	Projects With Horizontal and Vertical Controlled Cross Sections	3-8
3.4.3.2	Projects Without Horizontal and Vertical Controlled Cross Sections	3-9
3.4.4	Variation in Quantities.....	3-9
3.5	Earthwork Items of Payment.....	3-10
3.5.1	Guidelines for Selecting Earthwork Pay Items	3-10
3.5.2	Regular Excavation.....	3-11
3.5.3	Embankment.....	3-12
3.5.4	Subsoil Excavation.....	3-12
3.5.5	Lateral Ditch Excavation	3-12
3.5.6	Channel Excavation	3-13
3.5.7	Borrow Excavation (Truck Measure).....	3-13
3.5.8	Regular Excavation (RRR Projects Only)- Lump Sum.....	3-14
3.5.9	Summary of Earthwork.....	3-15

Tables

Table 3.5.1 Guidelines for Selecting Earthwork Pay Items3-10

Figures

Figure 3.1.1 Cut and Fill Limits (With and Without Subsoil
Excavation)3-3

Figure 3.4.1 Format for the Tabulation of Earthwork Quantities3-7

Figure 3.5.1 Pond Template.....3-11

Exhibits

Exhibit 3-A Fill and Truck Adjustments.....3-14

Exhibit 3-B Summary of Earthwork Box
(Projects With Cross Sections)3-15

Exhibit 3-C Summary of Earthwork Box
(Projects With Limited or No Cross Sections)3-16

Chapter 3

Earthwork

3.1 General Introduction

In 2000, the Department changed its philosophy on several issues that involved earthwork. This chapter was completely rewritten to include the changes that simplified how the Department addressed earthwork on a project. This introduction, highlighting those changes, was included in the manual to summarize the changes at a glance. Complete review of this chapter is recommended prior to plans preparation utilizing earthwork on a project.

Summary of Major Changes to Earthwork

1. Pay for all Cut Operations as Regular Excavation (CY) or Regular Excavation (Lump Sum). Do not differentiate between suitable and unsuitable.
2. Pay for all Fill Operations as Embankment or Borrow Excavation (Truck Measure).
3. Permanently Block the Pay Item for Borrow Excavation (Pit Measure).
4. Pay for all material excavated below the finished grading template as Subsoil Excavation. Do not differentiate between suitable and unsuitable.
5. Pay for subsoil excavation and backfill will be separate using the English method.
6. When quantities are large, pay for Lateral Ditch and/or Channel Excavation separately.
7. When calculating the quantity of Borrow Excavation (Truck Measure) do not subtract the quantity of Regular Excavation on the project.
8. Show soil survey borings on the Cross Section Sheets. Do not show limit lines **except** the lower limits of the removal of organic and/or plastic material to determine the quantities of subsoil excavation.
9. Revise the Earthwork Column format on the Cross Section Sheets. Show Subsoil Exc. - Regular Exc. - Embankment on the right side. Do not create columns for material classification. There will be no earthwork columns on the left side.
10. Identify Pond Excavation Limits and guidance in the PPM.
11. Material utilization will be left up to the Contractor. Adjusting quantities of material to compensate for Traffic Control or Sequence Phasing is no longer required.

3.1.1 General

Earthwork is a generic term for all items of work, materials and operations required to construct the excavated areas and the embankments of a project. **FDOT Specifications, Sections 120** and **125** define the terms, method of measure, basis of payment and pay items associated with earthwork.

In general, earthwork on a highway project consists of:

Embankment	Compacted fill material needed to construct the roadway, excluding the base and pavement portions of the roadway and shoulders.
Regular Excavation	Excavation necessary for the construction of the roadway, ditches, ponds, channel changes, etc.
Subsoil Excavation	Excavation, removal and disposal of any material that is unsuitable in its original position and that is excavated below the finished grading template.

The most important roadway operation involving earthwork is constructing the roadbed. The roadbed is constructed by excavating soil from cut sections and placing soil as embankments in fill sections. In cut sections, the roadbed is built below the original ground - the original ground is excavated to the elevation of the proposed roadbed. In fill sections, the roadbed is built above the original ground - the earth fill is on an embankment.

The finished grading template is defined as the finished shoulder and slope lines and bottom of the completed base or rigid pavement for most pavements. The Department occasionally uses stabilized bases and sand bituminous road mixes. For these, consider the finished grading template as the top of the finished base, shoulders and slopes.

Figure 3.1.1 Cut and Fill Limits (With and Without Subsoil Excavation)

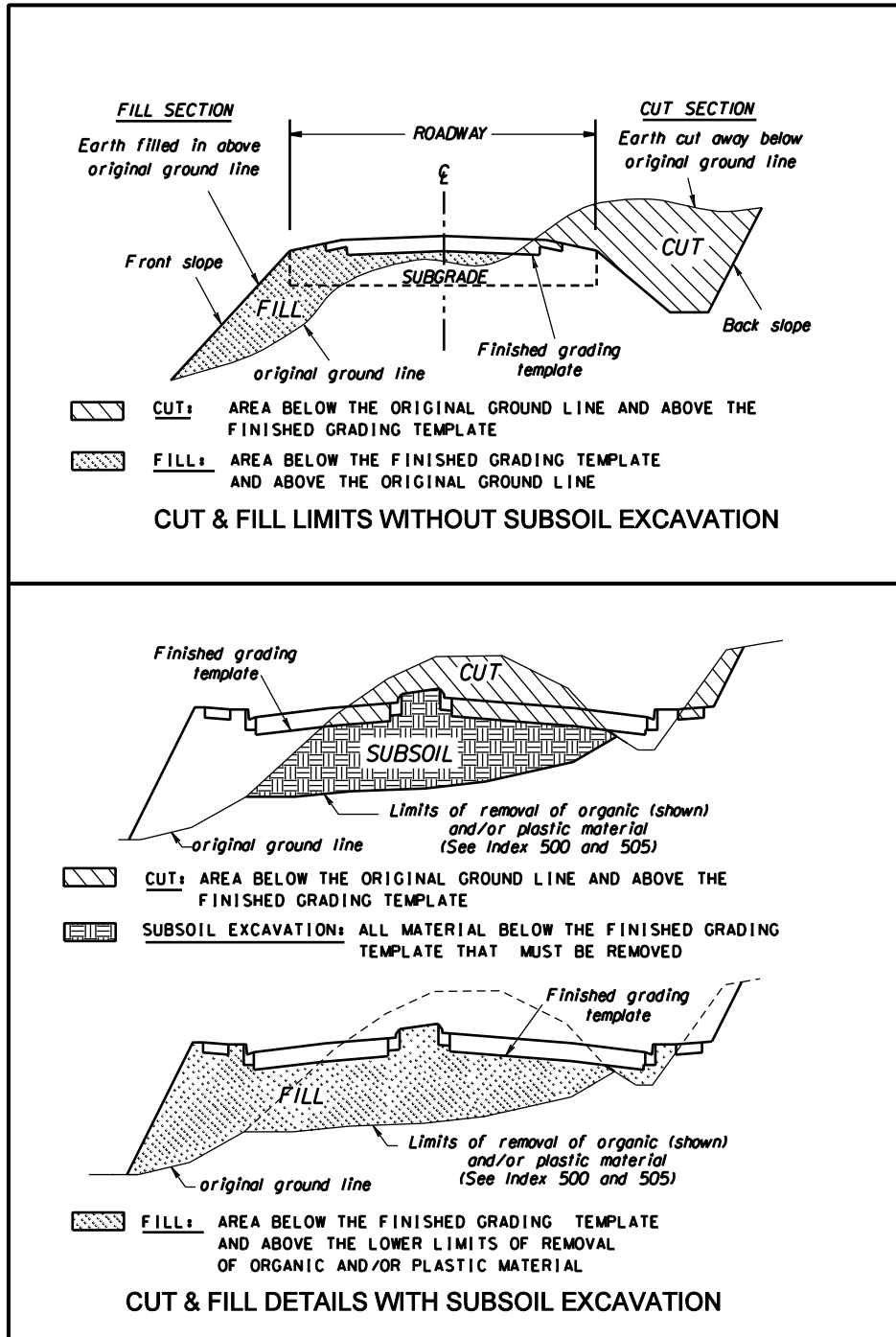

See the Design Standards, Indexes 500 and 505

3.2 Classification of Soils

The Department uses a system of soil classification that places materials into groups and subgroups based on soil fraction, liquid limit and plasticity index. This classification determines if and where the materials may be placed or left in their original position on a project. The soils survey, testing and classification of materials must be performed by a qualified geotechnical laboratory. The plans will include the information about the soil classification on the soil survey sheet and by showing the boring data soil boxes on the cross section sheets. If it is determined that an organic or plastic material must be removed below the finished grading template, the lower limits of removal of organic or plastic material will be shown to determine the area and volume of subsoil excavation. For more details, see **Volume 2** and the **Design Standards, Index 505**.

3.3 Cross Sections - A Design Tool

The details of cut and fill of earthwork are shown on the cross sections. The cross sections of the existing surface are usually obtained by location field survey or photogrammetry. The finished profile grades, typical section details, pavement design details, superelevation and horizontal alignments are used in combination to develop the finished template at each location where an existing cross section was obtained or generated. Sometimes it is advisable to develop and plot intermediate cross sections or half-sections to accurately determine quantities.

Cross sections cannot be finalized until late in the design process. However, preliminary cross section templates, developed early in the design process, can assist the designer in establishing many of the other design elements such as guardrail, shoulder gutter, inlets and special ditch grades. Preliminary cross sections are also used in performing the Soils Survey. Cross section templates should be plotted as soon as the alignment, grades and typical section details are established.

The interval selected for showing cross sections in the plans will vary according to project specific factors. For guidance see **Volume 2, Section 18.3**.

For resurfacing and minor widening and resurfacing projects, see **Section 3.5.8** of this chapter.

Additional criteria used for plotting the earthwork details are found in the **FDOT Specifications, Section 120**; the **Design Standards, Indexes 500** and **505**; and **Volume 2** of this manual.

THIS PAGE LEFT BLANK INTENTIONALLY

3.4 Earthwork Quantities

3.4.1 Method of Calculating

Earthwork quantities can be accurately determined by computer or by manual calculation, if proper care is taken. Therefore, the specifications allow it to be designated for payment as the original plan quantity unless determined to be substantially in error. Earthwork quantities are calculated by the method of average end areas:

$$\text{CUBIC YARDS} = \frac{\text{EA1} + \text{EA2} \times \text{LENGTH}}{2} / 27$$

Each set of end areas for the different types of earthwork (subsoil excavation, regular excavation and embankment) are calculated separately and shown in the appropriate column on the cross section sheets, as indicated in **Volume 2** of this manual.

3.4.2 Earthwork Tabulation

Areas and volume for subsoil excavation, regular excavation and embankment are tabulated on the right hand side of the cross section sheet. The designer must be familiar with the control lines for earthwork operations in order to properly delineate and calculate earthwork quantities.

Figure 3.4.1 Format for the Tabulation of Earthwork Quantities
 (Show the appropriate tabulation on the right side of the sheet)

Projects With Limited or No Cross Sections		Projects With Cross Sections					
See Example in <i>Section 3.5.7</i> of this chapter.		SUBSOIL EXC.		REGULAR EXC.		EMBK.	
A	V	A	V	A	V	A	V

3.4.3 Earthwork Accuracy

There are two methods of documenting the earthwork quantities for projects. The most accurate and preferred method involves the preparation of cross sections to define the quantities of earthwork involved. This method is mandatory on all new construction and major reconstruction projects. The other method, using working typical sections, is only to be used on RRR type projects where it has been determined that the project is a candidate for payment by Regular Excavation, Lump Sum. It is critical that the designer choose which method is best suited for their project with input from construction.

The calculation of earthwork volumes is not simple but, when performed with care and properly checked, many of the inaccuracies common in earthwork quantity calculations can be avoided. The primary causes for inaccurate earthwork quantities are found to be errors in calculating end areas and choosing inappropriate intervals between the cross sections. Correct methods and techniques for computing earthwork quantities will eliminate the gross errors.

3.4.3.1 Projects With Horizontal and Vertical Controlled Cross Sections

1. Calculate end areas and volumes by computer, when possible, and print the calculations for verification and future use by others.
2. Plot cross section details at the largest scale the sheets will permit. Care should also be taken when plotting slopes that extend over long distances.
3. If end areas are calculated from cross sections manually, show the breakdown of areas, etc. on work sheets and include these as backup in the computation book.
4. When computing volumes, determine lengths between sets of end areas to compensate for volumes that do not run the entire lengths between the normal station lengths.
5. Properly use match lines and turning lines to divide end areas when separate lengths should be used to calculate volumes.
6. Reduce the interval between cross sections to 25 feet or less on ramps or sharp turning roadways, or determine and use the centroid of the section as the length for computing volumes.
7. Exclude bridge spans, large culverts or other exceptions where earthwork is not required.

8. Include quantities for fill slopes under bridges, at guardrail installations and at culvert extensions. Show extended shoulder slope on cross sections at guardrail locations (not steeper than 1:10 per the *Design Standards, Index 400*).
9. Make sure that the fill for all subsoil excavation is included in either the embankment or borrow excavation (truck measure) quantities.

3.4.3.2 Projects Without Horizontal and Vertical Controlled Cross Sections

1. Include working typical cross sections in the computation book at all locations where there is a change in either the existing or proposed templates.
2. Working typicals should include the station limits of the typical, and the end areas of all cut and fill sections. Working typicals may be placed in the plans, but are not required.
3. The thickness of the base box is calculated on the most probable base option. A plan note should also be shown in the plans stating which option was used for calculating the earthwork quantities.
4. Extra fill material needed for the extended shoulder for guardrail placement should be documented in the computation book with the final quantity being tabulated on the summary of earthwork. The quantity should be based on working typical sections showing the extended shoulder slope on cross sections at guardrail locations (not steeper than 1:10 per the *Design Standards, Index 400*).

3.4.4 Variation in Quantities

When detailing and determining earthwork quantities, the designer shall use the most probable base option within the optional base group. A plan note should also be shown in the plans stating which option was used for plotting the cross sections and calculating the earthwork quantities. The Specifications do not allow adjustment of the earthwork quantities that were designated to be paid as plan quantity because a base of different depth was chosen during construction.

3.5 Earthwork Items of Payment

3.5.1 Guidelines for Selecting Earthwork Pay Items

Table 3.5.1 Guidelines for Selecting Earthwork Pay Items

Description		Control Lines	Recommended Pay Item	
			Projects with Cross Sections	Projects with Limited or No Cross Sections
Earthwork operations above the original ground line and below the finished grading template	Fill	from original ground to the finished grading template	Embankment (CY)	Borrow Excavation (Truck Measure) (CY)
Earthwork operations below the original ground line and above the finished grading template	Cut	from original ground to the finished grading template	Regular Excavation (CY)	Regular Excavation (3-R Projects) (LS)
Earthwork operations below the original ground line and below the finished grading template	Cut	from the finished grading template or original ground, whichever is lower, to the lower limits of removal of organic or plastic material	Subsoil Excavation (CY)	Subsoil Excavation (CY)
	Fill	from the lower limits of removal of organic or plastic material removed to the finished grading template	Embankment (CY)	Borrow Excavation (Truck Measure) (CY)
With significant quantities of lateral ditch or channel excavation the designer may select to pay for separately		from finished ground to the finished grading template	Lateral Ditch Exc. Channel Exc. (CY)	N/A

3.5.2 Regular Excavation

This is the most general classification of earthwork excavation. When Lateral Ditch or Channel excavation pay items are not called for in the plans, the total quantity of all excavation shall be paid for as Regular Excavation. Regular Excavation may include roadway, pond and ditch excavation. Roadway Excavation consists of the net volume of material excavated between the original ground line and the finished grading template of the roadway.

Retention or detention areas that require considerable excavation should be summarized separately and added to the Regular Excavation. This is especially important if there is a large quantity and the area is removed from the project by some distance.

Some environmental permits now require that the plans call for excavating additional depth below the finish elevation of the bottom of a pond or ditch. They also require that the area of extra depth be replaced with "blanket material" that will either allow for percolation or not allow for percolation as required by the permit. The drawing below shows the limits of pay for excavation in this situation. The depth and type of fill material must be identified in the plans.

Figure 3.5.1 Pond Template

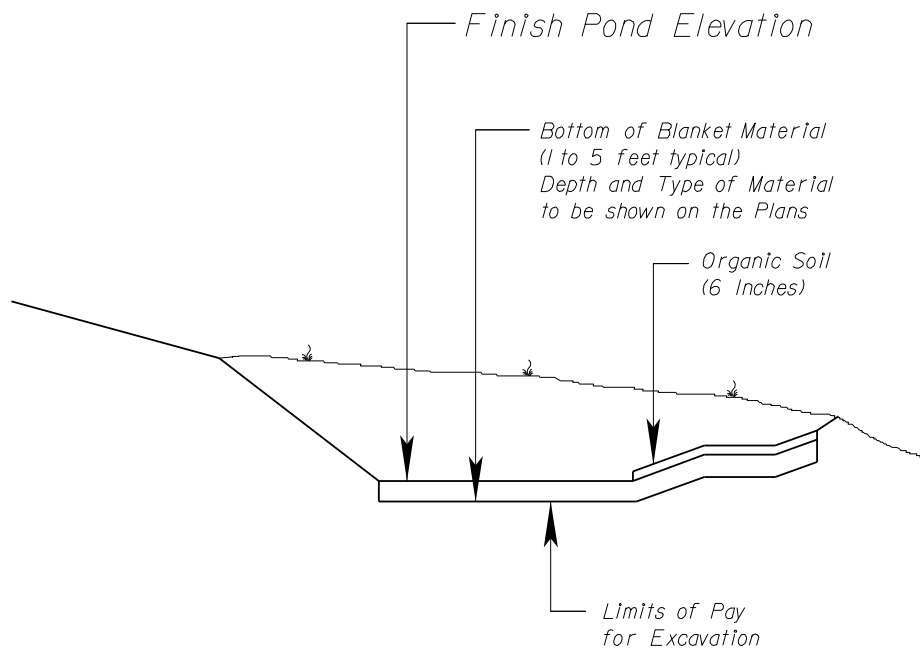

3.5.3 Embankment

This item includes placing material above the original ground line, or above the lower limits of removal of organic and/or plastic material to the finished grading template.

3.5.4 Subsoil Excavation

Subsoil Excavation consists of the excavation and disposal of any material that in its original position is excavated below the finished grading template or original ground, whichever is lower.

The soils investigation survey documents the organic and/or plastic material found on the project. Likewise, the cross sections and the earthwork calculations must use the lower limits of removal of organic or plastic material in determining the quantities for Subsoil Excavation.

Subsoil excavation areas and volumes shall be tabulated on the right side of the cross section sheets. The fill quantities (areas and volumes) shall include areas and volumes required to fill the excavated areas created by subsoil removal. See example given in **Section 3.1** of this chapter.

The payment for subsoil excavation shall not be included in the pay quantities for other items no matter how small the subsoil quantities.

Embankment (fill) or Regular Excavation (cut) should be used in conjunction with the pay item Subsoil Excavation. Both Embankment and Regular Excavation are plan quantity items. The quantities are based on line and grades shown in the plans and would allow construction personnel to field verify the quantities of material used on a project. Subsoil Excavation is a field measure item, and the final pay quantity will be determined by cross section taken when the removal of the material is completed.

3.5.5 Lateral Ditch Excavation

Excavation required to construct inlet and outlet ditches at structures, changes in channels of streams and ditches parallel to the right of way, but separated from the roadway template, may be designated by the designer as Lateral Ditch Excavation.

On projects with very little of this type of excavation, this earthwork is usually included in the Regular or Roadway Excavation. If there is a significant amount of Lateral Ditch Excavation, it should be detailed, calculated and summarized on separate cross section sheets and shown separately in the Earthwork Summary. For more details on lateral ditch cross sections, see **Volume II** of this manual.

Excavation included for payment or that will be bid as work under **FDOT Specifications Section 125, Excavation for Structures and Pipe**, must not be included again in Lateral Ditch or other excavation pay items.

3.5.6 Channel Excavation

The pay item for Channel Excavation consists of the excavation and satisfactory disposal of all material from the limits of the channel as shown in the plans. This work is generally called for by the plans and has lines, grades, typical sections and other details shown for excavating a channel change or a major modification to an existing channel or stream. This work may be significantly different from regular excavation or lateral ditch excavation, requiring draglines, barges or other special equipment. It should be detailed, calculated and summarized separately, in most cases.

3.5.7 Borrow Excavation (Truck Measure)

Borrow Excavation is the pay item used to indicate that the contractor is to furnish earthwork material from areas provided by him and generally outside the project limits, including material with a specific minimum bearing value for building up existing shoulders, when appropriate for the project.

Borrow material, if available, may be obtained from within the right of way of the project. Obtaining material from the project right of way shall not create an unsafe condition or unprotected hazard. Proper design criteria shall be applied to proposed excavation areas that will fill with water. The proposed borrow areas shall be reviewed and coordinated with the District Environmental Coordinator to minimize environmental disturbance and promote a future original appearance.

When the designer chooses the method of payment as Borrow Excavation (Truck Measure), a fill adjustment must be made to the net total fill material calculated from the plans to allow for handling. An additional adjustment (truck) is added to obtain a representative volume of material required. This is not a plan quantity item, but it is very

important that the most realistic determination of quantities possible be calculated by the designer. Recommendations on fill and truck adjustment percentages should always be obtained from either the District Materials or Construction Office during the design process.

Exhibit 3-A Fill and Truck Adjustments

EXAMPLE: Fill (From Working Typical)	253 CY
Fill Adjustment (+20%) (253 x 0.20)	<u>51 CY</u>
Fill	304 CY
Truck Adjustment (+25%) (304 x 0.25)	<u>76 CY</u>
Borrow Excavation (Pay Item)	380 CY

Adjustment percentages shown are for example only. Contact District Materials or Construction Office for actual percentages to be used for each project.

3.5.8 Regular Excavation (RRR Projects Only)-Lump Sum

The Pay Item for Regular Excavation (RRR Projects Only) - Lump Sum is to be used on resurfacing or minor widening and resurfacing (RRR) projects that conform to the following guidelines:

1. There are limited or no cross sections on the project.
2. Existing typicals are reasonably consistent throughout the project.
3. If utility adjustments are a consideration on the project, the designer will need to be sure that sufficient data is available to allow the utility to be relocated or adjusted.
4. There are no right of way requirements on the project.
5. There is no change in the existing horizontal or vertical alignment.
6. There are no major special ditches on the project.
7. There are no major intersection modifications.
8. Show quantity of Excavation in Summary Box, but pay for as 1 Lump Sum.

Regular Excavation (RRR Projects Only) - Lump Sum can be used on projects other than RRR, but only if they are minor projects complying with the same listed guidelines.

Earthwork will be paid for as Borrow Excavation (Truck Measure) and Regular Excavation

(RRR Projects Only) – Lump Sum. The designer will calculate these quantities based on information obtained from the field and the proposed typical section. The designer must conduct a thorough field review to ensure existing field conditions are accurately reflected in earthwork estimates.

3.5.9 Summary of Earthwork

The last sheet in each group or cross section group (mainline, sidestreet, pond 1, etc.) should tabulate the totals for each earthwork operation (subsoil excavation, regular excavation and embankment).

Below is an example of a summary of earthwork box for projects with cross sections. The summary should document all the groups totals in one location. This summary should be shown on the Summary of Quantities Sheet.

**Exhibit 3-B Summary of Earthwork Box
 (Projects With Cross Sections)**

SUMMARY OF EARTHWORK (CUBIC YARDS)	
ROADWAY EXCAVATION, Mainline	10,000
ROADWAY EXCAVATION, Sidestreet Name	800
REGULAR EXCAVATION, Pond No. 1	1,005
REGULAR EXCAVATION, Lateral Ditches	5,000
TOTAL REGULAR EXCAVATION	16,805
EMBANKMENT, Mainline	20,000
EMBANKMENT, Sidestreet	7,000
TOTAL EMBANKMENT	27,000
SUBSOIL EXCAVATION, Mainline	2,080
SUBSOIL EXCAVATION, Sidestreet Name	1,100
TOTAL SUBSOIL EXCAVATION	3,180

Below is an example of a summary of earthwork box that should be used for projects with limited or no cross sections. This summary should be shown on the Summary of Quantities Sheet. The summary should show all quantities and adjustments.

**Exhibit 3-C Summary of Earthwork Box
(Projects With Limited or No Cross Sections)**

SUMMARY OF EARTHWORK (CUBIC YARDS)	
FILL	253
GUARDRAIL LOCATIONS	70
CROSS DRAINS	<u>100</u>
	423
FILL ADJUSTMENT (20%) (423 x 0.20)	<u>+ 85</u>
FILL	508
TRUCK ADJUSTMENT (25%) (508 x 0.25)	<u>+ 127</u>
TOTAL BORROW EXCAVATION	635
REGULAR EXCAVATION	200

The pay items used will be:

Regular Excavation (RRR Projects Only)	1 (LS)
Borrow Excavation (Truck Measure)	635 CY

Adjustment percentages shown are for example only. Contact District Materials or Construction Office for actual percentages to be used for each project.

Chapter 4

Roadside Safety

4.1	Clear Zone	4-1
4.1.1	Clear Zone Concept.....	4-1
4.1.2	Clear Zone Criteria.....	4-2
4.1.3	Roadside Ditches.....	4-4
4.2	Hazard Standards	4-6
4.2.1	Canal Hazards	4-6
4.2.2	Drop-off Hazards.....	4-9
4.3	Roadside Barriers	4-11
4.3.1	Warrants	4-11
4.3.2	Barrier Selection	4-12
4.3.3	End Treatments	4-12
4.3.4	Transitions	4-13
4.3.5	Placement.....	4-13
4.3.6	Upgrading Existing Barrier Systems	4-15
	4.3.6.1 Resetting Guardrail.....	4-16
4.4	Median Barriers.....	4-17
4.4.1	Warrants	4-17
4.4.2	Selection	4-17
4.4.3	End Treatments	4-17
4.5	Crash Cushions.....	4-19
4.5.1	Warrants	4-19
4.5.2	Selection	4-19
4.5.3	Design.....	4-20

4.6	Roadside Appurtenances	4-21
4.6.1	Sign Supports	4-21
4.6.2	Mailbox Supports	4-21
4.6.3	Other Appurtenances	4-21
4.6.4	Location Criteria	4-21
4.6.5	Bus Benches and Transit Shelters.....	4-21
4.7	Non-Standard Roadside Safety Devices.....	4-22

Tables

Table 4.3.1	Minimum Offset of Barriers (Measured from the face of the barrier).....	4-14
-------------	---	------

Figures

Figure 4.1.2.1	Clear Zone Plan View	4-2
Figure 4.1.2.2	Clear Zone Cross Section	4-3
Figure 4.1.3.1	Roadside Ditch “Vee” Shape.....	4-4
Figure 4.1.3.2	Roadside Ditch “Trapezoidal” Shape	4-5
Figure 4.2.2	Drop-off Hazards in Urban Sections	4-9
Figure 4.3.1	Placement of Curb-Guardrail Combinations	4-15

Exhibits

Exhibit 4-A	Minimum Standards for Canal Hazards (Rural and Urban Flush Shoulders)	4-7
Exhibit 4-B	Minimum Standards for Canal Hazards (Urban Curb or Curb and Gutter).....	4-8

Chapter 4

Roadside Safety

4.1 Clear Zone

4.1.1 Clear Zone Concept

A roadside that is traversable and unobstructed by fixed objects will allow vehicles that leave the roadway to recover safely. The clear zone is the relatively flat unobstructed area that is to be provided for safe use by errant vehicles. The designer should provide as much clear zone as practical.

If natural or man-made hazards, including slopes steeper than 1:3, occur within the clear zone, the designer should attempt the following treatments, in order of priority:

1. Eliminate the hazard.
 - a. Remove the hazard.
 - b. Relocate the hazard outside the clear zone.
 - c. Make the hazard traversable or crashworthy.
2. Shield the hazard with a longitudinal barrier or crash cushion. This treatment should only be taken if the barrier or crash cushion presents a lesser hazard.
3. Leave the hazard unshielded. This treatment should be taken only if a barrier or crash cushion is more hazardous than the hazard, if the likelihood of striking the hazard is very small or if the expense of treatment outweighs the benefits in terms of crash reduction.

If crash data or safety reports indicate that early treatment of the hazards will result in fewer or less severe crashes, designers should consider directing that those treatments be accomplished as the first order of work, if feasible and practical.

4.1.2 Clear Zone Criteria

The clear zone must be wide enough so that the sum of all the recoverable terrain within is equal to or greater than the recoverable terrain value obtained in the appropriate **Table 2.11.11**, **Table 21.5** or **Table 25.4.14.1**. The process for determining the clear zone width is to extend the clear zone width as shown in **Figure 4.1.2.1** and **4.1.2.2** until the recoverable terrain is obtained. If non-recoverable terrain is encountered before obtaining the full amount of recoverable terrain, then the remaining amount must be provided beyond the non-recoverable terrain. Where right of way permits, the portion of recoverable terrain provided beyond the non-recoverable terrain must be a minimum of 10 feet. The clear zone is to be free of hazardous objects, hazardous terrain, and non-traversable terrain. Also, clear zones may be widened based on crash history.

Figure 4.1.2.1 Clear Zone Plan View

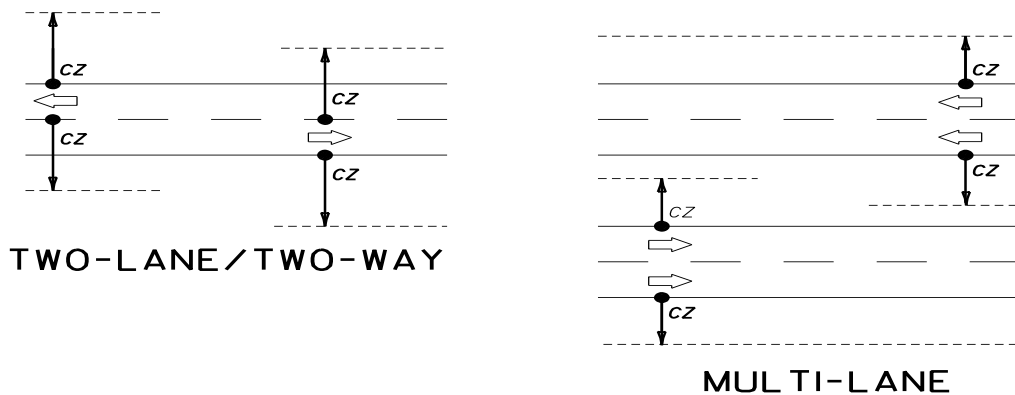
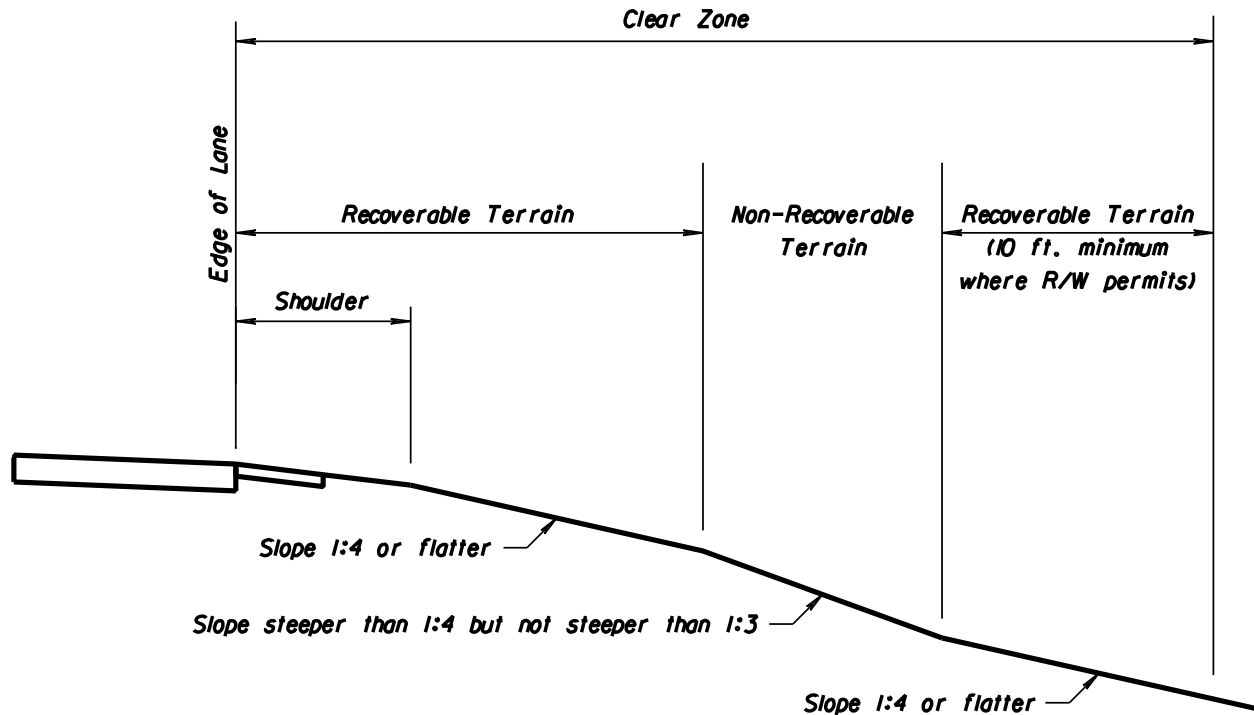

Figure 4.1.2.2 Clear Zone Cross Section



Note: See **Chapter 2, Table 2.4.1** for new construction slope criteria.

See **Chapter 25, Section 25.4.9** for RRR slope criteria.

Roadside Terrain includes all surfaces along the roadway other than Travel Lanes, Auxiliary Lanes, and Ramps. For the purpose of establishing Clear Zones, Roadside Terrain is defined as recoverable, non-recoverable, non-traversable, and hazardous as follows:

1. Recoverable when it is safely traversable and on a slope that is 1:4 or flatter.
2. Non-recoverable when it is safely traversable and on a slope that is steeper than 1:4 but not steeper than 1:3.
3. Non-traversable when it is not safely traversable or on a slope that is steeper than 1:3.
4. Hazardous when a slope is steeper than 1:3 and deeper than 6 feet.

4.1.3 Roadside Ditches

Roadside ditches within the clear zone shall conform to the acceptable channel cross section criteria as shown in either **Figure 4.1.3.1** or **Figure 4.1.3.2**, as applicable. These roadside ditch configurations are considered traversable as shown in the **AASHTO Roadside Design Guide**. See the **AASHTO Roadside Design Guide** for further information.

Figure 4.1.3.1 Roadside Ditch “Vee” Shape

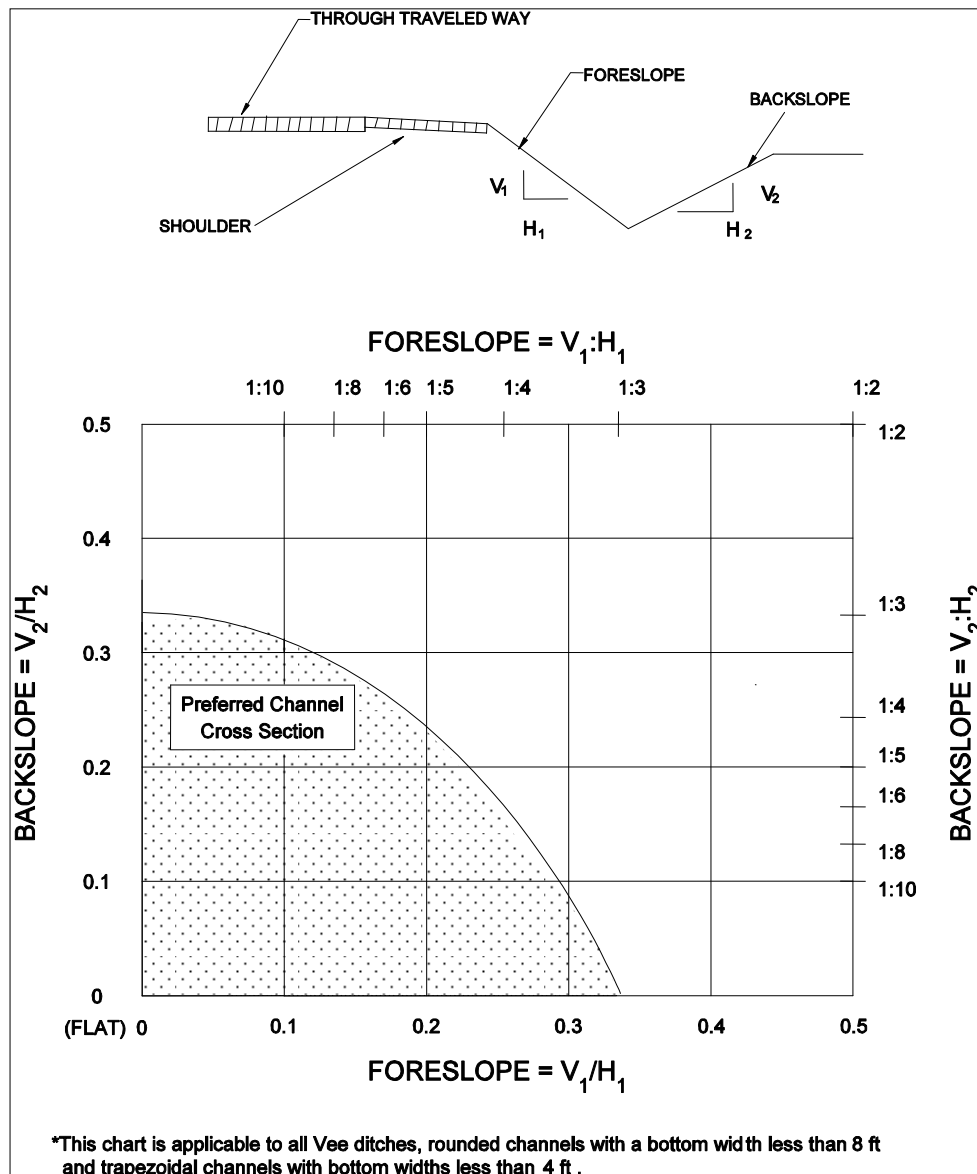

*This chart is applicable to all Vee ditches, rounded channels with a bottom width less than 8 ft and trapezoidal channels with bottom widths less than 4 ft.

(Ref: **Figure 3.6 – 2006 AASHTO Roadside Design Guide**)

Figure 4.1.3.2 Roadside Ditch “Trapezoidal” Shape

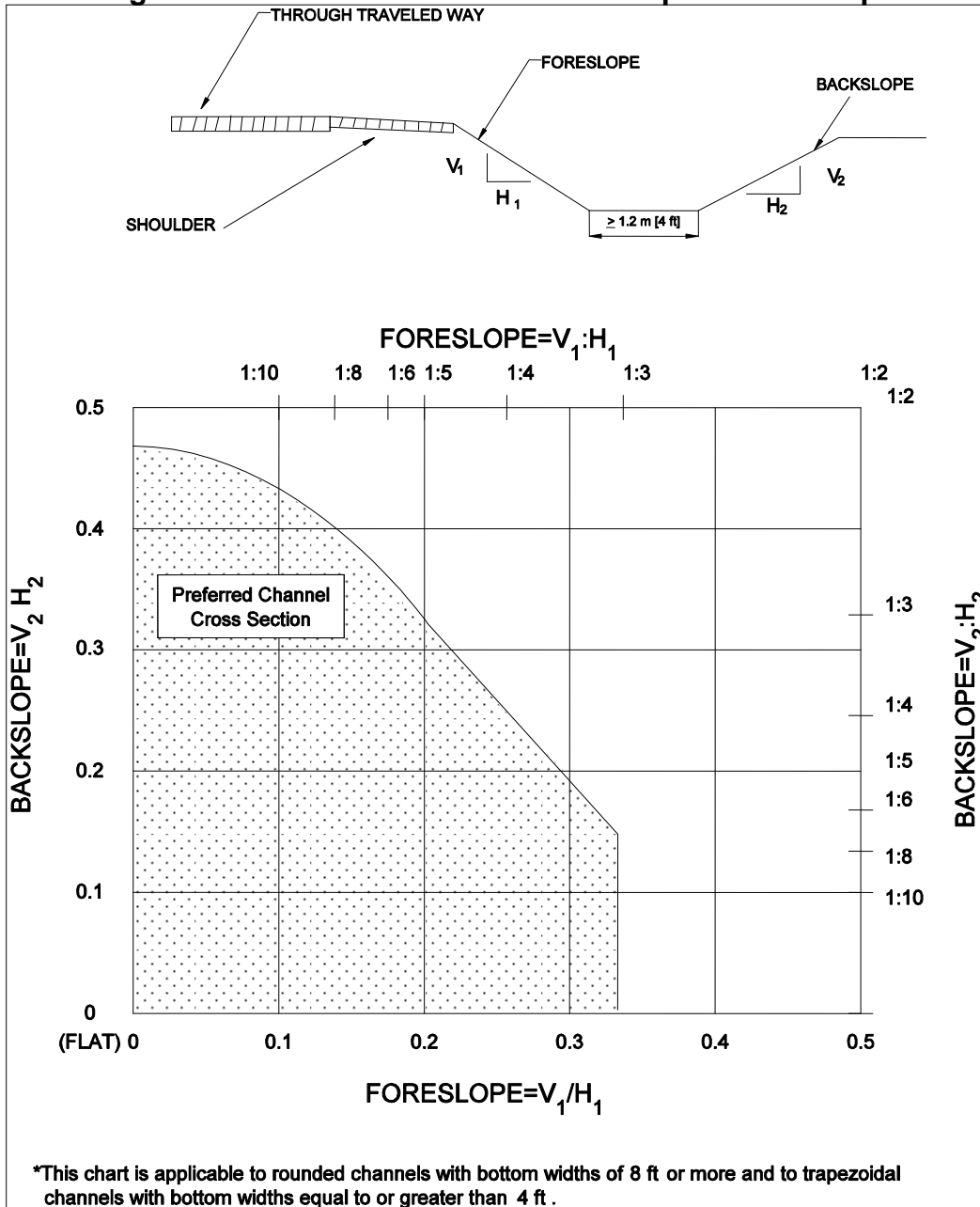

(Ref: **Figure 3.7 – 2006 AASHTO Roadside Design Guide**)

4.2 Hazard Standards

4.2.1 Canal Hazards

A canal is defined as an open ditch parallel to the roadway for a minimum distance of 1000 ft. and with a seasonal water depth in excess of 3 ft. for extended periods of time (24 hours or more).

For rural and urban flush shoulder highways, the distance from the outside edge of the through travel lane to the top of the canal side slope nearest the road will be no less than 60 ft. for highways with design speeds of 50 mph or greater. For highways with design speeds less than 50 mph this minimum distance may be reduced to 50 ft. for rural and urban flush shoulder highways or 40 ft. for urban curb or curb and gutter highways. When new canal or roadway alignment is required, distances greater than those above should be provided, if possible, to accommodate possible future improvements to the roadway (widening, etc.).

On fill sections, a flat berm (maximum 1:10 slope) of width no less than 20 ft. will be provided between the toe of the roadway front slope and the top of the canal side slope nearest the roadway. This minimum berm width applies to all types of highways, both rural and urban construction. (See **Exhibits 4-A & 4-B**)

When the slope between the roadway and the "extended period of time" water surface is 1:6 or flatter, the minimum distance can be measured from the edge of the through lane to the "extended period of time" water surface and a berm is not required.

In sections with ditch cuts, 20 ft. will be provided between the toe of the front slope and the top of the canal.

Guardrail or other protective devices shall be installed 5 ft. from the canal front slope where it is not possible to meet the above minimum criteria. The design is complicated when clear zone and slope criteria are combined with canal hazard criteria. Extreme caution must be taken to ensure that all criteria are met.

If the minimum standards for canal hazards cannot be met, then the standard guardrail treatments as provided in the **Design Standards** should be used.

Exhibit 4-A Minimum Standards for Canal Hazards (Rural and Urban Flush Shoulders)

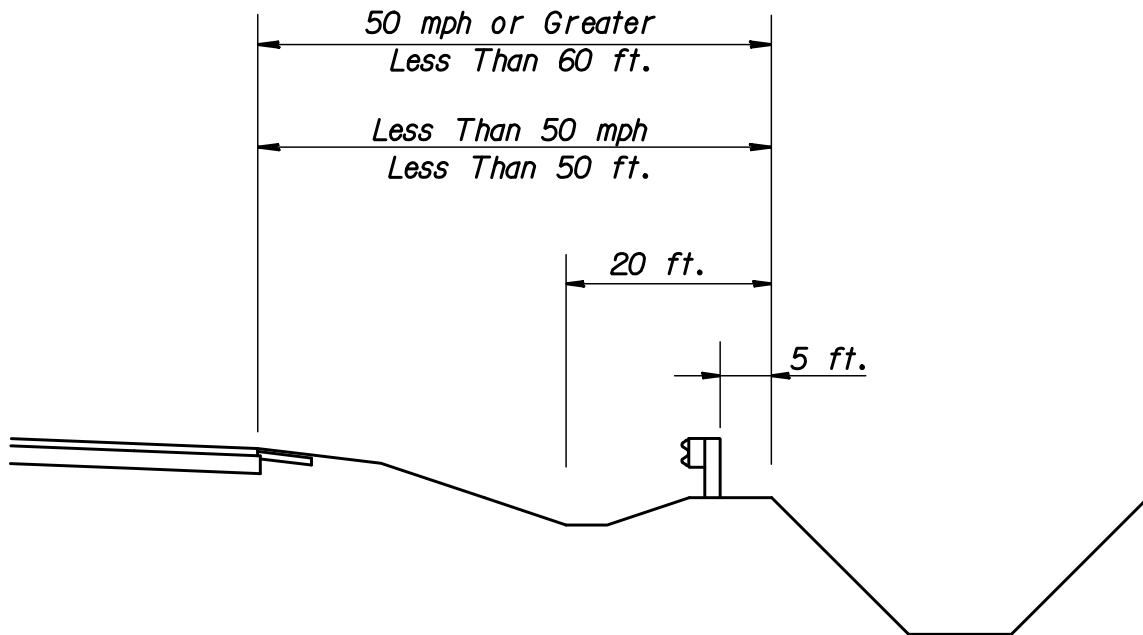
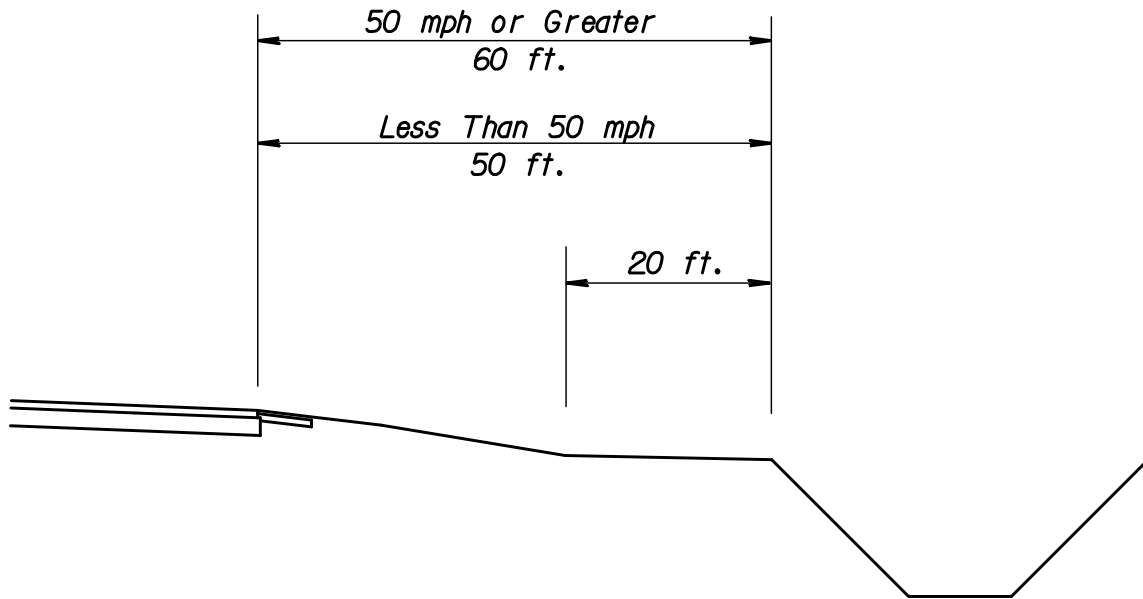

**Exhibit 4-B Minimum Standards for Canal Hazards
(Urban Curb or Curb and Gutter)**

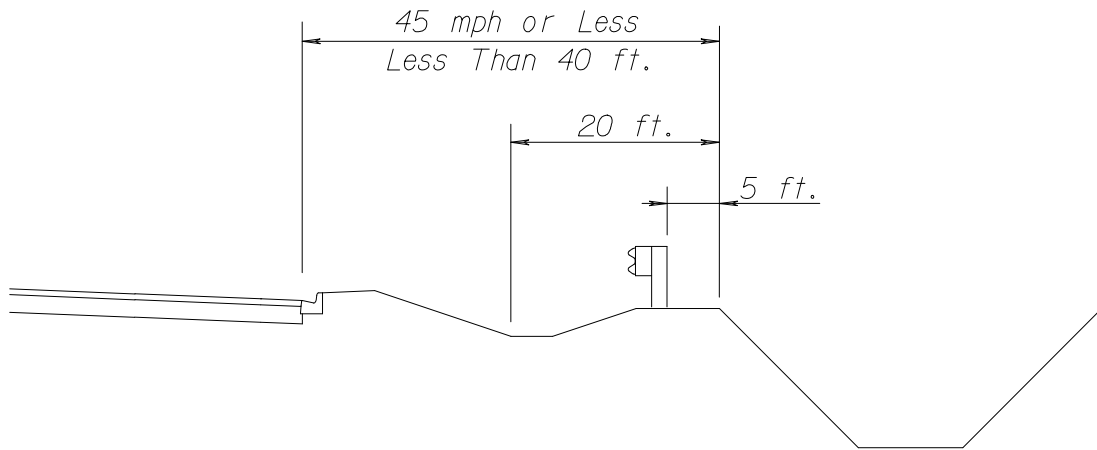
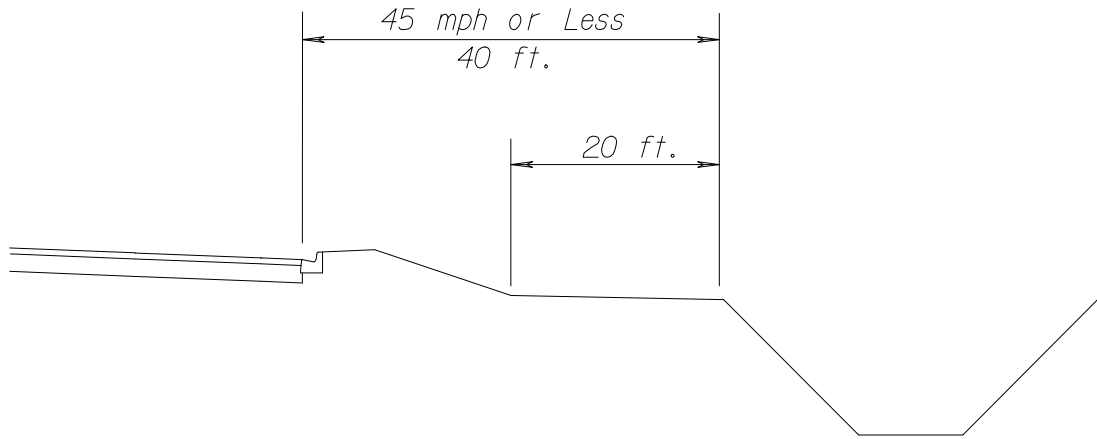

4.2.2 Drop-off Hazards

Drop-off hazards are defined as steep or abrupt downward slopes that can be perilous to vehicle occupants and/or pedestrians and cyclists. The Engineer should consider shielding any drop-off determined to be a hazard. The following guidelines will be useful in standardizing the identification and treatment of drop-off hazards.

Drop-off hazards for vehicle occupants:

- 1 A drop-off of 6 feet or more with a slope steeper than 1:3 should be considered a hazard and shielded when it is within the Clear Zone.
- 2 In urban sections with curb or curb and gutter (Design Speed \leq 45 mph), a drop-off of 6 feet or greater with a slope steeper than 1:3 located within 22 feet of the traveled way, should be evaluated for shielding.

Figure 4.2.2 Drop-off Hazards in Urban Sections

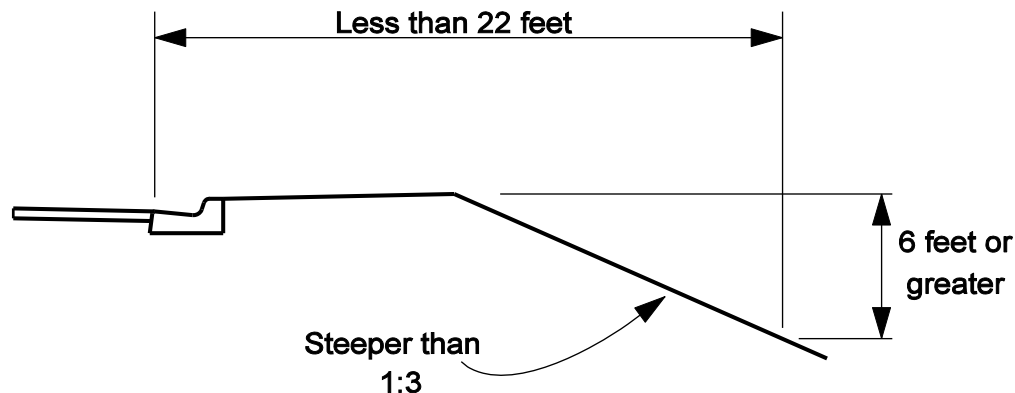

In determining if shielding a drop-off hazard would be feasible for protecting vehicle occupants, the following should be considered:

1. When a drop-off is shielded, a guardrail or barrier is usually set closer to the road, which increases the probability of impacting the guardrail or barrier. These shields generally require the ends to be treated, which also needs to be taken into consideration. Refer to **Section 23.5** of this volume for guidance on evaluating the benefits of shielding a drop-off.

2. When a drop-off is to be shielded with guardrail, a minimum of 62.5 feet of guardrail is required to develop proper ribbon strength. A minimum clear area 4 feet wide is to be provided behind the guardrail to allow the guardrail to deflect when impacted. Proper slope and soil bearing for the posts is to be provided.
3. Another consideration is whether the drop-off has a significant crash history. Drop-offs that have had 3 crashes within three consecutive years over a five-year period are considered to have a significant crash history and should be shielded. Five years of crash data for a particular site can be obtained from the Safety Office.

For drop-off criteria in work zones see **Chapter 10** of this volume and **Index 600** of the **Design Standards**.

Generally, pedestrians and bicyclists will be adequately protected from a drop-off hazard if a guardrail or barrier has been installed between the path or sidewalk and the drop-off. However, circumstances do exist that will ultimately dictate when a handrail is needed. For guidance, see **Section 8.8 Drop-off Hazards for Pedestrians and Bicyclists** of this volume.

4.3 Roadside Barriers

4.3.1 Warrants

Roadside barriers are warranted when hazards exist within the clear zone, hazards cannot be cost effectively eliminated or corrected, and collisions with the hazards will be more serious than collisions with the barriers.

The length of advancement and length of need necessary to properly shield the hazard must be determined on an installation by installation basis as indicated in the ***Design Standards***.

The following conditions within the clear zone are normally considered more hazardous than a roadside barrier:

1. Fill slopes steeper than 1:3.
2. Bridge piers, abutments and railing ends.
3. Non-traversable culverts, pipes and headwalls.
4. Non-traversable parallel or perpendicular ditches and canals.
5. Bodies of water other than parallel ditches and canals that the engineer determines to be hazardous.
6. Parallel retaining walls with protrusions or other potential snagging features.
7. Retaining walls at an approach angle with the edge of pavement larger than 7 degrees (1:8).
8. Non-breakaway sign or luminaire supports.
9. Trees greater than 4 inches in diameter measured 6 inches above the ground at maturity.
10. Utility poles.
11. Rigid protrusions above the ground in excess of 4 inches in height.

In addition to the above hazards, there may be other situations that warrant barrier consideration, such as nearby pedestrian or bicycle facilities, schools, residences or businesses.

4.3.2 Barrier Selection

Acceptable standard roadside barriers are detailed in the *Design Standards*. They include:

1. Blocked-out W-beam (strong post).
2. Blocked-out thrie-beam (strong post).
3. Modified thrie-beam (strong post).
4. Concrete barrier wall.

Most guardrail installations will be blocked-out W-beam on wood or steel posts. The thrie-beam guardrail should be considered when additional rail depth is needed because of a potential to under-ride the rail or because additional height may be needed. Other barrier designs may be required by specific site conditions. These must be called for and detailed on a project-by-project basis.

4.3.3 End Treatments

Longitudinal barrier ends which are not crashworthy can present serious hazards if they terminate within the clear zone. The Department's crashworthy end treatments and application criteria are detailed in the *Design Standards*. Other end treatments may be required under special circumstances. Special details will be required in the plans, when this is the case.

1. It is very important that the flare with offset be provided exactly as shown in the *Design Standards*. The end offset should be measured off a projection of the face of guardrail alignment. The maximum allowable cross slope in front of the rail is 1:10, including the area in front of and the upstream approach to the end anchorage assembly.
2. Non-crashworthy end treatments will be used outside the clear zone, and at downstream terminations, which are outside the clear zone of the opposing traffic flow. The Type II end anchorage is non-crashworthy and, therefore, may **NOT** be used as an approach terminal end treatment unless other end shielding is provided.
3. Thrie-beam and concrete barrier wall will be terminated as shown in the *Design Standards*.

4.3.4 Transitions

Whenever standard W-beam or thrie-beam guardrail transitions into bridge rail or concrete barrier wall, a transition section is necessary. Transitions must include sound structural connections, nested beams and additional posts for increased stiffness, as shown in the **Design Standards**. Standard flares should be introduced upstream of the transition section. Care must be taken in the details of the junction of the two barrier types to avoid snag points.

4.3.5 Placement

The primary design factors associated with guardrail placement are:

1. Lateral offset from the edge of pavement
2. Terrain effects
3. Flare rate
4. Length of advancement
5. Length of need

The standard offset is the shoulder width plus 2 ft., not to exceed 12 feet. Alternate guardrail offset locations are shown in the **Design Standards**.

A 2 ft. distance from the back of the barrier posts to the shoulder line or slope break is desirable for post support.

The length of advancement is dependent on the design speed, the offset distance to the face of guardrail and the lesser distance (a) to the back of the hazard or (b) to the clear zone needed. The designer must establish this advancement need for all installations on the project. On all facilities the guardrail needs must consider traffic from both directions.

A barrier should not be located so close to the hazard that it is shielding that the hazard is within the dynamic deflection distance of the barrier. The dynamic deflection of standard barriers is shown in **Table 4.3.1**.

**Table 4.3.1 Minimum Offset of Barriers
 (Measured from the face of the barrier)**

BARRIER TYPE	OFFSET (ft.)
W-Beam with Post Spacing @ 6'-3"	4.0
W-Beam with Post Spacing @ 3'-1½"	3.0
Thrie-Beam with Post Spacing @ 6'-3"	3.3
Thrie-Beam with Post Spacing @ 3'-1½"	2.6
Barrier Wall	0*
Double W-Beams (Nested) with Post Spacing @ 3'-1½"	2.6
Double W-Beams (Nested) with Post Spacing @ 1'-6¾"	2.3
Double Thrie-Beams (Nested) with Post Spacing @ 3'-1½"	2.3
Double Thrie-Beams (Nested) with Post Spacing @ 1'-6¾ "	2.0

* Except where specifically provided for in the Design Standards, hazards that extend above the top of a barrier wall shall be offset a minimum 1.5' from the face of the top edge of F-shape barrier, and a minimum 2.0' from the face of vertical shape barrier.

NCHRP Report 537 titled “**Recommended Guidelines for Curb and Curb-Barrier Installations**” provides acceptable placement of curb-guardrail combinations as a function of the lateral offset from the guardrail and the operating speed of the roadway. The application of these guidelines for use on FDOT roadways is contained in the design chart shown in **Figure 4.3.1**.

As shown in the design chart, there is a region between 0 and 8.2 ft behind the face of the curb where guardrail should not be located. For the general case of vehicles leaving the roadway with a broad range of speeds and angles, the bumper is likely to be too high for acceptable guardrail performance in this region. In addition, higher speeds create more suspension system disturbance and; therefore, require more time and distance for the bumper to return to the correct position.

The standard single W-beam guardrail installation (**Design Standards, Index 400**) was tested in this study. Other rails and barrier types (thrie beam, vertical face barrier wall, etc.) were not tested, however may be considered in areas where the W-beam is not considered acceptable.

Barriers should not be placed on slopes steeper than 1:10. This is particularly important for barrier ends shielded by crashworthy devices.

Figure 4.3.1 Placement of Curb-Guardrail Combinations

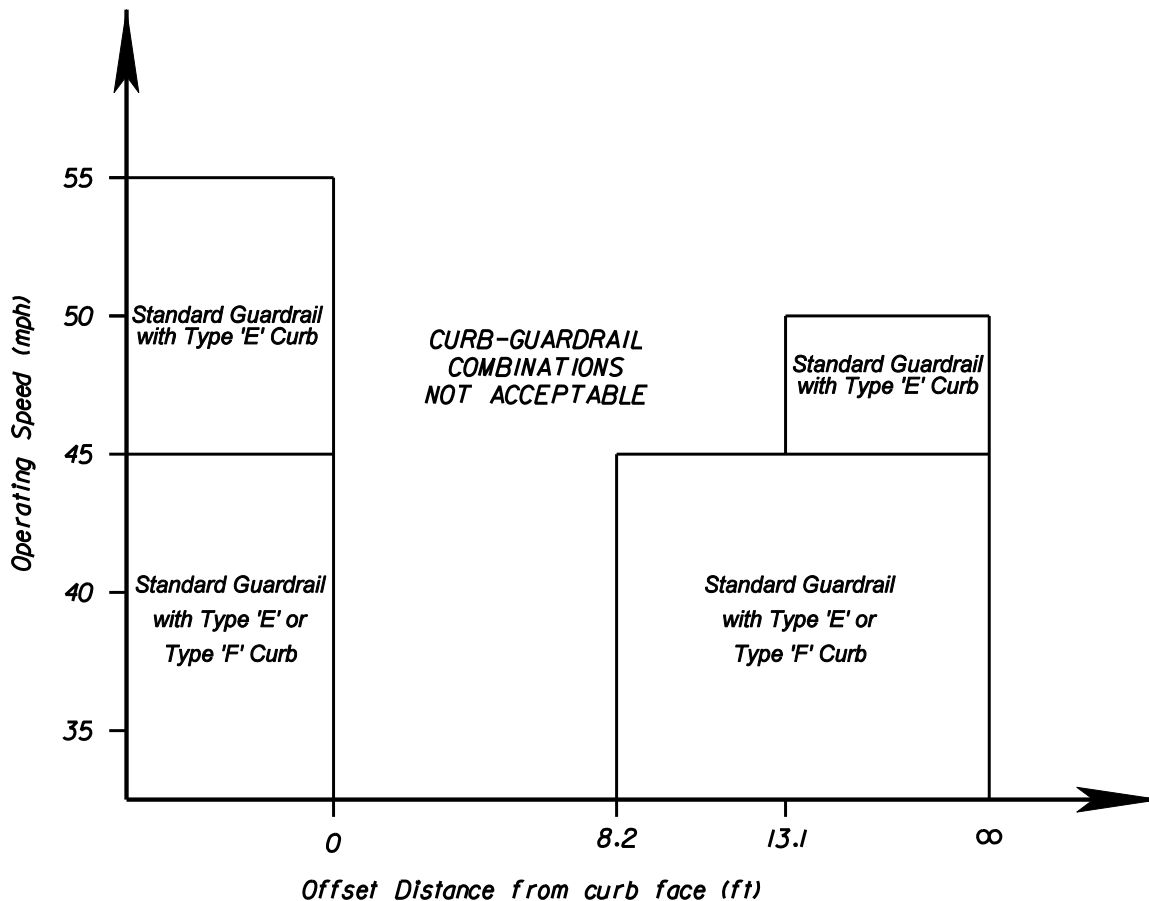

4.3.6 Upgrading Existing Barrier Systems

Deficient roadside barriers are generally upgraded in conjunction with other roadway work, such as RRR projects, or through spot or system wide safety improvement projects. In each case the designer must determine the scope and extent of the barrier upgrading to be accomplished. In making this determination, the existing installation should be investigated for what work is necessary to make the installation structurally and functionally adequate. The investigation should consider:

1. Whether there is a need for the barrier. If cost effective, the hazard should be removed, relocated, or redesigned and the barrier removed.

2. Length of need.
3. Proper rail height.
4. Proper flare rate.
5. Adequate offset at terminal end.
6. Proper deflection distance between the barrier and the shielded object.
7. Proper placement with respect to traffic lane.
8. Proper placement with respect to curb.
9. Placement on proper slope.
10. Adequate clear zone area behind yielding terminals.
11. The overall condition of the guardrail/barrier installation.
12. Post type, condition and spacing.
13. Existing unshielded hazards. For spot improvements, only those existing unshielded hazards in the immediate vicinity of the installation being addressed should be reviewed. For RRR projects, all existing roadside hazards within the project corridor should be reviewed for treatment needs.

In some cases the deficiencies will be so obvious that the best course of action is readily apparent. However, many times the deficiencies may be marginal and a decision on the scope and extent of the barrier upgrading will be based on engineering judgment. Factors which should be considered are:

1. Nature and extent of barrier deficiency.
2. Past crash history.
3. Cost effectiveness of recommended improvement.
4. Whether future scheduled reconstruction or RRR work in the 5 year work program will address deficiency.

4.3.6.1 Resetting Guardrail

For those projects that include the resetting of guardrail, refer to the **Standard Specifications**, the **Basis of Estimates Manual**, and the **Design Standards** for pay items, notes and quantity calculations.

4.4 Median Barriers

4.4.1 Warrants

A median barrier shall be provided on Interstate and expressway facilities where reconstruction reduces the median width to less than the standard for the facility. No variations or exceptions to this criterion will be approved.

On Interstate and expressway projects, crashes that occurred in the most recent 5-year period within the limits of 1 mile prior to the exit ramp gore to 1 mile beyond the entrance ramp gore shall be reviewed. If 1 or more are determined to be across median crashes, shielding within this area shall be provided. Outside these areas, the District may provide shielding after reviewing the most recent 5-year crash history.

4.4.2 Selection

The same barrier types as discussed in **Section 4.3.2** are available as median barriers. In general, the concrete barrier wall is preferable in narrow medians. Where deflection space is adequate, either a double face guardrail or single face guardrail on each side may be used. See the *Design Standards* and the *AASHTO Roadside Design Guide* for additional guidance.

4.4.3 End Treatments

Median barriers can be terminated with any of the treatments discussed in **Section 4.3.3**.

THIS PAGE LEFT BLANK INTENTIONALLY

4.5 Crash Cushions

Crash cushions are attenuating devices that may be non-redirective or redirective.

4.5.1 Warrants

Hazards within the clear zone, that present a more serious collision potential than a crash cushion, warrant the installation of a crash cushion.

4.5.2 Selection

Various types of crash cushions and attenuation devices approved for use on Department projects can be found on the Qualified Products List (QPL). Detailed information about these systems is provided in the **Design Standards**, approved QPL drawings, and in each manufacturer's publications. Each system has its own unique physical and functional characteristics. The designer shall indicate in the plans either the specific system to be used at each location, or the options that may be used when one or more crash cushion system is suitable at a given location (in accordance with **Design Standards, Index 430**). The design engineer shall consider the following factors when selecting a system for a particular location:

1. Site characteristics.
2. Structural and safety characteristics of candidate systems.
3. Initial and replacement/repair costs.
4. Expected frequency of collisions.
5. Maintenance characteristics.

Site characteristics and economics dictate the crash cushion selection. Sand barrels are relatively low in initial cost, but usually must be completely replaced when struck, so are more appropriate in locations with a low likelihood of collision. There are a number of other systems that have higher initial costs but can be repaired after collisions relatively quickly and inexpensively, so are more appropriate where frequent collisions are expected. The ability of maintenance forces to perform routine maintenance and to place a crashed system back into service quickly should be a major consideration. Crash cushions that require stocking unusual and expensive parts or that are complex to replace should not be selected.

A pay item has been established for Optional Permanent Crash Cushions, (2)544-75-40, beginning with the January 2006 letting. This pay item is applicable ONLY for crash cushions

being used to shield the ends of standard concrete barrier wall, standard W-beam guardrail, or thrie-beam guardrail. Use of this pay item for these locations is not mandatory. The designer may still call for a specific system brand and use the corresponding pay item. However, the reasons for restricting to a specific brand must be documented in the project design file. For crash cushions used to shield hazards other than standard concrete barrier wall, standard W-beam guardrail, or thrie-beam guardrail, designers must continue to identify the specific system to be used and use the corresponding pay item, as has been done in the past.

The Optional Crash Cushion pay item is to be used in conjunction with **Design Standards, Index 430**. **Index 430** includes crash cushion length information for each of the crash cushion systems approved for use under this pay item. Designers should note that certain crash cushion options may have lengths that do not provide the proper length of need, and others may have lengths that exceed the available space at a given location. These should be eliminated from the list of options shown in the plans.

4.5.3 Design

Standard details of systems listed on the QPL for typical installations shielding guardrail ends and barrier wall ends can be found in the **Design Standards** and approved QPL drawings. In addition, some of these systems have standard details for shielding wide hazards. For non standard applications, crash cushion suppliers normally provide design assistance for their systems. Special designs should be based on providing performance meeting NCHRP 350 crash test criteria for the established design speed of the facility. For special designed inertial systems where the **AASHTO Roadside Design Guide** charts are used, the maximum average deceleration level should not exceed approximately 7 g's.

All terrain within the likely approach of a vehicle should be relatively flat. An impacting vehicle should strike the unit at normal height, with the vehicle's suspension system neither collapsed nor extended. Curbs exceeding 4 inches in height shall not be used in the approach area of a crash cushion.

Care must be taken that the design of a crash cushion system does not create a hazard to opposing traffic.

The nose of all crash cushions shall be delineated with reflective material or standard object markers, as indicated in the **Design Standards**.

For additional guidance on the selection of crash cushions for temporary use in work zones, see **Chapter 10**.

4.6 Roadside Appurtenances

4.6.1 Sign Supports

All sign supports, except overhead cantilever, truss type or bridge or barrier wall mounted, shall be breakaway as defined in the ***AASHTO Standard Specifications for Structural Supports for Highway Signs, Luminaires and Traffic Signals*** and the ***AASHTO Roadside Design Guide***. Sign supports shall be of an acceptable and crashworthy design as described in the ***Design Standards***. Supports not meeting the breakaway criteria should not be installed within the clear zone. Sign supports not meeting these requirements, that must be installed within the clear zone, shall be protected by a barrier or crash cushion.

4.6.2 Mailbox Supports

Mailbox supports shall be of an acceptable crashworthy design, as described in the ***Design Standards***.

4.6.3 Other Appurtenances

The ***Design Standards*** contains design criteria for numerous other roadside appurtenances.

4.6.4 Location Criteria

Most breakaway mechanisms are designed to be impacted at bumper height, typically about 20 inches above the ground. If impacted at a significantly higher point, the bending moment in the breakaway base may be sufficient to bind the mechanism, resulting in non-activation of the breakaway device. For this reason, it is important that breakaway supports not be located in ditches or on steep slopes where a vehicle is likely to be partially in sprung suspension at the time of impact.

4.6.5 Bus Benches and Transit Shelters

Refer to ***Table 2.11.9*** for criteria on the placement of shelters and benches.

4.7 Non-Standard Roadside Safety Devices

The Qualified Products List (QPL) includes proprietary devices and products that have been evaluated against implemented FDOT Specifications and Standards, and found to meet those Specifications and/or Standards. The majority of proprietary roadside safety devices needed for use on the State Highway System are identified on the QPL. However, just as FDOT Specifications and Standards do not address every potential highway need, the QPL does not cover every type of roadside safety device that may be available on the market. Unique situations will sometimes require unique devices. Examples of available devices that are not covered by FDOT Specifications and Standards include barrier wall gates, aesthetic guard rails, temporary steel barriers, crashworthy stop gates, and others. When the need arises for a unique crashworthy device not covered on the QPL, the designer must carefully investigate the applicability of the device for the situation, as well as the crash performance characteristics of the device. For some of these devices, the State Roadway Design Office may have information and be of assistance in establishing the appropriateness of the device for a given situation.

The designer must document the following:

1. FHWA Acceptance Letter
2. Crash Test Reports, including review of all test results. All performance characteristics must be reviewed, including post impact vehicle behavior and post impact test article deflection, debris scatter, etc.
3. Compatibility with adjacent and/or connecting standard roadside safety devices.
4. Maintenance requirements and characteristics, including coordination with the District Maintenance Office.
5. For devices such as barrier gates, operational plans and training as appropriate.

The designer will also be responsible for providing special plan details, technical specifications, and method of pay as appropriate.

Chapter 5

Utilities

5.1	General	5-1
5.2	Utility Accommodation Manual.....	5-2
5.3	Location of Existing Utilities	5-3
5.3.1	Quality Levels of Utility Locates	5-3
5.4	Subsurface Utility Engineering	5-5
5.5	Coordination Process.....	5-6

THIS PAGE LEFT BLANK INTENTIONALLY

Chapter 5

Utilities

5.1 General

The Department has the responsibility to maintain state highways as necessary to preserve the integrity, operational safety and function of the highway facility. Since the manner in which utilities cross or otherwise occupy highway right of way can materially affect the safe operation, maintenance and appearance of the highway, it is necessary that such use of the right of way be authorized and reasonably regulated. By Florida Statutes, utilities, whether public or privately owned, aerial or underground are permitted by the Department to be accommodated within the right of way on the State Highway System. For limited access highways, parallel utilities within the right of way are not allowed except for utilities serving facilities required for operating the transportation system or by approved utility exception (for Limited Access R/W Use). Lateral crossings on limited access facilities are allowed by permit only. (See ***Utility Accommodation Manual, Topic No. 710-020-001***).

The designer should make every reasonable effort to design a project that will accommodate all existing utilities and new utilities to be constructed concurrently with the project. The selection of typical section features, horizontal alignment and location of storm drain lines are areas that can sometimes be varied without violating safety standards and design criteria. Design features that reduce or avoid utility conflicts may involve increased cost; however, those costs may be offset by savings in construction time and the total associated cost savings for the FDOT project and the utilities. The use of Subsurface Utility Engineering is promoted to best facilitate utility related cost savings.

Selection of the methods to be employed within the Subsurface Utility Engineering (SUE) discipline should be considered in the scoping process. Relying totally on designating and selectively exposing utility facilities will seldom prevent all utility related delays in construction nor will it prevent the need for redesign. Consulting a state of the art SUE provider early on is the best way to determine the most cost effective approach. Determining the location of utilities when they are great in number or are in intersections is the most problematic and risk prone area within a project. These areas especially lend themselves to being candidates for newer technology locating services because they can reflect changes in shape and alignment not seen with traditional methods. The data gathering process can be less disruptive to the facility user and is non-destructive. A knowledge of potentially limiting environmental conditions is essential to the process. No single method is cost effective when risk versus benefit is measured.

The **Utility Accommodation Manual (UAM)** shall be used for all detailed requirements of utility issues. The **UAM** is the controlling legal document for criteria and standards to be applied to utilities. The **UAM** may not be updated on the same frequency as the **PPM**. Where differences occur between the **UAM** and the **PPM**, the **UAM** controls. New Utility installations shall comply with the latest UAM requirements. When evaluating Utility compliance, the date of the permit establishes which UAM requirements must be met. The Designer/Project Manager should always determine which criteria are appropriate before directing a Utility/Agency Owner (UAO).

5.2 Utility Accommodation Manual

UAOs are required to obtain utility permits for the installation and maintenance of utility facilities within the right of way of any State Highway System. These permits will be issued and approved by FDOT in conformity with the **Utility Accommodation Manual**. This includes utility work required by FDOT projects. The designer may be involved in the coordination of this process.

The Department's **Utility Accommodation Manual** is established to regulate the location, manner, installation and adjustment of utility facilities along, across, under or on right of way under the jurisdiction of the FDOT. This manual also establishes the process for issuing permits for such work which is in the interest of safety, protection, utilization and future development of the highways with due consideration given to public service afforded by adequate and economical utility installations as authorized under **Section 337.403, Florida Statutes** and **Florida Administrative Code Rule 14-46.001**. Adherence shall be required under the circumstances set forth in the **Utility Accommodation Manual**.

Additional guidance for accommodating utilities within the highway rights of way are given in the AASHTO publications **A Guide for Accommodating Utilities within Highway Right of Way** and **A Policy on Geometric Design of Highways and Streets** and in the TRB publication **Policies for Accommodation of Utilities on Highway Rights-of-Way**.

5.3 Location of Existing Utilities

Determining the location of existing utilities on State highway right of way is a cooperative effort between the FDOT and the UAOs. The degree of effort on the part of the FDOT and the UAOs will vary with the type of project, the utility, and availability of existing location information. As a minimum the location of existing major utilities is required on new construction, reconstruction, and add lane projects.

Major existing utilities are those principal underground and aerial utilities that potentially conflict with construction activities and scheduling. The presence of major utilities shall be determined on each project by the UAOs. Service connections and laterals are not normally considered major utilities.

It is the responsibility of the design engineer with the assistance of the District Utility Office and construction personnel to determine the locations and levels of locate where utility information is needed. Quality levels of locates are identified in **Section 5.3.1**. It is the responsibility of the UAOs to provide up through a Quality Level “B” locate on request. In some instances the UAOs can provide Quality Level “A” locate information. If Quality Level “A” locate information is necessary and cannot be provided by the UAOs, the measurement and documentation for the Quality Level “A” locate will be obtained by the FDOT, consultants, or others by established agreement.

Existing major underground utilities which are suspected to be located within three feet (3') of proposed construction operations which would threaten the utility should be considered for Quality Level “A” locate information. The decision to allow utilities to remain within three feet (3') of new construction operations should be made by the Design Engineer in consultation with the District Utility Office and appropriate construction personnel.

5.3.1 Quality Levels of Utility Locates

The following identifies the quality levels about which Subsurface Utility Engineering is applied.

1. Quality Level “D” - Existing Records
2. Quality Level “C” - Surface Visible Feature Survey
3. Quality Level “B” - Designating
4. Quality Level “A” - Locating

A detailed description of the scope of work to be included to achieve the various quality levels can be found in the ***Utility Accommodation Manual***.

5.4 Subsurface Utility Engineering

Subsurface utility engineering (SUE) is more than an established engineering technology that can provide horizontal and vertical locations of underground utilities to produce an accurate picture of underground infrastructure. It is a branch of engineering practice that involves managing certain risks associated with utility mapping at appropriate quality levels, utility coordination, utility relocation, design and coordination, utility condition assessment, communication of utility data to concerned parties, utility relocation cost estimates, implementation of accommodation policies and utility design.

The scope of services and level of effort is established in the quality levels of information to be provided. The quality level is a professional opinion of the quality and reliability of utility information desired or provided. Each of the four established quality levels is established by different methods of data collection and interpretation.

5.5 Coordination Process

Coordination between the Department and the UAOs is to be accomplished throughout the design process through the District Utility Office. Refer to **Chapters 13** through **16** of this volume for the design and review processes. For requirements on conflicts and permits, see the **Utility Accommodation Manual**.

External agency coordination may also be required when utility issues impact other agency agreements regarding permits or plans reviews.

If during the plans design process it is determined that a domestic potable water supply line **must** pass through a storm drain structure, the State Department of Environmental Protection (DEP) Drinking Water Program Administrator in Tallahassee must be notified. Refer to **Design Standards Index 307** for accepted methods of addressing conflicts. To be submitted along with the notification shall be the design plans showing the conflict, and justification describing inordinate cost and impracticality of avoidance. Failure to comply could result in work stoppage.

Submittals to UAOs shall include a sheet that summarizes the changes to the plans and design (since the previous submittal) that could potentially impact the UAOs. Only those changes are required to be summarized. A “Notes to the Reviewer Sheet” will satisfy this requirement.

The Utility Work Schedule is the mechanism for the UAOs to coordinate their activities with the Contractor. This form (**710-010-05**) is to be submitted for each affected Utility with the plans as part of the bid package. This and other pertinent forms can be found on the State Utilities Office web site:

<http://www.dot.state.fl.us/rddesign/utilities/Default.shtm>

Chapter 6

Railroad Crossing

6.1	General	6-1
6.2	At-Grade Crossings.....	6-2
6.2.1	Devices	6-2
6.2.2	Surfaces.....	6-2
6.2.3	Railroad-Highway Grade Crossing Near or Within Project Limits	6-3
6.3	Grade Separations	6-4
6.3.1	Criteria	6-4
6.3.2	Bridge Width	6-4
6.3.3	Horizontal Clearances to Face of Structures	6-5
6.3.3.1	Adjustments for Track Geometry	6-5
6.3.3.2	Adjustments for Physical Obstructions	6-6
6.3.3.3	Required Foundation Clearances	6-6
6.3.4	Crash Walls.....	6-6
6.3.5	Vertical Clearance.....	6-6
6.3.6	Special Considerations	6-7
6.3.7	Widening of Existing Overpasses	6-7
 Tables		
Table 6.3.3	Horizontal Clearances for Railroads	6-5
 Figures		
Figure 6.1	Track Section	6-9
Figure 6.2	Section Thru Tracks.....	6-10

THIS PAGE LEFT BLANK INTENTIONALLY

Chapter 6

Railroad Crossing

6.1 General

A railroad-highway crossing, like any highway-highway intersection, involves either a crossing at-grade or a separation of grades. This chapter provides standard requirements for crossings at other than high-speed railways. Crossing requirements for high-speed railways must be coordinated with the Department's Rail Office on a project-specific basis.

The following three major railroad companies currently operate in the State of Florida:

1. CSX Transportation, Incorporated
2. Florida East Coast Railway Company
3. Norfolk Southern Corporation

Ten shortline railroad companies and three terminal switching companies also operate in the State of Florida.

6.2 At-Grade Crossings

Selection of the warning devices to be used is a function of the geometrics of railroad-highway grade crossing, including the alignment, profile, sight distance and cross section of both the roadway and the railroad. Railroad grade crossing angles should be as near 90 degrees as practical.

Design Criteria and Standards are given in the *Florida Greenbook* and the Department's *Railroad Procedures Manual*. Design considerations are discussed in **Chapter IX** of the *AASHTO Policy on Geometric Design*.

6.2.1 Devices

Traffic control devices for railroad-highway grade crossings consist primarily of signs, pavement markings, flashing light signals and automatic gates. A large number of significant variables must be considered in determining the types of warning device to be installed at a railroad grade crossing. The type of highway, volume of vehicular traffic, volume of railroad traffic, speed of vehicular traffic, volume of pedestrian traffic, accident record, and geometrics of the crossing are some of the factors influencing the choice of warning devices to be provided at the railroad crossing.

Standards and criteria for design, placement, installment and operation of these devices are covered in the *Manual on Uniform Traffic Control Devices (MUTCD)* and the Department's *Railroad Procedure Manual*. The Department's *Design Standards* should also be consulted in the design of railroad crossings.

6.2.2 Surfaces

The highway traveled way at a railroad crossing should be constructed for a suitable length with all-weather surfacing. A roadway section equal to the current or proposed cross section of the approach roadway should be carried across the crossing. The crossing surface itself should have a riding quality equivalent to that of the approach roadway. When selecting the type of crossing and the material to be used in its construction, consideration should be given to the character and volume of traffic using the highway. The Department's *Highway-Railroad Grade Crossing Material Selection Handbook* should be consulted in selecting the material.

The *Design Standards, Index 560* contains details for the construction of crossings.

6.2.3 Railroad-Highway Grade Crossing Near or Within Project Limits

Federal-aid projects must be reviewed to determine if a railroad-highway grade crossing is within the limits of or near the terminus of the project. If such railroad-highway grade crossing exists, the project must be upgraded to meet the latest **MUTCD** requirements in accordance **Title 23 United States Code (U.S.C.), Chapter 1, Section 109(e)** and **CFR 646.214(b)**. These requirements are located in **Chapter 8** of the **MUTCD**. “Near the terminus” is defined as being either of the following:

1. If the project begins or ends between the crossing and the MUTCD-mandated advanced placement distance for the advanced (railroad) warning sign. See **MUTCD, Table 2C-4** (on page 2C-6, Condition B, column “0” mph) for this distance.
2. An intersection traffic signal within the project is linked to the crossing’s flashing light signal and gate.

6.3 Grade Separations

For underpasses, the bridge carries the railway and must be designed and constructed to carry railway loadings in conformance with the **American Railway Engineering and Maintenance Association (AREMA) *Manual for Railway Engineering***, latest edition. For overpasses, the bridge carries highway traffic and must be designed and constructed to carry highway loadings. In either case, adequate clearances between the facilities must be provided.

Clearances, geometrics, utilities, provisions for future tracks, and maintenance road requirements for off-track equipment will involve negotiations with the governing railroad company. The railroad's review and approval, including need for and location of crash walls, shall be based on the completed BDR/30% Structures Plans prepared by the SDO, District Structures Design Engineer, or their consultant.

6.3.1 Criteria

The Structures Plans shall be prepared in accordance with the criteria obtained from the governing railroad company, the ***Plans Preparation Manual***, and the ***Structures Detailing Manual***.

See **Figure 6.1** for dimensions which must be obtained from the railroad company before preparing the BDR/30% Structures Plans.

The District Rail Coordinator is an additional reference source available to the designer.

6.3.2 Bridge Width

For overpasses, the highway bridge width is determined from the approved typical section for the proposed bridge. Details for underpasses will depend on the specific project.

6.3.3 Horizontal Clearances to Face of Structures

Horizontal clearances shall be measured in accordance with **Figure 6.1**. The governing railroad company occasionally may accept a waiver from normal clearance requirements if justified; i.e., for designs involving widening or replacement of existing overpasses. The FDOT’s Rail Office should be consulted if such action is being considered.

The minimum horizontal clearances measured from the centerline of outside track to the face of pier cap, bent cap, or any other adjacent structure are shown in **Table 6.3.3**, but must be adjusted for certain physical features and obstructions as described hereinafter.

Table 6.3.3 Horizontal Clearances for Railroads

Minimum Clearance Requirements	Normal Section	With 8 ft. Required Clearance for Off-Track Equip.	Temporary Falsework Opening
With Crash Walls	18 ft.	22 ft.	10 ft.
Without Crash Walls	25 ft.	25 ft.	N/A

The additional 8 ft. horizontal clearance for off-track equipment shall be provided only when specifically requested in writing by the railroad. In the event there is any doubt, the FDOT’s Rail Office should be consulted.

6.3.3.1 Adjustments for Track Geometry

When the track is on a curve, the minimum horizontal clearance shall be increased at a rate of 1.5 inches for each degree of curvature. When the track is superelevated, clearances on the inside of the curve will be increased by 3.5 inches horizontally per inch of superelevation. For extremely short radius curves, the **AREMA** requirements shall be consulted to assure proper clearance.

6.3.3.2 Adjustments for Physical Obstructions

Columns or piles should be kept out of the ditch to prevent obstruction of drainage. Horizontal clearance should be provided to avoid the need for crash walls unless extenuating circumstances dictate otherwise.

Figure 6.1 shows horizontal dimensions from the centerline of track to the points of intersection of a horizontal plane at the rail elevation with the embankment slope. This criteria may be used to establish the preliminary bridge length which normally is also the length of bridge eligible for FHWA participation; however, surrounding topography, hydraulic conditions, and economic or structural considerations may warrant a decrease or an increase of these dimensions. These dimensions must be coordinated with the governing railroad company.

6.3.3.3 Required Foundation Clearances

Edges of footings shall not be closer than 11 ft. from centerline of the track to provide adequate room for sheeting.

6.3.4 Crash Walls

See the *Structures Design Guidelines* for crash wall requirements.

6.3.5 Vertical Clearance

Minimum vertical clearances for overpasses are given in **Table 2.10.1, Chapter 2** of this manual. Vertical clearance is the least distance between the bottom of the superstructure and the top of the highest rail utilized anywhere within the horizontal clearance zone determined by **Section 6.3.3** and **Table 6.3.3**. If a track is identified as an electrified railroad, the minimum vertical clearance shall be 24 feet 3 inches. This provision is based on the FDOT's **South Florida Rail Corridor Clearance Policy for 25 KV service (Topic No. 000-725-003)**. In addition to existing electrified railroads, this provision applies to tracks identified as candidates for future electrification.

6.3.6 Special Considerations

1. Shoring and Cribbing requirements during construction should be accounted for in the preparation of the preliminary plans to assure compliance with the clearance criteria set forth herein. See **Figure 6.2**.

NOTE: Anything (e.g., cofferdams, footings, excavation, etc.) encroaching within 10 ft. of centerline of the track requires approval of the governing railroad.
2. Overpasses for electrified railroads may require protection screens.
3. Sometimes the substructure supports may be located between tracks or an outside track and the off-track equipment road.
4. Drainage from the section of the bridge above railroad right of way shall be drained away from the railroad right of way. When open scuppers are provided on the bridge, none shall be closer than 25 ft. from the centerline of the nearest track.

6.3.7 Widening of Existing Overpasses

The requirements for widening existing overpasses are as follows:

1. If existing horizontal or vertical clearances are less than those required for a new structure, it is required that the new portion of the structure be designed so as not to encroach into the existing clearances.
2. Permanent vertical clearances will have to take into account the track grade and the cross slope of the bridge superstructure. Therefore, it is generally more desirable to widen on the ascending side of the bridge cross slope.
3. Permanent horizontal clearances will have to take into account horizontal curves and substructures that are not presently parallel to the track.
4. Temporary construction clearances are particularly critical where existing clearances are already substandard. If vertical and horizontal clearances less than 22 ft. and 10 ft., respectively, are necessary, they will have to be approved on an individual basis. On high volume main lines, it may not be possible to reduce already restricted vertical clearances.
5. If widening requires construction of new widened approach fills, it is required that the same consideration be given to drainage design as required on new bridges. If new substructures provide less than 25 ft. horizontal clearance from center line of track, they must be designed with crash wall protection except as stated above.

The BDR/30% Structures Plans shall show a cross section at right angles to the centerline of the track where the centerline of bridge intersects the centerline of track. In situations where the substructure is not parallel to the track, or the track is curved, sections perpendicular to the centerline of the tracks shall be furnished at each substructure end.

If the Railroad is in an existing cut section, plan approvals will be considered by the governing railroad on an individual location basis. Factors to be considered will be the length, depth, and type material of the existing cut section, in addition to all of the previously mentioned factors.

Figure 6.1 Track Section

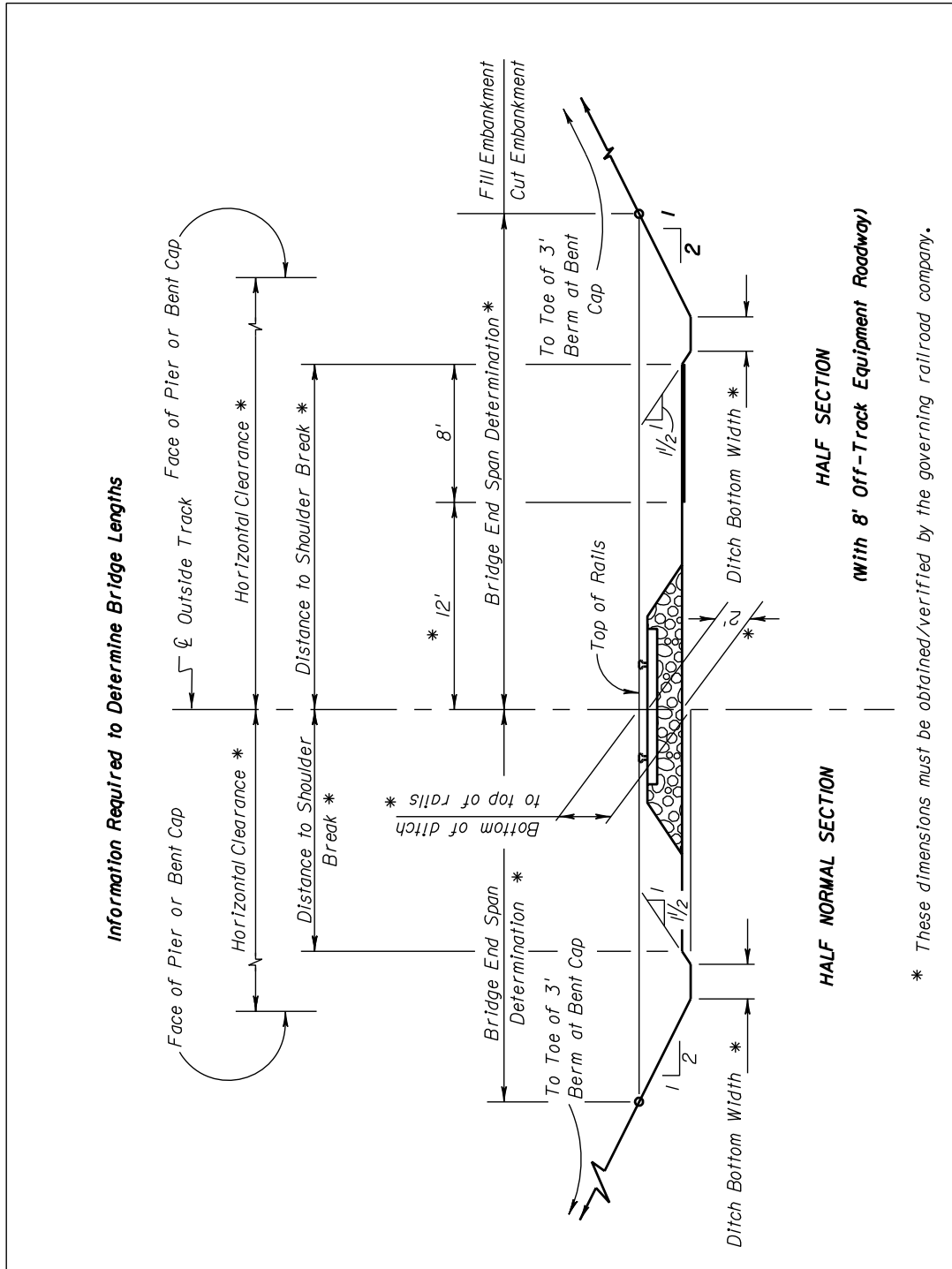
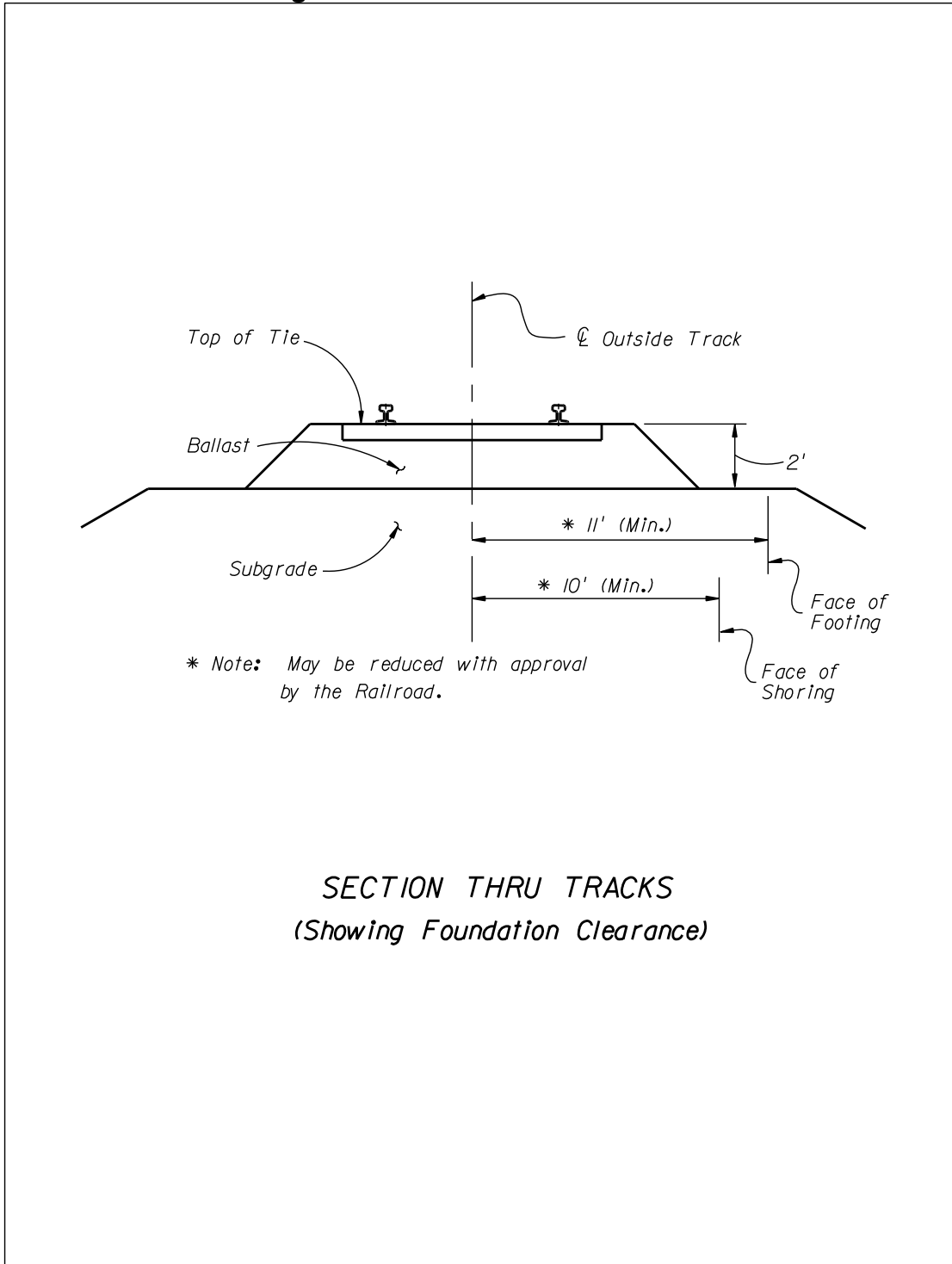

Figure 6.2 Section Thru Tracks



Chapter 7

Traffic and ITS Design

7.1	General	7-1
7.1.1	Railroad-Highway Grade Crossing Near or Within Project Limits	7-1
7.2	Signing and/or Pavement Marking	7-2
7.2.1	Design Criteria	7-2
7.2.2	Wind Loading Criteria - Signs	7-3
7.2.3	No-passing Zones	7-4
7.2.4	Use of Local Street Names on Guide Signs.....	7-4
7.2.5	Signing and Pavement Marking Project Coordination.....	7-5
7.2.6	Foundation Criteria	7-5
7.2.7	Signing for Bridges with Steel Decks	7-5
7.2.8	Guidance on Use of Various Pavement Marking Materials	7-6
	7.2.8.1 Maintenance of Traffic Applications	7-6
	7.2.8.2 Permanent Marking Applications	7-6
7.2.9	Delineators and Object Markers	7-8
7.3	Lighting.....	7-9
7.3.1	Design Criteria	7-9
7.3.2	Pole Design Criteria	7-12
	7.3.2.1 General	7-12
	7.3.2.2 Standard Aluminum Light Poles.....	7-12
7.3.3	Foundations Criteria.....	7-13
7.3.4	Wind Loading Criteria - Lighting.....	7-13
7.3.5	Lighting Project Coordination	7-13

7.3.6	Voltage Drop Criteria	7-14
7.3.7	Maintenance of Existing Lighting During Construction	7-14
7.3.8	Grounding	7-15
7.4	Traffic Signals	7-16
7.4.1	Design Criteria	7-16
7.4.2	Certification and Specialty Items.....	7-17
7.4.3	Stop Line Location	7-17
7.4.4	Controller Assemblies	7-18
7.4.5	Left Turn Treatments	7-19
7.4.6	Signal Preemption.....	7-20
7.4.7	Intersection Design - Lane Configuration.....	7-21
7.4.8	Signal Loops	7-23
7.4.9	Grounding and Electrical Bonding	7-23
7.4.10	Wind Loading - Traffic Signals	7-23
7.4.11	Foundation Criteria	7-24
7.4.12	Mast Arm Supports	7-24
7.4.13	Traffic Signal Project Coordination.....	7-25
7.4.14	LED Light Sources	7-26
7.4.15	Pedestrian Countdown Signal Applications	7-26
7.4.16	Number of Signal Heads for Through Lanes.....	7-27
7.4.17	Backplates	7-27
7.4.18	Span Wire Assemblies.....	7-27
7.5	Intelligent Transportation System (ITS) Components	7-29
7.5.1	Design Criteria	7-29
7.5.2	ITS Device Approval and Compatibility.....	7-30
7.5.3	Required Information	7-31
7.5.4	Motorist Information Systems.....	7-31
7.5.4.1	Dynamic Message Sign (DMS).....	7-31

	7.5.4.2	Highway Advisory Radio	7-32
	7.5.4.3	Road Weather Information System.....	7-34
7.5.5		Video Equipment.....	7-35
	7.5.5.1	Closed-circuit Television Cameras	7-35
	7.5.5.2	Video Display Equipment.....	7-36
7.5.6		Network Devices	7-36
	7.5.6.1	Managed Field Ethernet Switch	7-37
	7.5.6.2	Device Server	7-37
	7.5.6.3	Digital Video Encoder and Decoder.....	7-37
7.5.7		Fiber Optic Cable and Interconnect	7-38
	7.5.7.1	Fiber Optic Cable	7-38
	7.5.7.2	Fiber Optic Conduit.....	7-38
	7.5.7.3	Fiber Optic Splices and Terminations	7-39
	7.5.7.4	Fiber Optic Cable Designating System	7-39
	7.5.7.5	Fiber Optic Access Points.....	7-40
7.5.8		Infrastructure	7-41
	7.5.8.1	Grounding and Transient Voltage Surge Suppression	7-41
	7.5.8.2	ITS Pole and Lowering Device.....	7-42
	7.5.8.3	ITS Field Cabinet	7-42
	7.5.8.4	Equipment Shelter	7-43
7.5.9		Vehicle Detection and Data Collection.....	7-43
	7.5.9.1	Microwave Vehicle Detection System.....	7-43
	7.5.9.2	Video Vehicle Detection System.....	7-44
	7.5.9.3	Magnetic Traffic Detection System	7-44
	7.5.9.4	Acoustic Vehicle Detection System	7-44
7.6		Foundation Design	7-47

Tables

Table 7.3.1	Conventional Lighting - Roadways	7-10
Table 7.3.2	Highmast Lighting - Roadways	7-10
Table 7.3.3	Sign Lighting	7-10
Table 7.3.4	Underdeck Lighting - Roadways	7-11
Table 7.3.5	Rest Area Lighting	7-11
Table 7.3.6	Mounting Height Restrictions	7-11

Chapter 7

Traffic and ITS Design

7.1 General

Traffic control devices and intelligent transportation system (ITS) deployments are necessary to help ensure highway safety by providing the orderly and predictable movement of all traffic, motorized and nonmotorized, throughout the highway transportation system, and to provide such guidance and warnings as are needed to ensure the safe and informed operation of individual elements of the traffic stream. The design and layout of signs, signals, pavement marking and lighting should complement the basic highway design.

7.1.1 Railroad-Highway Grade Crossing Near or Within Project Limits

Federal-aid projects must be reviewed to determine if a railroad-highway grade crossing is in or near the limits of the project. If such railroad-highway grade crossing exists, the project must be upgraded in accordance with **Section 6.2.3**.

7.2 Signing and/or Pavement Marking

The designer responsible for a signing and/or pavement marking project should be aware that the design must comply with various standards. In addition to Department Standard Specifications, the following standards should be consulted:

Manual on Uniform Traffic Control Devices (MUTCD) - The **MUTCD** was adopted by the Department as the uniform system of traffic control for use on the streets and highways of the State. This action was in compliance with **Chapter 316.0745** of the **Florida Statutes**. The **MUTCD** is therefore the basic guide for signing and marking. The requirements of the **MUTCD** must be met, as a minimum, on all roads in the State.

Standard Highway Signs, FHWA - This manual contains detailed drawings of all standard highway signs. Each sign is identified by a unique designation. Signs not included in this manual or in the **Design Standards** must be detailed in the plans.

AASHTO Standard Specifications for Structural Supports for Highway Signs, Luminaires and Traffic Signals and **FDOT Structures Manual** - These documents provide structural design criteria.

Design Standards - These standards are composed of a number of standard drawings or indexes that address specific situations that occur on a large majority of construction projects.

Manual on Uniform Traffic Studies (MUTS) - This is a Department publication containing documentation for several types of traffic studies. This manual provides a systematic data collection procedure for the studies described.

Traffic Engineering Manual - This Department publication provides traffic engineering standards and guidelines to be used on the State Highway System.

7.2.1 Design Criteria

The **MUTCD** and the **Design Standards** should be consulted for sign location. All signs not bridge or barrier wall mounted and installed within the clear recovery zone, must be breakaway or protected by an approved barrier. **Chapter 4, Roadside Safety** of this volume, contains detailed instructions on safety design.

Post sizes for single column signs are covered in the ***Design Standards***. The supports for multipost signs are not in that reference and must be included in the plans. The designer must provide post sizes and length for each multipost sign. The Structures Design Office has written a program for personal computers that calculates post sizes and length for multipost signs. This program may be used for these calculations.

The design for all overhead sign structures and foundations shall be included in the plans. Refer to ***Section 7.6, Foundation Design***, and ***Chapter 29*** of this volume for more information.

The designer shall determine the lighting requirements for all overhead signs. Only induction lighting fixtures shall be utilized for sign lighting unless otherwise specified. The sign lighting requirements shall be shown in the plans on the Guide Sign Worksheet for each sign. Sign lighting calculations shall be included in the Lighting Design Analysis Report.

7.2.2 Wind Loading Criteria - Signs

The wind loadings given below are based on the ***AASHTO Standard Specification For Structural Supports for Highway Signs, Luminaires and Traffic Signals*** and ***FDOT Structures Manual***. The Counties are listed by wind loading for the appropriate sign type.

110 mph	Alachua, Baker, Bradford, Clay, Columbia, Gadsden, Gilchrist, Hamilton, Hardee, Jackson, Jefferson, Lafayette, Lake, Leon, Madison, Marion, Polk, Putnam, Sumter, Suwannee, and Union
130 mph	Bay, Brevard, Calhoun, Charlotte, Citrus, DeSoto, Dixie, Duval, Flagler, Franklin, Glades, Gulf, Hendry, Hernando, Highlands, Hillsborough, Holmes, Lee, Levy, Liberty, Manatee, Nassau, Okaloosa, Okeechobee, Orange, Osceola, Pasco, Pinellas, Sarasota, Seminole, St. Johns, Taylor, Volusia, Wakulla, Walton, and Washington.
150 mph	Broward, Collier, Miami-Dade, Escambia, Indian River, Martin, Monroe, Palm Beach, Santa Rosa, and St. Lucie

7.2.3 No-passing Zones

The procedures required by the Department for determining the limits of no-passing zones are contained in the *Manual on Uniform Traffic Studies, (MUTS)*. The requirements of this manual must be followed.

Limits of pavement markings for no-passing zones shall be established by one of the following methods:

1. On projects where existing roadway conditions (vertical and horizontal alignments) are to remain unaltered by construction, the no-passing zones study shall be accomplished as part of the design phase. This will be either by in-house staff or included in design consultant contracts.

The limits of the no-passing zones shall be included in the contract documents, and a note to this effect shown on the plans.

2. On projects with new or altered vertical and horizontal alignments, limits for no-passing zones shall be established during construction. The required traffic study and field determination of limits shall be performed through the design consultant as a post design service, or as part of a districtwide consultant contract for such services.

When this service is included as part of post design services, sufficient time shall be included to accomplish the required field operations without delaying or interfering with the construction process.

7.2.4 Use of Local Street Names on Guide Signs

The normal practice is to use route numbers on guide signs to designate roadways. In some areas, the local names for certain roadways are more familiar than the route number. For this situation, the local street name may be used. However, some roadways are known by more than one name as well as the route number. In many instances, the existing sign panel is not large enough to accommodate the street name and would require a new panel.

For these reasons, the decision to use local names on guide signs must be evaluated on a case-by-case basis. It is recommended that the District Traffic Operations Engineer be contacted for input in these decisions.

7.2.5 Signing and Pavement Marking Project Coordination

Coordination with other offices and other agencies is a very important aspect of project design. The offices discussed in this section are not intended to be an all inclusive list with which the designer should coordinate, but are those that are typically involved in a signing and marking project.

Roadway Design - The designer of a signing and pavement marking project receives the base sheets for design from the roadway designer, who can also provide any required cross sections. If the signing project is not an active roadway design project, base sheets may be obtained from existing plans.

Utilities - The District Utilities Engineer provides the coordination between the designer and the various utilities involved in the project. The Utilities Section can also identify potential conflicts with overhead and underground utilities or verify those which have previously been identified. The District Utilities Engineer should be contacted as early in the design phase as possible.

Structures Design - The Engineer of Record for Structures Design provides the design of the sign structures for overhead cantilever and overhead truss sign assemblies. This includes the design of the foundation for these structures. The Engineer of Record must be contacted early in the design phase to allow adequate time for coordination with the Geotechnical Engineer in obtaining the necessary soils information.

Right of Way – The State Motorist Information Services Administrator must be contacted on any projects that may impact Interstate Logo Signs. See **Section 13.5.4** for requirements and additional information.

7.2.6 Foundation Criteria

Refer to **Section 7.6, Foundation Design**, for geotechnical requirements.

7.2.7 Signing for Bridges with Steel Decks

Slippery When Wet Signs (W8-5) shall be placed in advance of all movable and non-movable bridges with steel decks. Refer to **Section 2.1** of the **Traffic Engineering Manual (Topic No. 750-000-005)**. This also applies to temporary bridges.

7.2.8 Guidance on Use of Various Pavement Marking Materials

The Engineer should consider several factors before selecting the pavement marking materials to be used during the Maintenance of Traffic operations or in application of the permanent markings.

7.2.8.1 Maintenance of Traffic Applications

The factors which should be considered in a Maintenance of Traffic (MOT) operation should include:

1. How long do the markings need to last?
2. Will the markings need to be removed or will they be covered by an asphalt course?
3. Cost.
4. Traffic Volumes.

Paint is normally used in MOT operations and is appropriate for short term operations. If a MOT operation lasts for more than a year under heavy traffic volumes a refurbishment thermoplastic should be considered.

7.2.8.2 Permanent Marking Applications

The factors which should be considered for permanent marking should include:

1. How long do the markings need to last?
2. What are the traffic volumes?
3. Type of Surface.
4. Does the marking need to meet special requirements (audible & vibratory, contrast, etc?)
5. Cost.
6. If it is a refurbishment marking, what is the thickness and condition of the existing markings?

Thermoplastic is the Department's primary material to be used for the permanent markings

on asphalt surfaces. When used in conjunction with RPM's on centerline application, it provides excellent wet night visibility and long term performance at a reasonable cost. When used in an edge line application, it provides moderate wet night visibility and long term performance at a reasonable cost.

On concrete pavements and bridge decks contrast markings shall be used. Options include thermoplastic, tapes and two-component reactive materials. On concrete surfaces, tapes are normally used for only centerline applications and are the preferred alternative. Two-component reactive or thermoplastic materials are normally used for edge line applications in conjunction with tape.

Audible and vibratory markings shall be installed on all flush shoulder rural projects excluding limited access facilities. These markings are a countermeasure for lane departure crashes. These markings shall be installed on the outside edge lines for all two lane and multi-lane undivided rural roadways; and on the inside and outside edge lines of all multi-lane divided rural roadways. Audible and vibratory markings shall be considered on flush shoulder roadways within Urban 2 and Urban 3 boundaries. (Urban 2 and Urban 3 boundaries may be found in the Roadway Characteristics Inventory (RCI) Database.) Noise is the primary concern within these areas. Audible and vibratory markings should only be used on centerline markings of two-lane roadways where there is a history of centerline cross over crashes.

For guidance on wet weather, contrast and other special use marking, contact the State Traffic Standards Engineer.

7.2.9 Delineators and Object Markers

The **MUTCD** defines the differences between delineators and object markers. Object markers are used to mark obstructions within or adjacent to the roadway. The **MUTCD** describes four object markers and how they are to be used. Type 1 or Type 3 object markers are used to mark obstructions within the roadway and Type 2 and Type 3 markers are used to mark obstructions adjacent to the roadway. Type 4 object markers, end-of-roadway markers are used to alert users of the end of the road.

Delineators are considered guidance devices rather than warning devices. The **MUTCD** shows the use of delineators along the edge of freeways and expressways and on the side of interchange ramps. **Design Standards, Index 17345** details the use of this type of delineator. This delineator may be a flexible or a non-flexible type delineator. District maintenance units generally have a preference on which should be specified.

The Department also uses delineators to mark median opening for both rural and urban openings. In general, flexible delineators are used on urban median openings and non-flexible are used on rural median openings. A high visibility median delineator should be used on traffic separators in the following locations:

1. At multilane intersections where additional visibility is required for the marking of the traffic separator,
2. Where the separator is obstructed due to crest vertical curves,
3. At intersections where the alignment thru the intersection is not straight, and
4. Where traditional flexible delineators are constantly being replaced.

High visibility median delineators can be specified for urban median separators.

High performance delineators should be used in all applications where the delineator is being used to maintain lane positions, restrict vehicle movements or any other area where the delineator is subject to being frequently hit.

The particular type of object marker or delineator should be identified in the plans by the use of the pay item.

7.3 Lighting

The designer responsible for a highway lighting project should be aware that the design must comply with various standards. In addition to the Department's Standard Specifications, the following standards should be consulted:

Roadway Lighting Design Guide, AASHTO - This is the basic guide for highway lighting. It includes information on warranting conditions and design criteria.

AASHTO Standard Specifications for Structural Supports for Highway Signs, Luminaires and Traffic Signals, and FDOT Structures Manual - This specification contains the strength requirements of the poles and bracket arms for the various wind loadings in Florida as well as the breakaway requirements. All luminaire supports, poles and bracket arms must be in compliance with these specifications.

Design Standards - These indexes are composed of a number of standard drawings or indexes which address specific situations that occur on a large majority of construction projects.

7.3.1 Design Criteria

The ***AASHTO Roadway Lighting Design Guide*** permits either the illuminance technique or the luminance technique to be used in the design of highway lighting. The luminance technique requires a more complex design process and knowledge of the reflective characteristics of the pavement surface used. These reflective characteristics change as the pavement ages and with variations in weather conditions. The Department has elected to use the illuminance technique for lighting design. The design values for light levels given by the ***AASHTO Roadway Lighting Design Guide*** are maintained values. The light levels given in this criteria have been adjusted and are listed as average initial foot candle. This, in effect, sets the maintenance factor to be used in the calculation process to a value of 1. Lighting criteria is contained in ***Tables 7.3.1 – 7.3.6***.

Mounting height (M.H.) for conventional lighting is the vertical distance from the roadway to the light source, regardless of lateral placement of the pole. Pole setback is the horizontal distance from the edge of the travel lane to the pole.

Refer to ***Chapter 29*** of this volume for more information.

Table 7.3.1 Conventional Lighting - Roadways

ROADWAY CLASSIFICATIONS	ILLUMINATION LEVEL AVERAGE INITIAL HORIZONTAL FOOT CANDLE (H.F.C.)	UNIFORMITY RATIOS		VEILING LUMINANCE RATIO
		Lavg/Lmin	Lmax/Lmin	Lv(max)/Lavg
INTERSTATE, EXPRESSWAY, FREEWAY & MAJOR ARTERIALS	1.5	4:1 or Less	10:1 or Less	0.3:1 or Less
ALL OTHER ROADWAYS	1.0	4:1 or Less	10:1 or Less	0.3:1 or Less
* PEDESTRIAN WAYS AND BICYCLE LANES	2.5	4:1 or Less	10:1 or Less	-----

Note: These values should be considered standard, but should be increased if necessary to maintain an acceptable uniformity ratio. The maximum value should be one and one-half values.

* This assumes a separate facility. Facilities adjacent to a vehicular roadway should use the levels for that roadway.

Table 7.3.2 Highmast Lighting - Roadways

ROADWAY CLASSIFICATIONS	ILLUMINATION LEVEL AVERAGE INITIAL (H.F.C.)	UNIFORMITY RATIOS	
		AVG./MIN.	MAX./MIN.
INTERSTATE, EXPRESSWAY, FREEWAY & MAJOR ARTERIALS	0.8 to 1.0	3:1 or Less	10:1 or Less
ALL OTHER ROADWAYS	0.8 to 1.0	3:1 or Less	10:1 or Less

Table 7.3.3 Sign Lighting

AMBIENT LUMINANCE	ILLUMINATION LEVEL AVERAGE INITIAL (H.F.C.)	UNIFORMITY RATIOS
		MAX./MIN.
LOW	15 - 20	6:1
MEDIUM & HIGH	25 - 35	6:1

Table 7.3.4 Underdeck Lighting - Roadways

LUMINAIRE TYPE	LIGHT SOURCE	MOUNTING LOCATION
PIER CAP	150 watt to 250 watt HPS	Pier or Pier Cap
PENDANT HUNG	150 watt to 250 watt HPS	Bridge Deck

Note:

1. The light levels for underdeck lighting shall be equal to the adjacent roadway lighting.
2. Underdeck lighting is accomplished by mounting either pier cap or pendant hung fixtures under the bridge structure.
3. Pier cap luminaires should be installed when bridge piers are located less than 15 ft. from edge of travel lane.
4. Pendant hung luminaires shall be mounted to the bottom of the bridge deck and should suspend where 50% of the lamp is below bridge beam.
5. Under no circumstances shall any luminaire or conduit be allowed to attach onto the bridge girders.

Table 7.3.5 Rest Area Lighting

AREA ILLUMINATED	ILLUMINATION LEVEL AVERAGE INITIAL (H.F.C.)	UNIFORMITY RATIOS	
		AVG./MIN.	MAX./MIN.
ENTRANCE & EXIT	1.5	4:1 or Less	10:1 or Less
INTERIOR ROADWAYS	1.5	4:1 or Less	10:1 or Less
PARKING AREAS	1.5	4:1 or Less	10:1 or Less

Table 7.3.6 Mounting Height Restrictions

LUMINAIRE WATTAGE	LIGHT SOURCE	MOUNTING HEIGHT (MIN.) (FEET)
150	High Pressure Sodium (HPS)	25
200	High Pressure Sodium (HPS)	30
250	High Pressure Sodium (HPS)	30
400	High Pressure Sodium (HPS)	40
750	High Pressure Sodium (HPS)	50
1000	High Pressure Sodium (HPS)	80

7.3.2 Pole Design Criteria

7.3.2.1 General

Chapter 2 of this volume specifies the minimum horizontal clearances for light poles. High mast lighting poles should not be located in gore areas within the runout length as defined in the **AASHTO Roadside Design Guide**. Engineering judgment should be used when locating high mast poles adjacent to bridges and high fills. All conventional height poles shall be breakaway unless bridge or barrier wall mounted.

See the **Design Standards** for breakaway requirements.

The installation of lighting in certain locations (e.g., adjacent to residential areas) may require the luminaires to be shielded. This is especially true for high mast poles.

7.3.2.2 Standard Aluminum Light Poles

The Department has developed an aluminum light pole standard for Conventional Lighting. The standard provides details for 40, 45 and 50 foot luminaire mounting heights on poles mounted either at grade or on fills up to 25 feet in height, all of which accommodate fixture arm lengths of 8, 10, 12 and 15 feet. Standard Aluminum Light Poles have been designed for 110, 130 and 150 mph design wind speeds.

The manufacturer of the Standard Aluminum Light Poles will be pre-approved by the Department and added to the Qualified Products List (QPL). When the standard assemblies are used, neither design details in the plans nor Shop Drawing submittals are required. Custom designs, for those locations where the Standard Aluminum Light Poles are not appropriate, will require the pole Fabricator's complete Shop Drawings and the Specialty Engineer's sealed calculations, all submitted as Shop Drawings in accordance with **Section 5** of the **Standard Specifications for Road and Bridge Construction**.

7.3.3 Foundations Criteria

Refer to **Section 7.6, Foundation Design**, for geotechnical requirements and **Chapter 29** of this volume for additional design information.

7.3.4 Wind Loading Criteria - Lighting

See **Chapter 29** of this volume.

7.3.5 Lighting Project Coordination

Coordination with other offices and other agencies is a very important aspect of project design. The offices discussed in this section are not intended to be an all inclusive list with which the designer should coordinate; instead it includes offices that are normally involved in projects.

Roadway Design - Normally the designer of a lighting project receives the base sheets for lighting design from the roadway designer. The roadway designer can also provide any required cross sections. If the lighting project is not an active roadway design project, base sheets may be obtained from existing plans.

Utilities - The District Utilities Engineer provides the coordination between the designer and the various utilities involved in the project. This usually is limited to agreements with the power company for electrical service. The Utilities Section can also identify potential conflicts with overhead and underground utilities or verify those which have previously been identified.

The Utilities Engineer should be contacted as soon as pole locations are set and the electrical load has been determined. The designer should indicate a preferred location for the electrical service.

Drainage - When the locations of high mast poles are established, they should be checked with the Drainage Section to determine if high water level is a problem. High mast poles are often located in the center of interchange loops. These same areas may be used as drainage retention areas. Coordination with the Drainage Section will alleviate this type problem.

Structures Design - Conventional height and highmast poles require the standard base shown in the *Design Standards* and *Standard Specifications*. A foundation design is only required in special cases. Soil borings are required for this design. The Engineer of Record for Structures Design provides the foundation design for highmast poles. He or she must be contacted early in the design phase to allow adequate time for coordination with the Geotechnical Engineer in obtaining necessary soils information.

Normally the District Traffic Operations Engineer in conjunction with the District Utilities Engineer obtains the required maintenance agreements. The designer should coordinate with these offices to ensure that this activity is either underway or scheduled.

Any lighting project, especially high mast, adjacent to or in the vicinity of an airport, may be a potential problem. Any lighting project within 3 miles of an airport should be discussed with the Office of Public Transportation, Aviation Office to determine if a problem exists.

7.3.6 Voltage Drop Criteria

When determining conductor sizes for lighting circuits, the maximum allowable voltage drop from the service point on any one circuit is 7%.

7.3.7 Maintenance of Existing Lighting During Construction

The maintenance of existing lighting shall be the responsibility of the contractor only if the lighting is affected by the construction. The contractor should not be expected to replace lamps and pole knockdowns or to repair wiring if these problems are not caused by the construction work. As an example, a milling and resurfacing project should have no effect on the roadway lighting and the contractor should not be responsible for the maintenance of the lighting system.

The plans should specify the scope of the contractor's responsibility for the maintenance of existing lighting.

7.3.8 Grounding

The grounding requirements for lighting systems shall be as follows:

1. Install 20' of ground rod at each conventional height light pole and at each pull box.
2. Install 40' of ground rod at each electrical service point.
3. At each high mast pole, install an array of 6 ground rods 20' in length, as shown in the ***Design Standards, Index 17502***.

This information is covered in the ***Design Standards***. The above lengths of ground rod will be installed at each pole, pull box and service point, and the cost will be incidental to the unit or assembly being installed.

7.4 Traffic Signals

The designer responsible for a traffic signal project should be aware that the design must comply with various standards. In addition to the Department's **Standard Specifications**, the following standards should be consulted:

Manual on Uniform Traffic Control Devices (MUTCD), FHWA - The **MUTCD** was adopted by the Department as the uniform system of traffic control for use on the streets and highways of the State. The action was in compliance with **Chapter 316.0745** of the **Florida Statutes**. The **MUTCD** is therefore the basic guide for traffic signals. The requirements of the **MUTCD** must be met, as a minimum, on all roads in the State.

AASHTO Standard Specifications for Structural Supports for Highway Signs, Luminaires and Traffic Signals, FDOT Structures Manual and **Chapter 29** of this volume - These documents provide structural design criteria.

Design Standards - These standards are composed of a number of standard drawings or indexes which address specific situations that occur on a large majority of constructions.

Traffic Engineering Manual – This Department publication provides traffic engineering standards and guidelines to be used on the State Highway System.

7.4.1 Design Criteria

The design of traffic signal mast arms and foundations shall be included in the plans. Refer to **Section 7.6, Foundation Design**, and **Chapter 29** of this volume for more information.

The horizontal clearance requirements for signal poles and controller cabinets are given in **Chapters 2** and **25** of this volume. Final location of these devices should be based on safety of the motorist, visibility of the signal heads, ADA requirements, and access by maintenance. When these clearances cannot be met with standard mast arm designs, alternatives and custom designs must be coordinated with the District Design Engineer.

The **MUTCD**, as noted above, has been adopted as the uniform system of traffic control for use on the streets and highways of the state. The **MUTCD** is the basic guide for traffic signal design; therefore, the traffic signal designer should be familiar with this document. The criteria in the following sections supplement the **MUTCD**.

7.4.2 Certification and Specialty Items

Traffic signal equipment installed in Florida is required to be certified by the Department. The Office of Traffic Engineering in the Central Office is charged with the responsibility of certifying traffic control equipment. The designer of a traffic signal project, if requiring new equipment types or types not normally used, should contact Traffic Engineering in Tallahassee to determine the certification status of the equipment. Noncertified equipment cannot be used.

Standard Specifications have not been developed for all signal equipment. Some items are project dependent and the development of standard specifications is difficult. Specifications for these items must be developed on a project by project basis and included in the contract as a special provision. Some of these specialty items are included on the Department's approved products list. For these items, detailed specifications are not required. The Office of Traffic Engineering should be consulted on these items.

7.4.3 Stop Line Location

A stop line that is not properly located invites violation by the motorist. The **MUTCD** specifies the minimum and maximum distances from the signal head to the stop line for adequate visibility. The traffic signal designer must insure that this requirement is met.

Instead of relocating the signal heads, the stop lines at many intersections have been moved from their proper location to comply with these requirements. The tendency for the motorist is not to stop at the new stop line location, but rather to creep beyond the stop line. This could in some cases result in valid calls being dropped, thereby increasing delay and decreasing the overall efficiency of the intersection.

The first step in the design process should be to locate crosswalks and stop lines properly. Then the signal head location should be determined to meet the **MUTCD** requirements. This may require changing the mounting configuration. A box span, for example, may be required where a diagonal span would normally be installed.

7.4.4 Controller Assemblies

Controller Timings: The development of controller timings is a basic part of traffic signal design. A recent ruling from the Board of Professional Engineers stated that the development of timings is considered engineering and therefore requires the signature and seal of a professional engineer.

All traffic signal designs prepared for or by the Department shall include initial timings of all controllers. This is also true for signals to be included in local systems. If the timings in the plans are not implemented, it will be the responsibility of the agency providing the timings to insure they were prepared under the supervision of a professional engineer.

Future Intersection Expansion: Any planned intersection improvements, should be considered in the signal design. The controller type, cabinet type and the number of load switches are examples of design features that may be affected by future intersection improvements. It is the responsibility of the signal design engineer to determine if the current design should include capabilities for future improvements.

Upgrade of Existing Controller Assemblies: For projects requiring an upgrade to an existing controller assembly, the assembly may either be expanded or replaced. Minor expansions include the addition of load switches, new controller timings, and/or new controller unit if the cabinet is properly wired. These may be made in the field; therefore, expansion is the logical choice. On the other hand, major expansions include cabinet rewiring or any work requiring the removal of the cabinet back panel. Major expansions shall not be made in the field and replacement of the assembly is required. The designer may wish to contact the District Traffic Operations Engineer before making the decision to expand or replace an existing controller assembly.

7.4.5 Left Turn Treatments

The guidelines given below should be followed when determining signal treatments for left turns.

1. Single Turn Lane
 - a. Protected/Permissive Phasing - A five-section cluster should be used for this location. The head should be installed over the lane line between the left turn lane and through lane. The five-section cluster can serve as one of the two indications required for the through traffic.
 - b. Protected Phasing - A separate signal head for the left turn lane with red, yellow and green arrow indications should be positioned over the center of the left turn lane.
2. Dual Turn Lanes - Only protected phasing should be used. Permissive movements should not be allowed for dual turn lanes. A single three-section head with red, yellow, and green arrow indications should be centered over each turn lane. These heads are in addition to the dual indications required for the thru movement.
3. Separated Turn and Thru Lanes – For signal operation guidelines for separated left turn and thru lanes, see [Section 3.2 of the Traffic Engineering Manual](#).
4. Single Lane Approach on Stem of "T" - Two three-section heads are required as minimum. All indications must be circular in this situation.
5. Two Approach Lanes on Stem of "T"

Option #1: The approach may display two three-section heads with circular indications on all sections.

Option #2: The approach may display a five-section cluster in conjunction with a three-section head. If the lanes are exclusive left and right turn lanes, then the five-section cluster should be placed over the center of the lane line and the three-section head over the major movement lane. If one of the lanes is a shared left and right lane, then the five-section cluster should be placed over the center of this lane and the three-section head over the center of the other lane.

Option #3: The approach may display two three-section heads for the major movement and a single three-section head for the secondary movement.
6. Three Approach lanes on Stem of "T"

Option #1: The approach may display two three-section heads for the major movement and one for the secondary movement (Exclusive left and right turn lanes).

Option #2: The approach may display a five-section cluster in conjunction with three-section head (exclusive left and right turn lanes). The five-section cluster should be placed over the center of the lane line separating the left turn lane(s) from the right turn lane(s). The three-section head should be placed over the other lane line to provide dual indication for the major movement.

Option #3: When the middle lane is a shared left and right turn lane, then a five-section cluster should be placed over the center of this lane and a three-section head placed over each of the other two lanes. Each head must contain green and yellow arrow indications in this situation.

NOTE:

1. For all cases, the approach shall display "dual indications". This means that there must be at least two heads with identical indications on the major approach. For example, if a green arrow is displayed on one head of the major movement or approach then a green arrow must be displayed on the second head.
2. The same signal display option should be used throughout an urban area to provide consistency in display to the motorist.
3. The use of advance and/or overhead lane use signs should be used as a supplement to pavement arrows on stems of signalized "T" intersections.

7.4.6 Signal Preemption

The engineer responsible for the design of a traffic signal project shall, as a matter of routine, check each intersection to determine if the need for signal preemption is present.

Intersections located in accordance with [Department Procedure 750-030-002](#) should be considered for preemption. Department signalization projects may also include preemption or priority systems for emergency vehicles or mass transit vehicles.

Refer to [Department Procedure 750-030-002, Signalization Preemption Design Standards](#), for more information.

7.4.7 Intersection Design - Lane Configuration

The engineer responsible for the traffic signal design may be asked to verify the number and configuration of traffic lanes required for an intersection to function properly when signalized.

The results are dependent upon the traffic volumes used in the analysis. The traffic used for this calculation shall be the design hourly volume based on the 30th highest hour (K factor) and not a peak to daily (P/D) ratio based on a 24-hour count. The K factor volumes account for traffic variations through the year, and, in most cases, are higher than P/D volumes.

The K, D, and T factors convert the two-way AADT volumes to a one-way Design Hourly Volume (DHV). This is appropriate for the total approach movements. The AM and PM peak turning movement counts on each approach should be addressed individually. Current turning movement counts should be taken to determine the percentage of turns for each approach. These percentages should then be applied to the DHV for each approach volume to determine the turning volumes that should be used for the turn lane design calculations. These values should be compared to the movement counts supplied by Planning and the greater of the two values used for the design of turn lanes. The District Planning Office should be contacted to determine if recent counts are available and also if any use changes are planned which would require adjustments to the turn percentages found in the current counts.

Storage lanes for left turns can affect the capacity and safety of intersections. The storage length of a left turn lane is a critical design element. The queue of left turn vehicles in a storage lane of inadequate length may extend into the through lanes. The result is loss of capacity for the through lanes. The queue of through vehicles may also extend beyond the entrance of a short left turn storage lane, blocking access to the storage lane. Either case results in a less efficient operation of the intersection and may cause last minute lane changes, thereby increasing the possibility of conflicts.

Turn lanes should comply with the ***Design Standards, Index 301*** to the extent practical. The available queue length provided should be based on a traffic study.

The important factors that determine the length needed for a left turn storage lane are:

1. The design year volume for the peak hour (see discussion above).
2. An estimate for the number of cycles per hour.

NOTE: If the cycle length increases, the length of the storage for the same traffic also increases.

3. The signal phasing and timing.

There are several techniques used to determine necessary storage length. The following are suggested guidelines for left turn lanes.

1. Where protected left turn phasing is provided, an exclusive turn lane should be provided.
2. Left turn lanes should be provided when turn volumes exceed 100 vehicles per hour (VPH) and may be considered for lesser volumes if space permits.
3. For signalized intersections, the following formula may be used, assuming an average vehicle length of 25 feet.

$$Q = \frac{(2.0) (DHV) (25)}{N}$$

Where:

Q = design length for left turn storage in ft.

DHV = left turn volume during design peak hour, in VPH.

N = number of cycles per hour for peak hour, use N = 30 as default.

Note: Computer programs, such as **TRANSYT-7F**, are used to develop signal phasing and timing. One of the outputs of these programs is the queue length. For projects where traffic signal timing is included as a part of the project, the output of these programs should be considered in determining storage length.

4. Where left turn volumes exceed 300 vph, a double left turn should be considered.
5. When right of way has already been purchased, and the designer has to choose between a long wide grass median or a long left turn lane, the storage length for the left turn should be as long as practical without hindering other access.

Right turn lanes are provided for many of the same reasons as left turn lanes. Right turns are, however, generally made more efficiently than left turns. Right turn storage lanes should be considered when right turn volume exceeds 300 vph and the adjacent through volume also exceeds 300 vehicles per hour per lane (vphpl).

7.4.8 Signal Loops

Traffic signal loops are detailed in the *Design Standards, Index 17781*. These loops are standard and will be appropriate for most locations.

The traffic signals for each intersection should be individually designed. The requirement for type and placement of loops is a part of this design. The above standard allows for some variation in size and placement of the standard loops. These modifications are intended to be used only when required by the design of a particular location.

7.4.9 Grounding and Electrical Bonding

The grounding requirements for traffic signal components shall be as follows:

1. Install 20' of ground rod at each signal pole, mast arm, pedestrian signal, etc. and at each pull box.
2. Install 40' of ground rod at each electrical service and controller cabinet.

This information is covered in the *Design Standards* and specifications. The above lengths of ground rod will be installed at each component, and the cost will be incidental to the unit or assembly being installed.

Design Standards, Index 17736 requires a bond wire connecting all poles, controllers, mast arms and pedestrian signal pedestals. This conductor is incidental to the cost of the signal installation.

7.4.10 Wind Loading - Traffic Signals

See *Chapter 29* of this volume.

7.4.11 Foundation Criteria

Refer to **Section 7.6, Foundation Design**, for geotechnical requirements.

7.4.12 Mast Arm Supports

All new signals installed on the State Highway System shall meet the following criteria:

1. Signalized Intersections within the ten mile coastline boundary defined by the State Traffic Engineering Office Implementation Guidelines (considered the mast arm policy area):

Signals shall be supported by galvanized mast arms, with the signal head(s) rigidly attached to the mast arm, along corridors within the ten mile coastline boundary. When it is impractical to use a mast arm or overhead rigid structure within the ten mile coastline boundary, a single point span wire assembly shall be used and a Design Variation must be approved in accordance with **Chapter 23** of this volume. The Department will cover the cost for a galvanized mast arm only. If the Local Maintaining Agency wants a painted mast arm, they must provide the additional funding and commit to cover the maintenance cost.

2. Signalized Intersections outside the ten mile coastline boundary:

Signals shall be supported by single point span wire assemblies along all corridors outside the ten mile coastline boundary. A two point span wire assembly may be used when a Design Variation has been approved in accordance with **Chapter 23** of this volume. If the Local Maintaining Agency wants a mast arm, they must provide the additional funding and commit to cover the maintenance cost if it is painted.

In addition, an underground communication cable infrastructure shall be utilized for those signals operating as part of an advanced traffic management system on these designated corridors.

The Department has developed a Traffic Signal Mast Arm Design Standard. The standard includes single arm designs, with and without luminaires and double arm designs without luminaires. The standard designs include 110, 130 and 150 mph design wind speeds. A foundation and base plate design has been developed for each pole type.

The manufacturer of the standard mast arms will be pre-approved by the Department and added to the Qualified Products List (QPL). When the standard assemblies are used, design details in the plans or shop drawing submittals will not be required. Custom designs, for

those locations where the standard design is not appropriate, will require complete design details for the pole, arm and foundation to be included in the plans, and will require shop drawings.

Mast arm design will require close coordination between the signal designer and the Structures Office. If standard designs are utilized, the Structures Engineer shall review applicability of structural parts with site conditions. Early coordination is important.

The Signal Designer will provide the Structures Office a copy of the mast arm tabulation sheet that includes the following information:

1. The pole and arm locations
2. Elevations and offsets
3. Signal and sign sizes and locations on the mast arm

The Structures Office will analyze the data and determine the standard pole and arm configuration required, and complete the "Standard Mast Arm Assemblies Data Table" (Structures CADD cell table) for the plans. If a custom design is required the Structures Office will provide the complete design details for the custom mast arm assembly. A custom design will require additional design time for either the Department or Consultant Structures Office. As noted above, the standard includes a foundation design for each pole. These designs were based on assumed soil conditions. The Structures Office will verify the project soil conditions to ensure the standard foundations are adequate. A custom design will be developed if required.

The engineer responsible for signal design will seal the mast arm tabulation sheet and the Structures Design Engineer will seal the structures data table and custom design details if required for the plans.

Refer to **Volume 2, Chapter 24** for instructions on the mast arm tabulation sheet.

7.4.13 Traffic Signal Project Coordination

Coordination with other offices and other agencies is a very important aspect of project design. The offices discussed in this section are not intended to be an all inclusive list with which the designer should coordinate, instead it includes offices that are normally involved in projects.

Roadway Design - Normally the designer of a signal project receives the base sheets for

design from the roadway designer. The roadway designer can also provide any required cross sections. If the signal project is not an active roadway design project, base sheets may be obtained from existing plans.

Utilities - The District Utilities Engineer provides the coordination between the designer and the various utilities involved in the project. This usually is limited to agreements with the power company for electrical service. The Utilities Section can also identify potential conflicts with overhead and underground utilities or verify those that have previously been identified.

The Utilities Engineer should be contacted early in the design phase. The designer should indicate a preferred location for the electrical service.

Structures Design - The Engineer of Record for Structures Design provides the design of the traffic signal mast arms and strain poles. This includes the design of the foundation for these structures. The Engineer of Record must be contacted early in the design phase to allow adequate time for coordination with the Geotechnical Engineer in obtaining the necessary soils information.

Pedestrian and Bicycle Coordinator - The pedestrian and bicycle coordinator should be consulted to be sure that all of the pedestrian and bicyclist concerns have been fully considered.

7.4.14 LED Light Sources

The Light Emitting Diode (LED) is the standard light source for all signal indications.

7.4.15 Pedestrian Countdown Signal Applications

Countdown pedestrian signals are the Department's standard installation on all projects that include pedestrian signal head devices. The Department's *Traffic Engineering Manual, Section 3.9*, contains specific criteria for their installation and operation.

7.4.16 Number of Signal Heads for Through Lanes

For two lane approaches, a three-section head shall be placed over the center of each lane. If a single left turn lane is provided and protected/permissive phasing is used, a five-section cluster can serve as one of the two indications required for the through lane.

For three or more lane approaches, a three-section head shall be placed over the center of each lane. If a single left turn lane is provided, a five-section cluster can serve as one of the indications required for the inside through lane.

7.4.17 Backplates

Louvered backplates shall be installed on all signal sections for all approaches. Retroreflective backplate borders are required for all backplates where the posted speed for the approach is 45 mph or greater. Retroreflective borders are encouraged on all backplates where the posted speed for the approach is less than 45 mph.

7.4.18 Span Wire Assemblies

Perpendicular spans, box spans or drop box spans shall be used for all signal span wire assemblies. Diagonal span assemblies shall only be used for flashing beacon installations. A design variation is required for other diagonal installations. The design variation shall be signed by both the District Design Engineer and the District Traffic Operations Engineer.

THIS PAGE LEFT BLANK INTENTIONALLY

7.5 Intelligent Transportation System (ITS) Components

Intelligent transportation system (ITS) designs utilize electronics, communications, or information processing systems singly or in combination to improve the efficiency and safety of a surface transportation system. ITS components are devices and subsystems that provide certain specialized functions within an ITS system. These devices are typically deployed to obtain information (including traffic data, video imagery, weather information, and other information relevant to roadway management) from field sites along Florida's Intrastate Highway System. This information is transmitted to transportation management centers (TMCs) and associated control facilities, where traffic managers use it to assess conditions, respond to incidents, and conduct other activities. ITS components also provide various means of disseminating travel-related information and alerts to motorists concerning traffic or weather conditions they may encounter.

The inclusion of new ITS design guidelines in this chapter will occur as statewide minimum specifications for ITS devices are finalized and adopted by the Department. Because this is an ongoing process, those individuals seeking the latest information on ITS device design requirements and specifications should contact the ITS Section in the Traffic Engineering and Operations Office.

The plans preparation information provided in this section applies to the placement and installation of ITS devices and systems along Florida's limited-access and non-limited-access corridors. ITS device requirements as adopted by the Department are published by the State Specifications Office and available online at the FDOT Web site. The ITS project designer is advised that plans involving ITS devices must also include provisions for grounding and surge suppression in order to protect ITS equipment and ensure human safety.

7.5.1 Design Criteria

ITS design criteria, in general, require that devices and systems be able to gather, analyze, and distribute accurate information to support the overall goal of improving the safety, efficiency, mobility, security, and integration of transportation systems. Designers must consider the strengths and limitations of various technologies for collecting, analyzing, and disseminating information, and select devices that are most appropriate for a specific application. Many ITS devices have specific placement and configuration requirements that must be met for the equipment to perform properly. Designers are strongly encouraged to familiarize themselves with the strengths and limitations of various devices and technologies prior to incorporating them into their designs. Other general considerations for

ITS designs include promoting safety for road users, monitoring traffic and travel conditions, supporting traffic management operations, providing equipment access for maintenance personnel, and disseminating useful information to motorists. Lastly, the designer needs to ensure that the ITS project is consistent with the FDOT regional ITS architecture, and that the project reflects the application of system engineering management principles.

For vehicle detection systems, such as those utilizing video, microwave, magnetic field, or acoustic technologies, the designer should consult with the device manufacturers to ensure that placement and installation plans facilitate proper operation of a particular device type. Be aware of a technology's capabilities and limitations in a given location in order to create a design that is capable of achieving the required levels of detection accuracy.

The clearance requirements for poles, sign structures, field cabinets, and communication hubs for ITS deployments should conform to those provided in **Chapters 2** and **25** of this volume. Any deviation or alternative or special design must be coordinated with the District Design Engineer.

7.5.2 ITS Device Approval and Compatibility

ITS devices sold or installed in Florida are required to be evaluated by the Traffic Engineering and Operations Office's Traffic Engineering Research Laboratory (TERL) prior to their use on the state's highways. The evaluation of ITS devices by the TERL will occur as statewide minimum specifications for ITS devices are finalized and adopted by the Department. Designers should consult the FDOT Approved Product List (APL) for the device types requiring evaluation and the currently approved devices. If the designer wishes to utilize a new device type or a device not on the APL, they should contact the TERL in Tallahassee to determine the appropriate course of action.

Designs should ensure that ITS devices which share communications networks or provide related functions are compatible with each other and will not interfere with the operation of other devices or systems. In addition, designs should incorporate features and functions that allow interoperability with other ITS deployments throughout the state. Examples of general design characteristics that promote interoperability include:

1. Systems and products based on open architectures and standards.
2. Systems and products that are scalable and nonproprietary.
3. Compatibility with the Department's SunGuideSM Software System directly or via support of one or more of its related Interface Control Documents (ICDs).

7.5.3 Required Information

The basic information necessary for ITS plans includes device placement and installation requirements (including communication and power interconnect), roadway geometrics, street names, construction stationing or milepost information, right of way lines, location of underground utilities, and presence of other roadside features or existing devices that may impact ITS device locations in the field.

The requirements for a complete set of ITS project plans are found in **Chapter 29 of Volume 2**.

7.5.4 Motorist Information Systems

7.5.4.1 Dynamic Message Sign (DMS)

The DMS is an electronic sign capable of displaying more than one message, which is changeable manually, by remote control, or by automatic control. The DMS is intended primarily to advise approaching motorists of freeway conditions, such as road construction or a traffic incident ahead, so that they can take appropriate action. In some instances the DMS could be used to display other messages, such as AMBER Alerts or traveler information related to special events, emergencies, and incidents impacting mobility and safety. A DMS generally displays messages that can be selected or modified by electronic means from a TMC or other central command location. As such, system designs utilizing DMS must also include designs for a communication infrastructure that supports this remote control capability.

The DMS should be positioned and illuminated to be readable from the roadway, taking into account the display characteristics of DMS technology (e.g., the vertical and horizontal viewing angles of the LED displays).

Design the DMS and support structure in accordance with **Chapter 29** of this volume.

Placement of a DMS should be determined by project-specific needs, as well as the following general design criteria:

1. Ability to communicate a meaningful message that can be read and comprehended by motorists within a brief time period (dictated by the sight distance characteristics)

- of the location and the design features of the sign). This is also dependent upon the posted speed limit of the roadway.
2. Placement prior to freeway interchanges that offer alternate routes.
 - a. In advance of 1-mile exit approach signing.
 - b. Maintain minimum 800-foot spacing between existing and planned overhead static sign panels and other signs, per the MUTCD. Consider increased spacing when conditions allow.
 - c. Maintain minimum of 1450-foot distance from decision points (meets MUTCD/AASHTO Green Book requirements).
 3. Placement in advance of high crash locations and traffic bottlenecks.
 4. Placement that accommodates access for service and maintenance.
 5. Placement in advance of system interchanges.
 6. Placement along key commuter or evacuation corridors.

The sign enclosure must be mounted with a minimum vertical clearance height as specified in **Table 2.10.4**.

7.5.4.2 Highway Advisory Radio

A highway advisory radio (HAR) system design should include all the equipment necessary for the operator to record verbal messages from onsite or remote locations, and to continually broadcast live, prerecorded, or synthesized messages from roadside transmission sites. HAR designs also include highway signs with remotely operated flashing beacons to notify motorists of HAR broadcasts.

The designer should be aware of the Federal Communications Commission (FCC) regulations in **CFR Title 47, Part 90.242**, pertaining to the operation of travelers' information stations. Additional information on licensing issues, frequency allocation, and other specifics can be obtained by contacting the FDOT ITS Telecommunications Office.

Radio waves are also propagated through the ground and grounding components are used to ensure peak performance. This necessitates a well-designed and well-constructed ground field, a circular space radiating from the antenna location. This design is critical to the successful operation of the HAR site, and may require a significantly sized circle around the antenna mast. An array of wiring emanating from the antenna mast radiates outward; ground assemblies at the end of each wire or cable are drilled into the ground.

Placement of a HAR installation should be determined by project-specific needs, as well as the following general design criteria:

1. Ability to transmit a meaningful message that can be received by motorists traveling through the broadcast zone.
2. Placement prior to freeway interchanges that offer alternate routes.
3. Placement in advance of high crash locations and traffic bottlenecks.
4. Placement that accommodates access for service and maintenance.
5. Placement along key commuter or evacuation corridors.

7.5.4.3 Road Weather Information System

A road weather information system (RWIS) receives input from an environmental sensor station (ESS) in the field to produce readings for temperature, precipitation, barometric pressure, wind speed and direction, visibility, and other variables. The designer should locate the ESS where its weather observations will be the most representative of the roadway segment of interest.

The ESS towers on which the weather instruments are mounted are frequently installed within a range of 30 to 50 feet from the roadway's edge to avoid the effects of passing traffic (e.g., heat, wind, splash), yet still be able to detect the weather conditions affecting motorists there. The location of ESS towers shall conform with the horizontal clearance requirements of **Table 2.11.10**.

Avoid standing water or locations where billboards, surrounding trees or other vegetation would affect the weather measurements. Median placement of an ESS on a divided highway is generally not feasible unless the median is 100 feet or wider. For more siting criteria, refer to the **FHWA's Road Weather Information System Environmental Sensor Station Siting Guidelines, Publication No. FHWA-HOP-05-026**, available at www.ops.fhwa.dot.gov/publications/ess05/index.htm.

At locations where the FDOT has Motorist Aid System towers, preference should be given in the design to mounting RWIS instruments on these structures. Also, consider the communication link the RWIS installation requires for transmitting the weather data. Options include twisted-pair copper wire, microwave, Ethernet communications over a fiber optic network, or use of a cellular telephone network.

7.5.5 Video Equipment

7.5.5.1 Closed-circuit Television Cameras

Closed-circuit television (CCTV) systems consist of roadside cameras, communication devices, as well as camera control and video display equipment at one or more remote monitoring locations that allow surveillance of roadway and traffic conditions

CCTV device placement and overall system design should be determined by project-specific needs, as well as the following general design criteria:

1. A camera should be strategically located to obtain a complete view of the freeway (keeping all ramps in mind) and to view the arterial traffic.
2. Camera location should provide the ability to view any nearby DMS for message verification.
3. A camera's location should provide the ability to view crossing features (i.e., streets, rail, bridges), as feasible.
4. Camera structures must be placed in accordance with **Section 2.11**.
5. Device placement should be such that it accommodates access for service and maintenance with minimal to no impact on traffic. For instance, the use of lowering devices to allow cameras to be lowered from the pole top to ground level for servicing with little or no disruption of traffic.

Designs and plans should consider and illustrate camera mounting height. Mounting height should be selected based upon project specific needs, as well as the following general design criteria:

1. Required viewing distance.
2. Roadway geometry and lane configuration.
3. Roadway classification (i.e., arterial or freeway).
4. Life-cycle cost, including maintenance impacts.
5. Environmental factors, such as glare from the horizon or from headlights.
6. Vertical clearance.

All camera housings, enclosures, lowering devices, and mounts must be designed to withstand sustained wind loads and gust factors according to **Chapter 29** of this volume.

CCTV camera poles should also be designed and installed according to the requirements of **Section 641, Prestressed Concrete Poles**, or **Section 649, Galvanized Steel Strain Poles, Mast Arms and Monotube Assemblies**, in the **FDOT Specifications**, and as depicted in **Index 17723** and **Index 17725** of the **Design Standards**.

Designs for support structures and foundations should be based on the **PPM** guidelines, the **Design Standards**, and on the **AASHTO LTS-4** standard with current addenda. The wind load requirements as specified in **Volume 9** of the **FDOT Structures Manual** should also be used as design criteria for CCTV structures and their associated foundations.

7.5.5.2 Video Display Equipment

Video display equipment is utilized in the TMC for viewing CCTV images and other information obtained from field locations. It is important to develop a display system design plan that is based on a detailed, documented analysis of the control center room dimensions, the operator's console desk layout, various distances from the operator's seating position to the video wall display, and the viewing angles to the display wall at the proposed mounting height for the display supporting structure.

The designer should consider any potential limitations introduced or imposed by existing facility construction that may hinder the installation of the video wall display. The video display components should be capable of being brought into the TMC control room and assembled in place without the Contractor having to make modifications to existing doorways, walls, floors, or ceilings.

7.5.6 Network Devices

Network devices utilized in ITS include a variety of Internet Protocol (IP)-addressable electronic equipment used for the collection and dissemination of video, traffic data, and other information.

Due to the critical nature of the network equipment described below, the complexity of the electronics, and harsh environmental conditions at installation locations, designs utilizing network devices should facilitate immediate replacement of defective or damaged units with minimal system downtime.

Consideration should be given to designs that promote open architecture, non-proprietary

systems, as well as survivability and reliability. Designers should consider solutions that provide immunity to single-point failure and implement redundant paths for reliability and survivability.

7.5.6.1 Managed Field Ethernet Switch

The managed field Ethernet switch (MFES) is an environmentally hardened field device that provides Ethernet connectivity from the remote ITS device installation location to the ITS network trunk interconnection point. Local connections from nearby Ethernet field devices or other cabinet electronics to the MFES are generally accomplished using CAT5e or CAT6 UTP cables connected to RJ-45 Ethernet ports on the MFES. However, when planning connections of the MFES to other Ethernet devices beyond a distance of 300 feet, fiber optic cabling from optical ports on the MFES is generally the preferred method. The designer should also consider fiber optic connection to devices outside the local cabinet if the design requires additional protection from transients or interference that may be induced on copper-based interconnects.

The design should provide an Ethernet port for the connection of each remote ITS field device. Field devices that typically connect to an MFES include, but are not limited to, CCTV camera systems, HAR field assemblies, vehicle detection systems, DMS, road weather information systems (RWIS), and traffic controllers.

7.5.6.2 Device Server

The device server encapsulates serial data in network packets and transports the packets across IP networks. Designs generally include device servers when remote field devices must connect to an Ethernet network, yet only possess serial communication interfaces.

Equipment that may require the use of device servers includes, but is not limited to, HAR field assemblies, DMS, vehicle detection systems, RWIS stations, and other low-speed data output devices

7.5.6.3 Digital Video Encoder and Decoder

Digital video encoders (DVEs) and digital video decoders (DVDs) are specialized network-based hardware devices and software that allow data signals and analog video to be encoded to digital format and transmitted across IP networks. These networks are designed so that the digitized video and data packets the DVE produces and places on the

network can be reconstructed (decoded) by hardware-based and software-based DVDs also attached to the network.

When designing a video and data transmission system incorporating DVE and DVD hardware with existing or planned network infrastructure, ensure that the system can transport video and data from multiple remote field locations simultaneously to multiple monitoring locations. If applicable, the designer should also seek to maintain video, data, and switching interoperability with legacy systems.

7.5.7 Fiber Optic Cable and Interconnect

The following sections describe the various fiber optic facilities that are used for device control and data communications between ITS field devices, TMCs, regional transportation management centers (RTMCs), and other identified stakeholder facilities. Designs that include network facilities should meet project-specific needs, as well as include the following information:

1. Facility diagrams illustrating facility routes.
2. General network topology.

7.5.7.1 Fiber Optic Cable

Fiber optic cable is utilized in the statewide ITS network infrastructure to provide data and device control communications between TMCs, RTMCs, ITS devices, and other identified stakeholder facilities. The designer should refer to Department specifications for material requirements of fiber optic cable and related material.

7.5.7.2 Fiber Optic Conduit

The type of fiber optic cable installation will determine the design for the conduit needed. For example, use polyvinyl chloride (PVC), fiberglass, or high-density polyethylene (HDPE) conduit for fiber optic cable that is exposed or placed underground along the roadway. Use HDPE SDR 11 conduit underground along the interstate. Use a UV-rated, flexible conduit to protect the cable in above-ground installations.

The design of the conduit should depict all required fittings and incidentals necessary to construct a complete installation. The conduit system should allow the fiber optic cable to maintain the minimum bend radius after installation.

7.5.7.3 Fiber Optic Splices and Terminations

Fiber optic splices provide a continuous optical path for transmission of optical pulses from one length of optical fiber to another. Designs and plans should identify splice points and provide splicing diagrams that detail the interconnection of specific fiber strands, their origination and final destination points, and expected link loss. The preferred method of presentation is a graphical format.

Fiber optic terminations connect the optical fibers housed within a cable to a fiber distribution panel (FDP) or a fiber patch panel (FPP). The FDP and FPP help connect the optical fibers to the electronic equipment and devices located throughout the network. Therefore, all fiber optic terminations should include the installation of a FPP or a FDP. Field terminations also include the installation of fiber optic connectors to the optical fibers if factory-installed connectors are not used.

7.5.7.4 Fiber Optic Cable Designating System

The fiber optic cable designating system provides visual notification of the presence of the underground fiber optic conduit/cable system, and provides a mechanism for electronically locating the physical presence of the conduit system below ground. The designating system provides a means to identify, locate, and protect the statewide fiber optic network between RTMCs, TMCs, ITS devices, and other facilities.

The designating system may consist of several components, including electronic markers, above-ground route markers, tone wire access points, buried cable warning tape, underground tracers, and tone wires. Design the designating system to support both high-power, office-based tone generators and portable field tone generators.

The design and construction of the designating system should consist of furnishing and installing the type, size, and quantity of system components as specified by the project, and meeting the following functional requirements based on project needs:

1. Provide visual notification of the presence of the conduit installed on FDOT projects.
2. Inform the public of potential hazards and provide contact information for conduit system marking prior to planned excavation.
3. Provide an end-to-end electrical conductor (tone wire) attached to the conduit system for conductive facility locating.
4. Provide above-ground access to the tone wire.

7.5.7.5 Fiber Optic Access Points

Fiber optic access points consist of splice boxes and pull boxes. They are utilized to provide access to the statewide fiber optic conduit system for the installation, operation, and maintenance of fiber optic cables between RTMCs, TMCs, ITS devices, and other identified stakeholder facilities. More information about pull and junction boxes is provided in **Section 635** of the **FDOT Specifications**.

Access point items should be planned and designed according to the type, size, and quantity necessary for the project. Design the access points to meet the following minimum functional requirements:

1. Provide at-grade access to fiber optic cables housed within conduit systems used for FDOT ITS communications.
2. Provide assist points to aid in fiber optic cable installation.
3. Provide protection for the fiber optic cable.
4. Provide adequate space for storing cable slack/coils and splice enclosures.
5. Make certain that pull boxes and splice boxes provide sidewall entry of the fiber optic cables.

Fiber optic access points should be placed at the following locations unless otherwise directed by the Engineer:

1. All major fiber optic cable and conduit junctions.
2. At all planned or future splice locations.
3. Every 2,500 feet in a continuous straight conduit section if no fiber optic cable splice is required.
4. At a maximum of 1,000 to 1,500 feet in metropolitan areas.
5. On each side of a river or lake crossing and at each end of a tunnel.
6. On each side of an above-ground conduit installation (i.e., attachment to bridge or wall).
7. All 90-degree turns in the conduit system.

Use splice boxes as the preferred access points on fiber optic cable backbone routes. Use pull boxes as the access points when the conduit system extending from the backbone to the ITS field devices requires an access point to house only fiber optic drop cables.

7.5.8 Infrastructure

7.5.8.1 Grounding and Transient Voltage Surge Suppression

Effective grounding and surge suppression is generally achieved through a combination of three primary techniques: proper bonding and installation of grounding rods, use of air terminals, and the application of a transient voltage surge suppressor (TVSS). These three methods work in concert to protect ITS equipment installed in the field and should be incorporated, as applicable, in ITS designs and plans.

Designs and plans should consider existing geological and other physical characteristics at proposed installation locations that may affect the design or layout of grounding systems. Information such as locations of rock formations, buried utilities, gravel deposits, soil types and resistivity, and presence of groundwater should be considered when developing plans that include these systems. Any pertinent survey data gathered during plans development, such as soil resistivity measurements, should be noted on the plans.

Placement and layout of grounding arrays should be planned in such a way that grounding paths from the down cable to the primary electrode are as straight as possible. Where practical, plans should provide detail related to cable routing and other installation details required to maximize the efficiency of Grounding and TVSS.

Grounding and TVSS device placement and overall system design should be determined by project-specific needs, as well as these general design criteria:

1. Follow best practices defined in the NFPA 780 Standard for the Installation of Lightning Protection Systems.
2. Place TVSS equipment so that grounding connections are as short and straight as possible.
3. Cable routing should avoid excessive bending and provide physical separation between low-voltage and high-voltage signal paths.
4. Avoid routing unprotected or grounding wires parallel or adjacent to protected wiring.

7.5.8.2 ITS Pole and Lowering Device

For installations of pole-mounted devices where height precludes easy access using a bucket truck, consider using a lowering device.

If designs call for a lowering device to be attached to an existing pole or similar structure, ensure that the design includes external conduit for housing the cabling, the necessary mounting box hardware at the top of the structure, and any other component details required for installation. Do not create designs that would require an operator to stand directly beneath equipment while it is being lowered.

The designer should consider the placement of all devices on the pole and how they affect the ability to utilize the lowering device.

7.5.8.3 ITS Field Cabinet

ITS field cabinets are designed and furnished to house any combination of several ITS devices installed along the roadway, including managed field Ethernet switches, hub switches, device servers, digital video encoders, vehicle detection system electronics, DMS communication devices, CCTV camera hardware, and power supplies for these items.

Final location of the cabinet should be based on safety of the motorist, visibility of roadside devices, and access by maintenance. ITS field cabinets can be base mounted on a concrete pad, structure mounted, or pole mounted.

The cabinet should be sized appropriately to accommodate the equipment to be installed inside. In addition, the cabinet design should take into account the ease of access to the equipment and the ability to achieve proper ventilation in order to maintain an internal operating environment that does not exceed the operating temperature ranges for the devices housed inside.

7.5.8.4 Equipment Shelter

An equipment shelter is utilized at the roadside to house network devices or telecommunications equipment that require a level of protection, security, or climate control beyond that is provided by typical ITS field cabinets. Equipment shelters are modular products manufactured from concrete or concrete composite and delivered to the installation site for placement on a prepared concrete slab. The location of equipment shelters shall conform with the horizontal clearance requirements of **Table 2.11.10**.

Though equipment shelters are prefabricated in large part, the designer must determine, and detail the site layout, including the shelter dimensions, site preparation work, fencing, landscape, conduit and pull box installation, as well as details for electrical, lighting, grounding, alarm, and HVAC systems necessary to accommodate the types and quantity of equipment the shelter will house. The design shall also include details that illustrate the equipment layout inside the shelter, including positioning of overhead cable trays, the quantity and placement of standard EIA/TIA 19-inch racks, demarcation and patch panels, and the equipment placement within each rack.

7.5.9 Vehicle Detection and Data Collection

The FDOT uses vehicle detectors along roadways to collect traffic information. Data from these detectors are used in the TMCs to initiate traffic control measures. There are various kinds of detectors available, each with its unique attributes and limitations. The four types described here are considered nonintrusive because their operation does not interfere with the flow of traffic, and installation does not require altering the roadway surface.

Prepare a design that details a complete detection assembly, including all other necessary components to be supplied and constructed. Detail in the drawings the exact location and placement of system components, and include installation details for the required cables. Design the cabling installation according to the manufacturer's recommendations.

7.5.9.1 Microwave Vehicle Detection System

The Microwave Vehicle Detection System (MVDS) is installed above ground on the side of the road (i.e., side-fire) for multilane detection, or over the travel lanes for single lane coverage only. This detection system uses a FCC-certified, but non-site licensed, low-power microwave radar beam to measure vehicle presence, volume, speed and occupancy.

7.5.9.2 Video Vehicle Detection System

The Video Vehicle Detection System (VVDS) measures vehicle presence, volume, occupancy, and speed by analyzing video signals generated by the video camera used to detect traffic.

Besides vehicle detection, the VVDS can also function as a roadway surveillance device. When surveillance capability is desired, dual-use VVDS systems are used. In the surveillance mode, these systems automatically turn off the vehicle detection functions.

The recommended deployment geometry for optimal video detection and surveillance requires that there be an unobstructed view of each travel lane where detection and surveillance are required. Though optimal results can be achieved when the cameras are directly above the travel lane, the cameras are not required to be directly over the roadway.

Cameras can be positioned so they can view either approaching or receding traffic or both in the same field of view. The preferred orientation for optimal detection is the view of approaching vehicles because there are more high-contrast features on vehicles viewed from the front than from the rear. Cameras should be positioned high enough to minimize the effects of occlusion from closely spaced vehicles and to avoid glare from the horizon.

7.5.9.3 Magnetic Traffic Detection System

The Magnetic Traffic Detection System (MTDS) relies on magnetic sensors or probes that are placed in conduits under the road surface. A probe is a transducer that converts changes in the vertical component of the earth's magnetic field to changes in inductance in a loop. Vehicles on the road surface increase the vertical component of the earth's magnetic field at the detection point when they move over the sensor. The increased magnetic field changes inductance in a loop connected to the sensor, and the system converts this input into traffic data.

7.5.9.4 Acoustic Vehicle Detection System

The Acoustic Vehicle Detection System (AVDS) utilizes a passive acoustic sensor that measures traffic parameters by detecting vehicle-generated acoustic signals. The AVDS can be mounted over the travel lane on a bridge or a mast arm, or on roadside poles or sign structures for a side-fire mounted configuration.

Acoustic detection systems measure traffic flow parameters for five adjacent lanes on a lane-by-lane basis. The system can identify acoustic signals from approaching vehicles with a different signal level and a different wave front angle (i.e., arrival angle) than that of passing vehicles that are leaving the detection area. The system also processes acoustic signals generated by stationary (i.e., idling) vehicles in real time.

The detection system can also be used to emulate a dual-loop speed trap configuration for speed measurement.

THIS PAGE LEFT BLANK INTENTIONALLY

7.6 Foundation Design

For foundations for standard conventional Roadway Lighting Poles, refer to the **Design Standards, Index 17515**. Refer to the **Design Standards, Index 17503** for foundations for non-standard conventional Roadway Lighting Poles. **Section 715** of the **Specifications** allows the screw type foundation as an alternate. The Geotechnical Engineer shall determine whether the soil characteristics meet the requirements of **Section 715**. If it is determined that the soil conditions do not allow the use of the screw type foundation as shown in **Section 715**, a note shall be added to the plans stating: "Use of the screw type foundation is not allowed on this project."

The **Design Standards, Index Nos. 17743 and 17745** include foundations for standard Mast Arm Assemblies. Unique site circumstances may require the foundation variables to be modified from the foundations shown. If custom designs are required, the Geotechnical Engineer shall provide the soil information to be used by the District Structures Design Engineer during the design phase of the project.

The foundation design and drawings where special foundations are required for locations where standard Mast Arm Assemblies are used and for overhead sign structures, high mast light poles, and traffic signal strain poles shall be the responsibility of the Structures Engineer of Record (EOR). The Geotechnical Engineer shall provide the EOR the following soils information (this information may be derived from the borings of other nearby structures or from roadway borings):

1. Soil Type
2. Effective Unit Weight of the Soil
3. Seasonal High Water Table Elevation
4. Effective Friction Angle of the Soil (if applicable)
5. Cohesion Value (if applicable)
6. Allowable Bearing Capacity (if applicable)

The above soils information shall be included in the plans. Additionally, Soil Boring Data Sheets shall be included in the plans, except for strain poles. This will provide the Contractor with the conditions for which the foundations were designed as compared to actual on-site conditions and establish criteria for any future analysis of the foundations.

THIS PAGE LEFT BLANK INTENTIONALLY

Chapter 8

Pedestrian, Bicycle and Public Transit Facilities

8.1	General	8-1
	8.1.1 Pedestrians and Bicyclists	8-1
	8.1.2 Transit	8-3
8.2	References	8-4
8.3	Pedestrian Facilities	8-5
	8.3.1 Sidewalks	8-5
	8.3.2 Disability Considerations	8-6
	8.3.3 Crosswalks	8-7
	8.3.3.1 Crosswalks at Intersections	8-7
	8.3.3.2 Midblock Crosswalks	8-8
8.4	Bicycle Facilities	8-10
	8.4.1 Bicycle Lanes	8-10
	8.4.2 Paved Shoulders	8-11
	8.4.3 Wide Curb Lanes	8-11
	8.4.4 Bicycle Lane Between Through Lane and Right Turn Lane, Bus Bay or Parking Lane	8-12
	8.4.5 Bicycle Route Systems	8-12
8.5	Drainage and Utility Considerations	8-13
8.6	Shared Use Paths	8-13
	8.6.1 Considerations	8-13
	8.6.2 Widths	8-14
	8.6.3 Cross Slopes	8-14
	8.6.4 Grades	8-15
	8.6.5 Horizontal Clearance	8-15

8.6.6	Vertical Clearance.....	8-16
8.6.7	Design Speed	8-16
8.6.8	Horizontal Alignment.....	8-16
8.6.8.1	Minimum Radii	8-16
8.6.8.2	Stopping Sight Distance.....	8-16
8.6.9	Vertical Alignment	8-17
8.6.10	Separation Between Shared Use Path and Roadway	8-17
8.6.11	Path Railings	8-17
8.6.12	Lighting	8-18
8.6.13	Signing, Pavement Marking, and Signalization.....	8-18
8.7	Bridges, Overpasses, and Underpasses.....	8-19
8.8	Drop-off Hazards for Pedestrians and Bicyclists.....	8-21
8.9	Florida Intrastate Highway System Limited Access Facilities ...	8-22
8.10	Public Transit Facilities	8-23
8.10.1.	Curb-Side Facilities.....	8-23
8.10.2	Street-Side Facilities	8-23
Tables		
Table 8.1.1	Bicycle Facilities.....	8-2
Table 8.6.4	Maximum Grade Lengths.....	8-15
Table 8.6.8.1	Minimum Radii for Shared Use Paths.....	8-16
Table 8.6.8.2	Minimum Stopping Sight Distances	8-17
Figures		
Figure 8.1	Pedestrian/Shared Use Path Bridge Typical Section	8-25
Figure 8.2	Drop-Off Hazards for Pedestrians and Bicyclists	8-26
Figure 8.3	Bus Stop Categories	8-27

Chapter 8

Pedestrian, Bicycle and Public Transit Facilities

8.1 General

8.1.1 Pedestrians and Bicyclists

It is the goal of the Department and in accordance with **Section 335.065, Florida Statutes, Bicycle and pedestrian ways along state roads and transportation facilities:**

- “(1)(a) Bicycle and pedestrian ways shall be given full consideration in the planning and development of transportation facilities, including the incorporation of such ways into state, regional, and local transportation plans and programs. Bicycle and pedestrian ways shall be established in conjunction with the construction, reconstruction, or other change of any state transportation facility, and special emphasis shall be given to projects in or within 1 mile of an urban area.
- (b) Notwithstanding the provisions of paragraph (a), bicycle and pedestrian ways are not required to be established:
1. Where their establishment would be contrary to public safety;
 2. When the cost would be excessively disproportionate to the need or probable use;
 3. Where other available means or factors indicate an absence of need.”

Projects that comply with the design criteria contained within the PPM are considered to meet the requirements of the statute. If the design criteria contained within the PPM for pedestrian and bicycle facilities are not met, a Design Variation is required. The documentation shall reference which of the three conditions under **Section 335.065 (1)(b), Florida Statutes** support not providing a bicycle or pedestrian facility.

Sidewalks and shared use paths are appropriate pedestrian facilities for all types of projects and locations. **Table 8.1.1** identifies appropriate bicycle facilities for various types of projects.

Table 8.1.1 Bicycle Facilities

Location	Condition	Type of Work		
		New Construction, Reconstruction	Resurfacing, Restoration, Rehabilitation (RRR) ^{1, 2, 3}	Traffic Operations, Intersection Improvements
In or within one mile of an urban area	All	Bicycle Lane	Bicycle Lane or Wide Curb Lane	Bicycle Lane or Wide Curb Lane
Beyond one mile of an urban area	Curb and gutter (DS ≤ 45mph)	Bicycle Lane	Bicycle Lane or Wide Curb Lane	Bicycle Lane or Wide Curb Lane
	All other	Bicycle Lane or Paved Shoulder	Bicycle Lane, Paved Shoulder or Wide Curb Lane	Bicycle Lane, Paved Shoulder or Wide Curb Lane

1. Widening of existing curbed sections for the project length to provide bicycle facilities may disproportionately affect the scope and cost of a RRR project, especially if reconstruction of the curb, sidewalk, and/or drainage system is required, additional right of way is needed, or utilities are impacted. No Design Variation is necessary, however, a statement similar to the following shall be included in the project file:

“Bicycle facilities have been considered for this project but will not be provided, due to insufficient width between existing curb lines to provide bicycle facilities without substantial reconstruction of the roadway, drainage system and sidewalk (and/or requires additional right of way). Reconstruction (and/or right of way acquisition) is outside the scope of this project.”

2. Substantial widening of an existing curbed section is outside the scope of a RRR project and is considered reconstruction.

3. See **Section 25.4.19** for options that shall be considered on RRR projects with existing roadways where no widening is planned.

Bicyclists and pedestrians should be expected on all of Florida's state roadways except where restricted on limited access facilities and interstate highways (**Section 316.091 Florida Statutes**).

Decisions on appropriate pedestrian and bicycle facilities shall be determined with input from the District Pedestrian/Bicycle Coordinator, throughout the project development and implementation process. Further coordination may also be necessary with the District Americans with Disabilities Act (ADA) Coordinator.

When considering other available means, the alternate route or facility should include accommodation for cyclists and pedestrians which meet the design criteria for bicycle and pedestrian facilities on state roadways, and provide access to the same services, origination and destination sites, and transit connections as the project corridor. The alternate route shall not result in a significant increase in travel time or trip length, exposure to motorized traffic or substantial elevation changes. If the alternate route requires the pedestrian or bicyclist to cross limited access, arterial or collector roadways, or rail corridors, appropriate crossing locations shall be provided.

8.1.2 Transit

For projects within the operational limits of a local transit agency service area, consideration should be given to connectivity of pedestrian and bicycle facilities with transit stops. Bicycle access to transit facilities should be provided because most bus service has bike-on-bus (bicycle rack) capability.

Decisions on appropriate pedestrian and bicycle facilities to connect with transit service shall be determined with input from the District Pedestrian/Bicycle Coordinators, District Modal Development Office Coordinators, District Americans with Disabilities Act (ADA) Coordinators, and the District Public Transportation staff. Where there is a demand for pedestrian and bicycle facilities, there could also be a demand for public transit or public transportation facilities. Public transit street side facilities should be considered in all phases of a project, including planning, preliminary design and engineering, design, and construction. Coordination with the District Modal Development Office and/or the local public transit provider(s) will help determine the need for and justification of bus bays and transit shelters on a project by project basis.

Multimodalism is the ultimate goal of the Department. The integration of public transit street facilities along with pedestrian and bicycle facilities furthers the implementation of this goal. Additional information on the design of transit facilities can be found in **Accessing**

Transit, Design Handbook for Florida Bus Passenger Facilities, Version 2, 2008.

Federal and State legislation provide the stimulus for planning, designing, and constructing a fully integrated transportation system benefiting the traveling public and the environment. Examples of legislation include ***The Safe, Accountable, Flexible, and Efficient Transportation Equity Act – A Legacy for Users (SAFETEA-LU)***, ***The Federal Transit Act***, as amended, ***The Americans with Disabilities Act of 1990 (ADA)***, and ***The Clean Air Act Amendment of 1990 (CAAA)***. In response to this legislation, the surface transportation system should provide for concurrent use by automobiles, public transit and rail, and to the extent possible, bicycles and pedestrians. Throughout the entire process, coordination with transit is essential.

8.2 References

1. ***Manual on Uniform Traffic Control Devices (MUTCD)***
2. ***Design Standards***
3. ***FDOT Pedestrian Planning and Design Handbook***
4. ***FDOT Bicycle Facilities Planning and Design Handbook***
5. ***FDOT Trail Intersection Design Handbook***
6. ***AASHTO Guide for the Development of Bicycle Facilities***
7. ***Highway Capacity Manual***
8. ***Americans With Disabilities Act (ADA)/Florida Accessibility Code for Building Construction (FACBC)***
9. ***Uniform Vehicle Code (UVC)***
10. ***AASHTO LRFD Bridge Design Specifications, Current Edition***
11. ***AASHTO Guide for the Planning, Design, and Operation of Pedestrian Facilities***
12. ***Transportation Research Board (TRB). Guidelines for the Location and Design of Bus Stops adapted from TCRP Report 19. Washington D.C.: National Academy Press***
13. ***Accessing Transit, Design Handbook for Florida Bus Passenger Facilities, Version 2, 2008***
14. ***Transit Facilities Guidelines on the Public Transportation Office website***
15. ***FDOT Structures Manual, Current Edition***
16. ***FHWA's Roundabouts: An Informational Guide***

8.3 Pedestrian Facilities

All roadways and bridges where pedestrian travel is expected should have separate walking areas such as sidewalks or shared use paths that are outside the vehicle travel lanes. Refer to **Section 8.6** for shared use paths.

8.3.1 Sidewalks

Sidewalks are walkways parallel to the roadway and designed for use by pedestrians. Generally, sidewalks should be constructed along both sides of arterial roadways that are not provided with shoulders, even though pedestrian traffic may be light. However, the construction of sidewalks on both sides of the street would not be required in such cases as when the roadway parallels a railroad or drainage canal and pedestrians would not be expected. If sidewalks are constructed on the approaches to bridges, they should be continued across the structure. If continuous sidewalks are constructed on only one side of the street, pedestrians should be provided access to transit facilities located on the opposite side of the street.

The minimum width of a sidewalk shall be 5 feet on both curb and gutter and flush shoulder roadways. The minimum separation for a 5-foot sidewalk from the back of curb is 2 feet. If the sidewalk is located adjacent to the curb, the minimum width of sidewalk is 6 feet.

Grades on sidewalks should not exceed 5% when not adjacent to a travel way. There should be enough sidewalk cross slope to allow for adequate drainage, however the maximum shall be no more than 2% to comply with ADA requirements. Where practical, a 1-foot level area should be provided adjacent to the sidewalk. Edge drop-offs should be avoided. When drop-offs cannot be avoided, they should be shielded as discussed in **Section 8.8**.

A 5-foot wide sidewalk that connects a transit stop or facility with an existing sidewalk or shared use path shall be included to comply with ADA accessibility standards.

Particular attention should be given to pedestrian accommodations at the termini of each project. If full accommodations cannot be provided due to the limited scope or an existing sidewalk isn't present at the termini, then temporary measures should be considered such as extending the sidewalk and project limits to next appropriate pedestrian crossing or access point. If special accommodations are made, it is equally important to address these measures on the adjoining projects. In all cases, the District Pedestrian/Bicycle Coordinator shall be contacted for input on making a determination regarding continuous passage.

New sidewalks should be placed as far from the roadway as practical in the following sequence of desirability:

1. As near the right of way line as possible.
2. Outside of the clear zone.
3. Five feet from the shoulder point on flush shoulder roadways or six feet from the back of curb to eliminate the need to narrow or reroute sidewalks around driveways.
4. As far from edge of traffic lane as practical.

Nearing intersections, the sidewalk should be transitioned as necessary to provide a more functional crossing location that also meets driver expectation. Further guidance on the placement of stop or yield lines and crosswalks is provided in the **MUTCD** and the **Design Standards**.

8.3.2 Disability Considerations

Pedestrian facilities must be designed in accordance with ADA to accommodate people with disabilities. Refer to the **Design Standards** for additional details.

Pull boxes, manholes (and other utility covers), and other types of existing surface features in the location of a proposed curb ramp should be relocated when feasible. When relocation is not feasible, the feature shall be adjusted to the new ramp to meet the ADA requirements for surfaces (including the provision of a non-slip top surface, and adjustment to be flush with and at the same slope as the curb ramp).

The detectable warning systems on the QPL are designed to work with concrete surfaces. In areas where the pedestrian facility has an asphalt surface, such as a shared use path, the engineer must specify an appropriate detectable warning system. In these cases, consider including a short section of concrete that will accommodate any system.

To assist pedestrians who are visually or mobility impaired, curb ramps should be parallel to the crossing. By providing ramps parallel to the crossing, the pedestrian is directed into the crossing. At intersections where more than one road is crossed, each crossing should have a separate curb ramp. Under no circumstance shall a curb ramp be installed allowing a pedestrian to enter a crossing without providing a curb cut (or at grade sidewalk if no curb is present) on the opposite side of the crossing. Crossings shall also meet the same grade and cross slope requirements as sidewalks where the grade should not exceed 5%, and the maximum cross slope shall be no more than 2%.

8.3.3 Crosswalks

Crosswalks occur at all intersections, whether or not they are marked and on any portion of a roadway distinctly indicated for pedestrian crossing by lines or other markings on the surface. Reasonable accommodation should be made to make crossings both convenient and safe, and minimize the pedestrian's exposure in the roadway. Crosswalks are defined in ***Florida Statutes 316.003(6)***.

There are a number of treatments that may be used to help pedestrians safely across the street, whether crossing at an intersection or midblock. A marked crosswalk is one of these tools. Marking of crosswalks helps drivers better identify the intersection, guides the pedestrian to the best crossing location and provides guidance for people with low vision.

The criteria provided in this section do not apply to school crossings.

Additional guidance on marked crosswalks can be found in the ***AASHTO Guide for the Planning, Design, and Operation of Pedestrian Facilities*** and ***FHWA's Safety Effects of Marked vs. Unmarked Crosswalks at Uncontrolled Locations: Executive Summary and Recommended Guidelines*** (http://safety.fhwa.dot.gov/ped_bike/docs/cros.pdf).

8.3.3.1 Crosswalks at Intersections

Marked crosswalks shall be provided at all side streets where a pedestrian facility meets the roadway. As roadway volumes, speeds and number of travel lanes increase, marked crosswalks are best used in conjunction with other treatments (including signals, signs, beacons, curb extensions, raised medians, refuge islands, and enhanced overhead lighting).

When right turn lanes are used, place crosswalks so that an approaching motorist has a clear view of the pedestrian, and the crossing distance is minimized.

All marked crosswalks at uncontrolled locations (without signals, stop or yield signs) shall be coordinated with the District Traffic Operations Office and meet the guidelines of the ***FDOT Traffic Engineering Manual***. Marked crosswalks on an uncontrolled leg of an intersection shall be supplemented with other treatments (including beacons, curb extensions, raised medians, raised traffic islands, or enhanced overhead lighting) when any of the following conditions exist:

1. Where posted speeds are greater than 40 mph.

2. On a roadway with 4 or more lanes without a raised median or raised traffic island that has an ADT of 12,000 or greater.
3. On a roadway with 4 or more lanes with a raised median or raised traffic island that has or is projected to have (within 5 years) an ADT of 15,000 or greater.

Roundabouts present a unique challenge for the design of pedestrian crossings. In a roundabout, the crosswalk markings should comply with the *MUTCD*, *FHWA's Roundabouts: An Informational Guide* and the *FDOT Traffic Engineering Manual*.

8.3.3.2 Midblock Crosswalks

Midblock crosswalks can be used to supplement the pedestrian crossing needs in an area between intersections. This can provide pedestrians with a more direct route to their destination. When used, midblock crosswalks should be illuminated, marked and signed in accordance with the *MUTCD, Traffic Engineering Manual (Section 3.8)* and *Index 17346, Design Standards*. Pedestrian-activated, signalized midblock crosswalks may be appropriate at some locations, but the locations must meet the warrants established in the *MUTCD*.

In addition to the requirements in *Section 8.3.3.1*, the following conditions also apply:

1. Midblock crosswalks should not be located where the spacing between adjacent intersections is less than 660 feet
2. Midblock crosswalks should not be located where the distance from the crosswalk to the nearest intersection (or crossing location) is less than 300 feet
3. Midblock crosswalks shall not be provided where the crossing distance exceeds 60 feet (unless a median or a crossing island is provided)
4. Midblock crosswalks shall not be provided where the sight distance for both the pedestrian and motorist is not adequate (stopping sight distance per *Table 2.7.1*)
5. Midblock crosswalks shall not be located where the ADA cross slope and grade criteria along the crosswalk cannot be met (per *Section 8.3.2*).

An engineering study is required before a marked midblock crosswalk is installed at an uncontrolled location. This study shall examine such factors as sight distance for pedestrians and vehicles (stopping sight distance), traffic volume, turning volumes near proposed crosswalk location, roadway width, presence of a median, lighting, landscaping, drainage, traffic speed, adjacent land use (pedestrian generators / destinations), pedestrian volume and existing crossing patterns. Midblock crosswalks should only be used in areas

where the need truly exists, and the engineering study will help to determine if an uncontrolled midblock crosswalk is a viable option. Refer to the Department's ***Manual on Uniform Traffic Studies (MUTS)***.

If any problem areas are identified that would preclude the placement of a justified midblock crosswalk, additional features must be included in the design to remedy those problem areas before a midblock crosswalk can be placed at that location. Features like overhead signing can help alert motorists and be used to light the crossing. Curb extensions or bulb-outs can improve sight distance and decrease the crossing distance. Adjustment of the profile on the roadway crossing may be required to improve the cross slope of the crosswalk.

8.4 Bicycle Facilities

Appropriately designed and located bicycle facilities play an important role in supporting safe bicycle travel. Bicycle facilities include bicycle lanes, paved shoulders, wide curb lanes, shared use paths, traffic control devices, and bicycle parking facilities.

Measures that can considerably enhance a corridor's safety and capacity for bicycle travel are:

1. Providing bicycle facilities.
2. Maintaining a smooth, clean riding surface, free of obstructions. This includes ensuring drainage inlets and utility covers that cannot be moved out of the travel way are flush with grade, well seated, and use bicycle-safe grates and covers.
3. Responsive and appropriate traffic control devices, consistent with guidance in the **MUTCD**, including providing bicycle oriented directional signage.

8.4.1 Bicycle Lanes

Where required by **Table 8.1.1**, a bicycle lane shall be provided for each direction of travel on the roadway. On flush shoulder roadways, the paved shoulder described in **Section 8.4.2** shall be marked as a bicycle lane in or within 1 mile of an urban area. Bicycle lanes shall be marked in accordance with **Design Standards** and the **MUTCD**.

On curb and gutter roadways, a 4-foot minimum bicycle lane width measured from the lip of the gutter is required. This provides for a 5.5-foot width to the face of curb when FDOT Type F curb and gutter is used. The 1.5-foot gutter width should not be considered as part of the rideable surface area, but this width provides useable clearance to the curb face. A minimum width of 5 feet shall be provided when the bicycle lane is adjacent to on-street parking, a right-turn lane, guardrail or other barrier. Bicycle lanes shall be one-way facilities and carry bicycle traffic in the same direction as adjacent motor vehicle traffic. On one-way streets, bicycle lanes should generally be placed on the right side of the street. A bicycle lane on the left side of the street can be considered if it will substantially reduce the number of potential conflicts, such as those caused by frequent bus traffic, heavy right-turn movements, high-turnover parking lanes, or if there is a significant number of left-turning bicyclists.

8.4.2 Paved Shoulders

A paved shoulder is a portion of a roadway which has been delineated by edge line striping, but does not include special pavement markings or signing for the preferential use by bicyclists. Paved shoulders shall be 5 feet in width for new construction, reconstruction and RRR projects, however existing 4-foot paved shoulders on RRR projects may be retained. A paved shoulder of at least 4 feet in width is considered to be a bicycle facility, however a minimum 5-foot clear width between the traveled way and the face of curb, guardrail or other roadside barrier is required.

8.4.3 Wide Curb Lanes

Wide outside curb lanes are through lanes which provide a minimum of 14 feet in width. This width allows most motor vehicles to pass cyclists within the travel lane, which is not possible in more typical 10-foot to 12-foot wide travel lanes. Wide curb lanes do not meet Department requirements for bicycle facilities on new construction or reconstruction projects. However, in some conditions, such as RRR projects, they may be the only practical option for a bicycle facility.

8.4.4 Bicycle Lane Between Through Lane and Right Turn Lane, Bus Bay or Parking Lane

In new construction, reconstruction and traffic operations projects, at locations with right turn lanes, bus bays or parking lanes, a 5-foot bicycle lane shall be provided between the through lane and the right turn lane, bus bay or parking lane. For bicycle lanes adjacent to parking lanes, if the parking volume is substantial or the turnover is high, an additional 1 to 2 feet of width should be provided for the bicycle lane if right of way is adequate.

When a RRR project includes the addition or modification of a right turn lane, bus bay or parking lane, a 5-foot bicycle lane shall be provided between the through lane and the right turn lane, bus bay or parking lane if existing right of way is adequate. On RRR flush shoulder projects where the approaching paved shoulder is 4 feet wide, a minimum width of 4 feet is acceptable for a bicycle lane between the through lane and right turn lane.

When a RRR project has an existing right turn lane without a bicycle lane between the through lane and right turn lane, bus bay or parking lane, a bicycle lane should be provided. Factors to be considered include the opportunity to provide a continuous alignment, reduce the potential for conflicts with turning vehicles, and availability of right of way.

8.4.5 Bicycle Route Systems

Bicycle route systems are linked by signs to aid bicyclists. Bicycle route systems are ineffectual unless signs are highly specific, giving a clear indication of destination. It may be advantageous to sign some urban and rural roadways as bicycle route systems. Bicycle route signing should not end at a barrier. Information directing the bicyclists around the barrier should be provided.

The decision whether to provide bicycle route systems should be based on the advisability of encouraging bicycle use on a particular road, instead of on parallel and adjacent roadways. The roadway width, along with factors such as volume, speed, types of traffic, parking conditions, grade, sight distance and connectivity to transit, should be considered when determining the feasibility of bicycle route systems. Roadway improvements such as adequate pavement width, drainage grates, railroad crossings, pavement surface, maintenance schedules and signals responsive to bicycles should always be considered before a roadway is identified as a bicycle route system. Further guidance on signing bicycle route systems is provided in the *MUTCD*.

8.5 Drainage and Utility Considerations

Drainage inlets, grates and utility covers are potential problems to bicyclists. When a new roadway is designed, all such grates and covers should be kept out of the bicyclists' expected path. Refer to the **Design Standards** for required grates and inlet tops.

See **Chapter 2** of this volume for horizontal clearances for light poles.

8.6 Shared Use Paths

Shared use paths are typically facilities on exclusive rights of way and with minimal cross flow of motor vehicles. They are almost always used by pedestrians, joggers, in-line skaters, bicyclists, and in some cases equestrians. However, the bicycle's operating characteristics will dictate the design of shared use paths. The criteria in this section apply to paved shared use paths. The term *path* as used in this section refers to these paved shared use paths. An example typical design is provided for guidance in **Volume 2, Exhibit TYP-15**.

Shared use paths should be thought of as extensions of the highway system that are intended for the exclusive or preferential use of bicycles and pedestrians in much the same way as freeways are intended for the exclusive or preferential use of motor vehicles. Well-planned and designed paths can provide good pedestrian and bicycle mobility.

Shared use paths can serve a variety of purposes. They can provide a school age child or a bicycle commuter with a shortcut away from busy roadways. They can provide recreational cyclists a peaceful place to ride, away from motor vehicle traffic. Shared use paths can be located along abandoned railroad rights of way, the banks of rivers and other similar areas. They can provide bicycle access to areas that are otherwise served only by limited access highways and closed to bicycles.

8.6.1 Considerations

Shared use paths adjacent to a roadway may be considered if the following conditions are met:

1. The path will be separated from the roadway.
2. There will be few access points or roadways crossing the path.
3. There will be adequate access to local streets and other facilities along the path.
4. There is a commitment to provide path continuity with other bikeways throughout the corridor.

Shared use paths are not replacements for on-street bicycle lanes. Within a roadway right of way, bicycle lanes are the safest, most efficient bicycle facility. When paths are located immediately adjacent to roadways, some operational problems are likely to occur:

1. Paths require one direction of bicycle traffic to ride against motor vehicle traffic, which is contrary to the normal Rules of the Road. Motorists are not in the habit of scanning for traffic from that direction.
2. At path ends, bicyclists riding against traffic will tend to continue to travel on the wrong side of the street, as do bicyclists getting on to a path. Wrong-way travel by bicyclists is a major cause of bicycle/automobile crashes and should be discouraged.
3. Many bicyclists will use the roadway instead of the path because they have found the roadway to be safer, less congested, more convenient, or better maintained.

8.6.2 Widths

The minimum width of a one-directional shared use path is 6 feet. It should be recognized, however, that one-way paths will often be used as two-way facilities unless effective measures are taken to assure one-way operation.

The minimum width for a two-way shared use path is 12 feet. Under certain conditions it may be necessary or desirable to increase the width of a path due to substantial use by bicyclists, joggers, skaters and pedestrians, by large maintenance or emergency vehicles and steep grades. Only under severe constraints should providing less than 12 feet be considered.

8.6.3 Cross Slopes

Since pedestrian use is expected on shared use paths, ADA requirements must be met. Therefore, the maximum cross-slope should be 2%. The maximum cross-slope for a path used exclusively by bicyclists is 6%.

8.6.4 Grades

To meet ADA the maximum grade is 5%. Grades greater than 5% should be considered ramps and designed accordingly. Maximum ramp slopes are 8.33% and can have a maximum rise of 30 inches, with a level landing at least 60 inches in length.

To accommodate bicycles exclusively, grades should not exceed 5%, since steeper grades cause difficulties for many bicyclists. If the terrain makes it necessary to use steeper grades on short sections, the following restrictions are recommended:

Table 8.6.4 Maximum Grade Lengths

Grade (%)	Maximum Length
6%	For up to 800 feet
7%	For up to 400 feet
8%	For up to 300 feet
9%	For up to 200 feet
10%	For up to 100 feet
11+%	For up to 50 feet

NOTE: When using a longer grade, 4 to 6 feet of additional width should be added to the path to allow some bicyclists to dismount and walk their bikes. Additional clear distances should be provided and sight distances must be modified to accommodate longer grades.

Refer to **Section 8.6.9** for controls on grade changes.

8.6.5 Horizontal Clearance

A 4-foot horizontal clearance to lateral obstructions shall be maintained on both sides of a shared use path. A 2-foot wide graded area with a maximum 1:6 slope shall be maintained adjacent to both sides of the path.

Edge drop-offs should be avoided. When drop-offs cannot be avoided they should be shielded as discussed in **Section 8.8**.

8.6.6 Vertical Clearance

The vertical clearance to obstructions should be a minimum of 8 feet. However, vertical clearance may need to be greater to permit passage of maintenance and emergency vehicles. In underpasses and tunnels, 10 feet is desirable.

8.6.7 Design Speed

A design speed of 20 mph should normally be used. When a downgrade exceeds 4 percent, a design speed of 30 mph should be considered.

8.6.8 Horizontal Alignment

8.6.8.1 Minimum Radii

The effective superelevation is usually limited to the existing 2% cross slope and may be positive or negative. If a transition is needed, then a minimum 75-foot transition should be used. See **Table 8.6.8.1** for minimum radii for shared use paths.

Table 8.6.8.1 Minimum Radii for Shared Use Paths

Design Speed	Superelevation	Friction Factor	Minimum Radius (ft.)
20	2%	0.27	95
20	-2%	0.27	110
30	2%	0.22	250
30	-2%	0.22	300

8.6.8.2 Stopping Sight Distance

The minimum stopping sight distances for a shared use path are given in **Table 8.6.8.2**. For a shared use path the object height is assumed 0.0 feet and the eye height is 4.5 feet.

Table 8.6.8.2 Minimum Stopping Sight Distances

MINIMUM STOPPING SIGHT DISTANCE (FEET) FOR 20 MPH PATH = 127 FEET, FOR 30 MPH PATH = 230 FEET														
Design Speed	GRADES													
	-9%	-8%	-7%	-6%	-5%	-4%	-3%	3%	4%	5%	6%	7%	8%	9%
20 MPH	Use 30 MPH Values					137	134	121	119	118	116	115	114	113
30 MPH	298	287	277	268	260	Use 20 MPH Values								

8.6.9 Vertical Alignment

The minimum length of vertical curve necessary to provide minimum stopping sight distance at various speeds on crest vertical curves is selected by using the formula listed below:

$$\text{When } S > L: \quad L = 2S - (900 / A) \quad L = \text{Min. Length of Vertical Curve (ft.)}$$

$$A = \text{Algebraic Grade Difference (\%)}$$

$$\text{When } S < L: \quad L = AS^2 / 900 \quad S = \text{Stopping Sight Distance (ft.)}$$

8.6.10 Separation Between Shared Use Path and Roadway

When two-way shared use paths are located adjacent to a roadway, a separation shall be provided. This demonstrates to both path users and motorists that the shared use path is a separate facility.

On roadways with flush shoulders, this separation is 5 feet measured from the outside edge of shoulder to the inside edge of the path. On roadways with curbs, the separation is 4 feet measured from the back of curb to the inside edge of the path, with consideration of other roadside obstructions (signs, light poles, etc.).

8.6.11 Path Railings

Railings or fences shall be provided as indicated in **Section 8.8**.

8.6.12 Lighting

Lighting for shared use paths is important and should be considered where riding at night is expected, such as paths serving college students or commuters, and at roadway intersections. Lighting should also be considered through underpasses or tunnels. Lighting standards are provided in **Table 7.3.1** of this volume.

8.6.13 Signing, Pavement Marking, and Signalization

The **MUTCD** shall be consulted for all signage, pavement markings, and signals, especially on path/roadway intersections.

8.7 Bridges, Overpasses, and Underpasses

A bridge, an overpass, or an underpass may be necessary to provide pedestrian/bicycle continuity to sidewalks, bicycle lanes and shared use paths. Bicyclists should be accommodated at all pedestrian bridges (e.g., provide an alternative to stairs).

The overpass or bridge design shall be in accordance with the criteria established below:

1. **FDOT Structures Design Guidelines – Chapter 10.**
2. **Section 8.2** of this volume.
3. The minimum clear width for new FDOT pedestrian bridges is:
 - a. On a pedestrian structure - 8 feet.
 - b. On a shared use path structure - 12 feet.
 - c. If the approach sidewalk or path is wider than these minimums, the clear width of the structure should match the approach width. The desirable clear width should include an additional 2-foot wide clear area on each side.
4. Vertical clearance criteria shall be as per **Chapter 2, Table 2.10.1** of this volume. Horizontal clearances shall take into affect future widening plans of the roadway below.
5. Ramps
 - a. Comply with ADA requirements. See the **Production Support Office - Accessibility Issues (ADA) Website:**
<http://www.dot.state.fl.us/projectmanagementoffice/>
 - b. Ramps (routes with grades>5%) should be provided at all pedestrian separation structures. When possible, stairways should be provided in addition to ramps.
 - c. Design ramps with the least possible grade, but in no case more than 8.33% and with 5 feet long, intermediate level platforms at a maximum 30-inch rise. Provide level platforms 5 feet long at the top of the ramp and 6 feet long at the bottom.
 - d. Provide full-length pedestrian ADA handrails on both sides of pedestrian ramps.
6. Fencing/Railing
 - a. Provide fencing/railing options in accordance with the **SDG Chapter 10.**

- b. Provide full or partial screening on pedestrian bridges crossing FDOT right of way in order to reduce the likelihood of objects being dropped or thrown onto the roadway below. See **Figure 8.1** for example of full screening.
- c. Pedestrian bridges on FDOT right of way but not crossing FDOT right of way are not required to be screened.
- d. Check with local authorities for guidance on screening for FDOT pedestrian bridges crossing local rights of way.
- e. The use of chain link fence on ramps of the pedestrian bridges will be determined on a project-by-project basis.

See **Chapter 26** for review requirements based on pedestrian bridge structure category.

Pedestrian underpasses are generally undesirable; however, if one is required, the geometrics and lighting requirements should be discussed with the Department Project Manager and the District Pedestrian/Bicycle Coordinator. Local law enforcement personnel may need to be consulted to assure public safety, emergency accessibility and other desirable features.

8.8 Drop-off Hazards for Pedestrians and Bicyclists

Drop-off hazards are defined as steep or abrupt downward slopes that can be perilous to pedestrians and bicyclists. The Engineer should consider shielding any drop-off determined to be a hazard. Generally, pedestrians and bicyclists will be adequately protected from a drop-off hazard if a guardrail or barrier has been installed between the path or sidewalk and the drop-off. However, circumstances do exist that will ultimately dictate when a railing is needed. Railings or fences should be provided for vertical drop-off hazards. The horizontal clearance discussed in **Section 8.6.5** should be maintained where practical when railings or fences are used for drop-offs along shared-use paths.

The following guidelines will be useful in standardizing the identification and treatment of drop-off hazards for pedestrians and bicyclists.

There are two cases that require shielding. As shown in **Figure 8.2 (Case 1)**, a drop-off greater than 10 inches that is closer than 2 feet from the pedestrians' or bicyclists' pathway or edge of sidewalk should be considered a hazard and shielded. Also, as shown in **Figure 8.2 (Case 2)**, a slope steeper than 1:2 that begins closer than 2 feet from the pedestrians' or bicyclists' pathway or edge of sidewalk should be considered a hazard and shielded when the total drop-off is greater than 30 inches. Also, depending on the depth of the drop-off and severity of the conditions below, shielding may be necessary for cases other than described above.

However, in determining if shielding a drop-off hazard would be feasible for protecting pedestrians and bicyclists, the following should be considered:

1. The engineer should ask the Pedestrian/Bicycle Coordinator for information on pedestrian and bicyclist traffic and their routes.
2. Installing fencing or railings are two ways to shield the drop-offs. Fencing is generally intended for rural areas along paths and trails. Standard railing is generally intended for urbanized areas, locations attaching to bridge rail or along concrete walkways. Railings* shown on **Index 850** and **860 Series** of the **Design Standards** are appropriate for all drop-offs. **Indexes 870** and **880** of the **Design Standards** are appropriate where drop-offs are 30 inches or less.
 - * Note: Care should be taken when using railings or fencing near intersections as they could obstruct the driver's line of sight.
3. Along continuous sections where the drop-off varies above and below the 30" threshold for using **Index 870** or **880**, for uniformity the engineer should consider using only one of the railing types appropriate for all drop-offs (**Index 850** or **860 Series**).

4. The height of railings for bicyclists are generally the same as the minimum pedestrian railing height of 42 inches, except a minimum 54 inch railing or fence should be considered on bridges and retaining walls for special circumstances as identified in the commentary of the ***AASHTO LRFD Bridge Design Specifications Section 13.9***. Specify the height of the pedestrian/bicycle railing in the contract plans.

8.9 Florida Intrastate Highway System Limited Access Facilities

Department Procedure No. 525-030-250, Development of the Florida Intrastate Highway System (FIHS), provides guidance relating to the provisions for bicycle and pedestrian facilities on the FIHS. The Procedure states: “Bicycle and pedestrian facilities shall not be provided on FIHS limited access roadways.”

8.10 Public Transit Facilities

When a project includes a public transit route, curb side and street side transit facilities for bus stops should be considered in the roadway design process.

The FDOT *Accessing Transit: Design Handbook for Florida Bus Passenger Facilities* provides guidance relating to provisions for curb side and street side facilities. Refer to **Table 2.11.9** for criteria on the placement of shelters and benches.

8.10.1. Curb-Side Facilities

Curb-side facilities are the most common, simplest and convenient form of facilities at a bus stop. These include bus stop signs, passenger waiting shelters, bus stop wheelchair access pad, curb ramps, benches, leaning rails, and shelter lighting. **Chapter 1 of Accessing Transit** provides additional details for each facility. Coordination with the District Modal Development Office and/or local public transit provider(s) is necessary in developing the plans.

8.10.2 Street-Side Facilities

Bus stop locations can be categorized as far-side, near-side and midblock stops. Bus stops may be designed with a bus bay or pullout to allow buses to pick up and discharge passengers in an area outside of the travel lane. This design feature allows traffic to flow freely without the obstruction of stopped buses. See **Figure 8.3** for typical detail for the bus stop categories. **Chapter 2 of Accessing Transit** provides additional details for each facility.

The greater distance placed between waiting passengers and the travel lane increases safety at a stop. Bus bays are encouraged on roadways with high operating speeds, such as roads that are part of the Urban Principal Arterial System. For a particular bus stop, a high frequency of crashes involving buses is a good indicator for the need of a bus bay. Bus bays are classified as closed, open or bulbs. See **Figure 8.3** for typical detail for the bus bay categories. Detailed standard drawings for various bus bay configurations are provided in the *Transit Facilities Guidelines* on the Public Transportation Office website: <http://www.dot.state.fl.us/transit/>

At a specific location, a balance must be obtained based on the designer's judgment and input from the applicable transit agencies. In locations where the traffic volumes exceed

1,000 vehicles per hour per lane, it is difficult to maneuver the bus into the bay and back into the travel lane. Incorporating an acceleration distance, signal priority, or a far-side (rather than near-side or midblock) placement, are potential solutions when traffic volumes exceed 1,000 vehicles per hour per lane.

The total length of the bus bay should allow room for an entrance taper, a stopping area, and an exit taper as a minimum. However, in some cases it may be appropriate to consider providing acceleration and deceleration lanes depending on the volume and speed of the through traffic. This decision should be based upon site specific conditions. ***Accessing Transit*** provides detailed bus bay dimensions for consideration when right of way is unlimited and access points are limited.

Figure 8.1 Pedestrian/Shared Use Path Bridge Typical Section

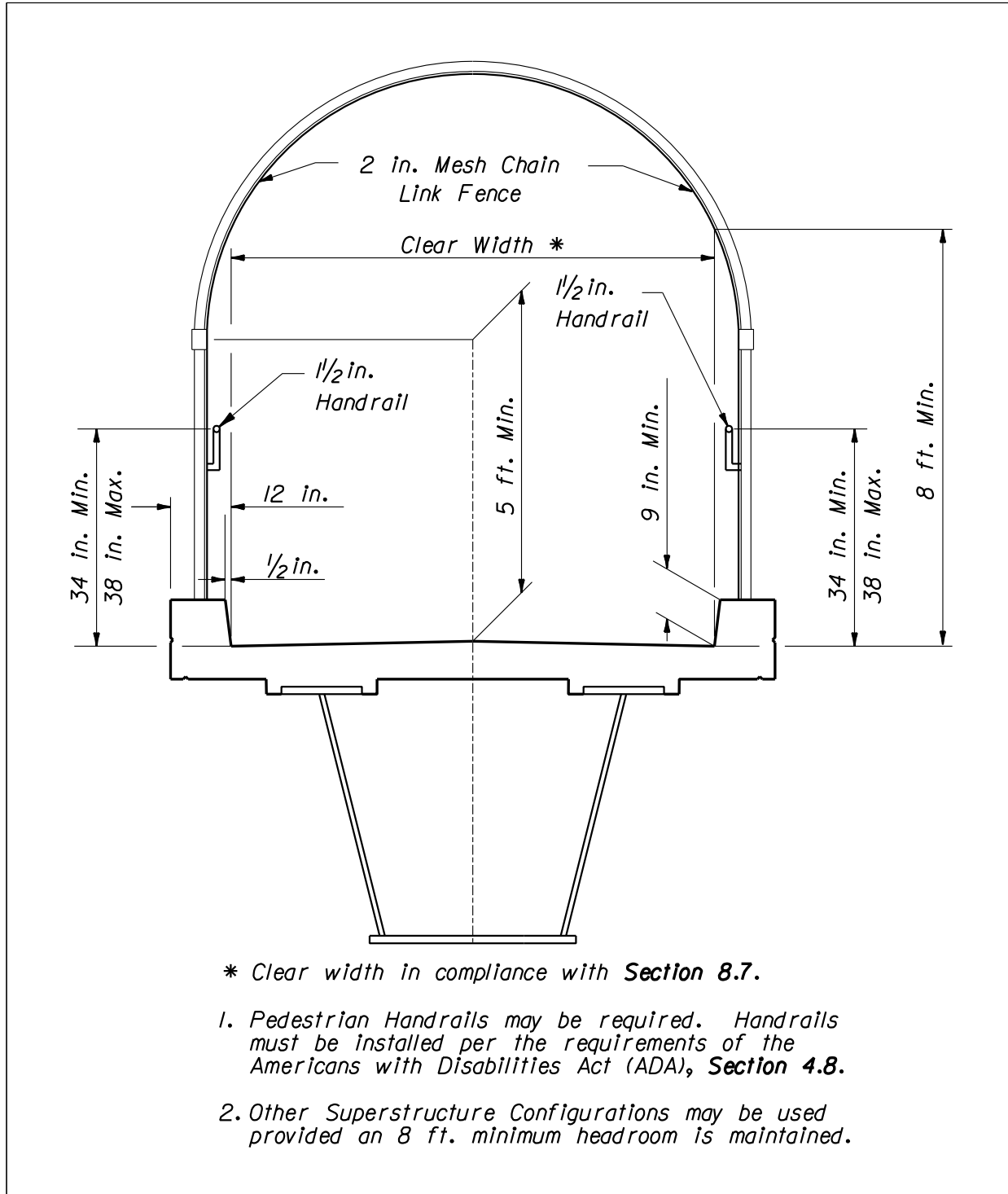

Figure 8.2 Drop-Off Hazards for Pedestrians and Bicyclists

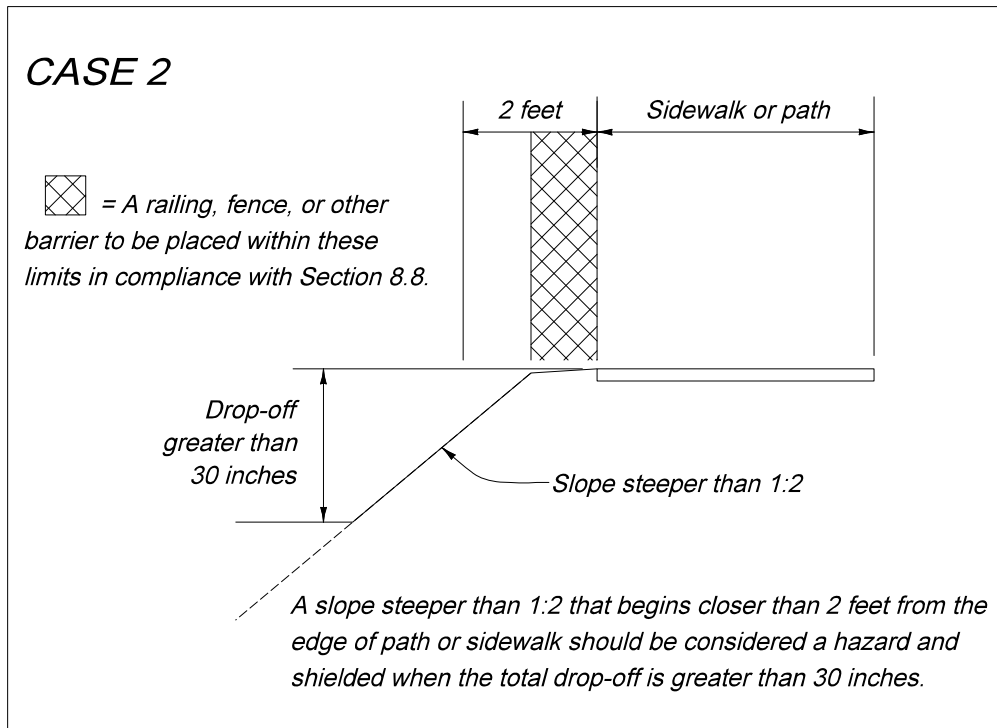
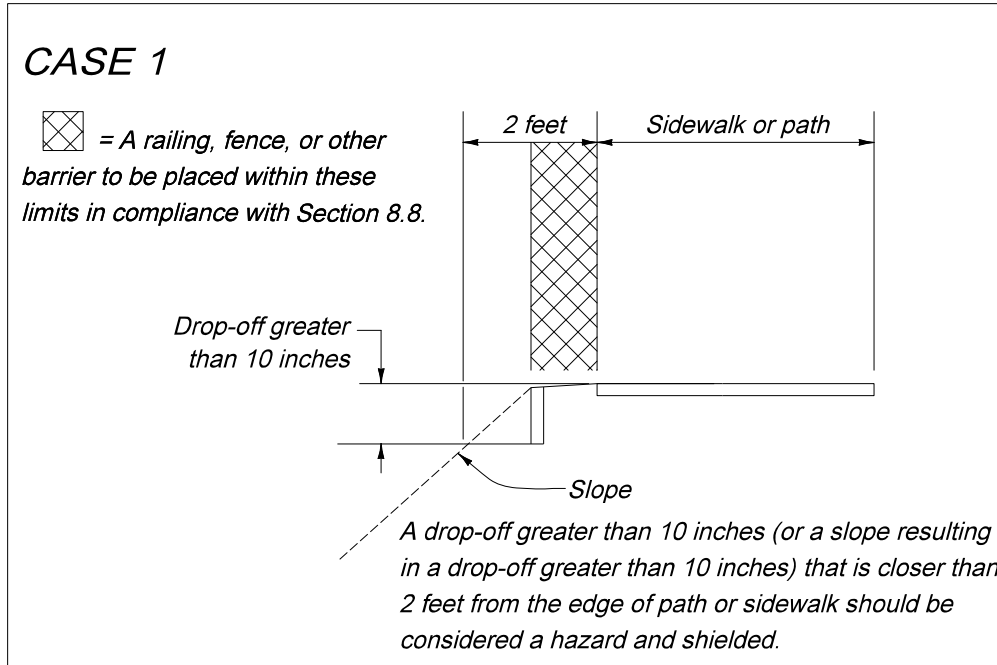
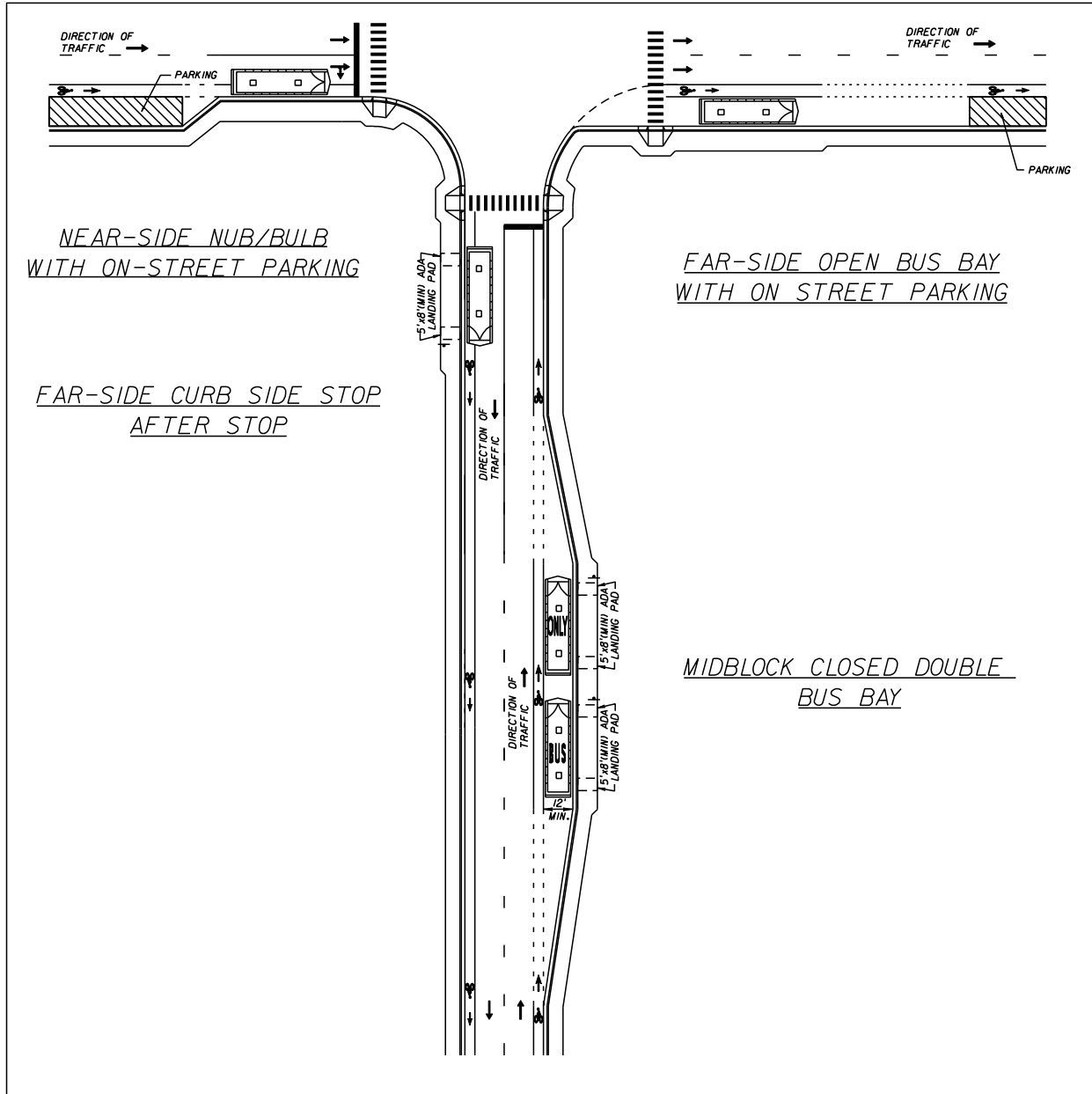

Figure 8.3 Bus Stop Categories



THIS PAGE LEFT BLANK INTENTIONALLY

Chapter 9

Landscape

9.1	General	9-1
9.2	Maintenance Plan	9-5
9.3	Cost Estimate	9-6
9.4	Community Structures.....	9-7
9.4.1	Design Criteria	9-8

THIS PAGE LEFT BLANK INTENTIONALLY

Chapter 9

Landscape

9.1 General

"Landscape" or "Landscaping" means any vegetation, mulches, irrigation systems, and any site amenities, such as, street furniture, specialty paving, tree grates, walls, planters, fountains, fences, and lighting (excluding public utility street and area lighting), as defined in **Rule Chapter 14-40.003, Florida Administrative Code, Highway Beautification and Landscape Management**. Community Identification Structures are also considered landscape site amenities and are discussed in **Section 9.4**.

Landscape plans should be designed to complement and enhance the natural and man-made environment. This may include irrigation systems and site amenities such as street furniture and specialty pavement, tree grates, walls, planters, fountains, fences, and lights.

To the extent practical, plans should consider the following elements:

1. Conservation of natural roadside growth (vegetation) and scenery.
2. Relocation of existing vegetation.
3. Selective clearing and thinning of existing vegetation.
4. Natural regeneration and succession of native plants.
5. Plants purchased from Florida based nurseries.
6. Large plants (plants equivalent or larger than those grown in 5 gallon containers) with combined value of 50% or more of the estimated value of all plants specified in the plans.
7. Florida native plants with known provenance (original source of plants stock) to be as close to planting site as possible.
8. Plant selection and placement that:
 - a. improves safety (e.g., reducing headlight glare, reducing worker exposure, discouraging midblock pedestrian crossing, etc.)
 - b. preserves visibility of signage
 - c. minimizes roadside maintenance requirements
 - d. reduces stormwater runoff volume and velocity

- e. promotes water conservation
 - f. minimizes impacts to natural areas
 - g. minimizes soil erosion
 - h. avoids conflicts with existing and proposed above and below ground utilities
9. Reclaimed water for irrigation.
10. Recycled and recyclable materials.

The Landscape should be designed to permit sufficiently wide, clear, and safe pedestrian walkways, bicycle ways, and transit waiting areas. Care should be exercised to ensure that requirements for sight distances and clearance to obstructions are observed, especially at intersections.

Landscape plans must be designed, constructed and maintained in conformity with the **Manual on Uniform Traffic Control Devices**, the **Standard Specifications for Road and Bridge Construction**, the **Design Standards**, and this manual. No landscaping shall screen from view a legally permitted outdoor advertising sign. The limits of the screening prohibition are provided in **Section 479.106(6), Florida Statutes**. Additional information is found in **Rule Chapter 14-40, Florida Administrative Code (F.A.C.)**. Landscape plans require a temporary traffic control plan in accordance with FDOT **Design Standards** (see **Chapter 10** of this volume).

When a legally erected and permitted outdoor advertising sign is within the project limits (adjacent to the right of way), and there is no permitted view zone, the landscape architect will notify the sign permittee that a highway landscape project is proposed. An example letter and other useful information are available at www.myfloridabeautiful.com. The sign permittee will have 30 days to establish a view zone by submitting an **Application to Permit Vegetation Management at Outdoor Advertising Sign** (form **650-050-06**) that proposes a view zone (see **Rule Chapter 14-40, Part III, F.A.C.**) If an **Application to Permit Vegetation Management at Outdoor Advertising Sign** is submitted within 30 days, a view zone will be established in accordance with the provisions of **Rule Chapter 14-40** upon approval of the application by the Department. If the sign owner does not respond to the notice within the 30-day time frame provided, and the specific location of the view zone is not established by permit or agreement, the view zone will be within an area beginning at a point on the edge of pavement perpendicular to the edge of the sign facing nearest the highway and continuing in the direction of approaching traffic for a distance of 350 feet for posted speed limits of 35 miles per hour or less and 500 feet for posted speed limits over 35 miles per hour (see **Section 479.106(6), F.S.**). Contact information for any permitted sign may be obtained by contacting the State Outdoor Advertising Administrator, Florida Department of Transportation, 605 Suwannee Street, MS 22, Tallahassee, Florida 32399-0450.

9.1.1 References

Additional information regarding landscape plans may be found in:

1. www.MyFloridaBeautiful.com
2. **Highway Beautification Policy # 000-650-011**
3. **Rule Chapter 14-40, Florida Administrative Code, Highway Beautification and Landscape Management.**
4. **Florida Highway Landscape Guide.**
5. **Highway Landscape, Beautification, and Plan Review Procedure (Topic No. 650-050-001).**
6. **Identification & Biology of Non-Native Plants in Florida's Natural Areas,** Langeland and Burks, 1998, University of Florida.
7. **Waterwise Florida Landscapes,** 2001, Florida's Water Management Districts.
8. **Transit Cooperative Research Program Report 19 – Guidelines for the Location and Design of Bus Stops** (for additional guidance in areas where transit is present).
9. **Florida's Best Native Plants; 200 Readily Available species,** Gil Nelson, 2003, University Press of Florida
10. **Florida Power and Light - Right Tree for Right Place:**
http://www.fpl.com/residential/trees/right_tree_right_place.shtml
11. **FDOT Voluntary Code of Conduct** regarding Invasive exotic plants
12. **Florida Accessibility Code for Building Construction**
13. **FDOT Utility Accommodation Manual**
14. **FDOT Drainage Manual**

9.2 Maintenance Plan

A performance based maintenance plan for all proposed landscape improvements must accompany the landscape plans. This may be on separate plan sheets or written documents. This maintenance plan will not be part of the construction contract documents, and does not affect the contractor's responsibility for plant establishment during the warranty period. The maintenance plan is intended to make sure that the landscape architect and the agency responsible for maintenance understand what resources and practices will be necessary to maintain the landscape in a safe and vigorous condition that meets the project objectives many years after construction is completed. The intent of design elements, such as to screen a view, maintain a clear sight distance, or assist with water retention, must be included in a description of the project, accompanied by a written or graphic guide describing the performance requirements of the maintaining agency. The maintenance plan shall define the limits of the maintenance activities that will be performed. The maintenance plan must also include performance requirements necessary to maintain and manage the following:

1. sight distance
2. horizontal and vertical clearance
3. accessibility,
4. plant health, form, height and spread
5. turf (mowing)
6. mulch thickness and cover
7. edges
8. weeds and litter
9. irrigation system(s)
10. erosion control
11. irrigation
12. hardscape, lighting, benches, and site amenities
13. other requirements necessary for the design intent to be fulfilled.

When necessary, the maintenance plan must include a temporary traffic control plan.

When the landscape project is to be maintained by the Department, a maintenance cost estimate based on anticipated maintenance activities must be attached to the plans. When the landscape project is to be maintained by a local governmental entity, the maintenance plan will become an exhibit to the maintenance agreement. The local government should participate during development of the maintenance plan.

For Landscape Plan contents refer to **Chapter 26** of **Volume 2**.

9.3 Cost Estimate

A cost estimate for all proposed landscaping must accompany the landscape plans. This must be on separate plan sheets or written documents. This cost estimate will not be part of the construction contract documents. The cost estimate is intended solely for use by the Department.

The cost estimate must break out the total cost for large plants and total cost for small plants as defined in ***Volume 2, Chapter 26, Landscape Plans***. The totals must include all incidental costs associated with the landscape plans.

9.4 Community Structures

Community Structures are designed and placed on the highway right of way for the sole purpose of representing, reflecting, or recognizing nearby community cultural and/or natural values and resources, or to enhance the sense of place through which a highway passes. The following criteria do not apply to Place Name Signs or Customized Place Name Signs. Requirements for Place Name Signs and Customized Place Name Signs are in **Rule 14-51 Part IV Place Name Signs**:

http://www.dot.state.fl.us/trafficoperations/Operations/Studies/TEM/14-51_PartIV.shtm

A proposed Community Structure located on the Interstate System must be approved by the State Roadway Design Engineer and the Federal Highway Administration (FHWA). A proposed Community Structure located on the State Highway System but not on the Interstate System can be approved by the District Design Engineer without further approvals if consistent with the established criteria.

For consideration, plans for a proposed Community Structure must be accompanied by a resolution of the local government legislative body endorsing their financial support of project design, construction, and perpetual project maintenance. If private funding is to be used, local endorsement is also required.

Prior to any construction within the highway right of way, the local government (or private enterprise) must execute a maintenance agreement with the Florida Department of Transportation.

These features are not eligible for regular federal-aid. They would not be eligible for repair or replacement under FHWA's Emergency Relief (ER) program.

Any changes to the FDOT's criteria shall be reviewed and approved by FHWA. Approval by the State Roadway Design Engineer is required when any of the Community Structure criteria in **Section 9.4.1** cannot be met.

9.4.1 Design Criteria

The design of a Community Structure must meet the following:

1. The structures/features site plan should be laid out so as to strongly discourage drivers from stopping to take pictures, or otherwise create an unsafe situation by stopping on the shoulder.
2. The location must be as far outside the appropriate clear zones as practical. Placement on Interstate routes should be well outside the minimum clear zone, a minimum of 50 feet, 100 feet preferred, from edge of the travel lane or ramp, whether guardrail is present or not. The 50 feet minimum/100 feet preferred lateral placement will help to minimize driver distraction, and reduce the likelihood that vertical structures will become storm debris blown across the roadway.
3. Structures shall not be placed in the median regardless of median width.
4. The object's highest point must not be greater in elevation than 14 feet above the nearest point of the roadway.
5. The structures must not contain any messages (alpha-numeric characters), signs, other traffic control features, auditory devices, flashing lights, or moving illumination, and be devoid of advertising per the **MUTCD** and **23CFR 1.23** which prohibits advertising on or commercial use of the right of way. Commercial advertising on state right of way is prohibited by **Section 479, Florida Statutes**, including charitable, fraternal, religious, or political signs, symbols, logo's, banners or any other such device. The permit for the Community Structure shall be immediately revoked by the Department for violation of this provision.
6. Only one structure is allowed per mainline interchange approach; thus, pick one site from amongst the ramp and the mainline, along the outside of a ramp, or the area inside a loop ramp.
7. The structure must meet all applicable building codes and design criteria for similar structures or landscapes placed adjacent to the highway's right of way, including wind loading commensurate with highway signs in the area.
8. The structures/features must meet all environmental regulations.
9. The structure must not obstruct any signs or interfere with any sight triangle or view zone (see **Section 9.1**).

Chapter 10

Transportation Management Plan

10.1	General	10-1
10.2	References.....	10-2
10.2.1	Design Standards.....	10-2
10.3	Transportation Management Plan (TMP).....	10-3
10.3.1	Transportation Management Plan Components	10-7
10.3.1.1	Temporary Traffic Control (TTC) Plans.....	10-7
10.3.1.1.1	TTC Plan Development	10-9
10.3.1.1.2	TTC Plan Phase Submittals... ..	10-12
10.3.1.2	Transportation Operations (TO).....	10-13
10.3.1.3	Public Information (PI)	10-14
10.4	Coordination.....	10-16
10.5	Work Zone Traffic Control Training	10-17
10.5.1	Background.....	10-17
10.5.2	Training Requirements.....	10-17
10.6	Traffic Control Devices	10-18
10.7	Signs	10-19
10.7.1	Advance Warning Signs.....	10-19
10.7.2	Length of Construction Sign.....	10-19
10.7.3	Project Information Sign.....	10-19
10.7.4	Existing Signs	10-19
10.8	Lighting Units	10-21
10.8.1	Warning Lights	10-21
10.8.2	Advance Warning Arrow Panels	10-21

10.8.3	Changeable Message Signs	10-22
10.8.4	Traffic Signals	10-27
10.9	Channelizing Devices.....	10-28
10.9.1	Type III Barricades	10-28
10.9.2	Separation Devices.....	10-28
10.9.3	Channelizing Device Alternates	10-28
10.10	Pavement Markings	10-29
10.10.1	Removing Pavement Markings	10-29
10.10.2	Raised Retro-Reflective Pavement Markers (RPM)	10-29
10.10.3	Work Zone Markings	10-29
10.11	Safety Appurtenances for Work Zones	10-30
10.11.1	Traffic Barriers.....	10-30
10.11.2	Barrier Walls (Temporary).....	10-30
10.11.3	End Treatments.....	10-32
10.11.4	Modifications of Existing Barriers	10-32
10.11.5	Crash Cushions.....	10-32
10.12	Temporary Traffic Control Plan Details	10-34
10.12.1	Taper Lengths	10-34
10.12.2	Intersecting Road Signing and Signals	10-35
10.12.3	Sight Distance to Delineation Devices	10-36
10.12.4	Pedestrians and Bicyclists	10-36
	10.12.4.1 Pedestrian Considerations.....	10-36
	10.12.4.2 Bicycle Considerations.....	10-38
10.12.5	Superelevation	10-38
10.12.6	Lane Widths	10-39
10.12.7	Lane Closure Analysis	10-39
10.12.8	Traffic Pacing Design.....	10-53
10.12.9	Detours, Diversions, and Lane Shifts.....	10-66

10.12.10	Above Ground Hazards.....	10-67
10.12.11	Drop-offs in Work Zones	10-67
10.12.12	Narrow Bridges and Roadways.....	10-67
10.12.13	Existing Highway Lighting	10-68
10.12.14	Work Area Access.....	10-68
10.12.15	Railroads.....	10-69
10.12.16	Pay Items and Quantities	10-69
10.13	Speed Zoning	10-71
10.13.1	Regulatory Speeds in Work Zones	10-71
10.14	Law Enforcement Services	10-73
10.14.1	Use of Speed and Law Enforcement Officers	10-73
10.14.2	Use of Traffic Control Officer.....	10-74
10.14.3	Coordination, Documentation and Payment	10-74
10.14.4	Other Uses of Law Enforcement.....	10-75
10.15	Motorist Awareness System (MAS).....	10-76
10.15.1	Portable Regulatory Signs (PRS).....	10-76
10.15.2	Radar Speed Display Unit (RSDU)	10-77
10.15.3	Speed and Law Enforcement Officer	10-77

Tables

Table 10.12.1	Taper Length Criteria for Work Zones.....	10-35
Table 10.12.2	Minimum Radii for Normal 0.02 Cross Slopes	10-38

Exhibits

Exhibit 10-A	Changeable Message Signs Worksheet	10-24
Exhibit 10-B	Lane Closures	10-41
Exhibit 10-C	Traffic Pacing	10-54

THIS PAGE LEFT BLANK INTENTIONALLY

Chapter 10

Transportation Management Plan

10.1 General

The need to improve the capacity of, and to rehabilitate Florida's highways, has greatly increased the frequency of highway construction taking place immediately adjacent to or under traffic. The traveling public, as well as construction and inspection personnel, are exposed to conflicts that may become hazardous. In addition to the safety issue, the potential delays to the public, as traffic is interrupted by construction, can be significant. As a result, the Department places a great deal of emphasis upon ensuring that all traffic, including motorists, transit operations, bicyclists and pedestrians can be accommodated through construction zones with minimum delay and exposure to unsafe conditions.

10.2 References

The following references contain the basic criteria and other required information for work zone traffic control in Florida:

1. The ***Manual on Uniform Traffic Control Devices for Streets and Highways, (MUTCD)***, Federal Highway Administration. ***Part VI*** of the ***MUTCD*** deals specifically with work zone traffic control. Other parts of the ***MUTCD*** may also be useful in designing a temporary traffic control plan.
2. ***Policy on Geometric Design of Highways and Streets, AASHTO.***
3. ***Roadside Design Guide, AASHTO, Chapter 9.***
4. ***Design Standards, Indexes 412, 414, 415, 417 and the 600 Series.***
5. ***Standard Specifications for Road and Bridge Construction.***
6. ***Basis of Estimates Manual.***

10.2.1 Design Standards

The ***Design Standards, Index 600 Series***, contains information specific to the Federal and State guidelines and standards for the preparation of temporary traffic control plans and for the execution of traffic control in work zones, for construction and maintenance operations and utility work on the State Highway System. Certain requirements in the ***Design Standards*** are based on the high volume nature of state highways. For highways, roads and streets off the State Highway System, the local agency (city/county) having jurisdiction, may adopt requirements based on the minimum requirements provided in the ***MUTCD***.

10.3 Transportation Management Plan (TMP)

A Transportation Management Plan (TMP) is a method for minimizing activity-related traffic delay and accidents by the effective application of traditional traffic handling practices and an innovative combination of public and motorist, bicyclist and pedestrian information, demand management, incident management, system management, construction strategies, alternate routes and other strategies.

All TMPs share the common goal of congestion relief during the project period by managing traffic flow and balancing traffic demand with highway capacity through the project area.

TMPs are required for significant projects which are defined as:

1. A project that, alone or in combination with other concurrent projects nearby, is anticipated to cause sustained work zone impacts.
2. All Interstate system projects within the boundaries of a designated Transportation Management Area (TMA) that occupy a location for more than three days with either intermittent or continuous lane closures shall be considered as significant projects.

For significant projects, a multi-discipline TMP team may be formed to handle the planning, coordination, implementation, monitoring, and evaluation details of the TMP elements. Depending on the project logistics, the team composition may vary from project to project. The TMP team may include representatives from the entities as follows:

1. PD& E
2. Design
3. Traffic Operations
4. Construction
5. Transit
6. FHWA
7. Local government (county and/or city)
8. Public Information
9. Others as deemed necessary (e.g., State Police, hospitals, etc.).

A TMP consists of strategies to manage the work zone impacts of a project. Its scope, content, and degree of detail may vary based upon the expected work zone impacts of the project. For significant projects a TMP will consist of three components: (1) Temporary Traffic Control (TTC) plan component (2) Transportation Operations (TO) component and (3) Public Information (PI) component. For individual projects that have less than significant work zone impacts, the TMP may consist only of a TTC plan, although it is encouraged to consider TO and PI issues for all projects. When multiple projects are in the same corridor or on corridors within the same traffic area, it may be possible to develop a single corridor or regional TMP.

1. The Temporary Traffic Control plan component describes TTC measures to be used for facilitating road users through a work zone or an incident area. The TTC plan plays a vital role in providing continuity of reasonably safe and efficient road user flow and highway worker safety when a work zone, incident, or other event temporarily disrupts normal road user flow. The scope of the TTC plan is determined by the project characteristics. The TTC plan shall either be a reference to specific Design Standard Index drawing(s) or be designed specifically for the project.
2. The Transportation Operations component of the TMP shall include the identification of strategies that will be used to mitigate impacts of the work zone on the operation and management of the transportation system within the work zone impact area. Typical TO strategies may include, but are not limited to, demand management, corridor/network management, safety management and enforcement, and work zone traffic management. The scope of the TO component should be determined by the project characteristics.
3. The Public Information component of the TMP shall include communications strategies that seek to inform affected road users, the general public, area residences and businesses, and appropriate public entities about the project, the expected work zone impacts, and the changing conditions on the project. This may include traveler information strategies. The PI component may be integrated in the project's Community Awareness Plan (CAP) if the district's CAP guidelines include communications strategies addressed above. The scope of the PI component should be determined by the project characteristics.

Public information should be provided through methods best suited for the project, and may include, but not be limited to, information on the project characteristics, expected impacts, closure details, and commuter alternatives.

Public information campaigns serve two main purposes in TMPs. They inform the public about the overall purpose of the project to generate and maintain public support; and they

encourage changes in travel behavior during the project to minimize congestion. Because they give travelers the information they need to make their own travel choices; public information campaigns can be the single most effective of all TMP elements.

TMPs should be developed and implemented in sustained consultation with stakeholders e.g., other transportation agencies, railroad agencies/operators, transit providers, freight movers, utility suppliers, police, fire, emergency medical services, schools, business communities, and regional transportation management centers.

Consideration of TMPs must begin at the Project Development and Environmental (PD&E) study stage. Impacts on traffic, traffic handling options, constructability, and design features and constraints, as they affect traffic and transit operations, are to be evaluated for each alternate alignment studied. The Project Development Summary Report (PDSR) must specifically address the TMP.

As the design progresses, using the TMP material from the PD&E study as the basis, the following should be considered:

Design features and constraints. Length of the project, lane configuration, transit stops, bicycle lanes, sidewalks and grade differentials between existing and proposed, interchanges and intersections, pavement materials, storm drains, roadway lighting, utilities and bridge features are some of the design element decisions that might be influenced by work zone traffic control considerations.

Contract specifications. Provisions such as time restrictions on construction activities; incentive-disincentive clauses; daily, weekly and seasonal restrictions and special materials may be necessary. Time restrictions could include work stoppages for Manatee (or other endangered/protected species) inhabitation, sporting events, holidays or other special considerations. The designer should coordinate with local agencies as to the dates of local events or other community sensitive issues. Public relations activities such as media releases, television and radio spots, and handbills may be specified.

Other actions. Actions may need to be taken by the Department prior to or during construction that may not be a contract requirement. Examples are dealing with the media and local businesses, provisions for mass transit options to commuters, service patrols, improvements to alternate routes, coordination with other projects and maintenance activities, and special inspection requirements.

Public input. On very large and complicated projects, it may be necessary to involve the public through informal public meetings to be held early in the design of a project. Close coordination with city and county officials may be necessary. Citizen and business advisory committees may be established as sources of input.

Utility work. If contract utility work is anticipated in conjunction with or during the highway construction, the Temporary Traffic Control plan must account for and adequately protect all work activities. The phasing of construction activities must be compatible with the utility work. Utilities, whose work affects traffic, are required to have a TTC plan by FHWA. This requires early and effective coordination with utilities.

10.3.1 Transportation Management Plan Components

10.3.1.1 Temporary Traffic Control (TTC) Plans

A TTC plan is a set of specific plan sheets, references to standard (typical) layouts, and/or notes on roadway plans describing how traffic will be controlled through a work zone. All projects and work on highways, roads and streets shall have a temporary traffic control plan, as required by Florida Statute and Federal regulations. All work shall be executed under the established plan and Department approved procedures. The TTC plan is the result of considerations and investigations made in the development of a comprehensive plan for accommodating traffic through the construction zone. These considerations include the design itself, contract specifications, and plan sheets.

TTC plan sheets detail the proper delineation of traffic through the work zone during all construction phases. The complexity of the TTC plan varies with the complexity of the traffic problems associated with a project. Many situations can be covered adequately with references to specific sections from the *Manual on Uniform Traffic Control Devices (MUTCD)*, or the *Design Standards, Series 600*. Specific TTC plan sheets shall be required in the plans set whenever project conditions are not specifically addressed in a typical layout from the manuals noted above. This is usually the case for complex projects; therefore references to the *Design Standards*, as well as specific TTC plan sheets, will likely be necessary.

A temporary traffic control plan should address the appropriate following information for the mainline and any affected crossroads, side streets, and ramps:

1. The location of all advance warning signs and lighting units.
2. Temporary pavement markings, (including RPM's).
3. Location of temporary barriers and attenuators.
4. Temporary drainage design.
5. Channelizing devices at special locations.
6. Locations for special devices such as changeable message signs (CMS), arrow panels, radar speed display units (RSDU), portable regulatory signs (PRS) and temporary signals.
7. CMS messages for each phase.

8. Signal timing for each phase, including temporary actuation, to maintain all existing actuated or traffic responsive mode signal operations for main and side street movements for the duration of the Contract (Check with Traffic Operations Engineer).
9. Location and geometry for transitions, detours, and diversions.
10. Typical sections for each phase of work on all projects, except simple resurfacing projects, in order to show lane widths, offsets, barrier locations and other features influencing traffic control.
11. The proposed regulatory speed(s) for each phase.
12. Reference to appropriate **Design Standards** or **MUTCD** drawings whenever applicable.
13. Appropriate quantities, pay items and pay item notes.
14. Resolve any conflicts between permanent signing and markings and work zone signing and markings.
15. Key strategies such as service patrol, police, public service announcements, night work, etc..
16. Good plan notes.
17. Address the need for maintaining existing roadway lighting.
18. Work area access plan.
19. Address the need for transit operations to safely stop along the roadway to board and discharge passengers, and to maintain transit stop signage.

Volume 2, Chapter 19, explains the required information for specific TTC plan sheets.

Consideration must also be given to adjoining, intersecting or sequential work zones. This can be a particular problem with maintenance operations, bridge or roadway projects under different contracts, and operations of other jurisdictions or utilities. When such work must take place, the operations must be coordinated and taken into account in the TTC plan so that the motorist encounters one, consistently designed, work zone.

TTC plan's for project designs "on the shelf" must be updated prior to contract letting.

10.3.1.1.1 TTC Plan Development

The following step-by-step process should be followed by designers when preparing temporary traffic control plans:

Step #1 Understand the Project

1. Field reviews by designers should be required.
2. Review the scope.
3. Examine the plans early in the plans development process.
4. Look at plan-profiles and cross sections for general understanding.
5. Review PD&E study for any constraints.
6. Consider transit and bicycle/pedestrian needs during construction.
7. For complex projects consider developing a TTC plan study and other possible strategies such as public awareness campaigns, alternate route improvements, service patrols, etc...

Step #2 Develop Project Specific Objectives

What are your objectives? Examples might be:

1. Use barrier wall to separate workers from traffic.
2. Close road if adequate detour exists.
3. Maintaining 2-way traffic at all times.
4. Maintaining existing roadway capacity during peaks.
5. Maintaining business/resident access.
6. Maintaining transit operations.
7. Provide bike/pedestrian access.
8. Minimize wetland impacts.
9. Expedite construction.

Step #3 Brainstorm TTC Plan Alternatives

Develop some rough alternatives considering what could be used to accomplish the work, such as constructing temporary pavement and/or temporary detours, using auxiliary lanes, placing 2-way traffic on one side of divided facility, using detour routes, etc. Also, south side as opposed to north side on an east-west roadway. Don't worry that an alternate doesn't meet all objectives.

Designers should check condition of any proposed detour routes. If the detour route is off the state system, additional documentation of the agreements with local agencies will be required (See **Section 10.12.9**). Design should prevent or minimize interruption of local transit operations.

Step #4 Develop a Construction Phasing Concept

1. Examine existing facility versus what is to be built. This is a major task on jobs other than resurfacing.
2. Coordinate with bridge designer.
3. Involve the Construction office as early as practical for input on alternate traffic control plans.
4. Color or mark the plan-profile sheets to show existing roadway versus new construction. Then, check station by station, the plan sheet against cross section sheets. Make notes on plan sheets as to drop-offs or other problems. Use profile grade lines or centerlines for reference points.
5. List out major tasks to be completed, such as:
 - a. Construct new WB Roadway
 - b. Construct new EB Roadway
 - c. Construct frontage roads
 - d. Construct bridge/flyover

Note: The designer may need input from construction personnel or even contractors' representatives in determining construction phases.

6. Make notes on plan sheets or notepad as to "decisions" that you make along the way.

Step #5 Examine/Analyze Alternatives Which Meet Objectives (for each phase)

Next, consider how you could achieve the proposed alternatives and meet the stated objectives.

1. Examine pros and cons of various alternatives.
2. Consider how much work and expense is involved for each alternative.
3. Consider detour/transition locations, signal operations during construction, how to handle buses, bicycles, pedestrians, service vehicles, etc...

Step #6 Develop Detailed TTC Plan

Select the most feasible alternative for each phase. Add details such as:

1. Detour/transition geometrics and locations.
2. If lane closures are needed, use the lane closure technique discussed in **Section 10.12.7** to determine time frame for closures.
3. Advanced signing scheme and locations, revisions needed to existing signs - including guide signs, and proposed signs for all work activities - lane closures, detours, etc., on mainline, side roads, crossroads and ramps.
4. Need for portable traffic signals, changeable message signs, and barriers.
5. How existing operations will be maintained - side streets, businesses, residents, bikes, pedestrians, buses - bus stops, etc...
6. Revisions to signal phasing and/or timing during each TTC plan phase.
7. Regulatory speed desired for each phase.
8. All pay items and quantities needed for TTC plan.
9. How existing auxiliary lanes will be used and any restriction necessary during construction.
10. Typical sections for each phase.
11. Outline key strategies to be used:
 - a. Service patrol
 - b. Police
 - c. Public service announcements
 - d. Night work
 - e. Motorist Awareness System (MAS)
12. Need for alternate route improvements.

10.3.1.1.2 TTC Plan Phase Submittals

TTC plan phase submittals should include the following:

1. **Phase I** - a typical section for each phase as well as a description of the phasing sequence and work involved.
2. **Phase II** - a majority of the TTC plan completed (75-90%), including the information outlined in **Section 10.3.1.1** of this chapter, and a list of the pay items needed.
3. **Phase III** - a final TTC plan, including all notes, pay items and preliminary quantities.

(Note: The construction office estimates the duration for each phase of construction during Phase III review. The designer will finalize the quantities in the plans, comp book, and TRNS*PORT after receiving the estimated durations for construction.)

10.3.1.2 Transportation Operations (TO)

Many work zone impact management strategies can be used to minimize traffic delays, improve mobility, maintain or improve motorist and worker safety, complete road work in a timely manner, and maintain access for businesses and residents. The table below presents various work zone management strategies by category. This set of strategies is not meant to be all-inclusive, but offers a large number to consider, as appropriate, in developing TMPs.

Transportation Operations (TO)			
Demand Management Strategies	Corridor/Network Management Strategies	Work Zone Safety Management Strategies	Traffic /Incident Management and Enforcement Strategies
Transit services improvements	Signal timing/ coordination improvements	Speed limits reduction or variable speed limits	ITS for traffic monitoring and management
Transit incentives	Temp. traffic signals	Temp. traffic signal	Transportation Management Center (TMC)
Shuttle services	Intersection improvements	Temp. barrier	Aerial surveillance
Ridesharing/ carpooling incentives	Bus turnouts	Crash Cushions	Call boxes
Park-and-Ride promotion	Turn restrictions	Automated flagger assistance devices (AFAD)	Mile post markers
HOV lanes	Truck restrictions	On-site safety training	Service patrol
Variable work hours	Dynamic lane close system	TMP inspection team meetings	Local detour routes
Telecommuting	Ramp closures		Contract support for incident management
	Railroad crossing controls		Incident/emergency response plan
			Law enforcement

10.3.1.3 Public Information (PI)

A work zone public information and outreach campaign involves communicating with road users, the general public, area residences and businesses, and appropriate public entities about a road construction project and its implications for safety and mobility. The PI component may be integrated in the project's Community Awareness Plan (CAP) if the district's CAP guidelines include public information communications strategies. Detailed information on Public Information can be found in the ***Project Development and Engineering Manual (PD&E) Chapter 11*** and the ***Public Involvement Handbook***. Both documents are available on the Environmental Management Offices web site at: <http://www.dot.state.fl.us/emo/>

Developing and implementing a public information and outreach campaign should be started well before road construction begins and will need ongoing monitoring throughout the life of the project. Planning and implementing a public information and outreach campaign involves a set of key steps that ideally will be coordinated and outlined in a public information and outreach plan:

1. **Determine the appropriate size and nature of the public information and outreach campaign.** The size and nature of a public information and outreach effort will be determined by the characteristics of a project, its location, and the anticipated impacts of a road construction project. Aspects to consider include size and duration of the project, the amount of delay anticipated, special traffic and safety conditions such as heavy truck traffic, and disruptions to other modes and key facilities such as airports, stadiums, and hospitals.
2. **Identify resources.** In most cases, public information and outreach spending will need to be part of a road construction project budget. In addition, campaign managers will also need to tap existing resources, an operating 511 system for example, and leverage external resources such as free media coverage.
3. **Identify partners.** Working with a range of partners to design and implement an information and outreach campaign will strengthen the strategies employed and may reduce the costs to the agency. Partners include, among others, State and local agencies, major employers, and business and neighborhood associations.
4. **Identify target audiences.** A key to any communication strategy is to identify the target audience(s). This will help to determine the types of messages that need to be conveyed and the best ways of communicating those messages.
5. **Develop the message(s).** In general, the messages communicated by the campaign should provide project information to maintain safety and minimize

delay, and should indicate that the agency cares about the driving public. More specific messages might include details of the work zone, travel times through the work zone, and alternate routes and modes of transportation.

6. **Determine communication strategies.** How information is communicated will depend on the audiences, the messages to be conveyed, and the campaign budget. The *Public Involvement Handbook* discusses a wide range of strategies for communicating information about a project.
7. **Determine communication timing.** Public information and outreach should not be limited to when a work zone is up and running. Before work commences is the best time to begin developing partnerships and informing the public about the project, its anticipated impacts, and how to find out more information. Post-construction it is a good idea to publicize completion and to thank project partners.

10.4 Coordination

Work zone traffic control can be a complex undertaking that requires the coordination of a number of agencies and other interested parties. Planning and coordination must begin early in a project design.

Traffic control is a joint responsibility of design (both roadway and bridge), construction and traffic operations personnel. Coordination is necessary by all three parties in the development of TMPs. Both traffic operations and construction personnel must routinely review TMPs during Phase I and Phase II plans to ensure that the plan is sound and constructible and bid items are complete and quantities reasonable. With subsequent reviews of Phase III plans, designers are also encouraged to contact contractors for ideas on Temporary Traffic Control Plans.

Temporary traffic control plans should also be reviewed with other appropriate entities such as maintenance, FHWA, community awareness teams, general public, transit agencies, businesses, freeway coordinator management teams, and local agencies. **Initial reviews should be made by construction and traffic operations no later than the Phase II plans stage with subsequent reviews of Phase III plans.** Input from local engineering and law enforcement agencies should be obtained early in the process, such as during the PD&E study and the Phase I plans stage.

Adjoining work zones may not have sufficient spacing for standard placement of signs and other traffic control devices within their traffic control zones. These situations can occur when separate contracts adjoin each other (separate bridge and roadway contracts are a typical example), utility work performed separately from roadway work or when maintenance activities are performed adjacent to a construction project. Where such restraints or conflicts occur, or are likely to occur, the designer should try to resolve the conflicts in order to prevent misunderstanding on the part of the traveling public.

10.5 Work Zone Traffic Control Training

10.5.1 Background

Work zone traffic control is an important function affecting the safety of the traveling public, contractor personnel and equipment, and department employees. Every reasonable effort should be made to eliminate or reduce involvement in crashes within work zones. Proper traffic control training is vital to achieving this objective.

The Department's Maintenance of Traffic Committee consists of representatives from Roadway Design, Construction, Maintenance, Traffic Operations and FHWA. Its purpose is to develop, review or revise procedures, standards and specifications regarding work zone traffic control to maximize efficiency and enhance safety of motorists, transit operations, bicyclists, pedestrians, and workers within the work zone.

10.5.2 Training Requirements

The Department's Maintenance of Traffic Committee has prescribed work zone traffic control training requirements outlined in ***Department Procedure, Topic No. 625-010-010***.

All Department employees, contractors, consultants, utility company personnel, local maintaining agency, or any other person responsible for work zone traffic control planning, design, implementation, inspection and/or for supervising the selection, placement, or maintenance of traffic control schemes and devices in work zones on the State Highway System, shall satisfactorily complete the training requirements of this procedure in the appropriate category of involvement. The Department may request to see a person's certificate or wallet size card documenting the successful completion of a Work Zone Traffic Control training course.

District Design, Construction, and Maintenance Engineers shall ensure that employees, including consultant personnel, who are responsible for temporary traffic control plan design, implementation, inspection or supervision of the design, selection, placement, or maintenance of traffic control schemes and devices in work zones have been certified under the provisions of this procedure.

10.6 Traffic Control Devices

Traffic control devices/methods that are available for use include:

1. Signs (warning, regulatory and guide)
2. Lighting units (arrow panels, barricade and sign lights, illumination devices, temporary signals and changeable message signs)
3. Channelizing devices (cones, tubular markers, plastic drums, vertical panels, and Types I, II and III barricades)
4. Markings (pavement markings, raised pavement markings, delineators, and removal of conflicting markings)
5. Safety appurtenances (portable concrete barriers, guardrail and crash cushions)
- See ***AASHTO Roadside Design Guide (Chapter 9)***
6. Flaggers
7. Law Enforcement
8. Motorist Awareness System (MAS)

The ***MUTCD*** contains detailed instructions on the use of traffic control devices. Special design considerations applicable to Florida are discussed in the following sections.

Traffic control devices should not be placed in locations where they will block transit stops, sidewalks or bicycle lanes.

10.7 Signs

Sign messages for speed limits and distances are to be posted in English units.

10.7.1 Advance Warning Signs

The TTC plan should identify the advance construction warning signs, including legends and location. These include signs such as "Road Work Ahead" and "Road Work One Mile". The TTC plan should provide the advanced warning signs, legends and locations for all proposed operations that require signing. These include diversions, detours, lane closures, and lane shifts, on the mainline as well as crossroads. The sequence for advance signing should be from general to more specific. As an example: Road Work Ahead (general), Left Lane Closed Ahead (more specific), and Merge Right (specific).

10.7.2 Length of Construction Sign

The length of construction sign (G20-1) bearing the legend "Road Work Next X Miles" is required for all projects of more than 2 miles in length. The sign shall be located at begin construction points.

10.7.3 Project Information Sign

The Project Information Sign shown in *Index 600* is required for all contracts with more than 90 days of contract time. This sign should be located approximately 500 feet in advance of the first advance warning sign or as close to be beginning of the project as practical, on each mainline approach. This sign may be omitted if physical constraints prohibit placement of this sign due to its size. Show the Project Information Sign in the TTC plans with the common name of the roadway (I-10; SR 5; US 1) and the phone number of the district office responsible to answer project specific questions.

10.7.4 Existing Signs

Existing (regulatory, warning, etc.) signs that conflict with the TTC plan shall be removed or relocated to complement the work zone conditions (i.e., if a stop sign on an existing side road is needed, use the existing sign and show the location that it is to be relocated to). Existing guide signs should be modified as necessary. It is good practice to revise existing guide signs by using black on orange panels to show changes made necessary by the construction operations.

If permanent guide signs are to be removed during construction, provisions should be made for temporary guide signing. The temporary sign should be black on orange with the legend designed in accordance with **MUTCD** requirements for permanent guide signing whenever possible.

10.8 Lighting Units

10.8.1 Warning Lights

Warning lights shall be in accordance with the *Design Standards, Index 600*.

1. Type A Flashing

To be mounted on Vertical Panel, Barricade, or Drums to mark an obstruction adjacent to or in the intended travel way. It is to be paid for as part of the device that it is mounted on.

2. Type B Flashing

To be mounted on the first and second advanced warning signs where two or more signs are used, as well as on advanced warning signs of intersecting roads. Type B Warning lights are to be paid for as High Intensity Flashing Lights (Temporary - Type B).

3. Type C Steady-Burn

Steady-Burn lights are to be placed on channelizing devices and barrier wall to delineate the traveled way on lane closures, lane changes, diversion curves and other similar conditions. On channelizing devices (Vertical Panels, Barricades, and Drums), their payment is included as part of the device. For use on Barrier wall, they are to be paid for separately as Lights, Temporary, Barrier Wall Mount (Type C, Steady-Burn). Their spacing on barrier wall is as follows:

- a. Transitions - 50 ft. on center
- b. Curves - 100 ft. on center
- c. Tangents - 200 ft. on center (Note: Curves flat enough to maintain a normal 2% cross slope are to have steady burn lights placed at the same spacing as tangents)

10.8.2 Advance Warning Arrow Panels

Arrow panels shall be used to supplement other devices for all lane closures on high-speed (55 mph or greater) and high-traffic density multilane roadways. The use of arrow panels should be considered for all other multilane closures. These devices are also useful for short-term operations, such as during work zone installation and removal.

Arrow panels should not be used in lane shift situations. Research has shown that motorists tend to change lanes (on multilane facilities) whenever an arrow panel is used to indicate a lane shift. Since this "response" is not desired, the arrow panel should not be used for lane shift situations on multilane roadways. Refer to current **MUTCD** for further information.

Arrow panel locations shall be shown on the TTC plan, along with any necessary notes concerning the use of this device.

10.8.3 Changeable Message Signs

Changeable message signs (CMS) may be used to supplement a traffic control zone. As a supplemental device, it cannot be used to replace any required sign or other device. These devices can be useful in providing information to the motorist about construction schedules, alternate routes, expected delays, and detours. Changeable message signs should be considered for use in complex, high-density work zones. Messages must be simple, with a minimum number of words and lines and should require no more than two displays of no more than three lines each with 8 characters per line. The TTC plan shall include the location and messages to be displayed.

The message displayed should be visible and legible to the motorist at a minimum distance of 900 ft. on approach to the signs. All messages should be cycled so that two message cycles are displayed to a driver while approaching the sign from 900 ft. at 55 mph.

The CMS units may be used:

1. To supplement conventional traffic control devices in construction work areas and should be placed approximately 500 to 800 ft. in advance of potential traffic problems, or
2. 0.5 to 2 miles in advance of complex traffic control schemes that require new and/or unusual traffic patterns for the motorists.

A CMS is required for night time work that takes place within 4 ft. of the traveled way.

Typical Conditions

Consistent with the factors described above, CMS messages should be considered under the following conditions:

1. Road closures
2. Ramp closures

3. Delays one hour or longer created by:
 - a. Congestion
 - b. Crashes
 - c. Lane closures
 - d. Two-way traffic on divided highway
 - e. Multiple lane closures
 - f. Unexpected shifts in alignment

Message Selection

Programmed messages should provide appropriate messages for the conditions likely to be encountered. A worksheet is provided and may be placed in the TTC plan. The following items must be carefully considered in the development of a message:

1. **Message elements - not necessarily in order**
 - a. Problem statement (where?)
 - b. Effect statement (what?)
 - c. Attention statement (who?)
 - d. Action statement (do?)
2. **Message format**
 - a. Will vary depending on content
 - b. "Where" or "what" will generally lead
 - c. "Who" and "do" follow in that order
 - d. "Who" often understood from "where"
3. **Display format**
 - a. Discrete, with entire message displayed at once is most desirable
 - b. Sequential is OK, 2 parts maximum
 - c. Run-on moving displays prohibited
 - d. One abbreviation per panel display desirable, two abbreviations are the maximum. Route designation is considered as one abbreviation and one word. Guidelines for abbreviations are provided on the following pages.

Exhibit 10-A Changeable Message Signs Worksheet

Location of board: _____

Used: from ____ - ____ - ____ at ____ : ____ am/pm
to ____ - ____ - ____ at ____ : ____ am/pm

Message programmed by: _____

MESSAGE 1

MESSAGE 2

Timing:

Message 1 will run ____ . ____ seconds.

Message 2 will run ____ . ____ seconds.

STANDARD ABBREVIATIONS FOR USE ON CHANGEABLE MESSAGE SIGNS

Standard abbreviations easily understood are:

<u>WORD</u>	<u>ABBREV.</u>	<u>WORD</u>	<u>ABBREV.</u>
Boulevard	BLVD	Normal	NORM
Center	CNTR	Parking	PKING
Emergency	EMER	Road	RD
Entrance, Enter	ENT	Service	SERV
Expressway	EXPWY	Shoulder	SHLDR
Freeway	FRWY, FWY	Slippery	SLIP
Highway	HWY	Speed	SPD
Information	INFO	Traffic	TRAF
Left	LFT	Travelers	TRVLRs
Maintenance	MAINT	Warning	WARN

Other abbreviations are easily understood whenever they appear in conjunction with a particular word commonly associated with it. These words and abbreviations are as follows:

<u>WORD</u>	<u>ABBREV.</u>	<u>PROMPT</u>
Access	ACCS	Road
Ahead	AHD	Fog*
Blocked	BLKD	Lane*
Bridge	BRDG	[Name]*
Chemical	CHEM	Spill
Construction	CONST	Ahead
Exit	EX, EXT	Next*
Express	EXP	Lane
Hazardous	HAZ	Driving
Interstate	I	[Number]
Major	MAJ	Accident
Mile	MI	[Number]*
Minor	MNR	Accident
Minute(s)	MIN	[Number]*
Oversized	OVRSZ	Load
Prepare	PREP	To Stop
Pavement	PVMT	Wet*
Quality	QLTY	Air*
Route	RT	Best*
Turnpike	TRNPK	[Name]*
Vehicle	VEH	Stalled*
Cardinal Directions	N, E, S, W	[Number]
Upper, Lower	UPR, LWR	Level

* = Prompt word given first

The following abbreviations are understood with a **prompt** word by about 75% of the drivers. These abbreviations may require some public education prior to usage.

<u>WORD</u>	<u>ABBREV.</u>	<u>PROMPT</u>
Condition	COND	Traffic*
Congested	CONG	Traffic
Downtown	DWNTN	Traffic
Frontage	FRNTG	Road
Local	LOC	Traffic
Northbound	N-BND	Traffic
Roadwork	RDWK	Ahead [Distance]
Temporary	TEMP	Route
Township	TWNNSHP	Limits

* = Prompt word given first

Certain abbreviations are prone to inviting confusion because another word is abbreviated or could be abbreviated in the same way. **DO NOT USE THESE ABBREVIATIONS:**

<u>ABBREV.</u>	<u>INTENDED WORD</u>	<u>WORD ERRONEOUSLY GIVEN</u>
WRNG	Warning	Wrong
ACC	Accident	Access (Road)
DLY	Delay	Daily
LT	Light (Traffic)	Left
STAD	Stadium	Standard
L	Left	Lane (Merge)
PARK	Parking	Park
RED	Reduce	Red
POLL	Pollution (Index)	Poll
FDR	Feeder	Federal
LOC	Local	Location
TEMP	Temporary	Temperature
CLRS	Clears	Color

10.8.4 Traffic Signals

Frequently portable or temporary traffic signals will be a preferred alternative to a flagger. Also, existing signal operations may need to be revised to accommodate the construction operations. The TTC plan should identify all existing actuated or traffic responsive mode signal operations for main and side street movements that are to be maintained for the duration of the Contract. In addition, the TTC plan should identify the specific alterations (physical location and timing) necessary for existing signals and the location and timing of portable signals. It shall include signal installation plans for each phase of construction. The signal installation plan shall include both the initial signal operation plan and the initial timing adjustments. Traffic control signal requirements or responsibilities shall be included in the Technical Special Provisions. Signal displays and location must meet **MUTCD** requirements. If temporary signals are used where a pedestrian crossing is present, either existing or temporary, the pedestrian must be accommodated in the signal timing.

Temporary Signal Plans or modification to existing signals should be reviewed by the appropriate section in the district for structural soundness and signal function.

10.9 Channelizing Devices

10.9.1 Type III Barricades

Two Type III barricades should be used to block off or close a roadway. Whenever two barricades are used together, only one warning light is required on each barricade.

10.9.2 Separation Devices

Placing two-lane two-way operations (traffic) (TLTWO) on one roadway of a normally divided highway should be a last resort (see **MUTCD**) and should be done with special care.

When traffic control must be maintained on one roadway of a normally divided highway, opposing traffic shall be separated either with portable barrier wall or Temporary Traffic Separators (see the **Design Standards, Index 600**). The use of striping, raised pavement markers, and complementary signing, either alone or in combination is not considered acceptable for separation purposes.

10.9.3 Channelizing Device Alternates

It is intended that cones, Type I and II barricades, vertical panels, drums and tubular markers be considered as alternative channelizing devices to be used at the contractor's option. The only exceptions to this are that tubular markers are not allowed at night and the use of cones shall comply with the notes shown on **Design Standards, Index 600**. The designer should not further restrict the options of channelizing devices.

10.10 Pavement Markings

10.10.1 Removing Pavement Markings

Existing pavement markings that conflict with temporary work zone traffic patterns must be obliterated where operations will exceed one work period. Painting over existing pavement markings is not permitted.

10.10.2 Raised Retro-Reflective Pavement Markers (RPM)

Raised Retro-Reflective Pavement Markers (RPM) are required as a supplement to all lane lines during construction. For further direction on the use of RPMs in the work zone the designer should refer to the *Design Standards, Index 600*.

10.10.3 Work Zone Markings

Markings for work zones include "Removable" and "Non-Removable" markings. **Section 102-10** of the *Standard Specifications* describes when each type is required. A separate pay item number is used for each. The designer should be aware of this information and provide appropriate pay items in the plans.

The designer should also consider using an asphalt layer and/or milling with an asphalt layer for covering/removing unneeded markings, especially in areas such as diversions or crossovers. Some construction phase durations may be long enough to require use of interim friction courses. When these type issues arise, the designer should work with the District Pavement Design Engineer, to determine what combination of pavement options best complements the Maintenance of Traffic with the final pavement design.

10.11 Safety Appurtenances for Work Zones

10.11.1 Traffic Barriers

Work zone traffic barriers are considered positive protection devices and are designed either as permanent barriers or as temporary barriers that can be easily relocated. They have four specific functions: to protect traffic from entering work areas, such as excavations or material storage sites; to provide positive protection for workers; to separate two-way traffic; and to protect construction such as false work for bridges and other exposed objects. The designer should anticipate when and where barriers will be needed and include this information and the quantities on the plans. At a minimum, positive protection devices shall be considered in work zone situations that place workers at increased risk from motorized traffic, and where positive protection devices offer the highest potential for increased safety for workers and road users, such as:

1. Work zones that provide workers no means of escape from motorized traffic (e.g., tunnels, bridges, etc.);
2. Long duration work zones (e.g., two weeks or more at the same location) resulting in substantial worker exposure to motorized traffic;
3. Projects with anticipated work zone speeds of 45 mph or greater, especially when combined with high traffic volumes;
4. Work operations that place workers close to travel lanes open to traffic; and
5. Roadside hazards, such as dropoffs or unfinished bridge decks, that will remain in place overnight or longer.

10.11.2 Barrier Walls (Temporary)

Portable concrete safety shape barriers, also known as portable concrete barriers (PCBs), are used in work zones to protect motorists as well as workers. Care must be taken in their design, installation and maintenance. Installation instructions and flare rates are given in the ***Design Standards, Index 415 & 600***.

When a PCB system other than ***Design Standards, Index 414***, Type K Temporary Concrete Barrier is used, the surface that the PCB is placed on shall have a cross slope of 1:10 or flatter carried a minimum of 2 ft. behind the barrier. See ***Design Standards, Index 414*** for specific requirements for the use of Type K Temporary Concrete Barrier. When the designer proposes temporary barrier walls, the cross-slope should be checked and temporary earthwork shown in the plans if necessary for the proper

placement of the barrier system. For requirements for PCB's that are used on bridges and retaining wall sections, see the **Structures Design Guidelines, Section 6.7**. When **Design Standards, Index 414**, Type K Temporary Concrete Barrier is used on bridges, see **Design Standards, Index 415** for details on transitioning between the Type K Temporary Concrete Barrier on the bridge and the Index 415 Barrier Wall on the adjoining roadway.

Water filled barriers should be used in accordance with the Vendor drawings on the **Qualified Products List (QPL)**.

The designer should show or note the location of all temporary barrier walls in the plans. The plans should also include a work area access plan for those projects with median work which is shielded with barrier wall.

10.11.3 End Treatments

The desirable treatments for exposed ends of barriers are:

1. Connecting to an existing barrier (smooth, structural connections are required - Refer to the ***Design Standards, Indexes 410 & 415***) or
2. Attaching a crashworthy terminal (such as a crash cushion) or
3. Flaring away to the edge of the clear zone (For Work Zone Clear zones, see the ***Design Standards, Index 600***)

10.11.4 Modifications of Existing Barriers

When 2-way traffic is placed on a facility that is normally one-way, the existing permanent or temporary barriers will be modified as necessary to ensure their proper crashworthiness during the temporary situation. This will include eliminating non-crashworthy end treatments, snag points or other protrusions normally angled away or hidden from approaching vehicles.

10.11.5 Crash Cushions

Crash cushions in work zones may be used in the same manner as at permanent highway installations. Crash cushions are used to protect the motorists from the exposed ends of barriers, fixed objects and other hazards within the clear zone. The designer must determine the need for crash cushions, select the appropriate type, and provide the necessary details and quantities in the plans. Selection of a system should be the result of an analysis of site conditions (i.e., space and need). Two types of stationary crash cushions are commonly used; redirective crash cushions and inertial crash cushions (i.e., sand filled module systems).

Redirective crash cushion systems will shield hazards by redirecting vehicles or absorbing end-on hits and are the principal type systems that should be used for shielding exposed ends of temporary concrete barrier wall on FDOT projects. ***Index 415*** provides details for shielding exposed ends of temporary concrete barrier wall using redirective systems. Temporary redirective crash cushions are paid for using the pay item IMPACT ATTENUATOR - CRASH CUSHION (TEMPORARY) (REDIRECTIVE OPTION). When this pay item is used, the contractor is allowed to use any temporary redirective crash cushion on the ***Qualified Products List***, unless the plans restrict the options to a specific redirective crash cushion system. Restricting the options is

normally not necessary and when done, must be justified with the reasons documented.

Inertial systems are gating devices with no redirection capability for side impacts and can only shield a hazard by absorbing end-on hits. Conditions and sites where these type systems are used are limited. **Index 417** provides standard arrays that may be used for shielding the ends of temporary concrete barrier wall where site conditions and duration restrictions can be met. Site conditions must provide for a clear runout area behind the array as shown in the index, as well as sufficient lateral space for the 5 degree taper in the alignment of the array with respect to the traffic lane. This taper helps to minimize the potential for side impacts into the heavier modules near the rear of the array as well as side impacts at the corner of the barrier wall end. When these site conditions can be met and the installation does not exceed 30 days in duration, **Index 417** may be used. Otherwise, a redirective system must be called for. As stated in **Index 417** the contractor does not have the option to use **Index 417** unless specifically called for in the plans.

End protection for hazards other than temporary barrier wall ends, must be custom engineered for each independent installation and detailed in the plans. The **Design Standards** and the **AASHTO Roadside Design Guide** can be consulted for more information.

10.12 Temporary Traffic Control Plan Details

The **Design Standards, Indexes 601** through **670**, are layouts of work zone traffic control for typical conditions. These indexes should be referenced only if project conditions are nearly the same as the typical layout. Otherwise, specific plan sheets or details must be prepared. Some conditions that will require specific plan sheets include:

1. Construction work zones near railroad crossings.
2. Work not covered by a typical layout.
3. Nighttime work requiring special lighting, oversized or additional devices.
4. Ramps and intersections that interrupt the standard layout.
5. Sight distance restrictions such as horizontal or vertical curves.
6. Lane or shoulder configurations that do not match the standards.
7. Special considerations during installation, intermediate traffic shifts and removal.
8. Complex projects, including add-lane projects, which involve many phases, traffic shifts, entrances and exits.
9. Special plan and notes detailing bus pullover bay/bus stop configuration.

When designing layouts, the following shall be considered:

10.12.1 Taper Lengths

Minimum taper lengths in the **Design Standards** are shown on individual Index sheets when applicable. When an Index sheet is not used, the minimum taper length shall be calculated by the formulas shown below **Table 10.12.1**.

Table 10.12.1 (taken from **MUTCD**) gives the criteria for the lengths of the various taper types.

Table 10.12.1 Taper Length Criteria for Work Zones

Type of Taper	Taper Length
UPSTREAM TAPERS	
Merging Taper	L Minimum
Shifting Taper	1/2 L Minimum
Shoulder Taper	1/3 L Minimum
Two-way Traffic Taper	100 ft. Maximum
DOWNSTREAM TAPERS	
	100 ft. per lane (use is optional)

Formulas for L are as follows:

For speed limits of 40 mph or less:

$$L = WS^2/60$$

For speed limits of 45 mph or greater:

$$L = WS$$

"L" is the length of the taper in feet

"W" is the width of lateral transition in feet

"S" is the posted regulatory speed for the work zone.

10.12.2 Intersecting Road Signing and Signals

Signing for the control of traffic entering and leaving work zones by way of intersecting highways, roads and streets shall be adequate to make drivers aware of work zone conditions. Under no condition will intersecting leg signing be less than a "Road Work Ahead" sign. The designer should remember to include these signs in the estimated quantity for Construction warning signs.

Existing traffic signal operations that require modification in order to carry out work zone traffic control shall be as approved by the District Traffic Operations Engineer (DTOE). If lane shifts occur, signal heads may have to be adjusted to maintain proper position. The DTOE should also determine the need for temporary traffic detection for traffic actuated signals. The TTC plan should include all necessary signal adjustments.

10.12.3 Sight Distance to Delineation Devices

Merging (lane closure) tapers should be obvious to drivers. If restricted sight distance is a problem (e.g., a sharp vertical or horizontal curve approaching the closed lane), the taper should begin well in advance of the view obstruction. The beginning of tapers should not be hidden behind curves.

10.12.4 Pedestrians and Bicyclists

Transportation plans and projects must consider safety and contiguous routes for pedestrians and bicyclists. In developing Temporary Traffic Control (TTC) Plans, when an existing pedestrian way or bicycle way is located within a traffic control work zone, accommodation must be maintained and provision for the disabled must be provided.

When existing pedestrian facilities are disrupted, closed or relocated in a TTC zone, the temporary facility or route shall be detectable and include accessibility features consistent with the features present in the existing facility. See **Chapter 6D** of the **MUTCD** for additional guidance.

10.12.4.1 Pedestrian Considerations

There are three threshold considerations in planning for pedestrian safety in work zones on highways and streets:

1. Pedestrians should not be led into direct conflicts with work site vehicles, equipment or operations.
2. Pedestrians should not be led into direct conflicts with mainline traffic moving through or around the work site.
3. Pedestrians should be provided with a safe, convenient travel path that replicates as nearly as possible the most desirable characteristics of sidewalks or footpaths.

Pedestrian accommodations through work zones must include provisions for the disabled. Temporary traffic control devices for vehicular traffic should not be allowed within the pedestrians' travel path.

At transit stops, provisions should be made to ensure passengers have the ability to board and depart from transit vehicles safely.

Signing should be used to direct pedestrians to safe street crossings in advance of an encounter with a work zone. Signs should be placed at intersections so pedestrians, particularly in high-traffic-volume urban and urbanized areas, are not confronted with midblock crossings.

10.12.4.2 Bicycle Considerations

There are several considerations in planning for bicyclists in work zones on highways and streets:

1. Bicyclists should not be led into direct conflicts with mainline traffic, work site vehicles, or equipment moving through or around traffic control zones.
2. Bicyclists should be provided with a travel route that replicates the most desirable characteristics of a wide paved shoulder or bicycle lane through or around the work zone.
3. If the work zone interrupts the continuity of an existing shared use path or bike route system, signs directing bicyclists through or around the work zone and back to the path or route should be provided.
4. The bicyclist should not be directed onto the same path used by pedestrians.

10.12.5 Superelevation

Horizontal curves constructed in conjunction with temporary work zone diversions, transitions, and crossovers should have the required superelevation. Under conditions where superelevation is not used, the minimum radii that can be applied are listed in the **Table 10.12.2**. Superelevation must be included with the design whenever the minimum radii cannot be achieved.

Table 10.12.2 Minimum Radii for Normal 0.02 Cross Slopes

SPEED (mph)	MINIMUM RADIUS (feet)
65	3130
60	2400
55	1840
50	1390
45	1080
40	820
35	610
30	430

10.12.6 Lane Widths

Existing lane widths of through roadways should be maintained through work zone travel ways wherever practical. The minimum widths for work zone travel lanes shall be 10 ft. for all roadways other than Interstate. On Interstate highways the minimum width for work zone travel lanes shall be 11 ft. except at least one 12 ft. lane in each direction shall be provided.

10.12.7 Lane Closure Analysis

The lane closure analysis is a process used by designers to calculate the peak hour traffic volume and the restricted capacity for open road and signalized intersections. The analysis will determine if a lane closure should or should not be allowed and the time of day or night a lane closure could occur without excessive travel delay.

For all projects under reconstruction, the existing number of lanes shall remain open to traffic when construction is not active.

For widening or major reconstruction on Limited Access facilities, the Temporary Traffic Control Plan will keep the existing number of traffic lanes open at all times throughout the duration of the construction project.

Closing a traffic lane on Interstate or Limited Access facilities can have a significant operational impact in terms of reduced capacity and delay. There will be no daytime lane closures allowed on Florida's Turnpike unless it is approved in writing by the Deputy Executive Director and Chief Operating Officer. Other districts have adopted similar policy for Interstate daytime lane closures; therefore, it is recommended the Designer verify the District's lane closure policy at the beginning of the design process.

No lane closures in excess of one work day shall be permitted on Limited Access construction where only two traveled lanes in one direction exist. If it becomes necessary to have a long-term lane closure on a four lane Interstate, sufficient documentation shall be provided to the District Secretary for her/his approval.

Chapter 22 of the *Highway Capacity Manual 2000*, titled "**Freeway Facilities Methodology**" contains a capacity reduction procedure appropriate for lane closures on Limited Access facilities and other freeways. The Designer may use the **HCS2000** method in lieu of the procedure described in this chapter of the **PPM**. The **HCS2000**

method considers the intensity of the work activity, the effects of heavy vehicles and presence of ramps. For certain freeway segments it will result in a lower capacity than the lane closure analysis described in the *PPM*.

Exhibit 10-B includes the lane closure analysis worksheets and two sample analyses. The sample **Lane Closure Worksheet (Exhibit 10-B, Sheet 3 of 11)** has been cross-referenced to the **Lane Closure Symbols and Definitions** sheets (**Exhibit 10-B, Sheets 1 & 2 of 11**) with circled numbers. The circled numbers correspond to the numbers of the symbols and definitions. The symbols and definitions sheets show the designer where to find the necessary information to fill out the lane closure worksheet.

Fill out the top part of the lane closure worksheet and complete the formulas to calculate the hourly percentage of traffic at which a lane closure will be permitted (see **Exhibit 10-B, Sheets 6 & 8 of 11**). Transfer these percentages to the graph on the **Lane Closures 24 Hour Counts** sheet (**Exhibit 10-B, Sheet 5 of 11**). Draw a line across the graph representing the percentage for both open road and signalized intersections (see **Exhibit 10-B, Sheets 7 & 9 of 11**). Plot the hourly percentages (hourly volume divided by total volume) on the graph. Any hourly percentage extending above the restricted capacity percentage lines for open road or signalized intersections indicated lane closure problems. The bottom of the graph gives times for AM and PM. By coordinating the lane closure problem areas to the time of day, a designer knows when to restrict lane closure.

Many of Florida's roadways have directional peak hour traffic volumes, with inbound morning traffic, and outbound afternoon traffic. Doing a composite lane closure analysis would in many cases require night work. However, if a separate lane closure analysis is calculated for inbound and outbound separately, a lane closure may be allowed and the contractor could work in daylight hours, (See **Exhibit 10-B, Sheets 10 & 11 of 11**).

Exhibit 10-B Lane Closures Sheet 1 of 11

Symbols and Definitions

1. **ATC** = Actual Traffic Counts. Use current traffic counts. Traffic counts can be obtained from the Office of Planning, or you may need to get traffic counts done. The designer needs hourly traffic volumes with a total traffic volume for a 24-hour period (see *Exhibit 10-B, Sheet 7 of 11*).
2. **P/D** = Peak Traffic to Daily Traffic Ratio. Highest hourly volume divided by the total 24-hour volume. Convert the percentage to a decimal on the Lane Closure Worksheet (see *Exhibit 10-B, Sheet 7 of 11*).
3. **D** = Directional Distribution of peak hour traffic on multilane roads. This factor does not apply to a two-lane roadway converted to two-way, one-lane. The directional distribution can be obtained from the Office of Planning.
4. **PSCF** = Peak Season Conversion Factor. Many counties in Florida have a significant variance in seasonal traffic. The designer should use the PSCF for the week in which the actual traffic count was conducted. The Office of Planning has tables showing Peak Season Conversion Factors for every county in Florida. (See sample table of values on *Exhibit 10-B, Sheet 4 of 11*).
5. **RTF** = Remaining Traffic Factor is the percentage of traffic that will not be diverted onto other facilities during a lane closure. Convert the percentage to a decimal on the Lane Closure Worksheet. This is an estimate that the designer must make on his own, or with help from the Office of Planning. Range: 0% for all traffic diverted to 100% for none diverted.
6. **G/C** = Ratio of Green to Cycle Time. This factor is to be applied when lane closure is through or within 600 ft. of a signalized intersection. The Office of Traffic Engineering has timing cycles for all traffic signals.
7. **V** = Peak Hour Traffic Volume. The designer calculates the peak hour traffic volume by multiplying the actual traffic count, times peak to daily traffic ratio, times directional factor, times peak seasonal factor, times remaining traffic factor. This calculation will give the designer the expected traffic volume of a roadway at the anticipated time of a lane closure.

Exhibit 10-B Lane Closures, Sheet 2 of 11

Symbols and Definitions (Continued)

8. **C** = Capacity of a 2L, 4L 6L, or 8L roadway with one lane closed, and the remaining lane(s) unrestricted by lateral obstructions. The capacity of a 4L, 6L, or 8L roadway is based on lane closure in only one direction (see Lane Closure Capacity Table on **Exhibit 10-B, Sheet 3 of 11**).
9. **RC** = Restricting Capacity of the above facilities by site specific limitations detailed in the Temporary Traffic Control plans which apply to travel lane width, lateral clearance and the work zone factor. The work zone factor only applies to two lane roadways (see the tables on **Exhibit 10-B, Sheet 4 of 11** to obtain the Obstruction Factor and Work Zone Factor).
10. **OF** = Obstruction Factor which reduces the capacity of the remaining travel lane(s) by restricting one or both of the following components: Travel lane width less than 12 ft. and lateral clearance less than 6 ft. (see TTC plan and Obstruction Factor Table in **Exhibit 10-B, Sheet 4 of 11**).
11. **WZF** = Work Zone Factor (WZF) is directly proportional to the work zone length (WZL). The capacity is reduced by restricting traffic movement to a single lane while opposing traffic queues. The WZF and WZL only apply to a two lane roadway converted to two way, one lane (see the Work Zone Factor Table on **Exhibit 10-B, Sheet 4 of 11**).
12. **TLW** = Travel Lane Width is used to determine the obstruction factor (see TTC plan and the Obstruction Factor Table on **Exhibit 10-B, Sheet 4 of 11**).
13. **LC** = Lateral Clearance is the distance from the edge of the travel lane to the obstruction. The lateral clearance is used to determine the obstruction factor (see TTC plans and Obstruction Factor Table on **Exhibit 10-B, Sheet 4 of 11**).

Exhibit 10-B, Lane Closures, Sheet 3 of 11

LANE CLOSURE WORKSHEET

FINANCIAL PROJECT ID: _____ FAP NO.: _____
 COUNTY: _____ DESIGNER: _____
 NO. EXISTING LANES: _____ SCOPE OF WORK: _____

Calculate the peak hour traffic volume (V)

$$V = ATC \text{ (1) } \times P/D \text{ (2) } \times D \text{ (3) } \times PSCF \text{ (4) } \times RTF \text{ (5) } = \text{ (7) }$$

LANE CLOSURE CAPACITY TABLE

Capacity (C) of an Existing 2-Lane – Converted to 2-Way, 1-Lane = 1400 VPH
 Capacity (C) of an Existing 4-Lane – Converted to 1-Way, 1-Lane = 1800 VPH
 Capacity (C) of an Existing 6-Lane – Converted to 1-Way, 2-Lane = 3600 VPH
 Capacity (C) of an Existing 8-Lane – Converted to 1-Way, 3-Lane = 5400 VPH

Factors restricting Capacity:

$$TLW \text{ (12) } LC \text{ (13) } WZL \text{ (11) } G/C \text{ (6) }$$

Calculate the Restricted Capacity (RC) at the Lane Closure Site by multiplying the appropriate 2L, 4L, 6L, or 8L Capacity (C) from the Table above by the Obstruction Factor (OF) and the Work Zone Factor (WZF). If the Lane Closure is through or within 600 ft. of a signalized intersection, multiply the RC by the G/C Ratio.

$$RC \text{ (Open Road)} = C \text{ (8) } \times OF \text{ (10) } \times WZF \text{ (11) } = \text{ (9) }$$

$$RC \text{ (Signalized)} = RC \text{ (Open Road)} \text{ (9) } \times G/C \text{ (6) } = \text{ (9) }$$

If $V \leq RC$, there is no restriction on Lane Closure

If $V > RC$, calculate the hourly percentage of ADT at which Lane Closure will be permitted

$$\text{Open Road \%} = \frac{RC \text{ (Open Road)} \text{ (9)}}{\text{ATC (1) } \times D \text{ (3) } \times PSCF \text{ (4) } \times RTF \text{ (5) }} = \text{ \%}$$

$$\text{Signalized \%} = \text{Open Road \%} \times G/C \text{ (6) } = \text{ \%}$$

Plot 24 hour traffic to determine when Lane Closure permitted. (See **Exhibit 10-B, Sheet 5 of 11**)

NOTE: For Existing 2-Lane Roadways, D = 1.00.
 Work Zone Factor (WZF) applies only to 2-Lane Roadways.

For $RTF < 1.00$, briefly describe alternate route _____

Exhibit 10-B, Lane Closures, Sheet 4 of 11

**Lane Closures – Capacity Adjustment Factors
 Peak Season Conversion Factor (PSCF) Sample**

1998 Peak Season Factor Category Report for Tropic County							
WK	Dates	SF	PSCF	WK	Dates	SF	PSCF
9	02/22 – 02/28/98	1.14	1.48	15	04/05 – 04/11/98	0.86	1.12
10	03/01 – 03/07/98	1.04	1.35	16	04/12 – 04/18/98	0.87	1.13
11	03/08 – 03/14/98	0.94	1.22	17	04/19 – 04/25/98	0.90	1.17
12	03/15 – 03/21/98	0.83	1.08	18	04/26 – 05/02/98	0.93	1.21
13	03/22 – 03/28/98	0.84	1.09	19	05/03 – 05/09/98	0.96	1.25
14	03/29 – 04/04/98	0.85	1.11	20	05/10 – 05/16/98	0.99	1.29

Obstruction Factors (OF)

Lateral Clearance (LC) (feet)	Travel Lane Width (TLW) (feet)			
	12	11	10	9
6	1.00	0.96	0.90	0.80
4	0.98	0.94	0.87	0.77
2	0.94	0.90	0.83	0.72
0.0	0.86	0.82	0.75	0.65

Work Zone Factors (WZF)

WZL (ft.)	WZF	WZL (ft.)	WZF	WZL (ft.)	WZF
200	0.99	2200	0.87	4200	0.78
400	0.97	2400	0.86	4400	0.77
600	0.96	2600	0.85	4600	0.77
800	0.95	2800	0.84	4800	0.76
1000	0.93	3000	0.83	5000	0.75
1200	0.92	3200	0.82	5200	0.75
1400	0.91	3400	0.81	5400	0.74
1600	0.90	3600	0.80	5600	0.73
1800	0.89	3800	0.80	5800	0.73
2000	0.88	4000	0.79	6000	0.72

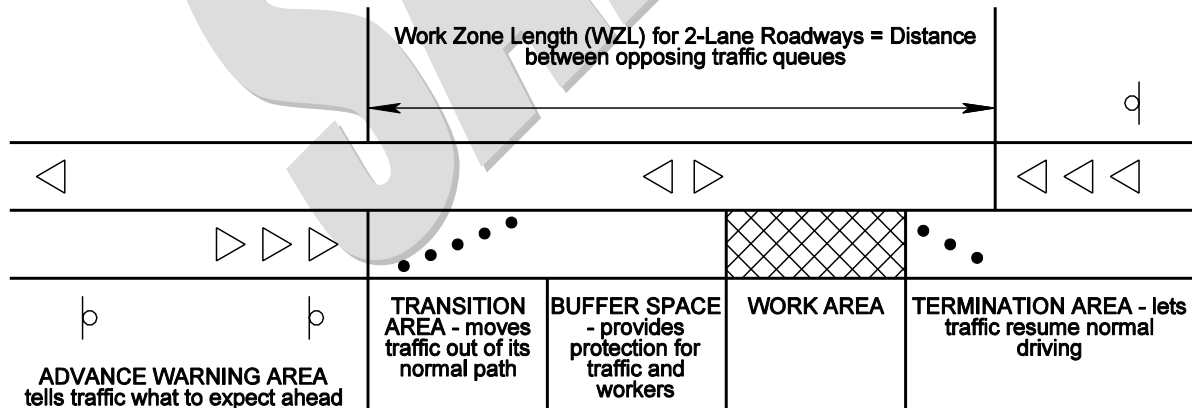

Exhibit 10-B, Lane Closures, Sheet 5 of 11

LANE CLOSURES
 24 HOUR COUNTS

TIME	AM HOURLY VOLUME	ATC %	PM HOURLY VOLUME	ATC %	DATE
12 - 1	_____	_____	_____	_____	_____
1 - 2	_____	_____	_____	_____	_____
2 - 3	_____	_____	_____	_____	DESIGNER
3 - 4	_____	_____	_____	_____	_____
4 - 5	_____	_____	_____	_____	_____
5 - 6	_____	_____	_____	_____	_____
6 - 7	_____	_____	_____	_____	FINANCIAL PROJECT ID
7 - 8	_____	_____	_____	_____	_____
8 - 9	_____	_____	_____	_____	_____
9 - 10	_____	_____	_____	_____	_____
10 - 11	_____	_____	_____	_____	_____
11 - 12	_____	_____	_____	_____	_____
		TOTAL	_____	_____	LOCATION

HOURLY VARIATION OF DAILY TRAFFIC

-CONCLUSION-
 ROUND TO THE
 NEAREST 1/2 HOUR
 CONSERVATIVELY

OPEN ROAD LANE
 CLOSURE

SIGNALIZED LANE
 CLOSURE

Exhibit 10-B, Lane Closures, Sheet 6 of 11

LANE CLOSURE WORKSHEET

FINANCIAL PROJECT ID: 123456-7-89-10 FAP NO.: NA

COUNTY: Tropic

DESIGNER: Yates

NO. EXISTING LANES: 2

SCOPE OF WORK: Widen

and Resurface

Calculate the peak hour traffic volume (V)

$$V = ATC \underline{15000} \times P/D \underline{0.083} \times D \underline{NA} \times PSCF \underline{1.17} \times RTF \underline{0.75} = \underline{1092}$$

LANE CLOSURE CAPACITY TABLE

Capacity (C) of an Existing 2-Lane – Converted to 2-Way, 1-Lane = 1400 VPH
 Capacity (C) of an Existing 4-Lane – Converted to 1-Way, 1-Lane = 1800 VPH
 Capacity (C) of an Existing 6-Lane – Converted to 1-Way, 2-Lane = 3600 VPH
 Capacity (C) of an Existing 8-Lane – Converted to 1-Way, 3-Lane = 5400 VPH

Factors restricting Capacity:

TLW 10 LC 4 WZL 3200 G/C 0.64

Calculate the Restricted Capacity (RC) at the Lane Closure Site by multiplying the appropriate 2L, 4L, 6L, or 8L Capacity (C) from the table above by the Obstruction Factor (OF) and the Work Zone Factor (WZF). If the Lane Closure is through or within 600 ft. of a signalized intersection, multiply the RC by the G/C Ratio.

$$RC \text{ (Open Road)} = C \underline{1400} \times OF \underline{0.87} \times WZF \underline{0.82} = \underline{999}$$

$$RC \text{ (Signalized)} = RC \text{ (Open Road)} \underline{999} \times G/C \underline{0.64} = \underline{639}$$

If $V \leq RC$, there is no restriction on Lane Closure

If $V > RC$, calculate the hourly percentage of ADT at which Lane Closure will be permitted

RC (Open Road) 999

$$\text{Open Road \%} = \frac{\text{RC (Open Road)}}{\text{(ATC } \underline{15000} \times D \underline{1.00} \times PSCF \underline{1.17} \times RTF \underline{0.75} \text{)}} = \underline{7.59\%}$$

$$\text{Signalized \%} = \text{Open Road \%} \underline{7.59} \times G/C \underline{0.64} = \underline{4.86\%}$$

Plot 24 hour traffic to determine when Lane Closure permitted. (See *Exhibit 10-B, Sheet 7 of 11*)

NOTE: For Existing 2-Lane Roadways, D = 1.00.

Work Zone Factor (WZF) applies only to 2-Lane Roadways.

For $RTF < 1.00$, briefly describe alternate route: 25% of existing traffic diverted on Bullard Blvd., north on Newhall Lane, then east on Xanders Expressway.

Exhibit 10-B, Lane Closures, Sheet 7 of 11

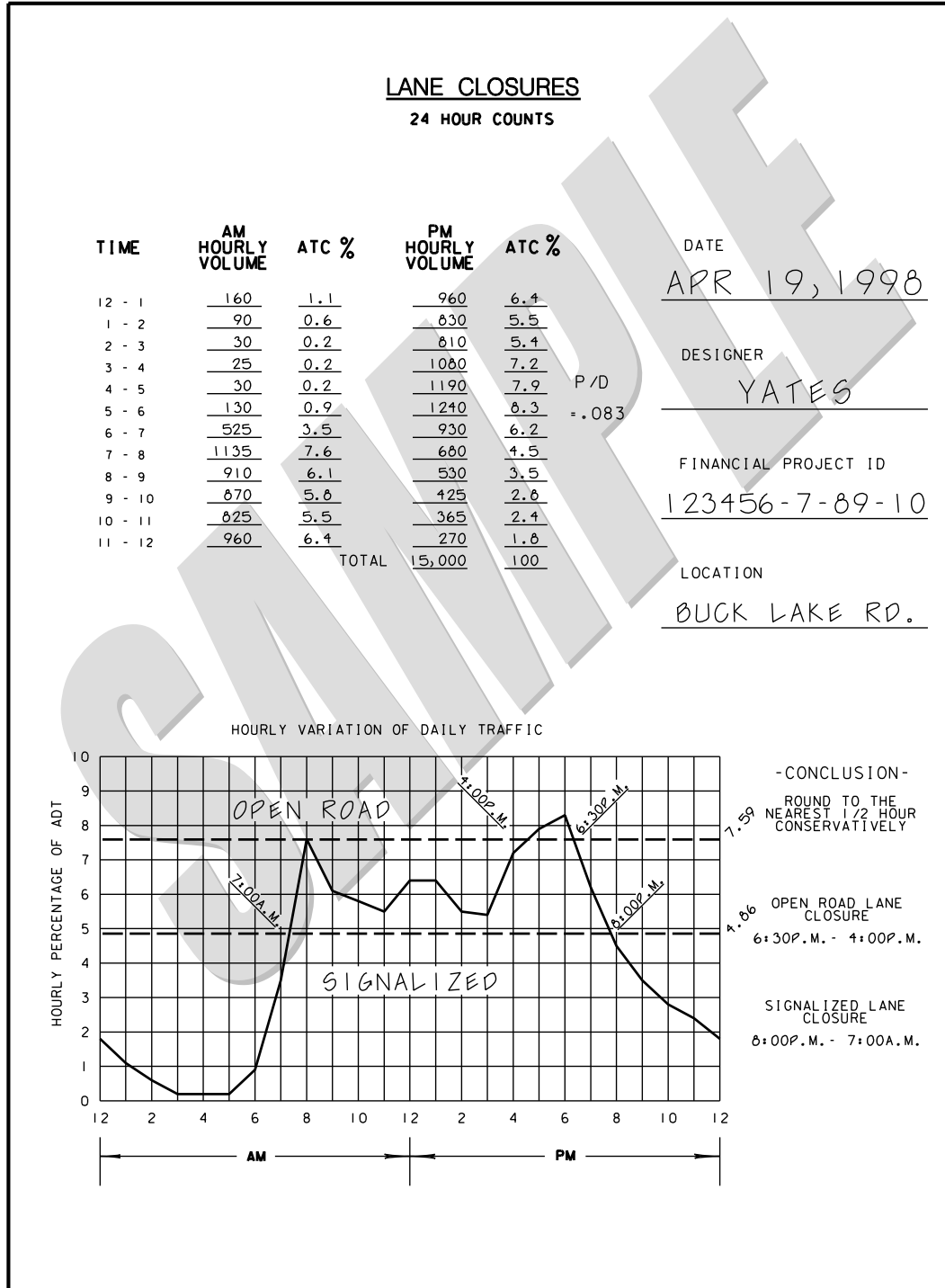

Exhibit 10-B, Lane Closures, Sheet 8 of 11

LANE CLOSURE WORKSHEET

FINANCIAL PROJECT ID: 123456-7-89-10 FAP NO.: NA

COUNTY: Tropic

DESIGNER: Giddens

NO. EXISTING LANES: 4

SCOPE OF WORK: Resurface

Calculate the peak hour traffic volume (V)

$$V = \text{ATC } \underline{30000} \times \text{P/D } \underline{0.083} \times \text{D } \underline{0.55} \times \text{PSCF } \underline{1.17} \times \text{RTF } \underline{1.00} = \underline{1602}$$

LANE CLOSURE CAPACITY TABLE

Capacity (C) of an Existing 2-Lane – Converted to 2-Way, 1-Lane = 1400 VPH
Capacity (C) of an Existing 4-Lane – Converted to 1-Way, 1-Lane = 1800 VPH
Capacity (C) of an Existing 6-Lane – Converted to 1-Way, 2-Lane = 3600 VPH
Capacity (C) of an Existing 8-Lane – Converted to 1-Way, 3-Lane = 5400 VPH

Factors restricting Capacity:

TLW 11 LC 6 WZL NA for 4L G/C 0.74

Calculate the Restricted Capacity (RC) at the Lane Closure Site by multiplying the appropriate 2L, 4L, 6L, or 8L Capacity (C) from the table above by the Obstruction Factor (OF) and the Work Zone Factor (WZF). If the Lane Closure is through or within 600 ft. of a signalized intersection, multiply the RC by the G/C Ratio.

$$\text{RC (Open Road)} = C \underline{1800} \times \text{OF } \underline{0.96} \times \text{WZF } \underline{1.00} = \underline{1728}$$

$$\text{RC (Signalized)} = \text{RC (Open Road)} \underline{1728} \times \text{G/C } \underline{0.74} = \underline{1279}$$

If $V \leq \text{RC}$, there is no restriction on Lane Closure

If $V > \text{RC}$, calculate the hourly percentage of ADT at which Lane Closure will be permitted

RC (Open Road) 1728

$$\text{Open Road \%} = \frac{\text{RC (Open Road)}}{\text{ATC } \underline{30000} \times \text{D } \underline{0.55} \times \text{PSCF } \underline{1.17} \times \text{RTF } \underline{1.00}} = \underline{8.95\%}$$

$$\text{Signalized \%} = \text{Open Road \% } \underline{8.95} \times \text{G/C } \underline{0.74} = \underline{6.62\%}$$

Plot 24 hour traffic to determine when Lane Closure permitted. (See **Exhibit 10-B, Sheet 9 of 11**)

NOTE: For Existing 2-Lane Roadways, D = 1.00.

Work Zone Factor (WZF) applies only to 2-Lane Roadways.

For $\text{RTF} < 1.00$, briefly describe alternate route: NA

Exhibit 10-B, Lane Closures, Sheet 9 of 11

LANE CLOSURES
 24 HOUR COUNTS

TIME	AM HOURLY VOLUME	ATC %	PM HOURLY VOLUME	ATC %
12 - 1	320	1.1	1920	6.4
1 - 2	160	0.6	1660	5.5
2 - 3	60	0.2	1620	5.4
3 - 4	50	0.2	2160	7.2
4 - 5	60	0.2	2360	7.9
5 - 6	260	0.9	2480	8.3
6 - 7	1050	3.5	1860	6.2
7 - 8	2270	7.6	1360	4.5
8 - 9	1820	6.1	1060	3.5
9 - 10	1740	5.8	850	2.8
10 - 11	1650	5.5	730	2.4
11 - 12	1920	6.4	540	1.8
		TOTAL	30,000	100

DATE
APR 19, 1998

DESIGNER
GIDDENS

FINANCIAL PROJECT ID
123456-7-89-10

LOCATION
BUCK LAKE RD.

HOURLY VARIATION OF DAILY TRAFFIC

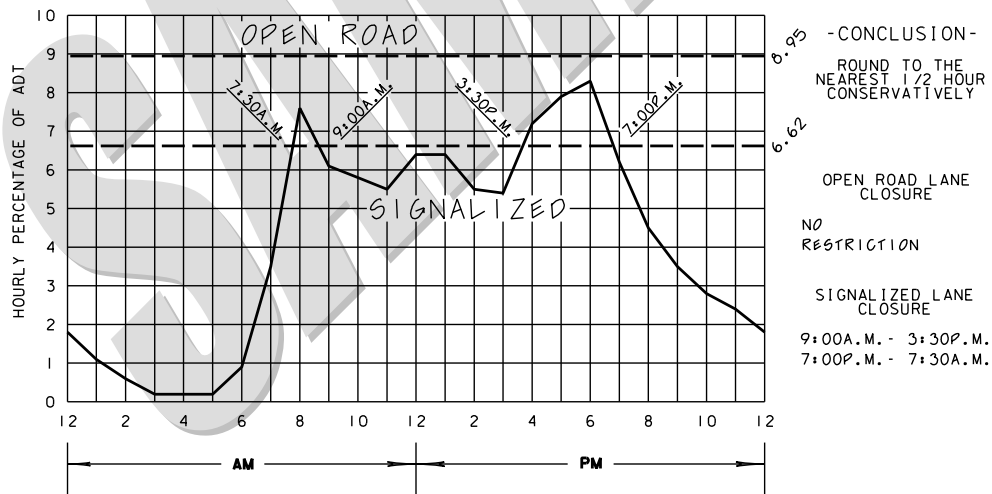

Exhibit 10-B, Lane Closures, Sheet 10 of 11

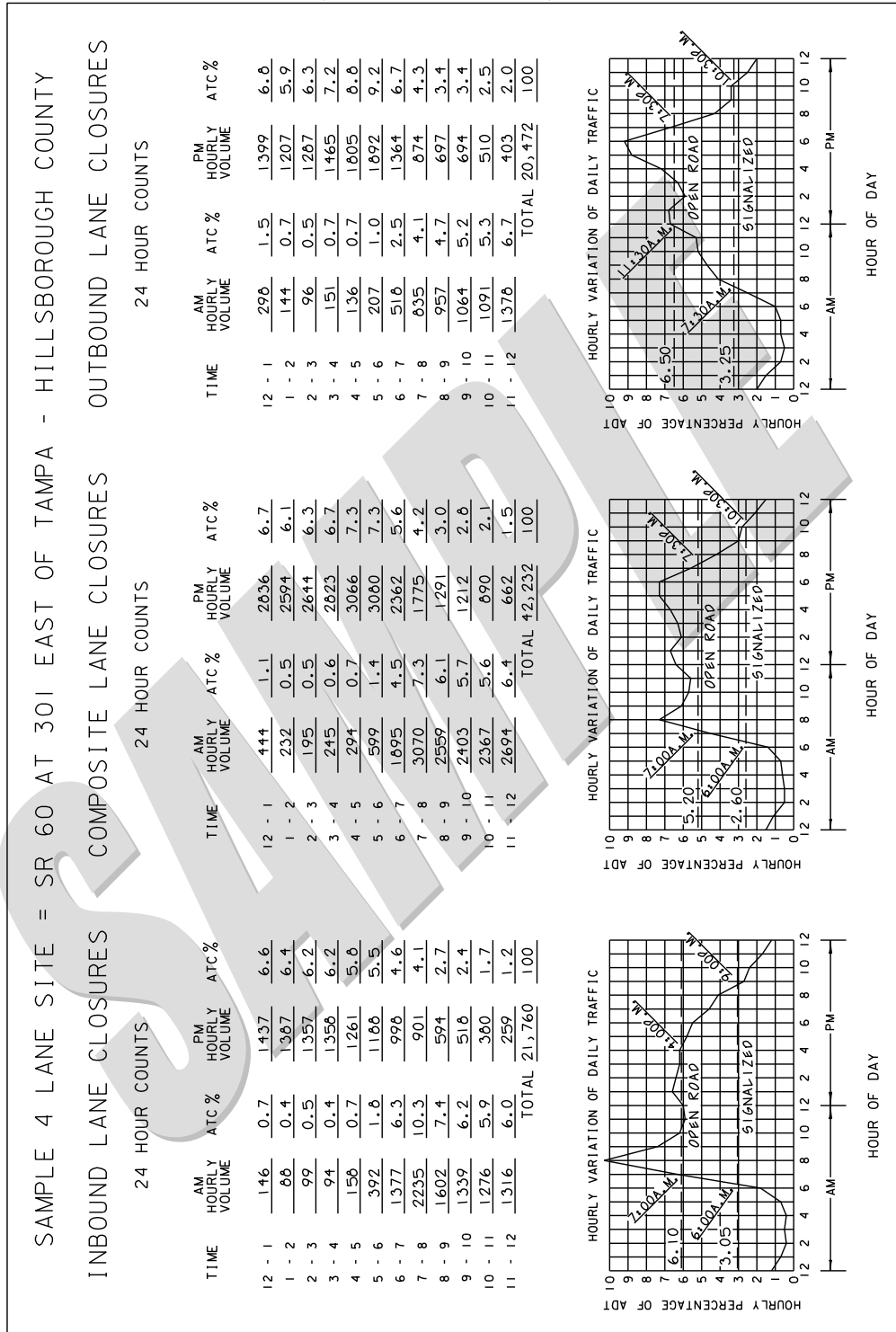

Exhibit 10-B, Lane Closures, Sheet 11 of 11

LANE CLOSURE WORKSHEET SUMMARY LANE SAMPLE WITH SIGNIFICANT AM-PM PEAKS SAMPLES = INBOUND (WB), COMPOSITE (EB & WB), OUTBOUND (EB) SITE = SR 60 @ US 301 EAST OF TAMPA, HILLSBOROUGH CO.			
COMPONENT	INBOUND	COMPOSITE	OUTBOUND
ADT	21,760	42,232	20,472
P/D	0.103	0.073	0.092
D	1.00	0.60	1.00
PSCF	1.17	1.17	1.17
RTF	1.00	1.00	1.00
V	2622	2164	2203
TLW	12	12	12
LC	0	0	0
C	1800	1800	1800
OF	0.86	0.86	0.86
RC (OPEN ROAD)	1548	1548	1548
G/C	0.50	0.50	0.50
RC (SIGNAL)	774	774	774
% OPEN ROAD	6.10	5.20	6.50
% SIGNAL	3.05	2.60	3.25
LANE CLOSURE (OPEN ROAD)	7:00 AM 4:00 PM	7:00 AM 7:30 PM	11:30 AM 7:30 PM
LANE CLOSURE (SIGNAL)	6:00 AM. 9:00 PM.	6:00 AM 10:30 PM	7:30 AM 10:30 PM

THIS PAGE LEFT BLANK INTENTIONALLY

10.12.8 Traffic Pacing Design

A traffic pacing design is prepared to provide adequate work time for overhead construction on limited access highways. Traffic pacing is a traffic control technique that facilitates short duration overhead work operations by pacing traffic at a slow speed for a predetermined distance upstream of the work area. The Department frequently uses this technique for installing overhead sign structures, replacing sign panels, installing cantilever trusses and, when site conditions allow, placing bridge beams. Traffic pacing may also be used by utility companies for the installation of utility crossings. Based on the required work time and other inputs such as traffic volumes, regulatory speed and pacing speed, the designer will prepare a traffic control plan that defines the allowable pacing hours, pacing distance, location of warning signs, interchange ramp closures and other critical information.

The Traffic Control Plan will document the layout and required resources for the pacing operation. The designer will assess the geometric conditions to ensure that sight distance and other geometric conditions are addressed. **Index 655 of the Design Standards** provides a basis for the traffic pacing operation and the development of the Traffic Control Plan. **Index 655** includes details of the four stages of a pacing operation and additional information related to:

1. Signing
2. Use of changeable message signs and attenuators
3. Use of traffic control officers
4. Contractor requirements

If it is determined that a pacing operation will be used, the designer should obtain concurrence from the Captain of the Florida Highway Patrol troop who will assist in the operation.

Exhibit 10-C contains definitions, and the procedure for calculating the pacing distance and the time intervals during which a pacing operation will be allowed.

Exhibit 10-C Traffic Pacing Sheet 1 of 12

Definitions

1. **HTD** = Hourly Traffic Demand in vehicles / hour. Hourly traffic volumes will be required for each hour in the analysis period. Hourly traffic volumes may be obtained from the Project Traffic Report, the Office of Planning or from field data collection. The designer should use the most recent values available.
2. **t_w** = Work Duration in minutes. This is the work time allotted for overhead construction. This value is usually between 10 and 30 minutes, and input in 5 minute increments.
3. **S_p** = Pacing Speed in MPH. This is the speed that the pacing vehicles travel and is usually 10, 15 or 20 MPH.
4. **S_r** = Regulatory Speed in MPH. This is the posted speed on the roadway segment.
5. **L** = Total Pacing Distance in miles. This is the total distance that the pacing vehicles are traveling at the pacing speed. It includes the distance required to clear traffic past the work area, and the distance required to provide the work duration. This distance is measured upstream from the work area.
6. **F_{HV}** = Heavy-vehicle adjustment factor. This factor is used to convert hourly traffic to equivalent passenger cars. Heavy vehicles include trucks, busses and recreational vehicles.
7. **P_t** = Percent Trucks (%).
8. **$FLOW_A$** = Traffic Demand Flow Rate in passenger cars per hour per lane. This is the traffic flow rate approaching the pacing operation from the upstream direction.
9. **$FLOW_B$** = Forced Traffic Flow Rate in passenger cars per hour per lane. This is the traffic flow rate within the queue.
10. **$FLOW_C$** = Congested Traffic Flow Rate in passenger cars per hour per lane. This is the traffic flow rate of the vehicles escaping the queue.
11. **QGR** = Queue Growth Rate in MPH. The rate that the queue grows from the time the pacing operation begins until the pace cars exit the roadway.

Exhibit 10-C Traffic Pacing, Sheet 2 of 12

Definitions (Continued)

12. **QDR** = Queue Dissipation Rate in MPH. The rate that the queue dissipates after the pace cars exit the roadway.
13. **SW_A** = Speed of Shockwave 'A' in MPH. The speed of the shockwave at the boundary between traffic 'FLOW_A' and traffic 'FLOW_B'.
14. **SW_B** = Speed of Shockwave 'B' in MPH. The speed of the shockwave at the boundary between traffic 'FLOW_B' and traffic 'FLOW_C'.
15. **DENSITY_A** = Free Flow Density in vehicles / mile. The traffic density under free flow conditions.
16. **DENSITY_B** = Forced Flow Density in vehicles per mile. The traffic density under forced flow conditions.
17. **DENSITY_C** = Congested Flow Density in vehicles per mile. The traffic density under congested flow conditions.
18. **N** = Number of Lanes
19. **T_{total}** = Total time to conduct the pacing operation. The time from when the pace cars enter the roadway until the queue has dissipated and normal traffic flow is restored.
20. **ATC** = Actual Traffic Counts. Traffic counts can be obtained from the Office of Planning or collected on the project site. The designer needs hourly traffic volumes for a 24 hour period.
21. **PSCF** = Peak Season Conversion Factor. The Office of Planning publishes tables with the PSCF for each county in Florida. Each county table has a PSCF for the week that the traffic counts were collected. The factor converts the ATC to Peak Season Traffic representing the highest daily traffic for the year.
22. **AADT** = Average Annual Daily Traffic. In lieu of actual traffic counts the designer may use AADT provided by the Office of Planning. The AADT must be adjusted to peak season hourly traffic by applying the model correction factor and the hourly distribution factors.

Exhibit 10-C Traffic Pacing, Sheet 3 of 12

Definitions (Continued)

23. **MOCF** = Model Correction Factor. The MOCF converts AADT to peak season traffic.
24. **HDF** = Hourly Distribution Factors. Multiply the AADT by the HDT to obtain the traffic volume for a particular hour. The Office of Planning publishes hourly distribution factors for regions of the state.
25. **C** = Capacity. The capacity of the roadway under free flow conditions in passenger cars per hour per lane.
26. **Pc/h/ln** = passenger cars per hour per lane. Pc/h/ln represents the traffic volume or capacity of one lane adjusted for heavy vehicles.
27. **T_D** = Time to dissipate the queue in minutes. T_D is the amount of time beginning at the point when the pacing vehicles leave the roadway until the traffic returns to normal operating conditions.
28. **Q_{max}** = the maximum queue length. The maximum queue length occurs when the pacing vehicles reach the work zone.
29. **Speed_C** = the average speed of passenger cars when the roadway reaches capacity.

**Exhibit 10-C Traffic Pacing, Sheet 4 of 12
Worksheets**

FINANCIAL PROJECT ID: _____ FAP NO: _____

COUNTY: _____ DESIGNER: _____

STATE ROAD / LOCAL ROAD NAME: _____

SCOPE OF WORK: _____

SECTION NO: _____ MILE POST LIMITS: _____

DIRECTION OF TRAVEL (NB, SB, EB or WB): _____

Project Inputs:

1. Regulatory Speed (S_r) = _____
2. Pacing Speed (S_p) = _____
3. Work Duration (t_w) = _____
4. Number of Lanes (N): _____
5. Percent Trucks (P_t): _____
6. Peak Season Conversion Factor (PSCF) or
 Model Correction Factor (MOCF) = _____
7. 24-hour Traffic Volumes:

Hour	AM Traffic Volume	Hour	PM Traffic Volume
24 - 1		12-13	
1 - 2		13-14	
2 - 3		14-15	
3 - 4		15-16	
4 - 5		16-17	
5 - 6		17-18	
6 - 7		18-19	
7 - 8		19-20	
8 - 9		20-21	
9 - 10		21-22	
10-11		22-23	
11-12		23-24	

**Exhibit 10-C Traffic Pacing, Sheet 5 of 12
Worksheets (Continued)**

STEP 1: Calculate the hourly percentage of peak season traffic for each hour of the day (in pcphpl) and plot the 24 hour traffic percentages.

A. Calculate the Heavy Vehicle Adjustment Factor, $F_{HV} = 1 + \left(\frac{P_t}{100}\right) 0.5$.

B. If using actual traffic counts calculate the hourly traffic demand as follows:

$$HTD_i = \frac{(ATC_i)(PSCF)(F_{HV})}{N}$$

If using average annual daily traffic calculate the hourly traffic demand as follows:

$$HTD_i = \frac{(AADT)(MOCF)(HDF)(F_{HV})}{N}$$

C. Calculate the percent capacity, $\%C = \frac{HTD_i}{C} (100)$ where:

C = 2,400 pc/h/ln for 70 mph regulatory speed

C = 2,300 pc/h/ln for 65 mph regulatory speed

C = 2,250 pc/h/ln for 60 mph regulatory speed

C = 2,220 pc/h/ln for 55 mph regulatory speed

C = 2,150 pc/h/ln for 50 mph regulatory speed

Hour	AM Hourly Traffic Demand	Percent Capacity	Hour	PM Hourly Traffic Demand	Percent Capacity
24 - 1			12-13		
1 - 2			13-14		
2 - 3			14-15		
3 - 4			15-16		
4 - 5			16-17		
5 - 6			17-18		
6 - 7			18-19		
7 - 8			19-20		
8 - 9			20-21		
9 - 10			21-22		
10-11			22-23		
11-12			23-24		

**Exhibit 10-C Traffic Pacing, Sheet 6 of 12
 Worksheets (Continued)**

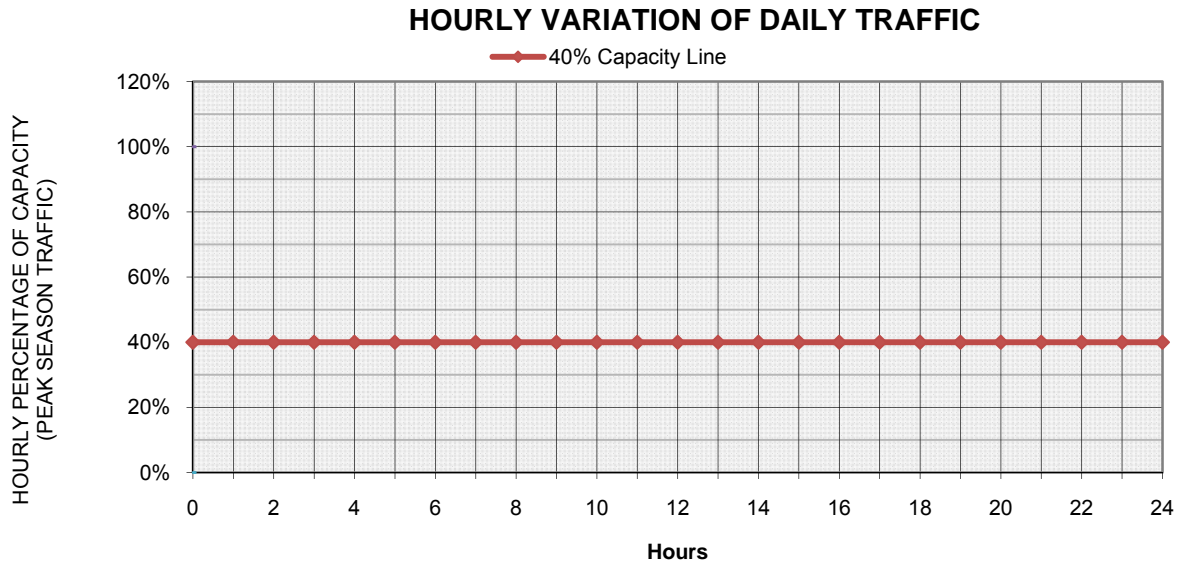

STEP 2: Calculate the Pacing Length, L .

$$L = S_p \left(\frac{t_w}{60} \right) \left(\frac{S_p}{S_r - S_p} + 1 \right)$$

STEP 3: Calculate the Maximum Queue Length, Q_{max} .

$$FLOW_A = HTD_i$$

$$DENSITY_A = \frac{FLOW_A}{S_r}$$

$$FLOW_B = 1,800 \text{ pcphpl (based on a 2.0 sec headway)}$$

$$DENSITY_B = \frac{FLOW_B}{S_p}$$

$$SW_A = \frac{FLOW_B - FLOW_A}{DENSITY_B - DENSITY_A}$$

$$QGR = S_p - SW_A$$

$$Q_{max} = QGR \left(\frac{L}{S_p} \right)$$

**Exhibit 10-C Traffic Pacing, Sheet 7 of 12
Worksheets (Continued)**

STEP 4: Calculate the Time to Dissipate the Queue, T_D .

$$FLOW_C = 2,400 \text{ pcphpl (assumed capacity value)}$$

$$DENSITY_C = \left(\frac{FLOW_C}{Speed_C} \right) \text{ where:}$$

$$Speed_C = 53 \text{ mph (for 70 mph regulatory speed)}$$

$$Speed_C = 50 \text{ mph (for 50 – 65 mph regulatory speed)}$$

$$SW_B = \left(\frac{FLOW_C - FLOW_B}{DENSITY_C - DENSITY_B} \right)$$

$$QDR = SW_A - SW_B$$

$$T_D = \left(\frac{Q_{max}}{QDR} \right) 60$$

STEP 5: Calculate the Total Time to Conduct the Pacing Operation, T_{total} .

$$T_{total} = \left(\frac{L}{S_p} \right) 60 + T_D$$

Label the pacing window chart by designating the time(s) that a pacing operation can begin and the time(s) after which a pacing operation cannot begin. The time that a pacing operation can begin is the point at which the percent capacity falls below 40%. The time after which a pacing operation cannot be started is the point at which the percent capacity reaches 40% minus T_{total} . Use one hour increments only.

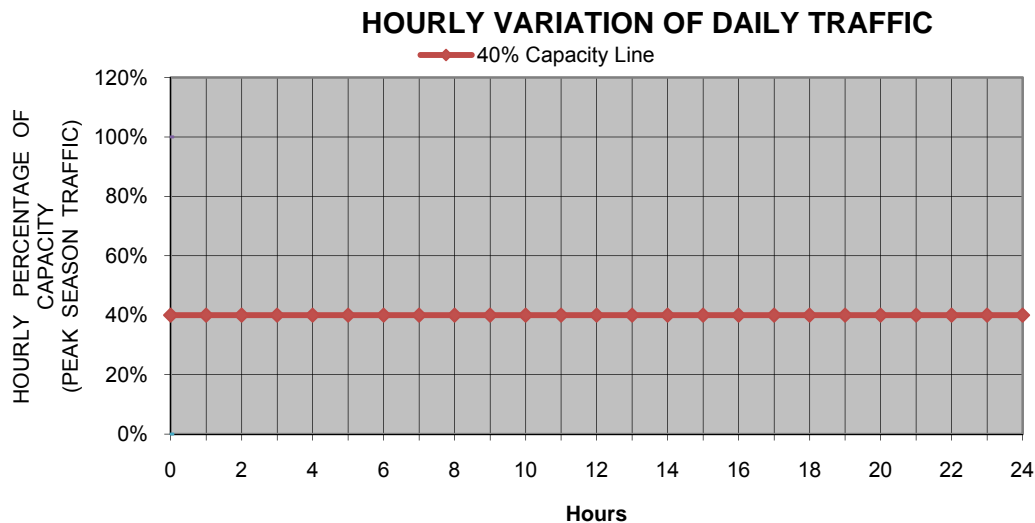

Exhibit 10-C Traffic Pacing, Sheet 8 of 12
Sample Worksheets

FINANCIAL PROJECT ID: 123456-7-89-10 FAP NO: NA
COUNTY: Tropic DESIGNER: John Smith
STATE ROAD / LOCAL ROAD NAME: I-4 @ Lee Road
SCOPE OF WORK: Replace Overhead Sign
SECTION NO: 75280 MILE POST LIMITS: 2.300
DIRECTION OF TRAVEL (NB, SB, EB or WB): East Bound

Project Inputs:

1. Regulatory Speed (S_r) = 65 MPH
2. Pacing Speed (S_p) = 20 MPH
3. Work Duration (t_w) = 25 minutes
4. Number of Lanes (N) = 3
5. Percent Trucks (P_t) = 6.71
6. Peak Season Conversion Factor (PSCF) = 1.04
7. 24-hour Traffic Volumes:

Hour	AM Traffic Volume	Hour	PM Traffic Volume
24 - 1	1406	12-13	6118
1 - 2	772	13-14	6390
2 - 3	599	14-15	6771
3 - 4	591	15-16	6675
4 - 5	942	16-17	6607
5 - 6	2116	17-18	5989
6 - 7	5666	18-19	5810
7 - 8	7302	19-20	5078
8 - 9	7173	20-21	4139
9 - 10	6719	21-22	3563
10-11	6275	22-23	3008
11-12	6067	23-24	2276

Exhibit 10-C Traffic Pacing, Sheet 9 of 12
Sample Worksheets (Continued)

STEP 1: Calculate the hourly percentage of peak season traffic for each hour of the day (in pcphpl) and plot the 24 hour traffic percentages.

A. Calculate the Heavy Vehicle Adjustment Factor,

$$F_{HV} = 1 + \left(\frac{P_t}{100}\right) 0.5 = 1 + \left(\frac{6.71}{100}\right) 0.5 = 1.034$$

B. Using actual traffic counts calculate the hourly traffic demand (*Hour 1 shown*)

$$HTD_i = \frac{(ATC_i)(PSCF)(F_{HV})}{N}$$

$$HTD_1 = \frac{(1406)(1.04)(1.034)}{3} = 504 \text{ pcphpl}$$

C. Calculate the percent capacity, $\%C = \frac{HTD_1}{c} \times 100$ where:

$C = 2,300$ pc/h/ln for 65 mph regulatory speed (*Hour 1 shown*)

$$\%C = \frac{HTD_1}{c} \times 100 = \frac{504}{2300} \times 100 = 21.9\%$$

Hour	AM Hourly Traffic Demand	Percent Capacity	Hour	PM Hourly Traffic Demand	Percent Capacity
24 - 1	504	21.90%	12-13	2193	95.40%
1 - 2	277	12.00%	13-14	2290	99.90%
2 - 3	215	9.40%	14-15	2427	105.50%
3 - 4	212	9.20%	15-16	2393	104.00%
4 - 5	338	14.70%	16-17	2368	104.00%
5 - 6	758	33.00%	17-18	2147	93.30%
6 - 7	2031	88.30%	18-19	2083	90.60%
7 - 8	2617	113.80%	19-20	1820	79.10%
8 - 9	2571	111.80%	20-21	1484	64.50%
9 - 10	2408	104.70%	21-22	1277	55.50%
10-11	2249	97.80%	22-23	1078	46.90%
11-12	2174	94.60%	23-24	816	35.50%

Exhibit 10-C Traffic Pacing, Sheet 10 of 12
Sample Worksheets (Continued)

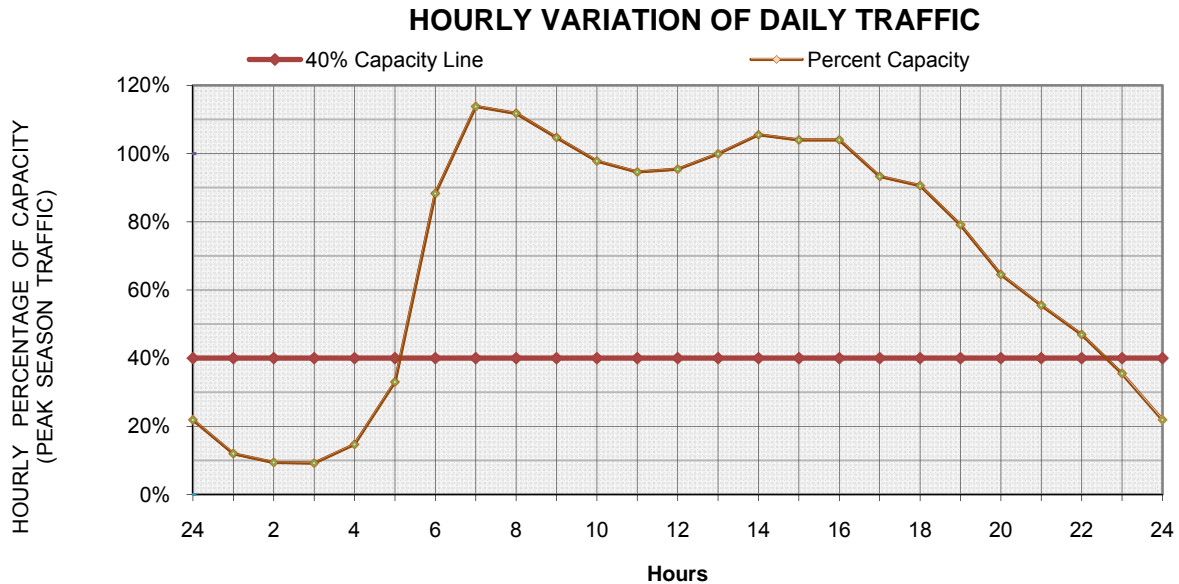

STEP 2: Calculate the Pacing Length, L .

$$L = S_p \left(\frac{t_w}{60} \right) \left(\frac{S_p}{S_r - S_p} + 1 \right) = 20 \left(\frac{25}{60} \right) \left(\frac{20}{65 - 20} + 1 \right) = 12.04 \text{ miles}$$

STEP 3: Calculate the Maximum Queue Length, Q_{max} , for hour 5 (4am to 5am).

$$FLOW_A = HTD_5 = 338$$

$$DENSITY_A = \frac{FLOW_A}{S_r} = \frac{338}{65} = 5.20 \frac{pc}{mi} / l$$

$$FLOW_B = 1,800 \text{ pcphpl (based on a 2.0 sec headway)}$$

$$DENSITY_B = \frac{FLOW_B}{S_p} = \frac{1800}{20} = 90 \frac{pc}{mi} / l$$

$$SW_A = \frac{FLOW_B - FLOW_A}{DENSITY_B - DENSITY_A} = \frac{1800 - 338}{90 - 5.20} = 17.24 \text{ mph}$$

$$QGR = S_p - SW_A = 20 - 17.24 = 2.76 \text{ mph}$$

$$Q_{max} = QGR \left(\frac{L}{S_p} \right) = 2.76 \left(\frac{12.04}{20} \right) = 1.66 \text{ miles}$$

Exhibit 10-C Traffic Pacing, Sheet 11 of 12
Sample Worksheets (Continued)

STEP 4: Calculate the Time to Dissipate the Queue, T_D .

$FLOW_C = 2,400$ pchpl (assumed capacity value)

$DENSITY_C = \left(\frac{FLOW_C}{Speed_C}\right)$ where:

$Speed_C = 50$ mph (for 50 – 65 mph regulatory speed)

$$DENSITY_C = \left(\frac{FLOW_C}{Speed_C}\right) = \left(\frac{2400}{50}\right) = 48 \frac{pc}{mile}$$

$$SW_B = \left(\frac{FLOW_C - FLOW_B}{DENSITY_C - DENSITY_B}\right) = \left(\frac{2400 - 1800}{48 - 90}\right) = -14.29$$

$$QDR = SW_A - SW_B = 17.24 - (-14.29) = 31.53 \text{ mph}$$

$$T_D = \left(\frac{Q_{max}}{QDR}\right) 60 = \left(\frac{1.66 \text{ mi}}{31.53 \text{ mph}}\right) 60 = 3.16 \text{ min}$$

STEP 5: Calculate the Total Time to Conduct the Pacing Operation, T_{total} .

$$T_{total} = \left(\frac{L}{S_p}\right) 60 + T_D = \left(\frac{12.04}{20}\right) 60 + 3.16 = 39.3 \text{ min}$$

HOURLY VARIATION OF DAILY TRAFFIC

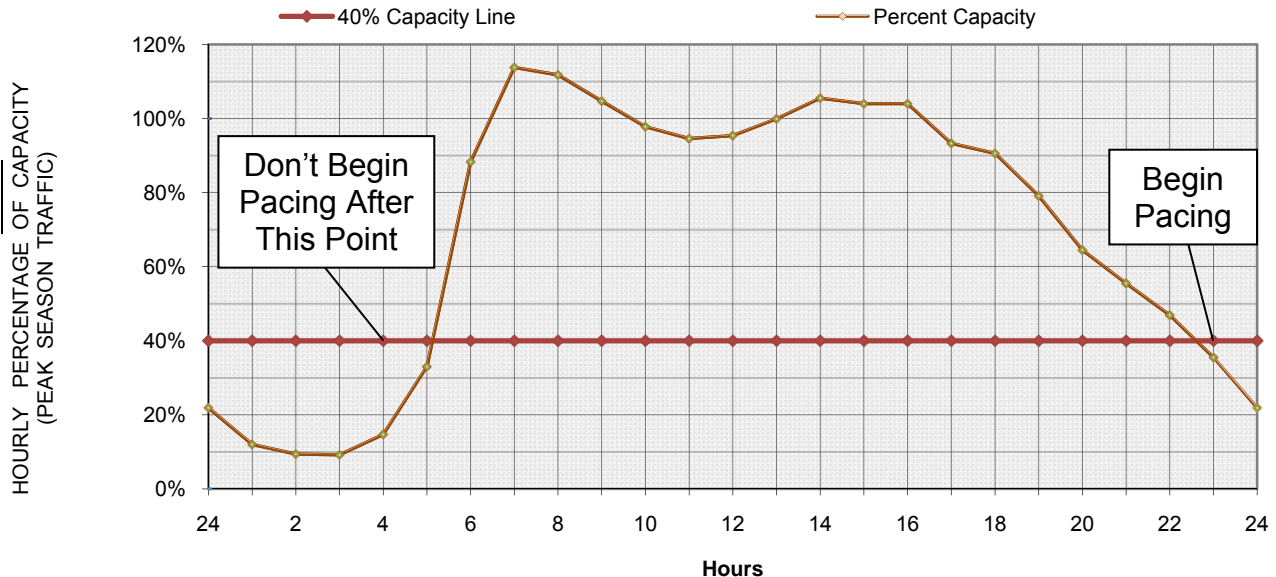

Exhibit 10-C Traffic Pacing, Sheet 12 of 12
Sample Worksheets (Continued)

Traffic Pacing Report

I-4 at Lee Road (Section 75280 EB)

Sign Replacement at mile post 2.300

Regulatory Speed = 65 mph

Number of Lanes = 3

Pacing Speed = 20 mph

Percent Trucks = 6.71

Work Duration = 25 min

Traffic Demand:

Hour	AM Hourly Traffic Demand	Percent Capacity	Hour	PM Hourly Traffic Demand	Percent Capacity
24 - 1	504	21.90%	12-13	2193	95.40%
1 - 2	277	12.00%	13-14	2290	99.90%
2 - 3	215	9.40%	14-15	2427	105.50%
3 - 4	212	9.20%	15-16	2393	104.00%
4 - 5	338	14.70%	16-17	2368	104.00%
5 - 6	758	33.00%	17-18	2147	93.30%
6 - 7	2031	88.30%	18-19	2083	90.60%
7 - 8	2617	113.80%	19-20	1820	79.10%
8 - 9	2571	111.80%	20-21	1484	64.50%
9 - 10	2408	104.70%	21-22	1277	55.50%
10-11	2249	97.80%	22-23	1078	46.90%
11-12	2174	94.60%	23-24	816	35.50%

HOURLY VARIATION OF DAILY TRAFFIC

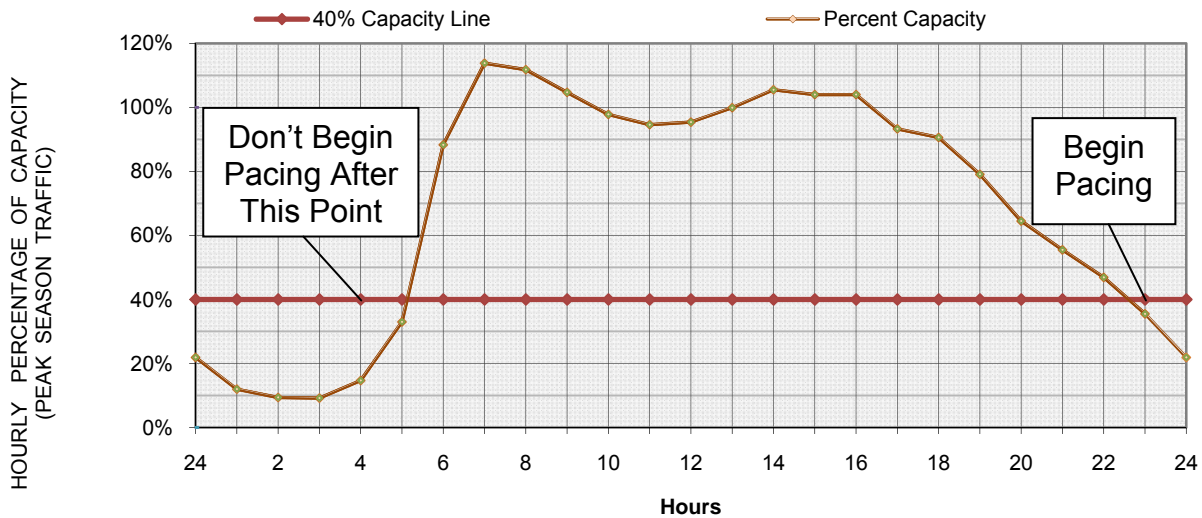

10.12.9 Detours, Diversions, and Lane Shifts

A **detour** is the redirection of traffic onto an alternate route, using state roads, county roads, or city streets, to bypass the work zone. A **diversion** is a special detour onto a temporary roadway adjacent to the existing or permanent roadway. A **lane shift** is the redirection of traffic onto a section of the permanent roadway or shoulder.

Detour signing is usually done under the direction of the traffic engineer who has authority over the roadway to be used. The detour should be signed clearly so drivers can traverse the entire detour and return to the original roadway. When detours are required, the geometry of the detour route should be compared against the type of traffic being routed through the detour. For example, detouring of traffic which includes large trucks and transit vehicles will require certain pavement widths, turning radius, and overhead clearance (including low power lines, span wires, and low hanging tree limbs). The structural capacity of the detour pavement should also be considered.

When detours are off of the state system, the designer shall coordinate with the local agency. The designer shall document that the local agency approves the detour route. The design should prevent or minimize interruption of local transit operations and emergency services. The designer shall coordinate with any affected local transit operations and emergency services and shall document that the affected agencies have been informed of the detour route.

The designer has two methods of paying for diversions: by (1) using the "special detour" lump sum pay item or (2) using the lump sum Maintenance of Traffic (MOT) pay item. When the special detour pay item is used, the work and quantities included for pay under the item are to be tabulated and noted in the plans. The special detour pay item is intended to be used in all situations where traffic is shifted one lane width or more onto temporary pavement.

A Diversion, which is to be signed as a lane shift, may be paid for under Special Detour, Pay Item 102-2 (Lump Sum). The ***Basis of Estimates Manual*** should be referenced to make sure that the appropriate items are included in this lump sum.

TTC plans shall include sufficient detail for diversion geometry. Diversions should be designed with shoulders (2 ft. min.) whenever practical. The radius of curvature and taper lengths shall be shown. Diversions should be designed and operated as close to the normal speed as possible. When speed reductions are necessary, the reduction should be in accordance with the ***Design Standards, Index 600***. The recommended minimum radius of curvature (without superelevation) for diversions is shown in ***Table 10.12.2***.

10.12.10 Above Ground Hazards

An above ground hazard is anything that is greater than 4 inches in height and is firm and unyielding or doesn't meet breakaway requirements. For treatment of an above ground hazard, see the *Design Standards, Index 600*.

10.12.11 Drop-offs in Work Zones

Acceptable warning and barrier devices for traffic control at drop-offs in work areas are detailed in the *Design Standards, Index 600*.

The designer should anticipate drop-offs that are likely to occur during construction and provide the appropriate devices. For those projects where barrier wall would be needed and yet it is not practical, such as highly developed urban areas where numerous driveways exist, the designer should consider adding plan notes that require conditions be returned to acceptable grade by the end of the day's operation.

10.12.12 Narrow Bridges and Roadways

Simultaneously working on both sides of a bridge (bridge widening, etc.) or roadway may be hazardous due to the narrow widths of some bridges and roads. Consideration should be given to specifying that work be done only on one side at a time, particularly on high speed roadways. In some situations, the installation of barrier wall on both shoulders can totally eliminate any shoulder or refuge area. The designer should consider whether or not this restriction of the effective width is acceptable and consistent with the desired operational ability of the facility.

10.12.13 Existing Highway Lighting

If the project has existing highway lighting, the designer shall prepare a specification that completely describes what is to be done with the existing lighting during all phases of construction. Give detailed information on any poles that have to be relocated or any new conduit or conductors that would have to be installed. A field survey should be conducted to establish the condition of the existing system and what responsibility the contractor will have in bringing the existing lighting system back to an acceptable condition.

The designer should use the appropriate pay items and quantities for all work to be done for maintaining existing lighting throughout construction.

10.12.14 Work Area Access

The TTC plan should consider the need for a work area access plan. This is a constructability issue in which the designer addresses the question of how the contractor is to get materials and equipment into the work area safely. This is a particularly critical issue on high speed facilities (such as the Interstate) where barrier wall is used to protect median work areas. Some consideration may be given to the design and construction of temporary acceleration and deceleration lanes for the construction equipment. The following should be considered in the design, planning and operation of work zones.

1. Anticipate types of work zones likely to create ingress/egress problems. Examples are median work spaces requiring work vehicles to merge into/out of high-speed traffic and work activities that will generate frequent delivery of materials such as paving projects and the delivery of fill material.
2. Access to the work area should be included in TTC Plan. When operations require access and it is not addressed in the plan the Worksite Traffic Supervisor in the field must address the issue within the limits of their authority.
3. Construction vehicle size, configuration and turning path/radius requirements must be considered in addressing ingress/egress.
4. For haul route crossing details see ***Index 606 of the Design Standards***. For non-limited access facilities crossover details see ***Index 630 and 631 of the Design Standards***; for limited access facilities see ***Index 665 of the Design Standards***.
5. Adequate acceleration/deceleration space for work vehicles should be provided.

6. The location of access opening should provide good sight distance for oncoming traffic.
7. In extreme conditions lane closures may need to be considered.
8. Openings in barrier walls should be planned to ensure that ends are properly protected and that the walls do not create sight problems.
9. Ingress/egress condition may justify lowering the speed limit.
10. Warning signs for truck ingress/egress conditions are available (***Index 600 of the Design Standards***) and should be used when appropriate. Special warning signs may be necessary.
11. The use of Portable Changeable Message Sign should be considered.

10.12.15 Railroads

Railroad crossings that are affected by a construction project must be evaluated to ensure that the Temporary Traffic Control Plan does not cause queuing of traffic across the railroad tracks. Evaluate the Plan's signal timing, tapers, lane closures and distance to intersections as compared to projected peak traffic volumes. The effects of the temporary traffic control plan on interconnected traffic signals and railroad signals must be evaluated to avoid conflicting or ineffective signal controls.

10.12.16 Pay Items and Quantities

The ***Basis of Estimates Manual*** contains detailed instructions on calculating many of the MOT quantities.

THIS PAGE LEFT BLANK INTENTIONALLY

10.13 Speed Zoning

10.13.1 Regulatory Speeds in Work Zones

Regulatory speeds should be established to route vehicles safely through the work zone as close to normal highway speeds as possible. Temporary Traffic Control Plans (TTC plans) for all projects must include specific regulatory speeds for each phase of work. This can either be the posted speed or a reduced speed. The speed shall be noted in the TTC plans: this includes indicating the existing speed if no reduction is made. By virtue of **Florida Statute 316.187**, all regulatory speeds must be established on the basis of a traffic and engineering investigation. Designers should only reduce speed when the temporary geometry requires it. The justification for establishing work zone regulatory speeds different from normal speed limits must be included in the project file. The TTC plan and the project file will suffice as the traffic and engineering investigation.

When field conditions warrant speed reductions different from those shown in the TTC plan, the contractor may submit to the project engineer for approval by the Department, a signed and sealed study to justify the need for further reducing the posted speed or the engineer may request the District Traffic Operations Engineer (DTOE) to investigate the need. It will not be necessary for the DTOE to issue regulations for regulatory speeds in work zones due to the revised provisions of **Florida Statute 316.0745(2)(b)**.

Regulatory speed signs in rural areas (Interstate and Non-Interstate) are to be preceded by a "Reduced Speed Ahead" sign positioned as follows:

Interstate (Rural)	-	1000 ft. in advance
Non-Interstate (Rural)	-	500 ft. in advance

Urban areas, ordinarily do not require an advance sign, however, the sign may be included at the designer's option.

The regulatory speed and "Reduced Speed" Ahead signs are to be paid for under the pay item for Construction Work Zone Signs (per each per day).

If the existing regulatory speed is to be used, consideration should be given to supplementing the existing signs when the construction work zone is between existing regulatory speed signs. For projects where the reduced speed conditions exist for greater than 1 mile in rural areas (Non-Interstate) and on Rural or Urban Interstate, additional regulatory speed signs are to be placed at no more than 1 mile intervals.

Engineering judgment should be used in the placement of additional signs. For urban situations (Non-Interstate), additional regulatory speed signs are to be placed at a maximum of 1000 ft. apart.

The regulatory speed should not be reduced more than 10 mph below the posted speed, and never below the minimum statutory speed for the class of facility, without the approval of the District Traffic Operations Engineer and the appropriate District Director (See the ***Design Standards, Index 600***).

To ensure credibility with motorists and enforcement agencies, temporary regulatory speed signs shall be removed or covered as soon as the conditions requiring the reduced speed no longer exist. Once they are removed or covered, the speed existing prior to construction will automatically go back into effect unless new speed limit signing is provided for in the plans. On projects with interspaced work activities (such as interstate resurfacing) speed reductions should be located in proximity to those activities which merit a reduced speed, and not “blanketed” for the entire project.

The TTC plan phase notes shall indicate when to remove the regulatory reduced speed limit signs.

When the regulatory speed is changed in a work zone, the permanent speed limit signs are to be removed or covered during the period when the work zone regulatory speed zones are in effect.

10.14 Law Enforcement Services

Work zones may require law enforcement services to protect both the workers and motorists during construction or maintenance activities. The need for these services should be considered during the development of the Temporary Traffic Control Plans. The service needed could involve a Speed and Law Enforcement Officer for speed and traffic law enforcement, a Traffic Control Officer for traffic control, or a combination of the two.

A contractual agreement between the FDOT and the Florida Department of Highway Safety and Motor Vehicles (DHSMV) was entered into for the use of Speed and Law Enforcement Officer (Central Office Statewide Contract) to exclusively enforce the speed limit in specified work zones. (REF. **Contract #B-8970**) Each district has also been encouraged to enter into contractual agreements with local law enforcement agencies to provide additional resources for the use of a Speed and Law Enforcement Officer (District Contract).

Traffic Control Officers are to be used for traffic control only as described in **Specification 102**. The Traffic Control Officer may be acquired from local law enforcement agencies or the Florida Highway Patrol. Such Traffic control law enforcement services shall not include patrolling or speed enforcement. The use of Traffic Control Officers may be called for on a project that also uses Speed and Law Enforcement Officers.

10.14.1 Use of Speed and Law Enforcement Officers

The Department has determined that construction or maintenance activities that divert, restrict, or significantly impair vehicular movement through work zones may require patrolling by a Speed and Law Enforcement Officer specifically for speed and law enforcement to provide a safer environment for both workers and motorists. A Speed and Law Enforcement Officer may also be warranted, for the safety of the motorists, through some work zones during times when construction or maintenance activities are not in progress.

Conditions to consider for the use of Speed and Law Enforcement Officer may include, but not be limited to:

1. A work zone requiring reduced speeds
2. Work zones where barrier wall is used adjacent to through traffic

3. Night time work zones
4. Areas with intense commuter use where peak hour traffic will require speed enforcement
5. A work zone in which workers are exposed to nearby high speed traffic
6. Work zones similar to the ***Design Standards, Indexes 608, 613, 614, and 651***

10.14.2 Use of Traffic Control Officer

There are certain construction activities that impede traffic flows such that supplemental traffic control is desirable. Uniformed law enforcement officers are respected by motorists; therefore, it may be in the best interest of the situation to utilize Traffic Control Officer as a supplement to traffic control devices to assist the motorists and provide a safer work zone.

By specification, conditions for the use of Traffic Control Officer shall be:

1. Traffic control in a signalized intersection when signals are not in use.
2. When ***Index Nos. 607 and 619*** of the ***Design Standards*** is used on Interstate at nighttime and required by the plans.
3. When pacing/rolling blockade is used.

10.14.3 Coordination, Documentation and Payment

On each individual project, the designer and/or the project manager shall coordinate with the district construction office to determine if law enforcement services will be justified. If possible the associated law enforcement commander shall also be included in the coordination.

Once the determination has been made that law enforcement will be used on a project, the designer/project manager and the construction engineer shall develop supporting documentation for each TTC phase including the conditions requiring the law enforcement services, the number of personnel, the man-hours, and any other requirements that may be established. The supporting documentation for Speed and Law Enforcement Officer and Traffic Control Officer will be kept separate.

The documentation for Speed and Law Enforcement Officer will be shown in the Computation Book only and there will be no reference made to these services in the

plans except as shown on the Summary of Pay Items Sheet.

Speed and Law Enforcement Officer can be used on non-limited access highways provided that the District Director of Transportation Operations has approved its use.

Speed and Law Enforcement Officer will be paid for under pay item 999-102-xxa - Speed and Law Enforcement Officer (Do Not Bid) HR.

For Traffic Control Officer, the TTC plan shall clearly indicate the intended use of the officer(s) during each phase of construction, the need for the service, the number of officers needed, and the required man-hours. Traffic Control Officer will be paid for under pay item 102-14 - Traffic Control Officer HR. Complete documentation that complies with the TTC plan shall be included in the Computation Book.

The initial coordination between the designer/project manager and construction shall take place prior to Phase II. The final determination of man-hours and final documentation shall be accomplished at the same time that construction days are set.

10.14.4 Other Uses of Law Enforcement

The contractor may choose to use law enforcement services beyond the details of the TTC plan for situations that assist with mobilization, demobilization, TTC setup, and other instances where he or she prefers the use of law enforcement.

The contractor is responsible for the coordination of these uses and will be included under the Lump Sum Maintenance of Traffic pay item. These contractor required services are not to be included in the Department's contract pay items for law enforcement services.

10.15 Motorist Awareness System (MAS)

The purpose of a Motorist Awareness System (MAS) is to increase the motorist awareness of the presence of active work and provide emphasis on reduced speed limits in the active work area. A MAS is created by using a combination of several different traffic control devices to draw attention to the legal speed and inform the motorist of his vehicle speed. Descriptions of some MAS devices are provided below. The *Design Standards, Index 670*, provide details on the most effective combination and placement of MAS traffic control devices.

The Department's goal is to achieve the same respect for Work Zones that School Zones currently receive. The key in achieving this respect is to discontinue blanket speed limit reductions in work zones, increase enforcement, and to remove the MAS when the conditions requiring it no longer exist and restore the speed limit within the limits of the project to the posted speed limit. Specifically, MAS components are to be activated when the lane closure is setup and deactivated when the lane closure is taken down. All MAS components shall be moved outside of the clear zone or to be shielded by a barrier or crash cushion when not in use.

The MAS shall be used if all of the following conditions exist:

1. Multilane facility
2. Posted speed limit is 55 mph or greater
3. Work activity requires a lane closure for more than 5 days (consecutive or not)
4. Workers are present

The following is a list of some of the devices that are used as part of a Motorist Awareness System.

10.15.1 Portable Regulatory Signs (PRS)

The purpose of this device is to highlight the regulatory speed for the work zone. A portable regulatory sign is a portable trailer that has the regulatory speed sign mounted with flashing lights on each side of the sign. The lights are used to draw the driver's attention to the regulatory speed.

10.15.2 Radar Speed Display Unit (RSDU)

The purpose of this device is to display the motorist's work zone speed. A radar speed display unit is a portable trailer that displays the speed of approaching motorists on a LED display panel. The radar mounted on the unit detects the speed. A regulatory sign with the posted speed is mounted above the LED display panel. The unit is fitted with a device, which counts the number of vehicles passing the Radar Speed Display Unit. The counter device is capable of:

1. Digital readout of the number of vehicles passing the radar speed display unit.
2. Digital readout of the number of vehicles exceeding the speed limit shown on the radar speed display unit.

The device can be set that only speeds greater than the work zone speed are displayed.

10.15.3 Speed and Law Enforcement Officer

The use of moving officers on a random basis, in conjunction with the other MAS devices, has proven to be effective. Although the Speed and Law Enforcement Officer is not shown on **Index 670**, the Designer should include the Speed and Law Enforcement Officer (DO NOT BID) pay item when using this Index. Department personnel are responsible to identify when Speed and Law Enforcement Officers are needed based on actual field conditions, document the manhours used and directly pay the appropriate law enforcement agency. See **Section 10.14** for additional information.

THIS PAGE LEFT BLANK INTENTIONALLY

Chapter 11

Stormwater Pollution Prevention Plan

11.1	General	11-1
------	---------------	------

THIS PAGE LEFT BLANK INTENTIONALLY

Chapter 11

Stormwater Pollution Prevention Plan

11.1 General

A Stormwater Pollution Prevention Plan (SWPPP) shall be developed and implemented for each FDOT construction project that disturbs one or more acres of total land area and discharges to waters of the United States. The State of Florida Department of Environmental Protection Generic Permit for Stormwater Discharges from Large and Small Construction Activities, herein referred to as the DEP Generic Permit, applies to projects where multiple, separate, and distinct construction activities may be taking place at different times and at different schedules under one contract plan. In these situations, if the combined total area of disturbed land is equal to or greater than one acre, the requirements of the DEP Generic Permit will apply.

The site specific SWPPP is a requirement of the DEP Generic Permit. In order to use this permit:

1. The FDOT must prepare a plan that assures compliance with the terms and conditions of the DEP Generic Permit. This includes obtaining a state stormwater quality permit, if appropriate.
2. The Contractor must file a Notice of Intent (NOI) and submit payment of permit fee to the DEP.

Distribution of the NOI, SWPPP and signed certification statements will be in accordance with ***Procedure No. 650-040-003, NPDES Permits for Stormwater Discharges from Highway Construction Sites.***

The objectives of the SWPPP are to:

1. Prevent erosion where construction activities are occurring
2. Prevent pollutants from mixing with stormwater
3. Prevent pollutants from being discharged by trapping them on-site, before they can affect the receiving waters

Note: For the purpose of preparing a SWPPP, a pollutant is anything that could cause or contribute to a violation of state water quality standards.

A complete SWPPP consists of several items: SWPPP sheets, other plan sheets and documents referenced in the SWPPP sheets, the contractor's approved **Section 104** Erosion Control Plan, inspection reports, and documentation of field changes that were made to better address the objectives.

Preparing and implementing a SWPPP involves evaluating the site, selecting and describing control measures to address the objectives, and implementing, installing, inspecting, and maintaining the controls.

Evaluating the site and selecting and describing the controls are done during the design phase and are documented in the SWPPP sheets. The SWPPP sheets are prepared by the responsible design engineer under the direction of the District Design Engineer or District Consultant Project Management Engineer (if this person reports directly to the Director of Transportation Development (Production)). The SWPPP sheets should be prepared in consultation with Drainage, Construction and Environmental personnel, as required. The SWPPP sheets shall be sealed. Refer to **Volume 2, Chapter 28** for guidelines for preparing the SWPPP sheets.

Implementing, installing, inspecting, and maintaining the controls are the responsibility of Construction and the contractor.

Chapter 12

Right of Way

12.1	General	12-1
12.2	Procedures for Establishing R/W Requirements.....	12-3
12.2.1	Open Cut and Fill Roadway Sections.....	12-3
12.2.2	Curb and Gutter Roadway Section.....	12-4
12.2.3	Access Management.....	12-5
12.2.4	Procedures for Decision Making	12-7
12.2.5	Transmittal of R/W Requirements	12-8
12.3	Process for Establishing Right of Way Requirements.....	12-9
12.3.1	New or Major Reconstruction Projects	12-9
12.3.2	Reconstruction Projects With Anticipated R/W Requirements	12-10
12.3.3	Projects Without an Identified R/W Phase	12-11

Figures

Figure 12.3.3	R/W Requirements Generalized Process Flow Diagram.....	12-13
---------------	---	-------

THIS PAGE LEFT BLANK INTENTIONALLY

Chapter 12

Right of Way

12.1 General

To assist the roadway designer's understanding of right of way (R/W) requirements, which must be addressed during the project development and design phases of projects, the following terms are briefly defined as an introduction.

Right of Way is real property or an interest therein, donated or acquired by purchase or condemnation, to accommodate transportation improvements. Fee simple is the strongest interest available to the Department and is sought for most permanent highway facilities. When improvements are designed which will fall outside of the existing R/W boundaries, additional lands must be identified and acquired. All necessary right of way and easements must be in Department ownership prior to advertisement of the project for letting.

Limited Access R/W is purchased for facilities such as Interstate and Expressways. This limits public access to interchange connection-points designed with entrance and exit ramps and limits access to motorized vehicular traffic. Pedestrians and bicycles are restricted in the interest of traffic capacity and safety.

Controlled Access R/W is acquired for the remaining State Highway System. This permits the general public and landowners along the corridors reasonable access, but in a controlled pattern that will facilitate the movement of through traffic.

Perpetual Easements (perpetual right of use over, under or through the property of another) are used when permanent structures or improvements are to be constructed and maintained on parcels where acquisition of fee title would be impractical, i.e., when acquisition of the fee would cause excessive severance damages due to green area or setback requirements or where underground structures are to be constructed which will not impair the surface utility of the land. A sight triangle or drainage facility are examples of features that may require a perpetual easement. Condemnation powers may be utilized to acquire necessary perpetual easements.

Temporary Easements (a temporary right of use over, under or through the property of another) are used when it is necessary to temporarily occupy a parcel for a specific purpose such as construction of temporary detours, stock piling materials or parking

equipment. No improvement which requires maintenance by the Department beyond the term of the easement can be constructed on a temporary easement.

License Agreements (permission to do a particular thing which without the license would not be allowable) are used to gain access to adjoining properties for sloping, grading, tying in, harmonizing and reconnecting existing features of the licensor's property with the highway improvements to be constructed. This work is solely for the benefit of the property owner. The Department does not compensate for license agreements. If the owner refuses to execute the agreement, the Department will not perform the work.

Licenses are included here as real property interests for convenience, but they are not real property interests. A license, with respect to real property, is a privilege to go on the premises for a certain purpose but does not vest any title in the licensee.

12.2 Procedures for Establishing R/W Requirements

The procedures for addressing R/W requirements require engineering analyses, economic comparisons and professional judgments. Consultation with the District R/W Surveyor and District R/W Manager is required. One excellent method of providing the consultation is the "R/W Partnering" concept with all parties that have a vested interest participating in the decision making process.

12.2.1 Open Cut and Fill Roadway Sections

R/W requirements along the project boundaries are dictated by the actual construction limits plus a reasonable maintenance buffer. The roadway cut and fill slopes, drainage ditch slopes and other construction elements are used to define the construction limits, which are generally shown on the roadway cross sections. R/W requirements are determined by reviewing the plotted cross sections after the roadway and drainage design elements have been established and major revisions are highly unlikely.

The procedures should, at this point, include a joint review of the proposed R/W, including a field review if necessary. The design details and the property information must be reviewed by the designer, personnel from the R/W Office and the R/W Mapping Office. This review should be scheduled during the Phase II design process as defined in this manual and should address such issues as:

1. Will additional R/W be required for project access, maintenance of the facility, or transit facility needs? Check pond sites, high embankment slopes, bridges, outfalls, canals and similar sites.
2. Can acquisitions be avoided or design modified to avoid substantial damages to remainder property or businesses? Examples include designing retaining walls or by adjusting slopes or grades to reduce the difference in elevation between the remainder and the project grade at the R/W line.
3. Can the roadway grades be revised or connections relocated so access to the remainders can be constructed without damaging the use of the remainder, thereby minimizing or avoiding severance and business damages caused by altering the access?
4. Can drainage facilities (outfalls, ponds, ditches, etc.) be maintained without additional R/W space? Can uneconomic remainders be used for stormwater treatment?
5. Has consideration been given to joint use ponds (including golf course ponds) and/or regional treatment facilities?

6. Check the suitability and cost effectiveness of storm water treatment facilities and the status of permit approval.
7. What types of legal instruments are likely to be required to secure the appropriate property rights for the project?
8. Review the status of R/W activities by others in the project area. Avoid multiple acquisitions from the same owner at ramp terminals, intersections and by future FDOT projects.
9. Check for potentials of hazardous materials, "4F" parcels, utility easements, landlocked remainders and parcels, which could be eliminated.
10. Check for acquisitions involving existing treatment systems which could be mitigated within the FDOT system.
11. Discuss the possibility of advance acquisition of any parcel where development is imminent.
12. Check for incidental work which will fall outside of R/W such as trenching, wall forms, or equipment maneuvering space.
13. Check for availability of offsite property owned by FDOT which could be used for mitigation sites.
14. Discuss status of any R/W being claimed by maintenance pursuant to **Section 95.361, F.S.** (Maintenance Statute).

12.2.2 Curb and Gutter Roadway Section

Establishing R/W requirements in urban sections will generally follow very similar procedures as the open roadway section projects. The analysis and decision making is complicated by more property owners, generally higher property values, businesses, and more complex access management problems.

The roadway and drainage design must be developed to a point where all major elements of the project (including transit facilities, signalization poles, lighting poles and overhead sign foundations) are firmly fixed. On projects with sidewalks and driveway connections, the design elements can be accurately established ONLY if proper survey data has been obtained for the designer's use. Profile elevations along the proposed R/W line and back of sidewalk and half-sections or profiles at each driveway location should be obtained as a minimum standard practice.

The design engineer must perform the design work required to establish the project profile

grades and the back of sidewalk grades to minimize the grade differences at the R/W line. Areas of superelevation must be analyzed very carefully. Split profile grades or other design strategies may be required to accommodate the proposed construction of the facility within minimum R/W limits.

The developed drainage and roadway design elements should be plotted on the plan sheets and the cross sections, which will establish the preliminary R/W requirements along the project boundaries as indicated by the construction limits. A good quality control review and a joint review with R/W appraisers and R/W Mapping personnel at this time will assist in determining the final R/W requirements. The same issues listed earlier in these procedures should be addressed.

The design engineer cannot assume the property owner's intentions or disposition with respect to his property. The designer must design the highway facility within the existing R/W or request acquisition of R/W to accommodate the project elements. The most economical means of constructing the project should always be the objective. Alternate design studies will be required in many locations to determine if additional R/W should be purchased, a retaining wall constructed or modified slopes and barrier system should be considered. A reasonable estimate of R/W costs or damages expected must be obtained from the R/W Office in order to make such a design study. Alternate construction methods may be shown on the plans as preferred and alternate methods.

12.2.3 Access Management

Access to the Department's facilities is an important element of the design and R/W determination procedures. Access Management is discussed in **Chapter 1, Section 1.8** of this volume. The designer must understand and follow the **Access Management Rules (14-96 and 14-97)** and the procedures and directives adopted (**Topic Numbers 625-010-020 and 625-010-021**) to implement the objectives of those rules. Identification of access and median opening location in relation to individual parcels should be completed before appraisal.

The following activities should be accomplished by the Designer:

1. The access classification of the roadway segment and the connection category of the driveways must be determined. The designer must be aware of the nature, type, frequency of trips and number of vehicles utilizing the driveway.
2. The designer must make a determination as to which driveways are in conformance, which are to be maintained, which are to be closed and which are to be modified to bring them into compliance.

3. The designer must obtain sufficient field survey data to establish the highway grades, horizontal alignment and the existing ground elevations in the vicinity of the driveway location. The data necessary to accurately design the driveway connection and determine an acceptable tie-in with the existing surface should be obtained as a minimum.
4. The designer should develop the most economical driveway design which will conform to the standards and the requirements of the access management objectives. Alternate designs and locations may be required to meet the property needs. Generally, the best option can be reached by negotiating with the property owner and/or tenant in a give and take atmosphere.

Driveway connections must be addressed in consultation with R/W personnel, generally appraisers or review appraisers. This fact should not be overlooked on projects such as resurfacing, etc. on which there may not be any other R/W requirements. R/W related decisions to be made about driveway connections, probably on a case-by-case basis, include:

1. If the driveway can be harmonized without impacting the value or the utility of the property, the Department should make a good faith offer to provide a suitable connection, at FDOT expense, in exchange for the permission to enter the land during construction for the purpose of doing the construction.
2. If providing the driveway connection reduces the remainder value or utility of the property, and no other acquisition of that property is contemplated for the project, a temporary easement will be requested and shown on the plans. The Office of R/W will see that the proper instruments are executed to enter onto the property for purposes of construction and to compensate the owner for damages, if any are due. If other acquisition of that property is proposed, these instruments should include the entry and compensation, if any, for the driveway.
3. If it cannot be determined during design that the harmonization work will reduce the remainder value or utility of the property, the owner can negotiate or claim damages through inverse condemnation during construction. This is not a desirable position for the Department, therefore the decision to employ this approach should be carefully considered.
4. Design should always, in their consultation with R/W personnel, make a determination if a fee taking or permanent easement is in the public interest to protect the facility. If a permanent easement will protect the facility and still give the owner some utility in the easement area, this may reduce the severance and business damages incurred.

12.2.4 Procedures for Decision Making

To assist in the decision process related to R/W requirements and instruments to be used the following guidelines from the Office of Right of Way may be used during the joint review process.

1. License agreements should be used only if the following conditions can be met:
 - a. The improvements or changes contemplated are minor in nature and are for the benefit of the property owner;
 - b. No compensation will be offered to the property owner;
 - c. None of the improvements are required for the construction of the transportation facility and removal of, or change to the improvements will not be detrimental to the facility;
 - d. The property owner is or will be fully informed of the nature and extent of the proposed improvements and has no objections; and,
 - e. The transportation facility can be constructed without adverse impact on safety or operation.

2. Temporary Easements should be used under the following conditions:
 - a. Where grading, tying in and harmonizing are necessary to avoid or minimize damage to the property;
 - b. The contemplated improvements or uses of the property owner's land are required only during the period of construction of the transportation facility;
 - c. The changes or improvements to the property owner's land are temporary and removal or alteration of the improvements subsequent to construction would not be detrimental to the facility; and,
 - d. After construction is complete, there will be no need for periodic re-entry onto the property for maintenance or other purposes.

3. Fee Simple R/W purchase should be used when the following conditions exist:
 - a. The planned improvements to the property owner's land are required as a part of construction of the transportation facility;
 - b. The improvement on that land must remain in place as a part of the facility; and,
 - c. Periodic re-entry to the property is required for maintenance or repair.

Perpetual Easements may be considered as an alternative to fee simple purchase in the R/W process if the owner may continue to enjoy some benefits of the property without impairing the Department's use and the total acquisition costs to the Department are less than the cost of acquiring fee.

12.2.5 Transmittal of R/W Requirements

R/W requirements should be finalized before transmitting them to the R/W Mapping Office for preparation of R/W maps. All R/W requirement transmittals should be in writing and clearly indicate in the memo and on the plans which parcels have been finalized and which parcels are still pending. An effort should be made to transmit final R/W requirements in usable segments. Priority should be given to the major, expensive or complex acquisitions that are going to require more time to acquire and complete the relocation of the occupants. Advanced design effort and final R/W requirement determination may expedite meeting production ready dates. It is desirable to transmit requirements as early as possible in the plans development.

All R/W requirements that are firm (primarily mainline construction limits) should be transmitted by Phase II. All other requirements that generally involve more detailed design completion (i.e., outfalls, pond locations, corner clips, access needs, etc.) must be submitted by the Phase III stage completion of the roadway design plans.

All R/W requirements must be transmitted by the completion of the Phase III roadway design plans.

12.3 Process for Establishing Right of Way Requirements

Establishing right of way requirements is a design process, but requires close coordination with other functions that have input to the project development and design of the project.

The Engineer of Record is responsible and must ensure that representatives from the appropriate functional areas are involved in the determination process. They must also ensure that a review of the final R/W requirements is performed. The "R/W Partnering" concept is an excellent method of ensuring that the proper consultation and input is received.

Generally, the R/W needs-determination will involve Roadway, Bridge and Drainage Design, Permits, Utilities, R/W appraisers, R/W Mapping and Legal functions. On consultant designed projects, the project manager's role as lead coordinator is especially critical.

12.3.1 New or Major Reconstruction Projects

These projects generally have Project Development and Environmental (PD& E) activities and Right of Way activities identified in the Work Program.

The project development process must address R/W requirements and perform sufficient preliminary engineering design to obtain preliminary cost estimates from the R/W Office. This may require that the PD& E consultant or in-house scope of services include work such as:

1. Preliminary roadway grades & geometric design.
2. Conceptual Drainage design and layout.
3. Analysis of major access management issues.
4. R/W Survey, property lines and limited topography.
5. R/W Mapping and property research activities.
6. Preliminary R/W cost estimates work.
7. Analysis of the transit, pedestrian/bicycle R/W needs.

This early identification of potential R/W requirements, approximate costs and work effort to complete R/W activities will greatly improve both cost estimates and schedules of projects. Also, involving R/W mapping and appraisers will assist in developing better project alternatives.

R/W requirements identified during the project development phase should not be considered firmly set. The R/W Office cannot be requested to begin R/W mapping or appraisal activities based on these requirements, without extraordinary efforts by the designer to support the acquisition process as in advance acquisition.

12.3.2 Reconstruction Projects With Anticipated R/W Requirements

These projects may not have a formal PD& E study, but they were determined during Work Program development to require some R/W acquisition. Most projects will require some environmental re-evaluation effort and all projects should have some preliminary engineering to better define objectives, scope and R/W requirements. The following general process, as it relates to R/W requirements should be established by design:

PHASE I

1. R/W Mapping will provide preliminary maps showing properties and all existing R/W lines for the project. These should be requested by the designer or by the project manager, on consultant projects.
2. The roadway designer will define project horizontal and vertical alignment and relate the existing R/W lines to the project as necessary to set R/W limits.

PHASE II

1. The roadway designer will identify proposed R/W requirements as indicated by the completed design details such as the following:
 - a. Limits of construction slopes for roadway and bridges.
 - b. Cross section elements, transit facilities, ditches, curb returns and sidewalks.
 - c. Driveway and street connections.
2. The drainage designer will identify proposed R/W requirements as indicated by the completed drainage features:
 - a. Retention or Detention Ponds.
 - b. Mitigation of environmental issues.
 - c. Drainage outfalls, sediment basins, etc.

The designer will review all proposed R/W requirements with the R/W Mapping Office. This should be performed during the Phase II design activities in order to make decisions on how each parcel of proposed R/W will be acquired. These

decisions will impact which design approach is taken. The issues to be discussed and decisions to be considered are detailed in **Section 12.2** of these procedures.

3. As R/W requirements are determined, the information is furnished to the R/W Mapping Office by memo documenting clearly which R/W is final and which is pending. The R/W Mapping Office will use only the final requirements transmitted to prepare R/W maps. See **Section 12.2.5**.

PHASE III

1. By the completion of Phase III design, all R/W requirements will be identified and transmitted to the R/W Mapping Office.
2. After transmittal of final R/W requirements to the R/W Mapping Office, design changes that affect R/W must be coordinated with the R/W Mapping Office, in a timely manner.

The R/W shown on the roadway plans must be in exact agreement with the R/W Maps.

It is essential that close coordination be maintained with R/W personnel in order to ensure that design changes affecting R/W are transmitted promptly.

12.3.3 Projects Without an Identified R/W Phase

Many improvements to highway projects are intended to be accomplished within the existing R/W. The widening or widening and resurfacing projects are examples. Such projects must be evaluated very carefully and very early in the roadway design process.

The addition of R/W requirements can have a tremendous impact on the schedule and on the anticipated costs of a highway improvement project.

R/W Mapping should be consulted on all projects to ensure that the proposed construction lies completely within the existing R/W and no Trustees of the Internal Improvement Trust Fund parcels or maintenance surveys are required.

For all projects determined to be completely within existing R/W the project manager or District R/W Surveyor as appropriate, shall notify the District R/W Manager, in writing, that no R/W is required. This notification will serve as the basis for the District R/W Manager's certification that all necessary R/W is available for construction.

If unanticipated R/W requirements are identified during design, the production management staff and the R/W Mapping Office should be notified as soon as the requirements are determined. The production management staff will then give direction as to continuing with the design and acquisition. If acquisition continues, it will follow the previously discussed procedures.

Figure 12.3.3 R/W Requirements Generalized Process Flow Diagram

(Each function must have well defined written procedures for the development, quality control, coordination and regular exchange of product evaluation.)

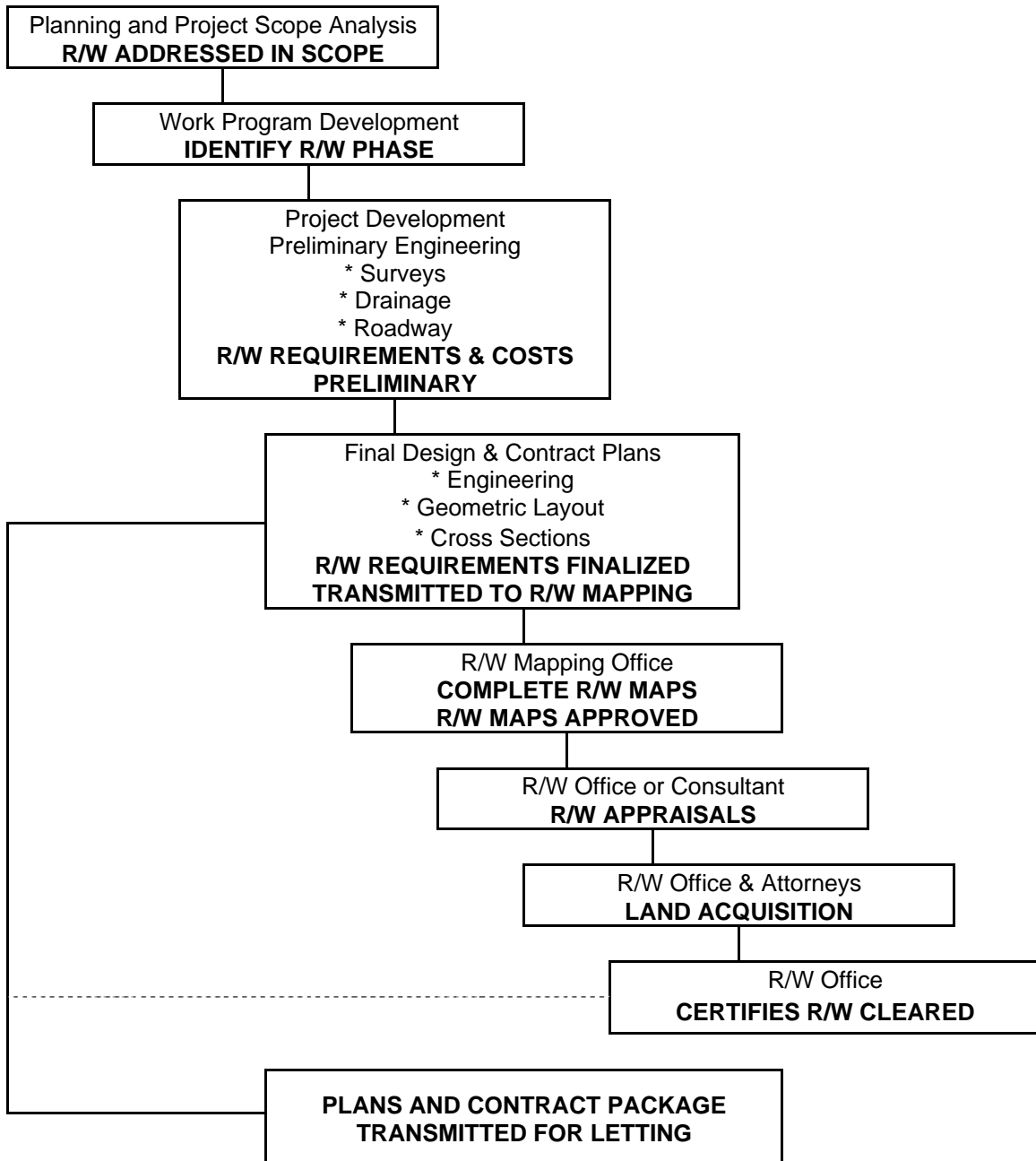

THIS PAGE LEFT BLANK INTENTIONALLY

Chapter 13

Initial Engineering Design Process

13.1	General	13-1
13.2	Initial Engineering Design (Phase I)	13-2
13.3	Scope, Objectives, Schedule and Budget	13-3
13.4	Project Design Controls and Standards	13-4
13.5	Support Services	13-5
13.5.1	Aviation Office Coordination	13-6
13.5.2	Projects Involving Existing Bridges	13-7
13.5.2.1	Projects Involving Steel Bridges	13-7
13.5.2.2	Projects Involving Bridges with Asbestos Containing Materials	13-8
13.5.2.3	Projects Involving Bridge Demolition	13-9
13.5.3	Projects Involving Bridges Over Navigable Water ..	13-10
13.5.4	Projects Affecting Interstate Logo Signs	13-10
13.5.5	Buy America Provisions	13-11
13.5.6	Traffic Monitoring Sites	13-12
13.6	Preliminary Geometry, Grades, and Cross Sections.....	13-13
13.7	Distribution of Exempt Public Documents	13-15
Tables		
Table 13.5.1	Construction of Airspace Obstructions - Notification	13-6
Exhibits		
Exhibit 13-A	Major Activities – Initial Engineering Process	13-ii

Exhibit 13-A Major Activities – Initial Engineering Process

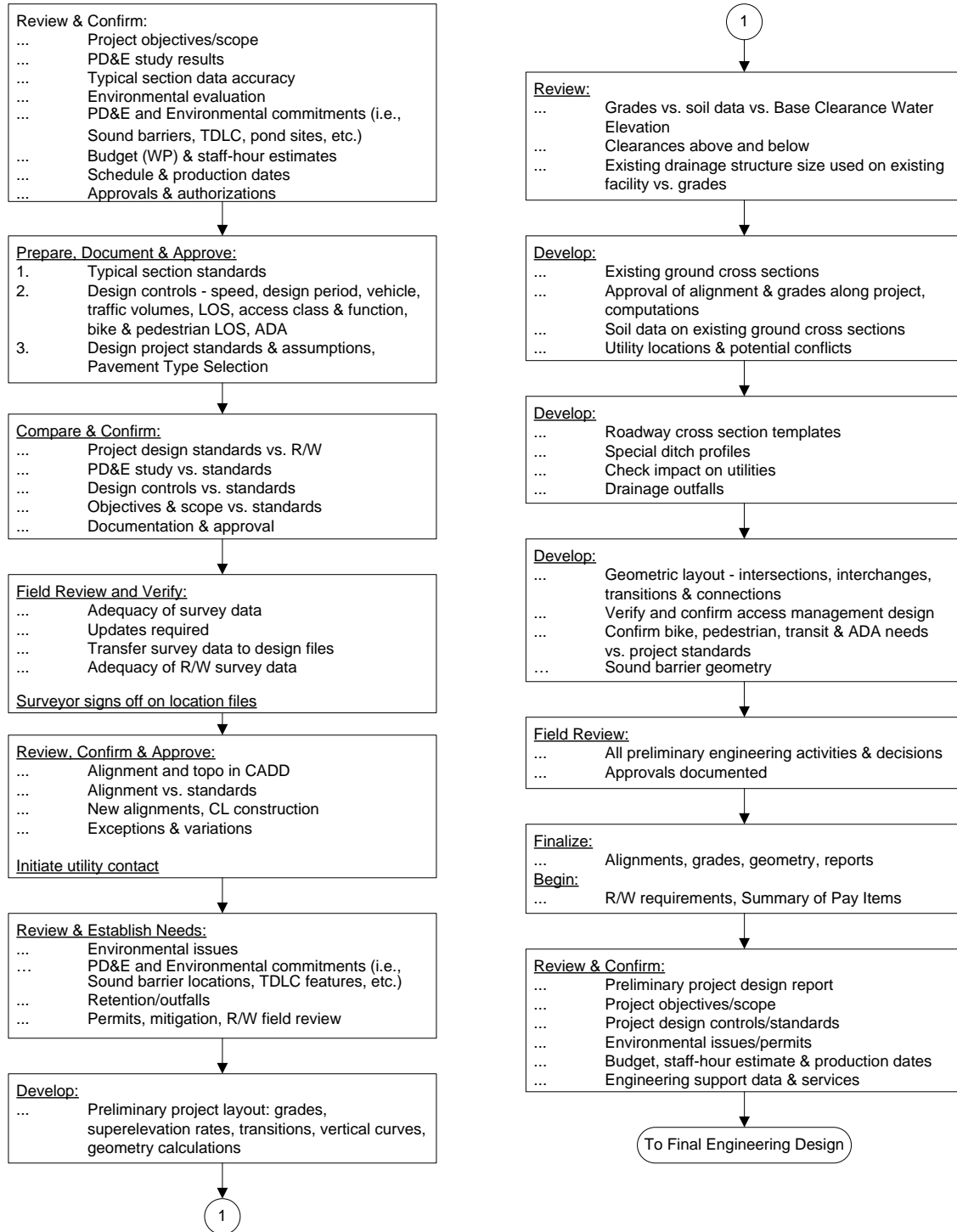

Chapter 13

Initial Engineering Design Process

13.1 General

The engineering design process, as discussed in this and following chapters, includes the data gathering, development and contract preparation phase of highway construction projects. It begins with the approval of the Project Location/Design and ends with the construction letting. It also includes the update process when the construction plans and specifications are ready and on hold in the district and require revising to make them contract ready. Throughout this design process, quality control will be exercised by those responsible for the engineering design and plans preparation activities by having a plan-do-check routine for each and every significant task or operation.

The engineering and design activities and the schedules depend on the type of project and the required effort to accomplish the desired objectives. Projects can be designated as three basic types:

1. **New Construction** - A highway or bridge project along a new corridor on new alignments, horizontal and vertical.
2. **Add Lanes and Reconstruct** - A highway project along an existing facility to add lanes, widen or add bridges, improve intersections, and, in general, upgrade and improve the capacity and safety of the facility.
3. **Other Projects** - May include Resurfacing, Restoration and Rehabilitation (RRR), Local Agency Program (LAP), or other projects such as a highway and/or enhancement projects - A highway and/or bridge project undertaken to extend the service life of an existing facility and to enhance the safety of the facility. These projects generally do not require a PD&E phase. The scopes are so varied that it is difficult to define them, except project by project. They can vary in magnitude from installing highway lighting for enhanced safety or resurfacing pavement to extend the service life, to minor lane and shoulder widening, bridge rail modification or intersection improvements. These projects may also include transit facilities, bike paths, sidewalks and landscaping projects.

13.2 Initial Engineering Design (Phase I)

It is important to distinguish the initial engineering design activities from planning and the preliminary engineering done during the Project Development and Environmental (PD&E) phase. If a PD&E phase has been completed, some of the activities discussed here may have been performed to varying levels during that phase. The information contained in the preliminary engineering report should be considered as the starting point for the initial engineering phase. In the case where there was not a PD&E phase, the initial engineering design activities must establish the project scope, controls and standards, data gathering requirements, right of way (R/W) needs, and major design elements necessary to determine that the project is viable and R/W can be cleared.

Generally, the initial engineering process **should** accomplish or complete the following activities:

1. Completely and fully define and document the objectives of the project and the scope of activities to accomplish them. This will almost always require an on-site review.
2. Develop and document a realistic staff-hour estimate and production schedule to accomplish the scope of activities identified.
3. Establish and document the design controls, assumptions, project design standards, exceptions, and variations. Significant changes to previously approved PD&E elements may result in a re-evaluation of the environmental document. Discuss with the District Environmental Management Office.
4. Identify all prior PD&E and environmental commitments such as the need to design and locate sound barriers (with insertion loss calculations), special pond site requirements, landscape or aesthetic considerations, transportation design for livable community issues, pedestrian and bicycle commitments, access commitments, wildlife management commitments, wetland issues, transit issues, etc.
5. Identify and document additional engineering, data gathering, and support services.
6. Determine and document the structural design requirements.
7. Determine and document if R/W is required.
8. Establish and document the review procedure and number of submittals, if different from guidelines provided in this manual.
9. Establish preliminary geometry, grades, and cross sections.
10. Identify and implement needed public involvement activities.
11. Develop Pavement Type Selection Report based on FDOT ***Pavement Type Selection Manual (Topic No. 625-010-005)***.

13.3 Scope, Objectives, Schedule and Budget

The project manager and other FDOT managers are responsible for the development, review and approval of the project objectives, scope of work, and schedule in accordance with the ***Project Management Guidelines***. They also must verify that required funds are in the work program.

The project objectives and scope are best confirmed and/or completed by:

1. Reviewing the PD&E study recommendations, conclusions and commitments, if they exist.
2. Performing a field review of the project with the project manager and personnel from other FDOT offices, such as Roadway Design, Traffic Operations, Safety, R/W Engineering, Utilities, Survey, Maintenance and Construction, as appropriate.
3. Requesting a review of the draft scope of services activities by FDOT offices, such as Maintenance, Construction, Design, Traffic Operations, Access Management, Public Transportation, Pedestrian and Bicycle, etc.
4. Developing the scope of services sufficient to advertise for professional services. After the scope of services is completed and approved, the schedule and budget may be confirmed and/or updated by the engineer/project manager and approved by the appropriate district manager.
5. After consultant selection or in-house assignment, the designer or consultant should review and confirm the scope by completing steps one through four above.
6. The scope should anticipate and include the most cost effective methods that may be used in Subsurface Utility Engineering (SUE) for locating subsurface anomalies, structures, and utilities. Its use may affect the design process and should be considered in the scoping process. Selecting which methods to be employed should be accomplished by balancing risk versus benefit. Seldom will the use of only one method provide the most value. For example: Using radar tomography may have an initial higher cost but yield significantly more information much earlier in the design process which can facilitate drainage design, shorten the over all project time, reduce contractor risk, minimize redesign, and identify unknown facilities. Conversely, radar tomography has limited depth and resolution issues in a salt or high mineral environment, but other high technology methods exist and are worthy of consideration. The designer must recognize that SUE is a process that has many old and new technologies at its disposal. Consulting a SUE provider who can demonstrate state of the art knowledge will yield the most benefit.

13.4 Project Design Controls and Standards

Among the activities the Engineer of Record (EOR) will accomplish on a project are the identification of the given design controls and the selection of the appropriate design standards. These will be documented in the project file(s).

The design controls as addressed in this manual and AASHTO include such things as rights of way constraints, major utilities, design speed, design vehicle, design period, traffic volume and service level, functional classification of the corridor, the access class, and other factors that control the selection of project standards that will ensure the facility will function safely at the level desired and expected by the motorists.

Establishing the project standards is one of the first requirements of the engineering design process. The decisions, assumptions and calculations for the design are based on these factors. All project standards shall be documented in the project file(s).

The preliminary engineering report (PD&E) or concept report may include some of the controls and standards to be used on the project. These values should be reviewed, confirmed as valid and consistent with the overall corridor or system, and documented. Significant changes to approved PD&E elements of design may require a re-evaluation of the environmental document.

The Engineer of Record must coordinate with the District Design Engineer, the District Traffic Operations Engineer, and the responsible PD&E engineer to discuss the anticipated posted speed and determine the appropriate design speed for the project.

If project standards must be used that do not meet recommended values, these must be documented and receive approval/concurrence by the appropriate FDOT and/or FHWA engineer. These are either exceptions or variations as described in **Chapter 23** of this volume and must be maintained in the project file(s).

When all project standards are selected, documented, and agreed upon, the engineer should get the District Design Engineer to concur that the appropriate standards are being used. The Typical Section package will include some of the project standards. Those not included, and all known exception/variation justification shall be documented in the project file(s).

13.5 Support Services

Any information or support services that have been provided must be reviewed by the Engineer of Record to determine the completeness of the information. Conditions and data may have changed drastically if they are not current.

Technical data required for the design of a roadway project can be available from various sources, such as:

1. Surveys - design, topographical, aerial, drainage, right of way location, soil, utilities
2. Traffic Data
3. Pavement Design
4. Environmental Documents (including Noise Study Report)
5. Original Plans
6. Accident Data
7. Access Management Classification

During the design process, the project will require coordination with different sections or departments. When engineering decisions, information, or other support services are required from FDOT functional areas, it is the project manager's responsibility to coordinate and facilitate the request and expedite a timely response. The functional areas include but are not limited to:

- | | |
|---------------------------------|----------------------------------|
| 1. Planning and Programs | 11. FHWA |
| 2. Surveying and Mapping | 12. Value Engineering |
| 3. Traffic Plans | 13. Traffic Operations |
| 4. Geotechnical | 14. Environmental Mgmt. Office |
| 5. Drainage | 15. Access Management |
| 6. Maintenance | 16. Structures |
| 7. Construction | 17. Safety |
| 8. Utilities | 18. Plans Review |
| 9. Estimates and Specifications | 19. Public Transportation Office |
| 10. Right Of Way | 20. District Landscape Architect |

13.5.1 Aviation Office Coordination

If it is determined that an airspace obstruction exists (based on the criteria contained in **Table 2.10.5**), refer to **Table 13.5.1** for applicable FAA notification guidelines. For guidelines on airspace obstruction permitting, refer to **Chapter 333, Florida Statutes, "Airport Zoning"**, and **Chapter 14-60, Florida Administrative Code, "Airport Licensing and Airspace Protection"**.

While the responsibility for filing FAA notifications and permitting applications for FDOT Airspace Obstruction Permits or Variances to the local ordinance rests with the Engineer of Record, the FDOT Aviation Office is available to provide any requested technical assistance on planned projects that may impact the national airspace system in Florida. Please direct your request to the following:

FDOT Aviation Office
Airspace and Land Use Manager
605 Suwannee St., M.S. 46
Tallahassee, FL 32399-0450
Tel: (850) 414-4500
Fax: (850) 414-4508
Internet: <http://www.dot.state.fl.us/Aviation/>

Table 13.5.1 Construction of Airspace Obstructions - Notification

<p>FAA Notification</p> <p>Federal law, Title 14 Code of Federal Regulations (CFR), Federal Aviation Regulations (FAR), Part 77, "Objects Affecting Navigable Airspace", requires that prior notification must be given to the Federal Aviation Administration (FAA) regarding any construction or alteration of structures that meet specific criteria (See Table 2.10.5, this volume).</p> <p>If FAA notification is required, FAA Form 7460-1, "Notice of Proposed Construction or Alteration" is submitted to the FAA Southern Regional Office in Atlanta. This notification must be submitted at least 30 days before the earlier of the following dates:</p> <ol style="list-style-type: none">1. Date proposed construction or alteration is to begin.2. Date an application for a construction permit is to be filed.
<p>FAA Emergency Notification</p> <p>In the case of an emergency involving essential public services, public health, or public safety, that requires immediate construction or alteration, the 30-day advance notice requirement does not apply. In such a case, the required notification may be sent by telephone or any expeditious means to the nearest FAA Flight Service Station, and within 5 days thereafter, a completed copy of the FAA Form 7460-1, must be submitted to the FAA Southern Regional Office in Atlanta.</p>

13.5.2 Projects Involving Existing Bridges

Special coordination efforts are required of the Design Project Manager on projects that involve demolition, renovation, repair, repainting or replacement of any bridge.

13.5.2.1 Projects Involving Steel Bridges

For all projects that involve the repair, repainting or replacement of a steel bridge, the Design Project Manager shall contact the State Corrosion Engineer in the State Materials Office to determine if the bridge contains lead or other hazardous elements. The State Corrosion Engineer will furnish a site specific specification for disposition of the lead based paint waste for that particular project.

The Design Project Manager must provide the site specific specification to the Engineer of Record who is preparing the contract plans and specifications. The Engineer of Record must ensure that the project specifications conform to the site specific specifications and that they prohibit the use of lead based paint. A mandatory pre-bid conference is not required unless special conditions exist and the district determines one is needed.

The Design Project Manager shall notify the Contracts office (State or District) that the project requires the contractor to show proof of qualification before receipt of the bid proposal if 51% or more of the project is painting or at the time of award if less than 51% of the project is painting. The Contractor must have a QP2 Category A certification, from the Society for Protective Coatings (SSPC), for painting projects. For structure removal projects, consult with the Construction Office (State or District) to determine if QP2 Category A certification will be required, or a less stringent qualification. The contractor will be required to present proof of qualification prior to beginning any structure removal work and not at award. Qualifications for both painting and structure removal projects must be noted in the advertisement and specification.

13.5.2.2 Projects Involving Bridges with Asbestos Containing Materials

There may be asbestos containing materials used in bridges. For projects involving bridges that are to be either partially or fully demolished or renovated, the Project Manager must follow the Department Procedure on ***Asbestos on Bridges / Inspection, Abatement and Notification (Topic No. 625-020-020)*** which requires coordinating as early in the project as possible with the District Asbestos Coordinator for information on asbestos inspections, abatement and for notification requirements. Some bridge elements potentially containing asbestos include (but are not limited to) the following:

1. Tender House Roof Materials (felts, flashings, mastics, etc)
2. Tender House Floor Materials (tiles, sheet flooring, mastics, etc.)
3. Tender House Wall Materials (drywall muds, joint compounds, etc.)
4. Tender House Window Materials (caulks, gaskets, etc.)
5. Bridge Equipment Materials (gaskets, packings, linings, insulation, etc.)
6. MSE Wall Gaskets
7. Beam/Deck Bearing Pads
8. Asbestos-cement pipes (scuppers, etc.)
9. Bascule Bridge Machinery Brake Pads
10. Trowelled-on or Sprayed-on Decorative Coatings

13.5.2.3 Projects Involving Bridge Demolition

At or before the 30% plans phase, the Department shall determine if it has a need for the debris resulting from the demolition of a bridge. If no such need exists, and in response to **Section 1805, SAFETEA-LU Legislation**, the Department is then required to notify local, State and Federal government agencies of the availability of the bridge debris for their beneficial use (use as shore erosion control or stabilization, ecosystem restoration, and marine habitat restoration). For any projects that involve the complete demolition of a bridge, the Design Project Manager is required to notify these agencies of the availability of the resulting debris. The Bridge Development Report (BDR)/30% Structure Plans (see **Chapter 26**) will include the approximate volume of debris and the estimated timeframe in which the material will be available.

The Design Project Manager must coordinate with the receiving agency and the District Construction Engineer to develop a Joint Project Agreement. The receiving agency will be responsible for all additional costs associated with the processing, delivery, placement and use of the material. The following items must be determined in order for the Joint Project Agreement to be developed:

1. The volume of raw (unprocessed) debris (a more detailed quantity than original estimate).
2. The estimated timeframe for the debris availability.
3. The location of the receiving agency's staging/storage site to which the raw debris is to be delivered. Any further work involving processing and/or final placement of the material is expected to be the responsibility of the receiving agency and not part of the FDOT's contract for bridge demolition.
4. An estimated cost to transport the debris to that site. This estimate will be amount the receiving agency must pay the FDOT.

Once this information is determined, the contract plans will include the instructions for the delivery of the debris.

If no agency expresses interest in the debris material, then the material will be disposed of in accordance with FDOT Specifications.

Requirements for the original notification to agencies (including a sample Notification Letter) and the resulting Joint Project Agreement are found in the **Project Management Handbook, Part 2, Chapter 3**.

Section 13.5.2.2 contains additional requirements for projects involving bridge demolition.

13.5.3 Projects Involving Bridges Over Navigable Water

For projects involving bridges over navigable water, the Project Manager must provide the District Structures Maintenance Engineer (DSME) sufficient notification prior to engaging in any action in, on, or around the bridge(s). This includes any field reviews involving persons conducting activities that may be perceived as suspicious (i.e., parking on the bridge, repeated viewing from a boat or other vehicle, carrying cameras and other electronic equipment like a GPS, etc.) This will allow the DSME to notify the U.S. Coast Guard prior to such activities taking place.

13.5.4 Projects Affecting Interstate Logo Signs

On projects that may impact Interstate Logo Signs through any construction activities, any affected logo signs must be identified so that early coordination can take place and so those signs can be properly addressed in the plans. When the affected logo signs are identified, that information must be coordinated with the State Motorist Information Services Administrator, the District Traffic Operations Office, and Florida Logos, Inc. to determine the degree of impact, and the maintenance of the signs during construction. Through this coordination, the following questions must be answered:

1. Will the logo signs need to be removed during construction?
2. Can the logo signs be reinstalled after construction?
3. Can the logo signs be temporarily relocated out of the work zone during construction so the service will not be interrupted, and then permanently reinstalled after the work is complete?
4. If the logo signs cannot be temporarily relocated during construction, where can they be stored until they are reinstalled?

13.5.5 Buy America Provisions

The Buy America provisions, established in **CFR 635.410**, requires that on all Federal-aid highway construction projects, if steel or iron materials are to be used, all manufacturing processes for these materials, including application of a coating, must occur in the United States. Buy America requirements are covered in **FDOT Standard Specification Section 6-12.2**. **Section 6-12.2** identifies allowable levels of foreign steel or iron and contractor certification requirements.

While **Section 6-12.2** applies to contractors, designers also have a responsibility to insure Buy America provisions are met. When Buy America provisions are not met, the entire project is not eligible for Federal funds. The design engineer of record needs to do sufficient research to determine that any steel or iron called for in the plans is manufactured in the United States. This is necessary when the plans include the following:

1. Non-standard or special grade steel components and shapes.
2. New proprietary products containing steel or iron materials.
3. Sole source products containing steel or iron materials.
4. Special machinery with steel or iron components.
5. Heavy sections of steel sheet pile wall.

It is not necessary to conduct such research for the following:

1. Standard domestic steel beams and shapes of standard grades as shown on the National Steel Bridge Alliance (NSBA) website.
2. Standard concrete reinforcing steel sizes and grades.
3. Standard steel drainage pipe sizes and gages.
4. Items covered in the **Design Standards** including:
 - a. Standard mast arm assemblies.
 - b. Standard steel guardrail, posts, and end treatments.
 - c. Standard drainage grates.
 - d. Standard steel fences.
 - e. Standard steel sign supports and structures.

If it is determined that a steel or iron product being proposed is not manufactured in the United States, then the Designer shall determine if the estimated costs of such foreign steel

or iron is within the thresholds stated in the specification. If the costs exceed such threshold, the Designer shall explore alternatives that utilize domestic steel or iron, or seek a waiver from FHWA. Generally it is preferred to select a different engineering solution utilizing domestic products.

Should a waiver become necessary, it must be obtained BEFORE the contract letting to insure federal funding is not jeopardized. Buy America waiver requests shall be submitted to the Central Office for concurrence by the Directors of Design and Construction. Requests will then be forwarded to the FHWA Florida Division Office for approval and coordinated with the FHWA headquarters in Washington D.C. for further concurrence. Originals will be returned to the District by the Central Office. These issues must be identified early in the plans preparation process.

13.5.6 Traffic Monitoring Sites

One or more traffic monitoring sites should be considered for addition to each construction project which has a type of work consistent with the construction of such sites. Examples of compatible work types include traffic signals, resurfacing, reconstruction, and other work that involves either pavement surfaces or electrical systems. Inquiries about monitoring sites should be addressed to the Traffic Data Section Manager of the Transportation Statistics Section, Office of Planning.

13.6 Preliminary Geometry, Grades, and Cross Sections

To establish geometry, grades, and cross sections, the following activities should be accomplished or near completion:

1. Supporting data such as surveys, traffic and pavement evaluation data.
2. Typical sections and pavement design.
3. Standards, variations and exceptions.
4. PD&E and environmental commitments addressed and if necessary, re-evaluation.
5. Need for R/W phase addressed.
6. Utility initial contact and survey data.
7. Transit initial contact and facility location.

The initial engineering design activities to establish the preliminary project plans are:

1. Set and calculate the horizontal alignment.
2. Set the proposed profile grade lines.
3. Develop preliminary cross sections at selected intervals or control locations.
4. Develop preliminary layout of roadway, intersections, interchanges, transitions, and connections.
5. Field review all proposed preliminary engineering layout and decisions for conflicts, R/W needs, connections, updates and additional needs.

The initial engineering review (Phase I) is used to obtain confirmation and approval of the objectives, scope, standards, decisions, and assumptions to be used as the basis for the engineering and design. The Engineer now has the decisions and direction necessary to perform final engineering. If this is not the case, the necessary initial engineering activities must be accomplished before continuing to the final design process.

The results of the above activities should be that:

1. Structures can now be given the horizontal and vertical alignment and clearance requirements for bridges.
2. R/W Engineering can be furnished with mainline R/W requirements for the project.
3. Plan-profile sheets can be clipped.
4. Traffic plans development can be initiated.

5. Cross sections, grades and alignments, as required, can be provided to the drainage section.
6. Work sheets, as needed, can be provided to the permits section for initial evaluation.
7. Utility/Agency Owners (UAOs) can be provided plans, profiles and cross sections as required to identify/verify and designate their existing utilities as well as indicate proposed installations.
8. The TRNS*PORT pay item listing can be initiated by identifying the items of work involved at this point.
9. The need for sound barriers has been confirmed and locations established.

13.7 Distribution of Exempt Public Documents

It is the policy of the Department to protect the State Highway System's infrastructure from disclosure under Florida's public records law for documents concerning Department structures. This exemption is created by **Section 119.07(3)(ee), F.S.** and covered by Department Procedure "***Distribution of Exempt Public Documents Concerning Department Structures and Security System Plans (Topic No. 050-020-026).***"

Structure is defined in **Section 334.03(28), F.S.**, as "a bridge, viaduct, tunnel, causeway, approach, ferry slip, culvert, toll plaza, gate, or other similar facility used in connection with a transportation facility." This includes pipes and pipe systems. Therefore, those portions of Department plans that depict pipes, pipe systems, or the internal layout and structural elements of a structure owned or operated by the Department, are exempt from a public records request under **Section 119.07(3)(ee), F.S.** This applies to all formats (paper, electronic, etc.), and at any phase of completion (existing, draft, preliminary, phase reviews, or final).

Entities or persons outside the Department requesting or receiving copies of any portion of plans considered Exempt Documents will need to complete a request form (**Form No. 050-020-26**). The form also advises the requestor that the entity or person receiving the information shall maintain the confidential and exempt status of the information.

This procedure applies to both Department internal or contracted staff who produce such Exempt Documents in their Department work or have other methods of access to such Exempt Documents in the distribution to persons or entities outside of the Department. Refer to **Topic No. 050-020-026** for further requirements.

THIS PAGE LEFT BLANK INTENTIONALLY

Chapter 14

Final Engineering Design Process

14.1	General	14-1
14.2	Final Engineering Design	14-1
14.3	Contract Plans Preparation	14-3
14.4	Specifications	14-3
14.5	Pay Items and Summaries of Quantities	14-4
14.6	Assemble Contract Plans Package	14-4
Exhibits		
Exhibit 14-A	Major Activities – Final Engineering Design Process	14-ii

Exhibit 14-A Major Activities – Final Engineering Design Process

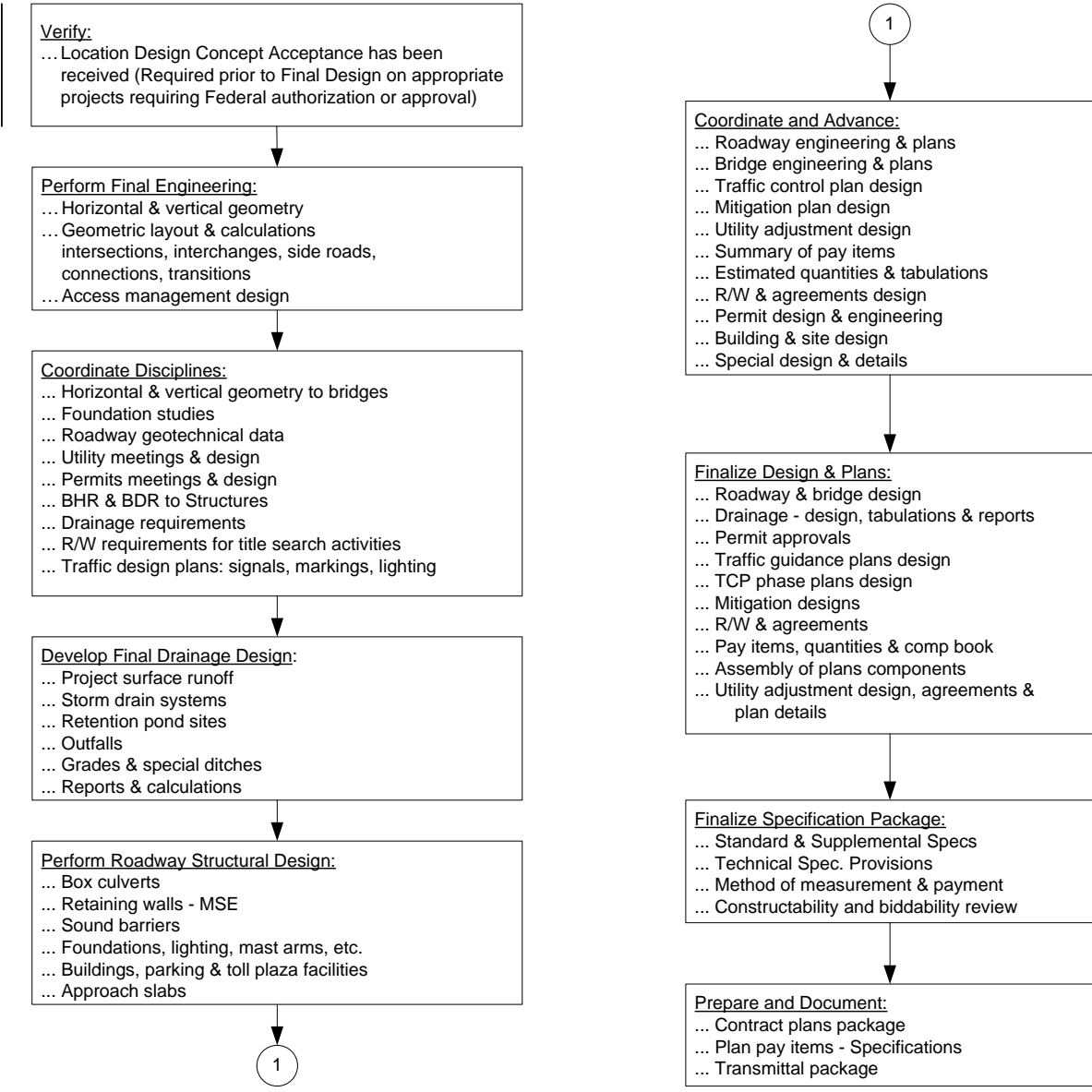

Chapter 14

Final Engineering Design Process

14.1 General

The final engineering design process follows the initial engineering design process and review (see **Chapters 13** and **16** of this volume). The final engineering design phase should be roughly 50% of the total effort. The primary objective of the final engineering design phase is to prepare contract plans and specifications that can be used to bid and construct the project with a minimum of field changes, delays, and cost overruns.

On projects requiring Federal authorization where the Design Phase and the PD&E Phase overlap, the Department must receive Location Design Concept Acceptance (LDCA), prior to acceptance of the Phase II submittal (prior to advancing into Final Design). The Design Project Manager must coordinate with the PD&E Project Manager, or the District Environmental Management Office to insure that that the Department has received LDCA for the project. The Project Manager will need to convey this information to the district federal aid staff in the District Work Program Office. (See the **Project Management Handbook, Part 2, Chapter 3** for further information).

14.2 Final Engineering Design

The Engineer and Project Manager must coordinate all activities to ensure that the quality, accuracy, and appropriate decisions go into the performance of each step. The project quality control should include a plan-do-check routine for each set of activities or operations.

The major design activities include, but are not limited to, the following:

1. Pavement design
2. Drainage design
3. Structural (bridge) design
4. Structural (roadway) design
5. Roadway design including access management, earthwork, geometrics, ADA, etc.
6. Traffic plans design including signing, marking, signals, lighting, etc.
7. Utility adjustment design
8. Permit preparation design including ponds, mitigation, etc.

9. Traffic control plans (work zone) design
10. R/W requirements design
11. Building and site design including landscaping, ADA, transit, etc.
12. Estimates and computation book preparation
13. Specifications and special provisions
14. Landscaping design
15. Sound barrier design

Project stationing information is to be checked and entered into the Work Program Administration (WPA) system during final engineering design. This information is important for tying construction records, such as material coring, sampling and testing to other databases. The information is entered by stations, which are related to roadway mile post for later information retrieval.

The project designer is responsible for finalizing the project stationing. The District Design Engineer should designate an individual to be responsible for coordinating the input of stationing information into the WPA system.

The begin/end stations and station equations are entered into the WP50 computer screen under FM on the FDOT CL/SUPERSESSSION Main Menu for each WPA location. After logging onto SUPERSESS, the WP50 designees enter on FM (Financial Management System). On the FM Main Menu, press ENTER: 3 for WPA (Work Program Administration). On WPA Main Menu, press ENTER: 25 for WP50 (Station Definition).

Update access to WP50 screen is granted through the Work Program Development Office in Tallahassee. Listed below are the important edit and browse features:

1. Only enter FM Item_Segment number on the top line.
2. The RDWYLOC sequence number displays on the top line of the screen and on the first line of the header information. It's entered on the top line to retrieve a particular location.
3. The transaction type "00" is entered on the top line to browse all station equation information for that RDWYLOC. The transaction type "02" is entered on the top line to update all station equation information for that RDWYLOC. The transaction type "99" is entered on the top line to erase all station equation information for that RDWYLOC.
4. Press the F8 key will forward from one RDWYLOC to the next RDWYLOC on the same Item_Segment number. Press ENTER key to update or delete data on the screen depending on the transaction type but will not page forward.
5. Press F3 key will take the user to the FM main menu while press F15 key will take the user back to the SUPERSESS main menu.

After entering the station information, it is important to check to see if the milepost limits in WPA are still accurate. This can be accomplished by reviewing the WP50 computer screen.

If the project length has changed, the District Work Program Office should be advised to correct the mileposts.

This information will become increasingly important as Geographic Information Systems increase in use and project locations are automatically mapped based on milepost limits.

14.3 Contract Plans Preparation

The outcomes of the engineering design activities are component sets of contract plans developed using CADD. The major component sets may include:

1. Roadway
2. Signing and Pavement Marking
3. Signalization
4. Intelligent Transportation Systems (ITS)
5. Lighting
6. Landscape
7. Architectural Plans
8. Structures Plans

Utility Joint Participation Agreement Plans have a separate Financial Project ID and are placed in the back of the contract plans set.

These component sets, the specifications package, and the TRNS*PORT pay item listing and quantities are assembled and packaged as the construction contract letting documents.

14.4 Specifications

The Engineer of Record must develop engineering designs that can be constructed, controlled, measured and paid for under the current **FDOT Specifications**. In the event the work required is not covered by the standard specifications or the supplements and special provisions thereto, the Engineer must develop Technical Special Provisions to be made part of the contract for this project. The Engineer can obtain Department procedural guidance to assist with the preparation.

14.5 Pay Items and Summaries of Quantities

As the engineering plans and specifications are prepared, the quantities are calculated, tabulated, and summarized by Pay Item (of work) as stipulated by specifications and the ***Basis of Estimates Manual***. The summary of pay items is updated as quantities are determined and summarized.

14.6 Assemble Contract Plans Package

The completed plans, specifications, and District estimate are transmitted to the central office for letting or they are assembled and held in the district for district advertisement and letting. ***Chapter 20*** of this volume provides further guidance on the contents of the transmittal.

Chapter 15

Update Engineering Design Process

15.1	General	15-1
15.2	Design Update Review and Decision Process	15-1
15.3	Updating Engineering Design and Documents	15-2
15.4	Revised Contract Plans Package.....	15-2
Exhibits		
Exhibit 15-A	Major Activities - Update Engineering Design Process	15-ii

Exhibit 15-A Major Activities - Update Engineering Design Process

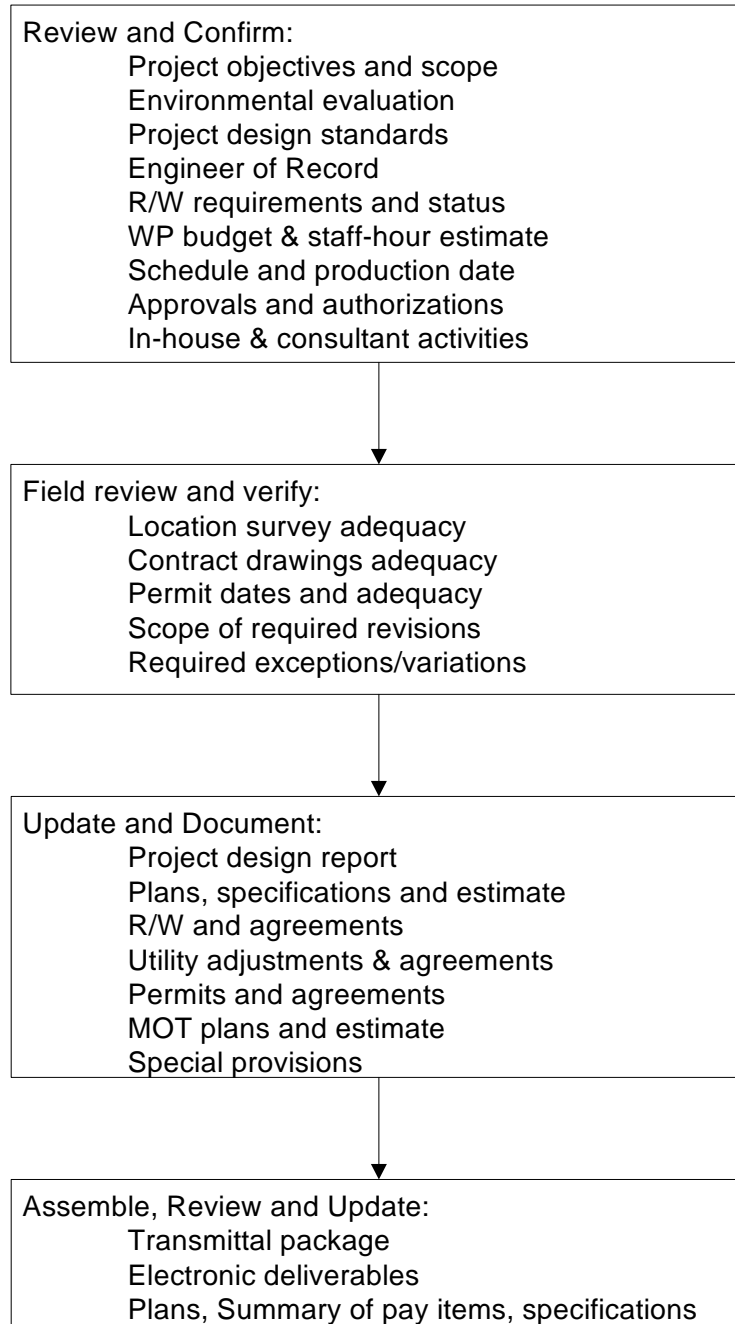

Chapter 15

Update Engineering Design Process

15.1 General

The update engineering design process begins when a final contract plans, specification and estimates (PS&E) package has been on the shelf for any significant period (approximately nine months). The update process depends on the type of project, the adequacy and appropriateness of the original design controls and standards, and the original scope and objectives. The extent of the update process should be determined based on both engineering and management input.

15.2 Design Update Review and Decision Process

An engineering review of the PS&E and proposed contract documents must be made to determine the activities required to update the package and get it ready for letting.

1. The original project objectives, scope and standards must be reviewed and compared with current corridor conditions, as well as growth rate and patterns, to determine if the project design is still valid.
2. Original environmental evaluations and commitments must be weighed against current requirements.
3. Permit date and terms must be weighed against current requirements.
4. R/W certifications and agreements must be reviewed and the status of documents confirmed.
5. Contract plans must be reviewed for current requirements, including standard indexes, specifications, pay items and design criteria.
6. Agreements with outside entities such as Utility/Agency Owners (UAOs), maintaining agencies and local agencies must be reviewed.
7. Design Exceptions and Variations must be resubmitted with updated documentation based on current data and conditions.

If the decision is that engineering updates are required, the scope, staff-hour estimate, schedule, cost estimate, and other activities described in **Chapter 13** of this volume should be followed to the extent necessary to define the scope and schedule for the update process.

15.3 Updating Engineering Design and Documents

The actual engineering design activities necessary to update the plans package will vary from project to project. They must be fully described in the professional services contract, if one is to be used. If done in-house, a fully defined scope of work must be developed to determine resources and schedule needed for the update.

All reports, calculations, assumptions, and engineering decisions that support the changes to plans, specifications, or other documents must be signed and sealed by the Engineer updating the engineering plans, specifications and documents. All changes to the plans must be approved by the responsible engineer in charge of the work and receive the concurrence of the District Design Engineer, Structures Design Engineer, or Consultant Project Management Engineer, as appropriate for the type of change. Updated documentation of all approvals and concurrences shall be in the project file.

15.4 Revised Contract Plans Package

In addition to the required engineering changes, which may be necessary, the contract transmittal package must be reviewed and updated to current status.

1. All component plans sets are made current and sealed.
2. Specifications and special provisions are made current.
3. The CADD electronic files are revised.
4. The computation book and pay item summaries are made current.
5. The contract file is made current.

Chapter 16

Design Submittals

16.1	General	16-1
16.2	Design Documentation Submittals	16-4
16.2.1	Field Survey Data	16-4
16.2.2	Project Traffic.....	16-5
16.2.3	Typical Section Package.....	16-6
16.2.4	Preliminary Drainage Design	16-10
16.2.5	Preliminary Geometry and Grades.....	16-10
16.2.6	Preliminary Traffic Control Plan	16-11
16.2.7	Pavement Selection and Design.....	16-11
16.2.8	Preliminary Utilities	16-11
16.3	Structures Submittals	16-12
16.3.1	Coordination of Structural Design - (Bridges and Retaining Walls)	16-12
16.3.2	Bridges.....	16-12
16.3.3	Other Structural Submittals and Reviews	16-13
16.4	Plans Phase Reviews	16-14
Exhibits		
Exhibit 16-A	List of Requests and Contacts	16-2
Exhibit 16-B	Typical Section Package.....	16-15

THIS PAGE LEFT BLANK INTENTIONALLY

Chapter 16

Design Submittals

16.1 General

The design process will require various submittals to transfer technical information and decisions between the Engineer of Record (EOR), certain Department personnel, and functional areas. The Project Manager is responsible for the adequacy of the submittals or requests and for the coordination of reviews between the Department and the EOR. Each office head including the District Construction and Maintenance Engineers should assume direct responsibility for assigning reviewers and meeting the review schedules. To the extent practical, the contract scope of work should list the information to be furnished by FDOT functional areas and submittals (number and type) required of the EOR. **Exhibit 16-A** is a partial list of functional areas with typical submittals and requests.

During the design process, various items of information may be required from different sections or departments. The following is a list of some of those items and their source:

Exhibit 16-A List of Requests and Contacts Sheet 1 of 2

A) Planning

Request pavement design (18 Kip ESAL)
Request project traffic
Request turning movements for intersections
Request updates of project traffic (as needed)
Railroad contact (Phase I and III)
Plans transmittal letter data (railroad)
Notification that project is in vicinity of a traffic monitoring site

B) Traffic Plans/Traffic Operations

Request turns and counts for intersection design
Notification that project includes milling
Signing & pavement marking plans (Phase I, II, III)
Traffic signal plans (Phase I, II, III) & signal warrant
Lighting plans (Phase I, II) & justification report
Pedestrian and bicycle project traffic
Safety/crash analysis and recommendations
Operational and capacity review of design plans

C) Geotechnical

Request pavement design soil information
Request roadway soil survey
Soils data
Request foundation investigations
Request dynaflect testing
Phase III review, if unsuitable soils exist.
Soils and foundation recommendations
PH and soils resistivity for culvert material selection
Request pavement composition and milling recommendations
Review if any changes are made in alignment, grade or typical section.
Bridge Geotechnical Report

D) Surveying and Mapping

Request survey

E) Drainage

Request grade and high water review
Conceptual drainage plan & assumptions
Bridge Hydraulics Report
Request drainage design
Request final drainage review
Permit review
SWPPP
Erosion Control Plan

F) Maintenance

Pavement design comments
Phase I Plans review & response
Phase II Plans review & response
Phase III Plans review & response

G) Construction

Pavement design comments
Phase I Plans review & response
Phase II Plans review (constructability) & response
Phase III Plans review (biddability) & response
Submit traffic control plan request
Contract time

H) R/W Surveying and Mapping

Submit title search request
Request existing right of way maps
Transmit right of way requirements
Final right of way check
Plans transmittal letter data

I) Utilities

Preliminary (First) contact (Phase I)
Pre-Design conference and contact (Phase II)
Final contact (Phase III)
Horizontal and vertical verification of utilities
Plans transmittal letter data (utilities)
Number of sets of final prints for utility companies

Exhibit 16-A List of Requests and Contacts Sheet 2 of 2

J) Estimates and Specifications

Preliminary estimate (LRE)
Preliminary estimate (Phase I)
Preliminary estimate (Phase II)
Preliminary estimate (Phase III)
Complete estimate (Phase IV)

K) Right Of Way Department

Project schedule updates as needed
R/W estimates as needed
Pre-Proposal appraisal conference
Field questions from R/W agents as needed
Plans transmittal letter data
Phase I Plans Review (by Appraiser)
Phase II Plans Review (by Appraiser)
Phase III Plans Review (by Appraiser)
Phase IV Plans Review (by Appraiser)

L) FHWA (if not exempt)

Phase I Plans review & response
Phase II Plans review & response
Phase III Plans review & response
Phase IV Plans review & response
Submit for typical section approval
Submit for pavement design approval
Submit exception request letters
R/W review

M) Value Engineering (\$2,000,000+)

Phase I & II reviews

N) Environmental

Hazardous waste determination
SWPPP
Erosion Control Plan
Mitigation Plans

O) Materials

Environmental Classifications
Type of Structural Steel (existing)
Existence of Lead-Based Paint

P) Bridge

Phase I, Bridge Analysis, review & response
Phase II Plans review & response
BDR/30% Plans review and response
60% Plans review & response
90% Plans review & response
100% Plans review & response

Q) Public Transportation/Modal Development

Notification that project contains a transit route
Request transit agency contact(s)
Request facility locations and information
Identify any special transit needs
Phase I Plans review & response
Phase II Plans review & response
Phase III Plans review & response
Number of sets of final prints for transit agencies

16.2 Design Documentation Submittals

During the engineering processes there is the need to submit information to specific Department personnel for the purpose of making timely decisions and confirming the project objectives. Preferably these submittals will take place as these activities are completed so that issues do not go unresolved before subsequent activities begin. The following are some submittals that should take place during initial engineering. Ideally these engineering type submittals should be done in lieu of traditional phase plans reviews.

16.2.1 Field Survey Data

The following are typical field survey data, which should be evaluated by the designer for sufficient breadth and accuracy to complete the proposed design.

1. Design location survey data including horizontal and vertical control, alignments, reference points, utilities, natural and manmade features, and topography or general shape of the terrain.
2. Digitized aerial survey data, especially for large areas such as drainage maps.
3. Drainage design survey data from site inspection and historical records.
4. Right of Way and related property (land) survey data, including property owners and acreage.
5. Geotechnical studies and foundation and soils report, including physical properties and classifications of soils, together with recommendations related to foundations, pavement and drainage design.
6. Bridge data sheet surveys, channel alignment survey data and bathymetric data.

16.2.2 Project Traffic

In the development of roadway plans, project traffic is primarily used to justify the number of through lanes, geometric improvements to intersections, traffic signal timings, and pavement design. The number of through lanes is usually determined during the project development phase, based on Annual Average Daily Traffic (AADT) and factors included in the typical section. Vehicular traffic data provided in the plans typical section includes AADT for the current year, opening year and the design year. Also included are the design hour factor (K is the proportion of AADT occurring during the 30th highest hour of the year), the directional distribution (D is the percent of two way peak hour traffic that occurs in the peak direction), and truck factors (T is the percent that trucks constitute of vehicular traffic) for the peak hour and a 24 hour period. The source and methods used to produce this data must be documented.

Intersection improvements and signal timings require additional information on turning volumes. The ***FDOT Project Traffic Forecasting Procedure*** describes the input data required, explains the procedure to forecast turning volumes, and provides examples. A Project Traffic Report may be required. Manual and mechanical counts provide input on the number of vehicles and pedestrians using an intersection. At proposed (nonexisting) major intersections, turning volumes are estimated using transportation planning models or other means. Forecasts provide designers the information required to determine the need for turning lanes, turning bay length, signal timings, and pedestrian crossings. Also, the designer establishes right of way requirements based on documented needs to satisfy design year volumes.

In pavement design, the designer requires AADT forecasts for the year a project opens to traffic and for the design year. AADT, together with percent trucks (24 hour period) and other factors used by the Department, provides information on the pavement loadings used in pavement design. The ***FDOT Project Traffic Forecasting Procedure*** provides additional information.

16.2.3 Typical Section Package

All projects that add or alter cross section elements, and all resurfacing projects, require the preparation and concurrence of a typical section package.

The typical section package shall be prepared and sealed by the responsible engineer.

The typical section package is the instrument for formal review and concurrence of the proposed project cross sectional elements by the appropriate FDOT District Design Engineer. Review and concurrence of the typical section package by the FHWA Transportation Engineer is required on projects that have FHWA oversight (see **Chapter 24** of this volume for determination of FHWA oversight).

The purpose of the typical section package review and approval process is to:

1. Establish typical transverse geometry
2. Consider safety related issues
3. Ensure compatibility between the bridge typical section and the roadway typical section

The typical section package consists of a Project Controls Sheet and Project Identification/ Proposed Typical Section Sheet. The Project Identification/ Proposed Typical Section Sheet should not be confused with the Typical Section Plan Sheet, which is part of the Contract Plans Set and is discussed in **Volume 2, Chapter 6**. The Project Controls Sheet contains the project data, which serves as a basis for selecting criteria and establishing project standards for cross-sectional elements. The Project Identification/Proposed Typical Section Sheet contains: data which uniquely identifies the project; a detail of the proposed typical cross section with critical dimensions and cross sectional elements labeled; and signature blocks.

Usually, Project Identification/ Proposed Typical Section Sheets will be prepared for the main roadway and bridges. However, additional Project Identification/Proposed Typical Section Sheets:

1. **Shall** be required if:
 - a. A change in the number of through lanes occurs.
 - b. Flush shoulders change to curbing or vice versa.
 - c. A crossroad which may affect a structure exists.
 - d. Major work of significant length is being done on an intersecting roadway.
2. **May** be required if a change in design speed occurs within the project limits.

The proposed typical sections for roadway and bridges are to be submitted by the responsible engineer for concurrence by the District Design Engineer. Coordination with the District Structures Design Engineer is also required on all bridge typical sections. The roadway and bridge typical sections shall be submitted together to ensure compatibility.

The typical section package for both roadway and bridges shall be approved as part of the Project Development & Environmental (PD&E) process. Typical section package preparation, and coordination between the responsible PD&E engineer and the District Design Engineer, must occur during the development of project alternatives prior to preferred alternative selection. The responsible PD&E engineer shall prepare, seal and submit the typical section package for concurrence. Typical section package concurrence by the District Design Engineer shall be obtained after the preferred alternative is selected. A copy of the approved typical section package shall be included as part of the PD&E Final Preliminary Engineering Report.

For projects that do not contain a PD&E phase, the typical section package shall be prepared, sealed and submitted by the responsible engineer for concurrence by the District Design Engineer. The typical section package should be concurred with prior to the final engineering process.

The Engineer of Record must coordinate with the District Design Engineer, the District Traffic Operations Engineer, and the responsible PD&E engineer to discuss the anticipated posted speed. The selected design speed shall be jointly approved by the District Design Engineer and the District Traffic Operations Engineer. This joint approval shall be documented on the Typical Section Data Sheet (see **Exhibit 16-B, Sheet 1 of 6**).

Exhibit 16-B contains example typical section package sheets. The following is an outline of the information which is required as part of the typical section package submittal. This information is critical for proper evaluation by the District Design Engineer. Missing information may require a resubmittal of the typical section package.

The following information is required on the project controls sheet:

1. Financial Project ID
2. County (and Section)
3. Project Description
4. Functional Classification
5. Highway System
6. Access Classification

7. Traffic Data (AADT, for Current, Opening and Design Year, Design Speed, Posted Speed; K, D, and T Factors)
8. Potential Exceptions and Variations related to the typical section elements
9. List Major Structures Requiring Independent Structures Design (including location and description)
10. List Major Utilities within project corridor
11. List other information pertinent to the design of the project

The following information is required on the project identification/proposed typical section sheet:

Project Identification:

1. Financial Project ID
2. State Project No. (if assigned)
3. Federal Aid Project No. (if assigned)
4. Work Program Item (if assigned)
5. Road Designation
6. County Name (and Section)
7. Limits (In Milepost)
8. Project Description

Proposed Roadway Typical Section Drawing:

1. Design Speed
2. Limits (station limits of the typical section shown if available)
3. Lanes (dimension width, show cross slope of each lane, label bike and HOV lanes)
4. R/W Line (graphically show, label and dimension from centerline const.)
5. Shoulder (dimension width, show cross slope, paved shoulder is dimensioned and labeled separately)
6. Curb (graphically show curb, label curb type)
7. Median (dimension width, show slopes, graphically show whether median is typically depressed or raised)
8. Centerline Construction and/or Baseline Survey (graphically show and label)
9. Profile Grade Point (label)

10. Slopes (dimension and label)
11. Border Width (dimension and label for new construction)
12. Ditches (show typical front slope and typical back slope, dimension typical ditch width and depth, and label)
13. Natural Ground Line (graphically show and label)
14. Pavement and Roadbed (graphically show)
15. Barriers (graphically show, dimension, and label)
16. Sidewalk (graphically show, dimension, and label)

Proposed Structure Typical Section Drawing:

1. Design Speed
2. Bridge Description w/ Crossing Information
3. Lanes (dimension widths, and show cross slope of each lane, label bike or HOV lanes)
4. R/W Line (graphically show, label and dimension from centerline const.)
5. Shoulder (dimension, show cross slope, and label)
6. Gutter (dimension width, and graphically show)
7. Median (dimension width, show slopes, graphically show whether median is typically depressed or raised)
8. Centerline Construction and/or Baseline Survey (graphically show and label)
9. Bridge Deck (graphically show, dimension)
10. Profile Grade Point (label)
11. Barriers (graphically show including railing, dimension width, and label)
12. Sidewalk (graphically show, dimension width, and label)

The typical section package sheets are in the FDOT Engineering CADD Systems Software.

16.2.4 Preliminary Drainage Design

On projects where the drainage design is a critical element the following items should require a preliminary submittal:

1. Determination of water elevations affecting the roadway grade. These include base clearance water elevations and design flood elevations.
2. Pond Siting Report
3. Documentation of preliminary drainage coordination with permitting agencies
4. Information that is essential to proper evaluation of drainage design concepts such as seasonal high ground water, soil types, existing cross drain peak design stages, historical pavement failure, flood plain elevation, present water elevations, drainage areas, etc.

16.2.5 Preliminary Geometry and Grades

On projects where connections to the facility make grades a critical element, back of sidewalk profiles, project profile grades, determination of water elevations affecting the roadway grade, and driveway and side street geometry should require a preliminary submittal. The Districts may require the designer to present the project geometry and grade to a geometry and grade technical review team to encourage productive dialogue and proper communication regarding these design issues. If a bridge exists within the project limits, the early input of the structural designer as to approach grades and clearance needs should be coordinated to ensure proper bridge design.

16.2.6 Preliminary Traffic Control Plan

On projects where the traffic control plan is a critical element the following items should require a preliminary submittal.

1. Typical sections of each construction phase with information that is essential to proper evaluation of each construction phase such as: location and nature of proper construction drainage; regulatory speed; location of work zone; proposed traffic control devices; number, width and location of maintained traffic; maximum drop-off; maintenance of existing lighting.
2. Documentation addressing possible innovative construction techniques; need for temporary detours, hazardous material excavation, temporary structures, etc.
3. Documentation of coordination with the local community: i.e., city and county transportation engineers, businesses, police, hospitals, civic centers or arena operations, fire department, schools, mass transit, etc.

16.2.7 Pavement Selection and Design

The pavement selection and design should be completed as early in the process as possible. The ***Rigid*** and ***Flexible Pavement Design Manuals*** are available through the Maps and Publications Sales Office.

16.2.8 Preliminary Utilities

On projects where utility coordination is a critical element the following early involvement activities should be required.

1. Before Phase I plans submittal, early involvement can be obtained by coordinating a review of the utility information in the topographic survey. This review may be accomplished by distribution of the topographic survey to all Utility/Agency Owners (UAOs) through the District Utility Office for mark-ups and confirmation of existing facilities.
2. Once the designer has reviewed the early topographic survey mark-ups a meeting should be held with the UAOs, District Utility Office and the designer to discuss errors, omissions, and future plans of the utilities already identified within the corridor. This will allow the designer the ability to prioritize which utilities will ultimately impact the design.

16.3 Structures Submittals

Structures design elements also go through decision-making reviews at various stages of the design as listed below:

16.3.1 Coordination of Structural Design - (Bridges and Retaining Walls)

All requests for structural design should include roadway plan and profile sheets showing horizontal and vertical alignment and cross sections within 500 feet of each end of the bridge or ends of retaining walls. Horizontal curvature that is on or near the end of the bridge or retaining wall must be shown. Nonstandard superelevation transition details or other special profiles must be included if any part or all of the transition is on the bridge or wall. The approved typical section is required.

Provisions for access to property near the end of bridges and adjustments to avoid costly right of way takings should be resolved.

16.3.2 Bridges

Bridge design begins when the Phase I bridge geotechnical report is complete and proceeds on a schedule which allows simultaneous review of the final (90%) bridge plans and the Phase III roadway plans. All structures design work is coordinated through the District Structures Design Engineer or the State Structures Design Office in the Central Office, depending on the category or complexity of the structure. A typical section of the facility crossing, horizontal and vertical clearances required and the profile grades shall be determined prior to beginning structures design. For complete details and requirements for structural designs and plans preparation, the reader is referred to **Chapter 26** of this volume and the **Structures Detailing Manual** issued by the State Structures Design Office.

Generally, the completion and review of bridge designs are accomplished in the following phases:

1. BDR/30% Structures Plans
2. 60% Structures Plans
 - a. (Foundation submittal for all Structures and full)
 - b. (Submittal for Category 2 or unusual structures only)

3. 90% Structures Plans
4. 100% Structures Plans

These reviews should be coordinated with the phase reviews of the roadway plans. The latest set of structural plans shall be submitted with the Phase II roadway plans submittal. This joint submittal at Phase II roadway plans review is to ensure that roadway and bridge structures plans are consistent, i.e., widths, superelevation transitions, vertical and horizontal alignment, and work zone traffic control agree. The precise number and type of plans submittals depends on the complexity of the design and/or the sensitivity of the project. Each submittal shall include written responses to the comments received on the previous submittal.

16.3.3 Other Structural Submittals and Reviews

In addition to bridge plans, structures plans may include retaining walls, sheet piling, sound barriers, box or three-sided culverts, pedestrian overpasses, temporary bridges, and special structural appurtenances. Special structural appurtenances that include transit related furnishings and amenities would require review by the local transit agency.

For projects where bridges and other structures plans are involved, preliminary and final plan submittals (usually along with bridge plans) should be handled according to the instructions for structures plans submittals covered in **Chapters 26** and **30** of this volume.

For projects where retaining walls are required along with roadway plans only (no bridge in the project), the Engineer of Record shall follow the procedure outlined in **Chapter 30** of this volume. The submittal of detailed control plans should occur as early in the design process as possible.

Where the District Roadway Office cannot carry out the structural review or verify the review as proper by a consultant, such review may be requested from the District Structures Design Office or the State Structures Design Office.

16.4 Plans Phase Reviews

The number of submittals and phase reviews shall be determined on a project-by-project basis and shall be defined in the scope. Submittals allow functional areas to review the development of the project as contained in the scope.

Formal plans phase review requirements are covered in the District Quality Control Plan. Reviews should include Department personnel that can assist in making timely decisions and confirm that the requirements have been met for their discipline. Ideally, reviews should be driven by the engineering process and should occur when there is a need for input or a decision to complete a critical activity before progressing with the design. Some of these activities are discussed in **Section 16.2** of this chapter. Reviews are complete when the comments from all the various offices have been resolved and have been documented as required in **Chapter 24** of this volume.

Constructability and biddability reviews by the District Construction Office shall be included at appropriate stages of the phase review process. Procedures for these reviews are provided in the **Construction Project Administration Manual (Topic No. 700-000-000)**.

Minor projects, such as resurfacing, should typically have two plans phase reviews. The two reviews should consist of a decision-making phase review on the scope and intent of the project and a final plans phase review for constructability/biddability. One of these will be an on-site review.

On complex projects plans phase reviews may be required at the Phase I, II and III stages and a final check at Phase IV. Two on-site reviews will be required. Generally, one of the site reviews is held early in the initial engineering phase.

Section 2.3 of **Volume 2** outlines, in detail, the sequence for contract plans preparation and assembly required by the several design phase submittals. Also included in the chapter is information required to be presented on various plan sheets included with each submittal.

When the plans are in compliance with all phase review requirements and are considered final, they are to be submitted in accordance with the process described in **Chapter 20** of this volume.

**Exhibit 16-B Typical Section Package
 Sheet 1 of 6**

PROJECT IDENTIFICATION																																					
FINANCIAL PROJECT ID _____ COUNTY (SECTION) _____																																					
PROJECT DESCRIPTION _____																																					
PROJECT CONTROLS																																					
<p align="center"><u>FUNCTIONAL CLASSIFICATION</u></p> <p align="center"> <input type="checkbox"/> RURAL <input type="checkbox"/> URBAN <input type="checkbox"/> FREEWAY/EXPWY. <input type="checkbox"/> MAJOR COLL. <input type="checkbox"/> PRINCIPAL ART. <input type="checkbox"/> MINOR COLL. <input type="checkbox"/> MINOR ART. <input type="checkbox"/> LOCAL </p>	<p align="center"><u>HIGHWAY SYSTEM</u></p> <p>Yes No</p> <p><input type="checkbox"/> <input type="checkbox"/> NATIONAL HIGHWAY SYSTEM</p> <p><input type="checkbox"/> <input type="checkbox"/> FLORIDA INTRASTATE HIGHWAY SYSTEM</p> <p><input type="checkbox"/> <input type="checkbox"/> STRATEGIC INTERMODAL SYSTEM</p> <p><input type="checkbox"/> <input type="checkbox"/> STATE HIGHWAY SYSTEM</p> <p><input type="checkbox"/> <input type="checkbox"/> OFF STATE HIGHWAY SYSTEM</p>																																				
<p align="center"><u>ACCESS CLASSIFICATION</u></p> <p> <input type="checkbox"/> 1 - FREEWAY <input type="checkbox"/> 2 - RESTRICTIVE w/Service Roads <input type="checkbox"/> 3 - RESTRICTIVE w/660 ft. Connection Spacing <input type="checkbox"/> 4 - NON-RESTRICTIVE w/2640 ft. Signal Spacing <input type="checkbox"/> 5 - RESTRICTIVE w/440 ft. Connection Spacing <input type="checkbox"/> 6 - NON-RESTRICTIVE w/1320 ft. Signal Spacing <input type="checkbox"/> 7 - BOTH MEDIAN TYPES </p>	<p align="center"><u>TRAFFIC</u></p> <table style="width: 100%; border-collapse: collapse;"> <thead> <tr> <th></th> <th style="text-align: center;">YEAR</th> <th style="text-align: center;">AADT</th> <th colspan="2"></th> </tr> </thead> <tbody> <tr> <td>CURRENT</td> <td style="text-align: center;">_____</td> <td style="text-align: center;">_____</td> <td colspan="2"></td> </tr> <tr> <td>OPENING</td> <td style="text-align: center;">_____</td> <td style="text-align: center;">_____</td> <td colspan="2"></td> </tr> <tr> <td>DESIGN</td> <td style="text-align: center;">_____</td> <td style="text-align: center;">_____</td> <td colspan="2"></td> </tr> </tbody> </table> <p align="right"><u>DISTRIBUTION</u></p> <table style="width: 100%; border-collapse: collapse;"> <tbody> <tr> <td>DESIGN SPEED</td> <td style="text-align: center;">_____</td> <td style="text-align: center;">K</td> <td style="text-align: center;">%</td> </tr> <tr> <td>POSTED SPEED</td> <td style="text-align: center;">_____</td> <td style="text-align: center;">D</td> <td style="text-align: center;">%</td> </tr> <tr> <td></td> <td></td> <td style="text-align: center;">T₂₄</td> <td style="text-align: center;">%</td> </tr> </tbody> </table> <p align="center">DESIGN SPEED APPROVALS</p> <table style="width: 100%; border-collapse: collapse;"> <tbody> <tr> <td style="width: 70%; border-top: 1px solid black;">DISTRICT DESIGN ENGINEER</td> <td style="width: 30%; border-top: 1px solid black;">DATE</td> </tr> <tr> <td style="border-top: 1px solid black;">DISTRICT TRAFFIC OPERATIONS ENGINEER</td> <td style="border-top: 1px solid black;">DATE</td> </tr> </tbody> </table>		YEAR	AADT			CURRENT	_____	_____			OPENING	_____	_____			DESIGN	_____	_____			DESIGN SPEED	_____	K	%	POSTED SPEED	_____	D	%			T ₂₄	%	DISTRICT DESIGN ENGINEER	DATE	DISTRICT TRAFFIC OPERATIONS ENGINEER	DATE
	YEAR	AADT																																			
CURRENT	_____	_____																																			
OPENING	_____	_____																																			
DESIGN	_____	_____																																			
DESIGN SPEED	_____	K	%																																		
POSTED SPEED	_____	D	%																																		
		T ₂₄	%																																		
DISTRICT DESIGN ENGINEER	DATE																																				
DISTRICT TRAFFIC OPERATIONS ENGINEER	DATE																																				
<p align="center"><u>CRITERIA</u></p> <p> <input type="checkbox"/> NEW CONSTRUCTION / RECONSTRUCTION <input type="checkbox"/> RRR INTERSTATE / FREEWAY <input type="checkbox"/> RRR NON-INTERSTATE / FREEWAY <input type="checkbox"/> TDLC / NEW CONSTRUCTION / RECONSTRUCTION <input type="checkbox"/> TDLC / RRR <input type="checkbox"/> MANUAL OF UNIFORM MINIMUM STANDARDS (FLORIDA GREENBOOK) (OFF-STATE HIGHWAY SYSTEM ONLY) </p>																																					
LIST ANY POTENTIAL EXCEPTIONS AND VARIATIONS RELATED TO TYPICAL SECTION ELEMENTS:																																					
LIST MAJOR STRUCTURES LOCATION/DESCRIPTION - REQUIRING INDEPENDENT STRUCTURE DESIGN:																																					
LIST MAJOR UTILITIES WITHIN PROJECT CORRIDOR:																																					
LIST OTHER INFORMATION PERTINENT TO DESIGN OF PROJECT:																																					

Exhibit 16-B, Sheet 2 of 6

<p>PROJECT IDENTIFICATION</p> <p>FINANCIAL PROJECT ID <u>000002-1-32-01</u> FEDERAL AID PROJECT NO. <u>FEDERAL FUNDS</u> COUNTY NAME <u>HILLSBOROUGH</u></p> <p>SECTION NO. <u>12345</u> ROAD DESIGNATION <u>SR 99</u> LIMITS/MILEPOST <u>(MP 7.381 TO MP 10.535)</u></p> <p>PROJECT DESCRIPTION <u>MULTILANE RECONSTRUCTION OF SR 99 FROM CR 239 (CALHOUN BLVD.) TO I-10</u></p>	
<p>PROPOSED ROADWAY TYPICAL SECTION</p> <p>The diagram illustrates a proposed roadway typical section with two configurations. The left configuration (for STA. 250+38.00 TO STA. 416+91.12) features a 12' R/W LINE, a 12' BORDER, a 28' R/W Varies (5' Min.), a 24' lane width, a 4' BIKE LANE, a 12' LANE, a PROFILE GRADE POINT, a 5' S/W, a 0.02 slope, and CURB & GUTTER TYPE F. The right configuration (for STA. 416+91.12 TO STA. 416+91.12) features a 12' R/W LINE, a 12' BORDER, a 28' R/W Varies (5' Min.), a 22' lane width, an 8'-9" BIKE LANE, a 12' LANE, a PROFILE GRADE POINT, a 5' S/W, a 0.04 slope, and CURB & GUTTER TYPE E. A design speed of 45 mph is noted. Natural ground is indicated on the left side of the roadway.</p> <p>DESIGN SPEED = 45 mph STA. 250+38.00 TO STA. 416+91.12</p>	
<p>APPROVED BY: (Engineer of Record Printed Name)</p> <p>_____ Engineer of Record Signature and Date</p>	<p style="text-align: center;">FDOT CONCURRENCE</p> <p>_____ Signature Block Printed Name FDOT District Design Engineer</p> <p style="text-align: center;">FHWA CONCURRENCE</p> <p>_____ Signature Block Printed Name FHWA Transportation Engineer</p> <p style="text-align: center;">Date</p>

Exhibit 16-B, Sheet 3 of 6

PROJECT IDENTIFICATION		
FINANCIAL PROJECT ID _____ FEDERAL AID PROJECT NO. _____ FEDERAL FUNDS _____ COUNTY NAME _____ HILLSBOROUGH SECTION NO. _____ ROAD DESIGNATION _____ SR 99 _____ LIMITS/MILEPOST _____ (MP 7.381 TO MP 10.535) PROJECT DESCRIPTION _____ MULTILANE RECONSTRUCTION OF SR 99 FROM CR 239 (CALHOUN BLVD.) TO I-10 _____		
PROPOSED STRUCTURE TYPICAL SECTION		
DESIGN SPEED = 50 mph SR 99 BRIDGE OVER TUCKER CANAL		
APPROVED BY: (Engineer of Record Printed Name)	FDOT CONCURRENCE	FHWA CONCURRENCE
Engineer of Record Signature and Date	Signature Block Printed Name FDOT District Design Engineer	Signature Block Printed Name FHWA Transportation Engineer
_____ _____	_____ _____	_____ _____

Exhibit 16-B, Sheet 4 of 6

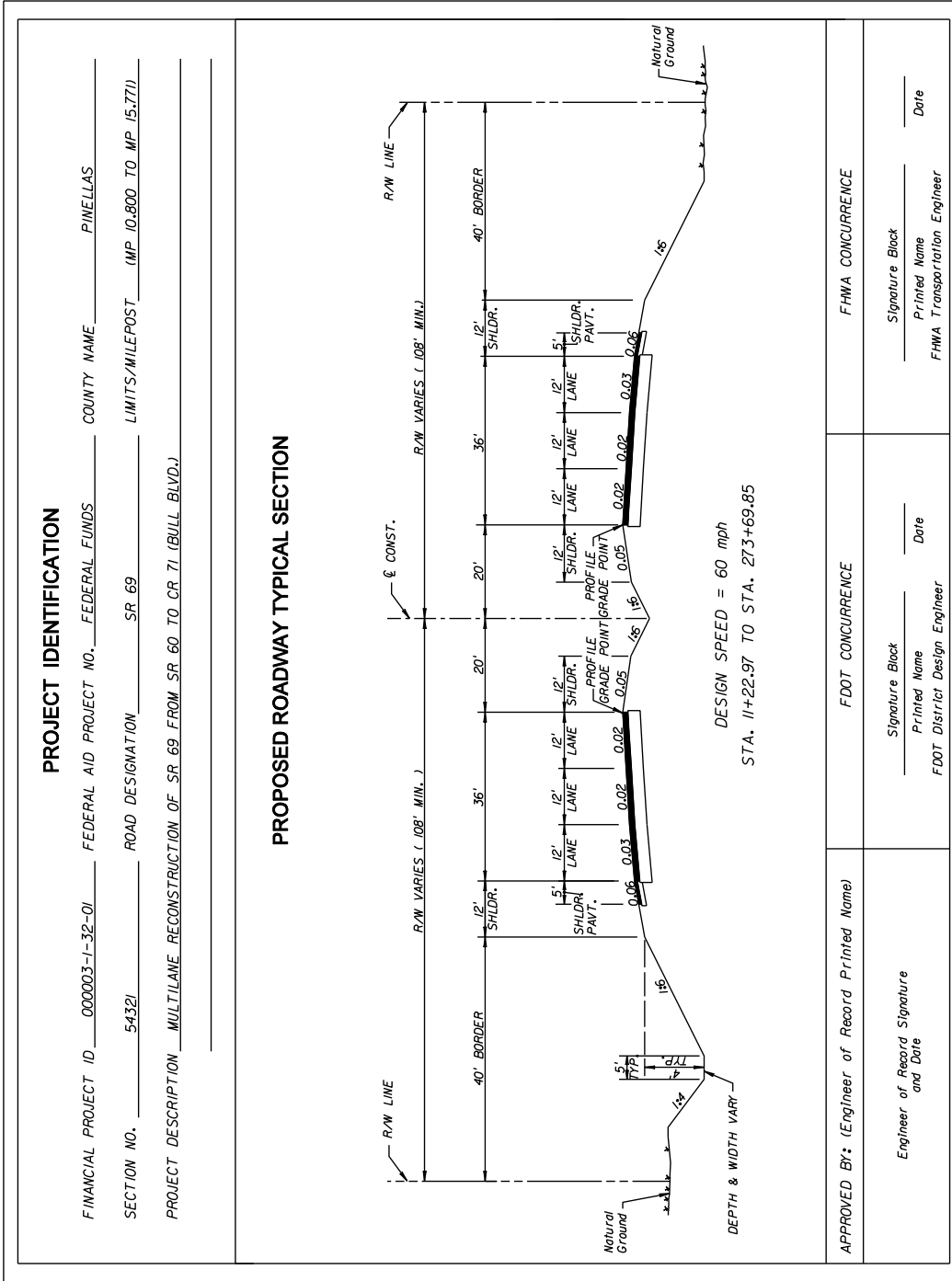

Exhibit 16-B, Sheet 5 of 6

PROJECT IDENTIFICATION	
FINANCIAL PROJECT ID 000003-1-32-01	FEDERAL AID PROJECT NO. _____ COUNTY NAME PINELLAS
SECTION NO. 54321	ROAD DESIGNATION SR 69
LIMITS/MILEPOST (MP 10.800 TO MP 15.771)	
PROJECT DESCRIPTION MULTILANE RECONSTRUCTION OF SR 69 FROM SR 60 TO CR 71 (BULL BLVD.)	
PROPOSED STRUCTURE TYPICAL SECTION	
<p style="text-align: center;">DESIGN SPEED = 60 mph SR 69 BRIDGE OVER WHATCHAMACALLIT RIVER</p>	
APPROVED BY: (Engineer of Record Printed Name)	FHWA CONCURRENCE
Engineer of Record Signature and Date	Signature Block Printed Name Date FHWA Transportation Engineer

Exhibit 16-B, Sheet 6 of 6

PROJECT IDENTIFICATION		
FINANCIAL PROJECT ID <u>000001-1-32-01</u> FEDERAL AID PROJECT NO. <u> </u> FEDERAL FUNDS <u> </u> COUNTY NAME <u>JACKSON</u>	SECTION NO. <u>99999</u> ROAD DESIGNATION <u>SR 71</u> LIMITS/MILEPOST <u>(MP 1.94) TO MP 5.809)</u>	
PROJECT DESCRIPTION <u>MILLING AND RESURFACING OF SR 71 FROM CR 481 (ONTZ RD.) TO BEAVER CREEK BRIDGE</u>		
PROPOSED ROADWAY TYPICAL SECTION		
<p style="text-align: center;">DESIGN SPEED = 55 mph STA. 10+53.00 TO STA. 214+76.04</p>		
APPROVED BY: <u> </u> (Engineer of Record Printed Name)	FDOT CONCURRENCE	FHWA CONCURRENCE
Engineer of Record Signature and Date	Signature Block Printed Name FDOT District Design Engineer	Signature Block Printed Name FHWA Transportation Engineer
Date	Date	Date

Chapter 17

Engineering Design Estimate Process

17.1	General	17-1
17.2	Basis of Estimates.....	17-2
17.3	Designer Interface for Trns•port.....	17-3
17.4	Estimated Quantities	17-4
17.4.1	Computation Book and Summary of Quantities	17-4
17.4.1.1	Plan Quantity	17-4
17.4.1.2	Final Measurement Concept.....	17-4
17.4.2	Breakdown of Quantities	17-5
17.4.3	Utility Work by Highway Contractor Agreement Plans	17-6
17.4.4	Pay Item Notes	17-6
17.5	Contract Time.....	17-7
17.6	Alternative Contracting Practices	17-7

THIS PAGE LEFT BLANK INTENTIONALLY

Chapter 17

Engineering Design Estimate Process

17.1 General

The construction cost estimate (Authorization Estimate) is one of the last activities performed on roadway and structures design projects. To do a quality cost estimate, the engineer must have available the following:

1. The complete contract plans set, including all component sets such as structures, architectural, etc.;
2. The complete specifications, including the supplemental specifications and technical special provisions;
3. The **Design Standards** booklet referenced on the key sheet of the contract plans;
4. The completed computation book for the roadway and structures plans; and
5. The current **Basis of Estimates Manual**.

17.2 Basis of Estimates

The Specifications establish the method of measurement, basis of payment, and pay items for work specified for road and bridge construction. The ***Basis of Estimates Manual*** contains design aids, notes, the pay item structure, a list of currently open pay items, and computation information to aid the engineer in preparing the cost estimate. The ***Basis of Estimates Manual*** is available on the Specifications and Estimates Office web pages at: www.dot.state.fl.us/specificationsoffice/ .

Pay items for the various categories of construction work should be identified as those components are completed. For example, pay items for base and pavement work may be identified as the pavement design is completed; signal pay items may be identified as the signal design is completed. The engineer doing the design and specifications should be knowledgeable about what work is to be done and which pay items are needed. The quantity take-off is generally performed at a later date when the plans are final and the tabulations and calculations are completed. The persons doing the quantity take-off should also ensure that all pay items have been identified.

The ***Basis of Estimates Manual*** shall be utilized to identify pay items on all types of projects, including resurfacing, widening, safety, bridge, etc. If any work on a project is not covered by existing specifications, then a technical special provision and possibly a new pay item description, unit of measure, and basis of payment may be required. If a desired pay item is not available, contact your Project Manager and /or District Estimates Office for assistance. Additional details for requesting pay items are available in ***Chapter 6*** of the ***Basis of Estimates Manual***.

17.3 Designer Interface for Trns•port

The Designer Interface, available through the Specifications and Estimates Office Webgate, is used to build categories and to add pay items and quantities to categories. Contact your District Estimates Office for more information.

17.4 Estimated Quantities

17.4.1 Computation Book and Summary of Quantities

Quantities for pay items are tabulated and computed by two methods; they are tabulated and totaled on Summary of Quantity sheets in the plans, or they are tabulated and calculated on standard computation forms. Do not record quantities in both locations. The computation book contains calculations and summary of quantities organized in pay item sequence for the project. Detailed information on the documentation required with the computation book can be found in the ***Computation Methods for Design, Construction and Final Estimates Handbook***. Summary of Quantity sheets in the plans should be completed in accordance with ***PPM Volume 2, Chapter 7***.

The original computation book, including the structures computation book, shall be transmitted to the District Construction Office when the plans are sent for letting.

17.4.1.1 Plan Quantity

The Department's current practice is to provide for final payment under the plan quantity concept for a large number of commonly used items. Refer to the ***FDOT Specifications*** to determine if an item is paid by plan quantity. This concept requires that the estimated quantities be calculated and documented as accurately as possible. The designer is responsible for the final pay quantity for all plan quantity items.

17.4.1.2 Final Measurement Concept

The designer is responsible to estimate a quantity for all final measure items. Because there are many variables associated with these items, the final pay quantity will be determined by measurements performed in the field when the item is being used or constructed.

17.4.2 Breakdown of Quantities

For projects that have partial federal funds, adequate distinction should be clearly made between participating (included in federal aid) and nonparticipating (not included in federal aid) items. All nonparticipating items with quantities should be identified in Trns•port and the Computation Book. The method of presenting this information must be of sufficient detail for project personnel to readily distinguish between participating and nonparticipating work, including its physical location on the project. Project personnel must be able to properly account for the necessary separation of quantities. These separated quantities should be properly identified as to participating and nonparticipating work when entered into Trns•port. The identification of the non-participating items within the Trns•port system will be entered by the District's estimating staff when they receive the information. In a few cases certain lump sum items such as mobilization, maintenance of traffic, etc., may be at least partially federal aid nonparticipating depending upon the nature of other nonparticipating items which must be separated. Where it is determined that certain lump sum items should be partially nonparticipating, the percentage assignment of nonparticipating should be negotiated with the FHWA. Upon mutual agreement, this percentage should be reflected when entering data into Trns•port. These items should be determined during early stages of project development. Coordinate Trns•port data entry of nonparticipating items with the District Estimates Office.

When a contract contains more than one Financial Project ID, the Summary of Pay Items and Summary of Quantities (plan tabulation sheets) must show the separate quantities for each project. The computation book should clearly distinguish the location of each part of the work. The designer should also verify that the method of payment for an item of work agrees among all projects when projects are combined into a single contract.

17.4.3 Utility Work by Highway Contractor Agreement Plans

When separate plans for utility construction are to be included in the contract, special attention should be given to establishment of pay items and loading the projects into Trns•port. Refer to the [Work Program Instructions \(Section 42\)](#) for guidance on the Financial Project ID phase number identification.

For contracts with more than one project, the pay items for Mobilization and Maintenance of Traffic will be shown on each project's Summary of Pay Items. An exception to this is when the contract contains a Utility Work by Highway Contractor (UWHC) Agreement. The pay items for Mobilization and Maintenance of Traffic will not be shown on the Summary of Pay Items for the UWHC Agreement. The cost of these items will be included in the lead project.

17.4.4 Pay Item Notes

Pay item notes are intended to be used to clarify basis of quantity, work included or method for payment. In general, pay item notes should be kept to a minimum. Only those notes that are job specific should be used. Notes that restate the standard **FDOT Specifications** or **Design Standards** shall not be used. This will help to place proper emphasis on those notes that are job specific and avoid discrepancy of documents. Refer to **PPM Volume 2, Chapter 7** for details on the usage of pay item notes in the plans.

17.5 Contract Time

Contract duration is the time required for the complete construction of the contract. Pay items measured per day need an accurate estimate of construction duration. Before completion of the design project, the plans package is submitted to the District Construction Office scheduling engineer for establishing the contract duration. Large complex projects should have the desired contract duration established earlier in the design process.

17.6 Alternative Contracting Practices

The Construction Office web page defines various contracting techniques used by the Department (<http://www.dot.state.fl.us/construction/AltContract/AltContract.shtm>). When alternative contracting is called for by the Department, coordinate the PS&E preparation with the FDOT Project Manager.

THIS PAGE LEFT BLANK INTENTIONALLY

Chapter 18

Quality Assurance and Quality Control

18.1	General	18-1
18.2	Quality Assurance	18-2
18.2.1	Authority	18-2
18.2.2	Accountability	18-2
18.2.3	Critical Areas to be Monitored.....	18-3
18.2.4	Documentation	18-4
18.2.5	Training	18-4
18.3	Quality Control	18-5
18.3.1	Authority	18-5
18.3.2	Accountability	18-6
18.3.3	Critical Areas to be Monitored.....	18-6
18.3.4	Documentation	18-6
18.3.5	Training	18-6

THIS PAGE LEFT BLANK INTENTIONALLY

Chapter 18

Quality Assurance and Quality Control

18.1 General

Quality Assurance and **Quality Control** are two processes used to ensure the public receives a quality product. Quality Assurance is the responsibility of, and performed by the Central Office. Quality Control is a responsibility of the District Offices, and is performed by the Districts and their Agents (Consultants), as appropriate.

18.2 Quality Assurance

Quality Assurance is the planned, coordinated and continued activities performed to measure processes against predetermined critical requirements. The objective of Quality Assurance is the continual improvement of the total delivery process to enhance quality, productivity and user satisfaction.

18.2.1 Authority

Florida Statutes Section 20.23(3)(a) requires a **Quality Assurance Process**. It requires the Central Office to establish departmental policies, rules, procedures and standards and to monitor the implementation in order to ensure uniform compliance and quality performance by the District and Central Office units that implement transportation programs. Also, **Florida Statutes, Section 334.048** states the Legislative intent with respect to the Central Office role in the Department's management accountability and monitoring systems, including corrective actions when appropriate.

18.2.2 Accountability

The State Roadway Design monitoring plan identifies the process, critical areas, criteria used to measure compliance, report format, method of monitoring and tracking, and procedure for follow-up of unresolved issues. The results of the Quality Assurance monitoring activities are reported to management in exit interviews and reports. The reports identify areas needing improvement, provide feedback on the effectiveness and appropriateness of established policies, procedures and standards, and recognize areas of outstanding quality. The reports are also used to share improvement ideas between districts, and to maintain consistency in process and practice.

The Central Office shall furnish all the planned and systematic actions necessary to provide adequate direction to the Districts so that all design products will be the result of predetermined requirements. This involves the establishment of design policies, procedures, standards and guidelines, training, and the monitoring and review of District compliance with these items.

The Central Office shall review each design process and its associated components for assurance that the Districts have adequate control measures in place and are complying with policy, procedures, standards, guidelines and processes. It will also be used for identifying any areas of excellence, noncompliance and need.

18.2.3 Critical Areas to be Monitored

Critical areas to be monitored by the Central Office are based on well-established roadway design policy and practice. These policies, guidelines and accepted practices formulate the criteria used to measure compliance in the areas critical to quality. The minimum frequency of review for a critical area is three years. However, latitude is allowed for the depth and frequency of reviews, based on the individual District's observed performance, review findings or the needs of District management.

The State Roadway Design monitoring plan for Quality Assurance lists the following critical areas to be monitored.

1. Initial Engineering Design Process (See **Chapter 13**, this volume)
 - a. Quality Control Activities,
 - b. Scope Activities,
 - c. Standards Activities,
 - d. Design Support Activities,
 - e. Project Activities.
2. Final Engineering Design Process (See **Chapter 14**, this volume)
 - a. Quality Control Activities,
 - b. Review Initial Engineering Design Activities,
 - c. Engineering Activities,
 - d. Support Activities.
3. Update Engineering Design Process (See **Chapter 15**, this volume)
 - a. Quality Control Activities,
 - b. Scope Activities,
 - c. Standards Activities,
 - d. Engineering Activities,
 - e. Support Activities.

18.2.4 Documentation

The Quality Assurance findings and recommendations will be documented in a report that will be distributed to the District Secretaries and other affected offices. A brief summary of the data will also be entered in the Quality Assurance Reporting (QAR) database. Summaries of significant issues will be prepared quarterly for upper management.

18.2.5 Training

Training and assistance are also a mandated role of the Central Office units and the Quality Assurance program.

1. Development: The Central Office Roadway Design will formulate a training plan based upon District requests or needs as determined by the Quality Assurance reviews.
2. Delivery: The Central Office will manage or conduct training courses for District and Consultant personnel as requested, with schedules and locations sensitive to budgets and production schedules.

18.3 Quality Control

Quality Control is the process performed to ensure conformance with valid requirements. This process includes quality planning, training, providing clear decisions and directions, constant supervision, immediate review of completed activities for accuracy and completeness, and documenting all decisions, assumptions and recommendations.

Each District shall have a **District Quality Control Plan for Roadway Design** and the other production units, which addresses broad overall quality initiative. The **District Quality Control Plan** shall identify the organization, responsibility, and accountability used to perform and document overall quality control, including the requirement for a Project Quality Control Plan on all projects. All **Project Quality Control Plans** must address any project specific scope of service needs and be approved by the Project Manager or District Design Engineer as appropriate.

In-house and consultant designers and reviewers must recognize quality is the result of several processes. It requires many individuals performing many appropriate activities at the right time during the plans development process. Quality control does not solely consist of a review after a product is completed. Quality requires performing all activities in conformance with valid requirements, no matter how large or small their overall contribution to the design process. Good CADD techniques, attention to details and ensuring the plans are correct and useful to the contractor are also essential to quality.

18.3.1 Authority

Section 20.23(4)(b), Florida Statutes, requires a **Quality Control Process**. It requires that each District shall be accountable for ensuring their District's quality of performance and compliance with all laws, rules, policies, and procedures related to the operation of the department.

18.3.2 Accountability

1. The **District** shall follow established design policies, procedures, standards and guidelines in the review and preparation of all design products; and review Consultant prepared individual engineering and design for compliance and good engineering practice.
2. The **Consultant** is an agent for the District with the primary responsibility for preparation of contract plans. Consultants must ensure quality and adherence to established design policies, procedures, standards and guidelines in the review and preparation of all design products for compliance and good engineering practice as directed by the District Project Quality Control Plan.

18.3.3 Critical Areas to be Monitored

The District shall monitor the Quality Control efforts used by in-house staff and its consultant services units. The District shall assure project scopes include an adequate **Project Quality Control Plan**.

18.3.4 Documentation

The Districts shall maintain a file containing the current District Quality Control Plan and shall furnish Central Office Design with a copy to be used as part of the critical areas to be reviewed. Every project file will contain a Project Quality Control Plan at the beginning of the Initial Engineering Design Process.

18.3.5 Training

The District shall identify and coordinate training needs of in-house and Consultant services through the appropriate Central Office units.

Chapter 19

Sealing Design Documents

19.1	General	19-1
19.2	Sealing of Contract Plans/Record Set.....	19-2
19.2.1	Manual Sealing	19-3
19.2.2	Electronic Sealing	19-4
19.3	Sealing Other Design Documents	19-5
19.4	Sealing of Revisions.....	19-6
19.4.1	Plans	19-6
19.4.2	Other Design Documents.....	19-6
19.5	Support Documents	19-7
Exhibits		
Exhibit 19-A	18 KIP Equivalent Single Axle Loads (ESAL)	19-7
Exhibit 19-B	Project Traffic.....	19-8

THIS PAGE LEFT BLANK INTENTIONALLY

Chapter 19

Sealing Design Documents

19.1 General

This chapter is based on *Florida Statutes* as well as the *Florida Administrative Code (F.A.C.)*. Though the intent of this chapter is to contain current and accurate information, it is not all-inclusive. The Laws and Rules referenced in this chapter are primarily those governing Professional Engineers and serve as a starting point for researching requirements. In some cases, other licensed professionals working on plans or other design documents will also be required to seal design documents, and those licensed professionals are required to follow the Laws and Rules applicable to their profession. The Laws and Rules regarding the signing and sealing of design documents continue to be amended, and it is the engineer's (or licensed professional's) responsibility to be aware of any changes. If there is ever a discrepancy between this chapter and the Laws and Rules regarding the sealing of documents, the Laws and Rules will govern.

This chapter explains the Department's requirements for signing/sealing design plans and other design documents prepared by or for the Department. **Section 334.175, Florida Statutes**, requires that all design plans and surveys prepared by or for the Department be sealed by the professional engineer, surveyor, architect, or landscape architect in responsible charge of the project work. It is the licensee's responsibility to comply with the sealing requirements applicable to their profession's Laws and Rules. It is the District's responsibility to verify that all record sets and documents are properly signed and/or sealed.

19.2 Sealing of Contract Plans/Record Set

An Engineer of Record (EOR) is a Florida licensed professional engineer in responsible charge for the preparation of engineering documents. A Professional of Record (POR) is any Florida licensed professional in responsible charge for the preparation of design documents. An original set of the Contract Plans shall be sealed by the EOR or POR. This becomes the Record Set. Every sheet of the Record Set must be sealed by an EOR (or POR). The key sheet must be prepared and sealed by the EOR (or POR) who is the Prime Professional for that component. Other individual sheets of the Record Set may be sealed by a delegated engineer or professional, who in turn becomes the EOR (or POR) for that portion of the work. A plans set shall not make reference to a sealed copy of “District Standards” that are kept on file at the District Office. Any “District Standards” intended for use on a project must be included in the plans set and sealed for that project.

In accordance with **Rule 61G15-23.002**, each plan sheet shall contain a title block legibly showing either:

1. the printed name, address, and license number of the engineer who has sealed the plans, or
2. if practicing through a duly authorized engineering business, the name and license number of the engineer who has sealed the plans, and the name, address and certificate of authorization number of the engineering business.

Other PORs are required to show similar information in the title block of each plan sheet in accordance with the Laws and Rules of their profession.

Licensees working for local, State or Federal Government agencies shall legibly indicate their name and license number, and shall indicate the name and address of the agency on all documents that are to be sealed. See **Volume 2, Section 1.4**.

19.2.1 Manual Sealing

The requirements for properly sealing a document are covered in the Laws and Rules for each licensee's profession.

Plans prepared by an employee of a Utility or other employees exempted under **Section 471.003, Florida Statutes**, that will be appended to Department plans, are not required to be sealed except as follows.

1. Utility plans that modify or detail attachments to a bridge or other structure belonging to the Department must have the sheets affecting such structure sealed.
2. Plans prepared by nonexempt parties for a Utility, that will be appended to Department plans, must be sealed.

For detailed requirements refer to the **Utility Accommodation Manual, Topic No. 710-020-001**.

19.2.2 Electronic Sealing

Information stored in electronic files representing plans, specifications, plats, reports, or other documents which must be sealed, shall be signed, dated and sealed by the professional in responsible charge.

Electronic files may be sealed by creating a "signature" file that contains the licensee's name and license number, a brief overall description of the design documents, and a list of the electronic files to be sealed. Each file in the list shall be identified by its file name utilizing relative Uniform Resource Locators (URL) syntax described in the **Internet Architecture Board's Request for Comments (RFC) 1738, December 1994**, which can be obtained from the Internet Website:

<ftp://ftp.isi.edu/in-notes/rfc1738.txt>

Each file shall have an authentication code defined as an SHA-1 message digest described in **Federal Information Processing Standard Publication 180-1 "Secure Hash Standard," 1995 April 17**, which can be obtained from the Internet Website:

<http://www.itl.nist.gov/fipspubs/fip180-1.htm>

A report shall be created that contains the licensee's name and license number, a brief overall description of the design documents in question and the authentication code of the signature file. This report shall be printed and manually sealed by the professional in responsible charge. The signature file is defined as sealed if its authentication code matches the authentication code on the printed, manually signed, dated and sealed report. Each electronic file listed in a sealed signature file is defined as sealed if the listed authentication code matches the file's computed authentication code.

For those sheets that are electronically signed and sealed, the following note shall be placed legibly on the sheet (outside and along the right sheet border line, within 1/8" of the line and beginning within 1" of the bottom sheet border line):

"NOTICE: THE OFFICIAL RECORD OF THIS SHEET IS THE ELECTRONIC FILE SIGNED AND SEALED UNDER RULE 61G15-23.003, F.A.C." *

* Note: The Rule number referenced is determined by the discipline of the professional that is signing and sealing (i.e., for Surveyors, this Rule is 61G17-7.0025, F.A.C.; for Geologists, this Rule is 61G16-2.005, F.A.C.; for Landscape Architects, this Rule is 61G10-11.011, F.A.C.; for Architects, this Rule is 61G1-16.005, F.A.C.).

19.3 Sealing Other Design Documents

Other design documents include related plans, reports, calculations, specifications or criteria, used in the development of design plans. Bound design documents must be sealed on a signature page or cover letter by the EOR (or POR). If a document includes work by more than one EOR (or POR), the signature page or cover letter must have an index with sufficient information for the user to be aware of each portion of the document for which each licensee is responsible. With the exception of specifications, any document, report or computations not bound shall have all sheets sealed. Specifications will be sealed in accordance with the ***Specifications Package Preparation Procedure***.

The following design documents shall be kept in the district's Project File(s).

1. Specifications Package
2. Pavement Design Package
3. Typical Section Package
4. Drainage Computations
5. Hydraulics Reports
6. Bridge Development Report
7. Traffic Engineering Reports and Recommendations
8. Environmental Reports and Recommendations
9. Soil Survey Reports and Geotechnical Report
10. Value Engineering Record
11. Other Engineering Reports
12. Permit Documentation
13. Design Exceptions and Variations
14. Design Exceptions for Utilities prepared by an Engineering Consultant

19.4 Sealing of Revisions

Revisions are a partial modification of a design document after a plans package is sent to Tallahassee for contract letting. Whenever practical, revisions should be prepared by the original EOR (or POR).

19.4.1 Plans

Revisions to a plans sheet prior to the contract letting shall be prepared as outlined in **Chapter 20** of this volume. Revised sheets will be appended to the plans set.

Any plans sheet revised after the contract letting will be sealed in accordance with **Chapter 4** of the **Preparation and Documentation Manual, Topic No. 700-050-010**.

19.4.2 Other Design Documents

Each revised sheet shall be sealed by the EOR (or POR) who prepared the revision and placed immediately behind the cover sheet of the sealed document. Specifications will be revised in accordance with the **Specification Package Preparation Procedure, Topic No. 630-010-005**.

19.5 Support Documents

Engineering decisions are often made on the basis of support documents furnished by non engineering staff or offices. Two reports prepared in accordance with Department procedures will be attested as follows:

Exhibit 19-A 18 KIP Equivalent Single Axle Loads (ESAL)

Financial Project ID _____

State Road No. _____

County _____

I have reviewed the 18 KIP Equivalent Single Axle Loads to be used for pavement design on this project. I hereby attest that these have been developed in accordance with the FDOT **Project Traffic Forecasting Procedure** using historical traffic data and other available information.

Name

Signature

Title

Organizational Unit

Date

Exhibit 19-B Project Traffic

Financial Project ID _____

State Road No. _____

County _____

I have reviewed the Project Traffic to be used for design on this project. I hereby attest that it has been developed in accordance with the FDOT ***Project Traffic Forecasting Procedure*** using historical traffic data and other available information.

Name

Signature

Title

Organizational Unit

Date

Chapter 20

Plans Processing and Revisions

20.1	General	20-1
20.2	Glossary	20-1
20.3	Plans Processing	20-3
20.3.1	District Activities	20-3
20.3.2	Submittal to Tallahassee.....	20-3
20.3.3	Submittal for Letting	20-3
20.4	Revisions to the Bid Set	20-5
20.5	Re-submittal of Withdrawn Projects	20-8
20.6	Retention of Electronic Documents	20-23
Figures		
Figure 20.1	Plans Processing Thru Tallahassee.....	20-4
Figure 20.2	District Revisions.....	20-7
Figure 20.3	Storage of Electronic Documents.....	20-24

Exhibits

Exhibit 20-A	Transmittal of Plans, Specifications, and Estimates Package	20-9
Exhibit 20-B	Contract File Index	20-11
Exhibit 20-C	Revision Memo	20-13
Exhibit 20-D	Status of Environmental Certification	20-19
Exhibit 20-E	Preliminary Engineering Certification,	20-21

Chapter 20

PLANS PROCESSING AND REVISIONS

20.1 General

This chapter describes in general terms the critical activities required to process the contract plans, specifications and estimate for letting. It identifies the transmittal forms, certifications and other documents prepared by the District and the various offices involved in processing a PS&E package. This chapter also outlines the revision process, and the steps to resubmit a project that has been withdrawn from letting.

All projects must be delivered in electronic format. Because the process is continuously updated, the latest information regarding the letting of electronic plans and specifications (including critical dates) will be posted on the Roadway Design Office web page as new information becomes available:

<http://www.dot.state.fl.us/rddesign/electronic-letting>

Other specific requirements for processing the electronic delivery, including information on the Electronic Delivery software, can be found in the **CADD Manual**, and the **CADD Production Criteria Handbook**, both are located on the Engineering/CADD Systems Office web page:

<http://www.dot.state.fl.us/ecso/downloads/publications/>

20.2 Glossary

As Built Plans - The Contract Plans after construction is completed, all revisions including those occurring during construction, have been included and with the title on the key sheet changed to Final Plans.

Bid Set – The electronic Contract Plans and Specifications Package submitted to Contracts Administration for the letting of a project.

Contract Documents - The term “Contract Documents” includes: Advertisement for Proposal, Proposal, Certification as to Publication and Notice of Advertisement for Proposal, Appointment of Agent by Nonresident Contractors, Noncollusion Affidavit,

Warranty Concerning Solicitation of the Contract by Others, Resolution of Award of Contract, Executed Form of Contract, Performance Bond and Payment Bond, Standard Specifications, Supplemental Specifications, Special Provisions, Contract Plans, Addenda, or other information mailed or otherwise transmitted to the prospective bidders prior to the receipt of bids, change orders, field orders, and supplemental agreements, all of which are to be treated as one instrument whether or not set forth at length in the form of contract.

Note: As used in Sections 2 and 3 of the Standard Specifications only, Contract Documents do not include change orders, field orders, and supplementary agreements. As used in Section 2 only, Contract Documents also do not include Resolution of Award of Contract, Executed Form of Contract, and Performance and Payment Bond.

Contract Plans - The signed and sealed documents prepared during the design phase and used by construction personnel to build a project. ,

PS&E – The Contract Plans, Specifications Package, and Estimates.

Specifications Package – The signed and sealed document prepared for inclusion in the Contract documents and which is comprised of Special Provisions, Developmental Specifications, Supplemental Specifications and Appendices.

20.3 Plans Processing

20.3.1 District Activities

There are certain plans processing activities that must occur at the District level prior to submitting plans to Tallahassee. These activities have schedule implications which will vary by District. Contact the appropriate District for specific requirements.

Any modification to the plans, specifications or quantities after Estimates changes the Control Group and before the Plans are sent to Tallahassee will be referred to as Plan Changes. These Plans Changes include the modification, deletion, or addition of data on individual sheets, adding new sheets, or the removal of entire sheets. These changes are not revisions and are not noted in the Revision Block on the sheets.

20.3.2 Submittal to Tallahassee

Prepare and post the Bid Set, the Authorization Estimate, Details of Selected Proposal, to the Central Office server no later than the Plans to Tallahassee Date. At the time of the PS&E submittal, transfer control of the Transport project files to the Project Review section of the State Specifications and Estimates Office.

Email the Transmittal of Plans, Specifications and Estimates Package Memo (**Exhibit 20-A**) and the Contract File Index (**Exhibit 20-B**) with attachments, to CO-CPKG with a copy to the Project Manager. Ensure that the computation book is available to the District Construction Engineer.

20.3.3 Submittal for Letting

Upon receipt of the Bid Set, the Project Review Section checks the package for completeness and records the date posted on the Transmittal Memo. If incomplete, the District Project Manager and District Plans, Specifications and Estimates are notified to provide a corrected submittal. Once accepted, the Bid Set is posted to the server, for access by Contracts Administration.

20.4 Revisions to the Bid Set

Design revisions are modifications to the Bid Set after it has been accepted by Central Office Project Review but prior to bid opening. The District Project Manager ensures a revision is completed as follows (see **Figure 20.2**):

1. All revisions require a completed Revision Memo (**Exhibit 20-C**). When transfer of Trns•port control to the District is needed, obtain an email concurrence from the District Director of Transportation Development (or designee) or a signed Revision Memo and forward to Central Office Project Review (CO-PROJREV). The email will include a summary of the revision. Control will then be returned to the District for a period not to exceed 48 hours.
2. If the project requires Federal Aid Oversight, obtain an email concurrence from FHWA prior to making revisions or requesting transfer of Trns•port control. On the revision memo, include the name of the FHWA contact and the concurrence date.
3. For revisions to plan sheets other than a Key Sheet, place a conspicuous unique numbered symbol (e.g., a numbered triangle) beside the revision that corresponds to the Plans Revision Number on the Revision Memo. Begin the revision numbering with “1” and number subsequent revisions of the plans, sequentially. Place the revision date, corresponding numbered symbol for the revision, and a brief description of the revision in the Revision Block on each modified sheet. The same applies to adding sheets: however, the added sheets may be numbered with alpha characters (e.g., 22a, 22b, 22c). If a sheet is being deleted, the sheet numbers for the following sheets remain unchanged. For revisions involving revised, added or deleted pay items, see **Exhibit 20-C**.
4. Revised plan sheets other than the Key Sheet are noted in the lower left corner of the Key Sheet in the “Revisions” area. (See **Exhibit KS-1, Chapter 3, Volume 2**). If the changes to a Key Sheet only involve notes in the Revisions area, no entry is made in the Key Sheet Revisions Block at the lower right corner. The Key Sheet Revisions Block is only used to record changes other than revision notes. Revisions to component sets such as the Signalization Plans are noted in the Revision Block of the modified sheet and on the **Lead** Key Sheet in the Revisions Area. If a sheet is being deleted, this must be noted in the Revisions Area on the Lead Key Sheet, and the Index of Sheets must be revised to show the sheet numbers of the deleted sheets, with a sheet description of “(DELETED)”. This also must be recorded in the Key Sheet Revisions Block as a revision to the Index of Sheets. A new Lead Key Sheet is required when any sheet is revised.

5. The Engineer of Record seals each revised document in accordance with the requirements of **Chapter 19, Sealing Design Documents**, of this volume.
6. Prepare the Revision Memo (**Exhibit 20-C**), providing a Revision Number and describing modifications. Record the revision date for each revised sheet, using the date shown in the revision block on the sheet.
7. District Specifications reviews the revision for any effect on the specifications then dates and signs the Revision Memo.
8. Revision packages should be submitted by the Monday prior to Authorization for Advertisement, whenever practical. Revisions submitted after authorization for advertisement and prior to the letting will be processed as an addendum.
9. Ensure that any revisions to the Bid Set are posted to the Central Office server. Email the scanned, signed Revision Memo to Project Review, CO-PROJREV. Ensure that the revised computation book is available to the District Construction Engineer.
10. If the Revision will be received in Project Review within 15 working days or less prior to the letting, the District Secretary's signature is required on the Revision Memo. Revisions within five working days of the letting are not allowed since there is no assurance that all prospective contractors will get these documents on time to be considered in their bids. If the revision is not approved, the project will either be let as is, or be withdrawn from letting. Withdrawing or moving the project to a later letting after advertisement requires approval by the District Secretary and the Chief Engineer.
11. Upon receipt of the scanned, signed Revision Memo, Project Review checks the revisions to the Bid Set for completeness.

Figure 20.2 District Revisions

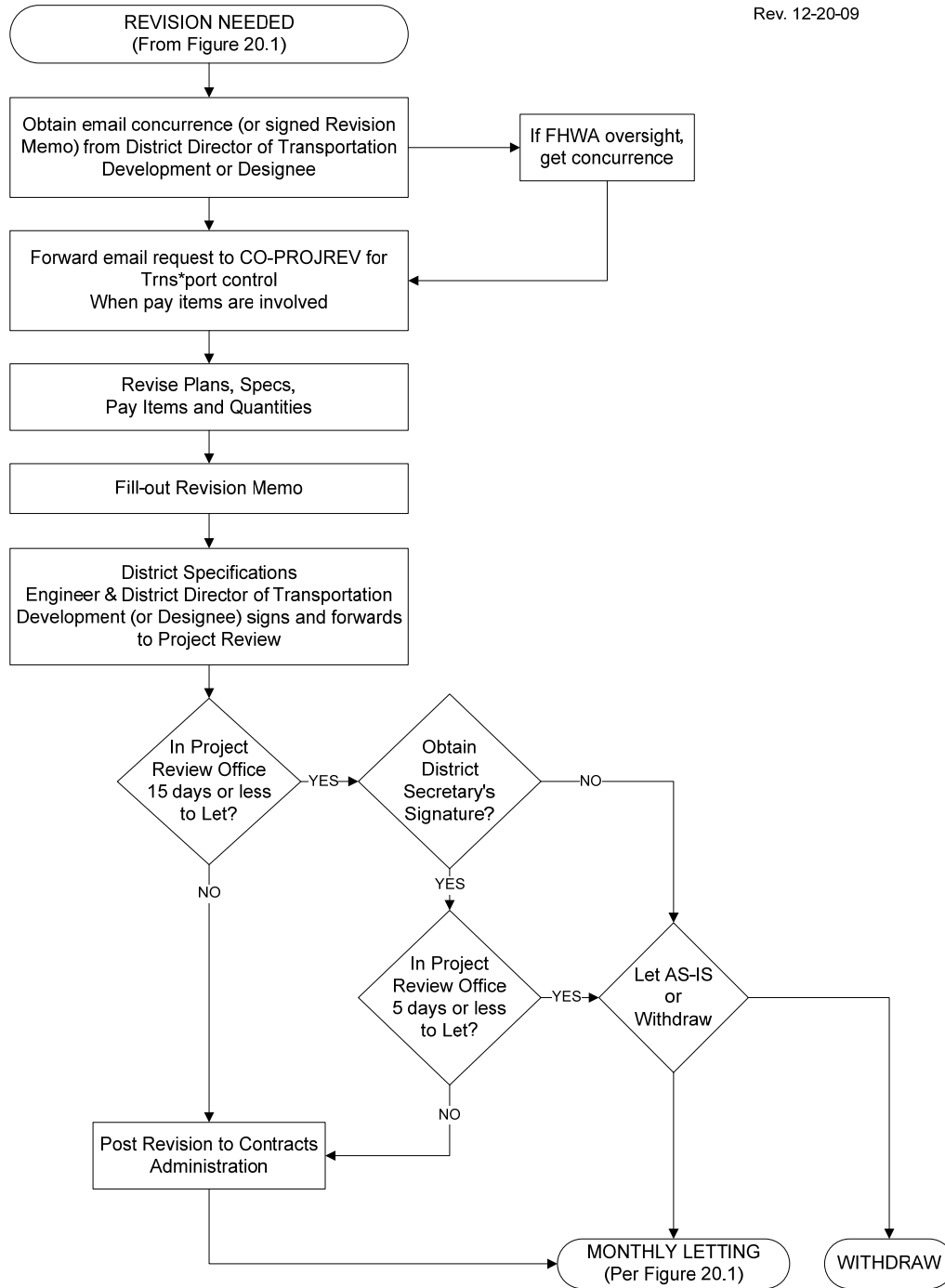

20.5 Re-submittal of Withdrawn Projects

If the District requests that the entire Plans, Specifications and Estimate (PS&E) Package be returned for major revisions before the letting, the project will be resubmitted as follows:

1. Resubmit PS&E Package as a new transmittal with all required components. Note on the Transmittal memo by the Transmittal date “Plans completely revised”. Note on the lower left corner of the lead Key Sheet, “Plans completely revised. (date)”. Project documents in Central Office from the previous submittal will be destroyed or deleted.
2. A project withdrawn for a significant period (nine months or longer) will be updated according to the process outlined in **Chapter 15**, this volume.

Plans rejected from letting by the Awards Committee or withdrawn for minor revisions may not need to follow the above process. District coordination with Central Office Production Management is required to reschedule a letting. Note that a new Proposal/Contract ID number is generated and shall be shown when resubmitting.

**Exhibit 20-A Transmittal of Plans, Specifications, and Estimates Package
Sheet 1 of 2**

TRANSMITTAL OF PLANS, SPECIFICATIONS, AND ESTIMATES PACKAGE

Date: _____
Financial Project ID(s): _____
Proposal/Contract ID: T _____ Letting Date: _____
County: _____ State Road No.: _____
Federal Funds: No Yes Federal Aid No.: _____
Work Type: _____

On ___/___/___, the District Director of Transportation Development (Production) certified that the Plans, Specifications and Estimates (PS&E) Package is complete, has no known errors or omissions, has been reviewed for constructability and biddability, and is ready to be advertised for construction.

The following items transmitted as noted:

SEALED PLANS SET (___ SHEETS), SPECIFICATIONS PACKAGE (_____ PAGES): The Electronic Bid Set was reviewed by _____ and posted to the server on ___/___/___.

ESTIMATES OFFICE INFORMATION:

The Authorization Estimate, will be reviewed by District Estimates and posted to the server along with the Details of Selected Proposal, by the Plans to Tallahassee date. At the time of posting, transfer control of the Trns*port project files to Central Office.

FEDERAL AID OFFICE INFORMATION:

Federal Aid Oversight: No Yes
FHWA: Approved by _____ Date: _____
Print Name of FHWA Engineer

CONTRACTS OFFICE INFORMATION:

Contract Time: _____ Calendar Days
Special Start Time: No Yes (If yes, Start Date: ___/___/___)
Flexible Start Time: No Yes (If yes, _____ Calendar Days)
Acquisition Time: Standard Other (_____ days)
Lead-based paint: No Yes (If yes, is it greater than 51% of the work? No Yes)
Alternative Contracting: No Yes
(If yes, Type: _____)
(If Lump Sum, Checklist 22-A submitted to District Specifications : No Yes)
Pre-Bid Conference Mandatory? No Yes (Date: ___/___/___ Time: _____ A.M./P.M.)
(Contact Person and Phone: _____)
(Location of Conference: _____)

SPECIAL NOTES and REQUIREMENTS (List/Explain):

If any items are missing please contact, _____
Contact Name and Phone Number

**Exhibit 20-A Transmittal of Plans, Specifications and Estimates Package
Sheet 2 of 2**

REMINDER

1. Check that all components of the Contract Plans are included as listed on the lead key sheet.
2. Check that all sheets are included according to key sheet indices.
3. Check that all sheets have the correct Financial Project ID.
4. Check that all sheets are legible and reproducible.
5. On strung projects, check that all Summary of Pay Item sheets from the Proposal/Contract ID go in the lead project and the Financial Project ID of the strung project is shown on the lead key sheet.
6. Check that bridge pay item sheets show bridge numbers and the quantity breakdowns.
7. E-mail the Transmittal Memo, Contract File Index and attachments to the group "CO-CPKG" and copy the Project Manager. .
8. Post the Authorization Estimate and the Details of Selected Proposal to the server, SECCADDSREV.
9. Verify the accuracy of the Description, Project Limits, Mileage and Structures.

Special Notes and Requirements:

Anything that affects the advertisement, bidding and award that is not listed above. i.e.:

For A+B projects, include the User Cost Per Day \$_____ and Maximum Days _____.

**Exhibit 20-B Contract File Index
Sheet 1 of 2**

CONTRACT FILE INDEX

Financial Project ID _____
Proposal/Contract ID _____

ATTACHMENTS (check if included or list expected date of transmittal to Central Office)

- _____ Calendar Days Recommendation*
- _____ Preliminary Engineering Certification*
- _____ Utility Certification
- _____ Status of Environmental Certification*
- _____ Permit Transmittal Memo
- _____ Railroad Clear Letter
- _____ Special Component Plan Approval**

-
- No Yes Federal Authorization Request (FAR) Form has been electronically transmitted*
 - No Yes Cost Estimate Summary Sheet has been transmitted*
 - No Yes Project exempt from FHWA oversight under agreement dated February 21, 2008*
 - No Yes Right of Way Certification was mailed to State R/W Administrator
 - No Yes Local Funds Agreement sent to Office of Comptroller
 - No Yes Local Funds Sent to Office of Comptroller
 - No Yes Project is Federally Funded off the State Highway System, requiring a Maintenance Agreement.

If yes, a Maintenance Agreement (Number _____) was executed on _____.
A copy is available upon request.

* Include if federally funded.

** Per Volume 2, Section 2.1.

Note: If project is federally funded and has a state funded "Goes With", please provide the same documentation as required for a federally funded project.

Name: _____

Date: _____

Print Name of Project Manager/Other Title

Exhibit 20-B Contract File Index, Sheet 2 of 2

REMINDER

PROCESS:

1. Organize attachments in the order listed.
2. Show the number of Maintenance Agreements (Federal funds – off the State Highway System).
3. Show anticipated date of arrival on any item not included in package.

NOTE: The Contract File Index is an integral part of the Transmittal of Plans, Specifications and Estimates Package.

Exhibit 20-C Revision Memo
Sheet 1 of 6

DATE: _____ 1 of ____
TO: Project Review (CO-PROJREV)
FROM: _____, Project Manager
COPIES: DDE, DCPME
SUBJECT: **Revision Number** _____ - Letting (mo./yr.) ____
Financial Project ID _____ (Lead number only)
Proposal/Contract ID _____
Federal Funds: No Yes Federal Aid No. _____
County _____ State Road No. _____
Concurred by: _____ Date: _____
Signature of Director of Transportation Development or designee

I have reviewed for effects on the Specifications Package and a package revision **is** ____
is not ____ required. Approved By: _____ Date: _____
Signature of District Specifications Engineer

If FA Oversight, Authorized By: _____ Date: _____
Print Name of FHWA Engineer

REVISIONS RECEIVED IN THE PROJECT REVIEW OFFICE WITHIN 15
WORK DAYS OF THE LETTING MUST BE APPROVED BY THE DISTRICT
SECRETARY.

NO REVISIONS ALLOWED WITHIN 5 WORK DAYS OF THE LETTING.

Approved By: _____ Date: _____
Signature of District Secretary

- SUPPLEMENTAL SPECIFICATIONS PACKAGE NUMBER _____ (____ Pages).
 - REISSUED SPECIFICATIONS PACKAGE _____ (____ Pages).
 - PLANS REVISION NUMBER ____ (____ Sheets)
- CONTRACT TIME REVISED: No Yes (If yes, _____ Calendar Days)

Exhibit 20-C Revision Memo, Sheet 2 of 6

DATE: _____ of _____

Financial Project ID _____ (Lead number only)

Proposal/Contract ID _____

PLANS REVISION NUMBER _____

<u>Sheet Nos.</u>	<u>Rev. Date</u>	<u>Description</u>
_____	_____	_____
_____	_____	_____
_____	_____	_____

SUPPLEMENTAL SPECIFICATIONS PACKAGE NUMBER _____

<u>Sheet Nos.</u>	<u>Rev. Date</u>	<u>Description</u>
_____	_____	_____
_____	_____	_____
_____	_____	_____

Summary of Quantities (Trns*port)

Pay Item	Sheet No.	Add. / Del. / Rev.	Old Quantity	New Quantity

Exhibit 20-C Revision Memo, Sheet 3 of 6

REMINDER

PROCESS:

1. Fill out headings.
2. On oversight projects, get FHWA concurrence. Print name of FHWA Engineer and date.
3. Get concurrence signature from the District Director of Transportation Development or designee.
4. Get signature of the District Specifications Engineer.
5. Revisions received in the Project Review Office within 15 work days of the letting must be approved by the District Secretary. Notify Project Review. Revisions are not allowed within 5 work days of the letting.
6. For Supplemental Specification Packages, fill in the Rev. Date, number of pages and a brief description.
7. Enter the sheet number and:
Describe new pay item number, Rev. Date with old quantity and new quantity, deleted pay item number only, or revised quantities; by entering pay item number with old and new quantities.
8. On bridges indicate “each bridge number” with corrected changes.
9. If a revision will impact the utility plans, adjustments or schedules, provide a copy of the revision memo and affected plan sheets to the District Utilities Engineer.
10. Any change to any pay item, requires replacement of the entire Proposal Summary of Pay Items..
11. Email the Revision approval to Project Review Section (CO-PROJREV) to unlock the summary of pay items.
12. Email Revision Memo to Project Review.

REVISED DOCUMENTS:

1. Revised sealed plans sheets including Summary of Pay Items.
2. Revised District Cost Estimate if federally funded.
3. Revised sealed Supplemental Specifications Package.

COMPUTATIONS:

Show Financial Project ID on revised computation book sheets, and make available to the District Construction Engineer.

Exhibit 20-C Revision Memo, Sheet 4 of 6

EXAMPLE REVISION MEMO

DATE: March 14, 2007 1 of 2
TO: Project Review (CO-PROJREV)
FROM: _____, Project Manager
COPIES: DDE, DCPME
SUBJECT: **Revision Number** _____ - Letting (mo./yr.) _____ / _____
Financial Project ID 197707-1-52-01 (Lead number only)
Proposal/Contract ID T1235
Federal Funds: No Yes Federal Aid No. _____
County County Name State Road No. 25

Concurred by: _____ Date: _____
Signature of Director of Transportation Development or designee

I have reviewed for effects on the Specifications Package and a package revision **is** _____
is not _____ required. Approved By: _____ Date: _____
Signature of District Specifications Engineer

If FA Oversight, Authorized By: _____ Date: _____
Print Name of FHWA Engineer

REVISIONS RECEIVED IN THE PROJECT REVIEW OFFICE WITHIN 15 WORK DAYS OF THE LETTING MUST BE APPROVED BY THE DISTRICT SECRETARY.

NO REVISIONS ALLOWED WITHIN 5 WORK DAYS OF THE LETTING

Approved By: _____ Date: _____
Signature of District Secretary

- SUPPLEMENTAL SPECIFICATIONS PACKAGE NUMBER _____ (____ Pages).
- REISSUED SPECIFICATIONS PACKAGE _____ (____ Pages).
- PLANS REVISION NUMBER 2 (4 Sheets)

CONTRACT TIME REVISED: No Yes (If yes, _____ Calendar Days)

Exhibit 20-C Revision Memo, Sheet 5 of 6

EXAMPLE REVISION MEMO

DATE: March 14, 2007

2 of 2

Financial Project ID 197707-1-52-01 (Lead number only)

Proposal/Contract ID T1235

PLANS REVISION NUMBER 2

<u>Sheet Nos.</u>	<u>Rev. Date</u>	<u>Description</u>
<u>1</u>	<u>3-14-07</u>	<u>Listed Revisions</u>
<u>2</u>	<u>3-14-07</u>	<u>See Summary of Quantities Table below</u>
<u>3</u>	<u>3-14-07</u>	<u>See Summary of Quantities Table below</u>
<u>4</u>	<u>3-14-07</u>	<u>Transport updated.</u>

SUPPLEMENTAL SPECIFICATIONS PACKAGE NUMBER _____

<u>Sheet Nos.</u>	<u>Rev. Date</u>	<u>Description</u>
_____	_____	_____
_____	_____	_____
_____	_____	_____

Summary of Quantities (Trns*port)

Pay Item	Sheet No.	Add. / Del. / Rev.	Old Quantity	New Quantity
120-1	2	Rev	121,172 CY	128,237 CY
120-6	2	Rev	96,143 CY	95,680 CY
425-1-559	2	Add		1 EA
530-3-3	3	Rev	54.7 TN	57.7 TN
530-3-4	3	Rev	86-7 TN	32.0 TN

Exhibit 20-C Revision Memo, Sheet 6 of 6 EXAMPLE SUMMARY OF PAY ITEMS SHEET

NOTICE: THE OFFICIAL RECORD OF THIS SHEET IS THE ELECTRONIC FILE SIGNED AND SEALED UNDER RULE 6095-23.003, F.A.C.

DATE: 07/14/09		FLORIDA DEPARTMENT OF TRANSPORTATION		PAGE: 1 A0001	
PROJECTS: 19770715201		LEAD PROJECT: 19770715201		MANDIST: 01	
COUNTY: POLK		COUNTY: POLK		MANDIST: 01	
0001 SUMMARY OF ROADWAY		PAY ITEMS		QUANTITY TOTAL	
P ALT	ITEM NUMBER	DESCRIPTION	UNIT	19770715201	TOTAL
	0999-102-2	SPEED & LAW ENFORCEMENT OFFICER, STATE FURNISHED, DISTRICT CONTRACT	HR	1,000	1,000
	0100-1	MOBILIZATION OF TRAFFIC	LS	1,000	1,000
	0102-3	COMMERCIAL MATERIAL FOR DRIVEWAY MAINTENANCE	CY	1050.000	1050.000
	0102-14	TRAFFIC CONTROL OFFICER	HR	48.000	48.000
	0102-61	BUSINESS SIGNS	EA	600.54.000	600.54.000
	0102-71	BARRIER WALL, TEMPORARY, E&I, CONCRETE	LF	5177.000	5177.000
	0102-74	BARRIER WALL, TEMPORARY, TYPE 1, 6" VP & DRUM	LF	197.000	197.000
	0102-76	ADVANCE WARNING ARROW PANELS, TYPED, TEMPORARY	ED	290.000	290.000
	0102-78	REFLECTIVE PAVEMENT MARKER, TEMPORARY, TYPE B	EA	4299.000	4299.000
	0102-89	LIGHTS, BARRIER WALL MOUNT, TYPE C, STEADY BURN	EA	2079.000	2079.000
	0102-99	CHANGEBLE-VARIABLE MESSAGE SIGN, TEMPORARY	ED	118.000	118.000
	0102-150	PORTABLE REGULATORY SIGN	ED	180.000	180.000
	0104-70	SEMENT BARRIER UNIT	LF	20646.000	20646.000
	0104-12	STAKED RUBBER BARRIER, NYLON REINFORCED PVC	LF	463.000	463.000
	0109-71	INLET PROTECT ON	EA	1840.000	1840.000
	0110-7	INLET PROTECT ON	EA	725.000	725.000
	0120-1	MATERIAL, F&I, SINGLE	EA	17.000	17.000
	0120-6	EMBANKMENT	EA	128237.000	128237.000
	0288-71	STABILIZATION TYPE B GROUP 11	CY	95680.000	95680.000
	0387-70	TURNOUT CONSTRUCTION	SY	105404.000	105404.000
	0334-7	MILLING EXIST. ASPH PAVT, 2 3/4" AVG DEPTH	SY	1068.000	1068.000
	0341-70	SUPPLEMENTARY CONCOURSE INTERLAYER, FC-5, PG76-22	SY	62414.000	62414.000
	0400-1	ASPHALT RUBBER MEMBRANE INTERLAYER	SY	336082.500	336082.500
	0400-2	CONCRETE CLASS 1, SUBWALLS	CY	62585.000	62585.000
	0415-1	CONCRETE CLASS 1, CULVERTS	CY	154.000	154.000
	0425-1	REINF STEEL ROADWAY, 5" <10"	CY	139.100	139.100
	0425-2	INLETS, CURB, TYPE P-6, <10"	EA	20914.000	20914.000
	0425-3	INLETS, CURB, TYPE P-6, <10"	EA	20.000	20.000
	0425-4	INLETS, CURB, TYPE J-5, <10"	EA	2.000	2.000
	0425-5	INLETS, CURB, TYPE J-5, <10"	EA	4.000	4.000
	0425-6	INLETS, CURB, TYPE J-6, <10"	EA	6.000	6.000
	0425-7	INLETS, CURB, TYPE J-6, <10"	EA	1.4.000	1.4.000
	0425-8	INLETS, DT BOT, TYPE B, <10"	EA	2.000	2.000
	0425-9	INLETS, DT BOT, TYPE D, <10"	EA	2.000	2.000
	0425-10	INLETS, DT BOT, TYPE D, MODIFY	EA	3.000	3.000
	0425-11	INLETS, BUTTER, TYPE S, <10"	EA	17.000	17.000
	0425-12	INLETS, BUTTER, TYPE S, J BOTTOM <10"	EA	3.000	3.000
	0425-13	MAHWHOLLS, P-7, <10"	EA	3.000	3.000
	0425-14	MAHWHOLLS, P-7, <10"	EA	3.000	3.000
	0425-15	MAHWHOLLS, P-7, <10"	EA	7.000	7.000
	0425-16	MAHWHOLLS, J-7, <10"	EA	3.000	3.000
	0425-17	MAHWHOLLS, J-7, <10"	EA	3.000	3.000

DATE: 06/11/07

PROJECTS: 19770715201

LEAD PROJECT: 19770715201

COUNTY: POLK

0001 SUMMARY OF ROADWAY

PAY ITEMS		CONTINUED	
P ALT	ITEM NUMBER	DESCRIPTION	QUANTITY TOTAL
	0425-18	INLETS, CURB, TYPE J-5, <10"	2.000
	0425-19	INLETS, CURB, TYPE J-5, <10"	4.000
	0425-20	INLETS, CURB, TYPE J-6, <10"	6.000
	0425-21	INLETS, CURB, TYPE J-6, <10"	1.4.000
	0425-22	INLETS, DT BOT, TYPE B, <10"	2.000
	0425-23	INLETS, DT BOT, TYPE D, <10"	2.000
	0425-24	INLETS, DT BOT, TYPE D, MODIFY	3.000
	0425-25	INLETS, BUTTER, TYPE S, <10"	17.000
	0425-26	INLETS, BUTTER, TYPE S, J BOTTOM <10"	3.000
	0425-27	MAHWHOLLS, P-7, <10"	3.000
	0425-28	MAHWHOLLS, P-7, <10"	3.000
	0425-29	MAHWHOLLS, J-7, <10"	7.000
	0425-30	MAHWHOLLS, J-7, <10"	3.000

DATE: 7/14/07 5/15/07 6/11/07 REVISIONS TRANSPORT UPDATED REVISED AND ADDED PAY ITEMS DELETED PAY ITEM 04-5 ADDED PAY ITEMS	STATE OF FLORIDA DEPARTMENT OF TRANSPORTATION ROAD NO. 25 COUNTY POLK PROJECT 197707-1-52-01 1/3/2009 9:42:24 AM #:\V\19770715201\19770715201\Summary of Pay Items Sheet File - 058 USD-2008-09
SUMMARY OF PAY ITEMS	
SHEET NO.	2

Exhibit 20-D Status of Environmental Certification
Sheet 1 of 2

STATUS OF ENVIRONMENTAL CERTIFICATION

Financial Project ID _____
Proposal/Contract ID _____
Federal Aid No. _____
Project Description _____

This project is a Categorical Exclusion under 23 C.F.R. 771.117:

- _____ This project is a Type 1 Categorical Exclusion under (23 CFR 771.117(c)) effective November 27, 1987 as determined on _____, and the determination remains valid.
- _____ This project is a Programmatic Categorical Exclusion per FHWA, FTA, and FDOT Agency Operating Agreement executed on January 15, 2003 as determined on _____, and the determination remains valid.

The environmental document for this project was a (check one):

- _____ A Type 2 Categorical Exclusion under 23 C.F.R. 771.117(d) approved on _____,
- _____ A Finding of No Significant Impact under 23 C.F.R. 771.121 approved on _____, or
- _____ A Final Environmental Impact Statement under 23 C.F.R. 771.125 approved on _____.

A reevaluation in accordance with 23 C.F.R. 771.129 was (check one):

- _____ Approved on _____.
- _____ Not required.

Signature: _____ Date: _____
Environmental Administrator

Exhibit 20-D Status of Environmental Certification
Sheet 2 of 2

REMINDER

Exhibit 20-D must be completed on all federally funded projects. On federally funded projects strung with non-FA projects, the FA project is to be the lead project. Regarding federal environmental compliance, the limits of the environmental document will control the scope of compliance with NEPA requirements. NEPA requirements (including staging areas and Contractors' off-site activities) must only be met for that portion of the project included within the "logical termini" as described in the NEPA document associated with the federally funded portion of the contract.

**Exhibit 20-E Preliminary Engineering Certification
Sheet 1 of 2**

MEMORANDUM

DATE: _____

TO: _____, Federal Aid Programs Manager

FROM: _____, Design Project Manager

COPIES:

SUBJECT: **PRELIMINARY ENGINEERING CERTIFICATION** (Federal Aid Projects Only)

Financial Project ID _____

Proposal/Contract ID _____

Federal Aid No. _____

Preliminary Engineering (design) was funded with:

_____ State Funds under,
Financial Project ID _____

_____ Federal Funds authorized under,
Federal Aid No. _____
Financial Project ID _____

The following projects, designed with the same Preliminary Engineering funds,
will be strung to (awarded with) the subject project:

Federal Aid No. _____, Financial Project ID _____,

Federal Aid No. _____, Financial Project ID _____.

The Preliminary Engineering for the subject project is _____ open/ _____ closed. If
open,

_____ it will be closed after PS&E authorization, or

_____ it is a district wide project. Task order number _____ for this project is closed.

The financial number will be open for other projects.

_____ it will remain open for additional charges, as follows: _____

The FDOT Project Manager may be contacted at (phone): _____

**Exhibit 20-E Preliminary Engineering Certification
Sheet 2 of 2**

REMINDER

Under “Preliminary Engineering (design) was funded with:”

The Financial Project ID should always have a 3X phase in it. 3X is for
Preliminary Engineering (design). Example: 415211-1-32 01
or 415211-1-31 01

20.6 Retention of Electronic Documents

The documents and files created throughout the life of a project must be retained in electronic format. There are several different storage systems used for retaining these records. See **Figure 20.3**.

Figure 20.3 Storage of Electronic Documents

		Electronic Data Management System (EDMS)			
		Legal Records for Department of State Requirements - Image files (TIF) only			
		For Information on Specific Document Types stored in each Group contact the Responsible Office			
TIMS	PEDDS DATABASE	DESIGN EDMS	CONTRACTS EDMS	CONSTRUCTION EDMS	STRUCTURES MANAGEMENT EDMS
File management system for In-house CADD file check in/out. Allows for multiple users to work on same files. Working files only. Can be used during Construction Phase to prepare As-Built Plans.	Electronic Vault for Storage of electronically signed files For Storage of: -Project CD -Plans and Specs CD -Revisions CD -Cat II Bridge As-Built files Files stored in the PEDDS Database cannot be overwritten.	<u>Design Records</u> <u>Groups</u> Architectural Community Involvement Drainage Environmental Permits Estimates FDOT Publications Geotechnical/Materials Landscaping Lighting Product Evaluation Project Management Rdwy Design Documentation Does not include Plans Roadway Resource Library Specifications Structures Structures Resource Library Tolls Facilities Traffic Design Utility Agreements	<u>Contracts Records</u> <u>Groups</u> Construction Contracts: - Amendments - Bid Blank - Certificate Of Insurance - Contract - Federal Aid Contract - Provisions - Permits - Pertinent Pages - Proposal - Special Provisions - Specifications - Supplemental - Specifications - Utility Work Schedule - Wage Rate Supporting Construction Contract Documents: - Award Letter - Correspondence - Daily Diaries - Execution Letter - Final Estimates - Package - Work Progress	<u>Construction Records</u> <u>Groups</u> Claim Compliance Contract Changes Includes Design Errors and Omissions, Field SA/Work Orders and SA/Change Orders Contract Documents Does not include Plans Daily Diary Estimates Final Estimates General Correspondence Job Correspondence Material Sampling and Reporting Pre-Letting Includes Design Correspondence Quality Assurance/Quality Control Service Contracts Shop Drawing Transmittals Structure Sublet Work Time Correspondence Unpaid Bills Utility	<u>Maintenance Records</u> <u>Groups</u> Bridge Plans and Specifications Bridge Record Bridge Shop Drawings Correspondence Geotechnical High Mast Record Sign Record Structural Calculations - As-Bid Plans - As-Built Plans - Repair As-Bid Plans - Repair As-Built Plans - Widening As-Bid Plans - Widening As-Built Plans

Chapter 21

Transportation Design for Livable Communities

21.1	General	21-1
21.2	Planning	21-2
21.3	Application.....	21-3
21.4	Techniques.....	21-4
21.5	Design Criteria	21-5
21.5.1	Design Speed	21-5
21.5.2	Number of Lanes	21-5
21.5.3	Lane Widths	21-5
21.5.4	Horizontal Alignment.....	21-6
21.5.5	Medians	21-6
21.5.6	Horizontal Clearance	21-6
21.5.7	Intersections.....	21-10
21.5.8	Lighting	21-10
21.5.9	Traffic Control	21-10
21.5.10	Landscaping.....	21-11
21.5.11	Parking.....	21-11
21.5.12	Alternative Roadway Paving Treatments.....	21-12
21.5.13	Conversion to/from One-Way Street Pairs.....	21-12
21.6	Pedestrian and Bicycle Considerations.....	21-13
21.6.1	Sidewalks.....	21-13
21.6.2	Crosswalks.....	21-13
21.6.3	Curb Extensions (Bulb-Outs)	21-13
21.6.4	Personal Security and Safety Amenities.....	21-14
21.6.5	Bicycle Facilities.....	21-14
21.7	Transit-Systems and Amenities	21-14

Tables

Table 21.1	Lane Widths	21-5
Table 21.2	Horizontal Clearance to Utility Installations.....	21-8
Table 21.3	Horizontal Clearance to Trees	21-8
Table 21.4	Horizontal Clearance to Canal and Drop-off Hazards.....	21-8
Table 21.5	Horizontal Clearance to Other Roadside Obstacles	21-9
Table 21.6	TDLC Recoverable Terrain	21-9

Figures

Figure 21.1	Curb Extension	21-14
-------------	----------------------	-------

Exhibits

Exhibit 21-A	Corridor Techniques	21-15
Exhibit 21-B	Techniques To Reduce Speed Or Traffic Volume.....	21-16
Exhibit 21-C	Techniques To Encourage Multimodal Travel.....	21-17
Exhibit 21-D	Network Techniques	21-18

Chapter 21

Transportation Design for Livable Communities

21.1 General

It is the policy of the Department to consider Transportation Design for Livable Communities (TDLC) features on the State Highway System when such features are desired, appropriate and feasible. This involves providing a balance between mobility and livability. TDLC features should be based on consideration of the following principles:

1. Safety of pedestrians, bicyclists, motorists and public transit users.
2. Balancing community values and mobility needs.
3. Efficient use of energy resources.
4. Protection of the natural and manmade environment.
5. Coordinated land use and transportation planning.
6. Local and state economic development goals.
7. Complementing and enhancing existing Department standards, systems and processes.

21.2 Planning

TDLC features are to be considered when they are desired, appropriate and feasible. Incorporating TDLC features are contingent upon involvement of the local stakeholders in the planning and project development processes. Therefore, it is essential that all stakeholders are included from the initial planning phase of the project through design, construction and maintenance.

During the initial planning and scoping phases it is important to identify and assess the desires and willingness of the community or stakeholder to accept all of the ramifications of TDLC, including funding allocations and maintenance agreements of the TDLC features included in a project.

21.3 Application

A team approach is recommended to evaluate TDLC projects or features. Depending on the complexity and/or potential for controversial proposed TDLC features and the district resources available, the team may include representation from Planning, Traffic Operations, Environmental Management, Roadway Design, Right of Way, Public Transportation, Maintenance, Safety, and the Pedestrian/Bicycle and Community Impact Assessment Coordinators. This team should also include the respective Metropolitan Planning Organization(s), local governments/agencies, transit agencies, citizen groups and any others affected by the proposed projects or features.

TDLC projects require documentation of the desired project features determined to be appropriate and feasible for implementation and the respective responsibilities of all involved stakeholders. Documentation may be stand-alone or placed in the design documentation..

TDLC features can be incorporated into new construction, reconstruction, and resurfacing, restoration and rehabilitation (RRR) projects using existing design standards and criteria found in **Chapters 2, 8 and 25** of this volume. When documentation identifies TDLC features for a project or segments of a project, the criteria provided in this chapter may be used with the approval of the District Design Engineer.

21.4 Techniques

Selected TDLC techniques applied by type of highway system are shown in **Exhibits 21-A, B, C and D** at the end of this chapter. These techniques are intended as guidance for balancing the need for mobility and the desire for livable communities, and not as standards, policies or procedures of the Department.

21.5 Design Criteria

The criteria in this chapter meets or exceeds **AASHTO** minimums. All TDLC projects are subject to the requirements for Design Exceptions and Design Variations found in **Chapter 23** of this volume.

21.5.1 Design Speed

Recommended design speeds are found in **Section 1.9** of this volume.

21.5.2 Number of Lanes

In developed urban areas, reducing the number of lanes may provide space for pedestrians, bicycles, parking, landscaping etc. This technique may be appropriate depending on volume and character of traffic, availability of right of way, function of the street, existing or planned level of pedestrian, bicycling and transit activity, intensity of adjacent land use, and availability of alternate routes.

The decision to reduce the number of lanes on a project shall be supported by an appropriate traffic capacity study. If transit vehicles and school busses are currently operating in the area of the project, appropriate local agencies should be consulted.

21.5.3 Lane Widths

Minimum lane widths for TDLC projects or segments are shown in **Table 21.1**.

Table 21.1 Lane Widths

Lane Types	Width (feet)
Through Lanes	11 ¹
Turn Lanes	11 ¹
Parking Lanes (parallel)	8 ²
Bicycle Lanes	4 ³

1. May be reduced to 10 feet in highly restricted areas with design speeds \leq 35 mph. having little or no truck traffic.
2. May be reduced to 7 feet (measured from face of curb) in residential areas.
3. 5 feet adjacent to on-street parking.

21.5.4 Horizontal Alignment

A curvilinear alignment can be used to control vehicle speed by introducing a bend or curve on a tangent roadway. Design should meet criteria in **Chapter 2** of this volume.

21.5.5 Medians

Requirements for medians are provided in **Section 2.2** of this volume. Where continuous raised medians are not provided, such as on 5-lane sections, refuge areas should be provided at appropriate locations. These locations are typically near high pedestrian generators such as schools, park entrances, transit stops and parking lots. Refuge Islands must provide a large enough area for several pedestrians at once while at the same time be of sufficient size and spacing as to not create a hazard. For wheelchair accessibility, it is preferable to provide at-grade cuts rather than ramps.

For landscaping in medians see **Section 21.5.10**.

21.5.6 Horizontal Clearance

Horizontal clearance is the lateral distance from a specified point on the roadway such as the edge of travel lane or face of curb, to a roadside feature or object. Horizontal clearance applies to all highways. Horizontal clearance requirements vary depending on design speed, whether rural or urban with curb, traffic volumes, lane type, and the object or feature.

Rural highways with flush shoulders and highways with curb or curb and gutter where right of way is not restricted have roadsides of sufficient widths to provide clear zones; therefore, horizontal clearance requirements for certain features and objects are based on maintaining a clear zone wide enough to provide the recoverable terrain in **Table 21.6**. The procedure for determining required clear zone widths is further described in **Chapter 4** of this volume.

In urban areas, horizontal clearance based on clear zone requirements for rural highways should be provided wherever practical. However, urban areas are typically characterized with lower speed (Design Speed ≤ 45 mph), more dense abutting development, closer spaced intersections and accesses to property, higher traffic volumes, more bicyclists and pedestrians, and restricted right of way. In these areas, curb with closed drainage systems are often used to minimize the amount of right of way needed. Highways with curb or curb and gutter in urban areas

where right of way is restricted do not have roadsides of sufficient widths to provide clear zones; therefore, while there are specific horizontal clearance requirements for these highways, they are based on clearances for normal operation and not based on maintaining a clear roadside for errant vehicles. It should be noted that curb has no redirection capabilities except at speeds less than the lowest design speeds used on the State Highway System. Therefore curb should not be considered effective in shielding a hazard. Curb is not to be used to reduce horizontal clearance requirements.

Crashworthy objects shall meet or exceed the offsets listed in **Tables 21.2** through **Table 21.5** and objects that are not crashworthy are to be as close to the right of way line as practical and no closer than the requirements listed in **Tables 21.2** through **Table 21.5**.

Table 21.2 Horizontal Clearance to Utility Installations

ABOVE GROUND OBJECTS	See the <i>Utility Accommodation Manual (UAM)</i> , (Topic No. 710-020-001) for horizontal clearance criteria for utilities. The <i>UAM</i> is available online at: http://www.dot.state.fl.us/rddesign/utilities/
-----------------------------	---

Table 21.3 Horizontal Clearance to Trees

<p>Minimum horizontal clearance for new plantings where the diameter is or is expected to be greater than 4 inches (measured 6 inches above the ground) shall be located outside the clear zone except as follows:</p> <p>Urban Curb or Curb and Gutter (Design Speed \leq 45 mph): 4 feet from face of outside curb and 6 feet from edge of inside traffic lane. In areas where the border width or median width are constrained and this criteria cannot be met, this horizontal clearance may be reduced to 1.5 feet from face of outside curb and 3 feet from edge of inside traffic lane.</p> <p>On existing roadways, the minimum horizontal clearance to existing trees where the diameter is or is expected to be greater than 4 inches (measured 6 inches above the ground) shall be located outside the clear zone except as follows:</p> <p>Urban Curb or Curb and Gutter (Design Speed \leq 45 mph): 1.5 feet from the face of outside curb and 3 feet from the edge of the inside traffic lane.</p>
--

Table 21.4 Horizontal Clearance to Canal and Drop-off Hazards

See Chapter 4 of this Volume for horizontal clearance criteria for canal and drop-off hazards.

Table 21.5 Horizontal Clearance to Other Roadside Obstacles

Shall be located outside the clear zone except as follows: Urban Curb or Curb and Gutter (Design Speed ≤ 45 mph): Shall be located no closer than 1.5 feet from face of curb.	
Note:	Horizontal clearance to mailboxes is specified in the construction details contained in the <i>Design Standards, Index 532.</i>
Note:	Transit and school bus shelters shall be placed in accordance with <i>Rule Chapter 14-20.003, Florida Administrative Code.</i> Transit bus benches shall be placed in accordance with <i>Rule Chapter 14-20.0032, F.A.C..</i>

Table 21.6 TDLC Recoverable Terrain

Design Speed (mph)	(feet)
≤ 30	12
35	14
40	16

21.5.7 Intersections

Intersection designs must adequately meet the needs of motorists, transit riders, bicyclists and pedestrians. Large return radii increases the crossing distance for pedestrians while small return radii decreases a vehicle's ability to negotiate the turn. Return radii must balance the needs of the pedestrian and the design vehicle. See **Figure 21.1**.

21.5.8 Lighting

Lighting requirements are discussed in **Chapters 2** and **7** of this volume.

21.5.9 Traffic Control

Where traffic volumes are high enough to require traffic signals, they should be placed to allow good progression of traffic from signal to signal. Optimal spacing of signals depends on vehicle operating speeds and signal cycle lengths. At speeds of 35 mph and standard cycle lengths, signals must be at least a fourth of a mile apart. Such spacing is consistent with FDOT's requirements for state highways, and with its recommended minimums for local arterials and collectors.

Where traffic volumes are not high enough to warrant traffic signals, 4-way stop signs and roundabouts should be considered. Four-way stops are considered to have a traffic calming effect and cause minimal delays under light traffic conditions. Roundabouts allow traffic from different directions to share space in the intersection, while signals require traffic to take turns.

Where traffic volumes are high enough to warrant traffic signals but does not require them, roundabouts should also be considered. If Roundabouts are being considered in a TDLC project, refer to FHWA's **Roundabouts: An Informational Guide** and the **Florida Roundabout Guide**.

21.5.10 Landscaping

Landscaping on a TDLC project can be provided when a local agency or organization agrees to assume the maintenance of the landscaped area in accordance with all Department requirements. See **Chapter 9** of this volume and the **Florida Highway Landscape Guide** for landscape requirements.

Landscaping shall not interfere with the visibility of “permitted” outdoor advertising in accordance with **Rule 14-40** of the **Florida Administrative Code**. Landscaping shall provide required sight distances in accordance with the **Design Standards, Index 546**. Landscaping shall also comply with the horizontal clearance requirements found in **Section 21.5.6** of this chapter, and **Chapters 2, 4, and 25** of this volume.

Community Structures placed in the right of way to represent the community are discussed in **Section 9.4** of this volume.

21.5.11 Parking

When parking is incorporated on a TDLC project, several parking configurations may be considered (parallel, front-in angled and back-in angled). The design of parking facilities should be coordinated with local transit agencies and consistent with state and local laws (including **Section 316.195, Florida Statutes**). For parking lane widths see **Table 21.1**.

21.5.12 Alternative Roadway Paving Treatments

Alternative paving treatments such as patterned/textured pavement may be used to accent the roadway in accordance with the **Standard Specifications**. Architectural pavers, however, shall not be used on the traveled way of the State Highway System. See **Section 2.1.6.1** for additional requirements.

21.5.13 Conversion to/from One-Way Street Pairs

Converting one-way pairs to two-way streets or two-way streets to one-way pairs may be appropriate on TDLC projects. These techniques require a great deal of consideration, planning and public involvement. Some considerations include: safety of pedestrians, bicyclists and motorists, traffic capacity, on-street parking, signal progression along the corridor and transit facilities.

21.6 Pedestrian and Bicycle Considerations

21.6.1 Sidewalks

For criteria refer to **Chapter 2, Section 2.1.4** and **Chapter 8** of this volume.

21.6.2 Crosswalks

Marked crosswalks should be provided at signalized intersections. Marked crosswalks should also be provided at midblock crossing locations that are controlled by traffic signals and pedestrian signals, and school crossing locations that are controlled by guards during school crossing periods. The use of uncontrolled crosswalks should be carefully considered. Refer to **Section 8.3.3** for further guidance on designing crosswalks.

21.6.3 Curb Extensions (Bulb-Outs)

Curb extensions, sometimes called bulb-outs, may be used at intersections, or at mid-block locations where there is a crosswalk, provided there is adequate width for existing traffic movements. Curb extensions shorten the crossing distance, and provide additional space at intersections allowing pedestrians to see and be seen before entering a crosswalk. The design of curb extensions must take into consideration the needs of transit vehicles, drainage and bicyclists. See **Figure 21.1**.

Figure 21.1 Curb Extension

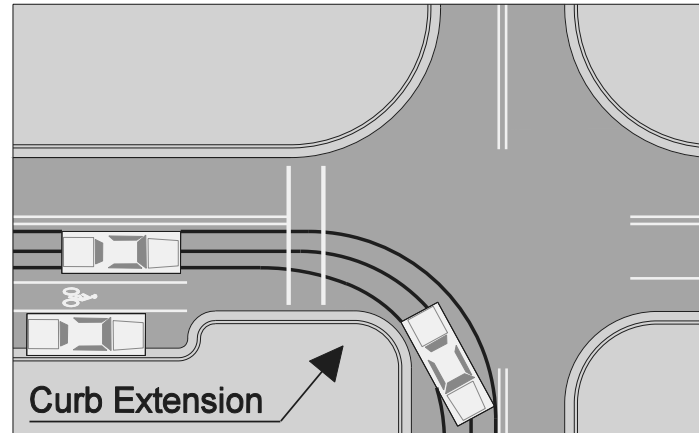

21.6.4 Personal Security and Safety Amenities

Personal security and safety is promoted by maximizing visibility in and along parking areas, building entrances, transit stops, sidewalks and roadways. This can be provided by the following techniques:

1. Providing lighting.
2. Lowering vegetation heights.
3. Removing hiding places.

Examples for designing safer communities can be found in The National Crime Prevention Council's publication: ***Crime Prevention Through Environmental Design***.

21.6.5 Bicycle Facilities

Refer to **Chapter 8** of this volume for design of bicycle facilities.

21.7 Transit-Systems and Amenities

Transit accommodations should be developed in cooperation with the local jurisdictions and transit agencies. Refer to **Chapter 8** of this volume and [Accessing Transit, Design Handbook for Florida Bus Passenger Facilities, Version 2, 2008](#) for additional information on the design of transit facilities.

Exhibit 21-A Corridor Techniques

TECHNIQUE	FIHS/SIS		SHS URBAN	SHS RURAL	NON-SHS
	LIMITED ACCESS	CONTROLLED ACCESS			
Improved location, oversized or redundant directional signs	A	A	M	M	M
Use of route markings/ signing for historical and cultural resources	M	A	A	A	A
Increased use of variable message signing	A	A	M	M	M
Landscaping	M	M	M	M	M
Sidewalks or wider sidewalks	NA	M	A	M	M
Street furniture	NA	M	M	M	M
Bicycle lanes	NA	M	M	M	M
Shared Use Paths	NA	M	M	M	M
Conversion to/from one-way street pairs	NA	M	M	NA	M
Alternative paving materials	NA	NA	M	NA	M
Pedestrian signals, midblock crossings, median refuge areas	NA	M	A	M	M
Parking modifications or restoration	NA	NA	M	M	M
Safety and personal security amenities	M	M	M	M	M
Street mall	NA	NA	NA	NA	M

- A "Appropriate"--Techniques which should be included on all TDLC projects unless there are compelling reasons not to do so.
- M "May be Appropriate"--Techniques which should be employed, but must be evaluated relative to context of the particular project.
- NA "Not Appropriate"--Techniques which need not be considered for TDLC projects.

Exhibit 21-B Techniques To Reduce Speed Or Traffic Volume

TECHNIQUE	FIHS/SIS		SHS URBAN	SHS RURAL	NON-SHS
	LIMITED ACCESS	CONTROLLED ACCESS			
Lower speed limits	NA	NA	NA	NA	N
Increase use of stop or multi-way stop signs	NA	NA	NA	NA	N
Speed humps/tables	NA	NA	NA	NA	M
On-street parking to serve as buffer between travel lanes and pedestrian areas	NA	NA	M	M	M
Curb bulb-outs at ends of blocks	NA	NA	M	M	M
Traffic “chokers” oriented to slowing traffic	NA	NA	NA	NA	M
“Compact” intersections	NA	A	A	A	A
Traffic roundabouts to facilitate intersection movement	NA	M	M	M	M
Curvilinear alignment (with redesign, chicanes, winding paths, etc.)	NA	NA	M	NA	M
Street closing or route relocation	NA	NA	M	NA	M

- A “Appropriate” --Techniques which should be included on all TDLC projects unless there are compelling reasons not to do so.
- M “May be Appropriate”--Techniques which should be employed, but must be evaluated relative to context of the particular project.
- NA “Not Appropriate”--Techniques which need not be considered for TDLC projects.

Exhibit 21-C Techniques To Encourage Multimodal Travel

TECHNIQUE	FIHS/SIS		SHS URBAN	SHS RURAL	NON-SHS
	LIMITED ACCESS	CONTROLLED ACCESS			
Sidewalks	NA	M	A	M	M
Pedestrian friendly intersection design	NA	M	A	M	M
Midblock pedestrian crossings	NA	M	M	M	M
Illuminated pedestrian crossings	NA	M	M	M	M
Bicycle lanes/paved shoulders	NA	M	A	A	M
Independent Shared Use Path	NA	M	M	M	M
Bicycle friendly design and parking	NA	M	A	A	A
Transit system amenities	NA	M	A	M	M
Transit user amenities	NA	M	A	M	M
Exclusive transit lanes	M	M	M	M	M
Linking modal facilities	A	A	A	A	A
Lower speed limits	NA	NA	NA	NA	NA
Removal of street parking	NA	NA	M	M	M

- A “Appropriate” --Techniques which should be included on all TDLC projects unless there are compelling reasons not to do so.
- M “May be Appropriate” --Techniques which should be employed, but must be evaluated relative to context of the particular project.
- NA “Not Appropriate” --Techniques which need not be considered for TDLC projects.

Exhibit 21-D Network Techniques

TECHNIQUE	FIHS/SIS		SHS URBAN	SHS RURAL	NON- SHS
	LIMITED ACCESS	CONTROLLED ACCESS			
Design the street network with multiple connections and relatively direct routes	NA	NA	A	M	M
Space through-streets no more than a half mile apart.	NA	NA	A	M	M
Use traffic calming measures	NA	M	M	M	M
Limit local speed to 20 mph	NA	NA	NA	NA	M
Limit lanes	M	M	M	M	M
Align streets to give buildings energy-efficient orientations	NA	NA	M	NA	M
Avoid using traffic signals wherever possible. Space them for good traffic progression	NA	M	M	M	M
Incorporate pedestrian and bicyclist design features	NA	A	A	A	A
Incorporate transit-oriented design	M	A	A	A	A
Design attractive greenway corridors	A	A	A	A	A
Design attractive storm water facilities	A	A	A	A	A

- A “Appropriate”--Techniques which should be included on all TDLC projects unless there are compelling reasons not to do so.
- M “May be Appropriate”--Techniques which should be employed, but must be evaluated relative to context of the particular project.
- NA “Not Appropriate”--Techniques which need not be considered for TDLC projects.

Chapter 22

Lump Sum Project Guidelines

22.1	General	22-1
22.2	Project Selection	22-2
22.3	Plans Preparation.....	22-4
22.4	Preliminary Estimate	22-5
22.5	Specifications	22-6
22.6	Contracts Administration	22-7
22.7	Construction Contract Administration.....	22-7
22.8	Materials Sampling and Testing.....	22-8
Exhibits		
Exhibit 22-A	Items of Work.....	22-9

THIS PAGE LEFT BLANK INTENTIONALLY

Chapter 22

Lump Sum Project Guidelines

22.1 General

The purpose of Lump Sum projects is to reduce the costs of design and contract administration associated with quantity calculation, verification and measurement. This contracting technique requires the Contractor to submit a lump sum price to complete a project as opposed to bidding on individual pay items with quantities provided. The Contractor will be provided a set of bid documents (plans, specifications, etc.) and will develop a Lump Sum bid for all work specified in the contract drawings.

The decision to use the Lump Sum Contracting Technique on a project should be made by the District Design Engineer in consultation with the District Construction Engineer. Lump Sum Projects should be identified during the scope development process, rather than during or after the design process. Conversion of partially complete plans and completed “plans on the shelf” that were originally developed as conventional bid item type projects to the Lump Sum Technique may require significant rework and is generally not recommended.

The contingency pay item is recommended on a Lump Sum project. This tool is used to compensate the Contractor for any additional work requested, which is not covered in the contract documents. District Construction should be consulted for the contingency amount.

22.2 Project Selection

Lump Sum contracting should be used on simple projects. “Simple” is defined by the work activity, not by the project cost. “Simple” projects are:

1. Projects with a well-defined scope for all parties (Design and Construction)
2. Projects with low risk of unforeseen conditions (i.e., projects that do not involve such things as significant underground utilities, earthwork variations, underground drainage pipes, bricks under pavement in urban areas, etc.)
3. Projects with low possibility for change during all phases of work – Design and Construction (i.e., limited possibilities for added driveways, median modifications due to developments, changes due to political involvement, etc.)

Examples of projects that may be good Lump Sum contracting candidates:

1. Bridge painting
2. Bridge projects
3. Fencing
4. Guardrail
5. Intersection improvements (with known utilities)
6. Landscaping
7. Lighting
8. Mill/Resurface (without complex overbuild requirements)
9. Minor road widening
10. Sidewalks
11. Signing
12. Signalization

Examples of projects that may not be good Lump Sum contracting candidates are listed below. Use of Lump Sum contracting on these type projects requires written approval by the State Roadway Design Engineer:

1. Urban construction/reconstruction
2. Rehabilitation of movable bridges
3. Projects with subsoil earthwork
4. Concrete pavement rehabilitation projects
5. Major bridge rehabilitation/repair projects where there are many unknown quantities
6. JPA Projects with local agency funds

22.3 Plans Preparation

Plan content should conform to the requirements of **Volume 2**, subject to the guidance provided herein. Designers should detail plans, either by detailed drawings or plan notes, to clearly describe the work to be performed by the contractor. Special care should be used to insure pay item notes and other notes and requirements such as “as directed by the Engineer” are deleted or replaced with specific direction and details that can be properly bid on by the Contractor. Following are some of the desired elements in a set of Lump Sum plans:

1. Typical Sections.
2. Milling, resurfacing and overbuild details to show any cross slope corrections, including existing pavement cross slope information.
3. Summary Boxes to define work when work is not shown on the plan sheets (i.e., Summary of Side Drain and Mitered Ends, Summary of Guardrail/Removal, Summary of Mailbox replacement, etc.) The standard summary boxes contained in the FDOT CADD Cell Library should be used. Note -- Summary boxes should not have totals shown at the bottom of each box. Summary boxes are not required when plan details sufficiently describe the work, however for bridge projects, concrete and reinforcing steel quantities for individual bridge components are required to be shown in quantity blocks in the plans.
4. Plan sheets to accurately depict existing conditions and detail all work to be performed by contractor. (i.e., show all limits of milling and resurfacing, pipe installations, limits of sod when different from typical section, all concrete work, guardrail removal/installation, etc.).
5. Details of work not covered by typical section or the **Design Standards** (i.e., curb and gutter installation, traffic separator limits, special curb ramps, modifications to storm inlets, etc.).
6. Cross sections when shoulder point is moved. When cross sections are provided, earthwork columns and earthwork summaries and totals should be left blank since earthwork quantities are not to be shown in the plans.
7. Anticipated pile tip/drilled shaft elevations on bridge projects. Note: This is the predicted elevation to achieve axial capacity and satisfy all other design requirements and is usually deeper than the minimum tip elevation shown for piles.

No computation book is prepared.

Signing and Pavement Marking, Lighting, and Signalization plan sheets shall continue to contain pay item numbers to be used for reference purposes only. Conduit lengths on conduit pay items should not be shown. A note should be placed on each sheet that states, "Pay item numbers are provided only for the purpose of describing the work to be performed. Pay item descriptions are found in the Department's ***Basis of Estimates Manual***." Signing and Pavement Marking, Lighting, and Signalization plans should NOT have any Tabulation of Quantities sheets included in the contract plans. For projects that include new asphalt surfaces, a note should be placed in the Signing and Pavement Marking Plans that states, "All pavement markings shall be paint unless otherwise noted in the plans."

22.4 Preliminary Estimate

If there is only one project in the contract, the designer will code in the pay item for Lump Sum (Alternative Bidding) (999-2) and the Initial Contingency Amount (Do Not Bid) Pay item (999-25). If there is more than one project in a single contract (strung projects), the designer will code both pay items on each project.

The designer shall provide data to the District Estimates Office to be used in the estimate process. The data necessary for preparing the preliminary estimate may differ with project type and complexity. Preliminary estimates for Lump Sum projects may be determined in a number of ways: data from the designer, historic data, long-range estimate (LRE), and by reviewing data from similar, current projects. The intent of Lump Sum Contracting is not to shift the responsibilities or work involved in estimating quantities from the designer to the District Estimates Office. The cooperative effort of the designer in providing data in an electronic spreadsheet or other means acceptable to the District Estimates Office will be helpful in improving the Lump Sum Preliminary Estimate Process. Contact the appropriate District for specific requirements.

22.5 Specifications

The Design Project Manager will provide an “Items of Work” checklist to the District Specifications Office. The Specifications Office will include the work items identified on the checklist in the “Intent and Scope” in the Specifications Package. The checklist shall include, as a minimum, the major work items shown in the sample included with these guidelines.

Lump Sum Projects require Special Provisions that modify the first nine articles of the Standard Specifications. These Special Provisions are in the Specifications Workbook and must be included as part of the Specifications package.

Article 9-2 of the Special Provisions for Lump Sum Projects shall be completed with predetermined unit prices for asphalt materials, concrete, and base when applicable. These unit prices will serve as a basis for calculating pay reductions for deficiencies accepted by the Engineer. In the case of asphalt overbuild, the predetermined unit price for the material used for overbuild will serve as a basis for pay adjustments for thicknesses that differ from the thickness shown in the plans. All predetermined unit prices should be based on an analysis of similar type projects let in the District and/or the District wide average of projects let within the six months prior to the letting date of the project.

For projects including bridges, Article 9-2 of the Special Provisions for Lump Sum Projects shall be completed with predetermined unit prices for piling and/or drilled shafts as applicable. These unit prices will serve as a basis for pay adjustments for the actual quantities installed as additions or deletions from the individual element lengths shown in the plans. All predetermined unit prices should be based on an analysis of similar type projects let in the District and/or the District wide average of projects let within the six months prior to the letting date of the project.

22.6 Contracts Administration

Contracts Administration shall include the information provided in the Specifications Package “Intent and Scope” in the job advertisement. This information can be used by the contractors/subcontractors to determine what type of work is contained in the project, in lieu of a list of pay items.

22.7 Construction Contract Administration

Monthly payments will be made based on a payout schedule mutually agreed upon by the Department and the Contractor. The payout schedule will include only major tasks similar to what has been used on design-build projects.

Lump Sum contracts are not fixed price. Changed conditions, extra work and unforeseen work must be negotiated and resolved with the Contractor utilizing Supplemental Agreements and/or Work Orders on Contingency Supplemental Agreements.

Construction inspection personnel should not be required to document quantities except for asphalt and other items subject to pay adjustments (items with predetermined unit prices). Measurement and completion of “Final” quantity for summary boxes on plan sheets is not required. Focus should be on inspection and achieving a quality final product. For example, the project engineer will not be concerned with how many square yards of sod it takes or the number of miles of final striping. The project engineer will be charged with ensuring that the sod, striping, embankment, pipe, etc., meets the lines and grades of the plans and specifications.

22.8 Materials Sampling and Testing

The Laboratory Information Management System (LIMS), relies on the pay items identified in TRNS*PORT to generate a Job Guide Schedule based on the ***Sampling, Testing and Reporting Guide (STRG)***. On Lump Sum projects, since there is no detailed pay item list to identify the various types of work, LIMS will output a generic Job Guide Schedule. Some materials will not actually be used depending on the project scope. Personnel should use the Job Guide Schedule entries applicable to their project and input sample data and field test results into LIMS system in accordance with standard procedures. Materials not included on the Job Guide Schedule will be accepted in accordance with ***Section 6 of the FDOT Specifications*** and/or other pertinent contract documents.

**Exhibit 22-A Items of Work
(Sheet 1 of 2)**

DATE: _____

TO: _____, District Specifications

FROM: _____, Project Manager

COPIES TO:

SUBJECT: ITEMS OF WORK

Financial Project ID: _____ (GOES WITH _____)

County (Section): _____

* Project Description: _____

The plans package for the above referenced project includes the following items of work to be performed:

_____	Milling & Resurfacing	_____	Highway Signing
_____	Base Work	_____	Guardrail
_____	Shoulder Treatment	_____	Landscaping
_____	Drainage Improvements	_____	Box or Three-sided Culverts
_____	Curb & Gutter	_____	Bridges
_____	Traffic Signals	_____	MSE Walls
_____	Lighting	_____	Sidewalks/Shared Use Path
_____	Other (Please Specify) _____		

Please include the county, project description and all items of work that apply in the *Intent and Scope* so they may be added to the advertisement description.

* The project description should only include the road number and the limits or location of the project.

Exhibit 22-A Items of Work, Sheet 2 of 2
Example

DATE: June 4, 2010

TO: _____, District Specifications

FROM: _____, Project Manager

COPIES TO:

SUBJECT: ITEMS OF WORK

Financial Project ID: 123456-1-52-01 (GOES WITH _____)

County (Section): St. Johns (78010)

Project Description: SR 5/US 1 in St. Johns County from SR 312 to 1.250 miles North of SR 16

The plans package for the above referenced project includes the following items of work to be performed:

- | | | | |
|-------------------------------------|------------------------------|-------------------------------------|-----------------------------|
| <input checked="" type="checkbox"/> | Milling & Resurfacing | <input checked="" type="checkbox"/> | Highway Signing |
| <input checked="" type="checkbox"/> | Base Work | <input type="checkbox"/> | Guardrail |
| <input type="checkbox"/> | Shoulder Treatment | <input type="checkbox"/> | Landscaping |
| <input checked="" type="checkbox"/> | Drainage Improvements | <input type="checkbox"/> | Box or Three-sided Culverts |
| <input checked="" type="checkbox"/> | Curb & Gutter | <input type="checkbox"/> | Bridges |
| <input checked="" type="checkbox"/> | Traffic Signals | <input type="checkbox"/> | MSE Walls |
| <input type="checkbox"/> | Lighting | <input type="checkbox"/> | Sidewalks/Shared Use Path |
| <input type="checkbox"/> | Other (Please Specify) _____ | | |

Chapter 23

Exceptions and Variations

23.1	General	23-1
23.2	Identification	23-2
23.3	Approval	23-3
23.4	Justification for Central Office Approval	23-5
23.5	Documentation for Central Office Approval.....	23-6
23.6	Central Office Submittal and Approval	23-10
23.7	Central Office Denial and Resubmittal	23-12
23.8	Design Variations Needing District Approval Only	23-12
23.9	AASHTO Criteria for Controlling Design Elements	23-13

Tables

Criteria Tables Cross Reference.....	23-13
--------------------------------------	-------

Exhibits

Exhibit 23-A	Submittal/Approval Letter.....	23-22
--------------	--------------------------------	-------

THIS PAGE LEFT BLANK INTENTIONALLY

Chapter 23

Exceptions and Variations

23.1 General

The Department's roadway design criteria and standards are contained in this volume and are usually within the desirable ranges established by AASHTO. The values given in this volume have been accepted by FHWA and govern the design process. When it becomes necessary to deviate from the Department's criteria, early documentation and approval are required. There are three approval processes: Design Exceptions, Utility Exceptions and Design Variations. When the Department's criteria are met, no Design Exception, Utility Exception or Design Variation is required. However, when the Department's criteria are not met, a Design Exception, Utility Exception or Design Variation is required. This requirement applies to all entities affecting planning, design, construction, maintenance and utilities.

For projects using safety funds and developed to improve specific safety problems, only the elements identified under the scope of work for the safety improvement project are subject to these approval processes. The existing features, within the limits of the safety improvement project that do not meet design criteria do not require approval to remain.

Maintenance Resurfacing, Ride Rehabilitation and Skid Hazard Projects do not require Design Exceptions or Variations other than for ADA curb ramp requirements. If compliance with ADA curb ramp requirements is determined to be technically infeasible, documentation as a Design Variation is required. Maintenance Resurfacing Projects can only be programmed on routes that meet the requirements identified in the [Work Program Instructions \(Chapter 28\)](#).

23.2 Identification

To allow time to research alternatives and begin the analysis and documentation activities, it is important proper approval process be identified as early in the Planning and Design as possible. This is preferably done during the PD&E process for major projects and the scope development process for minor projects. It is required that approval be obtained no later than the initial engineering phase.

Design Exceptions are required when the proposed design elements (other than utility elements) are below both the Department's governing criteria and AASHTO's new construction criteria for the 13 Controlling Design Elements.

The 13 Controlling Design Elements are:

1. Design Speed
2. Lane Widths
3. Shoulder Widths
4. Bridge Widths
5. Structural Capacity
6. Vertical Clearance
7. Grades
8. Cross Slope
9. Superelevation
10. Horizontal Alignment
11. Vertical Alignment
12. Stopping Sight Distance
13. Horizontal Clearance

Section 23.9 provides AASHTO's minimum requirements for the above elements.

Utility Exception requirements are found in the ***Utility Accommodation Manual (UAM)***.

Design Variations are required when proposed design elements are below the Department's criteria and where a Design Exceptions or Utility Exception is not required.

23.3 Approval

All required approvals shall be obtained as described in this section. Approvals from multiple individuals may be required for certain issues. The Director of Design shall resolve any approval authority issues if conflicting objectives arise.

Approval is required from the State Chief Engineer for the following:

- Design Exceptions for Design Speed on FIHS/SIS facilities (following review by the State Transportation Planner).
- Utility Exceptions for limited access R/W use.
- Design Variations for Design Speed on FIHS/SIS facilities (following review by the State Transportation Planner).

Approval is required from the FHWA Division Administrator for the following:

- Design Exceptions on full FHWA oversight projects.
- Design Exceptions, Utility Exceptions and Design Variations for vertical clearance over an interstate roadway less than 16 feet.
- Exceptions involving horizontal or vertical clearances for railroads not meeting the requirements of **Rule 14-57 F.A.C.** or the clearance criteria for the South Florida Rail Corridor (**Topic No. 000-725-003 - South Florida Rail Corridor Clearance Policy for 25 KV service**).

Approval is required from the District Design Engineer or Turnpike Design Engineer for the following:

- Design Exceptions.
- Utility Exceptions.
- Design Variations.

Approval is required from the State Roadway Design Engineer for the following:

- Design Exceptions for elements other than Structural Capacity.
- Utility Exceptions.
- Design Variations involving modifications to or elimination of required rumble strips.

Approval is required from the State Structures Design Engineer for the following:

- Design Exceptions for Bridge Width, Structural Capacity, Horizontal Clearance and Vertical Clearance impacting Category 1 and 2 structures.
- Utility Exceptions impacting Category 2 structures, or impacting Category 1 structures with controlling elements below AASHTO's criteria.
- Design Variations for Bridge Width, Structural Capacity, Horizontal Clearance and Vertical Clearance impacting Category 2 structures.
- Design Variations for Structural Capacity due to deficient load ratings impacting both Category 1 and 2 structures

Approval is required from the District or Turnpike Structures Design Engineer for the following:

- Utility Exceptions impacting Category 1 structures, with none of the 13 Controlling Design Elements below AASHTO's Criteria.
- Design Variations for Bridge Width, Structural Capacity, Horizontal Clearance and Vertical Clearance impacting Category 1 Structures.

23.4 Justification for Central Office Approval

Sufficient detail and explanation must be given in order to build a strong case to those reviewing the request. The 13 Controlling Design Elements are considered safety related and the strongest case must be made to lower these requirements. At some point, this justification may be used to defend the Department's and/or the designer's design decisions. All deviations must be uniquely identified, located, and justified; no blanket approvals are given.

A strong case can be made if it can be shown that:

- The required criteria are not applicable to the site specific conditions.
- The project can be as safe by not following the criteria.
- The environmental or community needs prohibit meeting criteria.

Most often a case is made by showing the required criteria are impractical and the proposed design wisely balances all design impacts. The impacts usually compared are:

- Operational Impacts.
- Impacts on Adjacent Section.
- Level of Service.
- Safety Impacts.
- Long term effects.
- Costs.
- Cumulative Effects.

A case should not be made based solely on the basis that:

- The Department can save money.
- The Department can save time.
- The proposed design is similar to other designs.

23.5 Documentation for Central Office Approval

During the justification process supporting documentation will be generated which needs to accompany each submittal. This documentation includes, but is not limited to the following:

Utility Exception documentation requirements are found in ***Chapter 13 of the Utility Accommodation Manual (UAM)***.

All Design Variations needing Central Office approvals and all Design Exceptions should include the following documentation:

- a) ***Exhibit 23-A*** Submittal/Approval Letter Included (Cover Letter)
- b) Summary description of included support documentation such as:
 - 1) Location map or description,
 - 2) Typical section,
 - 3) Aerial or Photo logs when they best illustrate the element issues,
 - 4) Crash History and analysis,
 - 5) Plan sheets in the area of the exception/variation elements,
 - 6) Profiles in the area of vertical alignment exception/variation elements,
 - 7) Tabulation of pole offsets for horizontal clearance exception/variation, and
 - 8) Any Applicable Signed and Sealed Engineering Support Documents.
- c) Project description (general project information, typical section, begin/end milepost, county section number). Include Work Mix, To – From, Objectives, Obstacles and Schedule.
- d) Description of the exception/variation element and applicable criteria (AASHTO and Department value or standard). Detailed explanation of why the criteria or standard cannot be complied with or is not applicable. Description of any proposed value for project and why it is appropriate.
- e) Amount and character of traffic using the facility. Description of the anticipated impact on Operations, Adjacent Sections, Level Of Service, Safety, Long and Short Term Effects. (Is the Exception temporary or permanent?) Description of the anticipated Cumulative Effects.

- f) A plan view or aerial photo of the exception location, showing right of way lines, and property lines of adjacent property.
- g) A photo of the area.
- h) Typical section or cross-section of exception location.
- i) The milepost and station location of the exception.
- j) Any related work programmed or in future work plans.
- k) The Project Schedule Management (PSM) Project Schedule Activities maintained by the Finance Management Office.
- l) All mitigating efforts. An explanation of what if any associated existing or future limitations as a result of public or legal commitments. Description and explanation of any practical alternatives, the selected treatment and why.
- m) Comments on the most recent 5-year crash history including all pertinent crash reports.
- n) Description of the anticipated Cost (Social and to the Department - Benefit/Cost)
- o) Summary Conclusions

For the specified conditions the following additional documentation is required:

- p) For design speed on FIHS/SIS, provide typical sections at mid blocks and at intersections.
- q) For lane width, provide locations of alternative routes that meet criteria and a proposal for handling drainage, the proposed signing and pavement markings.
- r) For shoulder width, provide a proposal for handling stalled vehicles and a proposal for handling drainage.
- s) For bridge width, provide a plan view of the approaching roadways and existing bridge plans (these may be submitted electronically).
- t) For a bridge with a design inventory load rating less than 1.0, a written evaluation and recommendation by the Office of Maintenance is required. Provide the load rating calculations for the affected structure.

- u) For vertical clearance, provide locations of alternative routes that meet criteria.
- v) For cross-slope, provide a proposal for handling drainage and details on how the cross slope impacts intersections.
- w) For conditions that may adversely affect the roadway's capacity, provide the comments on compatibility of the design and operation with the adjacent sections. Effects on capacity (proposed criteria vs. AASHTO) using an acceptable capacity analysis procedure and calculate reduction for design year, level of service).
- x) For superelevation, provide the side friction factors for the curve for each lane of different cross-slope at the PC of the curve, the point of maximum cross-slope, and the PT of the curve using the following equation.

$$f = \frac{V^2 - 15Re}{V^2e + 15R} \quad \text{where} \quad \begin{array}{l} f = \text{Side Friction Factor} \\ V = \text{Design Speed (mph)} \\ R = \text{Radius (feet)} \\ e = \text{Superelevation (ft/ft) at the station evaluated} \end{array}$$

- y) For areas with crash histories or when a benefit to cost analysis is requested, provide a time value analysis between the benefit to society quantified in dollars and the costs to society quantified in dollars over the life of the exception.

In general practice the benefit to society is quantified by the reduction in crash cost foreseeable because of the proposed design and the cost due to the implementation of that change such as construction and maintenance costs over the life of the project. This analysis may be performed by using either the Roadside Safety Analysis Program (RSAP), available through AASHTO's publications, or the Historical Crash Method (HCM) depending on their applicability. The RSAP is applicable to crashes into roadside objects and the HCM is applicable to sites with a crash history. Use a 5% time value of money for both the RSAP and HCM methods.

The Historical Crash Method (HCM) uses the following **Highway Safety Improvement Program Guideline (HSIPG)** cost per crash by facility type to estimate benefit to society while the cost to society is estimated by the cost of right of way, construction, and maintenance.

HSIPG COST/CRASH BY FACILITY TYPE						
FACILITY TYPE	DIVIDED			UNDIVIDED		
	URBAN	SUBURBAN	RURAL	URBAN	SUBURBAN	RURAL
2-3 Lanes	\$81,811	\$155,553	\$264,712	\$86,904	\$234,543	\$415,498
4-5 Lanes	\$110,711	\$178,106	\$372,912	\$82,383	\$208,402	\$98,611
6+ Lanes	\$111,009	\$129,514	\$355,024	n/a	n/a	n/a
Interstate	\$147,368	n/a	\$319,974	n/a	n/a	n/a
Turnpike	\$134,254	n/a	\$212,792	n/a	n/a	n/a

All State Roads Average Cost/Crash: **\$146,558**

*The above values were derived from 2005, 2006, and 2007 traffic crash and injury severity data for crashes on state roads in Florida, using the formulation described in ***FHWA Technical Advisory "Motor Vehicle Accident Costs", T 7570.1, dated June 30, 1988*** and ***FHWA Technical Advisory, T 7570.2, dated October 31, 1994*** using updated fatality cost of \$5.8 million as recommended in the U.S. Department of Transportation ***Office of Secretary Transportation memo, Treatment of the Economic Value of a Statistical Life in Department Analysis dated February 5, 2008*** (<http://ostpxweb.dot.gov/policy/reports/080205.htm>).

23.6 Central Office Submittal and Approval

Submittals, when complete, shall contain 3 parts, and shall be compiled in the same order as addressed below.

1. Part 1 shall consist of a cover letter. The cover letter shall be either the ***Plans Preparation Manual Volume 1, Exhibit 23-A Submittal/Approval Letter*** for Design Exceptions or the ***Utility Accommodation Manual Exhibit A Utility Exception Form***. If both types of Exceptions are contained in a single submittal, both forms must be completed and submitted in the same package. They shall not be combined on a single form.
2. Part 2 shall consist of the justification or report proper including all signed and sealed documents. Part 2 may contain or require more than one separately signed and sealed report. An example is a single submittal that includes a structural analysis and a roadway geometry analysis. There may also be documents or discussions that are not within the bounds of individually signed and sealed analysis.
3. Part 3 shall consist of any support documents to facilitate an understanding of Part 2. Note that Part 3 may include any supplementary documentation developed or added by the Central Office after the District submittal. This shall be considered a part of the submittal justification package and is provided only to assist the District in getting a favorable and timely review and approval. Any supplemental documents provided by the Central Office will be appended and shall not alter the Engineer of Record's analysis or design.

The report justifying and documenting a request is to be sealed by the Responsible Engineer in accordance with **Chapter 19** of this volume. The Responsible Engineer then attaches a Submittal/Approval Letter (***Exhibit 23-A***) to the Sealed Report and submits them to the District or Turnpike Design Engineer. The District or Turnpike Design Engineer then approves or denies the request and notifies the Responsible Engineer. When further approvals are required the District or Turnpike Design Engineer will forward the Submittal/Approval Letter and Sealed Report to the State Roadway Design Office.

The State Roadway Design Office will assign reference numbers to each request. The request will be reviewed then forwarded for approval to the Chief Engineer, the State Roadway Design Engineer, the State Structures Design Engineer, the Planning Office and/or FHWA as appropriate.

Each request will be reviewed on a case by case basis and approved on its merits. When approval is obtained the Roadway Design Office will e-mail the District or Turnpike Design Engineer the Central Office's disposition and return the signed Submittal/Approval Letter and Sealed Report. The Roadway Design Office will keep a copy filed under the assigned reference number. Additional copies will be provided upon request.

23.7 Central Office Denial and Resubmittal

When a request is denied, the State Roadway Design Office will notify the District or Turnpike Design Engineer of the Central Office's disposition.

Denied requests can be resubmitted when all deficiencies, noted in the denial notification, have been addressed. This may require only a new Submittal/Approval Letter if the Sealed Report does not need to be amended. However, if the Sealed Report requires revision, a new Sealed Report and attached Submittal/Approval Letter must be submitted.

The State Roadway Design Office will assign the resubmittal a tracking reference number. The resubmittal will be reviewed for completeness and forwarded for approval to the Chief Engineer, the State Roadway Design Engineer, the Structures Design Engineer, the Planning Office and/or FHWA as appropriate.

23.8 Design Variations Needing District Approval Only

For Design Variations needing District approval only, the following is the minimum justification and documentation required. However, on a case by case basis the District approvers may require more or may opt for the Design Variation to follow **Sections 23.4-7**.

A Design Variation request must address the following items:

1. Design criteria versus proposed criteria.
2. Reason the design criteria are not appropriate.
3. Justification for the proposed criteria.
4. Any background information which documents or justifies the request.

The Responsible Engineer then attaches a Submittal Approval Letter (**Exhibit 23-A**) to the sealed report and submits them to the District or Turnpike Design Engineer. The District or Turnpike Design Engineer then approves or denies the request and notifies the Responsible Engineer.

Design Variations requiring Central Office approval from the State Chief Engineer, State Roadway Design Engineer, and/or the State Structures Design Engineer (see **Section 23.3**) follow the processes in **Sections 23.4-7**.

23.9 AASHTO Criteria for Controlling Design Elements

As an aid to the designer, the following tables may be used as a reference for determining when a Design Exception is required based on AASHTO criteria, but are in no way intended to replace Department design criteria. The page numbers referenced are to AASHTO's *A Policy on Geometric Design of Highways and Streets 2004* (unless otherwise noted) and are a starting point for researching project criteria. Please note that the criteria used for determining exceptions on Interstate projects must be based on AASHTO's *A Policy on Design Standards Interstate System*.

Criteria Tables Cross Reference

Table Number	Title	Page
Table 23.9.1	AASHTO Design Speed (Minimum).....	23-14
Table 23.9.2	AASHTO Lane Widths (Minimum)	23-15
Table 23.9.3	AASHTO Shoulder Widths (Minimum)	23-15
Table 23.9.4	AASHTO Bridge Widths (Minimum)	23-16
Table 23.9.5	AASHTO Structural Capacity (Minimum Loadings).....	23-17
Table 23.9.6	AASHTO Vertical Clearance (Minimum)	23-17
Table 23.9.7	AASHTO Grades (Minimum and Maximum)	23-18
Table 23.9.8	AASHTO Cross Slope (Minimum and Maximum).....	23-18
Table 23.9.9	AASHTO Superelevation (Maximum).....	23-19
Table 23.9.10	AASHTO Horizontal Alignment.....	23-19
Table 23.9.11	AASHTO Vertical Alignment	23-20
Table 23.9.12	AASHTO Stopping Sight Distance	23-20
Table 23.9.13	AASHTO Horizontal Clearance (Minimum).....	23-21

Table 23.9.1 AASHTO Design Speed (Minimum)

Type Facility	Other Factors	Design Speed (mph)	AASHTO	
Freeways	Urban	50	pg. 503	
	Rural	70		
Urban Arterials	Major	30	pg. 72	
	Other	30		
Rural Arterials	Rolling terrain	50	pg. 444	
	Level terrain	60		
Urban Collectors		30	pg. 430	
Rural Collectors	Level	ADT < 400	pg. 422, Exh. 6-2	
		ADT 400 - 2000		
		ADT > 2000		
	Rolling	ADT < 400		
		ADT 400 - 2000		
		ADT > 2000		
CBD	Major or Minor	30	pg. 430	
Ramps	Highway Design Speeds (mph)		pg. 826	
		30		15
		35		18
		40		20
		45		23
		50		25
		55		28
		60		30
		65		30
		70		35
Loop Ramps	150 ft. radius	25	pg. 825	
Connections	Direct	40	pg. 825	
	Semi-Direct	30		

Table 23.9.2 AASHTO Lane Widths (Minimum)

Type Facility	Lane Width (feet)	AASHTO
Freeways (including Auxiliary lanes)	12	pg. 504, 814, DSIS pg.3 ⁽¹⁾
Rural Arterials	11	pg. 448, Exh. 7-3
Urban Arterials	10	pg. 472
Urban Collectors	10	pg. 433
Rural Collectors	10	pg. 425, Exh. 6-5
Low Speed	10	pg. 312
Residential	9	pg. 312
Auxiliary (all but Freeway)	10	pp. 312, 433
Continuous TWLTL	10	pg. 312

1. DSIS = AASHTO's *A Policy on Design Standards Interstate System* (January 2005).

Table 23.9.3 AASHTO Shoulder Widths (Minimum)

Type Facility	Other Factors	Right (feet)	Median (feet)	AASHTO
Freeways	4 lanes	10	4	pg. 505
	≥ 6 lanes	10	10	pg. 505
Rural Arterial	ADT > 2000	8		pg. 448, Exh. 7-3
	ADT 400-2000	6		
	ADT < 400	4		
	Divided highway 4 lanes	8	4 paved	pg. 455
	Divided highway 6 lanes	8	8	pg. 456
Urban Arterial	Low Type	2		pg. 314
	High Type	10		pg. 314
Heavily Traveled	High Speed (≥ 50 mph)	10		pg. 314
Rural & Urban Collectors	ADT > 2000	8		pg. 425, Exh. 6-5
	ADT 1500-2000	6		
	ADT 400-1500	5		
	ADT < 400	2		

Table 23.9.4 AASHTO Bridge Widths (Minimum)

Type Facility	Other Factors	Bridge Widths	AASHTO
Freeways	New Bridges	Approach Roadway Width	pg. 506
Rural Arterials	New Bridges (Short)	Approach Roadway Width	pg. 447
	New Long Bridges (> 200 ft.)	Travel Lanes + 4 ft. each side	pg. 447
	Remain in Place	Travel Lanes + 2 ft. each side	pg. 447
Urban Arterials	Long (> 200 ft.), where shoulders or parking lanes are provided on the arterial	Travel Lanes + 4 ft. each side	pg. 481
	All new bridges	Curb to curb width of street	pg. 481

Type Facility	Other Factors	Bridge Widths		AASHTO
		New or Reconstruction	To Remain	
Rural and Urban Collectors	Under 400 ADT	Traveled Way + 2 ft. each side ⁽¹⁾	22 ft. ⁽²⁾	pp. 426, 427
	ADT 400-1500	Traveled Way + 3 ft. each side ⁽¹⁾	22 ft. ⁽²⁾	pp. 426, 427
	ADT 1500-2000	Traveled Way + 4 ft. each side ^{(1),(3)}	24 ft. ⁽²⁾	pp. 426, 427
	ADT > 2000	Approach Roadway Width ^{(1),(3)}	28 ft. ⁽²⁾	pp. 426, 427

1. If the approach roadway has paved shoulders, then the surfaced width shall be carried across the bridge.
2. Bridges longer than 100 ft. are to be analyzed individually.
3. For bridges > 100 ft. in length, the minimum bridge width of traveled way plus 3 ft. on each side is acceptable.

Table 23.9.5 AASHTO Structural Capacity (Minimum Loadings)

Type Facility	AASHTO
All Facilities	See <i>AASHTO LRFD</i> for minimum loadings.

Table 23.9.6 AASHTO Vertical Clearance (Minimum)

Type Facility	Vertical Clearance (feet)	AASHTO
Freeways	16 ^{(1),(2)}	pp. 506, 507, 763, 764
Arterials: Rural	16 ^{(1),(2)}	pp. 447, 763, 764
Urban	16 ^{(1),(2)}	472, 763, 764
Other Highways	14 ⁽²⁾	pp. 385, 507
Sign Trusses	17 ⁽²⁾	pg. 507
Pedestrian Overpass	17 ⁽²⁾	pg. 507
Tunnels: Freeways	16 ⁽²⁾	pg. 355
Other	14 ⁽²⁾	pg. 355
Highways		
Railroads	23 ^{(2),(3),(4)}	pg. 522

1. 14 feet allowed in highly developed urban areas if alternate route has 16 feet.
2. Minimum value that can be used without a Design Exception. An allowance of 6 inches should be added to vertical clearance to accommodate future resurfacing.
3. Over High Speed Rail Systems: See Department guidelines and specifications for Intermediate Class Rail Operations entitled ***Standard Specifications for the Design and Construction of Railways***.
4. Over Electrified Railroad: The minimum vertical clearance shall be 24 feet 3 inches. This provision is based on FDOT Policy for 25 kV service: ***South Florida Rail Corridor Clearance (Topic No. 000-725-003)***

Table 23.9.7 AASHTO Grades (Minimum and Maximum)

Maximum Grades

Type Facility	Type Terrain	Grades (%) For Design Speed (mph)									AASHTO
		30	35	40	45	50	55	60	65	70	
Freeway ⁽¹⁾	Level	---	---	---	---	4	4	3	3	3	pg. 506, Exh. 8-1
	Rolling	---	---	---	---	5	5	4	4	4	
Rural Arterial	Level	---	---	5	5	4	4	3	3	3	pg. 446, Exh. 7-2
	Rolling	---	---	6	6	5	5	4	4	4	
Urban Arterial:	Level	8	7	7	6	6	5	5	---	---	pg. 472, Exh. 7-10
	Rolling	9	8	8	7	7	6	6	---	---	
Rural Collector ⁽²⁾	Level	7	7	7	7	6	6	5	---	---	pg. 423, Exh. 6-4
	Rolling	9	9	8	8	7	7	6	---	---	
Urban Collector ⁽²⁾	Level	9	9	9	8	7	7	6	---	---	pg. 432, Exh. 6-8
	Rolling	11	10	10	9	8	8	7	---	---	

- Grades one percent steeper than the values shown may be used for extreme cases in urban areas where development precludes the use of flatter grades and for one-way downgrades.
- Short lengths of grade in rural and urban areas, such as grades less than 500 ft. in length, one-way downgrades, and grades on low-volume rural and urban collectors may be up to 2 percent steeper than the grades shown above.

Minimum Grades for Urban Curb & Gutter

Type Facility	Minimum %	AASHTO
Arterials	as required for adequate drainage	pg. 471
Collector Roads & Streets	0.30	pg. 431
Local Roads & Streets	0.20	pg. 391

Table 23.9.8 AASHTO Cross Slope (Minimum and Maximum)

Type Facility	Other Factors	Minimum	Maximum	AASHTO
Freeways	---	0.015	0.025 ⁽¹⁾	pg. 504
Arterials	Rural	0.015	0.02 ⁽¹⁾	pg. 446 pg. 472
	Urban	0.015	0.03	
Divided Highways	---	0.015	0.02 ⁽¹⁾	pg. 455
Collectors	Rural	0.015	0.02 ⁽¹⁾	pg. 421 pg. 431
	Urban	0.015	0.03	
Shoulders	Paved	0.02	0.06	pg. 316 pg. 316 pg. 316
	Gravel	0.04	0.06	
	Turf	0.06 ⁽²⁾	0.08 ⁽²⁾	

- Values given are for up to two lanes in one direction. Additional outside lanes may have cross slopes of 0.03.
- Shoulder cross slopes which meet FDOT criteria do not require a Design Exception.

Table 23.9.9 AASHTO Superelevation (Maximum)

Type Facility	Superelevation Rate	AASHTO
Highways (Rural)	0.12	pg. 144
Urban	0.06	pg. 145
Low Speed Urban w/severe constraints	None	pg. 145
Ramps and Turning Roadways at Intersections	0.10	pg. 639

Table 23.9.10 AASHTO Horizontal Alignment

Minimum Radius (feet) with Superelevation (page 147, Exh. 3-15)

Type Facility	Super-elevation e-max	Minimum Curve Radius (feet) for Design Speed (mph)											
		15	20	25	30	35	40	45	50	55	60	65	70
Rural Highways and High Speed Urban Streets	0.04	42	86	154	250	371	533	711	926	1190	1500	---	---
	0.06	39	81	144	231	340	485	643	833	1060	1330	1660	2040
	0.08	38	76	134	214	314	444	587	758	960	1200	1480	1810
	0.10	36	72	126	200	292	410	540	694	877	1090	1340	1630
	0.12	34	68	119	188	272	381	500	641	807	1000	1220	1480

Minimum Radius (feet) for Section with Normal Cross Slope (2001 AASHTO, page 168, Exh. 3-26)

Type Facility	Minimum Curve Radius (feet) for Design Speed (mph)											
	15	20	25	30	35	40	45	50	55	60	65	70
All	960	1700	2460	3350	4390	5570	6880	8350	9960	11720	13180	14730

Minimum Radius (feet) for Intersection Curves (2001 AASHTO, page 201, Exh. 3-43)

Design Speed (MPH)	10	15	20	25	30	35	40	45
Minimum Radius (feet)	25	50	90	150	230	310	430	540
Assumed Minimum Superelevation Rate	0.02	0.02	0.02	0.04	0.06	0.08	0.09	0.10

Minimum Passing Sight Distance (feet) (page 124, Exh. 3-7)

Design Speed (mph)	20	25	30	35	40	45	50	55	60	65	70
Passing Sight Distance	710	900	1090	1280	1470	1625	1835	1985	2135	2285	2480

Table 23.9.11 AASHTO Vertical Alignment

(Taken from page 272 Exh. 3-72, page 277 Exh. 3-75, and page 422 Exh. 6-2)

Design Speed (mph)	K Value ⁽¹⁾ for Vertical Curves Rounded for Design	
	Crest	Sag
15	3	10
20	7	17
25	12	26
30	19	37
35	29	49
40	44	64
45	61	79
50	84	96
55	114	115
60	151	136
65	193	157
70	247	181

1. Rate of vertical curvature, K, is the length of curve per percent algebraic difference in the intersecting grades.

Table 23.9.12 AASHTO Stopping Sight Distance

(Taken from page 112, Exh. 3-1)

Design Speed (mph)	Stopping Sight Distance (feet) Computed for Design
15	80
20	115
25	155
30	200
35	250
40	305
45	360
50	425
55	495
60	570
65	645
70	730

Table 23.9.13 AASHTO Horizontal Clearance (Minimum)

Feature	Clearance	AASHTO
Bridges	See Table 23.9.4	---
Tunnels	2.5 ft. from edge of traffic lane	pg. 354, Exh. 4-17
Underpasses	2-lane: (1) Normal shoulder width (to edge of barrier) Divided Roadway: Normal shoulder (outside or median) width (to edge of barrier) (1)	pg. 762, Exh. 10-6
Barrier Wall & Guardrail	Normal shoulder width	pg. 762, Exh. 10-6
Light Poles (2)	Rural: Outside clear zone (if non-breakaway) Urban: 1.5 ft. from face of curb	pg. 291 pg. 319
Trees greater than 4 inches in diameter measured 6 inches above the ground	Rural Arterials: Outside clear zone Collectors ≤ 45 mph: 10 ft. from traveled way Collectors > 45 mph: Outside clear zone Urban: 1.5 ft. from face of curb Freeways (Rural and Urban): Outside clear zone	pg. 399, 481 pg. 427 pg. 427 pg. 399, 437, 481 pg. 507
Sign supports	Outside clear zone (if non-breakaway)	pg. 294
Utility Poles (2)	Rural: Outside clear zone Urban: 1.5 ft. from face of curb	pg. 294 pp. 293, 319
Building Line	15 feet from elevated roadway (wall)	pg. 522
Signal Pole and Controller Cabinets	Rural: As far from the roadway as practicable Urban: 1.5 ft. from face of curb	pg. 4-13 (3) pg. 319

1. For metal guardrail, add deflection distance.
2. Exceptions for utility poles are to be in accordance with the current **Utility Accommodation Manual** exceptions procedure for horizontal clearance for utility poles.
3. **2002 AASHTO Roadside Design Guide.**

Exhibit 23-A Submittal/Approval Letter

To: _____
District or Turnpike Design Engineer

Date: _____

Financial Project ID: _____ New Const. () RRR ()

Federal Aid Number: _____

Project Name: _____

State Road Number: _____ Co./Sec./Sub. _____

Begin Project MP: _____ End Project MP: _____

Full Federal Oversight: Yes () No ()

Request for Design Exception (), Design Variation ()

(For Design Exception or Variations Requiring Central Office Approval)

Re-submittal: Yes () No () Original Ref# _____ - _____ - _____

Requested for the following element(s):

- | | | | |
|--------------------------|--------------------------|------------------------|-----------------------------|
| () Design Speed | () Lane Widths | () Shoulder Widths | () Bridge Widths |
| () Structural Capacity | () Vertical Clearance | () Grades | () Cross Slope |
| () Superelevation | () Horizontal Alignment | () Vertical Alignment | () Stopping Sight Distance |
| () Horizontal Clearance | () Other _____ | | |

1. Include a brief statement here concerning the project and the exception or variation requested.

2. Attach the Sealed Report including applicable documentation as per *Section 23.5*.

Recommended by:

_____ Date _____

Responsible Professional Engineer

Approvals:

_____ Date _____
District or Turnpike Design Engineer

_____ Date _____
District Structures Design Engineer

_____ Date _____
State Roadway Design Engineer

_____ Date _____
State Structures Design Engineer

_____ Date _____
State Chief Engineer

_____ Date _____
FHWA Division Administrator

Chapter 24

Federal Aid Project Certification

24.1	General	24-1
24.2	Selection of FHWA Oversight Projects.....	24-2
24.3	FDOT Responsibilities	24-4
24.4	Certification Documentation and Reviews	24-6
24.5	Certification Statement.....	24-7
Exhibits		
Exhibit 24-A	Approval and Concurrence Process	24-8
Exhibit 24-B	Design Plans Phase Review.....	24-9
Exhibit 24-C	Special Provisions.....	24-10

THIS PAGE LEFT BLANK INTENTIONALLY

Chapter 24

Federal Aid Project Certification

24.1 General

The Florida Department of Transportation has a formal agreement with the Federal Highway Administration setting forth the respective roles, responsibilities, and accountability of FDOT and FHWA in the administration and oversight of Federal Aid highway funds. See **Florida Federal-Aid Partnership Agreement, Topic No. 700-000-005** and **Title 23 United States Code (U.S.C.) 106**. Under this agreement FHWA grants to FDOT general oversight responsibilities and approvals for design, plans, specifications, estimates, contract awards, contract administration and project inspections on Federal Aid highway projects except for selected projects as discussed in **Section 24.2** where FHWA retains full oversight. For those projects that FDOT has oversight responsibility, FDOT will follow all applicable FHWA policies, regulations, **Title 23 U.S.C.**, and **non-Title 23 U.S.C.** requirements as if FHWA were involved. Notwithstanding this, FHWA may become involved with any Federal-aid project and retains overall responsibility for all aspects of Federal-aid programs. As such, FHWA has full access to and the legal authority to review any aspect or record of any Federal-aid project at any time. In accordance with **49 CFR Part 18**, records will be retained for a minimum of three years or until litigation, claims or audit findings initiated before the three-year period have been resolved.

24.2 Selection of FHWA Oversight Projects

In accordance with the Partnership Agreement, annually in July, FHWA and FDOT will negotiate which new projects will be selected for “full oversight” by FHWA. FHWA Transportation Engineer will coordinate the project selection with their assigned FDOT District Office. Ideally, the projects will be selected from projects listed in the Statewide Transportation Improvement Program (STIP) to be approved by FHWA the following October 1st, and will include projects selected from all four years of the STIP. The projects selected should be on the Federal-aid system to primarily include the Interstate and National Highway System (NHS) routes, but non-NHS projects can be selected. The projects should be selected considering the factors below:

1. All major projects as defined by FHWA’s major project criteria (cost ≥ \$500 million)
2. Controversial and Congressional interest Projects
3. Demonstration (demo) and pilot projects
4. Interstate projects:
 - a. With design exceptions to the 13 controlling criteria
 - b. For new or modified access points
 - c. For major reconstruction and widening
5. Projects utilizing innovative contracting methods, such as design build
6. Special Experimental Projects (SEP):
 - a. Projects requiring SEP-14 approval for alternative contracting methods
 - b. Projects requiring SEP-15 approval for public-private partnerships
7. Projects with an EIS
8. Unusually complex or controversial projects
9. Major unique and/or unusual structures
10. A priority focus for projects on the NHS
11. A desire to have a mix in project size and scope

All federally funded projects must comply with applicable ***non-Title 23 U.S.C.*** requirements which include, but are not limited to:

1. ***National Environmental Policy Act (NEPA) of 1969*** pursuant to ***40 C.F.R. Parts 1500 - 1508, 23 C.F.R. Section 771*** and ***Section 6002 of SAFETEA-LU***
2. ***Section 4 (f) of the DOT Act of 1966***

3. **Clean Air Act Amendments of 1990**
4. **Civil Rights Act of 1964**
5. Civil Rights approvals
6. Disadvantaged Business Enterprise Program (DBE)
7. **Uniform Relocation Assistance and Real Properties Acquisition Policies Act of 1970**
8. Hardship acquisition and protecting buying
9. **Americans with Disabilities Act/Section 504 Rehabilitation Act of 1973**
10. Davis-Bacon wage rates
11. Waiver for Buy America requirements
12. SEP-14/SEP15 contracting methods
13. Executive Orders
14. FHWA Guidance and technical advisories
15. Addition/modification of access points to the Interstate (Interchange, locked gate access points, median crossovers for construction)
16. Project by project obligation of federal funds
17. Modifications to Federal-aid project agreements
18. Final Vouchers

24.3 FDOT Responsibilities

The final design documents, reports and plans for projects not selected for FHWA oversight will be developed in accordance with all applicable Department manuals, guidelines and procedures, and in compliance with all applicable Federal Statutes, Regulations, Executive Orders, and FHWA Directives and Standards. The Department is responsible for assuring that all appropriate criteria has been adhered to, and for documenting its findings in lieu of FHWA reviews. Several of the major areas and the method to be used by the Department to document the acceptability of various final design activities in place of an FHWA review and approval are:

1. Typical Section Package

The typical section package should be prepared as described in **Chapter 16, Sections 16.2.3** and **16.3.2** of this volume. Concurrence by the District Design Engineer documents the acceptability of the package. Concurrence from the District Structures Design Engineer may also be required on unusual bridge typical sections.

2. Pavement Design Package

The pavement design is developed and approved by the responsible professional engineer in accordance with Department pavement design procedures. Concurrence from the District Design Engineer is required to document the acceptability of the package in lieu of FHWA review and concurrence.

3. Bridge Hydraulics Report

The hydraulics report is developed and approved by the responsible professional engineer in accordance with appropriate design standards. Concurrence from the District Drainage Engineer is required to document the acceptability of the package in lieu of FHWA review and concurrence.

4. Bridge Development Report

The bridge development report is developed and approved by the responsible professional engineer in accordance with appropriate design standards. Concurrence from the District Design, Structures Design, or Project Management Engineer is required to document the acceptability of the report in lieu of FHWA review and concurrence.

5. Design Plans Phase Reviews

Plan reviews should be conducted as described in **Chapter 16** of this volume. Concurrence in the resolution of phase review comments from the District Design, Structures Design, or Project Management Engineer is required to document the acceptability of the reviews in lieu of FHWA review and concurrence. (See **Exhibit 24-B.**)

6. Design Exceptions

Design Exceptions on projects not under full FHWA oversight require approval and concurrence as described in **Chapter 23** of this volume.

7. Special Provisions

Special provisions, which include project specific and technical special provisions, will be developed and approved by the responsible professional engineer. Concurrence from the District Specifications Engineer is required to document the acceptability of the special provisions in lieu of FHWA review and concurrence. (See **Exhibit 24-C**.)

8. Plans, Specifications and Estimate

The Plans, Specifications, and Estimates (PS&E) Package and contract file will be transmitted to Tallahassee as described in **Chapter 20** of this volume. The District Director of Transportation Development (Production) will certify that the design and PS&E Package has been prepared according to the appropriate certification procedures. The date of this certification will be noted on the Transmittal of PS&E Package. The Transmittal will also identify the individuals that reviewed the Plans Package, Specification Package, and Authorization Estimate, and the dates of their respective reviews. The Department's official estimate will be approved by the District Estimates Engineer.

9. Authorization to Advertise

The letter requesting FHWA authorization to advertise for bids and the PS&E package, including reimbursable utility agreements, will be submitted to FHWA by the Federal Aid Office. The Federal Aid Manager will certify in the letter to FHWA that the package was prepared under the appropriate certification procedures. An FHWA PS&E checklist (the Contract File Index, filled out by the District and submitted as part of the Transmittal of PS&E Package) will be submitted to FHWA.

10. Revisions

Revisions to the PS&E will be processed as described in **Chapter 20** of this volume. Concurrence from the District Design, Structures Design, or Project Management Engineer is required to document the acceptability of the revision in lieu of FHWA review and concurrence.

In special cases where programs or projects are developed in the Central Office, an appropriate Central Office Manager will provide any necessary concurrences in lieu of a District Manager. **Exhibit 24-A** outlines the approval and concurrence process.

24.4 Certification Documentation and Reviews

FHWA will perform periodic reviews of projects developed under the Partnership Agreement and may have access to review project phases and records at any time. To support the exemption program, adequate documentation throughout the design phase is critical. All approvals and concurrences outlined in the previous section must be sufficiently documented. A complete, well-organized design project file should be able to support a compliance review. All correspondence and documents must include the Federal Aid project number. The Quality Assurance procedures described in **Chapter 18** of this volume will be used by the Central Office to monitor district compliance with the certification requirements.

24.5 Certification Statement

A Federal Aid project certification statement by the District Director of Transportation Development (Production) for each project is no longer required. However, Districts are responsible for insuring that all Federal Aid requirements are met as described in this chapter.

Exhibit 24-A Approval and Concurrence Process

<p>TYPICAL SECTION PACKAGE</p> <p>Approved: 6 Concurrence: 3 or 4 <i>(PPM Vol. 1, Section 16.2.3)</i></p>	<p>PAVEMENT DESIGN PACKAGE</p> <p>Approved: 6 Concurrence: 3 <i>(Pavement Design Manual)</i></p>		
<p>BRIDGE DEVELOPMENT REPORT</p> <p>Approved: 6 Concurrence: 3 4 5 or 7 <i>(PPM Vol. 1, Chap. 26)</i></p>	<p>APPROVAL OF PHASE REVIEW PLANS (Roadway and Structures)</p> <p>Approved: 6 Concurrence: 3 4 5 7 or District Roadway Design Engineer <i>(PPM Vol. 1, Chap. 16)</i></p>		
<p>ACCIDENT/SAFETY REVIEW</p> <p>Approved: District Safety Engineer</p>	<p>SPECIAL PROVISIONS</p> <p>Approved: 6 Concurrence: 9</p>		
<p>DESIGN CRITERIA</p> <p>DESIGN EXCEPTIONS Requested: 3 or 6 Concurrence: 8, and 7 when needed. Approved: FHWA or 11 <i>(PPM Vol. 1, Chap. 23)</i></p>	<p>BRIDGE HYDRAULICS REPORT</p> <p>Approved: 6 Concurrence: District Drainage Engineer <i>(Drainage Manual, Chap. 4)</i></p>		
<p>PLANS, SPECIFICATIONS AND ESTIMATE</p> <p>PLANS PACKAGE Approved: 2</p> <p>SPECIFICATIONS PACKAGE Approved: 9</p> <p>FHWA AUTHORIZATION ESTIMATE Approved: 10 <i>(PPM Vol. 1, Section 20.3)</i></p>	<p>REVISIONS TO PS&E</p> <p>Approved: 6 Concurrence: 3 4 or 5 <i>(PPM Vol. 1, Section 20.4)</i></p> <hr/> <p>ASSEMBLY OF PS&E & CERTIFICATION OF OTHER REPORTS AS REQUIRED</p> <p>Responsibility: FA Manager</p>		
<table border="0"> <tr> <td style="vertical-align: top;"> <ol style="list-style-type: none"> 1 District Secretary 2 District Director of Transportation Development (Production) 3 District Design Engineer 4 District Structures Design Engineer 5 District Project Management Engineer 6 Responsible Professional Engineer 7 State Structures Design Engineer 8 State Roadway Design Engineer 9 District Specifications Engineer 10 District Estimates Engineer 11 State Director of Design (for exempt projects) </td> <td style="vertical-align: top; padding-left: 20px;"> <p>NOTE: In special cases where programs or projects are developed in the Central Office, an appropriate Central Office Manager will provide concurrence in lieu of the District Manager.</p> </td> </tr> </table>		<ol style="list-style-type: none"> 1 District Secretary 2 District Director of Transportation Development (Production) 3 District Design Engineer 4 District Structures Design Engineer 5 District Project Management Engineer 6 Responsible Professional Engineer 7 State Structures Design Engineer 8 State Roadway Design Engineer 9 District Specifications Engineer 10 District Estimates Engineer 11 State Director of Design (for exempt projects) 	<p>NOTE: In special cases where programs or projects are developed in the Central Office, an appropriate Central Office Manager will provide concurrence in lieu of the District Manager.</p>
<ol style="list-style-type: none"> 1 District Secretary 2 District Director of Transportation Development (Production) 3 District Design Engineer 4 District Structures Design Engineer 5 District Project Management Engineer 6 Responsible Professional Engineer 7 State Structures Design Engineer 8 State Roadway Design Engineer 9 District Specifications Engineer 10 District Estimates Engineer 11 State Director of Design (for exempt projects) 	<p>NOTE: In special cases where programs or projects are developed in the Central Office, an appropriate Central Office Manager will provide concurrence in lieu of the District Manager.</p>		

Exhibit 24-B Design Plans Phase Review

DATE:

TO: (See Below)*

FROM:

COPIES:

SUBJECT: Response to _____ Phase Review

REF: Financial Project ID
FA Project Number
County

In content of letter include a statement confirming that all review comments have been responded to or satisfactorily resolved.

Include appropriate copies of review comments, responses and other pertinent data.

APPROVED:

CONCURRENCE:

Responsible Professional Eng.
(Name of Consultant Firm)

* District Design Engineer
* District Structures Design Engineer
* District Project Management Engineer

* As appropriate

Exhibit 24-C Special Provisions

DATE:

TO: District Design, Structures Design or
Project Management Engineer

FROM:

COPIES: State Specifications Engineer

SUBJECT: Special Provisions

REF: Financial Project ID
FA Project Number
County

Include detailed information concerning special provisions required.

Appropriate section(s) of FDOT Standard Specifications should be referenced.

Questions concerning format and content should be directed to the Specifications Office of FDOT

APPROVED:

CONCURRENCE:

Responsible Professional Eng.
(Name of Consultant Firm)

* District Design Engineer
* District Structures Design Engineer
* District Project Management Engineer

* As appropriate

Chapter 25

Florida's Design Criteria for Resurfacing, Restoration and Rehabilitation (RRR) of Streets and Highways

25.1	Introduction	25-1
25.1.1	General	25-1
25.1.2	Application	25-1
25.2	Planning and Programming RRR Projects	25-3
25.2.1	Projects Requiring Right of Way	25-3
25.2.2	Projects With Bridges Within Project Limits	25-3
25.2.3	Project Features Requiring Design Exceptions and Design Variations.....	25-4
25.2.4	Ride Rehabilitation Projects	25-4
25.2.5	Railroad-Highway Grade Crossing Near or Within Project Limits	25-4
25.3	RRR Project Design Process	25-5
25.3.1	Review of Project Purpose.....	25-5
25.3.1.1	Principal Reason(s) for the RRR Project ..	25-5
25.3.1.2	General Nature of Proposed Improvements (Type of Work)	25-6
25.3.1.3	Review Project Budget and Priority	25-7
25.3.2	Assessment of Conditions.....	25-7
25.3.2.1	Office Reviews	25-8
25.3.2.2	Field Reviews.....	25-9
25.3.3	Project Scopes	25-10
25.3.4	Survey Guidelines for RRR Projects	25-11
25.3.4.1	Types of Work for RRR Projects.....	25-11

	25.3.4.2	Definition of Levels of Survey Effort.....	25-13
	25.3.5	Review Project Plans	25-14
	25.3.6	Document the Design Process.....	25-14
25.4		RRR Design Criteria.....	25-15
	25.4.1	Design Period	25-15
	25.4.2	Project Traffic Volume.....	25-15
	25.4.3	Pavement Design.....	25-16
	25.4.4	Design Speed	25-16
	25.4.5	Lane and Shoulder Widths.....	25-18
	25.4.6	Roadway Cross Slopes.....	25-20
	25.4.7	Superelevation	25-20
	25.4.8	Shoulder Treatment	25-21
	25.4.9	Side Slopes.....	25-22
	25.4.10	Vertical Alignment	25-23
		25.4.10.1 Vertical Curvature	25-23
		25.4.10.2 Grades	25-25
	25.4.11	Horizontal Alignment.....	25-25
		25.4.11.1 Horizontal Curves	25-26
	25.4.12	Stopping Sight Distance.....	25-27
	25.4.13	Vertical Clearance.....	25-28
	25.4.14	Horizontal Clearance.....	25-28
		25.4.14.1 Control Zones	25-29
		25.4.14.2 Areas Outside Control Zones.....	25-30
	25.4.15	(Reserved)	25-34
	25.4.16	Border	25-35
	25.4.17	Intersections.....	25-36
	25.4.18	Drainage	25-37
	25.4.19	Pedestrian, Bicyclist and Transit Needs.....	25-38
		25.4.19.1 Pedestrian Needs	25-38

	25.4.19.2 Bicyclist Needs.....	25-39
	25.4.19.3 Transit Needs.....	25-40
25.4.20	Utilities (Underground and Overhead)	25-40
25.4.21	At-grade Railroad Crossings.....	25-40
25.4.22	Aesthetics and Landscaping	25-40
25.4.23	Highway Lighting.....	25-41
25.4.24	Highway Traffic Control Devices.....	25-42
25.4.25	Bridges.....	25-42
	25.4.25.1 Bridge Loading.....	25-43
	25.4.25.2 Bridge Width	25-43
	25.4.25.3 Bridge Railing.....	25-44
	25.4.25.4 Vertical Clearance.....	25-45
	25.4.25.5 Considerations.....	25-45
	25.4.25.6 Pier Protection and Design	25-45
25.4.26	Roadside Safety Hardware	25-46
	25.4.26.1 Longitudinal Barriers, Guardrails, Median Barriers.....	25-46
	25.4.26.2 Guardrail to Bridge Rail Transitions	25-46
	25.4.26.3 Guardrail Terminals	25-48
	25.4.26.4 Crash Cushions and Attenuators.....	25-49
25.4.27	Sign, Signal, and Lighting Structures.....	25-51
	25.4.27.1 Existing Structures-Without Planned Additional Loading.....	25-51
	25.4.27.2 Existing Structures - With Planned Additional Loading.....	25-51
25.5	Design Exceptions and Design Variations	25-52

Tables

Table 25.4.4.1	RRR Design Speed vs. Posted Speed.....	25-17
Table 25.4.5.1	Lane and Shoulder Widths - Rural Multilane.....	25-18
Table 25.4.5.2	Lane and Shoulder Widths Two-Lane Rural and Urban, Without Curb and Gutter	25-18
Table 25.4.5.3	Lane Widths Urban Multilane or Two-Lane With Curb and Gutter	25-19
Table 25.4.5.4	Lane and Shoulder Widths Urban Multilane Without Curb and Gutter	25-19
Table 25.4.6	Roadway Cross Slopes.....	25-20
Table 25.4.10.1	K Values for Vertical Curvature	25-24
Table 25.4.11.1	Safe Criteria for State Highway System With Maximum Superelevation.....	25-27
Table 25.4.12	Stopping Sight Distance.....	25-27
Table 25.4.14.1	Recoverable Terrain.....	25-31
Table 25.4.14.2	Horizontal Clearance for Traffic Control Signs.....	25-31
Table 25.4.14.3	Horizontal Clearance for Light Poles.....	25-31
Table 25.4.14.4	Horizontal Clearance for Utility Installations.....	25-32
Table 25.4.14.5	Horizontal Clearance to Signal Poles and Controller Cabinets for Signals	25-32
Table 25.4.14.6	Horizontal Clearance to Trees	25-32
Table 25.4.14.7	Horizontal Clearance to Bridge Piers and Abutments.....	25-32
Table 25.4.14.8	Horizontal Clearance to Railroad Grade Crossing Traffic Control Devices.....	25-33
Table 25.4.14.9	Horizontal Clearance to Other Roadside Obstacles	25-33
Table 25.4.14.10	Horizontal Clearance to Canal and Drop-off Hazards.....	25-33

Table 25.4.25.1	Bridge Loading	25-43
Table 25.4.25.2	Clear Width Criteria for Bridges	25-43
Exhibits		
Exhibit 25-A	Control Zones	25-53

THIS PAGE LEFT BLANK INTENTIONALLY

Chapter 25

Florida's Design Criteria for Resurfacing, Restoration and Rehabilitation (RRR) of Streets and Highways

25.1 Introduction

25.1.1 General

Resurfacing, restoration and rehabilitation (RRR) work is defined as work undertaken to extend the service life of an existing highway and/or enhance highway safety. This includes the placement of additional surface materials and/or other work necessary to return an existing roadway to a condition of structural and functional adequacy. Many of the RRR Standards used by the Department are derived from the ***National Academy of Sciences "Special Report 214"***. This publication contains many of the methods necessary to make the safety and cost effective evaluations required by this chapter.

RRR projects must be designed and constructed in a manner that will comply with the accessibility standards and requirements set forth in the ***Americans with Disabilities Act of 1990 (ADA)***.

25.1.2 Application

The criteria included in this chapter are for all RRR projects except for Interstate highways, freeways, and Limited Access Florida Intrastate Highway System (FIHS)/Strategic Intermodal System (SIS) Corridors and Connectors, and are not intended to apply to new construction or major modifications of existing facilities.

The RRR design criteria applicable for Interstate Highways and Freeways are new construction criteria, with the following exceptions:

1. The standards used for horizontal alignment, vertical alignment, and widths of median, traveled way and shoulders may be the AASHTO interstate standards that were in effect at the time of original construction or inclusion into the interstate system.

2. Mainline bridges may remain in place if they have minimum cross sections consisting of 12 ft. lanes, 10 ft. shoulder on the right and 3 ft. shoulder on the left. For mainline bridges (over 200 ft.), the offset to the face of parapet or bridge rail on both the left and right is 3 ft. (minimum) measured from the edge of the nearest traveled lane. Bridge railing shall meet or be upgraded in accordance with the requirements of **Section 25.4.25.3 Bridge Railing** of this volume.
3. Roadside Safety Hardware shall meet the requirements of **Section 25.4.26 Roadside Safety Hardware** of this volume.
4. Pier protection and design shall comply with the requirements provided in **Structures Design Guidelines, Section 2.6**.

Existing median crossovers on Interstate highways and freeways shall be evaluated for conformance to the criteria in **Section 2.14.4, Crossovers on Limited Access Facilities**. Crossovers that do not meet those criteria must be removed as a part of the project unless approved by the State Roadway Design Engineer and FHWA (FHWA approval on Interstate only).

Projects on controlled access FIHS/SIS Corridor and Connector facilities shall be designed using new construction criteria. RRR criteria may be applied on a project to the extent permitted by the Action Plan for that corridor, consistent with the schedule for phased improvements to bring the facility up to new construction criteria. For controlled FIHS/SIS Corridors and Connectors with no Action Plan, RRR criteria may be applied if minimum design speed criteria shown in **Section 25.4.4** are met or a Design Exception for design speed is approved.

The RRR criteria may be used for establishing the minimum requirements for intersection improvement projects with the understanding that when right of way is adequate, new construction criteria will be used to the maximum extent feasible.

This chapter does not apply to projects programmed as Maintenance Resurfacing projects other than meeting ADA curb ramp requirements. If compliance with ADA curb ramp requirements is determined to be technically infeasible, documentation as a Design Variation is required. Refer to the **Work Program Instructions (Chapter 28)** for these projects.

25.2 Planning and Programming RRR Projects

RRR projects must balance a number of competing objectives, the principal ones being the preservation of highways, improved service levels and enhancement of safety. The success in meeting these objectives depends on the quality of individual project designs and project programming decisions.

The majority of RRR projects are identified and programmed as a result of deficient pavement condition. These projects are funded under the Department's Pavement Resurfacing program. Districts are provided specific lane mile targets that must be met annually. Program funds are allocated to each District based on a fixed amount per lane mile to be resurfaced. The amount allocated includes funds necessary to resurface/rehabilitate the pavement plus a limited amount which can be used for other improvements and upgrades. Improvements and upgrades which cost more than the allocated amount result in reduced funds for such improvements on other roadways being resurfaced and/or must come from other Department funding programs. For additional information on the Department's Pavement Resurfacing program requirements and restrictions, see the Department's [Work Program Instructions](#).

25.2.1 Projects Requiring Right of Way

RRR projects do not typically involve Right of Way acquisition. However, in all cases, facilities programmed for RRR projects should be given a review of the existing right of way, roadway, transit stops, access management, drainage design elements and other improvements to identify locations that require additional right of way. For such locations, the design should be expedited to determine actual right of way requirements. The designer must coordinate the requirements with the Right of Way Office so that necessary areas will be cleared before the project is ready for letting.

25.2.2 Projects With Bridges Within Project Limits

Bridges must be reviewed in sufficient detail to clearly establish the cost effective and appropriate changes to be included in the project design effort. Pavement resurfacing funds can only be used for minor bridge improvements such as rail retrofits and ADA improvements. Bridges that require major improvement or replacement must be programmed with the appropriate bridge program funds.

25.2.3 Project Features Requiring Design Exceptions and Design Variations

Projects may have features below criteria values which have not been programmed and/or which are determined not to be appropriate to accomplish under the design project. These usually require design exception or design variation approval, as appropriate. See **Sections 25.3.6** and **25.5**.

25.2.4 Ride Rehabilitation Projects

Projects that are deficient only due to Ride Rating (<5.5) as rated by the Pavement Condition Survey, and have a posted speed limit less than 50 mph, can be programmed as Ride Rehabilitation Projects.

If the pavement is in good structural condition, the scope of the work can be limited to meeting ADA requirements and doing what is necessary and practical to improve the smoothness of the pavement to meet standards. This can often just be adjustments to manholes and valves or the correcting of utility cut patches through short milling and paver-laid friction course.

These projects meeting the specific criteria above do not have to comply with **Sections 25.3.6** and **25.5**. They can be funded with Resurfacing Funds and will receive lane mile target resurfacing credit.

25.2.5 Railroad-Highway Grade Crossing Near or Within Project Limits

Federal-aid projects must be reviewed to determine if a railroad-highway grade crossing is in or near the limits of the project. If such railroad-highway grade crossing exists, the project must be upgraded in accordance with **Section 6.2.3**.

See **Section 25.4.21** for additional railroad-highway grade crossing criteria.

25.3 RRR Project Design Process

Significant improvements in overall safety can be brought about by a systematic safety conscious design process. The design process is a team effort that requires the expertise of persons familiar with design, safety, maintenance, traffic operations and others. To assure that safety issues are fully addressed on RRR projects, in addition to the usual design process, the following are also required:

1. A review of the purpose for which the RRR project was programmed.
2. An assessment of current safety conditions.
3. A final scope of work with recommendations for specific safety improvements.
4. Documentation of the safety design decisions.
5. Reviews of the design for safety issues.
6. Identify and implement needed public involvement activities.

25.3.1 Review of Project Purpose

A RRR project is generated by specific needs or conditions. The designer must become familiar with these needs or conditions at the very beginning of involvement with the project in order to assure that the final scope of work and final design actually accomplish the original purpose of the project. This may involve research of background data or other information that provides the reason, the proposed improvements, estimated project cost and project priority.

25.3.1.1 Principal Reason(s) for the RRR Project

As indicated in **Section 25.2**, the majority of RRR projects are identified and programmed as a result of deficient pavement condition. The following list indicates some, but not all, of the principal reasons that can generate a RRR project:

1. To preserve or extend the life of the existing pavement.
2. Improve capacity (without adding continuous through lanes).
3. Improve operating characteristics.
4. Site specific crash reduction.
5. Section wide crash reduction.
6. General safety modifications.

25.3.1.2 General Nature of Proposed Improvements (Type of Work)

Department policy requires that the following items be included in each RRR project unless written authorization to deviate from this policy is obtained at a Director level position in the District:

1. Safety improvements needed to address crash problems.
2. Pavement Resurfacing/Rehabilitation.
3. Modifications necessary to Comply with the American's with Disability Act (ADA).
4. Paved Shoulders.
5. Improvements to roadside barriers, guardrail, and bridge rails necessary to meet minimum standards. (Design Exceptions require Central Office approval.)
6. Traffic Signal Mast Arms within the mast arm policy area (see **Section 7.4.12**) where existing strain poles require replacement/relocation.

In addition to the above, a project may include one or more of the following types of work as a general improvement. The list is not all-inclusive.

1. Widen roadway and bridge lanes.*
2. Widen or add roadway and bridge shoulders.*
3. Provide clear zone.
4. Upgrade pavement markings.
5. Add, update or remove traffic signals.
6. Correct skid hazards.
7. Replace bridges rated "insufficient".*
8. Upgrade to current Access Management requirements.
9. Provide non vehicular transportation needs.
10. Add or extend auxiliary lanes to a roadway.
11. Add turn lanes at an intersection or on a roadway.
12. Realign an intersection or roadway.
13. Replacement of bridges which cannot be widened economically.*
14. Upgrade at-grade railroad crossings.

15. Intersection improvements.
16. Removal of parking lanes.
17. Other safety improvements.
18. Add or upgrade transit stops.

* Major bridge improvements and replacements must be programmed using the appropriate bridge program funds.

While the general nature and type of improvements that can be made is extensive, due to the limited availability of funds, the cost of improvements other than those needed for safety and to meet minimum criteria must be carefully considered before including these improvements in the project.

25.3.1.3 Review Project Budget and Priority

The design and construction of a RRR project must be accomplished with expediency and at reasonable cost. Nevertheless, the project design must address all issues of safety, plus preservation of investment, and service to the user. Conditions that are discovered but cannot be resolved within the programmed budget and schedule must be addressed and the decisions documented.

25.3.2 Assessment of Conditions

Before beginning actual design of the project, the designer shall assess current conditions on the project. This assessment shall include both physical conditions and operating conditions plus a safety assessment. Office reviews and field reviews shall be performed as part of the assessment.

25.3.2.1 Office Reviews

Office reviews shall be conducted to assimilate and analyze data that may be pertinent to the improvements that can be made on the project.

1. **Assess Physical Conditions**

This assessment should include:

- a. Geometrics.
- b. Radius, length, and superelevation of curves.
- c. Typical shoulder treatments.
- d. Cross drain and structure locations.
- e. Location and design of intersections, etc..

A review of old plans, as built drawings, Straight Line Diagrams, and other historical records will determine many of the existing conditions.

2. **Assess Operating Conditions**

This assessment should include:

- a. A summary of legal posted speeds on the project.
- b. Drainage and Maintenance section's verbal or written concerns of past, present and/or anticipated future problems.
- c. Conditions attributable to current control of access.

3. **Assess Safety**

A review of historical crash and travel statistics shall be performed by a qualified safety specialist. This assessment, with written recommendations, should include:

- a. Identification of significant crash locations, with:
 - 1) possible causes.
 - 2) suggested corrective measures.
- b. Review of correspondence files for letters of public concern.

The designer shall review the safety assessment, evaluate the cost effectiveness of suggested corrective measures and include these measures in the project when appropriate.

25.3.2.2 Field Reviews

A field review shall be performed by a multi discipline team. This review should assess physical, operational and safety conditions.

1. Assess Geometric and Physical Conditions
 - a. Verify office review findings.
 - b. Check roadway features such as:
 - 1) alignment.
 - 2) cross slope.
 - 3) superelevation.
 - 4) lane width.
 - 5) existing traffic control markings and signs.
 - 6) side slopes.
 - 7) clear zones.
 - 8) shoulder type and width.
 - 9) intersection elements.
 - 10) sight distances.
 - 11) drainage (including erosion problems).
 - 12) pavement condition.
 - 13) highway appurtenances.
 - 14) transit stops.
 - 15) other features.
2. Assess Operating Conditions.
 - a. Verification of posted regulatory speeds.
 - b. Verification of posted advisory speeds.
 - c. Verification of reported problems.
 - d. Observation of operating conditions.
 - e. Evaluation of access features.
3. Assess Safety Conditions.
 - a. Observation of known crash locations.
 - b. Indications of unsafe operations, such as run-off-the-road indications or previous repairs.

25.3.3 Project Scopes

Utilizing the office and field review findings, prepare a final scope of work by incorporating, where appropriate, other work including engineering and surveying services not identified in the original scope. Improvements other than resurfacing, restoration or rehabilitation to be considered are listed below. The list is not all-inclusive.

1. Remove, relocate or make crashworthy roadside obstacles.
2. Remove unwarranted guardrail.
3. Upgrade or replace non standard guardrail.
4. Replace or retrofit obsolete bridge rails.
5. Improve side slopes; slope flattening/stabilizing.
6. Correct shoulder drop-off.
7. Pave shoulders.
8. Improve pavement cross slope.
9. Provide side drain safety modifications.
10. Increase sight distance at intersections.
11. Improve pavement markings.
12. Improve pavement drainage.
13. Provide or upgrade sidewalks, transit stops and bikeways.
14. Upgrade railroad crossings.
15. Provide or upgrade signalization.
16. Provide or upgrade lighting.
17. Upgrade signing and other traffic control devices.
18. Provide or upgrade curb cuts, ramps and other disability access features.
19. Reconstruct or close driveways to comply with Access Management standards.

25.3.4 Survey Guidelines for RRR Projects

25.3.4.1 Types of Work for RRR Projects

1. Mill and resurface only, EOP to EOP, no other improvements [Level 1].
2. Resurface with trench widening (Roadway only) [Level 1 if lump sum excavation].
3. Resurface adding turn lanes (spot improvements) [Level 2].
4. Resurface adding paved shoulders [Level 2].
5. Combination of numbers 2-4 [Level 2].
6. Resurface with access management improvements [Level 2].
7. Add paved shoulders only [Level 2].
8. (E) Extend drainage structures [Level 3].
9. (E) Guardrail, end treatments, etc. (safety) [Level 2].
10. (E) Side drain closure; mitered ends [Level 3].
11. Intersection improvements [Minor = Level 2; Major = Level 3].
12. (E) Correct horizontal and/or vertical alignment [Level 3].
13. (E) ADA compliance [Level 2].
14. Approaches to structures [Level 4].
15. RRR with Right of Way acquisition [Level 3].

(E) = Element of an item

(See also **Section 25.3.1.2**)

THIS PAGE LEFT BLANK INTENTIONALLY

25.3.4.2 Definition of Levels of Survey Effort

1. LEVEL 1

Review by District Surveyor to check for Public Land Corners. Check sections for cross slope at 1000 feet in tangents. For curves, check 50 feet before PC, at PC, 50 and 100 feet after PC and at middle of curve or 300 foot intervals. (Reverse at PT). May use assumed datum if approved by the District Location Surveyor and the Project Manager/Designer. The cross sections will have a common bench mark elevation throughout the curve. In other words, do not assume an elevation at the centerline of the highway for each cross section. A minimum of two (2) bench marks should be set off of the highway near the Right of Way (R/W) Line and may be on assumed elevations or NAVD 88 datum. If the surveyor elects to use temporary assumed bench marks, they must last throughout the life of construction and **cannot** be set in trees, power poles or concrete monuments. Establish begin and end points of project and reference.

2. LEVEL 2

Minor spot improvements such as turn lane at existing crossover, turn lane on 2-lane, etc. No additional Right of Way required. Where Right of Way is adequate, establish horizontal and vertical control in the improvement area. May use assumed vertical datum if approved by the District Location Surveyor and the Project Manager/Designer. The cross sections will have a common bench mark elevation throughout the curve. In other words, do not assume an elevation at the centerline of the highway for each cross section. A minimum of two (2) bench marks should be set off of the highway near the Right of Way Line and may be based on assumed elevations or NAVD 88 datum. If the surveyor elects to use temporary assumed bench marks, they must last throughout the life of construction and **cannot** be set in trees, power poles or concrete monuments. If Right of Way is constrained, re-establish existing R/W line. Level 1 required throughout other portions of project. Cross section level to be determined by Project Manager/Designer with input from the District Location Surveyor and Resident Engineer. TOPO with supplemental elevations in area of improvement. Reference control points outside R/W. Subsurface utility locates if required.

3. LEVEL 3

Continuous improvements through length of project such as widening and/or paved shoulder; or major spot improvements (structure replacement; major intersection improvement). May require Right of Way purchase. Horizontal Control baseline, centerline or network. Vertical Control on NAVD 88. TOPO with

supplemental elevations (limits to be determined). Digital Terrain Model (DTM) at specified locations. Right of Way Control Survey and Maps (if Right of Way purchased). Subsurface utility locates.

4. **LEVEL 4**

Full Digital Terrain Model (DTM) and TOPO for entire project.

25.3.5 Review Project Plans

RRR design plans are reviewed by other disciplines including a safety specialist. These reviews are detailed in **Chapter 16** of this volume.

25.3.6 Document the Design Process

The designer shall include in the design file all documentation that substantiates the design process and decisions made, including the following information:

1. A short paragraph which states the overall project purpose. Factors such as principal reason for the project, anticipated project cost, principal work type, general right of way needs or provisions, and any special project priorities are appropriately addressed here.
2. Documents that detail the existing conditions on the project. Findings of office reviews, field reviews and surveys are assembled here, to document existing geometric and roadside features, operating conditions, traffic volumes, posted speeds, existing pavement markings, signing, safety, etc. A brief overall summary of findings is recommended.
3. Document the selected standards based on project intent and conditions. When RRR criteria cannot be met, a design exception/variation is required.
4. A summary of safety issues that have been identified for the project and the recommended solution of those issues.
5. Reviews of the project design for safety improvements, documenting what was finally accomplished or ruled out of the project subsequent to the scope of work having been completed.
6. Those items in the original scope of work for the project which cannot be reasonably accomplished and must be deleted or delayed.

25.4 RRR Design Criteria

Design values and decisions for roadway features should reflect the anticipated service life of the project. The designer has the responsibility to choose the specific design value to be used, taking into consideration its cost-effectiveness, which can range from the minimum RRR Criteria presented herein, to new construction criteria. Design values in the following sub-sections apply to RRR projects only. When specific values are not provided, the standards used in the original construction or subsequent enhancements may be retained except when an upgrade is identified in the project scope.

Designers are encouraged to make a deliberate selection of design values by explicitly addressing issues of safety cost-effectiveness, overall highway consistency in geometric design, design of adjoining segments and expected trends in traffic growth and truck use before specifying design values. The design values indicated in this chapter usually reflect a cost-effective basis for evaluating existing roadway characteristics to determine which features require upgrading.

The design values presented herein are the minimum to be used for a RRR project on the State Highway System without obtaining an exception or variation. See **Section 25.5** of this volume. Existing project features which were constructed to meet minimum metric design criteria, but are mathematically slightly less than equivalent minimum English design criteria, do not require design exceptions or variations to remain.

25.4.1 Design Period

Improvements should be evaluated using a design period which is consistent with the design period selected for the pavement rehabilitation. The design period (service life) for RRR projects should be from 8 - 20 years for projects without milling and 12 - 20 years for projects with milling. See the ***Flexible Pavement Design Manual, Topic No. 625-010-002*** for specific design periods. For skid hazard projects, where other improvements are not made, the design year is the expected year of construction.

25.4.2 Project Traffic Volume

The design year for traffic volume is the same design year as the year established for service life. Traffic data to be used for design:

AADT and DHV for mainline (current, post construction and design year),

1. K, D and T factors,
2. Peak turning movements at signalized and problem intersections and major traffic generators,
3. Movements for future traffic generators that are scheduled during the service life should be considered.

25.4.3 Pavement Design

The pavement design procedures are found in the *Flexible Pavement Design Manual (Topic No. 625-010-002)*, the *Rigid Pavement Design Manual (Topic No. 625-010-006)*, and the *Pavement Type Selection Manual (Topic No. 625-010-005)*.

Alternative paving treatments such as patterned/textured pavement may be used to accent the roadway in accordance with the *Standard Specifications*. Architectural pavers, however, shall not be used on the traveled way of the State Highway System. See *Section 2.1.6.1* for additional requirements.

25.4.4 Design Speed

Most highway features are based on design speed. Design speed is a principal design control that regulates the selection of many of the project standards and criteria used to design a roadway project. Selection of the design speed must be logical for the type, location and operational conditions of the highway, and the design speed used should be consistent with comparable adjacent projects. Design speed must not be dictated by an isolated geometric feature.

Design speed should generally not be less than the legal posted speed. The design speed used in the original design of the highway should be used for RRR projects. However, there may be situations where the existing posted speed on the highway is different than that used in the original design of the highway. The decision to modify the posted speed limit after the construction of the original project was completed would have been made under the authority of the District Traffic Operations Engineer (DTOE). In this case, the selected design speed shall be jointly approved by the District Design Engineer and the DTOE. This is to be documented on the Typical Section Package as described in *Section 16.2.3*. New project features and the correction of features having a significant crash history shall be designed using a design speed equal to or greater than the posted speed and process Design Exceptions or Variations for those new design elements that do not meet the criteria for the higher speed. See *Table 25.4.4.1* for further guidance.

Table 25.4.4.1 RRR Design Speed vs. Posted Speed

Condition	Establishing the Proposed Project Design Speed (DS _p)
CASE 1	Use the design speed used in the original design of the highway. $DS_p = DS_o$
CASE 2	Use the design speed used in the original design of the highway unless a reduced design speed (not less than posted speed) is approved by the DDE and the DTOE. $DS_p = DS_o$
CASE 3	Use the design speed used in the original design of the highway unless there is a significant crash history associated with a specific highway feature. If so, then the design speed used in correcting the feature shall be equal to or greater than the posted speed. The posted speed shall also be used as the design speed for any other new highway features (not replacements). Special attention should be given to curb and gutter sections. $DS_p = DS_o$ and $DS_p = PS$ (for design of features that are new or have a significant crash history)

CASE 1: The existing posted speed falls **within** an acceptable range of the original design speed. (i.e., $PS \leq DS_o \leq (PS + 10 \text{ mph})$ Example: $DS_o = 65\text{mph}$ and $PS = 55\text{mph}$).

CASE 2: The existing posted speed falls **below** an acceptable range of the original design speed. In a case like this, the posted speed was reduced, and the operational conditions have changed. (i.e., $DS_o > (PS + 10 \text{ mph})$ Example: $DS_o = 65\text{mph}$ and $PS = 35\text{mph}$).

CASE 3: The existing posted speed falls **above** an acceptable range of the original design speed. In a case like this, the posted speed was increased, and the operational conditions have changed. (i.e., $PS > DS_o$ Example: $DS_o = 50\text{mph}$ and $PS = 60\text{mph}$).

LEGEND

DS_o = Design speed used in the original project

DS_p = Proposed design speed for project

PS = Existing (or proposed if different) posted speed

Regardless of the original design speed or posted speed, the following are the minimum design speeds:

1. Rural Facilities: 55 mph
2. Urban Facilities: 30 mph
3. Urban Facilities on FIHS/SIS: 50 mph

Note: Values for design speeds less than these minimums have been provided in the tables in this chapter in the event that lower design speeds can be justified. If reconstruction is indicated, the criteria used for design should be selected from **Chapter 2** of this volume.

25.4.5 Lane and Shoulder Widths

The minimum lane and shoulder widths allowed are provided in **Tables 25.4.5.1, 25.4.5.2, 25.4.5.3, and 25.4.5.4**. The minimum widths shown in these tables are to allow existing lanes and shoulders to remain, not to be reduced to these widths unless the purpose is to provide a bicycle facility. See **Section 25.4.19** for further information.

On resurfacing projects, when the original construction was in metric units, hard convert typical section dimensions where existing conditions permit. Exception: Use direct mathematical (soft) conversion for existing pavement widths in curbed sections, existing right of way widths, and existing median widths.

For interchange ramps, where accommodation of future resurfacing is a factor, consideration should be given to increasing the minimum combined width (traveled way + outside paved shoulder) to 24 ft. where practical.

Table 25.4.5.1 Lane and Shoulder Widths - Rural Multilane

Design Year AADT	Design Speed (mph)	Minimum Lane Width (ft.)	Minimum Shoulder Width (ft.)
ALL	ALL	12	6

**Table 25.4.5.2 Lane and Shoulder Widths
 Two-Lane Rural and Urban, Without Curb and Gutter**

Design Year AADT	Design Speed (mph)	Minimum Lane Width (ft.)	Minimum Shoulder Width (ft.)
1 – 750	ALL	10 ₁	6
751 – 2000	< 50	11 ₂	6
	≥ 50	12 ₂	6
> 2000	ALL	12 ₂	6

1. For rural and urban projects without curb and gutter (regardless of traffic volume), when widening is required, a minimum lane width of 11 ft. is required.
2. May be reduced by 1 ft. if trucks ≤ 10% of design year traffic.

**Table 25.4.5.3 Lane Widths
 Urban Multilane or Two-Lane With Curb and Gutter**

Design Year AADT	Design Speed (mph)	Minimum Thru Lane (ft.)	Minimum Turn Lane (ft.)	Minimum Parking Lane (ft.)
ALL	ALL	10 ₁	9 ₂	7 ₃

1. 11 ft. where either of the following conditions exist:
 - a. Trucks are >10% of Design Year Traffic.
 - b. Design Speed is 40 mph or greater.
2. 10 ft. for 2 Way Left Turn Lanes.
3. A minimum width of 7 ft. measured from face of curb may be left in place. Otherwise provide 8 ft. minimum, measured from face of curb.

**Table 25.4.5.4 Lane and Shoulder Widths
 Urban Multilane Without Curb and Gutter**

Design Year AADT	Design Speed (mph)	Minimum Thru Lane (ft.)	Minimum Turn Lane (ft.)	Minimum Shoulder Width (ft.)
ALL	ALL	10 ₁	9 ₂	6

1. 11 ft. where either of the following conditions exist:
 - a. Trucks are >10% of Design Year Traffic.
 - b. Design Speed is 40 mph or greater
2. 10 ft. for 2-Way Left Turn Lanes.

25.4.6 Roadway Cross Slopes

The existing pavement and shoulder cross slopes shall be reviewed for compliance with criteria. Existing pavement and shoulder cross slopes shall be field verified by the design location survey. If cross slopes are out of tolerance, additional cross sections may be requested by the designer to estimate cross slope correction material quantity. Whenever practical, pavement and shoulder cross slopes shall be constructed to new construction criteria. When meeting new construction cross slope criteria is not practical, documentation in the design file is required and the normal non-superelevated cross slope used shall be consistent with the values in **Table 25.4.6**. Superelevation requirements are covered in **Section 25.4.7** of this volume.

When cross slope correction is necessary, the designer must work closely with the Pavement Design Engineer and the District Bituminous Engineer to determine the appropriate method of correction and ensure constructability. Special milling and layering details showing the method of correction shall be shown in the plans. For projects with superelevated sections, details shall address how the transition from normal cross slope to superelevation is to be achieved. Since this type work will often involve variable depth milling and/or asphalt layers, special care in estimating quantities for milling, overbuild, and structural courses will be necessary.

Table 25.4.6 Roadway Cross Slopes

Feature	Standard	Range
Travel Lanes	0.02	0.02 - 0.04 ¹
Shoulders	0.06	0.03 - 0.08 ²
Parking Lanes	0.05	0.03 - 0.05

- Existing multilane curb and gutter sections originally constructed with a parabolic crown section may be resurfaced using a series of tangents with a cross slope range from 0.015 to 0.05.
- When existing shoulders are to remain, the algebraic difference between the shoulder slope and adjoining roadway pavement slope shall be ≤ 0.07 .

25.4.7 Superelevation

Roadway and shoulder superelevation shall be provided in accordance with the **Design Standards, Index 510** for rural curves and **Index 511** for urban curves, consistent with **Section 25.4.11.1, Number 2, Superelevation**.

25.4.8 Shoulder Treatment

On projects with rural type (without curb) construction, shoulder treatment, erosion control, turf and sod shall be provided consistent with the criteria for new construction. Paved shoulders shall be provided in accordance with new construction criteria with the following exceptions:

1. The widening of existing 4 ft. paved shoulders is optional.
2. When a bicycle lane is provided between the through lane and the right turn lane in accordance with **Section 25.4.19**, a paved shoulder should be provided for the right turn lane, but is optional. When a paved shoulder is provided for the right turn lane, it should be 5 feet wide (2 feet minimum) to address off-tracking vehicles and to provide drainage benefits.

For RRR projects using **Index 105** of the **Design Standards**, the shoulder treatment option must be identified in the plans. Treatment 1 can only be used if the shoulder is established with good soil and turf, and there is no significant shoulder erosion. If a project meets the overlay thickness requirements for Treatment 1, but there is significant shoulder erosion, Treatment 2 must be used in the plans.

For new construction paved shoulder criteria, refer to **Chapter 2** of this volume. Shoulder cross slope is addressed in **Section 25.4.6**.

25.4.9 Side Slopes

The values selected shall be the flattest that are practical. On RRR projects where existing ditches can be modified for stormwater management purposes, the use of steeper than standard side slopes and additional depth may be cost-effective but would require a variation. Justification must fully address safety, water depth, frequency and duration, as well as cost-effectiveness. The decision to shield steep side slopes shall be made consistent with the guidelines in the **AASHTO Roadside Design Guide**.

Front Slopes:

1. 1:6 are desirable.
2. 1:4 may be constructed within the clear zone.
3. 1:3 may be constructed outside the clear zone.
4. Existing front slopes 1:3 or flatter may remain within the clear zone. Shielding may be required.
5. Steeper than 1:3 shall be shielded as per **Design Standards, Index 400, General Notes**.
6. Consideration should be given to flattening slopes of 1:3 or steeper at locations where run-off-the-road type crashes are likely to occur (e.g., on the outsides of horizontal curves).
7. The proposed construction should not result in slopes steeper than the existing slopes in violation of the above values.

Back Slopes:

1. 1:4 are desirable.
2. 1:3 may be constructed in the clear zone.
3. 1:2 may be constructed outside the clear zone without shielding.
4. Existing back slopes 1:2 and flatter may remain.
5. Existing back slopes steeper than 1:3 within the clear zone may require shielding.

25.4.10 Vertical Alignment

Vertical alignment must be reviewed together with the horizontal alignment to assure that the necessary balance of standards is realized and that the combination is both safe and pleasing.

The alignment should be reviewed to see if the following principles are generally satisfied by the existing vertical alignment:

1. The sight distance provided meets or exceeds the values in **Table 25.4.12**.
2. Grades do not significantly affect truck operations.
3. There are no hidden dips which could obscure traffic or hazards.
4. Steep grades and sharp vertical curves do not exist at or near an intersection.
5. Sufficient grades and, when necessary, special gutter grades exist to adequately drain urban projects.
6. Adequate sight distance exists for traffic signals (e.g., beyond overpasses, etc.).

When any of the above conditions do not exist, the designer should evaluate for hazardous conditions and determine if corrective measures are warranted.

25.4.10.1 Vertical Curvature

The designer shall use the method given in **Table 25.4.10.1** to check the sufficiency of vertical curves and provide any indicated corrective measures. When an evaluation is required, it shall consider:

1. The nature of potential hazards hidden by a hill crest.
2. The location of the hazard in relation to the portion of the highway where sight distance falls below new construction criteria.
3. Effectiveness of other options such as relocating or correcting the hazard.
4. Providing warning signs.

Sag vertical curves do not normally pose sight distance problems, therefore only existing sag vertical curves where crash history (related to the curve) indicates a problem must be evaluated against new construction criteria. An evaluated sag vertical curve that does not meet the minimum K value in **Table 2.8.6** requires a Design Exception to remain. Sag vertical curves that are to be reconstructed must meet new construction criteria. Sag vertical curves without crash problems that fall below new construction criteria do not require Design Exceptions or Design Variations to remain.

Table 25.4.10.1 K Values for Vertical Curvature

DESIGN SPEED (mph)	K Values	
	Crest Vertical Curves	
	A ⁽¹⁾	B ⁽²⁾
15	5	3.0
20	10	6.1
25	18	11.1
30	30	18.5
35	47	29.0
40	70	43.1
45	98	60.1
50	136	83.7
55	184	113.5
60	244	150.6
65	313	192.8
70	401	246.9

1. The "A" values are based on an eye height of 3.5 feet and an object height of 0.5 feet.

2. The "B" values are based on an eye height of 3.5 feet and an object height of 2.0 feet.

3. For the design speed, compare the K value to the tabulated values using the following formula:

$$K = \frac{L}{A}$$

Where: K = Rate of vertical curvature
 L = Length of vertical curve, (feet)
 A = Algebraic difference in grades, (percent)

a. If the K value is equal to or greater than the "A" value, the curve is satisfactory.

b. If the K value is equal to or greater than the "B" value, but less than the "A" value, a study **should** be made to evaluate possible mitigation of hazards requiring driver reaction and/or appropriate treatment (i.e. relocation of the hazard, hazard warning signs, reduced safe speed signs, etc.).

c. If the K value is less than the "B" value, **reconstruction** of the curve is required, or an exception must be obtained.

25.4.10.2 Grades

Grades which satisfied the standards in effect at the time of construction may be used provided the result is consistent with the design principles in **Section 25.4.10**. Grades which are not consistent with these design principles must be evaluated.

25.4.11 Horizontal Alignment

Vertical and horizontal alignment must be reviewed together to assure that the necessary balance of standards is realized and the combination is both safe and pleasing.

The designer should review the alignment to identify that the existing alignment generally adheres to the following guidelines:

1. Consistent with no sudden changes from easy to sharp curvature.
2. Sufficient tangent length between reverse curves.
3. Superelevation transitions provided.
4. Maximum curvature is not used:
 - a. On high fills or elevated structures.
 - b. At or near crest in grade.
 - c. At or near low points in grade.
 - d. At the end of long tangents.
 - e. At or near intersections or points of access or egress.
 - f. At or near decision points.

At all locations where the existing alignment does not adhere to these conditions, the designer should evaluate for hazardous conditions and determine if corrective measures are warranted.

25.4.11.1 Horizontal Curves

Horizontal curves shall be reviewed for horizontal curvature and superelevation. Review existing curves against the values in **Table 25.4.11.1**. Every practical attempt shall be made to upgrade curves which are below State Highway System (SHS) minimum values for new construction. The review should also include an on-site review for evidence of near crashes or operational problems.

1. Horizontal Curvature

Condition #1 - Horizontal curves that meet or exceed the SHS minimum radius values are satisfactory unless there is a significant crash history (3 or more crashes within the most recent 5-year) or other evidence of safety or operational problems. If problems are identified corrective measures shall be included in the project.

Condition #2 - Curves which are below the SHS minimum radius values but meet or exceed the RRR minimum radius values shall be reviewed for specific safety problems at the curve. If the review indicated significant operational or safety problems exist, the curve must be reconstructed. If problems are identified but reconstruction is not warranted, corrective measures shall be included in the project.

Condition #3 - Those curves which do not meet the RRR minimum radius values must be reconstructed or a design exception must be obtained. Reconstructed curves shall meet the criteria for new construction contained in **Chapter 2** of this volume. Sufficient time and budget must be programmed into the RRR project to obtain any right of way necessary for reconstruction of the curve.

2. Superelevation

Rural Curves - Existing rural curves not having the indicated superelevation rate on the **Design Standards, Index 510** shall be corrected to that rate. Other measures appropriate to correct or improve identified safety or operational problems shall be provided.

Urban Curves - Existing urban (C&G) curves not having the indicated superelevation rate on the **Design Standards, Index 511** shall be corrected to that rate by reconstruction of the curve or, if practical, curb adjustment to accommodate overbuild. Other measures appropriate to correct or improve identified safety or operational problems shall be provided.

3. PIs Without Curves

Where alignments have PIs without curves that exceed the new construction values in **Table 2.8.1**, consideration should be given to reconstructing the roadway with suitable curvature.

**Table 25.4.11.1 Safe Criteria for State Highway System
 With Maximum Superelevation**

DESIGN SPEED (mph)	$e_{max.} = 0.10$				$e_{max.} = 0.05$			
	SHS		RRR		SHS		RRR	
	D_{max}	$R_{min.}$ (ft.)	D_{max}	$R_{min.}$ (ft.)	D_{max}	$R_{min.}$ (ft.)	D_{max}	$R_{min.}$ (ft.)
30	24° 45'	231	30° 30'	188	20° 00'	286	25° 45'	223
35	17° 45'	323	20° 45'	276	14° 15'	402	17° 15'	332
40	13° 15'	432	14° 45'	388	10° 45'	533	12° 15'	468
45	10° 15'	559	11° 00'	521	8° 15'	694	9° 00'	637
50	8° 15'	694	8° 30'	674	6° 30'	881	6° 45'	849
55	6° 30'	881	6° 45'	849	N/A		N/A	
60	5° 15'	1091	5° 30'	1042	N/A		N/A	
65	4° 15'	1348	4° 30'	1273	N/A		N/A	
70	3° 30'	1637	3° 45'	1528	N/A		N/A	

25.4.12 Stopping Sight Distance

Stopping sight distance requirements are provided in **Table 25.4.12**.

Table 25.4.12 Stopping Sight Distance

DESIGN SPEED (mph)	STOPPING SIGHT DISTANCE (ft.)
15	80
20	115
25	155
30	200
35	250
40	305
45	360
50	425
55	495
60	570
65	645
70	730

25.4.13 Vertical Clearance

The following clearances apply to highway bridges (to remain or be modified only) and other roadway features over the entire roadway. Entire roadway includes lanes and shoulders. Replacement structures shall be to new construction standards.

Underpass Clearance - For roadways passing under existing bridges, vertical clearance shall be at least 14 ft. over the entire roadway. Signing and warning features shall be provided whenever vertical clearance is less than 14 ft. 6 inches. The existing vertical clearance shall not be reduced by the RRR project if the existing clearance is 16 ft. or less.

Low Member Clearance - Existing bridges with sway bracing members over the bridge deck shall have at least 14 ft. clearance over the entire roadway.

Signs and Traffic Control Devices - Clearances shall be provided consistent with new construction standards.

25.4.14 Horizontal Clearance

Horizontal clearance is the lateral distance from a specified point on the roadway such as the edge of the travel lane or face of curb, to a roadside feature or object. Horizontal clearance applies to all highways. Horizontal clearance requirements vary depending on the design speed, whether rural or urban with curb, traffic volumes, lane type, the object or feature, and whether the object is or is not within a control zone as described in the following **Sections 25.4.14.1** and **25.4.14.2**.

25.4.14.1 Control Zones

Control zones are areas in which it can be statistically shown that crashes are more likely to involve departure from the roadway with greater frequency of contact with above ground fixed objects. These are described below and shown in **Exhibit 25-A**. The horizontal clearance requirements and clear zone widths in Control Zones are based on new construction criteria provided in **Chapter 2, Section 2.11** of this volume.

1. An above ground fixed object having been hit 3 times or more within 3 consecutive years in the last 5 years.
2. Within the return radii of an intersecting street and the new construction horizontal clearance distance.
3. For 'T' intersections (on the non-intersection side) within the area defined by a line through the center of the return radii and return point of tangent extended across the street to the rights of way limits.
4. For a distance of 100 ft. measured downstream from the point of intersection of a right turn deceleration lane and where full lane width is achieved within the new construction horizontal clearance distance (It is assumed the edge of pavement is not constructed on a reverse curve. If it is, the measurement is taken from the point of intersection of the trailing curve).
5. For a distance of 100 ft. measured downstream from the point of intersection of a full lane termination with a skewed merge section within the new construction horizontal clearance distance (It is assumed the edge of pavement is not constructed on a reverse curve. If it is, the measurement is taken from the point of intersection of the leading curve).
6. For a distance of 3 ft. from a driveway flare within the new construction horizontal clearance distance at the intersection of a dedicated intersecting service facility such as an alley way or easement.
7. For a distance of 3 ft. from a driveway flare within the new construction horizontal clearance distance at the entrance turnout for use other than a private residence.
8. The area on the outside of a curve when the operating speed exceeds 35 mph or downstream of a kink in the alignment for a distance of 100 feet. In each case the area falls within the new construction horizontal clearance distance unless protected by a barrier. For curves, if the radius exceeds 3000 feet, no control zone exists and control zone requirements do not apply. For kinks in the alignment, if the kink is less than 5 degrees, no control zone exists specifically for the kink and therefore control zone requirements for kinks do not apply.

25.4.14.2 Areas Outside Control Zones

Outside of Control Zones, horizontal clearance requirements are based on new construction criteria provided in **Chapter 2, Section 2.11** of this volume. When these requirements are deemed impractical the original project horizontal clearance requirements are to be used unless the following horizontal clearance requirements are greater.

Rural highways with flush shoulders and highways with curb or curb and gutter where right of way is not restricted have roadsides of sufficient widths to provide clear zones; therefore, the horizontal clearance requirements for certain features and objects are based on maintaining a clear zone wide enough to provide the recoverable terrain in **Table 25.4.14.1**. The procedure for determining required clear zone widths is described in **Chapter 4** of this volume.

In urban areas, horizontal clearance based on clear zone requirements for rural highways should be provided wherever practical. However, urban areas are typically characterized with lower speed (Design Speed \leq 45 mph), more dense abutting development, closer spaced intersections and accesses to property, higher traffic volumes, more bicyclists and pedestrians, and restricted right of way. In these areas, curb with closed drainage systems are often used to minimize the amount of right of way needed. Highways with curb or curb and gutter in urban areas where right of way is restricted do not have roadsides of sufficient widths to provide clear zones; therefore, while there are specific horizontal clearance requirements for these highways, they are based on clearances for normal operation and not based on maintaining a clear roadside for errant vehicles. It should be noted that curb has no redirection capabilities except at speeds less than the lowest design speeds used on the State Highway System. Therefore curb should not be considered effective in shielding a hazard. Curb is not to be used to reduce horizontal clearance requirements.

Crashworthy objects shall meet or exceed the offsets listed in **Tables 25.4.14.2** through **Table 25.4.14.10** and objects that are not crashworthy are to be as close to the right of way line as practical and no closer than the offset listed in **Tables 25.4.14.2** through **Table 25.4.14.10**.

Table 25.4.14.1 Recoverable Terrain

DESIGN SPEED (mph)	TRAVEL LANES & MULTI-LANE RAMP (feet)	AUXILIARY LANES & SINGLE LANE RAMP (feet)
< 45	6	6
45 ⁽¹⁾	14	8
> 45	18	8

GENERAL NOTES:

(1) May be reduced to <45 mph widths if conditions more nearly approach those for low speed (40 mph or less).

The above values are to be used in the process for determining the clear zone width as described in **Chapter 4** of this volume.

Table 25.4.14.2 Horizontal Clearance for Traffic Control Signs

PLACEMENT	Placement shall be in accordance with the <i>Design Standards</i> . Placement within sidewalks shall be such that an unobstructed sidewalk width of 4 feet or more (not including the width of curb) is provided.
SUPPORTS	Supports, except overhead sign supports, shall be breakaway. When practicable, sign supports should be located behind barriers that are justified for other reasons. Overhead sign supports shall be located outside the clear zone unless shielded.

Table 25.4.14.3 Horizontal Clearance for Light Poles

CONVENTIONAL LIGHTING	<p>Shall not be located in the median except in conjunction with barriers that are justified for other reasons.</p> <p>Supports shall be breakaway, except for median barrier mounted or shielded light poles.</p> <p>Urban Curb or Curb and Gutter (Design Speed ≤ 45 mph): Shall be located no closer than 4 feet from face of curb (may be 1.5 feet from face of curb when all other alternatives are deemed impractical). Placement within sidewalks shall be such that an unobstructed sidewalk width of 4 feet or more (not including the width of curb) is provided.</p> <p>All other facilities: Shall be located no closer than 20 feet from the travel lane or 14 feet from an auxiliary lane (may be clear zone width when clear zone is less than 20 feet).</p>
HIGH MAST LIGHTING	Shall be located outside the clear zone unless shielded.

Table 25.4.14.4 Horizontal Clearance for Utility Installations

ABOVE GROUND OBJECTS	See the <i>Utility Accommodation Manual (UAM)</i> , (Topic No. 710-020-001) for horizontal clearance criteria for utilities. The <i>UAM</i> is available online at: http://www.dot.state.fl.us/rddesign/utilities/
-------------------------------------	---

Table 25.4.14.5 Horizontal Clearance to Signal Poles and Controller Cabinets for Signals

Shall not be located in medians. Shall be located outside the clear zone except as follows: Urban Curb or Curb and Gutter (Design Speed \leq 45 mph): Shall be located no closer than 4 feet from face of outside curbs and outside the sidewalk. However, when necessary the signal poles may be located within sidewalks such that an unobstructed sidewalk width of 4 feet or more (not including the width of curb) is provided. Also, when site conditions make the 4-foot clearance impractical, clearance may be reduced to 1.5 feet.

Table 25.4.14.6 Horizontal Clearance to Trees

New plantings shall meet new construction criteria. Existing trees where the diameter is or is expected to be greater than 4 inches (measured 6 inches above the ground) shall be located outside the clear zone except as follows: Urban Curb or Curb and Gutter (Design Speed \leq 45 mph): <ul style="list-style-type: none">• 1.5 feet from face of outside curbs,• 3.5 feet from edge of inside traffic lane.

Table 25.4.14.7 Horizontal Clearance to Bridge Piers and Abutments

Bridge Piers and Abutments shall be located in accordance with Table 2.11.6
--

**Table 25.4.14.8 Horizontal Clearance to Railroad Grade Crossing
Traffic Control Devices**

Shall be located in accordance with the *Design Standards*.

Table 25.4.14.9 Horizontal Clearance to Other Roadside Obstacles

Shall be located outside the clear zone except as follows:

Urban Curb or Curb and Gutter (Design Speed \leq 45 mph):

Shall be located no closer than 4 feet from face of curb (may be 1.5 feet from face of curb when all other alternatives are deemed impractical).

Note: Horizontal clearance to mailboxes is specified in the construction details contained in the *Design Standards, Index No. 532*.

Note: Transit and school bus shelters shall be placed in accordance with *Rule Chapter 14-20.003, Florida Administrative Code*. Transit bus benches shall be located in accordance with *Rule Chapter 14-20.0032, F.A.C.*

Table 25.4.14.10 Horizontal Clearance to Canal and Drop-off Hazards

See *Chapter 4* of this Volume for horizontal clearance criteria for canal and drop-off hazards.

25.4.15 (Reserved)

25.4.16 Border

The minimum border width shall be the greatest of the following:

1. The border width used in the original project.
2. The border width required to satisfy ADA accessibility standards.
3. 8 feet.

When right of way is being acquired for other reasons, the minimum border width shall be that used for new construction projects; however, the minimum length of wider border width shall be a segment of sufficient length to provide reasonable continuity.

25.4.17 Intersections

Intersections shall be evaluated to determine those that need a traffic engineering study. The following items should be considered:

1. Traffic Signal Mast Arms or single point attachment span wires within the mast arm policy area (see **Section 7.4.12**) where existing strain poles require replacement/relocation.
2. Addition of right and left turning lanes.
3. Realignment of intersection.
4. Adequate turning radii for left and right turning lanes.
5. Use of channelization to reduce excessive areas of conflict at large intersections.
6. Placement of crosswalks as related to sidewalks and stop bars.
7. Locations of pedestrian, bicycle, and transit facilities.
8. Locations of utilities, signal poles, controller cabinets, lighting poles and drainage structures as related to sidewalks and curb ramps.
9. Warrants for traffic control systems.
10. Addition of signal backplates where it would not require structural modifications to mast arms or span wire systems.
11. Addition of auxiliary heads where it would not require structural modifications to mast arms or span wire systems.
12. Installation of buried conduit for future traffic control systems.
13. Lighting for intersection illumination.
14. Adequate sight distance.
15. ADA needs.

Corrective measures shall be included in projects having T-intersections with significant crash histories (3 or more crashes of a specific type within the most recent 5-years) or other evidence of safety or operational problems.

Due to funding limitations, improvements other than those needed for safety and minimum criteria must be carefully considered before inclusion in the project (see **Section 25.2**). The extra cost associated with improvements requested by local governments that exceed FDOT criteria, e.g. installation of mast arm signal supports in areas beyond the mast arm policy area, should be paid for by the local government making the request.

25.4.18 Drainage

The designer or drainage specialist must evaluate the hydraulic and physical adequacy of the existing drainage system. This requires examination of the existing drainage in the field and by consulting with maintenance personnel and records. If there are apparent problems with the existing drainage system, additional evaluation is required to determine the extent and type of improvements necessary to upgrade the system. The ***FDOT Drainage Manual (Topic No. 625-040-002)*** contains design criteria and methods which provide guidance in formulating suitable drainage features, either through modification or replacement.

Prior to selecting any plan of highway improvement, the designer should consult with drainage and environmental permitting specialists since almost all roadway modifications reduce storage and infiltration and increase discharge rates and volumes. Stormwater retention and detention for quality, rate and volume may be required. Theoretical evaluation of proposed changes to existing and new drainage features necessary to correct operational deficiencies should be referred to a drainage specialist. The drainage specialist will provide the necessary drainage design, flood data information, drainage related information for the Stormwater Pollution Prevention Plan (SWPPP) and any stormwater permit computations.

Due to funding limitations, improvements other than those needed for safety and minimum criteria must be carefully considered before inclusion in the project (see ***Section 25.2***).

25.4.19 Pedestrian, Bicyclist and Transit Needs

Whenever a RRR project is undertaken, pedestrian and bicyclist needs must be addressed, and transit needs should be considered. Recommendations by the District Pedestrian/Bicycle Coordinator and the District Modal Development Office shall be obtained; local government and transit agency contact in developing these recommendations is essential. This should be part of the project scoping and programming effort.

25.4.19.1 Pedestrian Needs

1. Sidewalks and Shared use Paths

On RRR projects, detectable warnings and curb ramps shall be brought into compliance with ADA requirements. This includes installing new detectable warnings for both flush shoulder and curbed roadway connections and signalized driveways where none exist or do not meet current requirements. New curb ramps shall be provided on curbed roadways where none exist; existing substandard curb ramps shall be replaced. Existing ramps not meeting detectable warning requirements which otherwise comply with ADA, shall be retrofitted with detectable warnings. (See *Design Standards, Index 304 & 310.*)

Pull boxes, manholes, and other types of existing surface features in the location of a proposed curb ramp or detectable warning should be relocated when feasible. When relocation is not feasible, the feature shall be adjusted to the new ramp to meet the ADA requirements for surfaces (including the provision of a non-slip top surface, and adjustment to be flush with and at the same slope as the curb ramp).

When compliance with ADA curb ramp requirements is determined to be technically infeasible documentation as a Design Variation is required. This may occur where existing right of way is inadequate and where conflicts occur with existing features that cannot be feasibly relocated or adjusted, e.g., drainage inlets, signal poles, pull boxes, etc...

Other than meeting detectable warning and curb ramp requirements, existing sidewalks and flared driveway turnouts are not required to be upgraded for the sole purpose of meeting ADA requirements, unless included in the project scope by the District. All new sidewalk and driveway construction or reconstruction included on RRR projects shall be designed in accordance with ADA requirements. However, even if new sidewalk is to be constructed, non-conforming driveways are not required to be upgraded.

2. Medians

Medians shall be evaluated to determine if modifications such as pedestrian refuge sections are necessary. 5-lane and 7-lane sections are restricted or eliminated under current policy, usually by the introduction of a raised or restrictive median, which enhances the opportunity to accommodate pedestrian needs. Traffic separators with a width sufficient to provide refuge should be used at intersections where possible. When adequate pedestrian refuge cannot be provided at the intersection, midblock islands should be provided.

Design details for disability access features including sidewalk, curb ramps and driveway turnouts are found in the **Design Standards**. Additional standards for ADA are found in the regulations and design guidelines issued by the Secretary of the U.S. Department of Transportation.

25.4.19.2 Bicyclist Needs

1. Bicycle Lanes, Wide Curb Lanes, Paved Shoulders

For existing sections without bicycle facilities where no widening is planned, consideration shall be given to reducing lane widths to provide bicycle lanes, wide curb lanes, or paved shoulders. These facilities shall meet the criteria provided in **Chapter 8**. Existing thru lane widths on urban multi-lane roadways and two-lane curb and gutter roadways shall not be reduced to less than 11 feet for design speeds ≥ 40 mph, and to no less than 10 feet for design speeds ≤ 35 mph. See **Section 25.4.5** for additional information on lane widths. Coordinate with the District Public Transportation (Modal Development) Office and local transit agency when considering the reduction of lane widths on roadways where public transit routes are present. When bicycle facilities are not provided in accordance with **Section 8.1**, a Design Variation is required.

2. Right Turn Lanes

Bicycle lanes at right turn lanes shall meet the criteria provided in **Section 8.4.4**.

3. Drainage Inlets, Grates, Utility Covers

Existing drainage inlets, grates and utility covers shall be evaluated as to whether they present an obstruction to bicyclists, and should be relocated out of the cyclist's path of travel. Drainage inlets, grates and utility covers to remain should be adjusted to be flush with the adjacent pavement surface, utilize a grate recommended for bicycle travel, and be marked as an obstruction. See the **MUTCD** and **Design Standards** for further information. Existing inlets, grates or covers which present gaps sufficient to trap the wheel of a bicycle should be referred to the Maintenance Office for remediation until the project is constructed.

25.4.19.3 Transit Needs

1. Sidewalks and Transit Facilities

A 5-foot wide sidewalk that connects a transit stop or facility with an existing sidewalk or shared use path shall be included to comply with ADA accessibility standards.

25.4.20 Utilities (Underground and Overhead)

Horizontal clearance criteria are given in **Table 25.4.14.4** and in the **Utility Accommodation Manual (UAM)**. Additional clearance criteria are found in the **UAM**.

25.4.21 At-grade Railroad Crossings

When highway improvements are undertaken that include at-grade railroad crossings, the physical and operational characteristics shall be reviewed and upgraded to meet minimum standards. Recommendations shall be made by the District Railroad Coordinator for incorporation into the project.

See **Design Standards, Index 560** for minimum vertical alignment criteria.

See **Chapter 6** of this volume and the **Design Standards** for additional information.

25.4.22 Aesthetics and Landscaping

Landscaping, including median and intersection treatment, shall be consistent with the criteria in this manual and the **Design Standards, Index 546**. Landscape improvements are normally done in response to local government requests and may involve intergovernmental agreements to cover the cost of installation as well as maintenance.

Due to funding limitations, improvements other than those needed for safety and minimum criteria must be carefully considered before inclusion in the project (see **Section 25.2**).

See **Chapter 9** of this volume for additional information and requirements on landscaping.

25.4.23 Highway Lighting

Lighting may be installed at specific locations to improve safety. For example:

1. Reducing the effects of ambient light conditions.
2. Busy or high crash intersections.
3. Transit stops.
4. Channelized intersections.
5. Car pool parking lots.
6. Pedestrian and bicycle crossings.
7. Ramp terminals.

Any lighting, existing or proposed, shall be reviewed by the District Lighting Engineer to determine specific needs. Lighting shall meet new lighting criteria, found in **Chapter 7** of this volume.

25.4.24 Highway Traffic Control Devices

Traffic control devices such as signals, signing, and pavement markings shall be updated as required to comply with the *Manual on Uniform Traffic Control Devices*, the *Manual on Uniform Traffic Studies*, the Department's *Design Standards* (excluding the structures of such traffic control devices per **Section 25.4.27**), and the ADA design guidelines issued by the Secretary of the U.S. Department of Transportation. The District Traffic Operations Engineer (or staff) shall determine any new or additional devices required.

25.4.25 Bridges

On each project, a determination must be made as to whether an existing bridge should remain as is, be rehabilitated or be replaced. This determination should be made as early as practical due to the potential impact to the work program. Pavement resurfacing funds can only be used for minor bridge improvements such as rail retrofits and ADA improvements. Bridges that require major improvement or replacement must be programmed with the appropriate bridge program funds.

The determination of bridge improvement needs must be supported by an engineering analysis/report and be based on an assessment of the bridge's structural and functional adequacy. The engineering report must include the project description, an operational impact evaluation, safety impacts, and a benefit/cost analysis. The safety impacts must include a detailed review of crash history, severity, contributing factors, etc. If the engineering analysis determines it is not feasible to bring the bridge in full compliance with minimum criteria, a design exception or variation addressing the feature(s) not meeting criteria must be processed in accordance with **Chapter 23** of this volume. The engineering analysis/report should be used to support the exception or variation.

If a bridge is found to be functionally obsolete but structurally sound, complete replacement is usually not warranted. For these type structures a full range of possible improvements must be considered, including improvements that enhance safety but do not necessarily bring the bridge into full compliance with minimum criteria. Improvements such as upgrading of connecting guardrail systems, approach roadway or shoulder widening, "Narrow Bridge Ahead" signing, or other appropriate feature modifications should be considered as appropriate. Widening of the structure itself, or rail retrofit, are also options that should be addressed. The designer should always review the Department's work program to see if a structure is scheduled for replacement in the near future, before determining short term improvements.

If the structure is on the Florida Intrastate Highway System (FIHS)/Strategic Intermodal System (SIS), the designer should also consider any improvements based on future alignment and possible lane additions required for an FIHS/SIS corridor. For example: if a bridge is to be replaced, the corridor is on the FIHS/SIS, and the project will be multilaned in the future, the new bridge should be aligned to fit future typical sections.

25.4.25.1 Bridge Loading

Bridges shall have an Inventory Load Rating equal to or greater than the load requirements shown in the following table:

Table 25.4.25.1 Bridge Loading

Type	Load Requirement
Collector Facilities	HS-15
Arterial Facilities	HS-20

25.4.25.2 Bridge Width

Bridges shall meet or exceed the following clear width criteria. If lane widening is planned as part of the RRR project, the minimum useable bridge width shall be determined using the width of approach lanes after widening.

Table 25.4.25.2 Clear Width Criteria for Bridges

Design Year ADT		Minimum Usable Bridge Width (ft.)
UNDIVIDED	0 - 750	Total width of approach lanes + 4
	751 +	Total width of approach lanes + 8
DIVIDED	ALL	Total width of approach lanes + 5.5 (median separator) * Total width of approach lanes + 6.5 (median barrier wall)**
ONE WAY BRIDGES	ALL	Total width of approach lanes + 6.5 (2.5 Lt. and 4.0 Rt.)

* 1.5 ft. median and 4 ft. outside shoulder

** 2.5 ft. median and 4 ft. outside shoulder

If widening is required, it shall be in accordance with the **Structures Design Guidelines** and meet the geometric requirements for new construction.

25.4.25.3 Bridge Railing

Florida bridge railing must meet or exceed design strength specified in the **AASHTO "LRFD Bridge Design Specifications"**. In addition, FDOT is moving towards full implementation of **NCHRP Report 350** crash test criteria for bridge traffic railing, and FDOT policy is to bring all bridge traffic railing to current standards on bridges that are being widened or rehabilitated. Bridge traffic railings are required to be evaluated for conformance to current standards whenever any improvements are made to any bridge or its approach roadway. An existing obsolete bridge traffic railing within a RRR project must be brought up to current standards, or else a design exception must be obtained for the project, providing that railing replacement or retrofit, or entire bridge replacement, is scheduled within a reasonable time. Structures Design Office staff are available to advise Districts on options.

The Thrie Beam Guardrail Retrofit and Vertical Face Retrofit **Design Standards, Index 470 and 480 Series** respectively, are suitable for retrofitting specific types of obsolete bridge traffic railings. These retrofits provide a more economical solution for upgrading obsolete traffic railings when compared with replacing the obsolete traffic railings and portions of the bridge decks that support them. As these retrofits do not provide for any increase in clear width of bridge deck, and in a few cases actually decrease clear width slightly, they should only be considered for use on existing bridges where adequate lane and shoulder widths are present. Detailed guidance and instructions on the use of these retrofits is included in the **Structures Manual, Volume 3**.

All superseded FDOT Standard Traffic Railings conforming to the designs shown on **the Existing FDOT Traffic Railing Details in Volume 3 of the Structures Manual** are both structurally and functionally adequate. Refer to **the Existing FDOT Traffic Railing Details in Volume 3 of the Structures Manual** for information on existing "New Jersey Shape" and "F Shape" Traffic Railings.

Existing bridge traffic railing retrofits constructed in accordance with **1987 through 2000 Roadway and Traffic Design Standards, Index 401, Scheme 16, "Guardrail Continuous Across Bridge"** may be left in place provided the following four criteria are met:

1. The retrofit railing is in good condition.
2. There is not a history of severe crashes at the site.
3. The bridge is not on an Interstate or a high-speed-limited-access facility.
4. The dimension from the center of the W-beam guardrail to the roadway surface is at least 1'-9" (1" tolerance acceptable).

Existing bridge traffic railing retrofits constructed in accordance with **1987 through 2000 Roadway and Traffic Design Standards, Index 401, Schemes 1 and 19 “Concrete Safety Barrier”** may be left in place provided the height of the railing is at least 2’-5” measured from the roadway surface.

All other former FDOT bridge traffic railings not listed above and any other traffic railings that are not based on crash tested designs are inadequate and shall be replaced, retrofitted or excepted, as appropriate, using the criteria included in the **Structures Design Guidelines**.

For guardrail to bridge rail transition requirements, see **Section 25.4.26.2**.

25.4.25.4 Vertical Clearance

For vertical clearance requirements for bridges, refer to **Section 25.4.13**.

25.4.25.5 Considerations

When evaluating bridge replacement or widening, the following should be considered:

1. Cost of replacing the existing bridge with a wider bridge designed to new bridge criteria.
2. Cost of widening the existing bridge (if widening is practical), including life cycle costs of maintaining a widened bridge.
3. The number of crashes that would be eliminated by replacement or widening.
4. The hydraulic sufficiency and the risk of failure due to scour and/or ship impact as well as the consequences of failure.

25.4.25.6 Pier Protection and Design

Pier protection and design shall comply with the requirements provided in **Structures Design Guidelines, Section 2.6**.

25.4.26 Roadside Safety Hardware

Roadside conditions must be reviewed to determine the need for roadside safety hardware. This review must include a review of existing roadside safety hardware for need and adequacy and whether upgrading or replacement is necessary. See **Chapter 4** of this volume for guidance on conducting reviews. All roadside safety hardware on RRR projects must comply with the following requirements.

25.4.26.1 Longitudinal Barriers, Guardrails, Median Barriers

Existing longitudinal guardrail sections must be upgraded or replaced unless they conform to the current **Design Standards, Index 400**. As an exception, existing guardrail constructed with steel offset blocks, but otherwise conforming to the current **Design Standards**, are not required to be upgraded or replaced.

Existing concrete barriers conforming to the current **Design Standards, Index 410**, New Jersey shape barriers, and approved vertical faced concrete barriers may remain in place. Other concrete barrier shapes must be replaced.

All replacements and new installations shall conform to the current **Design Standards**.

The above applies to barriers used for shielding roadside hazards not involving pier protection. See **Structures Design Guidelines, Section 2.6**, for barrier requirements for pier protection

See **Section 25.4.25.3** for bridge rail requirements.

25.4.26.2 Guardrail to Bridge Rail Transitions

Existing guardrail to bridge traffic railing approach and trailing end transitions must be upgraded or replaced unless they conform to one of the following systems.

1. For approach ends of existing standard New Jersey Shape and F Shape bridge traffic railings:
 - a. The nested three beam approach transition shown as **Detail J** in the current **Design Standards, Index 400**.
 - b. For retrofitted installations, the appropriate nested three beam transition shown in the current **Design Standards, Index 402**.

- c. The nested W-beam approach transition shown as **Detail J** in the 1998 edition of the **Roadway and Traffic Design Standards, Index 400**, Sheet 7 of 21. This detail is also shown in the 2000 edition of the **Roadway and Traffic Design Standards, Index 401**, Sheet 1 of 9.

All guardrail replacements and new installations connecting to standard New Jersey Shape and F Shape bridge traffic railings shall conform to the current **Design Standards, Index 400**. For guardrail retrofits connecting to existing bridge traffic railings, see **Design Standards, Index 402** and the **Structures Manual, Volume 3**.
2. For approach ends of existing bridge traffic railing retrofits constructed in accordance with the **1987 through 2000 Roadway and Traffic Design Standards, Index 401, Scheme 16, "Guardrail Continuous Across Bridge"**:
 - a. The W-beam approach transition shown as **Detail J** in the 1987 edition of the **Roadway and Traffic Design Standards, Index 400**, Sheet 9 of 13, upgraded as shown in **Interim Design Standards, Index 403** by the installation of a nested section of W-beam guardrail, additional guardrail posts and offset blocks and a transition block if a curb is not present beyond the bridge end.
 - b. The nested W-beam approach transition shown as **Detail J** in the 1998 edition of the **Roadway and Traffic Design Standards, Index 400**, Sheet 7 of 21, upgraded as shown in **Interim Design Standards, Index 403** by the installation of a transition block if a curb is not present beyond the bridge end. A transition block is not required if a curb is present.
3. For trailing ends of existing bridge traffic railing retrofits constructed in accordance with the **1987 through 2000 Roadway and Traffic Design Standards, Index 401, Scheme 16, "Guardrail Continuous Across Bridge"**:
 - a. In the absence of continuing guardrail, two panels of W-beam guardrail and a Type II End Anchorage as shown in **Design Standards, Index 400** or another approved end anchorage.
 - b. A continuous W-beam guardrail system.
4. For approach ends of existing bridge traffic railing retrofits constructed in accordance with the **1987 through 2000 Roadway and Traffic Design Standards, Index 401, Schemes 1 and 19, "Concrete Safety Barrier"**:
 - a. The appropriate nested thrie beam transition shown in **Design Standards, Index 402**.

- b. The W-beam approach transition shown as **Detail J** in the 1987 edition of the **Roadway and Traffic Design Standards, Index 400**, Sheet 9 of 13, upgraded as shown in **Interim Design Standards, Index 403** by the installation of a nested section of W-beam guardrail, additional guardrail posts and offset blocks and a transition block if a curb is not present beyond the bridge end.
 - c. The nested W-beam approach transition shown as **Detail J** in the 1998 edition of the **Roadway and Traffic Design Standards, Index 400**, Sheet 7 of 21, upgraded as shown in **Interim Design Standards, Index 403** by the installation of a transition block if a curb is not present beyond the bridge end.
 5. For trailing ends of existing bridge traffic railing retrofits constructed in accordance with the **1987 through 2000 Roadway and Traffic Design Standards, Index 401, Schemes 1 and 19, "Concrete Safety Barrier"**:
 - a. In the absence of additional downstream hazards, no end treatment is required.
 - b. When additional downstream hazards are present, an approved W-beam trailing end treatment similar to those shown in **Design Standards, Index 400**.

See **Section 25.4.25.3** for bridge traffic railing requirements.

25.4.26.3 Guardrail Terminals

Existing guardrail terminals must be upgraded or replaced unless they conform to one of the systems identified in the current **Design Standards**. As an exception, existing Type MELTs on high speed facilities are not required to be replaced.

All replacements and new installations shall conform to the current **Design Standards**.

25.4.26.4 Crash Cushions and Attenuators

Existing crash cushions and attenuators must be upgraded or replaced unless they conform to either the current ***Design Standards*** or one of the following systems:

1. G-R-E-A-T
2. Hex-Foam Sandwich System
3. Permanent Sand Barrel Arrays

All replacements and new installations shall conform to the current ***Design Standards***.

THIS PAGE LEFT BLANK INTENTIONALLY

25.4.27 Sign, Signal, and Lighting Structures

25.4.27.1 Existing Structures-Without Planned Additional Loading

Contact the District Structures Maintenance Engineer for replacement recommendations for all sign, signal, and lighting structures within the project. The District Structures Maintenance Engineer will base the recommendations on existing inspection reports, age, importance, structural condition and estimated performance during hurricanes. If necessary, the District Structures Maintenance Engineer may require the structures EOR to complete a structural assessment and /or structural evaluation for some sign, signal, and lighting structures. A structural assessment reports damage, deterioration, or other potential reduction in design capacity. Structural evaluation may range from the review of the structural plans and shop drawings (if available) to detailed structural analysis. If structural evaluation is deemed necessary by the District Structures Maintenance Engineer, evaluate the capacity as described in the following paragraph. When multi column ground signs need to be relocated, they shall be structurally evaluated. Existing signs that meet the new structural requirements may be relocated on the project. Existing signs not meeting the new structural requirements shall not be relocated.

When structural evaluation is required, evaluate the as-built capacity (no allowances for future loads) in accordance with the **Structures Manual Volume 9** and **Appendix C** of the **AASHTO design specifications**. Report the D/C ratios and CSRs. If all D/C ratios and CSRs are less than one, the structure meets current AASHTO design specification requirements. If any D/C ratios or CSRs are greater than one, strengthening or replacement is preferred or a Design Variation can be requested. Send a copy of the evaluation to the District Structures Maintenance Engineer for consideration in replacement recommendations. For guidance on evaluating existing structures without plans, shop drawings, foundation depths, or design calculations, contact the District Structures Design Office.

25.4.27.2 Existing Structures - With Planned Additional Loading

Analyze the proposed structure in accordance with the **Structures Manual Volume 9**. Report the D/C ratios and CSRs. If any D/C ratios or CSRs are greater than one, strengthening or replacement is preferred.

A Design Variation can be requested if the proposed structure fails to meet the design specification in the **Structures Manual Volume 9** but does meet the criteria in **Structures Manual Volume 9** and **Appendix C of the AASHTO design specifications**. If this requirement also fails, a Design Exception can be requested.

25.5 Design Exceptions and Design Variations

Every effort should be made to adhere to the desirable criteria stated herein. However, under unusual conditions, it may be necessary and appropriate to use values that are less than the minimum values shown. If lesser values are proposed for use, these shall be identified and the necessary approval and concurrence obtained at the earliest possible time, but not later than Phase II, so that the denial of any such request will not alter the project letting date. Refer to **Chapter 23** of this volume for the necessary procedure.

Exhibit 25-A Control Zones Sheet 1 of 5

RESTRICTED LOCATIONS FOR ABOVE GROUND FIXED OBJECTS

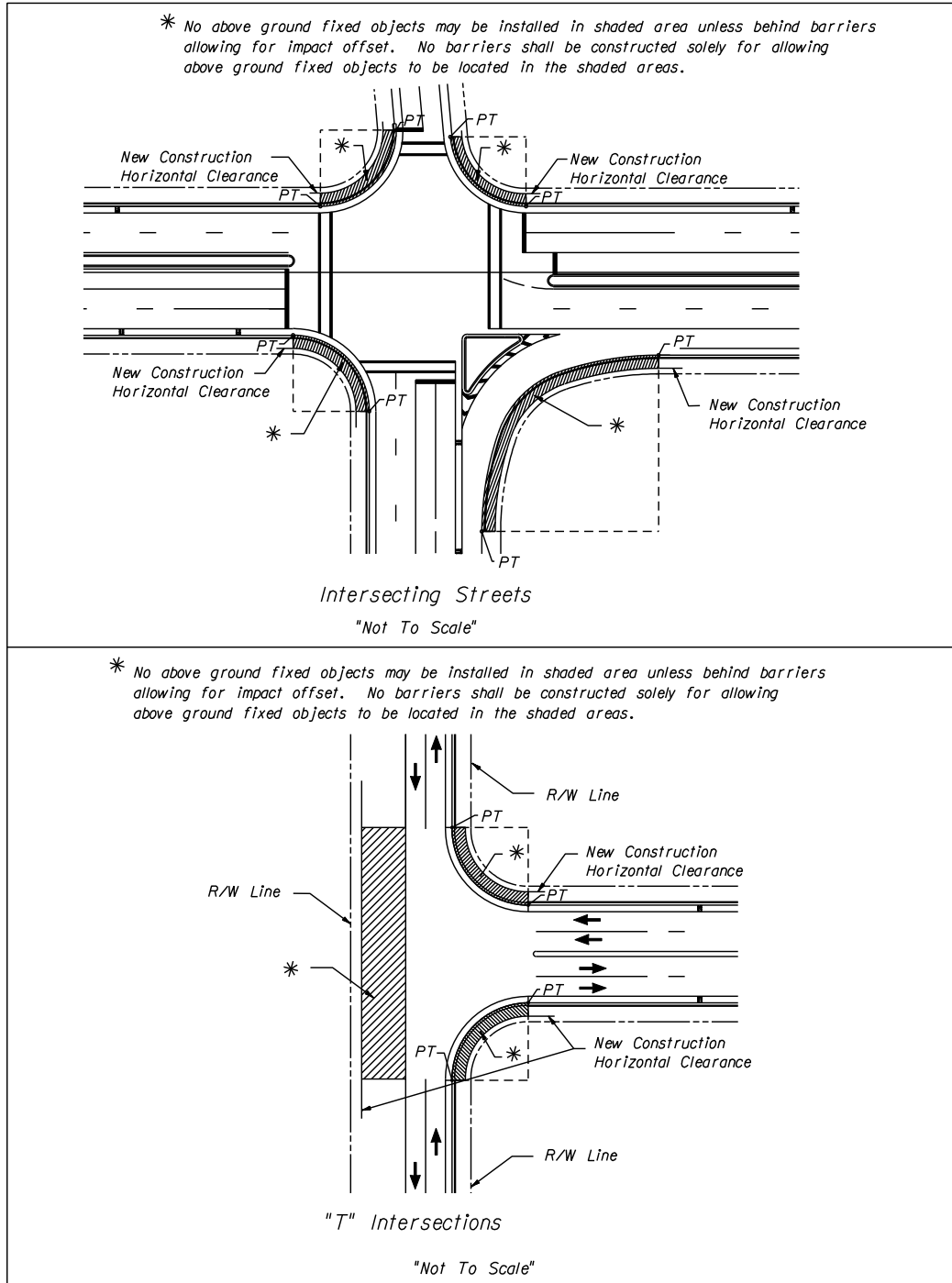

Exhibit 25-A Control Zones Sheet 2 of 5

RESTRICTED LOCATIONS FOR ABOVE GROUND FIXED OBJECTS

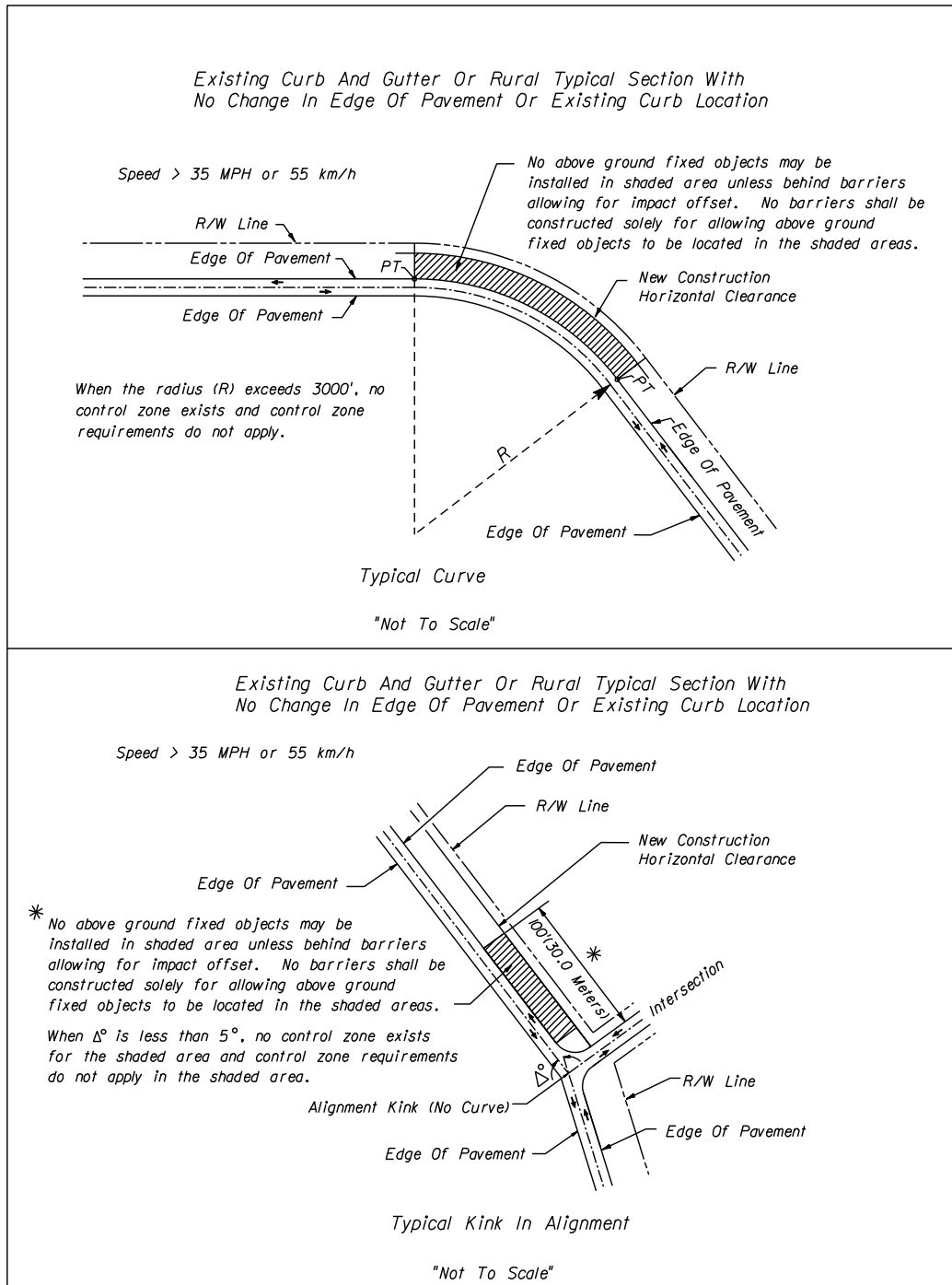
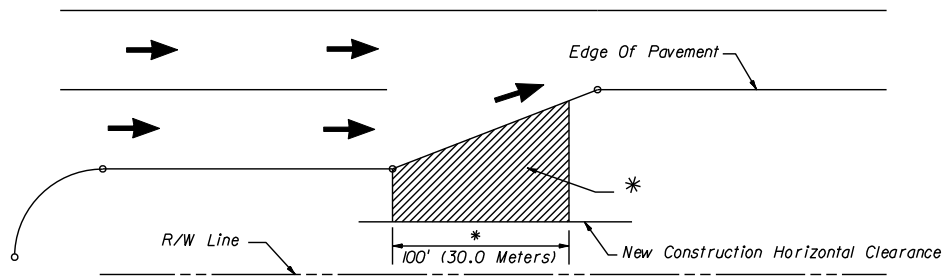

Exhibit 25-A Control Zones Sheet 3 of 5

RESTRICTED LOCATIONS FOR ABOVE GROUND FIXED OBJECTS

* No above ground fixed objects may be installed in shaded area unless behind barriers allowing for impact offset. No barriers shall be constructed solely for allowing above ground fixed objects to be located in the shaded areas.



Lane Termination Using A Skewed Merge Section

"Not To Scale"

* No above ground fixed objects may be installed in shaded area unless behind barriers allowing for impact offset. No barriers shall be constructed solely for allowing above ground fixed objects to be located in the shaded areas.

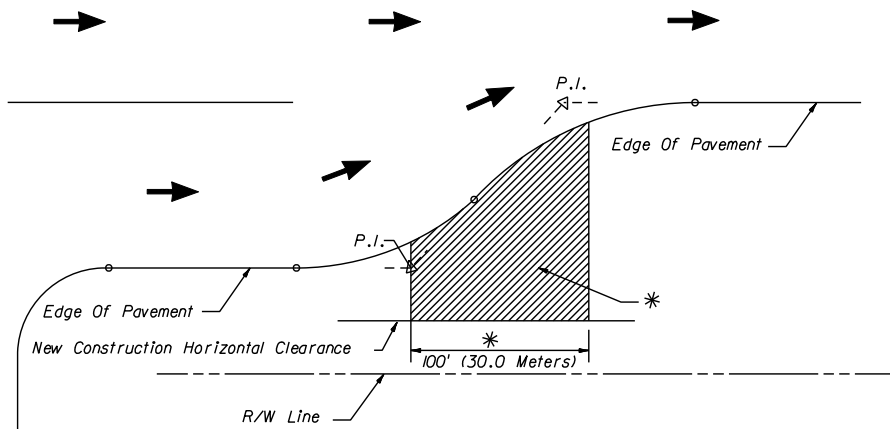

Lane Termination Using A Reverse Curve

"Not To Scale"

Exhibit 25-A Control Zones Sheet 4 of 5

RESTRICTED LOCATIONS FOR ABOVE GROUND FIXED OBJECTS

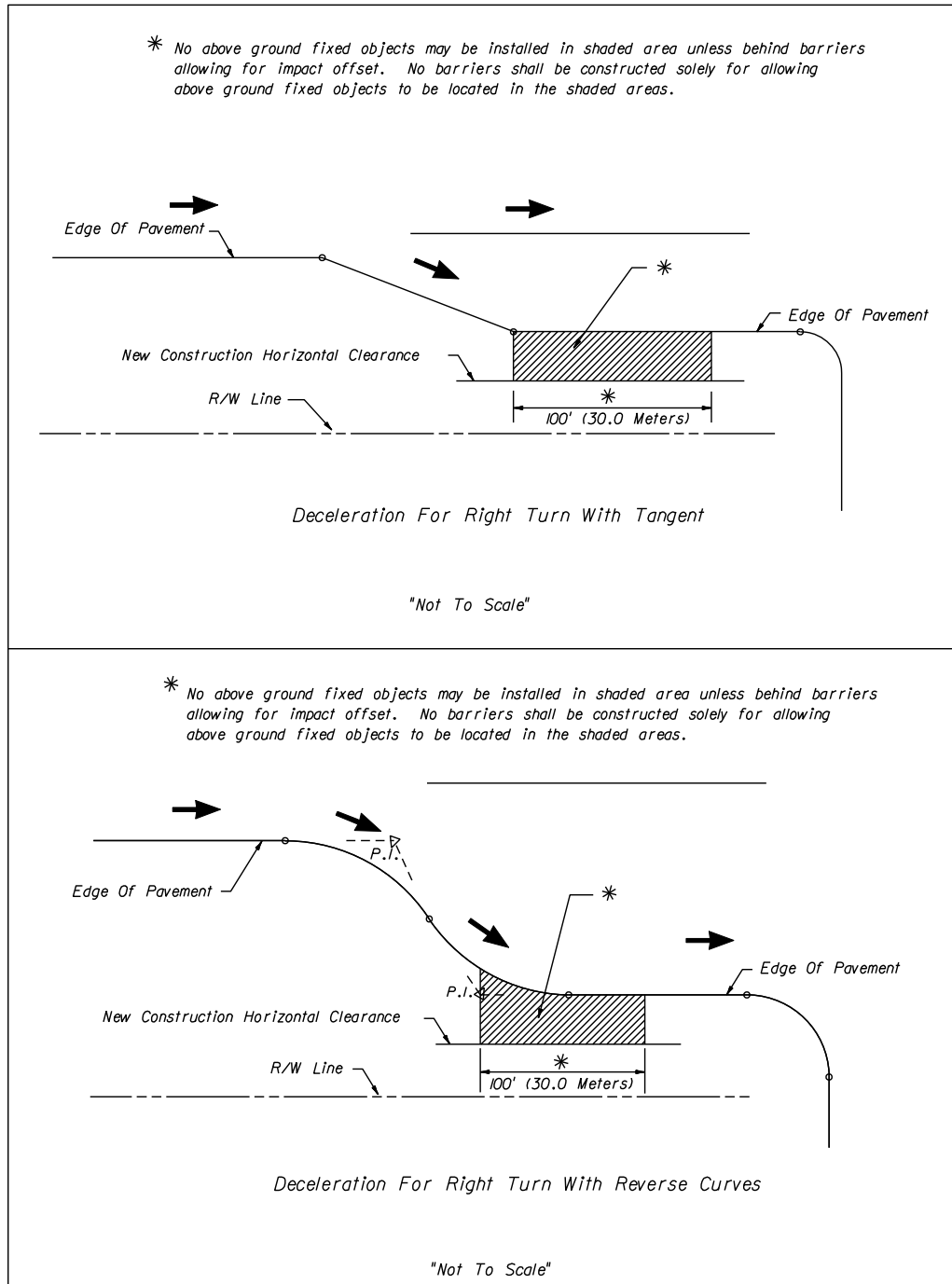
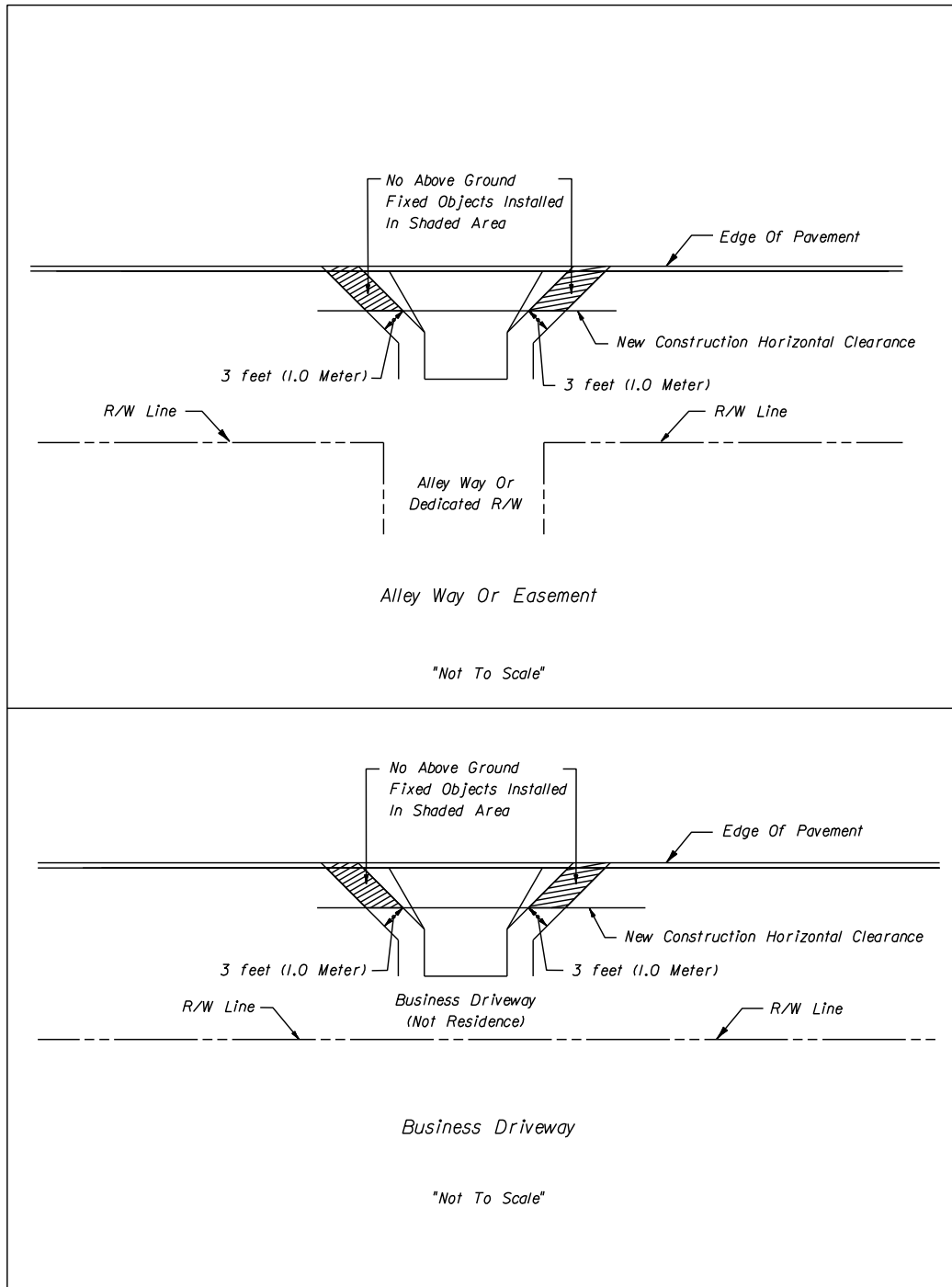

Exhibit 25-A Control Zones Sheet 5 of 5

RESTRICTED LOCATIONS FOR ABOVE GROUND FIXED OBJECTS



THIS PAGE LEFT BLANK INTENTIONALLY

Chapter 26

Bridge Project Development

26.1	General	26-1
26.2	Organization	26-1
26.3	Definitions	26-2
26.3.1	Category 1 Structures	26-2
26.3.2	Category 2 Structures	26-2
26.4	Abbreviations Used in Structures Design.....	26-3
26.5	Responsibility	26-5
26.6	FHWA Oversight	26-5
26.7	Bridge Project Development	26-6
26.8	Bridge Analysis	26-7
26.8.1	General	26-7
26.8.2	Contents.....	26-7
26.9	Bridge Development Report (BDR)/30% Structures Plans	26-9
26.9.1	General	26-9
26.9.2	Contents.....	26-10
26.9.3	Format.....	26-12
26.9.4	Aesthetics	26-13
26.9.5	Construction and Maintenance Considerations	26-15
26.9.6	Historical Significance Considerations	26-15
26.9.7	Bridge Security.....	26-16
26.9.8	Alternative Designs	26-17
26.9.9	Conclusions and Recommendations.....	26-17

26.9.10	30% Structures Plans.....	26-18
26.10	Bridge Development Report (BDR) Submittal Checklist	26-20
26.11	Final Plans and Specifications Preparation.....	26-22
26.11.1	General	26-22
26.11.2	60% Substructure Submittal / 60% Structures Plans.....	26-22
26.11.3	90% Structures Plans.....	26-24
26.11.4	100% Structures Plans and Specifications	26-24
26.12	Independent Peer Review of Category 2 Bridges	26-25
26.13	Plans Assembly.....	26-26
26.14	Plans Submittal	26-26
26.14.1	Schedule	26-26
26.14.2	Submittal Schedule	26-26
26.14.3	Summary of Phase Submittals.....	26-27
26.15	Review for Constructability and Maintainability	26-28
26.15.1	Purpose.....	26-28
26.15.2	Responsibility.....	26-28
26.16	Review for Biddability	26-29
26.16.1	Purpose.....	26-29
26.16.2	Responsibility.....	26-29
26.17	Bridge Load Rating	26-30
26.18	Review of Non-FDOT Funded Projects (New Construction) ...	26-30

Exhibits

Exhibit 26-A	Bridge Development Report (BDR) Submittal Checklist	26-31
Exhibit 26-B	Independent Peer Review Certification Letter (90% Submittal).....	26-32
Exhibit 26-C	Independent Peer Review Certification Letter (100% Submittal).....	26-33
Exhibit 26-D	Summary of Phase Submittals.....	26-34

THIS PAGE LEFT BLANK INTENTIONALLY

Chapter 26

Bridge Project Development

26.1 General

All structural designs for new construction for the Florida Department of Transportation (FDOT) are developed under the direction of the Structures Design Office (SDO) and/or the District Structures Design Offices (DSDO). All designs are to be developed in accordance with the **Structures Manual** which includes the **Structures Design Guidelines (Topic No. 625-020-150)**, the **Structures Detailing Manual (Topic No. 625-020-200)**, this Manual, the **Design Standards (Topic No. 625-010-003)**, and the **AASHTO Standard Specifications for Highway Bridges** or the **AASHTO-LRFD Bridge Design Specifications** as referenced in the Structures Manual, applicable FHWA Directives, and other criteria as specified by the Department.

Designs for repair or rehabilitation of bridges are generally developed under the direction of the District Structures Maintenance Engineer (DSME) and may not include all the submittal types discussed in this chapter.

Structures for other agencies or authorities such as the Jacksonville Transportation Authority, various Expressway Authorities, etc. may be designed to meet the Department's criteria or additional criteria as specified by the authority.

For projects involving bridges over navigable water, the Project Manager must provide the District Structures Maintenance Engineer (DSME) sufficient notification prior to engaging in any action in, on, or around the bridge. Refer to **Section 13.5.3** of this volume for further information.

26.2 Organization

The Structures Design Office (SDO) is a subdivision of the Office of Design under the direction of the State Highway Engineer and the Assistant Secretary for Transportation Policy. The SDO is under the direction of the State Structures Design Engineer (SSDE). Each District, including the Turnpike, has a staff of structural design engineers that comprise the District Structures Design Office (DSDO), and which is under the direction of the District Structures Design Engineer (DSDE).

26.3 Definitions

All structures have been grouped into the following two categories based upon design difficulty and complexity:

26.3.1 Category 1 Structures

Category 1 Structures consist of box or three-sided culverts, short span bridges (continuous reinforced slabs and prestressed slabs), simple span bridges with spans less than 170 feet, continuous straight steel plate girder bridges with spans less than 170 feet, bridge widenings for these structure types, retaining walls, roadway signing, signalization and lighting supports, sound barriers, and overhead sign structures.

26.3.2 Category 2 Structures

A structure will be classified as a Category 2 Structure when any of the following are present: steel box girders, curved steel plate girders, span lengths equal to or greater than 170 feet, cast-in-place concrete box girder bridges, concrete segmental bridges, continuous post-tensioned concrete bridges with or without pretensioning, steel truss bridges, cable stayed bridges, movable bridges, depressed roadways, tunnels, non-redundant foundations, substructures containing post-tensioned components, straddle piers, integral caps, bridges designed for vessel collision, or any design concepts, components, details or construction techniques with a history of less than five (5) years of use in Florida.

26.4 Abbreviations Used in Structures Design

Terminology used in the area of Structures Design for the Florida Department of Transportation often is written or spoken in the form of abbreviations and/or acronyms. Following is a list of those terms frequently encountered in this manual and in other references used in structures design and include those commonly used for offices, organizations, materials, systems, features, equipment, conditions, and expertise:

AASHTO	<i>American Association of State Highway and Transportation Officials</i>
ACI	<i>American Concrete Institute</i>
ACIA	<i>Assigned Commercial Inspection Agency</i>
ADA	<i>Americans with Disabilities Act</i>
AISC	<i>American Institute of Steel Construction</i>
ANSI	<i>American National Standards Institute</i>
AREMA	<i>American Railway Engineering and Maintenance Association</i>
ASTM	<i>American Society for Testing and Materials</i>
AWS	<i>American Welding Society</i>
BBS	<i>Bulletin Board System</i>
BDR	<i>Bridge Development Report</i>
BHR	<i>Bridge Hydraulics Report</i>
BHRS	<i>Bridge Hydraulics Recommendation Sheet</i>
CADD	<i>Computer Aided Design and Drafting</i>
CEI	<i>Construction Engineering and Inspection</i>
C.I.P. (C-I-P)	<i>Cast-in-Place (Concrete)</i>
CPAM	<i>Construction Project Administration Manual</i>
CVN	<i>Charpy V-Notch (Impact Testing)</i>
DSDE	<i>District Structures Design Engineer</i>
DSDO	<i>District Structures Design Office</i>
DSME	<i>District Structures Maintenance Engineer</i>
EMO	<i>Environmental Management Office</i>
EOR	<i>Engineer of Record</i>
FDOT	<i>Florida Department of Transportation</i>
FHWA	<i>Federal Highway Administration</i>
LRS	<i>Low-relaxation Strands</i>
LRFD	<i>Load and Resistance Factor Design</i>
MHW	<i>Mean High Water</i>
MSE	<i>Mechanically Stabilized Earth (Walls)</i>
MUTCD	<i>Manual on Uniform Traffic Control Devices</i>
NHS	<i>National Highway System</i>
NHW	<i>Normal High Water</i>
NOAA	<i>National Oceanic and Atmospheric Administration</i>
OIS	<i>Office of Information Systems</i>

OSHA	Occupational Safety and Health Administration
PDA	Pile Driving Analyzer
PD&E	Project Development and Environment
PPD	Plans Production Date
PPM	Plans Preparation Manual
QPL	Qualified Products List
RDR	Required Driving Resistance
SDO	Structures Design Office
SIP (S-I-P)	Stay-in-Place (Forms)
SRS	Stress-relieved Strands
SSDE	State Structures Design Engineer
TAG	Technical Advisory Group (SDO and DSDEs)
TFE (PTFE)	Polytetrafluorethylene (Teflon)
TRB	Transportation Research Board
UBC	Ultimate Bearing Capacity
UV	Ultraviolet
VECP	Value Engineering Change Proposal

26.5 Responsibility

The District Structures Design Office has total project development responsibility for projects involving Category 1 Structures, upon release by the Structures Design Office. The Structures Design Office has total project development responsibility for projects involving Category 2 Structures. This responsibility for Category 2 Structures extends to rehabilitation projects and repairs of bridge components that qualify the structure as a Category 2 Structure.

The District Project Manager shall coordinate with the District Structures Design Engineer who shall review and concur with the bridge aspect of all projects during the PD&E process in accordance with **Chapter 4** of the **PD&E Manual**.

The District Structures Design Engineer or the State Structures Design Engineer, as appropriate, shall concur/approve all bridge related work after location design approval is granted.

To assure a uniform approach to a project, the engineer shall coordinate with the appropriate Structures Design Office to discuss structures related phase review comments and get concurrence on how to proceed.

26.6 FHWA Oversight

See **Chapter 24** of this volume for FHWA requirements.

26.7 Bridge Project Development

The following sections will define, clarify and list the information necessary to produce an acceptable and reproducible set of contract documents (special provisions, bridge contract drawings, etc.) ready for advertisement and construction.

Bridge project development normally includes five phases of development. The first phase of development, bridge analysis, occurs during the Project Development and Environment (PD&E) process. After location design approval is granted, the second phase, Bridge Development Report/30% Structures Plans, is initiated. After approval of the BDR, the final phases of work will begin. The third phase is the 60% Structures Plans that consists of the substructure foundation submittal for all projects and 60% Structures Plans for most Category 2 Structures. The fourth phase includes the 90% Structures Plans and specifications. The fifth phase includes the 100% Structures Plans and specifications. For efficiency, one engineering firm (one design team) should be responsible for the BDR and the final plans and specifications.

For Category 2 bridges and some Category 1 bridges, step negotiations are suggested. Step negotiations are desirable because the final bridge type cannot be determined until the BDR is complete. Utilizing this scenario, the first step of the negotiations would include the BDR/30% Structures Plans. After submittal of the BDR/30% Structures Plans, negotiations for final three phases of work (60% Structures Plans, 90% Structures Plans and 100% Structures Plans) would begin. Negotiations should not be finalized until the BDR/30% Structures Plans are approved by the DSDO or the SDO as appropriate.

26.8 Bridge Analysis

26.8.1 General

The Bridge Analysis is performed during the PD&E phase by qualified bridge engineers. The District Structures Design Engineer must concur with the findings of the bridge analysis, which is part of the preliminary engineering report. The function of the bridge analysis is to determine the general attributes for the recommended bridge. The specific attributes of the bridge will be defined in the BDR.

For bridges over water, a location Hydraulics Report will be prepared in conjunction with the bridge analysis. General site geotechnical knowledge is also required (usually from existing bridge plans) or, in some cases, it may be desirable to obtain borings.

26.8.2 Contents

The bridge analysis shall provide conceptual guidance for the bridge design consultant. Conceptual guidance on how the bridge should fit into the uniqueness of the site should be provided. Bridge design and structure type should be left to the design team in the later phases of work. Bridge analysis shall include the following:

1. Environmental and site considerations.
2. Vertical and horizontal clearances (existing and proposed).
3. Disposition of existing structure. (Final disposition of demolished bridge debris will depend on whether or not a local, State or Federal agency has agreed to receive the debris. See **Section 13.5.2.3**).
4. Vertical and horizontal geometry.
5. Typical section.
6. Conceptual ship/barge impact data (sample of recreational and commercial traffic).
7. Identification of historical significance of bridge and surrounding structures.
8. Aesthetic level for bridge and bridge approaches.
9. Location Hydraulics Report.
10. Bridge deck drainage considerations.
11. Stream bottom profile.
12. Conceptual geotechnical data.

13. For sites with movable bridge options, a life cycle cost comparison will be prepared and compared to a fixed bridge.
14. Phase Construction Impacts.
15. Construction time.

26.9 Bridge Development Report (BDR)/30% Structures Plans

26.9.1 General

The BDR is intended to establish all the basic parameters that will affect the work done in the Design and Plans Preparation phase. Initiation of the BDR shall occur after location design approval (For some sites only a programmatic categorical exclusion will be required before initiation of the BDR). Once approved, the BDR will define the continuing work by the Engineer of Record (EOR). It is mandatory that the EOR obtain and coordinate the information and requirements of the offices and engineering disciplines whose input is essential to the preparation of an effective BDR. Changes to the parameters after the BDR is approved could result in schedule delays and supplemental agreements; therefore, it is critical that District Offices, FHWA (if involved), the Structures Design Office and other involved agencies recognize the purpose and importance of the BDR. The BDR phase of work will contain sufficient detail for the justification of the proposed bridge type. For most projects, the 30% Structures Plans will be included as an appendix to the BDR. The BDR is developed from information outlined on the Bridge Development Report Submittal Checklist shown in **Exhibit 26-A**, located at the end of this chapter. This information is often provided by others; however, the EOR is responsible for ensuring that all of the information is adequate and appropriate. If the data is not sufficient, the EOR must obtain the required information before the BDR can be completed and submitted.

When alternate designs are considered, consistency between the alternates is essential in ensuring equitable competition and optimum cost-effectiveness. This consistency includes uniformity of design criteria, material requirements and development of unit costs.

The BDR should contain only supportable and defensible statements. Subjective opinions or unsubstantiated statements are not acceptable. All arguments must be clearly and logically defensible with calculations, sketches or other technical data.

The quantity of work necessary to prepare the BDR depends upon the project's complexity; however, the usual work effort for bridge types normally encountered is:

1. **Minor Bridge Widening:** The BDR will be a minor work effort; however, viable structural possibilities and economical options should be thoroughly investigated to determine if replacement of the bridge would be more appropriate than its widening. This is particularly true at sites where the existing bridge condition is marginal, where there has been a record of serious flooding or scouring, when the widening is part of a route improvement with a high potential for attracting traffic, if the existing bridge has a history of structural problems (including vessel collision), or if the

inventory rating is less than required by AASHTO and cannot be improved. Load rating considerations that shall be included in the BDR recommendations are provided in **Section 7.1.1 of the Structures Design Guidelines**.

2. Minor Grade Separations or Small Water Crossings: The BDR shall be a thorough document that adequately addresses all viable structure types; however, the BDR will not usually be an extensive document since the viable types of superstructure and substructure are generally limited. Scour and vessel collision shall be considered.
3. Major Bridges (including Movable) and Major Interchanges: The BDR shall be an extensive and comprehensive document that thoroughly considers all viable structure types and considers all design parameters (such as vessel collision and scour).

26.9.2 Contents

The major items to be considered in the BDR are:

1. General: The bridge length, height and pier locations are subject to vertical and horizontal design clearance requirements such as those for clear zone, navigation and hydrology. After these considerations are met, span lengths are governed by economics and aesthetic considerations. Superstructure depths (grade separation structures in particular) shall be kept to the minimum that is consistent with good engineering practice. Recommended span/depth ratios for steel superstructures are shown in AASHTO.

The length of the bridge will be affected by:

- a. Opening required by the Bridge Hydraulic Report.
 - b. Environmental Considerations.
 - c. Railroad clearances and cross sections.
 - d. Width of waterway and/or width of cross section of roadway being spanned including the use of retaining walls, or fender systems.
2. Statical System: The economic and engineering advantages of both simple span and continuous spans shall be addressed.
 3. Superstructure: Some superstructure types that could be considered are prestressed concrete girders, inverted-tee sections, reinforced or prestressed concrete slabs, steel rolled sections or plate girders, steel or concrete box girders, and post tensioned slabs, bulb-tees or boxes.
 4. Substructures: Some substructure types that could be considered are pile bents and multi-column or hammerhead piers. Variations of column shapes may be appropriate for aesthetic or economical requirements.

5. Foundations: Some foundation types that could be considered are steel and concrete piles, drilled shafts and spread footings.
6. Vessel Collision: Vessel collision forces will often have a major effect on the structural configuration and overall economics. See vessel collision requirements in the **Structures Design Guidelines**.
7. Scour: The 100 year and 500 year predicted scour elevations will often have a major effect on the foundation design. See the foundations and geotechnical requirements in the **Structures Design Guidelines**.
8. Temporary Traffic Control: Show how traffic will be maintained during construction for each of the bridge alternates considered. Assess the impacts of the traffic carried on the structures as well as under the structures being constructed. Consider all major overhead work items such as bridge demolition and girder placement. Show stability towers locations, phased construction sequences, girder splice locations, etc., for each alternate being considered. Compare traffic user impacts for each of the alternates.
9. Prefabricated Bridge Options: Investigate the use of prefabricated bridge options to accelerate bridge construction and to reduce user impacts. Assess prefabricated bridge applicability based on the time savings, direct costs, indirect costs, equipment costs and forming costs. Establish equipment requirements based on size and weight of the prefabricated components and site access limitations. Forming costs should account for project size and component variability.
10. Quantity estimates: For minor bridges rough quantities (such as reinforcing steel based on weight per volume of concrete) may be sufficient. For major and complex bridges the degree of accuracy may require more exact calculations keeping in mind that the intent is to establish relative and equitable costs between alternates and not necessarily to require the accuracy of the Final Estimate. For major and complex structures it may be necessary to develop unit costs from an analysis of fabrication, storage, delivery and erection costs of the different components. For projects involving the demolition of bridges, debris volume quantities must be calculated.
11. Unit costs: Data available from the FDOT or contractors and suppliers should be used to arrive at unit costs. The sources of all price data shall be recorded for later reference. Base cost should be obtained from the **BDR Estimating Section** of the **Structures Manual**.
12. Develop cost curves: For each alternative establish the most economical span arrangement, i.e., minimum combined superstructure and substructure cost.
13. Retaining Wall Study: If retaining walls are present, a retaining wall study shall be included in the BDR. This study will conform with the work as specified in **Chapter 30** of this volume and **Chapter 4** of the **Structures Design Guidelines**.
14. Movable Bridges: For movable bridges the BDR shall include information on the type of equipment for the machinery and electrical drive systems, together with a

general description of the control system to be utilized. A written description and preliminary layouts of system components shall be included.

15. Bicycle and Pedestrian Facilities: The report shall describe the facilities to be provided and the means to be used to comply with ADA requirements and **Chapter 8** of this Volume.

For rehabilitation project plans, the BDR stage shall include plans and written descriptions of those system components to be modified from the existing configuration, along with plans of the existing configuration. Submittal of information described in the previous paragraph is not required unless the electrical and mechanical configuration is modified from the existing configuration.

26.9.3 Format

The report shall use standard, letter-size pages with any larger sheets or drawings folded to fit the report size. The report shall be neatly written and the contents presented in a logical sequence with narrative, as required, to explain the section contents. An Executive Summary shall compare the relative features and costs of the alternates considered and recommend alternate(s) to be carried forward into the Final Structures Plans Preparation phase.

The BDR shall be as self-contained as possible by including all arguments that establish, justify, support, or prove the conclusions. It is acceptable to make reference to other documents that will be included in the final submittal package; however, any documentation that will help emphasize a point, support a statement, or clarify a conclusion shall be included. Such documentation may include drawings, clear and concise views, or other such illustrated information.

The BDR shall address construction time requirements and the effect that components, systems, site constraints and conditions, or other site characteristics or criteria have upon the construction time, whether additive or deductive.

For most projects, the 30% Plans shall be an appendix to the BDR.

26.9.4 Aesthetics

1. General: Any bridge design must integrate three basic elements: efficiency, economy and elegance. Regardless of size and location, the quality of the structure, its aesthetic attributes and the resulting impact on its surroundings must be carefully considered. Achieving the desired results involves:
 - a. Full integration of the three basic elements listed previously.
 - b. The EOR's willingness to accept the challenge and opportunity presented. A successful bridge design will then be elegant or aesthetically pleasing in and of itself and will be compatible with the site by proper attention to form, shapes and proportions. Attention to details is of primary importance in achieving a continuity of line and form. In general, the rule of "form following function" shall be used.

The designer must consider the totality of the structure as well as its individual components and the environment of its surroundings. A disregard for continuity or lack of attention to detail can negate the best intent. Formulas cannot be established; however, the ACI's ***Aesthetic Considerations for Concrete Bridges*** and the TRB's ***Bridge Aesthetics Around the World*** as well as authors such as David P. Billington can guide the designer. A book developed by the Maryland Department of Transportation entitled ***Aesthetic Bridges*** provides excellent guidance. In bridge aesthetics the designer is dealing with the basic structure itself; not with enhancement, additions or other superficial touches. The EOR is expected to be well read on the subject of bridge aesthetics and committed to fulfilling both the structural and aesthetic needs of the site.

The challenge differs for major and minor structures. Indeed, the challenge may be greater the smaller the project. Major structures, because of their longer spans, taller piers, or curving geometry often offer inherent opportunities not available for minor bridges.

Some basic guidelines where aesthetics may play a more important role are:

- a. Bridges highly visible to large numbers of users (maritime and/or motorists).
- b. Bridges located in or adjacent to parks, recreational areas, or other major public gathering points.
- c. Pedestrian bridges.
- d. Bridges in urban areas in or adjacent to commercial and/or residential areas.
- e. Multi-bridge projects, such as interchanges, or corridors should attain conformity of theme and unifying appearance. Avoid abrupt changes in structural features.

Considering these guidelines, the District will determine the level of aesthetic effort

warranted on a project early in its development. When significant aesthetic expense is proposed, such as is the case with Level Three (Level of Aesthetics), Federally funded projects require legitimate written justification.

2. Levels of Aesthetics:

Normally the District will establish one of the following three general levels of aesthetic consideration and effort at each structure's site:

- a. **Level One:** Consists of cosmetic improvements to conventional Department bridge types, such as the use of color pigments in the concrete, texturing the surfaces, modifications to fascia walls, beams, and surfaces, or more pleasing shapes for columns and/or caps.
- b. **Level Two:** The emphasis is on full integration of efficiency, economy and elegance in all bridge components and the structure as a whole. Consideration should be given to structural systems that are inherently more pleasing, such as hammerhead or "T" shaped piers, oval or polygonal shaped columns, integral caps, piers in lieu of bents, smooth transitions at superstructure depth change locations, box-type superstructures, etc.
- c. **Level Three:** The emphasis in this level applies more to the overall aesthetics when passing through or under an interchange or at other sites such as historic or highly urbanized areas where landscaping or unique neighborhood features must be considered. The bridge itself shall comply with Level Two requirements. This level of work may require, at the District's option, a subconsultant (architect to consider adjacent building styles, and landscape themes) with the necessary expertise and credentials to perform the desired work.

These aesthetic levels are not exclusive. For example, where the EOR believes a specific landscape feature might significantly enhance bridge site elegance, even on a Level 1 design, the recommendation should be offered for the Department's consideration. For aesthetic Levels 2 and 3, public input into this issue may be appropriate. The EOR may recommend particular public involvement to the Department for consideration or the district might specify such efforts at specific times during the BDR and/or final plan development phase of the project.

The BDR shall include a summary of aesthetic considerations for the structure and the site. The summary shall consist of sketches, drawings, etc. of recommended treatment as well as the options considered in the aesthetic study but not recommended as appropriate. It shall also include an estimate of cost to implement the recommended aesthetic treatment.

26.9.5 Construction and Maintenance Considerations

All viable structure concepts shall be evaluated for constructability. Items such as member sizes, handling, fabricating, and transporting members as well as maintenance of traffic, construction staging, equipment access, equipment requirements, etc. must be considered. Special evaluation shall be made to insure against potential problems that may occur in obtaining permits and equipment to transport long and/or heavy members from point of manufacture to the project site. The Department's Road Use Permits Office shall be contacted for questions concerning the feasibility of transporting long and/or heavy structural components. Also, considerations for future maintenance inspection shall be taken into account in the structure's design. Such considerations shall include those described in **Section 26.14** of this Chapter and the bearings and joint requirements of the **Structures Design Guidelines**, or the need for 6'-0" minimum headroom inside steel or concrete box girder superstructures. All special construction and maintenance requirements should be identified and appropriately considered in any concepts recommended for design. A design is properly inspectable when it permits safe inspector access to all portions of the structure using equipment available to District Structures Maintenance personnel.

26.9.6 Historical Significance Considerations

When an older bridge is considered for rehabilitation or replacement, the Environmental Management Office will evaluate the historical significance of the structure. A structure may be historically significant due to some of the following characteristics:

1. The structure may be an historic example in the development of engineering.
2. The crossing may be historically significant.
3. The bridge may be associated with an historical property or area.
4. The bridge might be associated with significant events or circumstances.
5. National Register of Historic Places or on a state or local historical register. If it is determined that the structure is historically significant, then the project should be developed to preserve the historic character of the structure.

26.9.7 Bridge Security

Perform a refined evaluation of all new Category 2 bridges identified in a PD&E study as critical, landmark or signature bridges to determine if anti-terrorist countermeasures must be included as part of the design. Contact the State Structures Design Office and the State Maintenance Office for guidance and assistance. Alternative designs developed in the BDR shall minimize the bridge vulnerability. Countermeasures shall be designed to minimize the effectiveness of explosives. Vulnerability to shape charges and vehicle bombs shall be minimized. The use of structural redundancy and continuity shall be maximized to limit structural damage.

Countermeasures designed into the bridge alternatives shall meet one or more of the following objectives:

1. Maximizing explosive standoff distance;
2. Denial of access;
3. Minimizing time-on-target;
4. Selective protection of the structural integrity of key members;
5. Structural redundancy.

Use one or more of the following countermeasure strategies in the design:

1. Deter attacks by the possibility of exposure, capture or failure of the attacker due to visible countermeasures;
2. Detect potential attacks before they occur and provide the appropriate response force;
3. Defend the bridge by delaying and distancing the attacker from the bridge and protecting the bridge from the effects of weapons, fire and vehicle and vessel impacts;
4. Design the bridge to minimize the potential effects of Weapons of Mass Destruction (WMDs) and conventional explosives, fire and vehicle and vessel impacts.

Structural members that are fracture critical and/or are cable stays, cable stay pylons, hollow boxes, single columns, twin wall columns and thin wall columns require design modification to reduce the potential impact of explosions. Access into cable stay pylons, box superstructures and movable bridge machinery require heavy doors with secure lock systems. Bridges with essential communication utilities and or gas lines require the design to minimize risk to the utility.

26.9.8 Alternative Designs

The use of alternative designs for some larger or complex projects may result in more competitive bids and lower costs. Accordingly, the EOR shall evaluate benefits from alternatives for the particular structure being developed and provide a recommendation for or against preparing alternative designs. The alternative designs recommended shall be supported by the evaluations included in the BDR. As a guide, consider the following in evaluating justification for alternative designs:

1. Alternative designs shall be considered for all structures that cost more than \$25 Million and a difference in alternate material (steel versus concrete) construction costs that are within twice the cost of producing the alternate plans. For example, alternative designs would be warranted if the additional preliminary engineering cost for final plans preparation is \$1.5 million per alternate and the difference between the construction cost estimates utilizing FDOT estimating practices in the BDR was less than \$3 million.
2. For bridges that cost less than \$25 million consider alternative designs when project issues reflect possible advantages (i.e., MOT, A+B) from competitive bids.
3. For bridges estimated to cost more than \$10 million consider evaluation of alternative designs whenever a unique design concept is proposed until such time that a bid history is established for the unique design.
4. Projects containing multiple bridges with a reasonable mixture of concrete and steel designs do not require alternate designs.

Steel box structures and steel plate girders should be evaluated including the differences in corrosion potential. Box Girders are preferred over plate girders when located in extremely aggressive environments.

26.9.9 Conclusions and Recommendations

With due consideration for all applicable data, the engineer shall recommend the final bridge design system for the site. Thorough justification for the selection will be presented which examines each element of data, and the total estimated construction cost of the recommended design shall be indicated in the BDR. For most projects, the recommended design shall be supported by thirty percent plans (preliminary) as an appendix to the BDR.

The following sections will define, clarify and list the information necessary to produce an acceptable and reproducible set of contract documents (special provisions, bridge contract drawings, etc.) ready for advertisement and construction. The production of a bridge project commences with the Bridge Development Report (BDR) and ends with complete Contract Documents.

26.9.10 30% Structures Plans

The 30% Structures Plans should be submitted with the Bridge Development Report for most structures. The consultant's scope of services should clearly state at what point are the 30% plans to be submitted. If the 30% Structures Plans are submitted separately, the BDR shall contain enough information and drawings to depict the information needed to properly determine the type, size and location of the bridge. The Phase 1 Geotechnical Report and the Hydraulic Report shall be included with the submittal containing the BDR.

The 30% Structures Plans should show, as a minimum, the following information:

1. General Notes Sheet: As many general notes as possible should be included on this sheet at this stage. Subsequent additions shall be made, when necessary, as the design progresses (for example of General Notes, see **Chapter 3** of the **Structures Detailing Manual**).
2. Plan and Elevation Sheet: provide contents as required by the **Structures Detailing Manual**.
3. Substructures: For end bents, piers or intermediate bents, show substructure elements and sizes including all deviations from the typical dimensions, foundation type including element spacing and the arrangement of piles or drilled shafts.
4. Superstructure: Include cross section showing lanes, shoulders, railings, slab thickness, beam type and spacing and web depth for steel girders. If applicable, show geometric changes in shapes of various components. Also show construction phases and maintenance of traffic data, outline of the existing structure and portions to be removed, and utilities (existing and proposed as available).
5. Retaining Walls: Preliminary control drawings shall be submitted when proprietary or standard cast-in-place walls are proposed. Include control drawings for all critical temporary walls.
6. Bridge Hydraulics Recommendation Sheet.
7. Report of core borings.
8. Proposed construction sequence and methods, indicate construction easements and methods of construction access.
9. Preliminary aesthetic details.
10. Preliminary post-tensioning layouts.
11. Preliminary foundation layouts and installation table.
12. Sidewalks: If provided, show preliminary accessible elements.
13. Any other special details required by the Engineer or details which are not normally used on Department projects.

In addition to these requirements, the following items will be included for moveable bridges: preliminary electrical and mechanical equipment layouts in plan and elevation, submarine cable routing, and single line electrical diagrams including service voltage. All equipment shall be rough sized and supporting calculations shall be submitted.

Requests for design exceptions and/or variations for structural design criteria, shall be included in the 30% Structures Plans Submittal. Design exceptions and design variations shall be approved in accordance with **Chapter 23** of this volume with concurrence of the DSDO or SDO as appropriate.

26.10 Bridge Development Report (BDR) Submittal Checklist

The Bridge Development Report (BDR) Submittal Checklist (**Exhibit 26-A**) contains a list of the key supporting elements that are required for the preparation, submittal and review of a BDR. This Checklist must be included with the BDR when submitted for review and consists of the following items:

1. Typical Sections for Roadway and Bridge
The approved typical sections for both the bridge and roadway are required.
2. Roadway Plans:
Preliminary roadway plans covering the bridge vicinity are required.
3. Maintenance of Traffic Requirements:
The Maintenance of Traffic Plan must show the number of required lanes as well as lane widths of all affected roadways.
4. Bridge Hydraulics Report and Bridge Hydraulics Recommendation Sheet:
The Bridge Hydraulics Report (BHR) shall be prepared in accordance with the FDOT Drainage Manual. It shall include the Bridge Hydraulic Recommendations Sheet (BHRS) and address the required hydraulic opening, clearances, scour and deck drainage requirements. In addition to design water elevations normally shown, the BHRS shall include the Mean High Water (MHW) elevation for tidal crossings and Normal High Water (NHW) for non-tidal crossings. Concurrence of the BHR by the District Drainage Engineer with the District Structures Design Engineer for Category 1 Structures and State Structures Design Engineer for Category 2 Structures is required.
5. Geotechnical Report:
The Bridge Geotechnical Report (Phase I) shall be prepared in accordance with **Chapter 4** of the **Structures Design Guidelines** and the Department's **Soils and Foundation Handbook**. The report shall document a thorough investigation of all viable foundation types for the bridge and retaining walls. Concurrence of the District Geotechnical Engineer is required for Category 1 Structures and of both the State and District Geotechnical Engineers for Category 2 Structures.
6. Bridge Corrosion Environment Report:
A Bridge Corrosion Report shall be prepared to determine the environmental classifications for the structure in accordance with the **Structures Design Guidelines** and must be approved by the District Materials Office.

7. Existing Bridge Plans:

A set of prints of the existing (preferably as-built) bridge plans should be included for replacement structures and widenings. This is of particular importance for widenings and phase construction. These plans are not usually necessary for completely separate alignments or new interchanges unless the existing structures either will be used for new construction activities or will infringe upon the Contractor's allowed work zone.

8. Existing Bridge Inspection Report:

A copy of the latest existing Bridge Inspection Report and Structures Inventory and Appraisal Form is required for all widenings and rehabilitations and may be required for new structures. The existing paint system(s) on all significant metal elements of existing structures shall be identified. The presence of lead-based paint and/or asbestos shall be clearly delineated.

9. Utility Requirements:

All proposed utility attachments to the structure as well as all existing and proposed utilities in the vicinity of the structure shall be identified. The requirements of the Department's **Utility Accommodation Manual (Topic No. 710-020-001)** shall be followed regarding attachments to the structure.

10. Railroad Requirements:

Existing as well as future railroad requirements must be identified. This will include all clearances as well as crash wall or other construction parameters. Copies of correspondence with the Railroad Agency shall be included.

11. Retaining Wall and Bulkhead Requirement:

All permanent and temporary retaining wall requirements shall be identified and the proposed type of wall shall be shown. The type, location and extent of temporary walls to accommodate phased construction and/or maintenance of traffic must be identified.

For water crossings where erosion and/or wave action is anticipated, the type, location and extent of bulkhead production shall be identified. The tie-back and anchor system proposed for use shall be included in the submittal.

12. Lighting Requirements:

All proposed lighting on or under the structure shall be identified.

13. ADA Access Requirements:

Any ADA access requirements that affect the structure shall be identified.

26.11 Final Plans and Specifications Preparation

26.11.1 General

Within this phase of work, for both Category 1 and 2 Structures, there are three phases of work; viz., 60% Substructure submittal or 60% Structure Plans, 90% Structure Plans and 100% Structures Plans and Specifications. For projects where preapproved proprietary wall systems cannot be used and fully designed proprietary wall plans are required, approved control drawings shall be submitted to the appropriate proprietary wall companies as soon as possible and no later than the 60% substructure submittal. A copy of this submission shall be sent to the DSDO or SDO as appropriate. At any time during the project development, the reviewer may require submittal of design calculations.

After each of the phases, except the 100% Structures Plans Phase, review comments from the FDOT are sent to the EOR by letter and/or a marked-up set of prints. The EOR must address each of the comments in writing and resolve each comment prior to the next submittal. The FDOT 100% Structures Plans review comments are to be handled in the same manner; except that unresolved comments may be handled by telephone, in some instances, if confirmed in writing. Also, for any phase, items and drawings from a preceding phase must be included. These drawings shall reflect the comments resolved from the previous phase as well as the accumulated design and drafting effort required of the current phase.

26.11.2 60% Substructure Submittal / 60% Structures Plans

This submittal phase is divided into two distinct parts; viz., the 60% Substructure Submittal (required for all projects) and the 60% Structures Plans for Category 2 Structures and some Category 1 Structures.

1. **60% Substructure Submittal:**

This submittal is required for every project and should be made a part of the 60% Structures Plans phase when that phase is part of the project. The submission is only a partial plans set. The purpose of this submittal is to communicate essential project information to the Geotechnical and Hydraulic Engineers so that all remaining calculations can be performed using actual structural shapes, loads, and dimensions. Plan sheets required for this submittal include: Plan & Elevation, Bridge Hydraulics Recommendation Sheet, Boring Logs, Foundation layout, Substructure Plans, and draft technical specifications.

60% Substructure Submittal Contents:

- a. Foundation Layouts
- b. Foundation Installation Notes
- c. Pile/Drilled Shaft Installation Table
- d. Footing Concrete Outlines (All Variations)
- e. Pier Concrete Outline (All Variations)
- f. Wall Plans - Control Drawings
- g. Pile Details
- h. Lateral Stability Analysis Completed
- i. Phase II Geotechnical Report
- j. Draft Technical Specifications
- k. Reinforcement of Footing and Column
- l. Post-Tensioning Details
- m. Plan and Elevation Sheet
- n. Bridge Hydraulics Recommendation Sheet
- o. Boring Logs

2. 60% Structures Plans:

When a 60% Structures Plans submittal is required, all comments from earlier reviews shall have been resolved. At this phase, the design should be 90% complete and the plans, 60% complete. In addition to the documents required for the 60% Substructure Submittal, the 60% Structures Plans shall include the following details as applicable: final concrete outlines of all individual components, major reinforcing steel, final post-tensioning layouts, steel box/I-girder details, segmental concrete box details, bearing details, seismic details, details of congested areas, details of unique features, accessible pedestrian facilities details, and other details as required. For moveable bridges the following additional information is required: electrical calculations (for generator size, service voltage drop, short circuit, service size, automatic transfer switch, etc.), single line diagram showing equipment sizes and utilities, conduit and wire sizes, panelboard schedules, and light fixture schedules.

26.11.3 90% Structures Plans

Upon approval of the BDR/30% Structures Plans or 60% Structures Plans, as applicable, 90% Structures Plans shall begin. At this stage of plans development, the EOR shall have resolved the 30% and/or 60% Structures Plans review comments and developed the plans for completion. The design and plan production shall be 100% complete. This submittal shall include prints of the completed plans, Summary of Pay Items (complete with quantities), design calculations, Final Phase II Geotechnical Report, Addendums to Hydraulic Report and, if appropriate, Technical Special Provisions. No sheet or detail should be missing at this stage.

26.11.4 100% Structures Plans and Specifications

After resolution of the 90% Structures Plan comments, the EOR shall make all authorized changes necessary to complete the plans and Technical Special Provisions. The EOR shall provide a list of all changes made to the Plans or Specifications that were not directly related to the 90% Structures Plans review comments. The intent is to help minimize the Department's review time and to help the Department's review office to focus on only those new items or details proposed by the EOR. This will, in turn, help to expedite the project's authorization.

The 100% Structures Plans submittal is divided into two distinct phases. First, prints of the original drawings and technical special provisions are submitted 30 days prior to the District's Plans Production Date (PPD). Secondly, once notified by the FDOT, the original drawings and all other documents are submitted to the District.

Within the 30-day period allotted, the EOR will receive notification either of additional changes/corrections to be made or to submit the Final Plans as they are. If at any time during the 30-day period the EOR finds additional changes/corrections that should be made, the Structures Design Office responsible for plans approval (either the District Structures Design Engineer (DSDE) or the Structures Design Office (SDO) as appropriate) must be notified for discussion and resolution.

Once all changes/corrections are made, or if no changes/corrections are necessary, the EOR shall submit all his work to the District prior to or on the PPD. Submittal of this stage of the work shall include the original drawings, one record set of prints with each sheet sealed in accordance with **Chapter 19** of this volume, quantities book assembled as specified in the Department's **Basis of Estimates Manual**, sealed Technical Special Provisions (if required), and sealed Summary of Pay Items with estimated bridge quantities. If included in the Scope of Services, original documents in electronic media such as CADD diskettes may also be required.

26.12 Independent Peer Review of Category 2 Bridges

When an independent peer review of Category 2 bridge plans is required by the contract documents, a single independent engineering firm other than the engineer responsible for the initial work will be designated by the contractor to conduct the review. The designated independent review engineer shall be pre-qualified in accordance with **Rule 14-75 of the Florida Administrative Code**.

The independent peer review is intended to be a comprehensive, thorough verification of the original work. All independent peer reviews shall include but not be limited to the independent confirmation of the following when applicable:

1. Compatibility of bridge geometry with roadway geometrics including typical sections, horizontal alignment, and vertical alignment.
2. Compatibility of construction phasing with Traffic Control Plans.
3. Critical horizontal and vertical clearances.
4. Potential Conflicts with underground and overhead utilities.
5. Compliance with Department and FHWA design requirements.
6. Conformity to Department Standards.
7. Structural Analysis Methodology and assumptions.
8. Design results/recommendations (independent verification of the design).
9. Completeness and accuracy of bridge plans.
10. Technical Special Provisions.
11. Modified Special Provisions.
12. Constructability issues.

In addition to the requirements of **PPM Sections 26.11.3 and 26.11.4**, the following documents shall be included with plan submittals for Category 2 bridges requiring an independent peer review:

1. 90% Plan Submittals
 - a. A tabulated list of all review comments from the independent review engineer and responses from the originator of the design.
 - b. A standard peer review certification letter following the format presented in **Exhibit 26-B** signed by the independent review engineer. All

outstanding/unresolved comments and issues presented in this letter shall be resolved and implemented prior to the 100% plan submittal.

2. 100% Plan Submittals
 - a. A certification letter following the format presented in **Exhibit 26-C** signed and sealed by the independent review engineer stating that all review comments have been adequately addressed and that the design is in compliance with all Department and FHWA requirements.

26.13 Plans Assembly

Consult the **Structures Detailing Manual** for plans assembly, materials, content of plans, and other drafting information.

26.14 Plans Submittal

26.14.1 Schedule

The District Project Manager is responsible for establishing the schedule of submittals with input from the EOR and either the District Structures Design Engineer for Category 1 or Structures Design Office for Category 2 projects.

26.14.2 Submittal Schedule

1. BDR/30% Structures Plans
2. 60% Substructure Submittal/60% Structures Plans
3. 90% Structures Plans
4. 100% Structures Plans

26.14.3 Summary of Phase Submittals

Submittals made at various stages of project development must conform to a uniform standard of completeness for each phase. Use **Exhibit 26-D** to prepare deliverables for each stage of project development.

Design/Build projects utilize a unique submittal process due to the coincident nature of design and construction. The project scope will typically detail submittals required throughout the project schedule. Component submittals are generally allowed (e.g., substructure, superstructure, walls, etc.). However, specific member submittals (e.g., End Bent 1, Pier 3, I-girder details, etc.) are not allowed unless agreed to with the DSDE or SDO. Design/Build projects should also follow the submittal requirements outlined in **Exhibit 26-D** for the completeness of the specific component being submitted.

Exhibit 26-D categorizes sheets based on four levels of completeness. Each level is defined as follows:

1. **Preliminary (P):** Basic shapes, geometry and layout of specified members are shown. Rebar, elevations, quantities, etc. are not required for Preliminary submittals. For example, the outline drawing of an end bent with complete dimensions including stationing, beam and pedestal layout but without pile layout dimensions or rebar.
2. **Substantially Complete (S):** Shapes, geometry and layout have been finalized. Design is 90% complete with most rebar, plate sizes, bolt patterns, concrete strengths finalized and incorporated into the plans. For example, an end bent drawing with rebar, complete dimensions, pile and beam layout but without elevations or quantities.
3. **Complete but Subject to Change (C):** The design, drawings and details are complete for the specified component. Only reviewer-initiated changes should be expected at this level. For example, an end bent drawing would be complete, including all rebar callouts, elevations, dimensions and quantities.
4. **Final (F):** All drawings and designs are complete. No changes are expected at this level. Plans are ready to be signed and sealed by the EOR.

26.15 Review for Constructability and Maintainability

26.15.1 Purpose

The purpose of this review is to provide reasonable and practical use of fabrication and construction techniques and equipment without overloading and/or overstressing components, provide for proper material handling and transportation, provide safe maintenance of traffic and provide an appropriate construction sequence. Additionally, provide features which will retard bridge deterioration, permit reasonable access to all parts of the bridge for inspection and performance evaluation and provide features to facilitate replacement of damaged and/or deteriorated bridge components.

26.15.2 Responsibility

For Category 1 and 2 Structures, it will be the responsibility of the project manager or his designee to coordinate a review of both the 30% and 90% Structures Plans submittals by the appropriate District Construction and Maintenance personnel for constructability and maintainability. For Category 1 Structures, technical issues shall be resolved by the appropriate DSDE. For Category 2 Structures, technical issues shall be resolved by the SDO.

The Construction and Maintenance Offices should be given adequate time to perform these reviews. All comments from these reviews shall be addressed prior to the next submittal and its subsequent review.

26.16 Review for Biddability

26.16.1 Purpose

To prevent construction problems, the District Construction Office will review the plans to make certain the plans are clearly understandable, contain all pertinent notes and have sufficient and correct pay items. During the biddability review, the Construction Office will check for the interface with the roadway segment of the project, utility agreements and environmental permits.

26.16.2 Responsibility

For Category 1 and 2 Structures, it will be the responsibility of the project manager to coordinate a review of the 90% Structures Plan submittal. This review should occur at the same time as the Phase III Plans submittal for the roadway segments of the project.

Additionally, for Category 2 Structures, it will be the responsibility of the Structures Design Office to coordinate a review of the 90% Structures Plans submittal.

The Construction Offices should be given adequate time to perform these reviews. All comments from these reviews shall be addressed prior to the 100% Structures Plans Stage submittal.

26.17 Bridge Load Rating

Load rating analysis of new or existing bridges shall be performed in accordance with the **AASHTO “Manual for Condition Evaluation and Load Resistance Factor Rating (LRFR) of Highway Bridges”** as amended by the **FDOT “Structures Manual”, Volumes 1 and 8**. Load rating procedural matters can be found in the **“Bridge Load Rating, Permitting and Posting Manual (Topic 850-010-035-b)**.

For new bridges the Engineer of Record shall load rate the bridge(s) and submit the calculations with the 90% plan submittal.

Prior to developing the scope-of-work for bridge widening and/or rehabilitation projects, the FDOT or their consultant will determine the suitability of the bridge project using the load rating. If the existing load rating is inaccurate or was performed using older methods (e.g. load Factor), perform a new load rating using the procedures outlined in the **“FDOT Structure Manual”, Volume 1 - Structures Design Guidelines, Chapter 7**. Load rating calculations for the entire structure (existing and new) shall be submitted with the 90% plan submittal for the project.

26.18 Review of Non-FDOT Funded Projects (New Construction)

FDOT review will be required whenever a privately funded structure crosses over Department owned right of way or when such work otherwise affects such a route; i.e., lane closures, access, R/W changes, etc. FHWA review will be required whenever a privately funded structure crosses over an interstate route, or when such work otherwise affects such a route; i.e., lane closures, access, R/W changes, etc. The extent of FDOT and FHWA review is that:

1. Plans must meet all current clearance requirements (vertical and horizontal).
2. Maintenance of traffic scheme for construction must be reviewed and approved.
3. All attachments to the structure over the highway must be securely fastened.
4. Design must be sealed by a licensed professional engineer.
5. Design must be in accordance with a nationally recognized code such as AASHTO, ACI, AISC, etc.
6. Plans must meet all District permit requirements and procedures.
7. Only projects over or affecting a NHS facility shall be submitted to FHWA for approval.
8. FDOT review for these structures shall be performed by the District Structures Design Office for Category 1 and State Structures Design Office for Category 2 Structures.

Exhibit 26-A Bridge Development Report (BDR) Submittal Checklist

Project Name _____

Financial Project ID _____

FA No. _____ FHWA Oversight (yes no) NHS (yes no)

Date _____ FDOT Project Manager _____

	ITEMS	STATUS ^(b)
1.	Typical Sections for Roadway and Bridge ^(a)	P NA C
2.	Roadway Plans in Vicinity of Bridge ^(a)	P NA C
3.	Maintenance of Traffic Requirements ^(a)	P NA C
4.	Bridge Hydraulics Report ^(c)	P NA C
5.	Geotechnical Report ^(c)	P NA C
6.	Bridge Corrosion Environmental Report ^(c)	P NA C
7.	Existing Bridge Plans.....	P NA C
8.	Existing Bridge Inspection Report.....	P NA C
9.	Utility Requirements.....	P NA C
10.	Railroad Requirements.....	P NA C
11.	Retaining Wall and Bulkhead Requirements.....	P NA C
12.	Lighting Requirements.....	P NA C
13.	ADA Access Requirements.....	P NA C
14.	Other.....	P NA C

(a) Must be approved by District before BDR submittal.

(b) Circle appropriate status:
 P - Provided NA - Not Applicable C - Comments attached

(c) See approval requirements for these documents elsewhere in this chapter.

Exhibit 26-B Independent Peer Review Certification Letter (90% Submittal)

Insert Date

Florida Department of Transportation
District ____
[Insert Street Address]

Attn: *[Insert Project Manager/Construction Project Engineer]*

Reference: Independent Peer Review Category 2 Structures
[Insert Project ID]
Financial Project Number: *[Insert FPN]*
Contract Number: *[Insert CN]*

Submittal: 90% Bridge *[Insert Component/VECP]* Plans
Submittal *[Insert Submittal No.]*
Bridge Number(s): *[Insert Bridge No.(s)]*

Dear *[Insert Project Manager/Construction Project Engineer]*,

Pursuant to the requirements of the Contract Documents, *[Insert the name of the Independent Peer Review Firm]* hereby certifies that an independent peer review of the above-referenced submittal has been conducted in accordance with Chapter 26 of the Plans Preparation Manual and all other governing regulations. Component plans that were included in the peer review are as follows:
[Insert a list of all component plans that underwent an Independent Peer Review]

Outstanding / Unresolved Comments and Issues:

[Provide a statement of outstanding/unresolved comments for the above-referenced review, and actions being taken to resolve issues.]

Certification Statement:

I certify that the component plans listed in this letter have been verified by independent review and are in compliance with all requirements presented in the Contract Documents. Independent Peer Review comments and comment resolutions have been included in this submittal under separate cover.

Please do not hesitate to contact me if you have any questions.

Name of Independent Peer Review Firm *[Insert Firm Name]*

Name of Independent Peer Reviewer *[Insert Reviewer Name]*

Title *[Insert Reviewer Title]*

Signature _____

Florida Professional Engineer Lic. No. *[Insert License Number]*

Exhibit 26-C Independent Peer Review Certification Letter (100% Submittal)

Insert Date

Florida Department of Transportation
District ____
[Insert Street Address]

Attn: *[Insert Project Manager/Construction Project Engineer]*

Reference: Independent Peer Review Category 2 Structures
[Insert Project ID]
Financial Project Number: *[Insert FPN]*
Contract Number: *[Insert CN]*

Submittal: 100% Bridge *[Insert Component/VECP]* Plans
Submittal *[Insert Submittal No.]*
Bridge Number(s): *[Insert Bridge No.(s)]*

Dear *[Insert Project Manager/Construction Project Engineer]*,

Pursuant to the requirements of the Contract Documents, *[Insert the name of the Independent Peer Review Firm]* hereby certifies that an independent peer review of the above-referenced submittal has been conducted in accordance with Chapter 26 of the Plans Preparation Manual and all other governing regulations. Component plans that were included in the peer review are as follows:
[Insert a list of all component plans that underwent an Independent Peer Review]

Certification Statement:

I certify that the component plans listed in this letter have been verified by independent review, that all review comments have been adequately resolved, and that the plans are in compliance with all Department and FHWA requirements presented in the Contract Documents.

Please do not hesitate to contact me if you have any questions.

Name of Independent Peer Review Firm *[Insert Firm Name]*

Name of Independent Peer Reviewer *[Insert Reviewer Name]*

Title *[Insert Reviewer Title]*

Florida Professional Engineer Lic. No. *[Insert License Number]*

*[Insert Signature,
Date and Seal
here.]*

Exhibit 26-D Summary of Phase Submittals

Not all sheets are required - consult the project scope for applicability

ITEM	BDR	30%	60%	60%	90%	100%
			Substr.	Structures		
			Submittal	Plans*		
Cover Sheet		P	S	S	C	F
Key Sheet		P	S	S	C	F
Sheet Index		P	S	S	C	F
General Notes		P	S	S	C	F
Summary of Pay Items					C	F
Surface Finish Details			S	S	C	F
Riprap Details			S	S	C	F
Slope Protection Details			S	S	C	F
Plan and Elevation	P	S	C	C	C	F
Bridge Typical Section	P	C	C	C	C	F
Hydraulics Recommendation	P	P	S	S	C	F
Construction Sequence	P	P		C	C	F
Borings		C	C	C	C	F
Foundation Layout		P	S	S	C	F
Pile/Shaft Data Table			S	S	C	F
End Bent		P	S	S	C	F
End Bent Details			S	S	C	F
Wing Wall Details			S	S	C	F
Pier	P	P	S	S	C	F
Pier Details		P	S	S	C	F
Footing Details		P	S	S	C	F
Intermediate Bent	P	P	S	S	C	F
Intermediate Bent Details			S	S	C	F
Drilled Shaft Details		P	S	S	C	F
Finish Grade Elevations				C	C	F
Camber Diagrams				C	C	F
Framing Plan		P		S	C	F
Superstructure Plan				S	C	F
Superstructure Details				S	C	F
Erection Sequence	‡	‡	‡	S	C	F
P/S Beam Data tables				S	C	F
Cross Frames/Diaphragm Details				S	C	F
Steel Girder Details		P		S	C	F
P/T Systems		P		S	C	F
Bearing Details				S	C	F
Expansion Joint Details				S	C	F
Approach Slab Details				S	C	F
Reinforcing Bar List					C	F
Conduit Details				P	C	F
Vermin Guard				S	C	F
Wall Control Drawings		P	S	S	C	F
Wall Plans		P	S	S	C	F
Temporary Critical Wall Drawings	P	P	S	S	C	F
Wall Data Tables			S	S	C	F
Temp. Bridge Plan and Elevation			P	P	C	F
Temp. Bridge Foundation Layout			P	P	C	F

Exhibit 26-D Summary of Phase Submittals (continued)

Not all sheets are required - consult the project scope for applicability

ITEM	BDR	30%	60% Substr. Submittal	60% Structures Plans*	90%	100%
Segment Joint Coordinates/Deck Elev.				S	C	F
Segment Layout		P		S	C	F
Typical Segment Dimensions	P	P		C	C	F
Typical Segment Reinforcing				S	C	F
Pier Segment Dimensions	P	P		C	C	F
Pier Segment Reinforcing **				S	C	F
Abutment Segment Dimensions	P	P		C	C	F
Abutment Segment Reinforcing **				S	C	F
Expansion Joint Segment Dimensions		P		S	C	F
Expansion Joint Segment Reinforcing **				S	C	F
Deviation Segment Dimensions		P		C	C	F
Deviation Segment Reinforcing **				S	C	F
Post Tensioning Layout		P		C	C	F
P/T Details	P	P		S	C	F
Transverse P/T Details		P		C	C	F
Bulkhead Details		P		S	C	F
Drain Details		P		S	C	F
Load Rating Summary Sheet					C	F

Status Key:

P - Preliminary

S - Substantially Complete

C - Complete but subject to change

F - Final

* - 60% Structures Plan submittals are required for all Category 2 and some Category 1 bridges. See **Section 26.11.2** for additional information.

** - May require integrated drawings

‡ - Where required for project.

THIS PAGE LEFT BLANK INTENTIONALLY

Chapter 27

Hydraulic Data and U.S. Coast Guard Permits

27.1	Bridge Hydraulic Report (BHR)	27-1
27.2	Bridge Hydraulic Recommendation Sheet (BHRS)	27-1
27.3	U.S. Coast Guard Permit	27-2
27.4	Scour Considerations	27-3
27.4.1	Development of Scour Design Criteria	27-3
27.4.2	Submittal Requirements for Scour Design	27-4
27.5	Debris Accumulation	27-5
27.6	Widenings	27-6
27.7	Scour Elevations	27-7
Exhibits		
Exhibit 27-A	Structural Plans Development.....	27-8

THIS PAGE LEFT BLANK INTENTIONALLY

Chapter 27

Hydraulic Data and U.S. Coast Guard Permits

27.1 Bridge Hydraulic Report (BHR)

A Bridge Hydraulic Report (BHR) package consisting of the BHR and, as applicable, the Bridge Hydraulics Recommendation Sheet, bridge hydraulic calculations, and scour calculations shall be prepared as specified in **Chapter 4** of the FDOT **Drainage Manual, Topic No. 625-040-002**. The BHR package shall be processed as specified later in this chapter.

27.2 Bridge Hydraulic Recommendation Sheet (BHRS)

A Bridge Hydraulic Recommendation Sheet (BHRS) for new structures and widenings shall be prepared as specified in **Chapter 4** of the FDOT **Drainage Manual**. The BHRS package shall be processed as specified later in this chapter.

27.3 U.S. Coast Guard Permit

For Federal Aid projects, a U.S. Coast Guard Permit may be required for the construction of a bridge or causeway over navigable waters. If a water body is tidally influenced, a permit will probably be required. The FDOT District Permit Coordinator will determine when a permit is required for a particular site. If a determination is made that a permit is not required, FHWA concurrence is necessary (see, ***Project Development and Environment Manual, Topic Number 650-000-001***).

The permit shall be prepared in accordance with the ***U.S. Coast Guard Bridge Permit Application Guide***. The official instructions for preparing and handling the permit drawings will be issued by the District Permit Coordinator. Additional information is available in ***Environmental Management Office Procedure No. 650-040-001***.

Prior to preparation of the permit, the U.S. Coast Guard office having jurisdiction over the waterway for the project shall be notified of the intent to file a permit, and preparation of the permit shall be coordinated with that same office to minimize the chance for conflict, incorrect clearances, or other requirements not being shown.

27.4 Scour Considerations

Scour estimates shall be developed using a multi-disciplinary approach involving the Hydraulics Engineer, the Geotechnical Engineer, and the Structures Design Engineer. Bridges and bridge culverts shall be designed to withstand the design flood without damage and should withstand the 500-year flood (super flood) without failure. Refer to the ***Structures Design Guidelines, Topic No. 625-020-150***, for specific foundation design steps.

27.4.1 Development of Scour Design Criteria

The extent and the mitigating steps needed to resolve scour problems should be resolved early in the design process. The Bridge Development Report (BDR), or 30% structures plans submittal when a BDR is not required, is a means of addressing and resolving all major design issues early in the total design process and should also define the need for scour considerations, establish the scour parameters, and arrive at possible solutions. This can be achieved through the concerted and cooperative efforts of the Hydraulics, Geotechnical, and Structures Design Engineers. The necessary steps are as follows:

1. The Drainage Design Engineer evaluates stream stability and scour potential based on all available data, assumed soil conditions, structure positioning, and foundation designs. The Drainage Design Engineer's assumptions (hydraulic, geotechnical, and structural) and design parameters should be discussed with both the Geotechnical and Structures Design Engineers. When evaluating stream stability and scour potential, the recommendations developed from FHWA's ***Hydraulic Engineering Circular (HEC) 18 and 20*** should be followed as well as the design requirements provided in ***Chapter 4*** of the FDOT ***Drainage Manual***. This work should take place early in the PD&E study where changes in the alignment could affect the severity of general scour.
2. Given the scour potential and based on known subsoil conditions and where knowledge of the local variability of the subsoil is available, the Geotechnical Engineer will then consider the possible alignments. It may be necessary to conduct exploratory work if variability of subsoil conditions are suspected but not sufficiently defined. The results of exploratory investigations should be discussed with both the Hydraulics and Structures Design Engineer, and any previous scour assumption verified and/or modified.
3. The Structures Design Engineer should provide approximate span ranges, pier configurations, and pier locations necessary for the different alternates. In addition, possible foundation types and approximate size should be developed such that the

Drainage Design Engineer can estimate local scour potentials. Conditions to be considered are:

- a. The extent and severity of scour along the alignment must be developed. For example, for bridges over a wide body of water, general scour could vary in extent and severity. It may be reasonable, therefore, to consider fewer foundations in the most severe areas (i.e., span the problem), or take appropriate steps to assure the structural integrity of the foundation in those locations.
 - b. The pile driving resistance, which must be overcome at the time of construction, may be greater than the ultimate pile capacity at a later date due to subsequent scour activity.
 - c. Likewise, design drilled shaft capacity must account for the possibility that ultimate capacity will be reduced as a result of future scour activity.
4. The Drainage, Geotechnical and Structures Design Engineers shall develop the scour potential and rate each location and furnish the results to the District Environmental Management Office (DEMO) Engineer for consideration in establishing the recommended alignment(s).
 5. The preferred alignment is established by others.
 6. The Structures Design Engineer develops more detailed calculations showing possible span arrangements and types and sizes of foundations.
 7. The three engineers review the proposed configuration to assure that scour has been properly addressed. (The Drainage Design Engineer reviews both the general and local scour potential and recommends continuation or changes).
 8. The Structures Design Engineer finalizes his configuration and proceeds with an even more detailed analysis of the foundation including the anticipated pile tip elevations. All three Engineers shall review and concur. The final results are then incorporated into the BDR or 30% Plans Stage as applicable.

The eight (8) steps described above are shown as a flow diagram in **Exhibit 27-A**.

27.4.2 Submittal Requirements for Scour Design

During the 30% and 90% structures plans stage reviews, the EOR shall coordinate the reviews of the design of both the Drainage and Geotechnical Engineers to assure compliance with the results of the scour calculations. This review activity is shown diagrammatically in **Figure 27.2**. The Scour Calculations shall be processed as specified hereinafter.

27.5 Debris Accumulation

Debris accumulation on the upstream side of substructure units can significantly affect the flow of water and cause significant scour. The designer shall evaluate the type of vegetation upstream from the bridge and consider the probability of debris accumulation in establishing types and locations of substructure units. Special consideration shall be given to mitigating debris accumulation on substructure units.

Debris clearance criteria are specified in the FDOT *Drainage Manual, Chapter 4*.

27.6 Widening

The design for scour described above must be included in the widening of an existing bridge structure classified as a major widening as defined in the FDOT ***Structures Design Guidelines***.

The requirement to include scour potential in the design of the widening of an existing structure classified as a minor widening will be considered by the Department on an individual basis.

Hydraulic design procedures are specified in the FDOT ***Drainage Manual, Chapter 4***.

27.7 Scour Elevations

The 100-year and 500-year scour elevations are required for the design of all bridges over watercourses. In addition, the Long-Term Scour Elevation shall be established for bridge structures required to meet the extreme event vessel collision load. For more information on these scour elevations see the FDOT *Drainage Manual*.

Exhibit 27-A Structural Plans Development Sheet 1 of 2

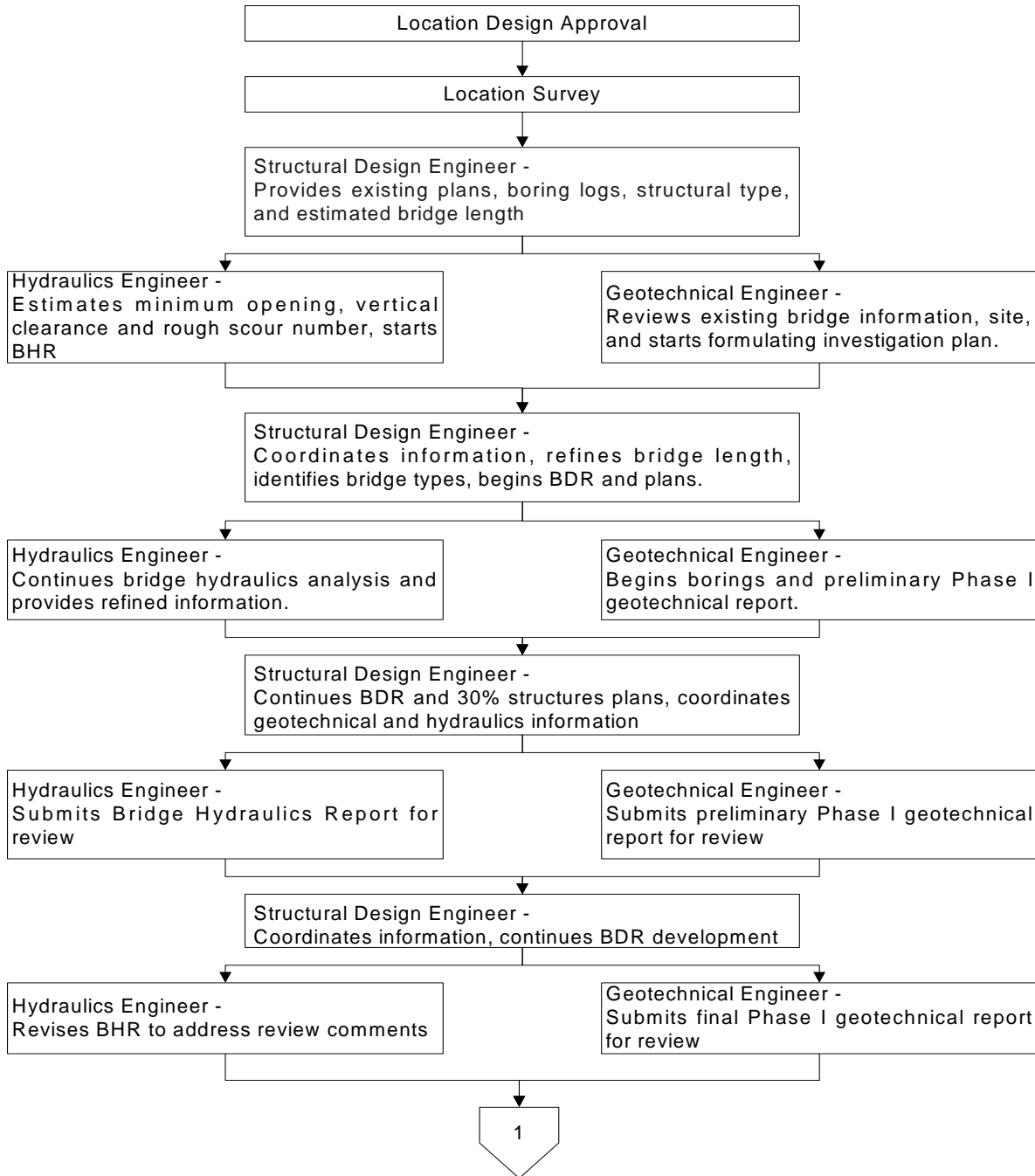
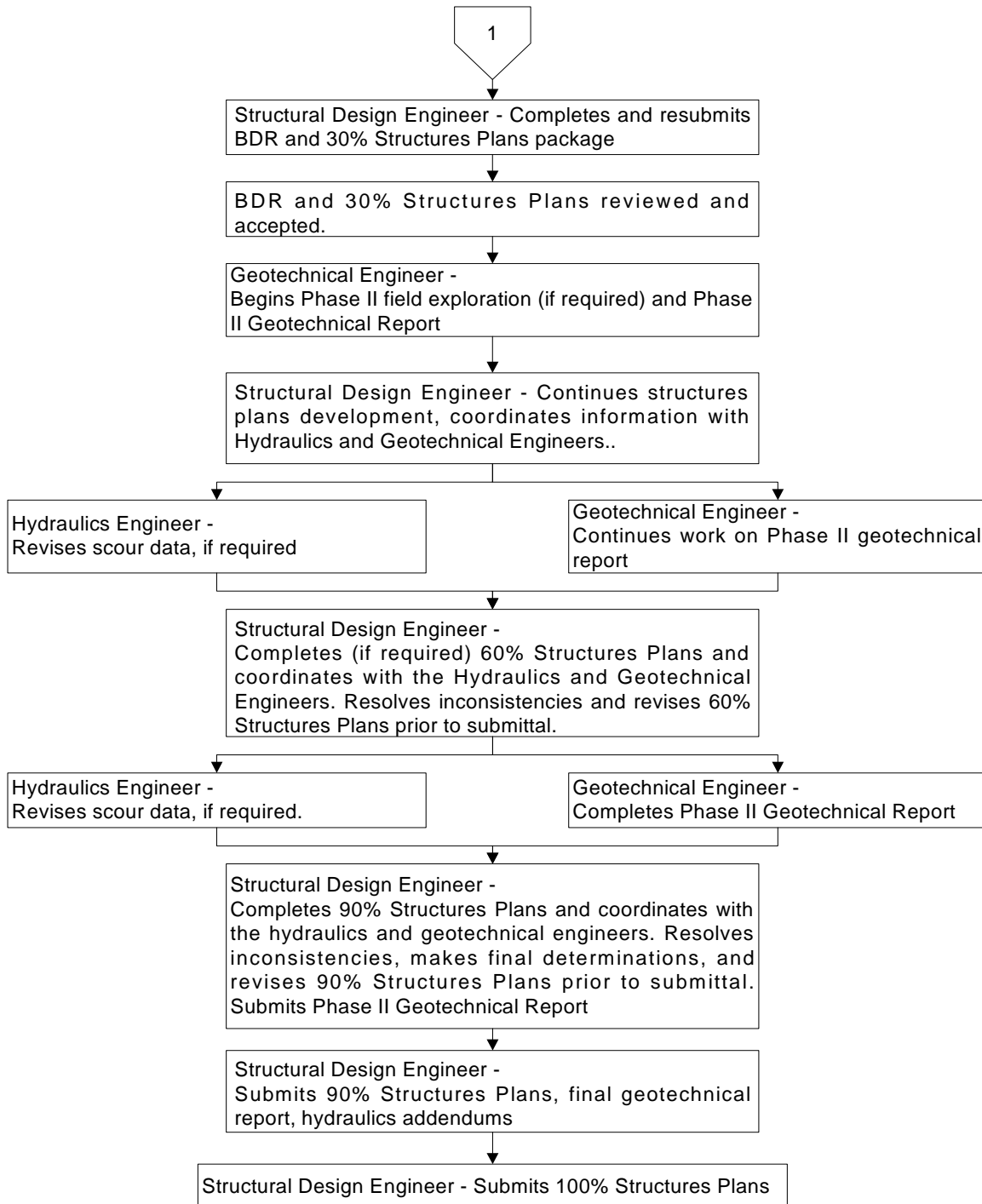

Exhibit 27-A Structural Plans Development Sheet 2 of 2



THIS PAGE LEFT BLANK INTENTIONALLY

Chapter 28

Shop and Erection Drawings

28.1	Introduction	28-1
28.2	Drawing Submittals Required.....	28-3
28.3	Contractor Information Required	28-5
28.4	Submittals Requiring a Specialty Engineer	28-6
28.5	Scheduling of Submittals.....	28-7
28.6	Transmittal of Submittals.....	28-8
28.6.1	General Submittal Requirements	28-8
28.6.2	Requirements for Department EOR	28-9
28.6.3	Requirements for Consultant EOR (Full Services)	28-10
28.6.3.1	Review by Engineer of Record only	28-10
28.6.3.2	Review by Engineer of Record and the Department	28-10
28.6.4	Requirements for Consultant EOR (Design Services Only)	28-11
28.6.5	Requirements for Architectural or Building Structures.....	28-11
28.6.6	Requirements for Roadway Submittal Items	28-11
28.6.7	Requirements for Overhead Sign Structures and Nonstandard Miscellaneous Structures	28-11
28.6.8	Miscellaneous Requirements and Assistance.....	28-11
28.7	Disposition of Submittals	28-12
28.7.1	Minor Modifications	28-15
28.7.2	Major Modifications	28-15

28.8	Segmental Bridges - Shop Drawing Checklist.....	28-16
28.8.1	Construction Methods and Sequence (Overall Scheme)	28-16
28.8.2	Casting Curves and Geometry Control	28-17
28.8.3	Post-Tensioning System and Computation.....	28-18
28.8.4	Segment Shop Drawings	28-20
28.8.5	Erection Equipment.....	28-21
28.9	Distribution of Submittals	28-23
28.10	Review of Prequalified Joint Welding Procedures.....	28-24
28.11	Submittal Activity Record (Logbook)	28-25
28.12	Archiving Record Shop Drawings.....	28-26

Tables

Table 28.1	FDOT Changes to Minor Modifications	28-15
Table 28.2	FDOT Changes to Major Modifications	28-15
Table 28.3	Shop Drawing Distribution Schedule.....	28-23

Exhibits

Exhibit 28-A	Shop Drawing Flow Diagram for Review by Consultant EOR Only (Structural and Movable Bridge Items).....	28-27
Exhibit 28-B	Shop Drawing Flow Diagram for EOR & DOT Review (Structural and Movable Bridge Items).....	28-28
Exhibit 28-C	Shop Drawing Flow Diagram for Review by DOT Only (Structural Items)	28-29
Exhibit 28-D	Record Shop Drawing Transmittal	28-31

Chapter 28

Shop and Erection Drawings

28.1 Introduction

Shop Drawings include all drawings, diagrams, illustrations, schedules, catalog data, material certifications, fabrication procedures, storage and/or transportation procedures, test results, design calculations, etc., required by the Contract Plans and Specifications and submitted by the Contractor to define some portion of the project work. While the Contract Plans and Specifications (including Supplemental and Special Provisions) define the overall nature of the project with many specific requirements, Shop Drawings provide a method for the Contractor to propose, under specification guides and for the Department to approve or reject, a particular material, product or system of accomplishing the work. Each Contractor knows best what materials and equipment can be provided more expeditiously and economically and, if an item proposed meets the contract requirements, the submission of Shop Drawings is the accepted method of approving an element of the structure while allowing flexibility in the Contractor's choice of materials and construction techniques.

It is mandatory, however, that Shop Drawings not be used to modify the construction contract time, the contract amount, the design intent nor in any way reduce the maintainability, structural integrity or load-carrying capacity of the structure or its components. Such modifications can only be administered by revised plan sheets or specifications.

Erection Drawings include all drawings, diagrams, design calculations, procedure manuals and other data required to depict in detail the proposed assembly and methods of installation of components into the project work. The work of construction is the expertise of the Contractor, who should be allowed some latitude in the use of construction means, methods, techniques, sequences and procedures as are compatible with and will result in the project being completed in accordance with the requirements of the Contract Plans and Specifications. Shop Drawings for items such as steel girders, precast/prestressed beams, miscellaneous steel, etc., usually include plan views and/or elevation views denoting the correct placement of a component in the structure. Additional Erection Drawings are required for major structures for items such as special precasting, handling and erection equipment, or the erection of concrete segmental bridges. The Engineer of Record must ensure that the Contract Plans and Special Provisions for the project clearly define all requirements for submittal of Erection Drawings.

The following are definitions used herein:

1. **Engineer:** As defined in *FDOT Standard Specifications for Road and Bridge Construction, Section 1*.
2. **Engineer of Record:** As defined in the *FDOT Standard Specifications for Road and Bridge Construction, Section 1*.
3. **Specialty Engineer:** As defined in the *FDOT Standard Specifications for Road and Bridge Construction, Section 1*.
4. **Consultant:** The Professional Engineer or Engineering Firm, or the Architect or Architectural Firm, licensed in the State of Florida and under contract to the Department to perform professional services. The consultant may be the Engineer or Architect of Record or may provide services through and be subcontracted to the Engineer or Architect of Record.
5. **Resident Engineer:** The Department's local area representative who reports directly to the District Construction Engineer and may be either a Departmental employee of the District or an employee of an engineering firm which is also serving as the Department's CEI (Construction Engineering and Inspection) Group. The Resident Engineer is the principal representative of the Department for a project at the District level. It shall be noted that neither the Resident Engineer nor the CEI Group is involved with the Shop/Erection Drawing review process but are recipients, only, of approved Shop/Erection Drawings.
6. **Architect of Record:** The Architect or Architectural Firm registered in the State of Florida that performs services for the Department in connection with the design and construction of buildings.
7. **"Ballooning":** The contractor's use of minimum 1/16 inch wide lines to "balloon" or "cloud" (encircle) notes or details on drawings, design calculations, etc., in order to explicitly and prominently call out any deviations from the Contract Plans or Specifications. The Engineer of Record may also use "ballooning" to make note of any limitations to their submittal review and disposition of shop and erection drawings.
8. **Record Shop Drawings:** The Department's official record copy of all Shop drawings, Erection Drawings, calculations, manuals, correspondence/ transmittal files and submittal activity record (logbook).
9. **Department Review Office:** The office or other Department entity responsible for performing the Department's review, record keeping, disposition and distribution of Shop and Erection Drawings.
10. **Final Review Office:** The Department Review Office or the Engineer of Record performing the final review and making final distribution of shop drawings which have been reviewed.

28.2 Drawing Submittals Required

Generally, Shop Drawings shall be required for items which require fabrication at a location other than the project job site.

Unless otherwise noted in the Special Provisions for the project, Shop Drawings are not required for reinforcing steel for cast-in-place concrete which is completely detailed and listed on the Contract Plans or on the Department's Standard Index Drawings. A copy of reinforcing bar lists shall be forwarded by the Contractor to the Department's Resident Engineer for record purposes.

Components such as traffic signal equipment, steel or aluminum light poles, concrete strain poles and high mast lighting may not require submittal of Shop Drawings due to having prior certification by the Department. The Contractor may contact the Department's Resident Engineer or the appropriate Department Review Office for clarification of any item.

Material certifications are typically submitted by the Contractor to the Resident Engineer whom forwards the certifications to the State Materials Engineer in Gainesville.

Except as otherwise stipulated in the Specifications, precast and/or prestressed concrete items other than those constructed from standard drawings require the submission of Shop Drawings.

Shop Drawing submittals for structural steel shall include complete shop and field details including a bill of materials, all dimensions, bolt and hole sizes, camber diagrams, web cutting diagrams, weld symbols, surface preparation and shop paint.

In general, drawing submittals for any item shall follow industry standards in regard to the quantity and quality of information contained. As a minimum, the information shown on approved shop drawings should be complete enough to allow for fabrication of the item without referencing any other document. The Department shall expect submittals to meet or exceed the quality level of previously approved submittals of a similar nature.

During component fabrication and construction phases of the project, the Contractor may elect to submit to the Engineer, for consideration or approval, repair procedures or disposition requests due to errors or omissions in the work. The information required and the procedure to be followed by the Contractor in initiating such requests shall be in accordance with the FDOT **Specifications** or as determined by the Engineer.

THIS PAGE LEFT BLANK INTENTIONALLY

28.3 Contractor Information Required

All Shop Drawings and Erection Drawings shall contain the following minimum information: the complete Financial Project Identification, drawing number, drawing title, a title block showing the name of the fabricator or producer and the Contractor for which the work is being done, the initials of the person(s) responsible for the drawing, and the date on which the work was performed.

The drawing shall also contain, adjacent to the title block, information which describes the location of the item(s) within the project. This information may consist of the Contract Drawing number, the station at which the item is positioned (as may be the case for sign structures or handrails), or the Site at which it is to be installed.

Before submission of each drawing, the Contractor shall have determined and verified all quantities, dimensions, specified performance criteria, installation requirements, materials, catalog numbers and similar data with respect thereto, and shall have reviewed and coordinated each drawing with other Shop Drawings and with the requirements of the Contract Plans and Specifications. The Contractor shall have stamped and initialed each sheet giving specific written indication of compliance with the above described specific responsibilities with respect to review of the submission.

The Contractor's approval signifies that the submittal meets the requirements of the Contract Plans and Specifications and conforms to field dimensions or other potential deviations from the established project documents. Drawing submittals received without stamping by the Contractor shall be returned for resubmittal.

At the time of each submission, the Contractor shall have given specific written notice (as in the transmittal letter) of each variation the Shop/Erection Drawings may have from the requirements of the Contract Plans and Specifications. In addition, the drawings shall contain a specific notation which explicitly and prominently calls out any deviation. Approval of Shop/Erection Drawings will not constitute nor be considered grounds for approval of a variation in which the project requirements are affected unless specifically so noted in the Department's approval comments as returned with the drawing submittal.

28.4 Submittals Requiring a Specialty Engineer

In general, and when so permitted in the Specifications, if a Shop/Erection Drawing submittal reflects any changes in the design and/or details of the Contract Plans, the Contractor shall have had a Specialty Engineer seal one (1) print of each drawing affected as well as the cover sheet of one (1) copy of any design calculations required. The Contract Plans and Specifications (including Supplemental and Special Provisions) shall contain instructions regarding requirements of a Specialty Engineer for items such as concrete segmental bridge work, loads imposed on an existing structure, or certain construction procedures and/or equipment.

Submittals which introduce engineering input to the project, such as defining the configuration or structural capacity of prefabricated components or assemblies not contained in the Contract Plans, shall require the services of a Specialty Engineer. Drawings prepared solely as a guide for component fabrication/ installation and requiring no engineering input, such as reinforcing steel drawings and catalog information on standard products, do not require the use of a Specialty Engineer.

When required, the Specialty Engineer shall properly seal on one (1) record print of each drawing and the cover sheet of one (1) record copy of calculations or computer printouts. Computer printouts are an acceptable substitute for manual computations provided they are accompanied by sufficient documentation of design assumptions and identified input and output information to permit their proper evaluation. Such information shall bear the seal of the Specialty Engineer as verification that he or she has accepted responsibility for the results.

It is emphasized that a Specialty Engineer may not affix his seal to any item not prepared under his direct supervision and control.

When a submittal requires a Specialty Engineer, the sealed prints and calculations will ultimately be retained by the Department, as the official, record Shop Drawing. See also Transmittal of Submittals hereinafter.

28.5 Scheduling of Submittals

Review of the submittal requirements and procedures at the outset of the construction contract is of benefit both to the Contractor and the Department. Therefore, the Contractor may have been requested by the Department to provide a Working Schedule for Shop/Erection Drawing submittals.

The preparation of a Working Schedule will bring to the attention of the Contractor the number of submittals required and at times may denote items about which the Contractor may wish the Department's advice as to the manner in which the design is to be implemented. Adherence to the Working Schedule will make for a smoother working relationship between all parties involved in the project, and proper planning should reduce the possibility of a large number of submittals being forwarded for review concurrently.

The Contractor is generally required to schedule submissions such that a minimum of 45 calendar days is allowed for review by the Department for routine work of which the first 30 calendar days are allotted to prime review by the Engineer of Record. However, for most routine submittals, a time period of 14 to 21 calendar days should be adequate. For work of more complexity, the review time may be adjusted proportionately to the complexity of the work. Allowance must also be made for potential resubmittals, and the Contractor normally is advised by the Department to consider a 75 to 90 calendar days total lead-time for submittals prior to the need for fabrication or construction work.

The Contractor must make submittals for approval with such promptness as to cause no delay in his fabrication and construction schedules. Only in emergency cases should special consideration be requested. If a submittal requires resubmission, an approximate additional 30 calendar days should have been scheduled by the contractor for approval of the resubmittal of which the first 15 calendar days are allotted to prime review by the Engineer of Record.

28.6 Transmittal of Submittals

Submittal of Shop/Erection Drawings shall be made to the designated office, as applicable, only by the Contractor for the project. In that the Department's legal contracts and documents are with the Contractor, submittals shall not be accepted directly from a subcontractor or fabricator. Situations may occur when a subcontractor or fabricator is allowed to make an advance submittal for review; however, the actual submittal to be stamped and approved must follow from the Contractor with the Contractor's stamp. Subcontractors and fabricators are encouraged to contact the appropriate Department Review Office for guidance or advice at any time. **Exhibits 28-A** thru **28-C** show the flow of submittals during the review process. All transmittals of submittals between parties shall be accomplished by OVERNIGHT DELIVERY.

The Special Provisions for the project may denote the amount of drawings, etc. to be submitted and the procedure to be followed. Furthermore, the office to which the Contractor shall transmit his submittal and the procedure to be followed may also be defined during the preconstruction conference for the project. In the absence of such instructions, the following generally applies:

28.6.1 General Submittal Requirements

On projects where the Engineer of Record is a Consultant to the Department, and unless otherwise directed at the project's preconstruction conference, the Contractor shall have submitted two (2) sets of xerographic reproduces directly to the consulting Engineer of Record. On projects where the Department is the Engineer of Record, the Contractor shall have submitted two (2) sets of xerographic reproduces directly to the appropriate Department Review Office. For design calculations, four (4) complete sets, including computer printouts, shall be submitted with the drawings. All drawings shall be on sheets not larger than 11" x 17". The Contractor's letter of transmittal should always accompany the drawings and a copy should always have been sent to the Department's Resident Engineer. On those projects where the Engineer of Record is a Consultant to the Department, and the Department will be reviewing the shop drawings, a second copy of the Contractor's letter should also have been sent to the Department's Review Office.

28.6.2 Requirements for Department EOR

On projects where the Engineer of Record is Department in-house staff, submittals shall have been transmitted to the appropriate Department Review Office as directed at the project's preconstruction conference. The Department's Review Office is the principal contact group and "clearing house" for all construction submittals and information desired by the Contractor regarding structural, mechanical or electrical items.

28.6.3 Requirements for Consultant EOR (Full Services)

28.6.3.1 Review by Engineer of Record only

On projects where the Engineer of Record is a Consultant to the Department and has been retained by the Department to review construction items without follow-up review by the Department, the Consultant will assume the responsibility of the owner's agent. The reviewing consultant is encouraged to communicate with fabricators, contractors, specialty engineers and the Department's Structures Office to clarify concerns before returning the submittal to the contractor. The reviewing consultant shall also contact the Department's Structures Office if unsure of the Department's position on certain issues during the review. Submittals should not be stamped "resubmit" if "approved as noted" will suffice. Submittals (unless otherwise noted below) shall have been transmitted by the Contractor directly to the Consultant. Upon receipt of the submittal, the Consultant shall perform the review, note any comments directly on the sheets, make the appropriate numbers of copies, indicate his disposition by stamping the sheets as described hereinafter, retain one set of prints for his files and, finally, make distribution as described hereinafter. The original prints and calculations form the official, record Shop Drawing submittal and must be retained by the Engineer of Record and forwarded to the Department at the end of the project.

28.6.3.2 Review by Engineer of Record and the Department

On projects where the Engineer of Record is a Consultant to the Department and has been retained by the Department to review construction items, submittals (unless otherwise noted below) shall have been transmitted by the Contractor directly to the Consultant. Upon receipt of the submittal, the Consultant shall perform the review, note any comments directly on the sheets, indicate his disposition by stamping the sheets as described hereinafter, retain one set of prints for his files and, finally, transmit the original sheets to the Department's Review Office for review and distribution. When submittals require a Specialty Engineer, the original prints and calculations form the official, record Shop Drawing submittal and must be retained by the Department. Upon completion of his review, the Consultant shall transfer his comments to the sealed sheets, indicate his disposition and transmit them to the Department as described above.

28.6.4 Requirements for Consultant EOR (Design Services Only)

On projects where the Engineer of Record is a Consultant to the Department but has not been retained by the Department to review construction items, submittals (unless otherwise noted below) shall have been transmitted by the Contractor directly to the Department's Review Office as directed at the project's preconstruction conference.

28.6.5 Requirements for Architectural or Building Structures

Submittals related to Architectural or Building Structures, such as Rest Areas, Picnic Pavilions, Offices and Warehouses, shall be made according to the requirements of the Architectural Services Group, Production Support Office, Florida Department of Transportation, 605 Suwannee Street, MS 40, Tallahassee, FL 32399-0450, Phone (850) 414-4378.

28.6.6 Requirements for Roadway Submittal Items

All submittals related to roadway plans such as lighting, attenuators, retained earth systems, etc. (except bridge items such as poles and bracket arms, or as noted below) shall be distributed in accordance with the ***Construction Project Administration Manual (Topic No. 700-000-000)*** for the component involved or as otherwise directed at the project's preconstruction conference. Submittals related to bridge items shall have been transmitted to the Department as previously described in this section.

28.6.7 Requirements for Overhead Sign Structures and Nonstandard Miscellaneous Structures

Submittals concerning overhead sign structures shall have been transmitted in accordance with the General and Structures Requirements above.

28.6.8 Miscellaneous Requirements and Assistance

For items not specified above or for which questions may arise as to submittal requirements, the Contractor should be advised to contact the appropriate Department Review Office. For submittals of any type, the Contractor shall always have transmitted a copy of the letter of transmittal to the Resident Engineer.

28.7 Disposition of Submittals

The approval or disapproval of submittals by the Reviewer shall be indicated by one of the following designations: "APPROVED" (no further action required), "APPROVED AS NOTED" (make corrections noted - no further submittal required), "RESUBMIT" (make corrections noted and resubmit for approval), or "NOT APPROVED" (rejected - do not resubmit the concept or component as submitted).

The disposition designation shall be indicated on each and every drawing sheet, or on the cover sheet of calculations, by the use of a red ink stamp. The stamp size shall not exceed 3" high by 3" wide, but 1 ½" high by 3" wide stamp is preferred. Stamps shall identify the approving groups, such as the Engineer of Record - Consultant, the Department's assigned commercial inspection agency and/or Department personnel, and the date. All notations or corrections made on the approval prints shall be consistently marked on all drawings.

All Consultants reviewing submittals shall red ink stamp and initial each item as noted above with the firm's appropriate stamp. Consultants must declare any limitations to the extent of their review and approval by the terminology of their standard stamp and/or by additional written and "ballooned" notes on the submittal items. When the Engineer of Record is a Consultant, and when he or she retains a Subconsultant to assist in the submittal review, the Engineer of Record shall signify disposition of the submittal as noted above with his firm's appropriate stamp prior to distribution or prior to transmitting it by overnight delivery to the Department. In this event it is the Engineer of Record's prerogative to also require a disposition stamp by his Subconsultant.

When a submittal contains deviations from the Contract Plans and Specifications, the Consultant and the Department shall determine as to whether or not a Supplemental Agreement or Value Engineering Change Proposal (VECP) is required. If either procedure is required to be initiated, the submittal shall not be reviewed until a decision is finalized.

When the Engineer of Record receives a submittal that is not in accordance with the requirements of this chapter, the Contractor shall be advised to resubmit immediately with the corrections or additions necessary.

Review and approval by the Engineer of Record (Consultant and/or Department) shall be for conformance with the design concept of the project and for compliance with the information given in the Contract Plans and Specifications (including Supplemental and Special Provisions). The review and approval shall not extend to means, methods, techniques, sequences or procedures of construction (except where a specific means,

method, technique, sequence or procedure of construction is indicated in or required by the Contract Plans and Specifications) or programs incident thereto. The review and approval of a separate item as such will not indicate approval of the assembly in which the item functions.

Disposition of Shop Drawing submittals by the Engineer of Record for construction and erection equipment including beams and winches, launch gantry, erection trusses, forms, falsework, midspan and/or longitudinal closures, lifting devices, temporary bearing fixity devices, cranes, form travelers, segment carrying equipment and stability devices shall be either "NOT APPROVED" if deemed to be unacceptable or, if acceptable, shall be "APPROVED AS NOTED" with the following note included on the submittal drawings:

"Drawings are acceptable for coordination with, relationship to, and effects upon the permanent bridge; but have not been reviewed for self-adequacy. Adequacy and intended function remain the sole responsibility of the Contractor."

Unless otherwise specifically designated in a Consultant's Scope of Services or required by the Department, the Engineer of Record is not responsible for accepting or reviewing calculations or drawings pertaining to construction formwork. These documents should normally have been submitted to the Resident Engineer or, in the event they are erroneously transmitted to the Engineer of Record, should be immediately rerouted to the Resident Engineer.

On projects when the Engineer of Record is a Consultant to the Department and the Department will also be reviewing shop drawings the Department will perform a second, confirmation review of the submittal upon receipt of the Consultants transmittal of reviewed drawings which have been stamped for disposition as noted above. The primary purposes of the Department's review include: conformance with FDOT policy, standards, etc.; uniformity of disposition with similar submittals; accuracy and completeness of the Consultant's review; and attention to specific details, areas of work, etc. that have experienced recurring problems during fabrication and/or construction.

When the Specialty Engineer is required by the Contract Plans and specifications to perform a portion of the design of the project, the Engineer of Record shall confirm that:

1. The Specialty Engineer is qualified to design and prepare the submittal.
2. The specified number of submittals have been furnished.
3. A minimum of one (1) set of Shop Drawings and the cover sheet of one (1) set of calculations have been correctly sealed by the Specialty Engineer.

4. The Specialty Engineer has understood the intent of the design and has used the correct specified criteria.
5. The configuration set forth in the submittal is consistent with that of the Contract Documents.
6. The Specialty Engineer's methods, assumptions and approach to the design are in keeping with accepted engineering practices.
7. The Specialty Engineer's design does not contain any gross inadequacies that would jeopardize or threaten public safety.

A detailed review of design calculations is not required, and a detailed review of dimensions (other than at interface areas with other work) is not required.

When a submittal has been returned as "RESUBMIT", the Contractor shall have made corrections as required and shall have returned the required number of corrected copies for review. All revisions to a drawing, etc., shall have been noted with a symbol consisting of the revision number within a triangle located next to revised area. The Contractor must have directed specific attention in writing to revisions other than the corrections called for by the Department on previous submittals.

Exhibits 28-A thru **28-C** show the submittal and distributional flow of a shop drawing transmittal. When the Department concurs with the Consultant's review and disposition of the submittal, the Department will stamp and distribute the submittal including a record copy for the Consultant. Should the Department's review and/or disposition of the submittal differ from that of the Consultant, the final disposition of the submittal will be resolved in accordance with the following procedures:

28.7.1 Minor Modifications

The submittal will be processed when notations not involving design decisions are added, modified or deleted and when the disposition of the submittal remains unchanged or changed only in accordance with the following **Table 28.1**:

Table 28.1 FDOT Changes to Minor Modifications

From	To
Approved	Approved as Noted
Approved as Noted	Approved
Resubmit	Not Approved
Not Approved	Resubmit

In this event, the Department will notify the Consultant of the modifications, document the notification in the project's shop drawing file, process and distribute the submittal and furnish the Consultant with a record copy.

28.7.2 Major Modifications

The submittal will be returned to the Consultant for re-review when notations involving significant design decisions must be added, deleted or modified, when the submittal's review is deemed by the Department to be incomplete or require significantly more work or when the disposition of the submittal requires one of the following **Table 28.2**:

Table 28.2 FDOT Changes to Major Modifications

From	To
Approved or Approved as Noted	Not Approved or Resubmit
Not Approved or Resubmit	Approved or Approved as Noted

As above, the Department will notify the Consultant and document the notification. The submittal will be returned to the Consultant for re-review and return to the Department.

28.8 Segmental Bridges - Shop Drawing Checklist

The following list is for guidance only. There may be occasions when particular details and needs are more or less than this list:

28.8.1 Construction Methods and Sequence (Overall Scheme)

This should be the first submittal as it lays out the Contractor's philosophy and overall approach to the project. It should cover:

1. Overall construction schedule (program) for the duration of the contract. Milestone dates should be clearly shown - for example, the need to open a structure by a certain time for traffic operations.
2. Overall construction sequence. The order in which each of the structures is to be built and the sequence in which individual spans or cantilevers are constructed.
3. The general location of any physical obstacles to construction that might impose restraints to the sequence and an outline of how the Contractor intends to avoid or handle such obstacles as he or she builds the structure. Obstacles might include road and rail clearances, temporary diversions, transmission lines, pipelines, local property rights, etc.
4. The general location of any temporary construction obstacles and how these are to be handled. Such might include excavation or cofferdams for an adjacent structure, piling rig or other plant clearances, temporary haul road clearances, etc.
5. The appropriate location of any temporary stability towers or other falsework.
6. The approximate location of any special lifting equipment in relation to the structure including clearances required for operation of that equipment; i.e., crane positions and operating radii.
7. The conceptual position of any special construction devices such as launching girders, support trusses, pier brackets, stability devices, beam, and winch type equipment, etc. (with outline details only at this time) of how the Contractor intends to attach such equipment to the structure. (The precise details of such attachments would be covered under later detailed submittals).
8. Outline proposals for the lifting, handling and storage of segments. (Again, precise details and any extra reinforcement provisions, etc. would be covered under later detailed submittals.)
9. Any other information pertinent to the Contractor's scheme at this time.

The above information should be in as concise form as possible on one or two drawings. The intent is to provide an overall integrated picture of the Contractor's intentions. As such, these drawings are for information only and it should be made quite clear that the delivery and receipt of such drawings does not constitute approval to the details implied therein. They are to be accepted for information only and not approved. However, the Contractor's subsequent detailed submittals should comply with the overall concepts.

28.8.2 Casting Curves and Geometry Control

Casting curves contain the superstructure geometry and compensations for deflections arising as a result of the construction sequence, methods, temporary loads, temporary supports, creep and shrinkage, etc. Camber diagrams are only the deflection compensation portions of the casting curves. Casting curves and camber diagrams may be presented in numerically tabular or graphic forms. The format is not critical, but the information given should be clear and concise, leaving no room for doubt or misinterpretation. Examples and illustrations should be shown to help clarify the data presented. Casting curves and camber should be generated according to the Contractor's proposed methods, sequence, schedule and equipment of the overall scheme. Changes to his overall scheme might require recomputation and submittal of new casting curves and camber.

Geometry control is the process of making field observations and measurements in the casting cell and combining these with the theoretical casting curve data to produce the required structural shape, segment by segment. It involves accurate instrument work and geometry calculations using graphical or computerized methods.

It is normal practice for the geometry control system to be explained in a manual prepared by or on behalf of the Contractor.

28.8.3 Post-Tensioning System and Computation

Contractors usually sublet this work to specialty suppliers. There are some differences of detail between suppliers but, by and large, these are not significant. Usually the differences are only in the shape and size of anchorage devices and jacks for a given tendon size and load.

Only pre-approved post-tensioning systems are to be used by the contractors. The State Structures Design Office (SDO) is responsible for approving these systems. Post-tensioning hardware shop drawings for a particular project should be checked against the drawings on the SDO website to assure the system components are identical to those of the appropriate approved system. The SDO is not responsible to check shop drawings that relate to the use of the approved hardware.

The Post-Tensioning proposals should show and be checked for:

1. Complete details of the pre-approved post-tensioning hardware.
2. Jack sizes and required clearances.
3. Special jack handling devices with all necessary inserts or fixtures.
4. Proposals for threading of tendons (i.e., use of steel wire pulling socks, welded pulling eyes, etc.).
5. Proposals for cutting off strand which has been affected by any heat from welding.
6. Proposals for cutting of surplus strand prior to and after stressing.
7. Information on the jacking equipment, pumps and dial gauges, etc.
8. The storage of materials and protection from corrosion.
9. Assumptions for the stressing operation, coefficient of friction, wobble factor, elastic modulus or stress - strain curve, anchorage draw-in (wedge set), etc.
10. A summary of the jacking loads, tendon forces, and extensions, before and after seating the wedges.
11. A stressing sequence and schedule for groups of tendons.
12. Post-tensioning duct profiles, vent locations, grout injection port locations and geometric layout used in the computations.
13. Proposed recording sheets.
14. Details, sequence, schedule, operations and stressing forces for any temporary post-tensioning.

15. Any special requirements for bursting rebar or extra rebar to restrain radial forces if the profiles are different from those shown in the contract plans.
16. Details for the means of securing the anchorage hardware in position until the concrete has been cast.
17. Details for the splicing of ducts to ensure that a smooth profile is maintained and that any connections are grout-tight.
18. Details of any special bar or tendon couplers such as those to show adequate clearance for couplers when the tendon elongates with stressing, etc.
19. Details for post-tensioning duct supports with regard to strength and frequency to maintain a good profile during concreting.
20. Details of grout joints such as the locations at all high points and at sufficiently close spacing to ensure a good grouting operation.
21. Information on proposed grouting procedures such as grout mix including admixtures, grout pump and delivery system, sequence of grouting (work "uphill" in one direction along a tendon), backup facilities, grouting pressures, etc.
22. Details of anchorage inspection, duct inspection, tendon and anchorage void repairs, anchorage protection systems, deck penetration repairs, etc.

The post-tensioning supplier might not be responsible for all of the above information. Some of it, particularly that relating to rebar, hardware, ducts, vents, etc. should be covered on the segment detail shop drawings. Also, the grouting operation (Item "U") might be by a separate subcontractor. Nevertheless, the Contractor is responsible for coordinating all this activity and for making sure that all the information and details are integrated. It should be noted that several items are more for the benefit of field personnel than part of the shop drawing review.

28.8.4 Segment Shop Drawings

The main purpose of these drawings is to bring all the information together in a format from which the parts can be easily assembled. This involves the integration of diverse details from many areas. Typically the following should be checked:

1. Segment number and direction of erection.
2. All dimensions including widths, lengths, thicknesses, tapers, fillets, radii, working points, post-tensioning duct locations and profiles, clearances, rebar spacings, blockouts, positions of embedded items, holes, grout, vents, anchorage positions and orientations.
3. All reinforcement including bar sizes, shapes, locations, spacings, covers, clearances for the largest sized aggregate, clearances for cumulative tolerances on bending and fixing dimensions, avoidance of conflicts with post-tensioning ducts, anchorages and hardware including any special lifting or equipment connections. As a general rule, rebar should be adjusted to avoid post-tensioning and other important embedments.
4. Clearances for post-tensioning jacks, including temporary post-tensioning bar jacks. Make sure there is enough room to thread a jack onto a post-tensioning tendon remembering that most center hole jacks require 3 to 5 feet of strand projecting out beyond the anchorage. Likewise with bar tendons, especially in blockouts, there has to be room for the jack to be placed over and threaded onto the extended section of bar beyond its anchorage.
5. Clearances for lifting devices. Check that there is room to place anchor plates and nuts on the bottom side of any bars connecting through the slabs to a lifting device, etc.
6. Anchorage and Buttress Detail. Check that there is adequate rebar in these zones for any bursting and local radial forces. This should be covered on the design drawings but might have to be modified as a result of the Contractor's choice of post-tensioning system. The rebar should not cause congestion and there should be adequate spacing for concrete placement and compaction.
7. Casting of blockouts regarding material to be used, reinforcing to be extended from the segments, and time of casting in relation to erection stressing, etc.

28.8.5 Erection Equipment

These drawings should be reviewed for procedure and structural effect on the structure. The shop and erection drawings shall be prepared by the Contractor's Specialty Engineer and will be reviewed as described in **Sections 28.4** and **28.7** of this chapter.

THIS PAGE LEFT BLANK INTENTIONALLY

28.9 Distribution of Submittals

If the initial review and approval of a submittal is performed by a Consultant to the Department, and the Department will be reviewing the shop drawings, the Consultant shall retain one (1) set of materials for his files and transmit the prints (or other sets of calculations or multiple sets of prints) to the Department's Review Office.

Distribution by overnight delivery is made in accordance with the following **Table 28.3**:

Table 28.3 Shop Drawing Distribution Schedule

DISTRIBUTION	FDOT - EOR	Consultant – EOR With Department Review	Consultant – EOR Without Department Review
FDOT Shop Drawing Review Office File	1 Set Original Prints + 1 Set Calcs	1 Set Original Prints + 1 Set Calcs	1 Set Prints + 1 Set Calcs
Engineer of Record	N/A	1 Set Prints + 1 Set Calcs	1 Set Original Prints + 1 Set Prints + 1 Set Calcs
FDOT Resident Engineer	2 Sets Prints	2 Sets Prints	2 Sets Prints
Prime Contractor	3 Sets Prints + 1 Set Calcs	3 Sets Prints + 1 Set Calcs	3 Sets Prints + 1 Set Calcs
M/E Section State Structures Design Office	N/A	N/A	Mechanical/Electrical - 1 Set Prints + 1 Set Calcs

When precast/prestressed concrete components are involved, the Department's District Prestress Engineer is furnished two (2) sets and the State Materials Office (Gainesville) is furnished one (1) set of prints. When structural steel components are involved, the Department's Assigned Commercial Inspection Agency (ACIA) is furnished two (2) sets. When mechanical/electrical components of movable bridges are involved, the Mechanical/Electrical Section of the State Structures Design Office (SSDO) is furnished one (1) set of prints and one (1) set of calculations.

The Contractor shall be responsible for transmitting a copy of the returned submittal to the appropriate subcontractor or fabricator.

When approval of a submittal is denied ("RESUBMIT" or "NOT APPROVED"), distribution of the submittal shall be made to the FDOT Review Office's File, when the Department is reviewing shop drawings, and the Prime Contractor only, with a copy of the transmittal letter to the Department's Resident Engineer.

28.10 Review of Prequalified Joint Welding Procedures

In accordance with **Section 11.2** of the **Materials Manual**, the approval of all joint welding procedures specification (WPS) will be the responsibility of the Department's Verification Inspection Consultant, which is the Department's Assigned Commercial Inspection Agency (ACIA). The State Materials Office maintains the list of the approved WPS which may be used on all future projects by the fabricator who developed them, until their expiration. A list of the welding procedures to be used on any individual project will be forwarded to the Engineer of Record (EOR) prior to the start of fabrication. The EOR may elect to review these documents, but it is the responsibility of the Verification Inspection Consultant to assure the proper welding procedure is used at the correct location. Shop drawings depicting plate sizes, types of welds, weld designations, weld sizes, grades of materials, etc. will continue to be reviewed by the EOR.

The fabricators of the following products are only required to include their approved Welding Procedure Specification as part of their quality control plan:

1. Overhead cantilevered sign supports with cantilevered arms less than or equal to 41 feet,
2. Overhead span sign supports,
3. Aluminum light poles,
4. High mast light poles,
5. Expansion joints,
6. Roadway decking,
7. Bearings,
8. Monotube Assemblies,
9. Mast arm assemblies,
10. Drainage items,
11. Stay-in-place forms,
12. Casing pipes,
13. Steel strain poles,
14. Pedestrian/Bicycle Railings
15. Any other items that are not designated as items requiring commercial inspections.

28.11 Submittal Activity Record (Logbook)

The Final Review Office is responsible for maintaining a Submittal Activity Record (Logbook) on each project reviewed by the office. The logbook shall be updated each day that any Shop Drawing submittal activity occurs.

The following minimum data shall be entered in the logbook for each submittal:

1. Financial Project ID and State Project Number (if assigned).
2. Submittal Number.
3. Description of Submittal.
4. Number of Sheets in the Submittal.
5. Number of Pages of Calculations, in Reports, in Manuals, etc.
6. Date Transmitted by Contractor to the Engineer of Record.
7. Date Transmitted by Engineer of Record (when EOR is not the final reviewer) to the Final Review Office.
8. Date Distributed by the Final Review Office to the Contractor.
9. Disposition as either "A" (Approved), "AN" (Approved as Noted), "R" (Resubmit) or "NA" (Not Approved).

The Logbook is an historical record of the activity devoted to an individual submittal as well as that for the project as a whole. It can serve as a verification of review time, to respond to inquiries of a particular submittal's status and as a record of manpower effort to aid in estimating and allocating future workload.

28.12 Archiving Record Shop Drawings

Upon completion and acceptance of a construction project by the Department (usually by receipt of a written Notice of Acceptance), the Final Review Office, within thirty (30) days, shall transmit the Record Shop Drawings to the appropriate offices, as dictated by district practice in the District in which the project is located. The Record Shop Drawings may include some or all of the following documents:

1. Shop Drawings
2. Erection Drawings
3. Calculations
4. Manuals
5. Project Files of Shop Drawing transmittal letters, etc.
6. Submittal Activity Record (Logbook printout)

The Final Review Office shall complete the Record Shop Drawing Transmittal (see **Exhibit 28-D**), in triplicate, retaining one (1) copy and transmitting two (2) copies, along with the Record Shop Drawings described above, to the appropriate office. The Record Shop Drawing Transmittal describes all the Record Shop Drawing documents being transmitted.

The Submittal Activity Record (logbook) is intended to serve as the listing of all Shop and Erection Drawings transmitted. Other transmitted material such as project files, samples, etc. should be listed individually on the Transmittal shown in **Exhibit 28-D**.

Upon receipt of the Record Shop Drawings, the offices receiving the transmittal shall verify the documents, material, etc. transmitted, sign and date both copies of the Record Shop Drawing Transmittal, retain one (1) copy for his files and return the second signed copy to the Final Review Office.

The Final Review Office shall maintain a file of Record Shop Drawing Transmittals (**Exhibit 28-D**) for future reference and use. Once the signed copy of the Record Shop Drawing Transmittal is received, the Final Review Office's initially retained Record Shop Drawing Transmittal may be discarded.

It should be noted that for Shop Drawing submittals requiring a Specialty Engineer, the Record Shop Drawing submittal normally will consist sealed prints.

Exhibit 28-A Shop Drawing Flow Diagram for Review by Consultant EOR Only (Structural and Movable Bridge Items)

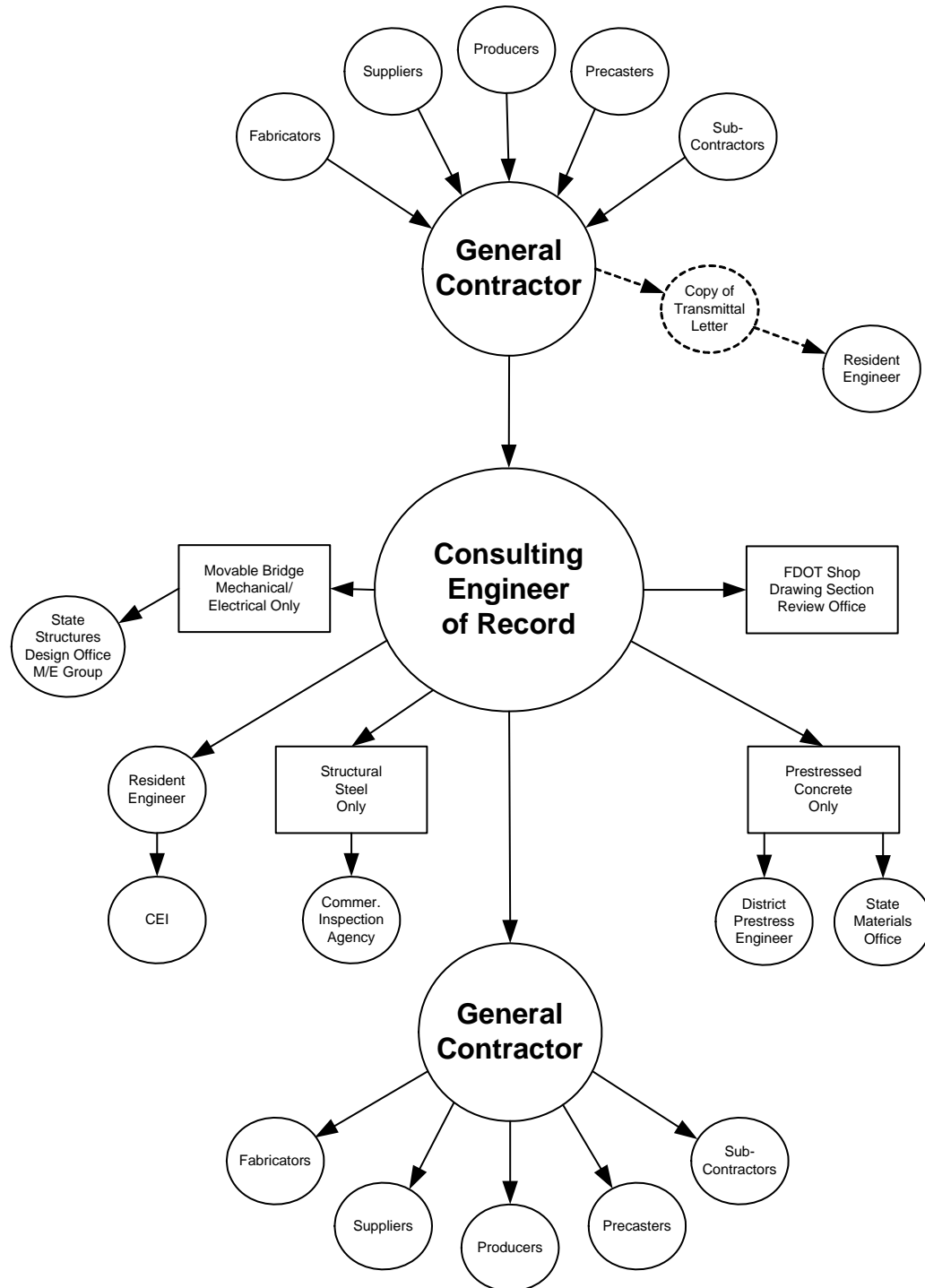

Exhibit 28-B Shop Drawing Flow Diagram for EOR & DOT Review (Structural and Movable Bridge Items)

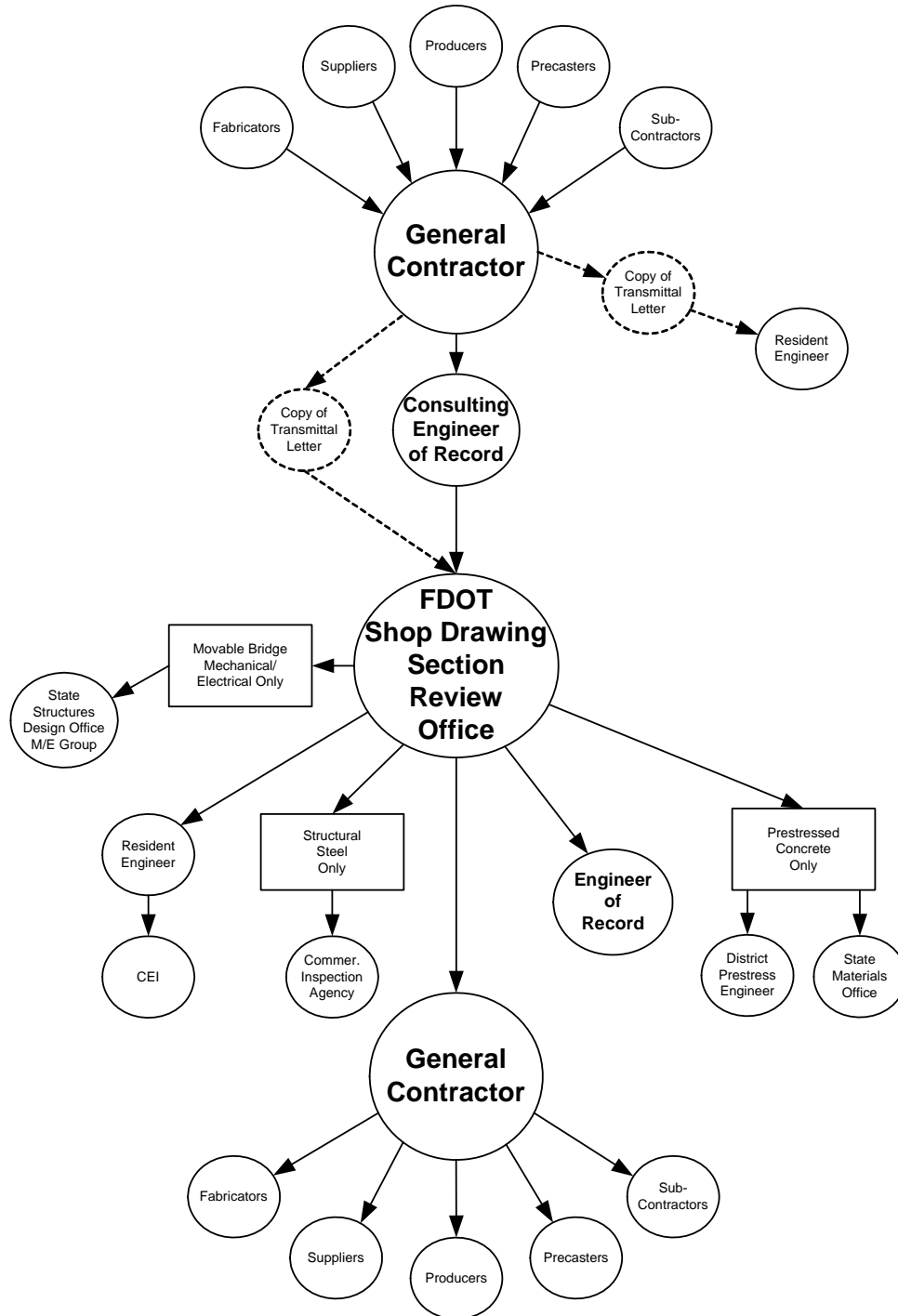
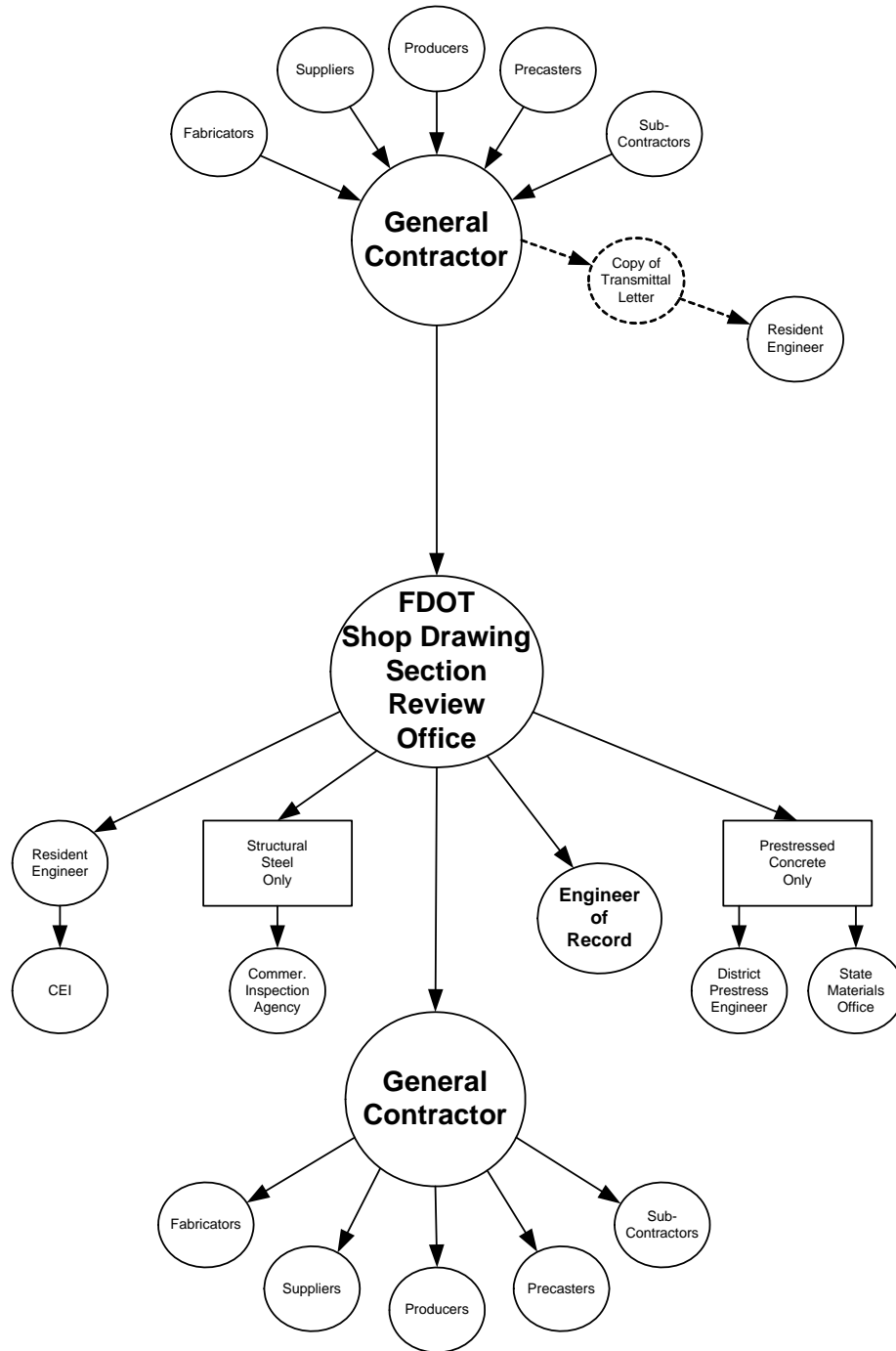

Exhibit 28-C Shop Drawing Flow Diagram for Review by DOT Only (Structural Items)



THIS PAGE LEFT BLANK INTENTIONALLY

Exhibit 28-D Record Shop Drawing Transmittal

(Letterhead of Final Review Office)

RECORD SHOP DRAWING TRANSMITTAL

Date _____

TO: (Destination Office)

FROM: _____

(Final Review Office)

PROJECT NAME _____

FINANCIAL PROJECT ID _____

FEDERAL AID PROJECT NO. _____

CONTRACT ID NUMBER _____

COUNTY (SECTION) _____

STATE ROAD NUMBER _____

BRIDGE NUMBER _____

CONTRACTOR _____

ENGINEER OF RECORD _____

We are transmitting herewith the following Record Shop Drawings for archiving:

1. Shop and Erection Drawing Submittals per attached Logbook.
2. Submittal Activities Record (Logbook)
3. _____
4. _____
5. _____
6. _____

For the Final Review Office: _____
(Signature) (Date)

For the Receiving Office: _____
(Signature) (Date)

THIS PAGE LEFT BLANK INTENTIONALLY

Chapter 29

Structural Supports for Signs, Luminaires, and Traffic Signals

29.1	General	29-1
29.2	Sign Structures.....	29-1
29.2.1	General	29-1
29.2.2	Standard Single Column Ground Signs	29-2
29.2.3	Standard Multipost Ground Signs	29-2
29.2.4	Standard Span Overhead Sign Structures.....	29-2
29.2.5	Standard Cantilever Overhead Sign Structures.....	29-2
29.2.6	Custom Designs.....	29-4
29.2.7	Dynamic Message Sign (DMS) Structures.....	29-4
29.3	Lighting Structures	29-4
29.3.1	General	29-4
29.3.2	Standard Aluminum Light Poles.....	29-4
29.3.3	Standard High-Mast Lighting	29-5
29.3.4	Custom Designs.....	29-5
29.4	Traffic Signal Structures.....	29-6
29.4.1	General	29-6
29.4.2	Mast Arm Signal Structures	29-6
29.4.2.1	Standard Mast Arm Assemblies.....	29-6
29.4.2.2	Standard Mast Arm Assemblies for Site-Specific Loadings	29-8
29.4.2.3	Custom Mast Arm Designs	29-8
29.4.3	Standard Span Wire with Concrete Strain Poles	29-11
29.4.4	Standard Span Wire with Steel Strain Poles.....	29-11
29.4.5	Custom Designs.....	29-11

Figures

Figure 29.1	Flowchart for Designing and Detailing Mast Arm Assemblies.....	29-9
Figure 29.2	Standard Mast Arm Design Loading Trees	29-10

Chapter 29

Structural Supports for Signs, Luminaires, and Traffic Signals

29.1 General

The design criteria for the structural design of all sign, signal, and lighting structures shall be in accordance with AASHTO's *2001 Standard Specifications for Structural Supports for Highway Signs, Luminaires and Traffic Signals*, as modified by the *FDOT Structures Manual, Volume 9*.

Include structural details in the Plans for all sign, signal, and lighting structures. Use the *Design Standards* for sign, signal and lighting structures unless site conditions or other considerations require a custom design.

The following sign and signal structure limits apply:

1. Overhead sign span length: 250 feet
2. Overhead sign cantilever length: 50 feet
3. Mast Arm cantilever length: 78 feet
4. Signal cable span length: 250 feet

These limits were chosen based on past practice and practical experience.

A Design Variation is required when sign or signal structure limits are exceeded. The design variation documentation shall include the type of structure, height, length, discussion of alternatives, and costs.

29.2 Sign Structures

29.2.1 General

FDOT assigns identification numbers to overhead sign structures. See the *Structures Detailing Manual, Chapter 2*, for instructions.

The rectangular unidirectional slipbase sign support systems in **Index No. 11200** and **Index No. 11860** can be used as a single-post or double-post sign support system where both posts are within a 7-foot span. Single post installations may use any post up to a mass of 45 lb/ft. Two-post systems with both posts within a 7-foot span must use posts with a mass of 18 lb/ft or less. Larger posts with masses up to 45 lb/ft may also be used as dual post systems but the posts must be more than 7 feet apart. In no case, however, should the total mass of all the sign posts above the slip-plane and below the hinge be greater than 600 pounds.

29.2.2 Standard Single Column Ground Signs

Refer to *Design Standards, Index No. 11860*.

29.2.3 Standard Multipost Ground Signs

Refer to *Design Standards, Index No. 11200* and *FDOT Multi-Post2001 Sign Program and (old) FDOT Multi-Post Program*.

29.2.4 Standard Span Overhead Sign Structures

The EOR is responsible for the design of all overhead sign structures whether ground mounted or supported on a structure (including bridge structures), unless otherwise directed by the Department. This responsibility is for the entire sign structure, including the supports and foundations, as well as all details necessary to fabricate and erect the sign structures. The EOR is also responsible for the shop drawing review in accordance with **Chapter 28** when sign structure shop drawings are required by the Contract Documents.

In general, however, the designer may refer to the *Design Standards, Index No. 11320*, the *FDOT Span Overhead Sign Program* and the “*Span Sign Structure Data Table*” cell from the FDOT CADD Menu.

29.2.5 Standard Cantilever Overhead Sign Structures

The EOR is responsible for the design of all cantilevered overhead sign structures whether ground mounted or supported on a structure (including bridge structures), unless otherwise directed by the Department. This responsibility is for the entire sign structure, including the supports and foundations, as well as all details necessary to fabricate and erect the sign

structures. The EOR is also responsible for the shop drawing review in accordance with **Chapter 28** when sign structure shop drawings are required by the Contract Documents.

In general, the designer may refer to the **Design Standards, Index No. 11310**, the **FDOT Cantilever Overhead Sign Program** and the **“Cantilever Sign Structure Data Table”** cell from the FDOT CADD Menu.

29.2.6 Custom Designs

If a custom design is required, include, a brief written justification with the 30% plans submittal.

The EOR is responsible for the design of the attachment system for signs mounted on bridge structures.

For sign structures mounted on bridge structures, include their plans in the structures plans. Otherwise, include design details in the signing plans.

29.2.7 Dynamic Message Sign (DMS) Structures

Refer to the *Structures Manual Volume 9* for Dynamic Message Sign Structure requirements.

29.3 Lighting Structures

29.3.1 General

Luminaire Structures may be Standard Aluminum Light Poles, Standard High-Mast Lighting or Custom Designs.

29.3.2 Standard Aluminum Light Poles

Standard, QPL listed, aluminum light poles must comply with the detail requirements shown in the *Design Standards, Index No. 17515*.

For additional design information, see *Chapter 7* of this volume.

Selection Procedure

1. Determine the height difference between the top of foundation and the top of roadway used to set the fixture mounting height, round as necessary.
 - a. Determine the design mounting height (40, 45, or 50 feet) and fixture arm length (8, 10, 12, or 15 feet) required.

- b. The wind height at fixture equals the design mounting height for poles not on fill. For poles on fill, determine the height of the roadway above the surrounding terrain. The wind height at fixture will equal the design mounting height plus the fill height, rounded up to the next highest 5-foot increment.
- c. Determine the pole design variables for each light pole.

Design

1. Fixture Arm Length of 8-feet, 10-feet, 12-feet or 15-feet. Single arm only.
 - a. Design Mounting Height of 40-feet, 45-feet or 50-feet. (May differ from Fixture Mounting Height, see Selection Procedure item 2).
 - b. 25-feet maximum height above adjoining ground surface.
 - c. Design weight of luminaire assumed to be 51 lbs.
 - d. Equivalent projected area of luminaire for design is 1.5 square feet.
2. No bridge or wall mounting permitted.
3. Maximum fill slope at the pole of one vertical to four horizontal. Steeper slopes can be accommodated provided the face of the slope on a horizontal projection from the foundation base is no closer than it would be if a 1:4 slope were projected from the top of the foundation.
4. Unique site circumstances where poorer soil conditions are encountered than shown on **Index No. 17515** may require the foundation variables to be modified from those shown. If custom designs are required, the Geotechnical Engineer will provide the soil information to be used by the EOR during the design phase of the project.
5. Use an Importance Factor (I_r) = 0.80 (25-year recurrence interval).

For additional design information, see **Chapter 7** of this volume.

29.3.3 Standard High-Mast Lighting

Refer to **Design Standards, No. 17502**.

29.3.4 Custom Designs

When custom aluminum light poles are required, or otherwise specifically designated in the contract documents, the EOR is responsible for the structural design of the roadway light poles, foundations, and the review of the Shop Drawings.

29.4 Traffic Signal Structures

29.4.1 General

Mast Arm Assemblies may be Standard Mast Arm Signal Structures, Standard Mast Arms for Site-Specific Loadings, or Custom Designs.

29.4.2 Mast Arm Signal Structures

Design all mast arm traffic signal assemblies with backplates in accordance with **Section 7.4.17**.

Design and detail mast arm assemblies using one of the following three methodologies:

1. Standard Mast Arm Assemblies: Mast arms that utilize all pre-approved components listed on the Department's Qualified Products List (QPL) and that have been pre-designed for the selected Load Trees shown in **Figure 29.2**.
2. Standard Mast Arm Assemblies for Site-Specific Loadings: Mast arms for unique loadings but which utilize all pre-approved QPL components.
3. Custom Mast Arm Designs: Special Mast arms for unique loadings and/or geometric constraints that contain any component (arm or pole) that is outside the range of those listed on the QPL.
4. For additional design information, see **Chapter 7** of this volume.

29.4.2.1 Standard Mast Arm Assemblies

Refer to **Design Standards, Index Nos. 17743** and **17745**, the **FDOT MastArm Program**, and the **“Standard Mast Arm Assemblies Data Table”** cell from the FDOT CADD Menu. Standard mast arm assemblies must comply with all the requirements and design criteria shown on **Index Nos. 17743** and **17745**.

Standard Mast Arm assemblies are limited to 110, 130 or 150 mph design wind speeds with one of the load tree configurations shown in **Figure 29.2**, and either single arm, single arm with luminaire, or double arms with arm orientations of 90° or 270° only.

Foundations and base plates for standard mast arm assemblies are pre-designed based on the following soil criteria:

- Classification: Cohesionless (Fine Sand)
- Friction Angle: 30 Degrees
- Unit Weight: 50 lbs./cubic foot (assumed submerged)

When the designer considers soil types at the specific site location to be of lesser strength properties than shown above, an analysis is required. Auger borings, SPT borings, or CPT soundings may be used as needed to verify the assumed soil properties, and at sites confirmed to be uniform, a single boring or sounding may cover several foundations. Borings in the area that were performed for other purposes may be used to confirm the assumed soil properties. Unique site circumstances may require the foundation variables to be modified from those shown on **Index 17743**. Accomplish this by completing the "Special Drilled Shaft Data" in the "Standard Mast Arm Assemblies Data Table". The Geotechnical Engineer must justify the differing foundation criteria to the District Structures Design Engineer during the design phase of the project.

To use standard mast arm assemblies:

1. Confirm that the information furnished by the signal designer in the "Mast Arm Tabulation Sheet" meets the geometric and load tree limitations shown in **Figure 29.2**.
2. Follow the procedure described in the design examples in **Volume 2, Chapter 24**, complete the necessary information required in the "Standard Mast Arm Assemblies Data Table" and include in the Traffic Plans.

29.4.2.2 Standard Mast Arm Assemblies for Site-Specific Loadings

The **FDOT Mast Arm Program** will select component parts from those shown on **Index No. 17743** for site specific load configurations differing from those shown in **Figure 29.2**.

In order to be eligible for utilization of QPL component parts, the mast arm assemblies must utilize only arms and poles from the components listed in the tables on **Index No. 17743**. As for standard mast arm assemblies, the foundation design is included with the pole selection and needs no further information.

Design and detail standard mast arm assemblies utilizing QPL component parts in the plans in the same manner as for standard mast arm assemblies by use of the “**Standard Mast Arm Assemblies Data Table**” cell. Similarly, because all QPL component parts are used, shop drawings are not required.

29.4.2.3 Custom Mast Arm Designs

The **FDOT Mast Arm Program** will provide the necessary variables to be shown in the “**Special Mast Arm Assemblies Data Table**” cell from the FDOT CADD Menu.

Show special mast arm assemblies and foundations in the plans. Refer to **Index No. 17745**. Require shop drawings for all special mast arm assemblies.

Figure 29.1 Flowchart for Designing and Detailing Mast Arm Assemblies

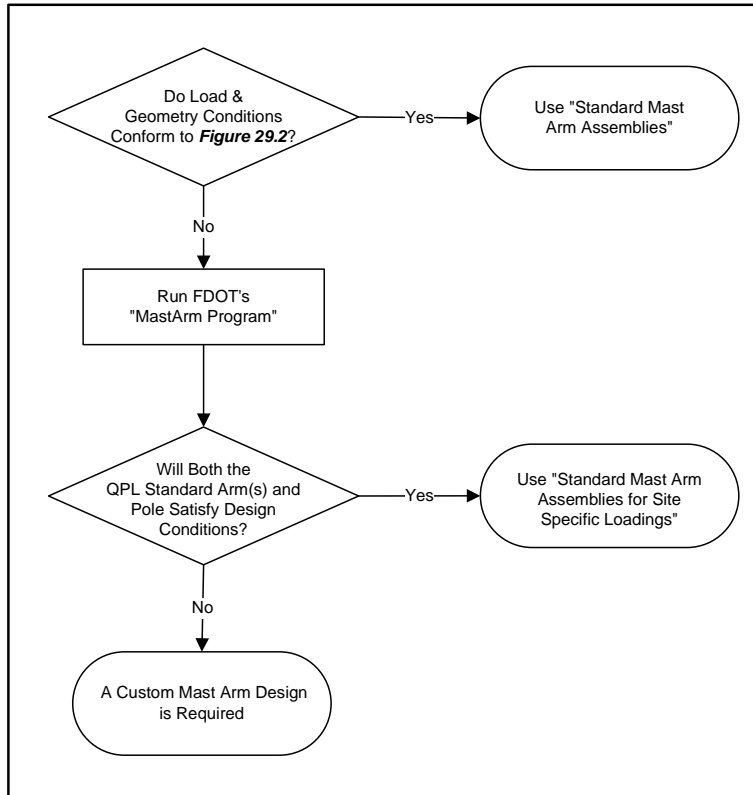
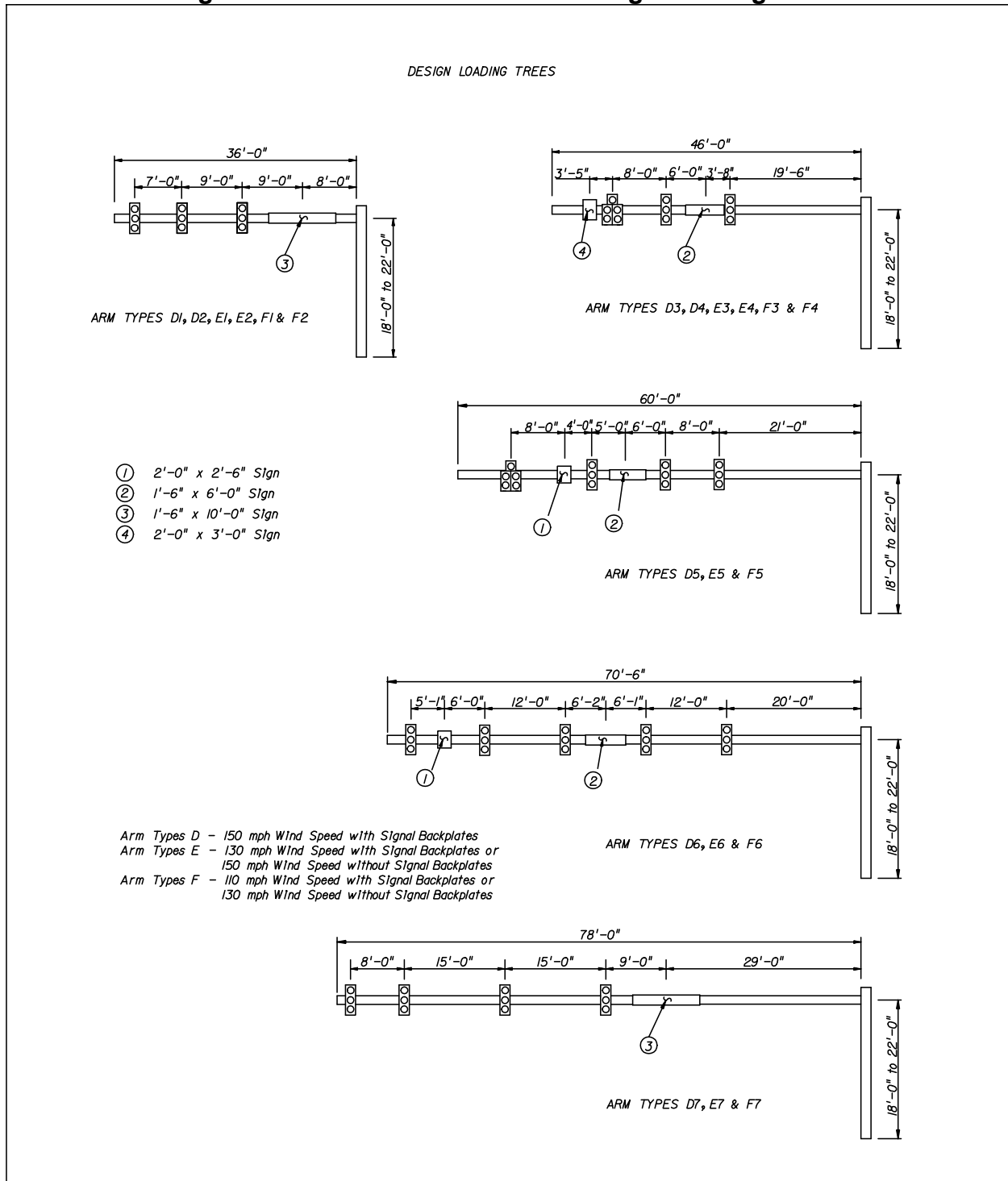

Figure 29.2 Standard Mast Arm Design Loading Trees



29.4.3 Standard Span Wire with Concrete Strain Poles

Refer to *Design Standards, Index No. 17725*, the *FDOT Strain Pole Program*, and the *University of Florida Bridge Software Institute ATLAS Program*.

29.4.4 Standard Span Wire with Steel Strain Poles

Refer to *Design Standards, Index No. 17723*, the *FDOT Strain Pole Program*, and the *University of Florida Bridge Software Institute ATLAS Program*.

29.4.5 Custom Designs

When custom traffic signal structures are required, or otherwise specifically designated in the contract documents, the EOR is responsible for the structural design, foundations, and review of the Shop Drawings.

THIS PAGE LEFT BLANK INTENTIONALLY

Chapter 30

Retaining Walls

30.1	Purpose.....	30-1
30.2	Conventional (C.I.P.) Retaining Walls and Proprietary Retaining Walls (Permanent Walls)	30-2
30.2.1	Retaining Walls (Conventional Design).....	30-3
30.2.2	Retaining Walls (Proprietary Design) (Design Required in Contract Plans).....	30-5
30.2.3	Retaining Walls (Proprietary Design - Control Plans only; Full Design not Required in Contract Plans)	30-7
30.2.4	Wall System Selection	30-8
30.3	Critical Temporary Walls	30-9
30.4	Experimental Wall Projects	30-11
30.5	Shop Drawing Review.....	30-12
30.6	Bidding Procedure.....	30-14

Figures

Figure 30.1	Location of Critical Temporary Wall with Respect to Traffic Lanes	30-10
-------------	---	-------

Exhibits

Exhibit 30-A	Permanent Retaining Wall Design	30-15
--------------	---------------------------------------	-------

THIS PAGE LEFT BLANK INTENTIONALLY

Chapter 30

Retaining Walls

30.1 Purpose

The purpose of this chapter is to give the designer an understanding of the procedure to develop retaining wall plans. A step-by-step method to develop and organize the retaining wall plans is presented. An example of retaining wall plans is included. This chapter should be used in conjunction with the ***Structures Design Guidelines (SDG)***.

If the difference in height between the ground levels to be supported is 5 ft. or less, a gravity retaining wall is generally the most efficient structure to be used. For details of gravity retaining walls see the ***Design Standards, Index No. 520***.

When the difference in height between the ground levels to be supported exceeds 5 ft., then either a reinforced cast-in-place (C.I.P.) concrete cantilever retaining wall or a proprietary retaining wall is required.

Roadside barriers are generally required to shield vertical drop-offs created by retaining walls in fill sections. See ***Chapter 4*** of this volume for guidance on roadside barrier requirements.

Handrails or fences for bicyclists and pedestrians are also generally required when retaining walls are located within the right of way. This requirement must be addressed for retaining walls in fill sections as well as at the top of retaining walls in cut sections. In cut sections, the character and use of the adjoining property shall be considered when selecting the type of protection required. See ***Chapter 8*** of this volume for pedestrian and bicycle rail requirements.

In general, proprietary retaining walls should be utilized for projects when the exposed surface area of the walls exceed 1000 square ft. and sufficient room for the earth reinforcement system is available; however, site specific conditions must always be considered when determining the type(s) of wall to be designed. Proprietary precast walls other than MSE walls should be used as an alternate to C.I.P. walls when sufficient room for soil reinforcement is not available.

The following sections refer to the structures submittal procedure. For projects where there are no bridges, the roadway designer shall adjust the procedure as required for the roadway project.

30.2 Conventional (C.I.P.) Retaining Walls and Proprietary Retaining Walls (Permanent Walls)

The Department's policy is to provide either a set of conventional retaining wall plans or the "preapproved standard details" for all the proprietary walls that are technically appropriate for the site for all projects where walls are not supported on piles. Projects where walls are supported on piles only require a conventional pile supported wall design or a pile supported proprietary wall design. Omission of conventional retaining walls is possible if adequate justification is provided.

Proprietary retaining wall design plans are not required in the contract plans for normal uncomplicated wall projects. If the proprietary walls are experimental, exceed 40 ft. in height, are subject to unusual geometric or topographic features or, by the geotechnical report, will be subjected to excessive settlement, or environmental conditions, they may be required to have fully detailed design plans in the contract set.

The success of this method of producing and letting wall plans is highly dependent on complete, accurate and informative Control Plans. The importance of the Geotechnical Engineer's role in this scheme cannot be emphasized enough and shall include the following responsibilities:

1. Borings.
2. Soils Report.
3. Wall Type recommendation.
4. For Proprietary Walls: external stability analysis, minimum soil reinforcement length vs. wall height for external stability, maximum bearing pressure for each wall height and soil reinforcement length for each different wall height (1.5 ft. increments).
5. Review of internal stability design as provided by the wall companies.
6. Establishment of allowable bearing pressures.

The normal failure modes to be investigated are shown in **SDG, Figure 3-1**.

Step-by-step procedures for developing retaining wall plans follow.

30.2.1 Retaining Walls (Conventional Design)

1. Bridge Development Report (BDR) / 30% Plans

The BDR shall discuss and justify the use/non-use of conventional retaining walls. If the use of conventional retaining walls is applicable to the site and economically justified, it may be the only design required or it may be an alternate to a proprietary design. The 30% Plans submittal shall contain a location plan, plan and elevation of walls showing vertical and horizontal alignment, cross sections and details. The plans shall denote location of drainage inlets, utilities, sign structures, lights and barrier joints. Specifically the submittal package shall include:

a. Plan:

A plan view of the wall and footings which indicate pertinent dimensions, boring locations and horizontal alignment.

b. Elevation:

A front view of the wall which indicates pertinent dimensions and elevations, sign and lighting structures locations, drainage structure locations and flow line elevations, location of section views and vertical alignment.

c. Sections:

Sections taken through the wall to better indicate dimensions and elevations.

d. General Notes including:

- 1) Design Toe Pressure
- 2) Environmental Classification
- 3) Concrete - (Strength and Class)
- 4) Reinforcing Steel - (Grade)
- 5) Design Method
- 6) Soil Design Parameters for both the in situ and backfill materials
- 7) Load and Resistance Factors

2. 30% Plans:

The 30% Plans shall be submitted for approval and development of the plans continued towards the 90% Plans submittal.

3. 90% Plans:

The 90% Plans submittal shall be further developed to include, in addition to the information required for the 30% Plans, the following:

- a. Plan:
A plan view of the wall and footings which indicates pertinent dimensions; reinforcing steel locations, cover and spacing in footings; and boring locations, back of wall drainage details and horizontal alignment.
- b. Elevation:
A front view of the wall which indicates pertinent dimensions and elevations; location of section views; reinforcing steel location, cover and spacing; back of wall drainage and flow lines; vertical alignment; and locations of construction and expansion joints.
- c. Sections:
Sections taken through the wall to better indicate dimensions, reinforcing steel locations, concrete cover for rebars and elevations.
- d. Estimated Quantities:
Estimated quantities for items incorporated in the wall, reinforcing bar list and standard bar bending sheet.

The Structures Design Office has prepared ***Index No. 5100*** of the ***Design Standards*** for use in conventional cantilever retaining wall designs. This Design Standard is to be used in conjunction with the Retaining Wall computer program available on the Structures Design Office web site. Design assumptions used in the development of ***Index No. 5100*** are in the “Retaining Wall Notes” in the program.

30.2.2 Retaining Walls (Proprietary Design) (Design Required in Contract Plans)

The following procedure for plans preparation should be followed if the walls are required to be fully detailed in the contract plans.

1. BDR/30% Plans

The BDR shall discuss and justify the use of proprietary retaining walls. The 30% Plans shall contain preliminary Control Plans. It will not be necessary for these Plans to contain pay items and standard drawings; however, they shall include, but not be limited to, the following information:

- a. Key Sheet
- b. General Notes Sheet
 - 1) General notes
 - 2) In situ soil characteristics
 - 3) Design parameters
 - 4) Applicable wall systems
- c. Plan and Elevation Sheet:
 - 1) Horizontal and vertical alignment
 - 2) Limits of wall
 - 3) Utility locations
 - 4) Plan view of wall
 - 5) Elevation view of wall (showing existing and proposed ground lines, elevations at 25 ft. intervals at top of wall, wall embedment (maximum elevation at top of leveling pad) and beginning and end of wall stations)
 - 6) Boring locations
 - 7) Quantity (pay area of walls)
 - 8) Table showing soil reinforcement length vs. wall height (for external stability)
 - 9) Design parameters - Load and Resistance Factors
 - 10) Sections thru wall showing offset control point, pay area, ditches, sidewalks, superelevation and other unusual features

- 11) Ranges of wall systems applicable to the portion of the project defined by the plan and elevation sheet.
 - d. Soil Profile Sheet
 - e. General Details showing:
 - 1) Wall/end bent cap interface
 - 2) Barrier and coping to wall interface
 - 3) Pile, inlets and pipe conflicts with soil reinforcement and slip joint details
 - f. Preapproved Standard Drawings:

Note: Through the June 2006 letting, standard drawings for each of the alternate companies will be included in the **Design Standards**. As of the July 2006 letting, only general notes and common details for the proprietary retaining wall systems will be included in the **Design Standards**. Vendor drawings with wall specific details for each approved wall company will be relocated on the State Specifications Office QPL website.
2. Control Plans/Invitation Package

The Control Plans shall be reviewed by the Department and, upon approval, sent to all the appropriate wall companies. The companies shall be provided with a set of control plans, roadway plans and foundation report. The Control Plans shall be sent to the wall companies as soon as they are approved. This action shall be accomplished as soon as possible but not later than the 60% Plans. A copy of the transmittals to the wall companies shall be sent to the DSDO or SDO as appropriate. The proprietary companies shall acknowledge receipt of the invitation package. If they choose to participate they shall provide design plans for the retaining walls and submit the plans for review as prescribed in the invitation letter.
 3. 90% Plans

Upon receipt of the proprietary design plans, the designer shall review the design and incorporate the wall plans into the contract set. The plans from the wall companies, control plans and wall company standard drawings shall constitute the 100% Plans.

30.2.3 Retaining Walls (Proprietary Design - Control Plans only; Full Design not Required in Contract Plans)

Use the following procedure in preparing plans for wall projects.

1. BDR/30% Plans

Discuss and justify the use of proprietary retaining walls and FDOT Wall Types (see **Index 5300**) in the BDR. Provide documentation of all the site-specific geotechnical information and wall system considerations in the Retaining Wall Justification portion of the BDR. Include the Retaining Wall System Data Tables and Preliminary Control Plans with the information shown in **Section 30.2.2** for the Plan and Elevation Sheets.

2. 90% Plans

Include the Control Plans into the 90% Plans submittal.

General notes, common details, and the Table of FDOT Wall Types are shown in the **Design Standards**. Approved proprietary retaining wall system drawings and details are listed, with FDOT Wall Type, on the State Specifications Office QPL website. The Data Tables are available on the Structures FDOT CADD Menu cells.

The site-specific wall design details are submitted as shop drawings for each project.

30.2.4 Wall System Selection

Using the site-specific geotechnical information, the Engineer of Record (EOR), in cooperation with the geotechnical engineer, will determine all wall system requirements. Design considerations include short term and/or long term settlement, differential settlement (both longitudinal and from front of wall to end of concrete stems or soil reinforcement (rotation)), and global stability. Use the Flow Chart **Exhibit 30-A** for Permanent Retaining Wall Design to determine:

1. Plan requirements
2. Concrete Class, Concrete Cover, and FDOT Wall Type

For all walls, place notes on the General Notes sheet of the Control Plans in accordance with the Plan Requirements listed in the Flow Chart **Exhibit 30-A**.

During construction on projects with a FDOT Wall Type listed in the plans, the contractor will submit, for approval by the engineer, a QPL approved wall system allowed in accordance with FDOT Wall Type Table. The July 2006 **FDOT Standard Specifications Section 548, Retaining Wall Systems** will state: Unless otherwise detailed and/or shown in the plans, choose a wall system from the Qualified Products List (QPL) in accordance with the FDOT Wall Type listed in the plans.

On projects with non-QPL Walls (non-proprietary walls, complex walls, two phase walls, total settlement > 6 inches, differential settlement > 0.5%, etc), the complete wall design and details are included in the plans.

30.3 Critical Temporary Walls

A critical temporary wall is one that is necessary to maintain the safety of the traveling public, or structural integrity of nearby structures and utilities for the duration of the construction contract. Traffic lanes located either above or below a grade separation and within the limits shown in **Figure 30.1**, will require the design of a critical temporary wall. Critical temporary walls shall be designed in accordance with this chapter, the **AASHTO LRFD Bridge Design Specifications**, and the **Structures Design Guidelines**. Generally temporary walls should be either mechanically stabilized earth (MSE) walls or steel sheet pile walls.

Critical temporary proprietary MSE walls shall comply with **Design Standard Index No. 5301** and require generic design details in the contract plans. The plans format shall be in accordance with **Section 30.2.2** and **30.2.3**. Include control drawings and the completed Temporary Retaining Wall System Data Tables (See Structures FDOT CADD Menu cell). The final design details shall be submitted in the shop drawings.

Critical temporary sheet pile walls require complete design details in the contract plans. Include control drawings or tables with wall limits, minimum section modulus per foot, minimum moment of inertia per foot, minimum material properties, and minimum tip elevations. Provide a construction sequence and appropriate details if tiebacks are required, including anchors, wales, and deadmen or pullout resistance for grouted anchors.

Figure 30.1 Location of Critical Temporary Wall with Respect to Traffic Lanes

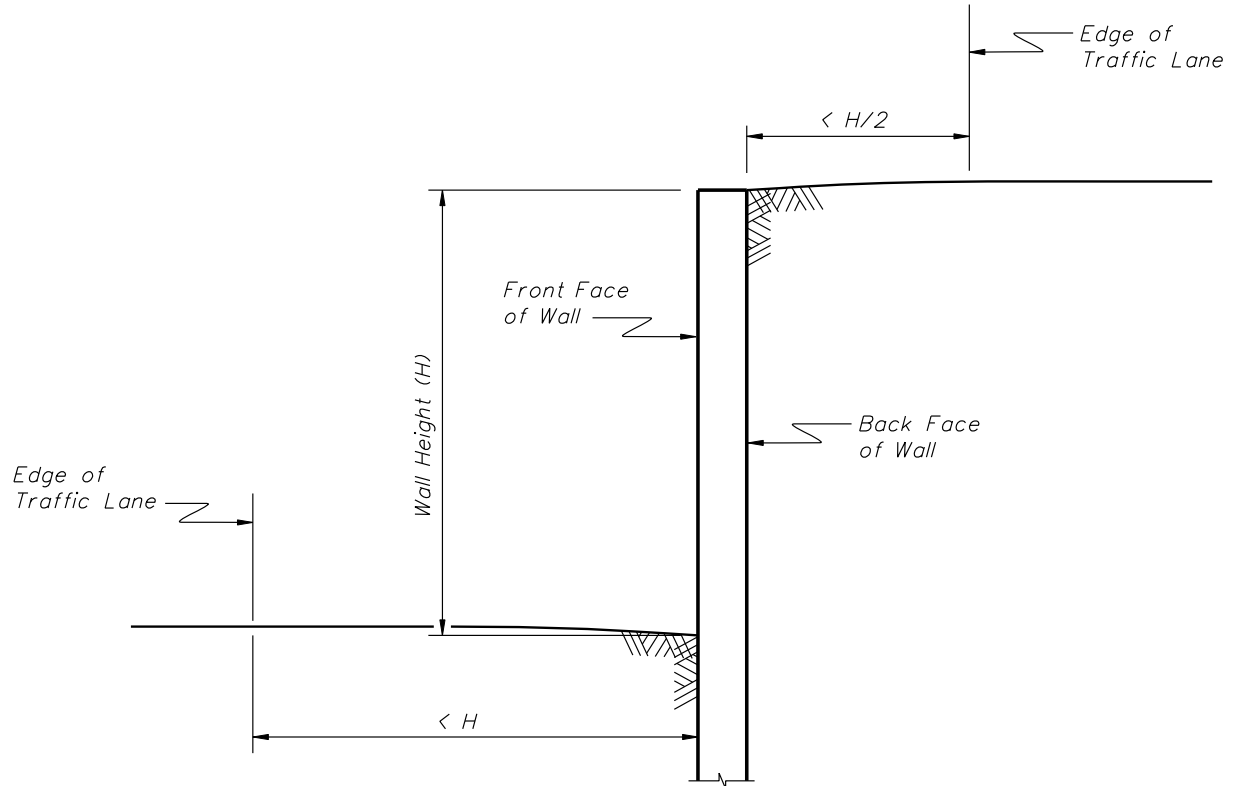

30.4 Experimental Wall Projects

Proprietary wall companies must comply with the Department's ***Guidelines for Selection and Approval of Proprietary Retaining Wall Systems, Topic No. 625-A20-118*** (available in Central Office Structures Design) and prepare standards to be approved and adopted by the FDOT. One of the requirements is to build a wall that may, at the discretion of the Department, be instrumented and monitored. Special instruction for design and plans preparation shall be obtained from the State Structures Design Office.

30.5 Shop Drawing Review

Conventional C.I.P. retaining walls do not require shop drawings; however, proprietary retaining walls require shop drawings in accordance with **Chapter 28**.

The shop drawing reviewer (EOR) shall be experienced in the requirements, design and detailing of proprietary wall plans. The EOR shall review but not be limited to the following items:

1. Verify vertical and horizontal geometry with contract plans.
2. Verify details with MSE wall suppliers standard details in contract plans.
3. Soil reinforcement placement in acute corners shall be detailed.
4. Slip joints shall be at all bin wall and standard MSE wall interface locations.
5. Soil reinforcement shall be detailed at all obstructions. Cutting or kinking of soil reinforcement shall not be allowed. Connection of soil reinforcement to piles or bearing against piles shall not be allowed.
6. Corner panels shall be used at all locations where walls are deflected horizontally 5 degrees or more.
7. Compare proposed reinforced fill characteristics with design fill characteristics. In-place moist density of backfill may vary by ± 5 pcf, and the internal friction angle may be 1° less than the design values (as shown in control plans) before a check of the wall design is required. If the internal friction angle is greater than the design value then a redesign is not required.
8. Review proprietary wall internal stability design calculations.
9. Verify soil reinforcement lengths for conformance to the **Structures Design Guidelines**, the external stability table on the plans, and the internal stability design calculations.
10. Confirm wall embedment.
11. Verify panel types and thickness are consistent with contract plans.
12. Soil reinforcement lengths shall be the same from top to bottom of wall at any section. The diameters of the longitudinal and transverse bars of any given mesh reinforcement shall be equal. The cross section of any soil reinforcement shall not vary along its length (i.e., "2WII" reinforcement shall not be spliced to "4WII").
13. Check stress level in soil reinforcement and connections.

14. Check steel strap soil reinforcement and consider the following for long straps:
 - a. One splice shall be permitted for steel strap soil reinforcement in excess of 32 feet in length.
 - b. Splice connection shall be Bearing-Type connections designed in accordance with the latest **AASHTO LRFD Bridge Design Specifications**.
 - c. Bolts shall be hot-dip galvanized ASTM A325 with appropriate washer and nut.
 - d. Corrosion rates for connections shall be in accordance with **Structures Design Guidelines Section 3.13.2-J**.
 - e. Holes shall be punched or drilled before galvanizing.
 - f. Strap extension shall be greater than $\frac{1}{4}$ of the total strap length.

30.6 Bidding Procedure

The conventional C.I.P. walls shall be bid as Concrete (Retaining Wall) and Reinforcing Steel (Retaining Wall). Conventional walls may be bid as an alternate to proprietary walls if the site conditions justify conventional walls.

Proprietary Walls shall be bid with Pay Item numbers;

548-___ Retaining Wall System (Permanent)

548-___ Retaining Wall System (Temporary)

Exhibit 30-A Permanent Retaining Wall Design Flowchart for Retaining Wall Design*

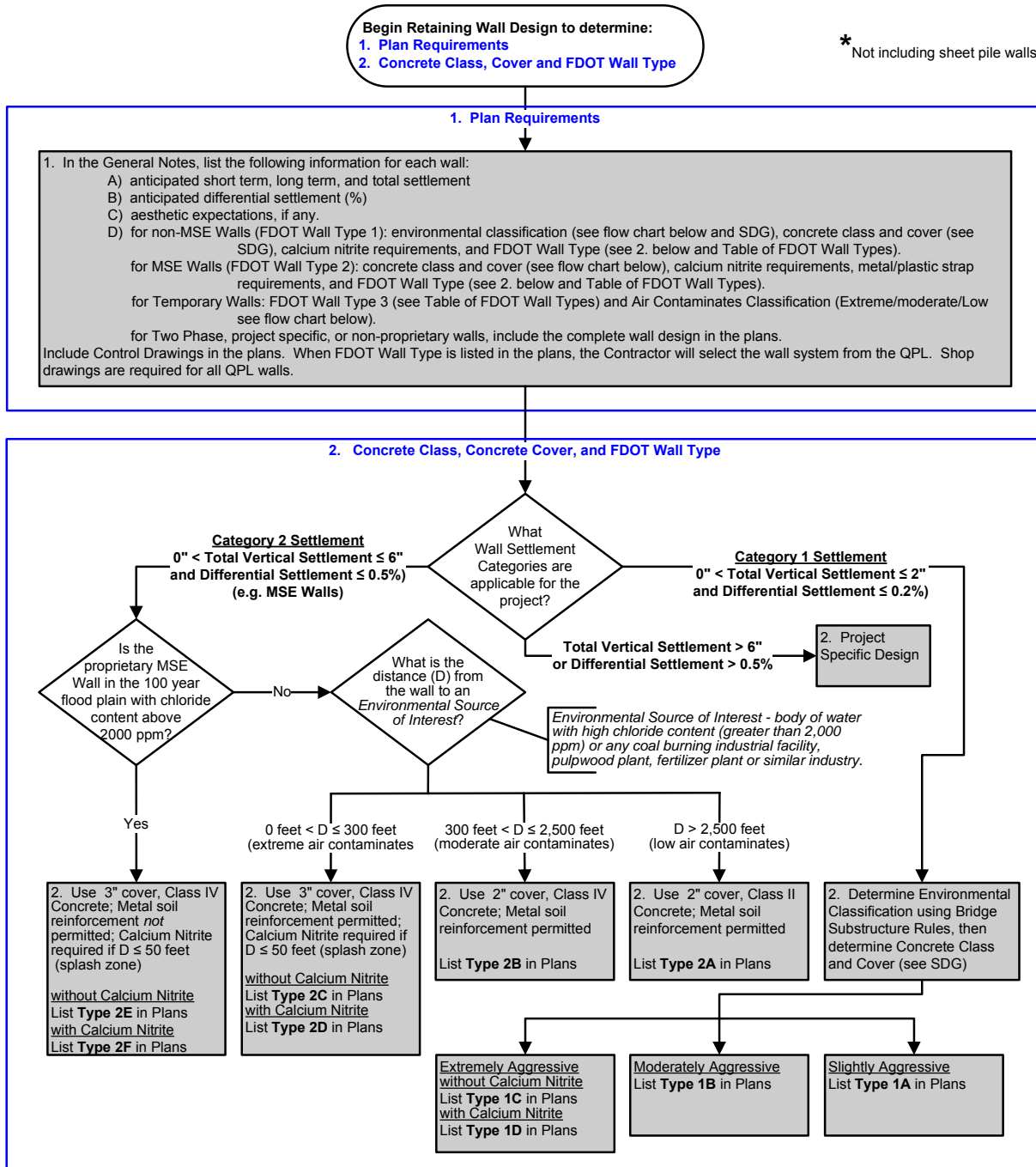

(CONTINUED ON NEXT PAGE)

Exhibit 30-A Permanent Retaining Wall Design (Continued)

Table of FDOT Wall Types																										
Wall Type ¹	Proprietary QPL Item	Settlement Category	Design Settlement Limitations			Durability Category	Durability Factors				Other Allowable Wall Types ⁷															
			Total Settlement ²		Differential Settlement ³		Typical Wall Construction	Concrete Cover	Concrete Class	Calcium Nitrate	Soil Strap Type	1A	1B	1C	1D	2A	2B	2C	2D	2E	2F					
Type 1	No	1	≤ 2"	and	≤ 0.2%	Cantilever, Gravity, and Counterfort Walls	Project Specific				Project Specific															
Type 1A	Yes						A	2"	II	No	n/a	✓	✓	✓	✓	✓	✓	✓	✓	✓	✓	✓	✓			
Type 1B							B	2"	IV	No		✓	✓	✓	✓	✓	✓	✓	✓	✓	✓	✓	✓	✓		
Type 1C							C	3"	IV	No		✓	✓	✓	✓	✓	✓	✓	✓	✓	✓	✓	✓	✓	✓	
Type 1D ⁴							D	3"	IV	Yes		✓	✓	✓	✓	✓	✓	✓	✓	✓	✓	✓	✓	✓	✓	
Type 2	No	2	≤ 6"	and	≤ 0.5%	MSE Walls	Project Specific				Project Specific															
Type 2A	Yes						A	2"	II ⁵	No	metal	✓	✓	✓	✓	✓	✓	✓	✓	✓	✓	✓	✓			
Type 2B							B	2"	IV ⁵	No		✓	✓	✓	✓	✓	✓	✓	✓	✓	✓	✓	✓	✓		
Type 2C							C	3"	IV ⁵	No		✓	✓	✓	✓	✓	✓	✓	✓	✓	✓	✓	✓	✓	✓	
Type 2D							D	3"	IV ⁶	Yes		✓	✓	✓	✓	✓	✓	✓	✓	✓	✓	✓	✓	✓	✓	
Type 2E							E	3"	IV ⁵	No		✓	✓	✓	✓	✓	✓	✓	✓	✓	✓	✓	✓	✓	✓	✓
Type 2F ⁴							F	3"	IV ⁶	Yes		✓	✓	✓	✓	✓	✓	✓	✓	✓	✓	✓	✓	✓	✓	✓
Type 3	Yes	3	n/a		≤ 2.0%	Temporary Walls	n/a				metal/plastic	n/a														

1 - Listed in the Plans; Wall Type combines both Settlement Limitations and Durability Factors.
 2 - Amount of wall settlements that will occur in its design life and includes both short and long term settlements. Short term settlements occur during wall construction and may contain elastic deformation and densification settlement. Long term settlements continue after the completion of the wall and may include consolidation and secondary consolidation/creep settlements.
 3 - Settlements along the alignment of and perpendicular to the wall face; usually are not uniform. Expansion joints for the cast-in-place walls and slip joints for MSE walls are provided to control wall and wall panel cracks, respectively.
 4 - Includes all underground walls and walls submerged in water.
 5 - For concrete requirements, see Specification Section 346 using slightly aggressive environment.
 6 - For concrete requirements, see Specification Section 346 using extremely aggressive environment.
 7 - "Other Allowable Wall Types" listed with a "✓", have Settlement Limitations and Durability Factors greater than those required by the "Wall Type" (Column 1).

Chapter 31

Geosynthetic Design

31.1	Purpose	31-1
31.2	Contract Plans Content	31-2
31.3	Bid Procedure	31-2
31.4	Shop Drawings / Redesigns	31-3
31.5	Geosynthetic Reinforcement Design Methodology	31-4
31.5.1	Design Considerations	31-4
31.5.2	Requirements	31-4
31.5.3	Design Guidelines	31-7
Exhibits		
Exhibit 31-A	Geosynthetic Reinforced Soil Slopes	31-9
Exhibit 31-B	Geosynthetic Reinforced Foundations Over Soft Soils	31-10

THIS PAGE LEFT BLANK INTENTIONALLY

Chapter 31

Geosynthetic Design

31.1 Purpose

The purpose of this chapter is to give the designer an understanding of the procedure to develop designs for geosynthetic reinforced soil slopes and geosynthetic reinforced foundations over soft soils. A step-by-step method to develop and organize the plans is presented.

Reinforced soil slopes should be utilized when the right of way is insufficient to construct embankments with normal slopes and retaining walls are not economical or are undesirable.

Reinforced foundations over soft soils should be utilized when the existing soils are too weak to support the anticipated loading without excessive settlement and excavation and backfilling is not an economical solution.

Approved products for these designs are included on ***Index No. 501*** of the ***Design Standards***.

31.2 Contract Plans Content

Control drawings are required which depict the geometrics (plan and elevation view) of the area being reinforced. These designs are generic and are not based upon any one specific product or supplier. For reinforced slopes the designer shall design the slopes using the maximum reinforcement spacings allowed. For soft soils the designer shall design the reinforcement and provide the minimum total strength required.

The plans shall depict the required reinforcement strength based on the maximum allowed spacing of these materials, the extent and the number of layers of geosynthetic reinforcement, vertical spacing of geosynthetic reinforcement, orientation of geosynthetic facing details, details at special structures or obstructions, typical construction sequence, and top and bottom elevations of the geosynthetic reinforcement. Product names are not to be shown in the plans. Surface treatments and any other required design parameters or limitations shall also be shown in the plans.

31.3 Bid Procedure

Geosynthetic Reinforced Soil Slopes shall be bid with Pay Item No.145-1.

Geosynthetic Reinforced Foundations Over Soft Soils shall be bid with Pay Item No. 145-2.

31.4 Shop Drawings / Redesigns

The contractor can choose to construct the reinforced soil structures either by: (1) using materials which meet or exceed the strength required in the plans and be placed at or less than the plan spacing(s) or (2) submitting an alternate design which optimizes the use of a specific material and revises the material spacing within the limits contained in the design methodology in **Section 31.5**. The properties of site specific backfill is seldom available at the design phase of a project. This being the case, subsequent alternate designs are encouraged after the backfill source is known. Using soil properties of site specific material allows for optimization of the materials resulting in a corresponding cost benefit to the Department. All designs shall meet the design methodology contained in **Section 31.5**.

The shop drawing reviewer shall be experienced in the requirements, design and detailing of these systems. The review shall consist of but not limited to the following items:

1. Verify horizontal and vertical geometry with the contract plans.
2. Soil reinforcement is listed in the **Design Standards, Index 501**.
3. Soil reinforcement material test results meet or exceed values in the **Design Standards, Index 501**.
4. Verify the material strengths and number of layers of the product selected meets or exceeds the design shown in the contract plans.
5. Soil properties for the material chosen by the contractor meet or exceed those used in the design shown in the Contract Plans.
6. If a redesign is proposed, verify the design meets the requirements of **Section 31.5** and the Contract Plans.

If a redesign is submitted, complete plans shall be provided which include: plan view, elevation view, and details in accordance with the Plans and Specifications. These shall show the extent, number of layers of geosynthetic reinforcement, minimum properties of each geosynthetic reinforcement layer, vertical spacing of geosynthetic reinforcement, orientation of geosynthetic facing details, details at special structures or obstructions, typical construction sequence, and top and bottom elevations of the geosynthetic reinforcement. Calculations shall be submitted to substantiate the design meets the requirements in this document and in accordance with the Contract Plans. As a minimum these shall clearly show the derivation of reinforcement requirements (i.e., type, spacing, length, etc.) and determination of all design parameters and factors. All plans and calculations are to be sealed by a Professional Engineer licensed in the State of Florida.

31.5 Geosynthetic Reinforcement Design Methodology

This design methodology applies only for geosynthetic reinforced soil slopes and geosynthetic reinforced foundations over soft soils. Geosynthetic is a generic term for all synthetic materials used in Geotechnical engineering applications and includes geotextiles and geogrids.

31.5.1 Design Considerations

Only those geosynthetic products listed on the *Design Standards, Index 501* are eligible for use on FDOT projects. The geosynthetic reinforced systems shall be designed using comprehensive stability analyses methods that address both internal and external stability considerations by a professional engineer licensed in Florida who specialized in Geotechnical engineering. The following design guidelines and requirements should be used for the analyses and design.

31.5.2 Requirements

1. **Performance:** The design factors of safety used shall be adequate to cover all uncertainties in the assumptions and design. Required minimum stability factors of safety are:
 - a. 1.5 against pullout failure.
 - b. 1.5 against sliding of the reinforced mass.
 - c. 1.3 against external, deep-seated failure.
 - d. 1.3 against compound failure, i.e., failure behind and through the reinforcement.
 - e. 1.3 against internal failure.
 - f. 1.3 against local bearing failure (lateral squeeze).

2. **Allowable Tension:** The geosynthetic design shall be based on the following relationships:

$$T_a = \frac{T_{ult}}{F_c F_d F_j CRF}$$

Where:

T_a = The allowable long term reinforcement tension. (T_a shall not exceed 19% T_{ult} for permanent applications or 29% T_{ult} for temporary applications).

T_{ult} = The ultimate strength of a geosynthetic.

F_c = Partial factor of safety for construction damage.

F_d = Partial factor of safety for durability.

F_j = Partial factor of safety for joint strength where geosynthetics are connected together or overlapped in the direction of primary force development. The values of F_j should be taken as the ratio of the unjointed specimen strength to the joined specimen strength. Use $F_j = 1.0$.

CRF = Creep reduction factor. $CRF = T_{ult}/T_{creep}$

T_{creep} = Serviceability state reinforcement tensile load based on minimum 10,000 hour creep tests.

These parameters can be found from the appropriate FDOT ***Design Standards, Index 501.***

For applications involving reinforcing slopes with geosynthetic, T_{creep} shall be projected for a design life of 75 years.

3. **Soil Reinforcement Interaction:** Unless existing approved values are used, pullout resistance for design purposes shall be determined from pullout testing performed by an approved testing laboratory. The coefficient of interaction (C_i) shall be determined from controlled strain rate pullout testing done in accordance with GRI GG5. C_i is defined by the following relationship:

$$C_i = \frac{T_p}{2 L \sigma_n \text{TAN } \Phi}$$

Where:

- T_p = Pullout capacity of reinforcement (lbs/foot of width).
 L = Geosynthetic embedment length (ft.).
 σ_n = Effective normal pressure (psf).
 Φ = Effective friction angle of backfill.

The coefficient of interaction should be approximately constant for a given soil and geosynthetic material over a range of effective normal pressures. If a plot of C_i vs. σ_n indicates that C_i is approximately constant then that value shall be used for design. If the plot indicates a relatively wide variability of C_i over the anticipated range of normal stresses then either a single minimum value shall be used for C_i or a C_i corresponding to the effective stress at each expected grid elevation may be used.

The coefficient of interaction may be determined by any one of the following means:

- a. Pullout testing may be performed on the proposed geosynthetics and actual soil backfill being proposed for the construction.
- b. Pullout testing is required for geosynthetic products as part of the **Design Standards, Index 501** approval process. If, in the opinion of the Engineer, the existing approved pullout test data is representative of the proposed soil backfill and geosynthetic reinforcement, these corresponding C_i values may be used.

31.5.3 Design Guidelines

The design guidelines are excerpted from the FHWA Publications (a) **No. FHWA-SA-96-071 "Mechanically Stabilized Earth Walls and Reinforced Soil Slopes Design and Construction Guidelines"**, and (b) **No. FHWA HI-95-038, "Geosynthetic Design and Construction Guidelines"**. Designers should refer to these publications for details.

1. **Reinforced Slope** - see reference (a) **FHWA-AS-96-071**.

- Step 1. Establish the geometry and loading - see **Exhibit 31-A**.
- Step 2. Determine the engineering properties of the insitu soils.
- Step 3. Determine the properties of the reinforced fill and the retained fill.
The following values for the backfill soil within the reinforced volume shall be used:
For sand backfill: $\phi = 30^\circ$, $\gamma = 105$ pcf, $c = 0$;
For crushed limerock backfill: $\phi = 34^\circ$, $\gamma = 115$ pcf, $c = 0$.
- Step 4. Evaluate design parameters for the reinforcement.
- Step 5. Check unreinforced slope stability.
- Step 6. Design reinforcement to provide a stable slope.
- Step 7. Check external stability.
- Step 8. Evaluate requirements for subsurface and surface water runoff control.

2. **Reinforced Foundation over Soft Soils** - see reference (b) **FHWA HI-95-038**.

- Step 1. Define embankment dimensions and loading conditions- see **Exhibit 31-B**.
- Step 2. Establish the soil profile and determine the engineering properties of the foundation soil.
- Step 3. Obtain engineering properties of embankment fill materials.

- Step 4. Establish minimum appropriate factors of safety and operational settlement criteria for the embankment.

The factor of safety for:

Bearing capacity: 1.5

Global(rotational) shear stability at the end of construction: 1.3

Internal shear stability, long-term: 1.5

Lateral spreading (sliding): 1.5

Settlement criteria: depend upon project requirements

- Step 5. Check bearing capacity, global stability (both short and long term), and lateral spreading stability.

- Step 6. Establish tolerable geosynthetic deformation requirements and calculate the required reinforcement modulus, J, based on wide width tensile strength, T_{Is} , tested in according to (ASTM D 4595). The geosynthetic reinforcement should be designed for strain compatibility with the weak insitu soil, with creep being a non-design factor.

Based on type of filled materials, the strains are recommended as follows:

Cohesionless soils: $\epsilon_{\text{geosynthetic}} = 5$ to 10%

Cohesive soils: $\epsilon_{\text{geosynthetic}} = 2\%$

Peat: $\epsilon_{\text{geosynthetic}} = 2$ to 10%

Reinforcement modulus is calculated as: $J = T_{Is} / \epsilon_{\text{geosynthetic}}$

- Step 7. Establish geosynthetic strength requirements in the geosynthetic's longitudinal direction.

- Step 8. Establish geosynthetic properties.

- Step 9. Estimate magnitude and rate of embankment settlement.

- Step 10. Establish construction sequence and procedures.

This includes stage construction, if needed, and all the stability analyses for each stage of constructions. The analysis should be based on the estimated strength of the subsoils at the end of the previous construction stage.

- Step 11. Establish construction observation requirements.

Instrumentations such as settlement plates, piezometers, and/or inclinometers should be designed to monitor the performance of the construction. The monitoring criteria, such as the maximum rate of piezometric and/or settlement change before the next stage of construction can proceed, etc., should also be established.

Exhibit 31-A Geosynthetic Reinforced Soil Slopes

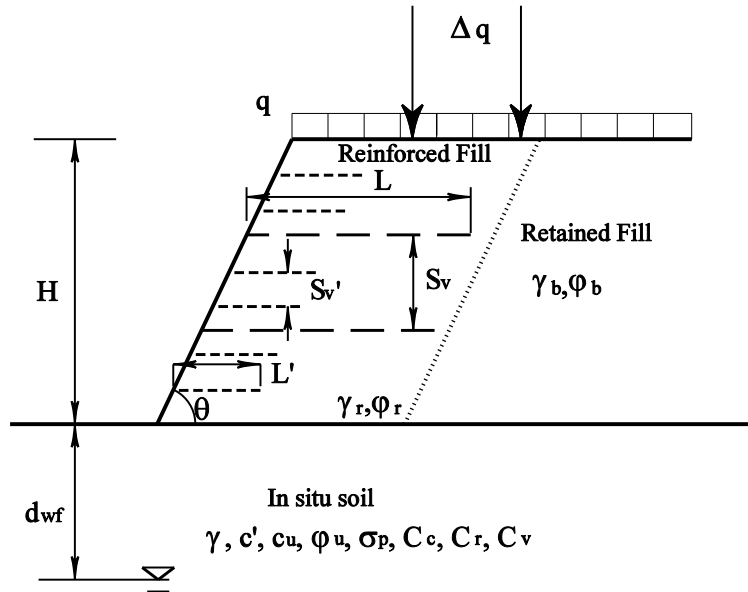

- Notations:**
- H = slope height
 - θ = slope angle
 - L = length of primary reinforcement
 - L' = length of secondary reinforcement, 4' minimum
 - S_v = vertical spacing between primary reinforcements, 4' maximum
 - S_v' = vertical spacing between secondary reinforcements, 1' maximum
 - q = surcharge load
 - Δq = temporary live load
 - d_{wf} = depth to groundwater table in foundation
 - $\gamma_r, \gamma_b, \& \gamma$ = unit weights of soils in reinforced, retained and foundation, respectively
 - $\phi_r, \phi_b, \& \phi$ = friction angles of soils in reinforced, retained and foundation, respectively
 - c', c_u = cohesion strength parameters of foundation soil

Exhibit 31-B Geosynthetic Reinforced Foundations Over Soft Soils

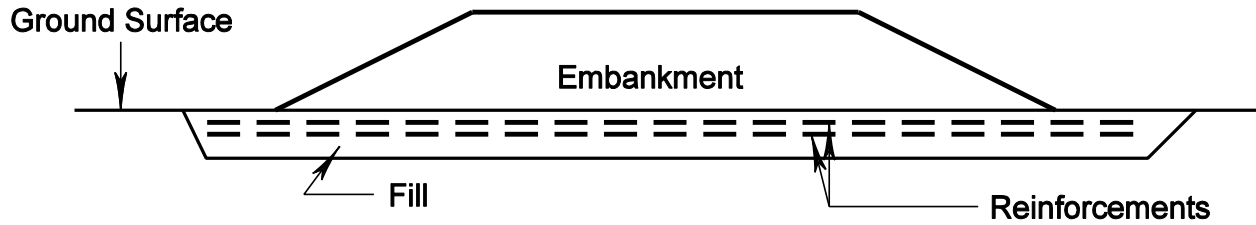

The minimum spacing between two reinforcements shall be 6 inches but not larger than 12 inches.

Chapter 32

Sound Barriers

32.1	General Requirements	32-1
32.2	Noise Study Report Addendum.....	32-3
32.3	Noise Abatement Criteria	32-4
32.4	Public Involvement	32-8
32.5	Final Noise Abatement Commitments	32-11
32.6	Structural Design.....	32-12
32.7	Geotechnical Investigation	32-14
32.8	Preparation of Control Drawings	32-15
32.9	Detail Drawings	32-16
Tables		
Table 32.1	Noise Abatement Criteria	32-7

THIS PAGE LEFT BLANK INTENTIONALLY

Chapter 32

Sound Barriers

32.1 General Requirements

Chapter 23 of the Code of Federal Regulations Part 772 (23 CFR 772) entitled “Procedures for Abatement of Highway Traffic Noise and Construction Noise” contains the federal regulations for the assessment of traffic noise impacts and abatement on federal aid projects. **Chapter 335.17 of the Florida Statutes** requires the use of **23 CFR 772** for traffic noise impact assessment on highway projects, regardless of funding. **Policy No. 000-360-005, Noise Abatement** contains the policy for abatement of traffic noise on Department projects. The requirements for assessing the noise impacts and abatement commitments are detailed in **Part 2, Chapter 17 of the Project Development and Environmental Manual (PD&E Manual) (Topic No. 650-000-001)**. The initial evaluation of noise impacts is made during the Project Development and Environmental (PD&E) phase of a project. Any preliminary commitments to provide reasonable and feasible noise abatement measures on a project are included in the Noise Study Report (NSR) and summarized in the environmental document. The environmental documents and any subsequent re-evaluations shall be reviewed to identify all preliminary noise abatement commitments.

Preliminary noise abatement commitments made during the PD&E phase are subject to change due to refinements during final design. Designers must consider final roadway grades and horizontal alignments, land use changes, as well as ground elevation at sound barrier locations. Noise abatement identified as reasonable and feasible during the PD&E phase need to be reassessed against the final roadway features. The typical PD&E phase assumptions are appropriate for reasonableness and feasibility decisions but the final design must utilize location specific data that reflects proposed vertical and horizontal locations of the travel lanes and sound barriers. The noise specialist shall provide the top of wall elevation for both minimum and desirable insertion reductions as described below. The designer shall coordinate with the noise specialist in the District Environmental Management Office to ensure proper analysis and public involvement occurs during final design.

If no noise abatement is identified in the environmental document or any subsequent

environmental re-evaluations, no further effort is required during final design. However, it may still be necessary to evaluate construction noise and vibration impacts and develop any special provisions to be included in the plans.

Upon review of the environmental documents the designer and the noise specialist should identify the noise receptors considered during the noise impact assessment performed in PD&E. Noise receptors resulting from development completed after the approval date of the environmental documents should not be considered as the Department is not responsible for providing noise abatement at these sites. A detailed design reassessment of the preliminary noise abatement commitments should be conducted for the following:

1. Locations of preliminary noise abatement commitments
2. Receptor sites where roadway geometric refinements are likely to change noise impacts

An addendum to the NSR prepared by the District Environmental Management Office during Final Design will document the final noise abatement commitments.

32.2 Noise Study Report Addendum

The primary effort related to the reassessment of preliminary noise abatement commitments during design is the preparation of an addendum to the NSR. The reassessment shall be based on the final roadway geometry and the proposed noise abatement design, including sound barrier type, location, dimensions and estimated costs. For consistency, the Final Design reassessment should be conducted using the latest version of the FHWA's Traffic Noise Model (TNM).

Noise abatement measures are considered when noise levels at a receptor(s) approach or exceed the noise abatement criteria or substantially exceed existing noise levels. The noise abatement criteria is listed in **Table 32.1**. Approaching the criteria means within 1 dBA of the noise abatement criteria. A predicted increase of 15 dBA or more is considered substantial. Noise abatement is generally only considered for Activity Categories 'A' and 'B'. Preliminary noise abatement commitments are documented in the original NSR.

32.3 Noise Abatement Criteria

The insertion loss is the level of noise reduction as a result of abatement. The desirable insertion loss is 10 dBA or more; however, the minimum insertion loss should be 5 dBA for an impacted receiver for abatement to be considered reasonable. If a sound barrier can meet the desired insertion loss for a cost of \$42,000 or less per benefited receiver site, the barrier is considered cost reasonable. The statewide average unit cost (per square foot) and the upper limit of the cost per benefited receiver to be used in determining cost reasonableness is established by the Environmental Management Office. As of the printing of this update the statewide average unit cost of sound barriers to be used in the calculation of the cost/benefited receiver is \$30.00/ft². The PD&E manual should be referenced for the latest unit cost update. Additional costs such as required additional right of way, special drainage features, special bridge support and special foundations associated with the installation of a sound barrier should be added to the unit cost if appropriate. If these special features increase the cost per benefited receiver above \$42,000, the decision whether or not to provide a barrier must be made in consultation with the District Environmental Management Office and FHWA. Any decision to eliminate a sound barrier from consideration based on the additional cost of special features will require clear demonstration that the need for such special features are associated only with the sound barrier and cannot be mitigated by other considerations.

If a minimum of 5 dBA insertion loss cannot be achieved at a receiver, that receiver is not benefited; therefore, it cannot be considered in the cost effective calculation to determine the reasonableness of that barrier. The noise specialist should thoroughly investigate the scenarios required to meet the desirable insertion loss of 10 dBA at \$42,000 or less per benefited receiver particularly where design changes or the consideration of special features require cost or abatement level reanalysis.

Section 32.6, Structural Design, provides structural design criteria and procedures, and horizontal clearance requirements. Under normal conditions sound barriers shall not exceed the following heights:

1. For sound barriers at the right of way line or outside the clear zone use a maximum height of 22 feet.
2. For sound barriers on bridge and wall structures use a maximum height of 8 feet.
3. For sound barriers at the shoulder point, mounted on embankments only, use a maximum height of 14 feet.

Use of barrier heights greater than these shall require a Design Variation. Justification for a variation should include, as a minimum, a description of site conditions requiring the increased height and a comparison to the standard height of both insertion loss and cost per benefited receiver.

The designer should provide analytical results to the Department project manager evaluating barrier heights necessary to achieve minimum, desired and optimum insertion loss. The optimum barrier height should be most cost effective in consideration of noise reduction benefits per unit cost of the barrier. An evaluation matrix is suited to this type of comparative analysis. The evaluation matrix should consider an appropriate range of sound barrier configurations (height, length and roadway offset) that provide the desirable insertion loss (10 dBA) per impacted receiver and the minimum insertion loss (5 dBA) per impacted receiver. The number of benefited receivers should be identified and the cost per benefited receiver calculated for each configuration evaluated. If a sound barrier configuration can provide the desirable insertion loss (10 dBA) at a reasonable cost (less than \$42,000 per benefited receiver), then it should be provided. If this is not achievable, the designer should select a sound barrier configuration that optimizes insertion loss per impacted receiver and cost per benefited receiver. The designer should always provide a recommendation with the evaluation. The designer should also coordinate with the District Structures Design Office to ensure that the sound barrier design meets appropriate structural design standards and that construction is feasible and achievable.

The height of the sound barrier is measured from the ground elevation to the top of the barrier. Tall sound barriers are seldom necessary at the top of roadway embankments or berms since the elevation of the embankment contributes to the effective height of the barrier. In addition, changes in the vertical grade of the top of the barrier should be gradual and abrupt changes in barrier heights should be avoided. Often natural ground elevations at the base of the barrier fluctuate, even in flat terrain. Therefore, the designer should provide plan details that make clear to the contractor the final barrier top elevations, foundation step locations and post spacing.

When an otherwise continuous barrier is broken resulting in a horizontal separation between the barriers, it is often necessary to overlap the barriers to reduce insertion loss degradation. Applications of this occur when the mainline barrier is located at the right of way line, but must be moved to the shoulder point at a bridge location. This may also occur at interchanges when transitioning from the mainline to a ramp. The overlap distance of sound barriers is generally equal to four times the separation; however, an analysis by the noise specialist is necessary to determine the optimum overlap. The need or effectiveness of a sound barrier in the infield area of an interchange should be reviewed as well during final design. The attenuation of ramp traffic may provide

adequate insertion loss when considering the intersecting roadway's noise contribution. Maintenance access and clear zone must be considered when selecting barrier termini details.

Other noise abatement techniques that may be considered to supplement or replace sound barrier walls are:

1. Traffic management measures (e.g., traffic control devices and signing for prohibition of certain type vehicles, time use restrictions for certain type vehicles, modified speed limits, and exclusive lane designations);
2. Alteration of horizontal and vertical alignments;
3. Acquisition of property rights for construction of sound barriers by donation, purchase or condemnation;
4. Acquisition of the balance of a noise-sensitive property from which there is a taking, if acquisition is less expensive than other methods;
5. Acquisition of right of way for landscaping adjacent to sound barriers and for buffer zones.

Table 32.1 Noise Abatement Criteria
 [Hourly A-Weighted Sound Level-decibels (dBA)]

Activity Category	Abatement Level (in L_{Aeq})		Description of Activity Category
	FHWA	FDOT	
A	57	56 (Exterior)	Lands on which serenity and quiet are of extraordinary significance and serve an important public need and where the preservation of those qualities is essential if the area is to continue to serve its intended purpose.
B	67	66 (Exterior)	Picnic areas, recreation areas, playgrounds, active sports areas, parks, residences, motels, hotels, schools, churches, libraries, RV parks, day care centers and hospitals.
C	72	71 (Exterior)	Developed lands, properties, or activities not included in Categories A and B above.
D			Undeveloped lands.
E	52	51 (Interior)	Residences, motels, hotels, public meeting rooms, schools, churches, libraries, hospitals, and auditoriums.

32.4 Public Involvement

The identification and design of noise abatement measures during the project design phase will require additional public involvement efforts and will be especially important in the establishment of sound barrier design features such as barrier texture. Public coordination is often necessary to finalize barrier locations, heights and aesthetic features, especially if there are substantial changes to prior commitments. These changes may be the result of any of the considerations noted in **Section 17-4.6.1** of the **PD&E Manual**. Coordination with the District Public Involvement or Community Liaison Coordinator in obtaining additional input during the final design of the sound barrier is required.

When a barrier is warranted, a written survey shall be conducted to establish whether a numerical majority of the benefited receivers are in favor of the construction of the barrier. If they are not in favor, the Department may choose not to build it. If agreement cannot be reached by a neighborhood on the use of sound barriers, the decision to provide them or not will rest solely with the Department. This survey will usually be conducted during the design phase although it is possible that a survey could be conducted during the PD&E phase. Survey issues should be coordinated with the District Environmental Management Office.

Sound barriers located on arterial roadways can potentially impact access. The ability to construct an effective sound barrier(s) can depend on an individual property owner's willingness to sign a right of way indenture allowing access to be cut off or modified. For these type projects it is general practice to obtain a written statement from each affected property owner demonstrating support for the sound barrier. If an adjacent property owner(s) declines to sign the indenture the noise specialist shall re-evaluate the effectiveness of noise abatement on the project segment considering alternate sound barrier layouts. If insertion loss criteria cannot be met, the noise specialist shall document in the NSR Addendum that the barrier is not feasible.

F.S. 479.25 (as amended by **HB 273**) "Outdoor Advertising", allows permitted, conforming, lawfully erected outdoor advertising signs to be increased in height if visibility is blocked due to construction of "noise attenuation" barriers. In addition, the amended statute requires the Department to notify a local government or local jurisdiction before erecting a sound barrier that will block a lawfully permitted sign. The local government or local jurisdiction is then required to notify the Department if increasing the height of an outdoor advertising sign will violate any local ordinance or land development regulation of the local government. When the notice has been received from the local government or local jurisdiction and prior to erection of the

sound barrier, the Department shall:

a.) Inform all the benefited receivers, as part of the written survey, that:

1. Erection of a specific sound barrier may block the visibility of an existing outdoor advertising sign;
2. The local government or local jurisdiction may restrict or prohibit increasing the height of the existing outdoor advertising sign to make it visible over the barrier;
3. If a majority of the benefited receivers vote for construction of the sound barrier, the local government or local jurisdiction will be required to:
 - a. Allow an increase in the height of the sign in violation of a local ordinance or land development regulation;
 - b. Allow the sign to be relocated or reconstructed at another location if the sign owner agrees; or
 - c. Pay the fair market value of the sign and its associated interest in the real property.

The amended statute also requires the Department to hold a public hearing within the boundaries of the affected local government or local jurisdiction to receive input on proposed sound barriers that may conflict with the local ordinances or land development regulations and to suggest or consider alternatives or modifications to the proposed sound barrier to alleviate or minimize the conflict with the local ordinances or land development regulations or minimize any costs associated with relocating, reconstructing, or paying for the affected outdoor advertising sign. Alternatives or modifications to barriers that will reduce the insertion loss below the minimum of 5 dBA will not be considered unless the results of the survey indicate that a numerical majority of the benefited receivers do not favor construction of the sound barrier.

The written survey materials shall inform the affected property owners of the location, date, and time of the public hearing. The public hearing may be held concurrently with other public hearings scheduled for the project. A general notice of the public hearing shall also be published in a newspaper in accordance with the notice provisions of **F.S. 335.02(1)** and containing the same information provided in the written survey materials. The notice shall not be placed in that portion of a newspaper in which legal notices or classified advertisements appear. Please refer to **Part 1, Chapter 11 Public Involvement, of the PD&E Manual** for additional details about meeting notification requirements.

The Department shall not construct a sound barrier that screens or blocks the visibility of an outdoor advertising sign until after the public hearing is held and the numerical majority of the benefited receivers has approved the construction of the barrier. If the construction of the sound barrier is approved the department shall notify the local governments or local jurisdictions. The local governments or local jurisdictions shall then exercise one of the options in paragraph 3 above.

32.5 Final Noise Abatement Commitments

During the final design phase, the noise abatement locations, sound barrier types, lengths and heights will be determined. The final noise abatement commitments must be documented in the environmental reevaluation and the noise study report addendum prior to construction advertisement. The required data collection, analysis and documentation detailed in **Part 2, Chapter 17 of the Project Development and Environmental Manual** will be documented in the NSR addendum. It should also contain a description of the methodology for selecting final sound barrier dimensions including any evaluation matrix(s) used.

A copy of the NSR addendum, a summary of proposed sound barrier and a summary of the public involvement regarding noise abatement that took place during the design effort will be provided to the District Environmental Management Office. The environmental management staff will ensure that the final noise abatement commitments are reflected in the reevaluation of the environmental document and will obtain concurrence from FHWA.

32.6 Structural Design

Designers shall specify the Department's Design Standard for Sound Barriers and any applicable sound barrier panels or systems listed on the QPL (see **Section 32.8**).

Except as specified below, **AASHTO's Guide Specifications for Structural Design of Sound Barriers** shall be used for the structural design; however, the designer shall also refer to the **Department Specifications, Section 534**, the **5200 Series** of the **Design Standards**, and the Structures Design Office's **Structures Manual, Volume 6, Chapter 2, Sound Barrier Evaluation Criteria** for specifications and general design requirements, the **Structures Manual, Volume 3** for guidance in the preparation of the drawings and the **Structures Detailing Manual** for conformance in detailing.

All sound barrier in the State of Florida shall be designed for a minimum wind velocity of 110 mph. If the sound barriers are not located on other structures, the wind pressures shown in **Table 1-2.1.2.C (Exposure B2)** of the referenced **AASHTO Guide Specifications** shall be used. If the noise barriers are located on bridge structures, retaining walls, or traffic barriers, the wind pressures shown in **Table 1-2.1.2.D (Exposure C)** of the referenced **AASHTO Guide Specifications** shall be used. For sound barriers located on embankments and structures, the height zone shall be determined by using the elevation of adjoining ground as being the approximate elevation of the original ground surface prior to embankment construction.

For panels, the maximum deflection due to service wind load shall not exceed the lesser of $1/180^{\text{th}}$ of the post spacing or $1\frac{1}{2}$ inch (deflection measured relative to posts). For posts or top of barrier, the maximum deflection due to service wind load shall not exceed the lesser of $1/50^{\text{th}}$ of the barrier height or 5 inches for sound barriers on deep foundations or 3 inches for sound barriers founded on shallow foundations, and measured from the following:

1. Sound barriers on deep foundations: the deflection shall be measured relative to the point of fixity in the soil. The lateral displacement at the base of the barrier shall not exceed 1 inch.
2. Sound barriers on shallow foundations: the deflection shall be measured relative to the base of the barrier system.

More restrictive panel and barrier deflection limits may be required based on the specific barrier system utilized. Design auger cast piles in accordance with the **Soils and Foundations Handbook, Appendix B**. See **5200 Series** of the **Design Standards** for standard auger cast pile foundation sizes and depths. Increase auger cast pile foundation diameters to 42 inches when depths exceed 30 feet.

If steel pile foundation is considered suitable for the project, determine the environmental classification for corrosion rate evaluation.

Unless approved by the Department, the maximum post spacing for sound barrier panels shall not exceed 20'-0".

On flush shoulder roadways, sound barriers shall be located outside the clear zone unless shielded, and as close as practical to the right of way line. On urban curbed roadways, sound barriers shall be a minimum of 4 feet back of the face of curb. However, additional setbacks may be required to meet minimum sidewalk requirements. Sound barriers may be combined with traffic railings on a common foundation if the combination meets the crash test requirements of NCHRP 350 Test Level 4 criteria.

Besides the structural integrity of the sound barrier, the structural engineer should also be concerned with aesthetics, maintainability, constructability, cost and durability.

Sound barriers should not be located on bridge structures where feasible alternative locations exist. Sound barriers on bridge structures cause a disproportionate increase in bridge cost because of strengthening of the deck overhang and exterior girder. In addition, sound barriers on bridges interfere with normal maintenance inspection access and detract from the aesthetic quality of the structure. Where feasible alternative locations do not exist and sound barriers must be located on bridges or retaining walls, they shall not be taller than 8 ft. unless specifically approved in writing by the State Structures Design Engineer. See ***Design Standards, Index Nos. 5210 and 5212*** for acceptable crash tested 8 ft. bridge and retaining wall mounted sound barriers.

On bridges or on the top of retaining walls, where the sound barrier does not meet crash test requirements of NCHRP 350, Test Level 4, sound barriers shall be placed a minimum of 5 feet beyond the gutter line of a FDOT approved standard bridge railing, and the sound barrier shall be limited to 8 feet in height unless authorized by the State Structures Design Engineer due to reasons stated in the previous paragraph. Sound barriers may be combined with the traffic railing as long as the structural system meets the crash test requirements of NCHRP 350, Test Level 4 criteria.

32.7 Geotechnical Investigation

Once the barrier location, alignments, height and minimum thickness are determined, the soil exploration should be undertaken. The geotechnical engineer should follow the Department's ***Soils and Foundations Handbook*** for exploration.

32.8 Preparation of Control Drawings

The initial set of drawings to be prepared by the EOR is referred to as Control Drawings. By preparation of these drawings, the EOR shall provide all control parameters such as alignments, limits, notes, etc., and shall provide all the information which is common to all wall types including but not necessarily limited to:

1. Barrier alignments (horizontal and vertical)
2. Barrier limits (beginning and ending)
3. Location of all existing utilities (overhead and/or underground in the vicinity of the proposed barrier)
4. Location of fire-access openings
5. Location of drainage openings
6. Sound barrier graphics details
7. General Notes
8. "Report of Core Borings" (Soil Information Data)
9. Quantities (barrier area as described below for payment purposes only; the itemized quantities such as concrete volume, etc., shall be provided in the specific drawings)
10. All other information that may be construed to be of general nature
11. NOTE: The barrier area for bidding purposes shall be the area bounded by the barrier limits (beginning and ending), the top of the barrier, and the bottom of the lowest panel between posts. This is the vertical surface area that can be seen on an elevation view plus the portion of the lowest panel which is buried.

32.9 Detail Drawings

The EOR shall prepare Detail Drawings showing the specific details required for the implementation of the selected Design Standard barrier type. All barrier components such as: foundations, posts, panels, etc. shall be fully detailed for construction. All sound barriers shall include the FDOT Design Standard (non-proprietary) design. The Structures FDOT CADD Menu cell tables shall be included in the plans depicting which QPL proprietary barrier designs are compliant with project specific requirements. These drawings shall provide the specific information as shown in the applicable drawings (see the ***Design Standards***).

Manufacturers of proprietary sound barrier products may have their products evaluated by the Department in accordance with the FDOT Sound Barrier Acceptance Criteria. Approved products will be listed on the Qualified Products List (QPL). The designer or project manager shall establish the project requirements for sound barriers and include commitments made during the PD&E phase or during the design phase public involvement. Project requirements may include color, textures, graphics, post spacing (10 feet or 20 feet), absorptive vs. reflective surface, flush vs. recessed panels, etc. The project requirements shall be listed in the plans.

The designer should refer to options outlined in the ***Structures Detailing Manual, Chapter 15***.

In addition to the Department's Design Standard for concrete sound barriers, the plans shall list proprietary sound barrier products that meet the project requirements and are listed in the QPL. Specify the environmental classification in the plans (for corrosion rate evaluation), if steel pilings can be considered for the project. Characteristics and details of each approved proprietary sound barrier product included in the QPL are listed in the Specification Office's web page.

Chapter 33

Reinforced Concrete Box and Three-Sided Culverts

33.1	General	33-1
33.2	Structure Type Selection	33-3
33.2.1	Precast Concrete Culverts	33-4
33.2.2	Concrete Box Culverts	33-5
33.2.3	Three-Sided Concrete Culverts.....	33-5
33.2.3.1	Precast Arch and Arch-Topped Units	33-6
33.2.3.2	Precast Frame Units	33-7
33.3	Foundation Design	33-8
33.3.1	Rock Foundations	33-8
33.3.2	Earth or Granular Soil Foundations.....	33-8
33.3.3	Three-sided Culvert Foundation Design	33-9
33.4	Wingwalls	33-10
33.5	Headwalls/Edge Beams	33-11
33.6	Cutoff Walls	33-12
33.7	Aprons	33-13
33.8	Subbase Drainage	33-14
33.9	Joint Waterproofing	33-15
33.10	Traffic Railings	33-16
33.11	Design Requirements for Concrete Culverts.....	33-18
33.12	Design Details	33-18

33.13 Computer Design and Analysis Programs33-20
33.14 Design and Shop Drawing Approvals33-21

Tables

Table 33.1 Bar Identification Schedule33-19

Chapter 33

Reinforced Concrete Box and Three-Sided Culverts

33.1 General

This chapter presents the minimum requirements for selection and designing reinforced concrete culverts. The Department recognizes two types of reinforced concrete culverts other than reinforced concrete pipe. These are concrete box culverts (four-sided) and three-sided concrete culverts. Both of these culvert types are classified as Category 1 structures in accordance with **Chapter 26**. It is not possible to provide prescriptive requirements for all conditions so guidance provided in this chapter is for typical designs. Each location will usually have some unique character (floods, scour, surroundings, salt water, historic character, etc.). Unique environments need to be thoroughly evaluated and all environmental requirements satisfied.

Structures with a span greater than or equal to 20 feet are technically not culverts, however, for simplicity all structures in this chapter are referred to as culverts. The procedures for designing culverts and bridges maybe different due to the differing risks associated with the size of the structure. Safety and economic issues and technical complexity can vary significantly with differing site conditions which will dictate the size and type of the most appropriate structural solution. Bridge-size culverts (≥ 20 feet span) warrant more complex hydraulic and foundation treatments, which require the expertise of a bridge engineer. Simpler, less complex and smaller culvert-size structures (≤ 12 feet span) may be designed with minimal oversight of a bridge engineer. Any questions on who should design a specific-size structure should be discussed with the District Structures Engineer.

The procedure for the hydraulic analysis of culverts differs based on whether the culvert is located at a riverine or tidal crossing. Refer to **Chapter 4** of the **Drainage Manual** for the appropriate hydraulic analysis and documentation requirements.

Definitions of terms used in this chapter include the following:

Bridge-size culverts are defined as any structure, whether of single-span or multiple-span construction, with an interior width greater than or equal to 20 feet when measured horizontally along the centerline of the roadway from face-to-face (inside) of the extreme abutments or sidewalls.

Culverts are defined as any structure, whether of single-span or multiple-span construction, with an interior width less than 20 feet when measured horizontally along the centerline of the roadway from face-to-face (inside) of the extreme abutments or sidewalls.

Concrete box culverts (four-sided) typically have rectangular cross sections. An arch or arch-topped culvert is considered a box culvert if the “sidewalls” are built monolithic with the bottom (invert) slab. Two-piece (four-sided) box culverts are permitted with a simply supported top slab, which is keyed into a monolithic three-sided bottom section. Concrete box culverts are typically used where the streambed is earth or granular soil and rock is not close enough to the streambed to directly support the structure.

Three-sided concrete culverts may be rectangular in shape or a frame with varying wall and/or slab thickness or an arched or arch-topped structure. These structures have separate foundations with spread footings supported by earth, rock or piles. The largest culverts are typically not boxes; rather they are frames or arches. Use of three-sided concrete culverts where rock is not at or near the streambed requires pile support for the footings or some other form of positive scour protection. Three-sided concrete culverts on spread footings may be used for railroads, wildlife crossings, bicycle/pedestrian/equestrian/golf cart paths, and other uses that do not convey water or have scour vulnerability.

Clear span is the perpendicular distance between the inside face of the sidewalls. The maximum clear span recommended for a concrete box culvert is 24 feet.

Design span for non-skewed culverts is the perpendicular distance between the centerline of the sidewalls. For culvert units with skewed ends, the design span of end sections is the distance between the centerlines of the sidewalls measured parallel to the skewed end.

33.2 Structure Type Selection

The designer must determine the most appropriate type of short-span structure. The basic choices are a corrugated metal structure, concrete box culvert, concrete frame or arch, and a short-span bridge. While the site conditions are the primary deciding factor for structure selection, aesthetics, constructability and economics are also very important.

Proper selection of the feasible structure alternatives is based on site and project-specific parameters, including but not limited to:

1. Vertical and horizontal clearance requirements.
2. Available “beam” (top slab) depth.
3. Maintenance and protection of traffic requirements (e.g., phase construction).
4. Construction constraints (e.g., water diversion requirements).
5. Foundation requirements.
6. Environmental concerns (e.g., natural streambed).
7. Desired aesthetic treatments (e.g., arch appearance).
8. Geometric limitations (e.g., skew angle, R.O.W. restrictions, utilities, etc.).

Concrete culverts are usually more expensive in initial cost than corrugated metal structures. However, concrete culverts are the preferred alternative when considering suitability to the site and life-cycle cost estimates. The advantages of concrete culverts are superior durability for most environmental conditions, greater resistance to corrosion and damage due to debris, greater hydraulic efficiency, and typically longer service life (i.e., potentially lower life-cycle costs).

At sites with limited headroom, concrete culverts are generally the least expensive option. Smaller corrugated metal structures typically require a minimum height of soil cover of 2 feet and for some structures the soil cover increases to 4 feet or more depending on size and shape. Concrete culverts, frames, and arches can have the least amount of cover by placing a minimum of 3 inches of asphalt pavement directly on the top slab. Corrugated metal structures will also typically require taller structures than concrete box culverts, to provide adequate waterway area below design high water due to their arched shapes. If a corrugated metal structure is a viable option, an engineering evaluation and cost analysis should be performed in consultation with the District Drainage Engineer.

Single-cell and multi-cell concrete box culverts with barrel spans less than 15 feet, are often the most cost effective structural solution where debris collection and aesthetics are not a major concern. Three-sided culverts may be appropriate for single spans exceeding 20 feet where scour is not a concern.

Before a final determination is made to use a large concrete culvert, the use of a short-span bridge should be investigated. Possible advantages of a bridge may be minimized work in the stream, speed of erection, minimized interference with the existing structure foundation, and easier phased construction. For procedural steps on planning short-span bridges, see **Chapter 26**.

Information on corrugated metal structures (steel and aluminum) is available in the **Drainage Manual**. When corrugated metal structures are more cost efficient and they may be considered for off-system routes where there will be no major risk of corrosion or by utilizing concrete pedestal walls to ensure there is infrequent water contact with the metal portion of the structure.

33.2.1 Precast Concrete Culverts

Precasting permits efficient mass production of concrete units. The advantages often offset the cost of handling and transporting the units to the site. Precast units are often limited to certain sizes and skews due to forms, transportation and handling concerns. Skewed units may need more reinforcement and thicker slabs and/or sidewalls. The use of skewed units will increase the cost of the culvert due to increased fabrication costs.

Skewed precast culvert units should be avoided, if practical. Precast concrete culverts should have square ends, whenever possible. Skewed end units are sometimes required to satisfy right of way constraints and/or phased construction requirements for skewed alignments. In the event they are necessary, skewed precast culvert units shall be designed for the skewed-end design span. Large skews may lead to units that require additional reinforcement and/or greater wall and slab thickness than typical square units with the same clear opening. Manufacturers should be contacted for information on maximum skews available when only precast culverts are shown in the contract plans.

Precast culverts may occasionally need to be placed on moderate or steep grades. No maximum slope is recommended for box culverts because of the need to match the slope of the streambed. Three-sided box culverts and the frames and arches should be limited to a maximum slope of 2%. If matching a steeper slope is necessary, the ends of the precast units should be beveled to create vertical joints and the footings may be stepped and/or the

length of the sidewall varied. Precast manufacturers should be contacted for the maximum grade that can be fabricated if the designer is proposing a grade larger than 2%.

When two or more single-cell, precast concrete culverts are placed side-by-side, it is usually not possible to place the walls of adjacent cells tightly together. The standard detail is to provide a 2 to 4 inch gap between the walls of adjacent cells. This gap should be filled with Class I (non-structural) concrete, non-excavatable flowable fill or non-shrink grout.

All manufacturers must have approved precast drainage product facilities in accordance with **Section 6.3** the **Materials Manual**.

33.2.2 Concrete Box Culverts

When a concrete box culvert is selected as the appropriate structure for the site, a cast-in-place culvert must be designed and detailed in the contract plans. A precast concrete box culvert alternative is usually permitted during construction unless specifically excluded in the contract plans. Speed of erection, maintenance of traffic, stream diversion problems, and site constraints can be minimized when the Contractor utilizes precast culverts.

33.2.3 Three-Sided Concrete Culverts

There are various types of proprietary, precast concrete frames, arch topped units, and arches available. These units are typically used when larger culverts (spans ≥ 20 feet) are required. They can be considered when scour protection can be adequately provided and/or aesthetics are a consideration. They may be placed on spread footings with an invert slab, footings on rock, or pile-supported footings. The advantages of the precast concrete arches and frames are the same as for the precast concrete box culverts, except that longer spans (up to 48 feet) are possible.

When a three-sided concrete culvert is selected as the appropriate structure for the site a precast culvert should be the preferred option. A cast-in-place reinforced concrete foundation and the channel lining must be designed and detailed in the contract plans. The final design of the precast three-sided culvert structure and any necessary foundation modifications should be completed by the Contractor's Engineer of Record (usually the manufacturer).

Sizes of precast units that are common to more than one manufacturer should be selected. Dimensions of the sidewalls and top slab, reinforcement size and spacing should not be

shown on the plans, unless necessary. If sidewall or top slab dimensions are dictated by site conditions, show only the affected dimensions and indicate if they are minimums, maximums, or specifically required dimensions. The assumed top slab dimension used to determine fill limits should be shown in the contract plans.

A note in the contract plans shall require the Contractor to provide all design details not included in the contract plans. This method should result in the most economical culvert design.

33.2.3.1 Precast Arch and Arch-Topped Units

The following guidelines should be considered when selecting a precast arch or arch-topped culvert:

1. Aesthetics concerns may make the use of arch-shaped units desirable. The use of arch-shaped facade panels is not recommended, especially for hydraulic openings due to snagging of debris.
2. The amount of skew that can be fabricated varies. Some manufacturers prefer to produce only 0° skew units. The maximum skew at which a precast unit should be fabricated is 45°. The culvert orientation to the centerline of the highway may be at a skew greater than 45°.
3. An arch unit is preferable for a grade separation for highway vehicles or railroads, when a dry conveyance environment is necessary. The arch shape eliminates any ponding problems above the culvert without special fabrication or field adjustments that would be required for flat-topped culverts.
4. Arch units are preferred in cases where fills above the precast units exceed 20 feet.
5. Precast arch-topped units are currently available in spans up to 48 feet.
6. Arched units have been used as liners for old masonry or concrete arches in other States. After the construction of a pedestal wall at the base, the units are slid into place. The void between the existing arch and the liner is filled with grout installed through fittings cast into the liner units.
7. Large arch units may be shipped in two pieces and assembled on site. Three-piece units are not permitted.

33.2.3.2 Precast Frame Units

The following guidelines should be considered when selecting a precast frame (rectangular) culvert:

1. Many of precast frame-type units can be fabricated with skew angles up to 45°. This characteristic is useful when phased construction is proposed. When used for phased construction with shallow highway pavements, no temporary shoring is needed at the phase construction joint to support the fill or pavement.
2. Frame units provide a simpler traffic railing/headwall connection than arch-topped units.
3. Frame units provide a hydraulic opening greater than arches of equivalent clear span when flowing full.
4. Precast frame units can be fabricated by some manufacturers with any increment of span length up to 40 feet, although typical span length increments are 2 feet.
5. Maximum rise of the units is normally limited to 10 feet due to shipping and handling considerations. If a larger rise is necessary, the designer should investigate the need for a pedestal wall.

33.3 Foundation Design

All structures discussed in this chapter, regardless of span and height of fill, are considered buried structures in regard to foundation design. Thus, there is no requirement for seismic analysis. This may change in the future as more research is completed.

For culverts with spans greater than or equal to 20 feet, foundation recommendations are provided to the designer in the Bridge Geotechnical Report (Phase I) and included in the Bridge Development Report (BDR). Foundation design parameters for culverts with spans less than 20 feet are provided by the District Geotechnical Engineer or the Department's Geotechnical Engineering consultant.

The District Geotechnical Engineer or the District Structures Design Office should be consulted to determine the proper foundation treatment.

33.3.1 Rock Foundations

In the unusual case where sound rock is at or near the surface of a streambed, an invert slab is not required and a three-sided culvert would generally be the appropriate structure selected. Concrete footings are either keyed or doweled into rock based on consultation with an Engineering Geologist and the District Geotechnical Engineer.

If the elevation of the rock surface varies by 2 feet or less, the wall height should be constant and the footing height varied. If the variation in rock surface elevation exceeds 2 feet, the height of the culvert wall may be varied at a construction joint or at a precast segment joint. In some cases, it may be necessary to use walls of unequal heights in the same segment, but this should generally be avoided.

33.3.2 Earth or Granular Soil Foundations

In most cases a concrete culvert will not be founded on rock, so a box culvert (four-sided) with an integral invert slab should be the preferred foundation treatment. However, in areas of compact soil and low stream velocities, three-sided concrete culverts may be used if they have positive scour protection such as piles or channel lining with concrete-filled mattresses, gabions or riprap rubble, and spread footings founded below the calculated scour depth. Three-sided concrete culverts located in stream beds, with spans equal to or exceeding 20 feet, must have pile supported footings when the structure is not founded on sound rock.

To avoid differential settlement, concrete box culverts should never be founded partially on rock and partially on earth. If rock is encountered in a limited area, it should be removed to a minimum depth of 12 inches below the bottom of the bottom slab and backfilled with either select granular material or crushed stone. Concrete culverts are rigid frames and do not perform well when subjected to significant differential settlement due to a redistribution of moments. All concrete box culverts located in streambeds should have a designed undercut and backfill. The standard undercut and backfill by **Section 125** of the **Specifications for Road and Bridge Construction** is 4 feet. The District Geotechnical Engineer should be consulted to determine the depth of the undercut and type of backfill material required for sites not located in streambeds or where significant settlement is anticipated.

A concrete box culvert can be considered if settlement is expected and the foundation material is fairly uniform. However, the culvert should be designed to accommodate additional dead load due to subsequent wearing surface(s) which may be needed to accommodate the settlement of the box. Precast culverts may require mechanical connections between units when significant differential settlement is anticipated. **Design Standards Index No. 291** provides criteria for cast-in-place bond beams to satisfy this requirement when joint openings are expected to exceed 1/8 inch. A Geotechnical Engineer should provide the anticipated differential settlement, which should be included in the contract plans.

If the foundation material is extremely poor and it is desirable to limit settlement, the problem should be referred to the District Geotechnical Engineer to determine the best course of action. A typical remedy might be removal of unsuitable or unstable material and replacement with suitable material.

33.3.3 Three-sided Culvert Foundation Design

When a three-sided structure is selected for a site, a cast-in-place footing design must be included in the contract plans. There are several types of culverts that may meet the project specifications. The designer must decide which specific type of unit would best fit that particular application and use those vertical and horizontal reactions for design of the foundations. The designer may contact known fabricators for design reactions. If no specific type of unit is determined as most appropriate, a conservative estimate of the design reactions for all types should be used and the reactions included in the contract plans.

33.4 Wingwalls

A wingwall is a retaining wall placed adjacent to a culvert to retain fill and to a lesser extent direct water. Wingwalls are preferably cast-in-place, but precast wingwalls may be considered on a project by project basis. Wingwalls are generally designed as cantilevered retaining walls however precast counterfort and binwalls may also be considered. Cast-in-place wingwall designs are provided by the Department's standard box culvert computer program.

Wingwall alignment is highly dependent on site conditions and should be evaluated on a case-by-case basis. The angle(s) of the wall(s) on the upstream end should direct the water into the culvert. It is also desirable to have the top of the wall elevation above the design high water elevation to prevent overtopping of the wall.

When precast wingwalls are permitted the designer should be aware of potential conflicts with ROW limits and utilities. The footprint of the footing and excavation, especially for bin type walls, can be extensive. Notes should be placed on the plans alerting the Contractor to these requirements when they exist. Due to skew and/or grade differences between the cast-in-place or precast culvert units and precast wingwalls it is necessary to provide a cast-in-place closure pour between the culvert end unit and precast wingwalls. A closure pour is not required if cast-in-place wingwalls are used.

When precast wingwalls are permitted the, cost shall be included in the cost of the culvert barrel. No separate item is required but the estimated concrete and reinforcing steel quantities for a cast-in-place design should be included in the contract plans.

33.5 Headwalls/Edge Beams

Headwalls are normally used on all culverts. In deep fills a headwall helps retain the embankment. In shallow fills the headwall may retain the subbase and/or highway pavement and provide the anchorage area for the railing system.

Headwalls should be cast-in-place and attached to precast culvert end segments in accordance with ***Design Standards Index No. 291***. Headwalls one foot or less in height with no railing attachment for single barrel precast culverts may be precast. If a curb must be placed on a culvert without a sidewalk, the headwall must be cast-in-place to allow for the tie-in of the curb's anchor bar, unless the curb is also cast at the precast facility.

The typical maximum height of headwalls is 3 feet. Greater heights are attainable but are only used in special cases. Headwall heights greater than 2 feet above the top slab require an independent transverse analysis, which is not provided by the FDOT box culvert program.

Concrete culverts with skewed ends may require additional stiffening of the top and bottom slabs by what is most commonly called an "edge beam". An edge beam is similar to a headwall or cutoff wall. The headwall may be used to anchor guardrail posts and traffic railings or retain earth fill, as well as stiffening the top slab of culverts that lose their rigid frame action as a result of having a skewed end.

When additional strength is required in the concrete edge beam, the following criteria shall be used:

1. If there is a 1-on-2 slope to the edge beam, it will be more economical to increase the depth of the edge beam in order to meet the required design.
2. When the edge beam is at shoulder elevation (anchoring guard rail and traffic railing), the edge beam height should be maintained and the width of the edge beam should be increased.

33.6 Cutoff Walls

A cutoff wall is required in all culverts with invert slabs to prevent water from undermining the culvert. The cutoff wall should be a minimum 24 inches below the bottom of the invert slab or to the top of sound rock if the rock is closer. For culverts founded on highly permeable soils or with significant hydraulic gradients, the designer should investigate the need for deeper cutoff walls. The cutoff wall may also act to stiffen the bottom slab for skewed box culverts.

Cutoff walls shall always be specified at each end of the barrel. When a concrete apron is provided, an additional cutoff wall shall also be shown at the end of the apron. For three-sided culverts, where the apron is made continuous with the barrel invert slab, the cutoff wall is only required at the end of the apron. The wingwall footings should have toe walls extending close to the bottom of the cutoff wall to prevent scour around the edges of the cutoff wall.

When a precast culvert is specified, the cutoff wall must cast-in-place and the cost should be included in the cost of the culvert barrel. No separate item is required but the estimated concrete and reinforcing steel quantities should be included in the contract plans.

33.7 Aprons

Box culverts can significantly increase the stream flow velocity because the concrete has a roughness coefficient significantly lower (i.e., smoother) than the streambed and banks. To dissipate this increase in energy and to prevent scour, a riprap rubble or other type of revetment apron may be required at the ends of some culverts. The District Drainage Engineer should be consulted to determine the appropriate apron requirements.

When a precast culvert is specified with a concrete apron, the apron must be cast-in-place and the cost should be included in the cost of the culvert barrel. No separate item is required but the estimated concrete and reinforcing steel quantities should be included in the contract plans.

33.8 Subbase Drainage

Draining surface and ground water away from the culvert through the subbase is almost as important as the conveyance of water through the culvert. All flat-topped or nonarched culverts should have a minimum longitudinal slope of approximately 1%, if possible, to drain the water that permeates through the pavement and subbase, away from the top of the culvert.

In situations where there is low fill (< 12 inches below the base coarse) **Design Standards Index No. 280** and **Index No.289** requires additional friable base or coarse aggregate material above the top and along the sides of the culvert to eliminate maintenance problems.

For deeper culverts, if a longitudinal slope is not possible, a 1% slope (wash), perpendicular to the centerline of the culvert, can be used. The wash can be from the centerline to each side or all in one direction. The wash can be formed into a cast-in-place culvert but is difficult to form on precast culverts. On precast culverts, the wash can be added after the culvert is in place by placing a shim course of asphalt or concrete.

An alternate solution in low fill conditions is to place a concrete pavement on top of the culvert. The minimum depth of concrete required is 6 inches. The concrete pavement is less susceptible to potholes than asphalt but is more costly and should have a longer service life. Contact the District Structures Design Engineer for guidance when considering the use of a concrete pavement section. Exclude precast units in the contract plans if there is concern about movement of units cracking the concrete pavement. Post-tensioning to connect precast units is not recommended.

33.9 Joint Waterproofing

Culverts will occasionally be used to allow the passage of things other than water, including but not limited to pedestrians, bicycles, trains, golf carts, wildlife, or farm animals. In cases where it is desirable to have a dry environment, a waterproof joint wrap should be used to cover the joints between precast culvert units or to cover the construction joints in cast-in-place culverts.

Even though a joint sealer is always placed between individual precast concrete culvert units and the units are pulled tightly together, water may seep through the joint. The minimum requirement for waterproofing these joints is to provide an external sealing band in accordance with **ASTM C 877**, centered on the joints, covering the top slab, and then extending down the sidewalls to the footing. The purpose of the waterproofing membrane is to restrict seepage of water or migration of backfill material through the joints in the culverts and it is not intended to protect the concrete.

The external sealing band is mandatory for precast three-sided culverts under **Section 407** of the **Specifications for Road and Bridge Construction** but will need to be included as a note in the contract plans when required for box culverts.

33.10 Traffic Railings

The Department has set policy that requires highway rail to meet NCHRP 350 Test Level-3 (TL-3) and requires bridge traffic railings to meet AASHTO LRFD TL-4 in most situations. See **Chapter 6** of the **Structures Design Guidelines** for more information. Concrete culverts may be highway-size or bridge-size by definition, and therefore, the guardrail requirements can theoretically vary by the span of the structure.

Any roadside protection placed at a culvert should be provided as highway guardrail or as bridge traffic railing. Highway guardrail should be used whenever it meets applicable safety standards since it is the most cost-efficient barrier type.

The anchorage/support of the guardrail or traffic railing is determined by the amount of fill over the top of the culvert. If there is more than a minimum of 4 feet of fill, a zero offset or greater (from the face of guardrail to shoulder break) and a 1:2 or flatter slope, use highway guardrail with standard length posts. When the embankment slopes exceed 1:2 for zero offset or there is less than 4 feet of fill, the preferred option for guard rail depends upon the amount of fill and the size of the culvert as described below:

1. Culverts with less than 5 feet outside widths (railing length) and less than 4 feet of fill should have the posts straddle the outside of the culvert. This assumes the use of standard post spacing of 6.25 feet and W-beam guard rail posts.
2. Culverts between 5 feet and 20 feet outside width (railing length) and less than 4 feet of fill may have posts attached to the top of the box or posts shortened. See **Design Standards Index No. 400** for guidance on the appropriate option.
3. Culverts with more than 20 feet outside widths (railing length) and less than 4 feet of fill should have guardrail anchored into the headwall or individual concrete pedestals. When the guardrail is anchored to a headwall or pedestal, either thrie-beam or a concrete traffic railing shall be used.

Concrete traffic railing is generally not recommended due to the short length of culverts unless it is being connected to barrier along the highway. The transition of the thrie-beam guardrail onto the traffic railing face will use up most of the length of traffic railing on the culvert. For example, 32" F-Shape traffic railing has a 16 feet transition from the end of traffic railing to the end of the thrie-beam terminal connector.

Designers should note that the location of the first and last posts is critical on culverts. Headwalls under guardrail should be a minimum of 18 inches wide and the base plate must

be located so that it is located at least 12 inches away from any construction joint or free end of the concrete headwall. Placement of base plates and bolts in the top slab should be avoided due to anchor embedment length problems and potential damage to the top of the culvert barrel.

33.11 Design Requirements for Concrete Culverts

Refer to the **Chapter 3** of the **Structures Design Guidelines** for design and analysis requirements.

33.12 Design Details

When a box concrete culvert is proposed for a site, the designer is required to provide a complete cast-in-place design for the contract plans. Standard details for concrete box culverts are provided in the **Design Standards Index No. 289** (LRFD). The contractor is usually permitted to substitute precast concrete box culverts for cast-in-place box culverts in accordance with **Section 410** of the **Specifications for Road and Bridge Construction**. The contractor may select a standard precast box culvert design in accordance with **Design Standards Index No. 292** or provide a custom design. Design and fabrication details for precast box culverts, including calculations for custom designs, must also comply with the requirements of **Design Standards Index No. 291** and be submitted to the Engineer of Record for approval.

When a three-sided concrete culvert is proposed for a site, the designer is required to provide either a complete cast-in-place design or a conceptual precast barrel design with a complete foundation and wingwall design, for the contract plans. The contractor is permitted to substitute precast three-sided culverts for cast-in-place three-sided culverts in accordance with **Section 407** of the **Specifications for Road and Bridge Construction**. Design and fabrication details for precast three-sided culverts, including calculations, must be submitted to the Engineer of Record for approval.

The bar designations in **Table 33.1** should be used for box culvert reinforcement:

Table 33.1 Bar Identification Schedule

BAR IDENTIFICATION SCHEDULE		
C.I.P (LRFD) Index No. 289	Precast (LRFD) Index No. 292	Description / Bar Location
105	As1	Top Corner Bars
106	As1	Bottom Corner Bars
102	As2	Top Slab, inside face transverse bars
103	As3	Bottom Slab, inside face transverse bars
101	As1/As7	Top Slab, outside face transverse bars
104	As1/As8	Bottom Slab, outside face transverse bars
108	As4	Exterior wall, inside face vertical bars
105/106	As1	Exterior wall, outside face vertical bars
107	-	Interior wall, vertical bars both faces
110/111	As9	Top Slab longitudinal bars (temperature reinf.)
109/112	As9	Bottom Slab longitudinal bars (temperature reinf.)
113/114		Exterior wall longitudinal bars (temperature reinf.)
115/ 116...		Interior wall longitudinal bars (temperature reinf.)
109	As6	Bottom Slab inside face longitudinal bars (design distribution reinforcement)
111	As5	Top Slab inside face longitudinal bars (design distribution reinforcement)

Additional reinforcing bars and designations should be added as required. No standardized bar designations are provided for three-sided culverts.

33.13 Computer Design and Analysis Programs

For LRFD designs the Department's ***LRFD Box Culvert Program*** (Mathcad) is available from the Structures Design Office website. This program analyses monolithic single of multi-barrel box culverts with prismatic members and integral bottom slabs only. The program requires input by the designer for all member thicknesses, material properties and reinforcing area utilizing a trial and error design methodology.

Other computer programs are available for design of reinforced concrete culverts such as BOXCAR and CANDE. Generally these other computer programs should only be used for preliminary designs or independent quality assurance checks. Designers should consult with the State Structures Design Office before using one of these other programs in lieu of the FDOT box culvert program.

33.14 Design and Shop Drawing Approvals

The Engineer of Record for the contract plans has design and shop drawing approval authority for precast concrete box and three-sided culverts. All calculations and shop drawings require a quality assurance review for general compliance of contract requirements and for suitability of the design for the given design conditions.

Standard precast concrete box culvert designs are available in ***Design Standards Index No. 292*** for a limited number of box culvert sizes. Modification of FDOT standard box culverts or design of special size box or three-sided culverts is delegated to Contractor's Engineer of Record in accordance with the ***Section 407*** and ***Section 410*** of the ***Specifications for Road and Bridge Construction***. The Contractor shall be responsible for providing all design computations and details for these units.

THIS PAGE INTENTIONALLY LEFT BLANK