

- LEGEND**
- Return Radius Point Or Flare Point
 - ▨ Buffer Areas
 - F.B. Line Frontage Boundary Line
 - W Driveway Width
 - Y Driveway Angle
 - C Corner Clearance
 - G Setback
 - R Outside Radius
 - U Inside Radius
 - D Distance Between Connections
 - F Flare

GENERAL NOTES

1. For definitions and descriptions of access connection "Categories" and access "Classifications" of highway segments, and for other detailed information on access to the State Highway System, refer to FDOT Rule Chapter 14-96, "State Highway Connection Permits Administrative Process" and Rule Chapter 14-97, "State Highway System Access Management Classification System And Standards."
 2. For this index the term 'turnout' applies to that portion of driveways or side roads adjoining the outer roadway. For this index the term 'connection' encompasses a driveway or side road and their appurtenant islands, separators, transition tapers, auxiliary lanes, travelway flares, drainage pipes and structures, crossovers, sidewalks, curb cut ramps, signing, pavement marking, required signalization, maintenance of traffic or other means of access to or from controlled access facilities. The turnout requirements set forth in this index do not provide complete intersection design, construction or maintenance requirements.
 3. The location, positioning, orientation, spacing and number of connections and median openings shall be in conformance with FDOT Rule Chapter 14-97.
 4. On Department construction projects all driveways not shown on the plans shall be reconstructed at their existing location in conformance to these standards, or, in conformance to permits issued during the construction project.
 5. Driveways shall have sufficient length and size for all vehicular queuing, stacking, maneuvering, standing and parking to be carried out completely beyond the right of way line. Except for vehicles stopping to enter the highway, the turnout areas and drives within the right of way shall be used only for moving vehicles entering or leaving the highway.
 6. Connections with expected daily traffic over 4000 vpd shall be constructed as intersecting side roads. The design requirement of this index and that of the local government will be used to select appropriate connection widths, radii and intersection design, subject to the approval of the Department. For connections with expected daily traffic less than 4000 vpd, the Department will determine if drop curbs or radius returns are required in accordance with existing or planned connections. Where radius returns apply, the design requirements of this index and that of the local government will be used to select appropriate connection widths, radii and intersection design, subject to the approval of the Department.
- For connections that are intended to daily accommodate either multi-unit vehicles or single unit vehicles exceeding 30' in length, returns with 50' radii shall be used, unless otherwise called for in the plans or otherwise stipulated by permit. Where large numbers of multi-unit vehicles will use the connection, the connection width and radii shall be increased and auxiliary lanes, tapers, lane flares, separators and/or islands constructed, as determined by the Department to be necessary for safe turning movements.
7. Any connection requiring or having a specified median opening with left turn storage and served directly by that opening shall have radial returns.
 8. Where a connection is intended to align with a connection across the highway, the through lanes shall align directly with the corresponding through lanes.
 9. For new connections and for connections on all new construction and reconstruction projects, pavement materials and thicknesses shall meet the requirements applicable to either that detailed for "Urban Flared Turnouts", or, that described in "Table 515-1" for connections with radial returns and/or auxiliary lanes.
 10. The responsibility for the cost of construction or alteration to an access connection shall be in accordance with FDOT Rule Chapter 14-96.

For Corner Clearance (C) Requirements see General Note 3.

For Additional Information Refer To FDOT Rules Chapters 14-96 And 14-97.

SKETCH ILLUSTRATING DEFINITIONS

ELEMENT DESCRIPTION	URBAN (CURB & GUTTER)			RURAL		
	1-20 Trips/Day or 1-5 Trips/Hour	21-600 Trips/Day or 6-60 Trips/Hour	601-4000 Trips/Day or 61-400 Trips/Hour	1-20 Trips/Day or 1-5 Trips/Hour	21-600 Trips/Day or 6-60 Trips/Hour	601-4000 Trips/Day or 61-400 Trips/Hour
CONNECTION WIDTH W	12' Min. 24' Max.	24' Min. 36' Max. ☆	24' Min. 36' Max. ☆	12' Min. 24' Max.	24' Min. 36' Max. ☆	24' Min. 36' Max. ☆
FLARE (Drop Curb) F	10' Min.	10' Min.	N/A	N/A	N/A	N/A
RETURNS (Radius) R & U	N/A	△	25' Min. 50' Std. 75' Max.	15' Min. 25' Std. 50' Max.	25' Min. 50' Std. 75' Max.	25' Min. 50' Std. (Or 3-Centered Curves)
ANGLE OF DRIVE Y		60°-90°	60°-90°		60°-90°	60°-90°
DIVISIONAL ISLAND (Throat Median)		4'-22' Wide	4'-22' Wide		4'-22' Wide	4'-22' Wide
SETBACK G	12' Min., All categories. See General Note No. 5.					
■ Side road intersection design, with possible auxiliary lanes and channelization, may be necessary. Intersection design, with possible auxiliary lanes and channelization, should be considered for connections with more than 4000 trips/days. □ "2-Way" refers to one "in" movement and one "out" movement i.e., not exclusive left or right turn lanes on the connection. ☆ When more than 2 lanes in the turnout connection are required, the 36' max. width may be increased to relieve interference between entering and exiting traffic which adversely affects traffic flow. These cases require documented site specific study and design. △ Small radii may be used in lieu of flares as approved by the Department. DESIGN NOTE: 1-Way connections will be designed to effectively eliminate unpermitted movements.						

**NOT INTENDED FOR FULL INTERSECTION DESIGN
SUMMARY OF GEOMETRIC REQUIREMENTS FOR TURNOUTS**

DESIGN NOTES

1. Prior to the adoption of FDOT Rules Chapters 14-96 and 14-97, connections to the State Highway System were defined and permitted by Classes. Connections have been redefined by Categories under Rule 14-96; and, the term "Class" has been applied to highway segments of the State Highway System as defined under Rule 14-97.

C:\projects\standards\roadway\00500-s\00515-01.dgn 6:20:58 PM 6/24/2013 smg70re

Footnotes:

All 1/2" joints shall be constructed with preformed joint filler.

* 1/8" Open joints placed at equal (20' max.) intervals for driveways over 20' wide. Joints in curb and gutter to match joints in driveways.

△ When connecting to side road curb and gutter sections, the no drop curb limits should extend back to the side road radius point. With or without curb and gutter, no driveway should encroach on the corner radius.

φ Driveways (6" concrete) shall be of a uniform width (W) to the right of way line.

⊖ Alpha-numeric identification of a flared driveway type specifically called for in the plans, see sheets 3 and 4.

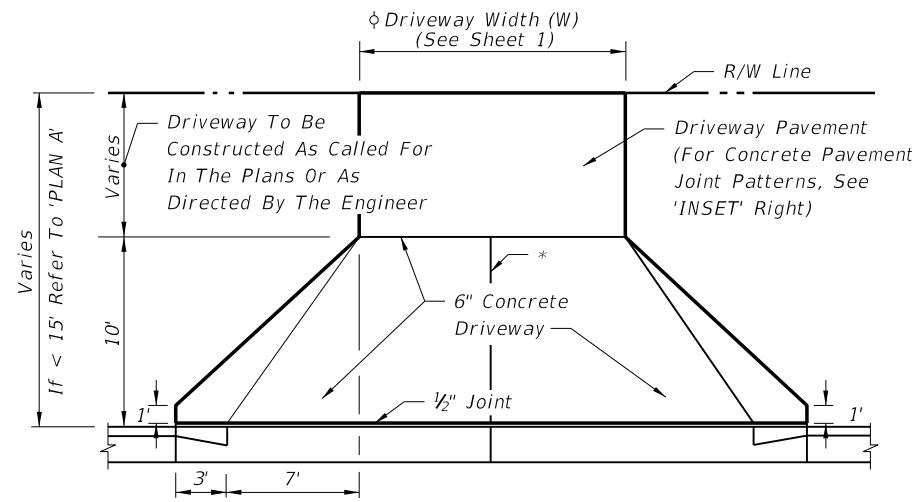

PLAN C
TURNOUT WITHOUT SIDEWALK

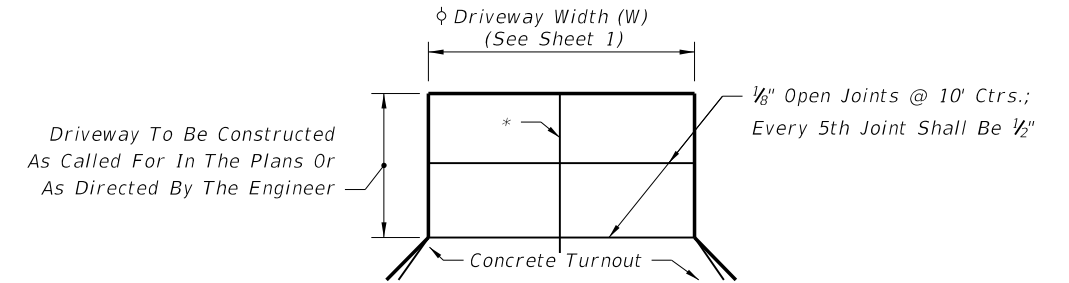

JOINT PATTERN WHEN CONCRETE DRIVE CONSTRUCTED INSET

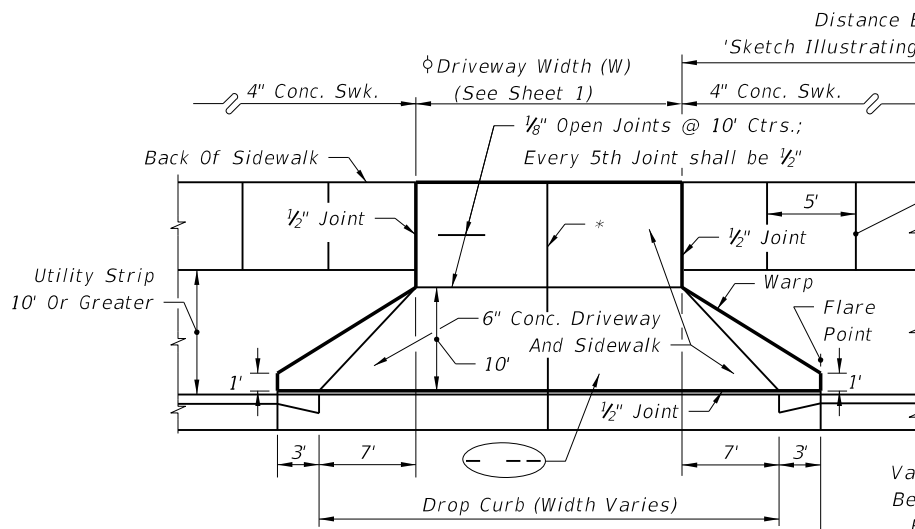

PLAN B
TURNOUT WITH SIDEWALK AND UTILITY STRIP (10' OR GREATER)

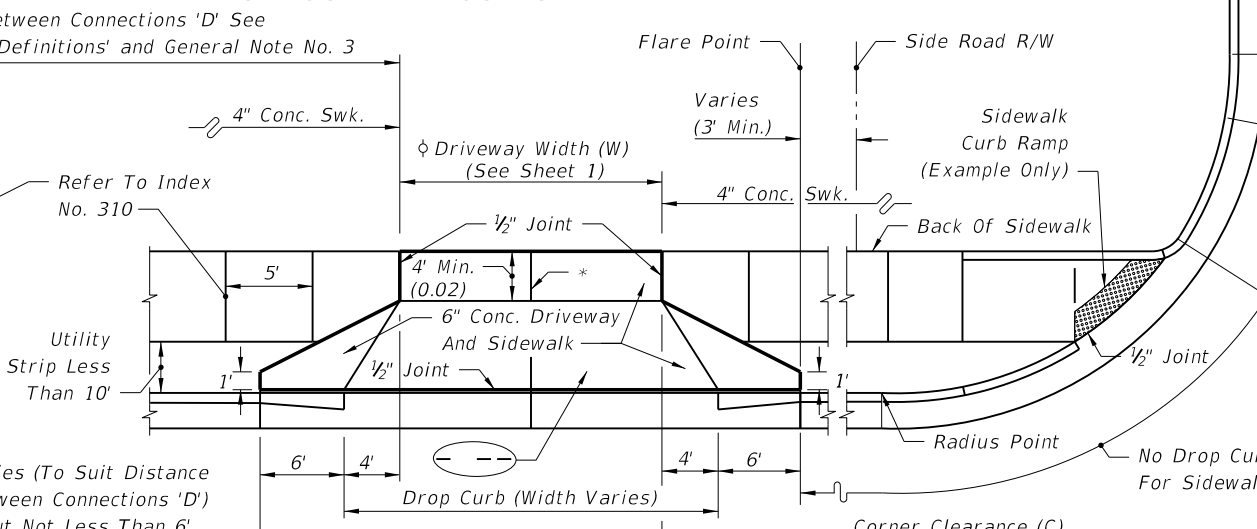

PLAN A
TURNOUT WITH SIDEWALK AND UTILITY STRIP (LESS THAN 10')

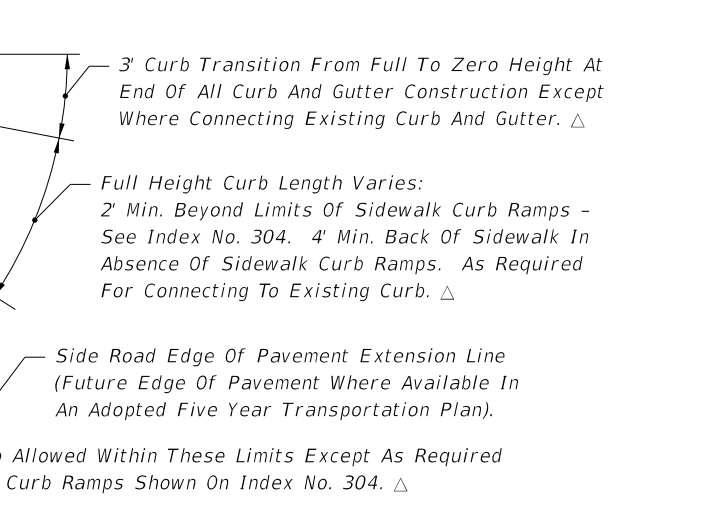

DESIGN NOTES FOR URBAN FLARED TURNOUTS

SPECIAL NOTES FOR URBAN FLARED TURNOUTS

- Drop curb, concrete sidewalks (6" thick) and driveways (6" thick) shall meet Specification Sections 520 and 522. The driveway foundation shall meet the requirements of Subarticle 522-4.
- For details of drop curb and sidewalk curb ramps refer to Indexes Nos. 300 and 304 respectively.
- Where turnouts are constructed within existing curb and gutter, the existing curb and gutter shall be removed either to the nearest joint beyond the flare point or to the extent that no remaining section is less than 5' long; and, drop curb constructed in accordance with Notes Nos. 1 and 2.
- For turnouts with radial returns see the requirements under the "Summary Of Geometric Requirements For Turnouts", the "General Notes", the details of "Rural Turnout Construction" and the detail of "Limits Of Clearing & Grubbing, Stabilization And Base At Intersections".

- Maintenance of pavement shall extend out to the right of way or 2' beyond the back of sidewalk, whichever distance is less.
- The maintenance and operation of highway lighting, traffic signals, associated equipment, and other necessary devices shall be the responsibility of a public agency.
- All pavement markings on the State highways, including acceleration and deceleration lane markings, and signing installed for the operation of the State highway shall be maintained by the Department.
- All signing and marking installed for the operation of the connection (such as stop bars and stop signs for the connection) shall be the responsibility of the permittee.
- All sidewalk surfaces crossing driveways with a cross slope shown in this Index to be 0.02 shall be 0.02 Maximum.

- Driveways indicated as 'Adverse Applications' are those with slopes that can cause overhang drag for representative standard passenger vehicles under fully loaded conditions; or, those with slopes that can cause drivers who are leaving the roadway to slow or pause to the extent that traffic demand volumes will be impeded.

Driveways indicated as 'Marginal Applications' are those with slopes that can cause overhang drag for representative standard passenger vehicles under fully loaded conditions when the driveway is located on the low side of fully superelevated roadways.

Driveways indicated as 'General Applications' are those with slopes that can readily accommodate representative standard passenger vehicles and those that can accommodate representative standard trucks, vans, buses and recreational vehicles operating under normal crown and superelevation conditions.
- The standard flared driveways on this index may not accommodate vehicles with low beds, low undercarriage or low appendage features. Where such vehicles are design vehicles, driveways shall have site specific flare designs or Category III designs.
- When specific flare type driveways shall be constructed, the type shall be designated in the plans using the assigned alpha-numeric designation.

URBAN FLARED TURNOUTS

6/24/2013 6:21:00 PM smg70re C:\projects\standards\roadway\00500-s\00515-02.dgn

LAST REVISION 07/01/13	REVISION	DESCRIPTION:	 <p>FDOT 2014 DESIGN STANDARDS</p>	TURNOUTS	INDEX NO. 515	SHEET NO. 2 of 7
---------------------------	----------	--------------	---	----------	------------------	---------------------

* See 'DESIGN NOTES FOR URBAN FLARED TURNOUTS'.

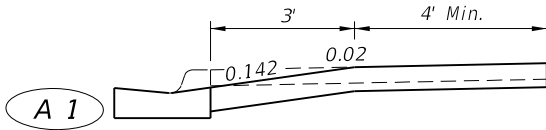
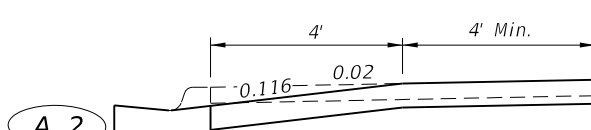
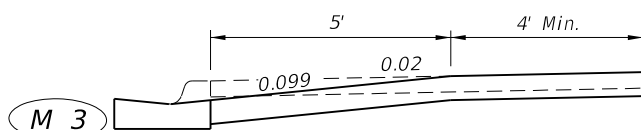
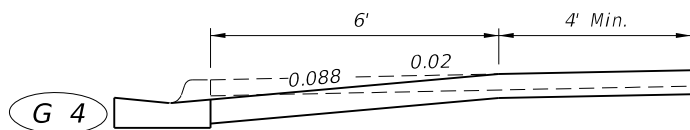
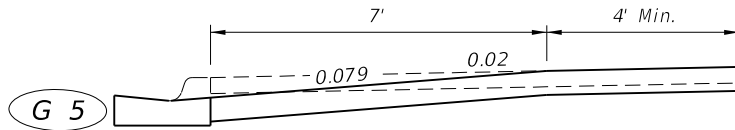
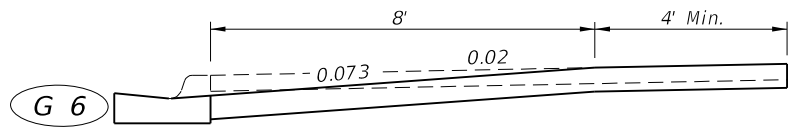
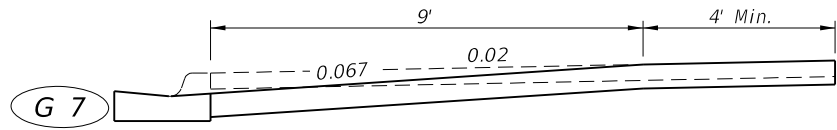
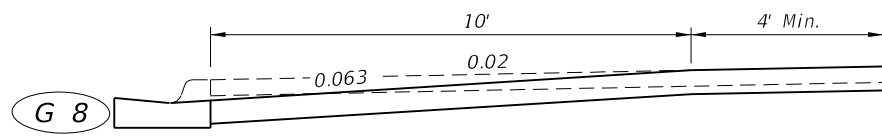

SIDEWALK ADJACENT TO CURB

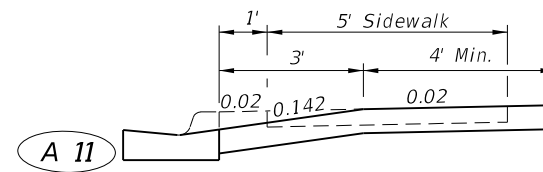
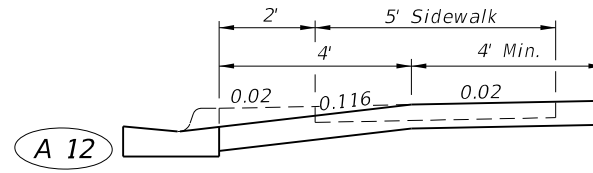
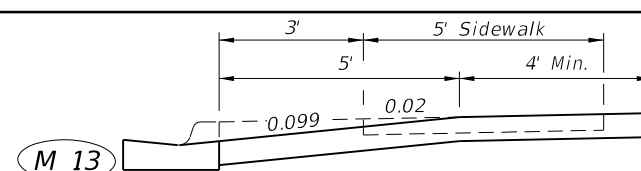
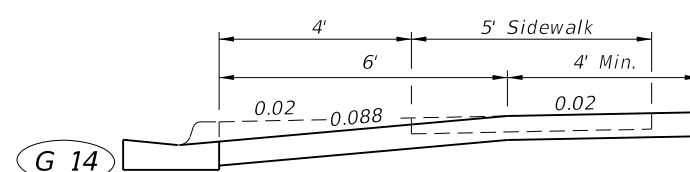
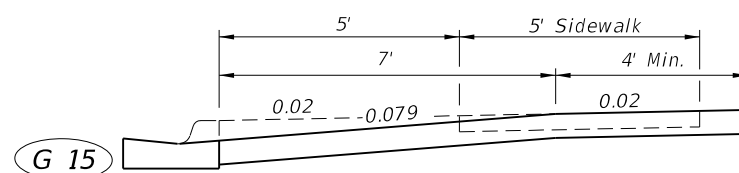
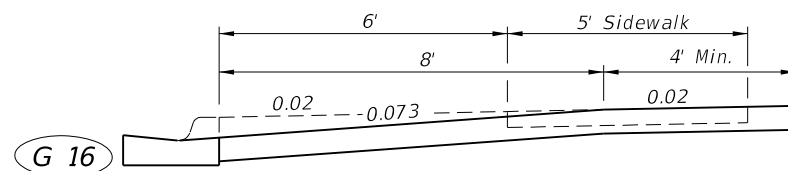
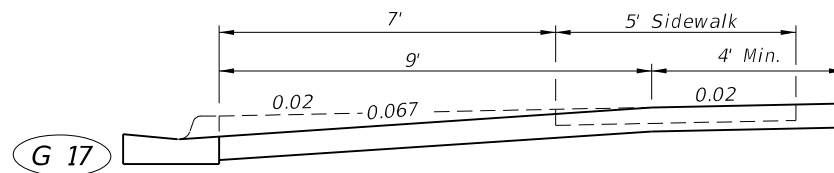
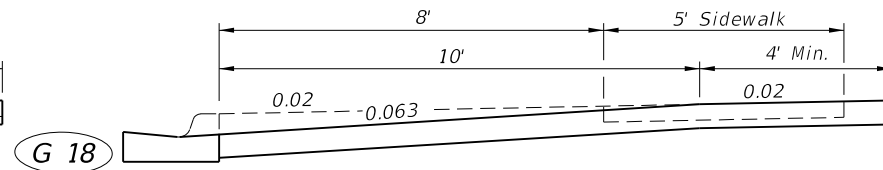

SIDEWALK WITH UTILITY STRIP ON 0.02 SLOPE

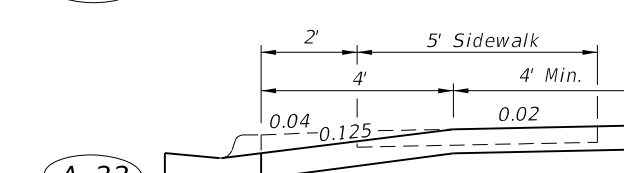
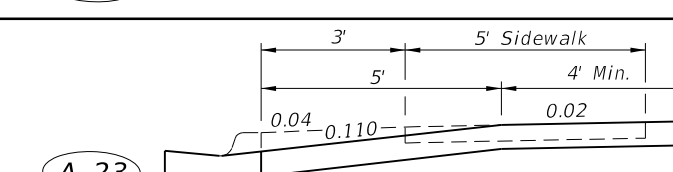
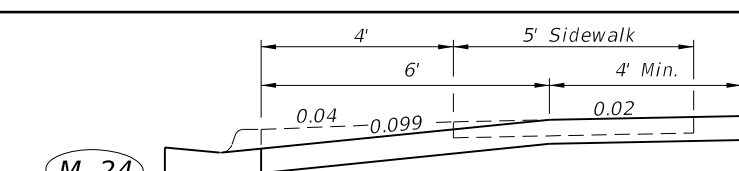
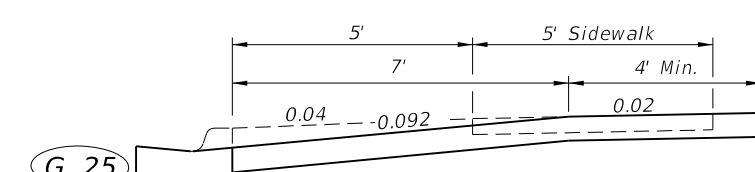
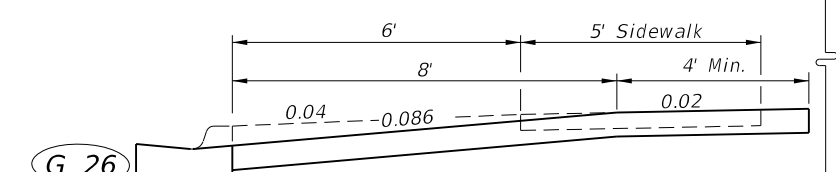
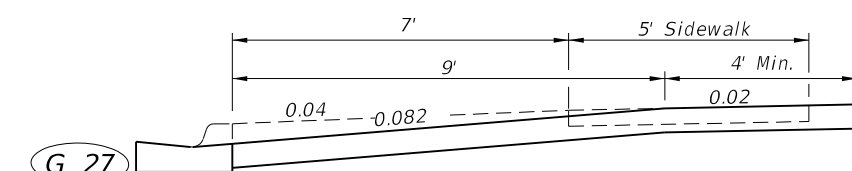
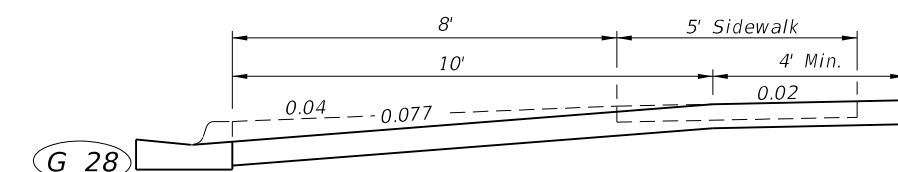
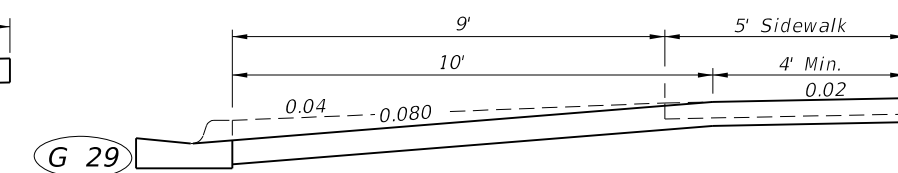
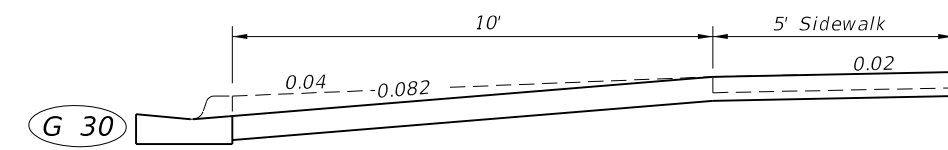

SIDEWALK WITH UTILITY STRIP ON 0.04 SLOPE

GENERAL* APPLICATIONS

MARGINAL* APPLICATIONS ON LOW SIDE OF FULLY SUPERELEVATED ROADWAY (REFER TO MODIFICATIONS ON SHEET 4)

ADVERSE* APPLICATIONS (REFER TO MODIFICATIONS ON SHEET 4)

DRIVEWAY SECTIONS ON CURBED FACILITIES WITH SIDEWALKS

C:\projects\standards\roadway\00500-s\00515-03.dgn 6:21:02 PM sm970re 6/24/2013

LAST REVISION 07/01/13	REVISION	DESCRIPTION:	 <p>FDOT 2014 DESIGN STANDARDS</p>	TURNOUTS	INDEX NO. 515	SHEET NO. 3 of 7

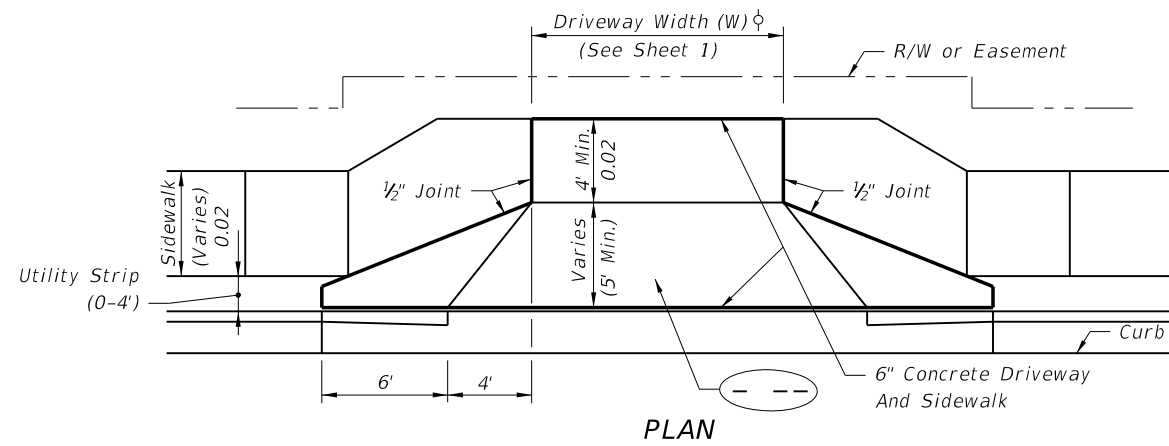

MODIFICATIONS OF 'ADVERSE' AND 'MARGINAL' APPLICATIONS

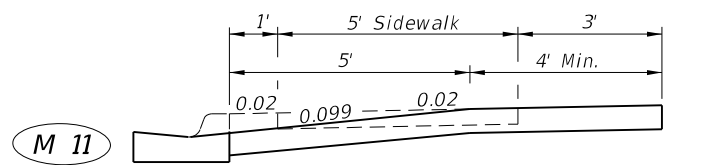
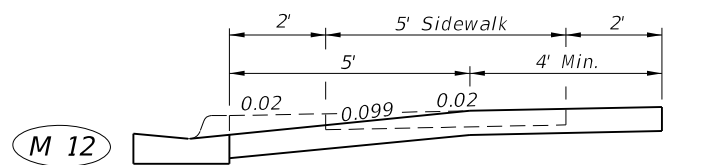
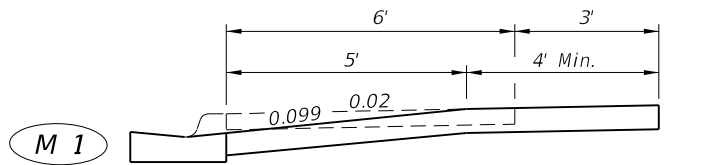
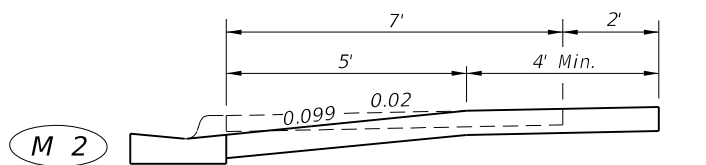
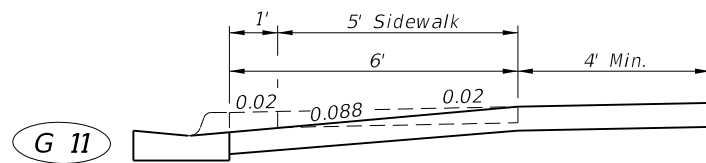
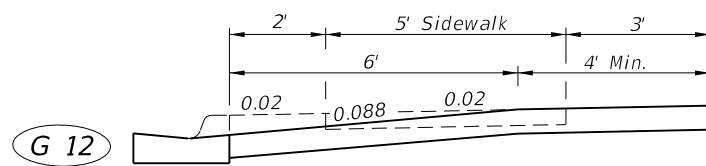
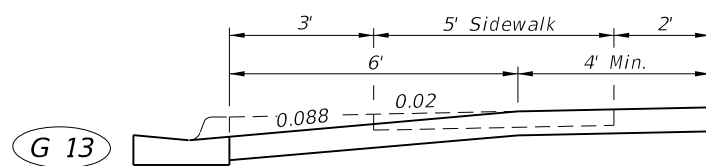
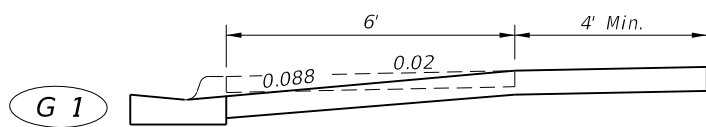
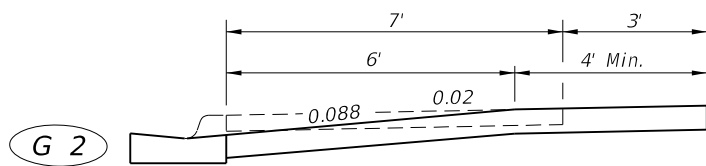
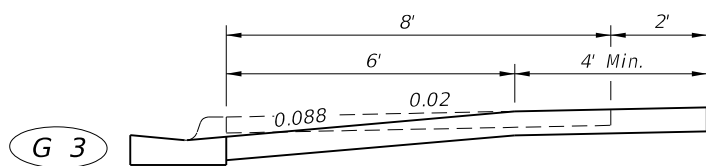

SIDEWALK ADJACENT TO CURB

SIDEWALK WITH UTILITY STRIP ON 0.02 SLOPE

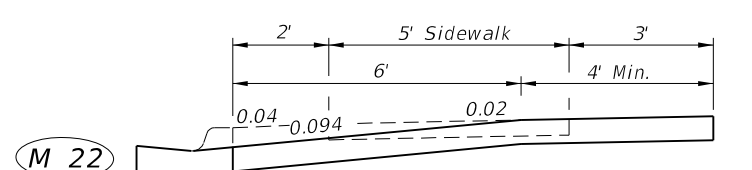
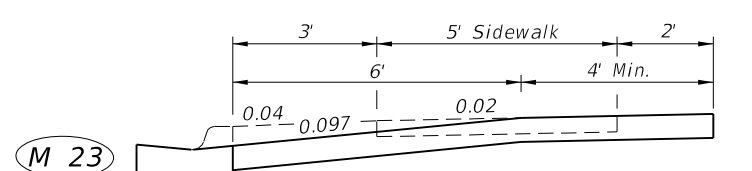
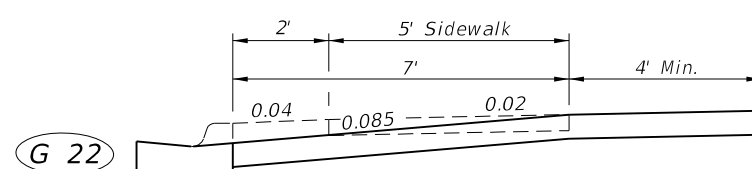
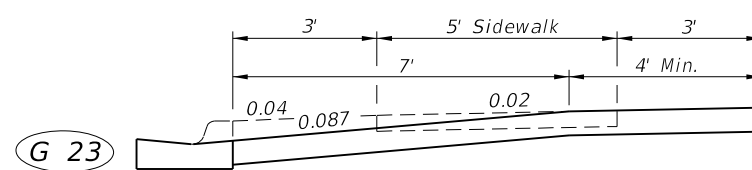
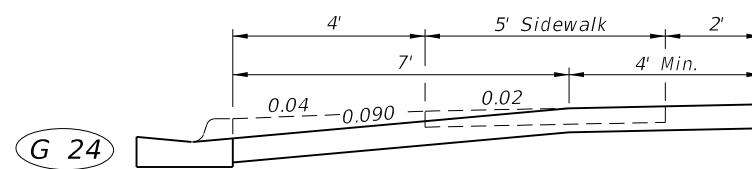

ADVERSE* AND MARGINAL* SECTIONS MODIFIED TO ACHIEVE GENERAL* APPLICATION

ADVERSE* SECTIONS MODIFIED TO ACHIEVE MARGINAL* APPLICATION

SIDEWALK WITH UTILITY STRIP ON 0.04 SLOPE

* See 'DESIGN NOTES FOR URBAN FLARED TURNOUTS'.

MODIFICATIONS TO ADVERSE AND MARGINAL SECTIONS

C:\projects\standards\roadway\00500-s\00515-04.dgn 6:21:04 PM sm970re 6/24/2013

LAST REVISION 07/01/13	REVISION	DESCRIPTION:	 FDOT 2014 DESIGN STANDARDS	TURNOUTS	INDEX NO. 515	SHEET NO. 4 of 7

C:\projects\standards\roadway\00500-s\00515-05.dgn 6:21:06 PM smg70re 6/24/2013

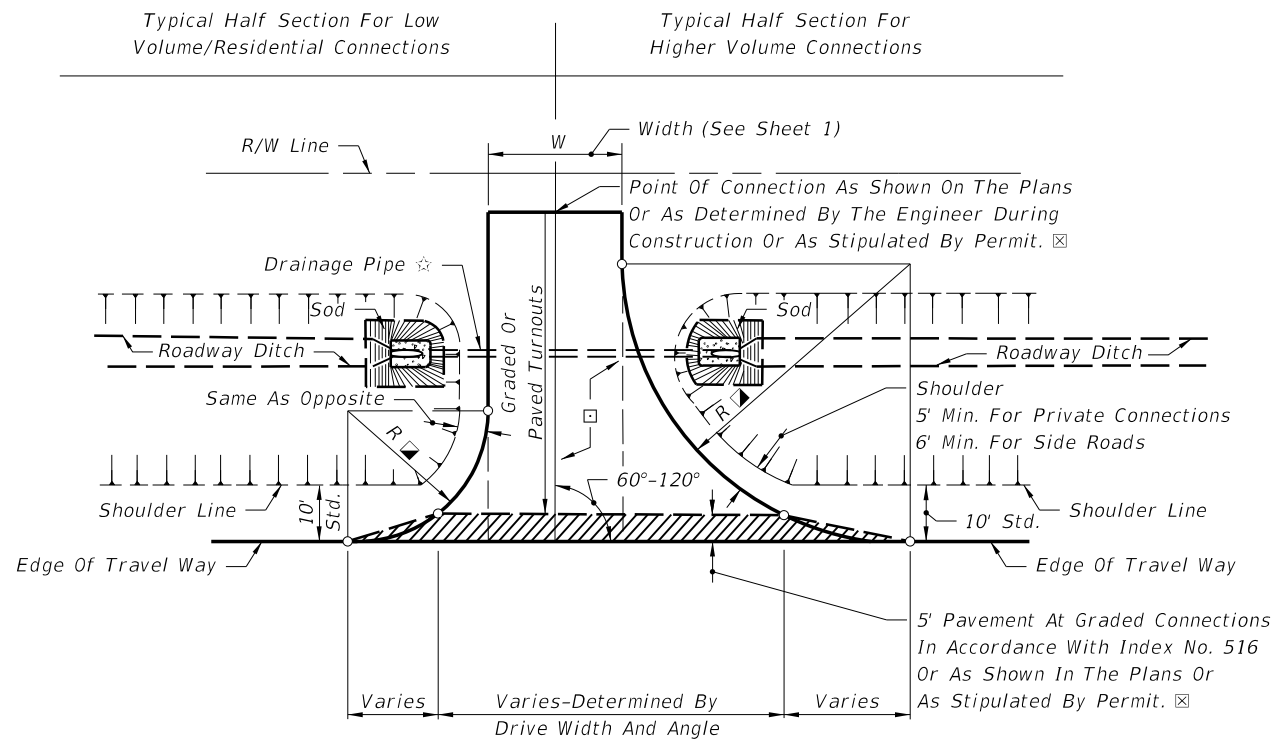

PLAN

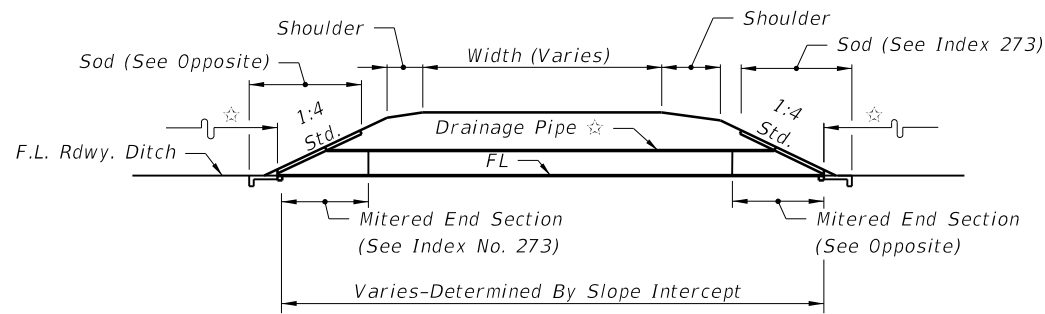

DRAINAGE SECTION

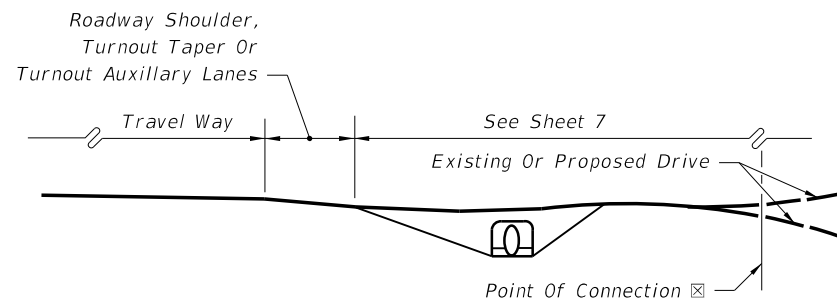

TURNOUT PROFILE AND END VIEW

RURAL TURNOUT CONSTRUCTION

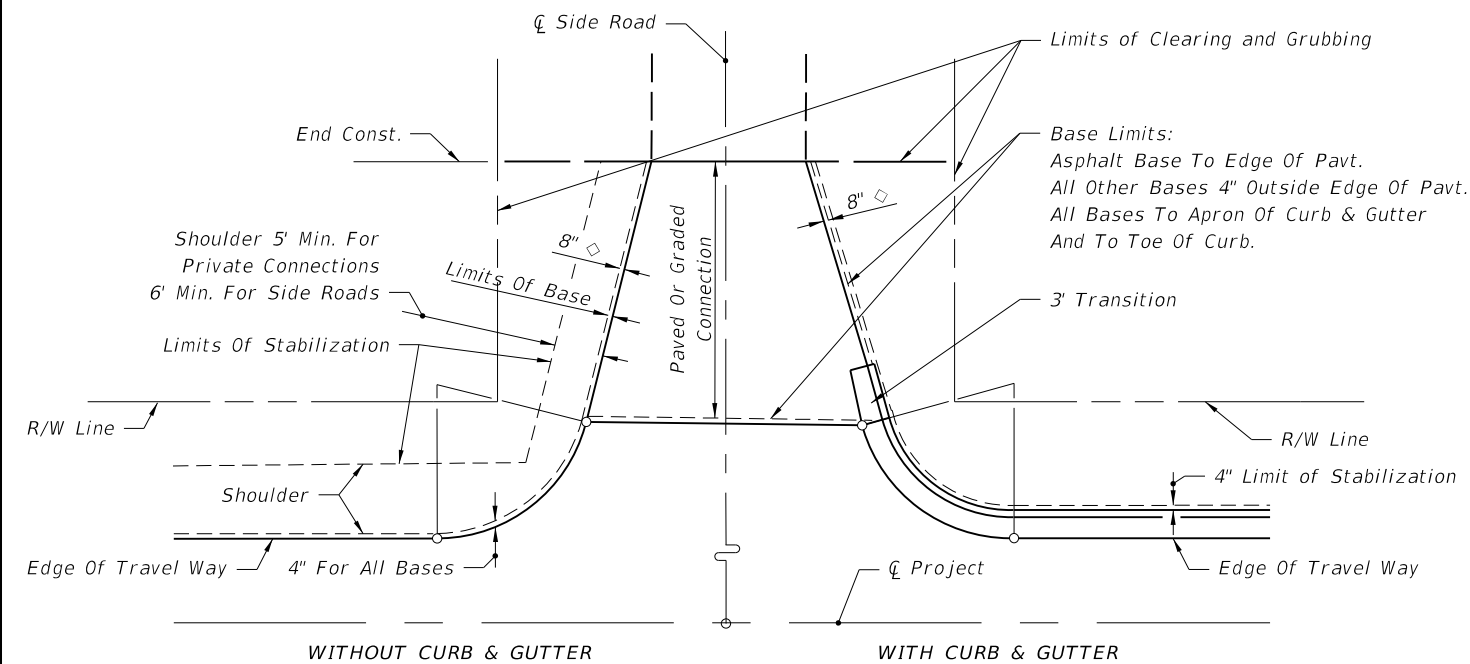

PLAN

LIMITS OF CLEARING & GRUBBING, STABILIZING AND BASE AT INTERSECTIONS

INTERSECTIONS NOTES:

- Return Radius Point or Transition Point.
- ◇ 8" Or Match Exist. Stabilization Limits (8" Min.).

DRIVE ENTRANCES NOTES:

- ☆ Drainage pipe size and length shall be that shown on the plans, or as stipulated by permit, or, as determined by the Engineer during construction. The size shall be at least that established by the FDOT District, but not less than 15" diameter or equivalent. For minimum cover over drainage pipe see Index No. 205. Pipe arch or elliptical pipe may be required to obtain necessary cover. At minimal cover applications a modified pavement apron is permitted. See 'PERMISSIBLE PAVEMENT MODIFICATION' Index No. 273. For spacing between adjacent pipe end treatments see Index No. 273.
- ☐ Stable material may be required for graded turnouts to private property as directed by the Engineer in accordance with Section 102-8 of the Standard Specifications.
- ☒ The 5' pavement at graded connections is not required where there is paved shoulder 4' or more in width. The 5' pavement requirement may be waived for connections serving one or two homes or field entrances with less than 20 trips per day, or 5 trips per hour as approved by permit or by the Engineer, or when not itemized in the plans.

Paved turnouts shall be constructed for all paved connecting facilities. The connecting point will be determined by the Engineer.

Paved turnouts shall be constructed for all business, commercial, industrial or high volume residential graded connecting facilities. The connecting point shall be 30' from edge of travel way or at R/W line, whichever is less.

Paved turnouts shall be constructed for all connecting facilities over 4000 vehicles per day. The connecting point shall be at the R/W line.
- See "Summary Of Geometric Requirements For Turnouts" chart for return radii lengths and supplemental information.
- Return Radius Point or Flare Point.

LAST REVISION 07/01/12	REVISION	DESCRIPTION:	 <p>FDOT 2014 DESIGN STANDARDS</p>	TURNOUTS	INDEX NO. 515	SHEET NO. 5 of 7
---------------------------	----------	--------------	--	-----------------	-------------------------	----------------------------

C:\projects\standards\roadway\00500-s\00515-06.dgn 6:21:08 PM smg70re 6/24/2013

MATERIAL TYPES AND THICKNESSES IN DRIVING AREAS FOR RURAL AND URBAN CONNECTIONS			
Course	Materials ②	Thickness (in.) ①	
		Connections ③	Roadway ④
Structural	Asphaltic Concrete	1"	1½"
Bases	Optional Base (See Index No. 514)	O.B.G. 1	O.B.G. 3

① Minimum thickness.
 ② All materials shall be approved by the Department prior to being placed.
 ③ Connection structure other than traffic lanes. See Notes 1 and 2 below.
 ④ Travel way flares (bypass lanes), auxiliary lanes serving more than a single connection, and all median crossovers including their auxiliary lanes and/or transition tapers. See Notes 1 and 2 below.

NOTES

- The pavement should be structurally adequate to meet the expected traffic loads and should not be less than that shown above, except as approved by the Department for graded connections. Other Department approved equivalent pavements may be used at the discretion of the Engineer. For additional information see Index No. 514.
- Auxiliary lanes and their transition tapers shall be the same structure as the abutting travel way pavement thickness or any of the roadway structures tabulated above, whichever is thicker.
- If an asphalt base course is used for a turnout, its thickness may be increased to match the edge of travel way pavement thickness in lieu of a separate structural course. 6" of Portland cement concrete will be acceptable in lieu of the asphalt base and structural courses. See Notes 4 and 5 below.
- A structural course is required for flexible pavements when they are used for auxiliary lanes serving more than a single connection.
- Connections paved with Portland cement concrete shall be Class NS concrete at least 6" thick. The Department may require greater thickness when called for in the plans or stipulated by permit. Materials and construction shall conform with FDOT Standard Specifications Sections 347, 350 and 522.
- The Department may require other pavement criteria where local conditions warrant.

**PAVEMENT STRUCTURE FOR TURNOUTS AND AUXILIARY LANES
TABLE 515-1**

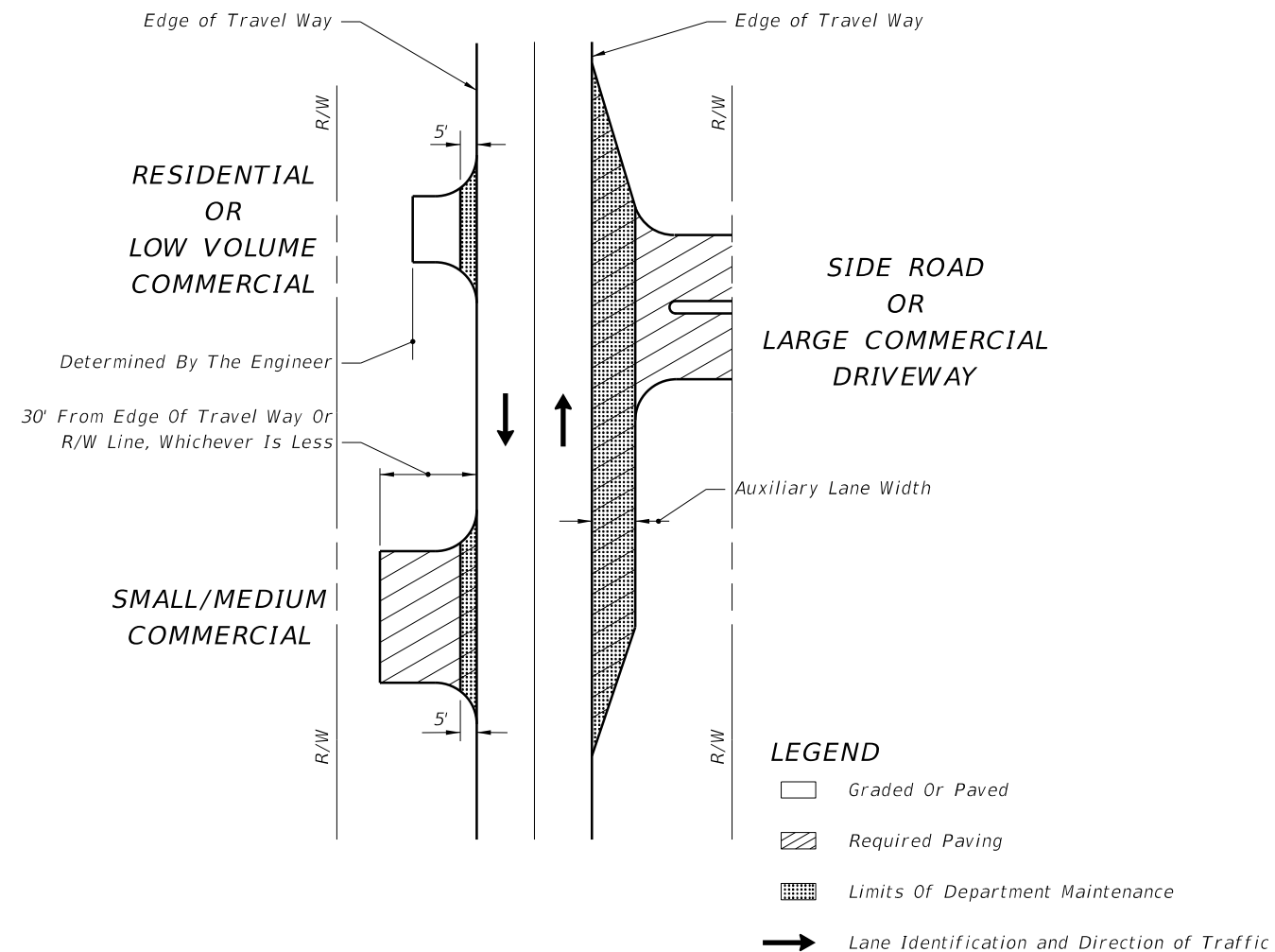

NOTES

- Auxiliary lane pavements and crossover pavements shall be maintained by the Department.
- Department maintenance of turnout pavement shall extend out to 5' from edge of the travel way or limits of paved shoulders, and, extend to include auxiliary lanes. The remainder of any turnout paved area on the right of way shall be maintained by the owner or his authorized agent. As a function of routinely reworking shoulders, the Department may grade and shape existing material on nonpaved areas beyond the maintained pavement.
- Control and maintenance of drainage facilities within the right of way shall be solely the responsibility of the Department, unless specified differently by Department permit.
- The maintenance and operation of highway lighting, traffic signals, associated equipment, and other necessary devices shall be the responsibility of a public agency.
- All pavement markings on the State highways, including acceleration and deceleration lane markings, and signing installed for the operation of the State highway shall be maintained by the Department.
- All signing and marking installed for the operation of the connection (such as stop bars and stop signs for the connection) shall be the responsibility of the permittee.

**LIMITS OF
CONSTRUCTION AND MAINTENANCE
FOR RURAL CONNECTIONS**

LAST REVISION 07/01/12	REVISION	DESCRIPTION:	 FDOT 2014 DESIGN STANDARDS	TURNOUTS	INDEX NO. 515	SHEET NO. 6 of 7
---------------------------	----------	--------------	--	-----------------	-------------------------	----------------------------

C:\projects\standards\roadway\00500-s\00515-07.dgn
smg70re
6/24/2013 6:21:10 PM

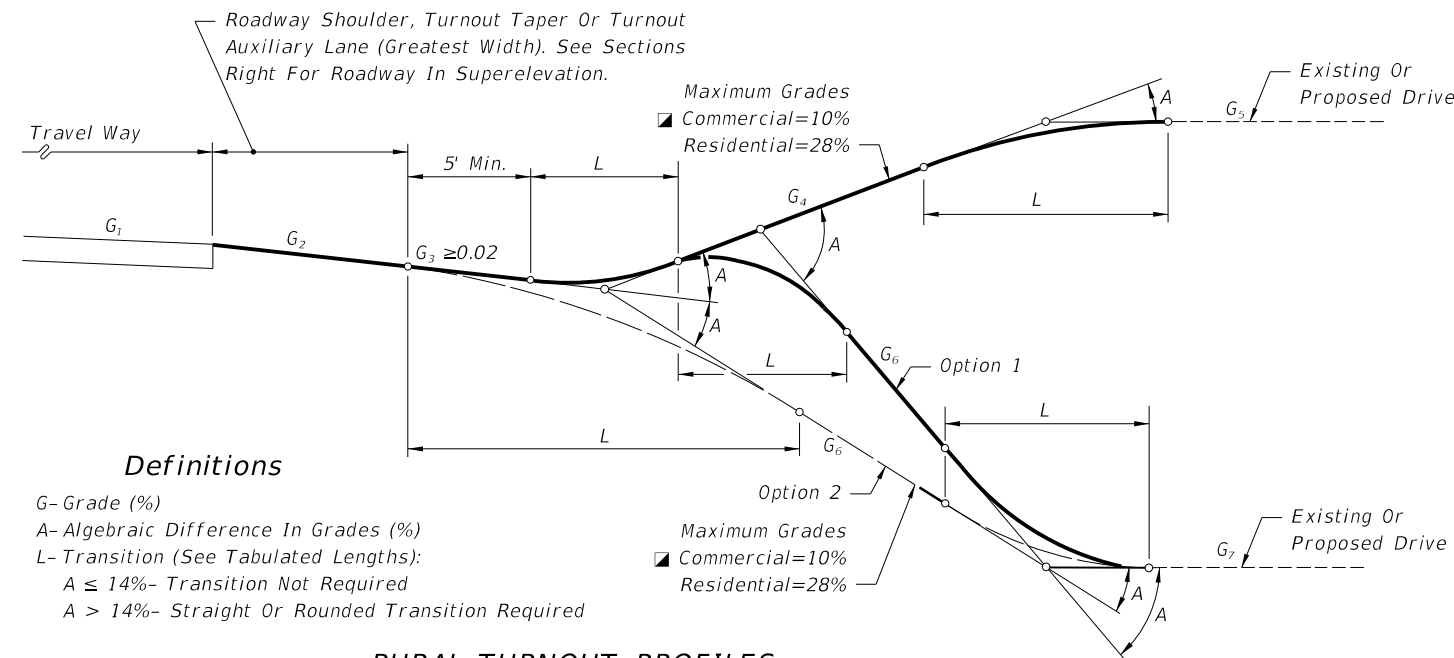

RURAL TURNOUT PROFILES

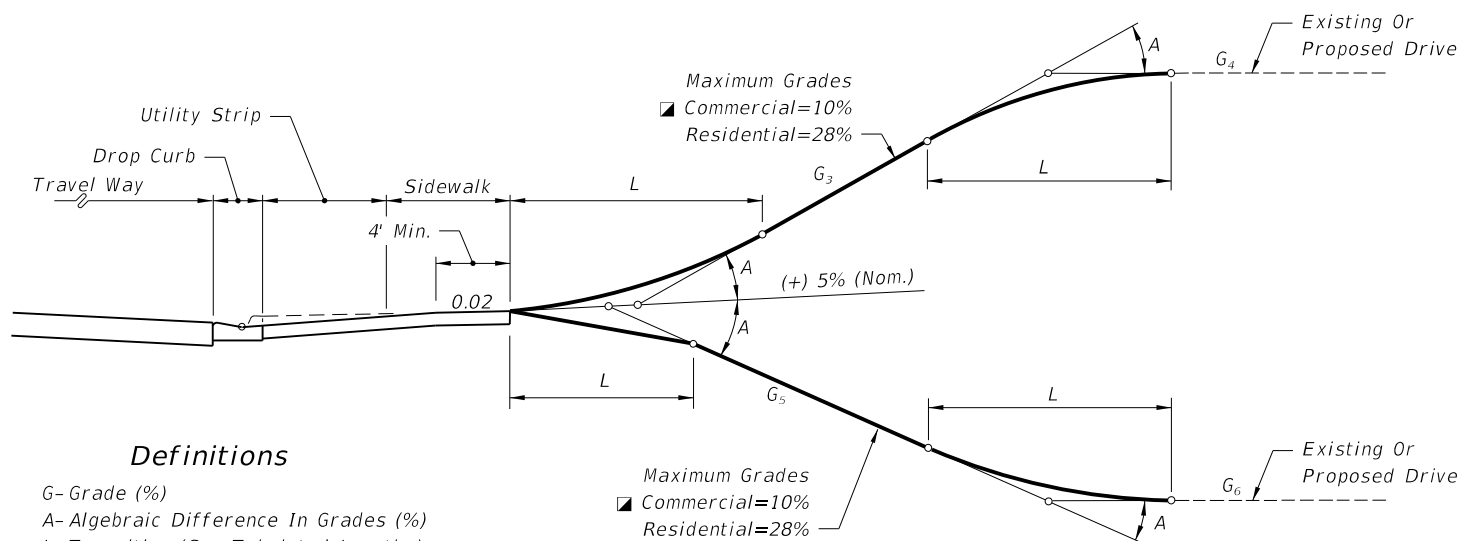

URBAN TURNOUT PROFILES

When restoring or reconstructing existing commercial turnout connections on new construction and reconstruction projects, the maximum 10% commercial grade may be exceeded provided this does not create adverse roadway operational or safety impacts. This shall be approved by the District Design Engineer and supported by documented site specific findings.

A	LENGTHS (L) (FT.)							
	CRESTS				SAGS			
	STRAIGHT		ROUNDED		STRAIGHT		ROUNDED	
	Desirable	Minimum	Desirable	Minimum	Desirable	Minimum	Desirable	Minimum
6-13%	3	0	5	0	3	0	5	0
14%	3	0	10	0	3	0	10	0
15%	3	2.5	10	3	5	3	10	5
16%	5	3	10	4	6	4	10	6
17%	6	3.5	10	5	8	5	10	7
18%	6	4	10	6	9	6	10	8
19%	7	4.5	10	7	11	7	12	9
20%	8	5	11	8	12	8	13	10
21%	9	5.5	12	9	13	8.5	14	11
22%	10	6	13	10	14	9	16	12
23%	10	6.5	14	10.5	14	9.5	16	12.5
24%	11	7	15	11	15	10	17	13
25%	12	7.5	15	11.5	16	10.5	18	13.5
26%	12	8	16	12	17	11	18	14
27%	13	8.5	17	12.5	17	11.5	19	14.5
28%	14	9	17	13	18	12	20	15
29%	NA	NA	22	14	NA	NA	21	17
30-31%	NA	NA	23	15	NA	NA	22	18
32-33%	NA	NA	24	16	NA	NA	23	20
34-36%	NA	NA	26	17	NA	NA	25	21
37-38%	NA	NA	27	18	NA	NA	26	22
39-41%	NA	NA	29	19	NA	NA	28	24
42-43%	NA	NA	30	20	NA	NA	29	25
44-46%	NA	NA	32	21	NA	NA	31	26
47-48%	NA	NA	33	22	NA	NA	32	27
49-51%	NA	NA	34	23	NA	NA	34	28
52-54%	NA	NA	36	24	NA	NA	35	30
55-56%	NA	NA	37	25	NA	NA	36	31

Rounded: Either circular, parabolic, or spline curvature. The plans or the Engineer may specify a particular type of curvature.
 Desirable: Desirable minimum lengths {Greater lengths than minimum and desirable are recommended where practical for flatter and smoother profile.}
 Minimum: Absolute minimum lengths

RECOMMENDED TURNOUT PROFILE TRANSITION LENGTHS (L) (FT.)

STORMWATER RUNOFF AND PROFILE OPTION NOTES

- Turnouts shall neither cause water to flow on or across the roadway pavement, nor cause water ponding or erosion within the State right of way. On all rural turnouts the transition (L) nearest the roadway shall be sloped or crowned to direct stormwater runoff to the roadside ditch. Inlets, flumes or other appropriate runoff control devices shall be constructed when runoff volumes are sufficient to cause erosion of the shoulder. Similar runoff control devices shall be constructed as necessary to properly direct and control the stormwater runoff on urban turnouts.
- The Option 1 profile is intended for locations where roadway, turnout taper and auxiliary lane stormwater runoff volumes are relatively large. The Option 2 profile is intended for locations where runoff volumes are relatively small and/or where there is no roadside ditch.

TURNOUT PROFILES

