

FREEWAY USE

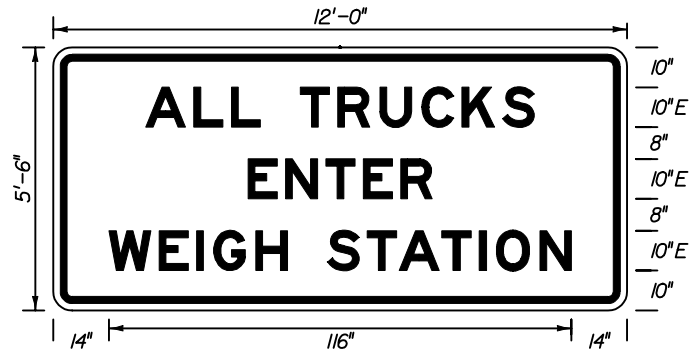

FTP-1-04
12' X 5'-6"
3" Radii 2" Border
10" Series E Legend
White Background
Black Legend & Border

OTHER THAN FREEWAY USE

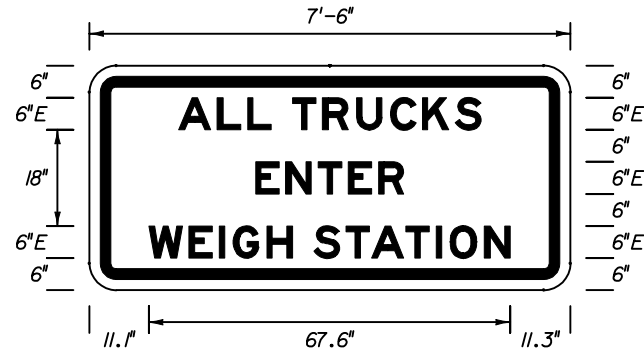

FTP-2-04
7'-6" X 3'-6"
3" Radii 2" Border
6" Series E Legend
White Background
Black Legend & Border

OTHER THAN FREEWAY USE

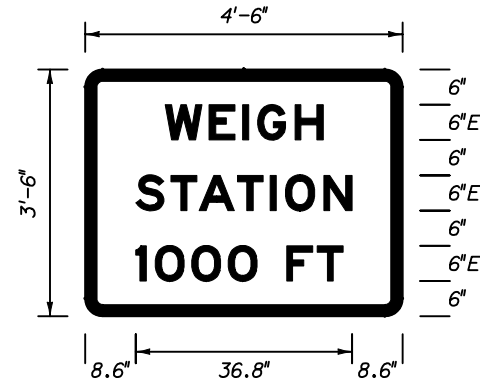

FTP-3-04
4'-6" X 3'-6"
3" Radii 2" Border
6" Series E Legend
Green Background
White Legend & Border

OTHER THAN FREEWAY USE

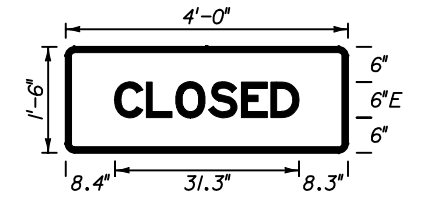

FTP-4-04
4' X 1'-6"
1 1/2" Radii 2" Border
6" Series E Legend
Green Background
White Legend & Border

Note
FTP-4-04 to be
used with FTP-3-04

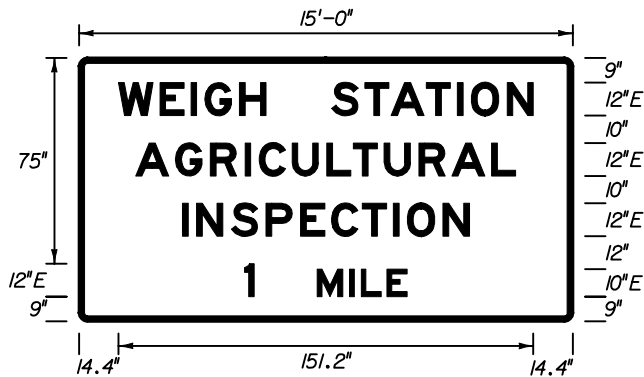

FTP-5-04
15' X 8'
3" Radii 2" Border
Series E Legend
Green Background
White Legend & Border

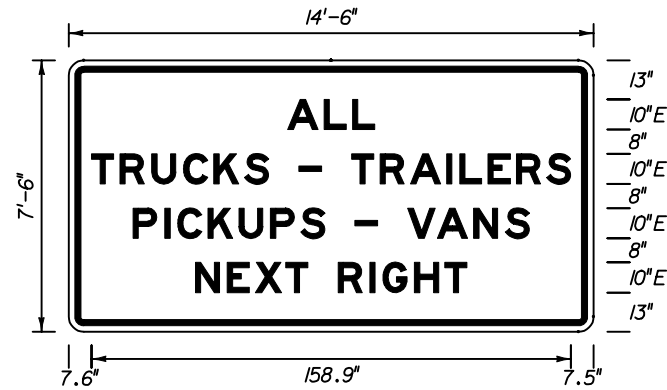

FTP-6A-04
14'-6" X 7'-6"
3" Radii 2" Border
10" Series E Legend
White Background
Black Legend & Border

On Interstate Station,
Delete Pickups-Vans,
and reduce Sign height
accordingly.

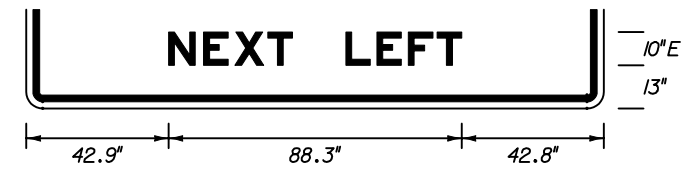

FTP-6B-04
14'-6" X 7'-6"
3" Radii 2" Border
10" Series E Legend
White Background
Black Legend & Border

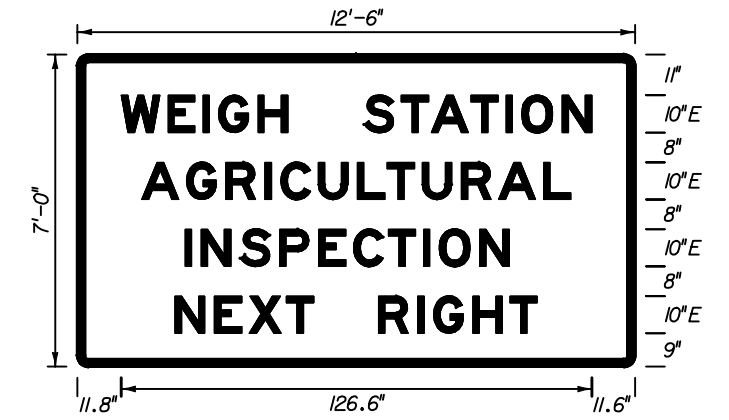

FTP-7A-04
12'-6" X 7'
3" Radii 2" Border
10" Series E Legend
Green Background
White Legend & Border

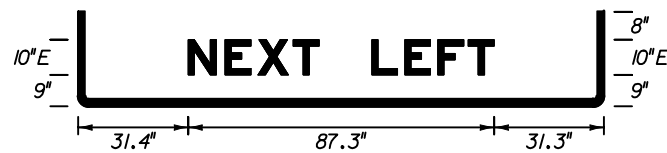

FTP-7B-04
12'-6" X 7'
3" Radii 2" Border
Series E Legend
Green Background
White Legend & Border

FREEWAY USE

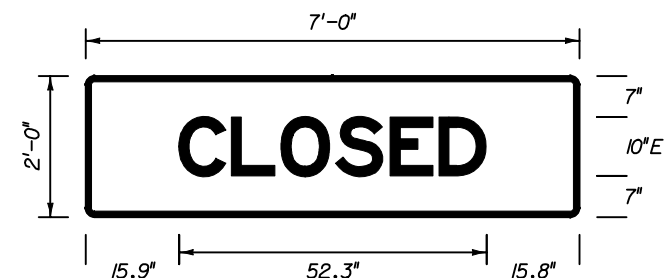

FTP-8-04
7' X 2'
1 1/2" Radii 2" Border
10" Series E Legend
Green Background
White Legend & Border

Note
FTP-8-04 to be
used with FTP-7A-04
& FTP-7B-04.

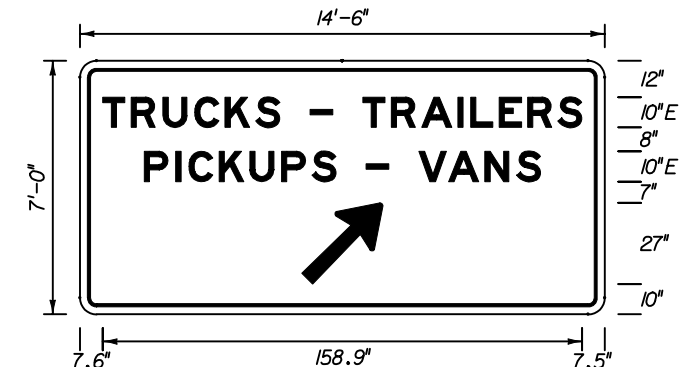

FTP-9A-04
14'-6" X 7'
3" Radii 2" Border
10" Series E Legend
Green Background
White Legend & Border

FTP-9B-04 - RIGHT ARROW
FTP-9C-04 - LEFT ARROW

STATE OF FLORIDA DEPARTMENT OF TRANSPORTATION

SPECIAL SIGN DETAILS

Names		Dates		Approved By	
Designed By				 State Traffic Standards Engineer	
Drawn By		Revision	Sheet No.	Index No.	
Checked By		04	1 of 10	17355	

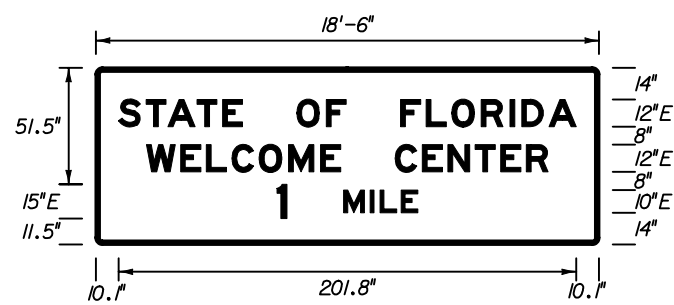

FTP-10-04
18'-6" X 6'-6"
3" Radii 2" Border
Series E Legend
Blue Background
White Legend & Border

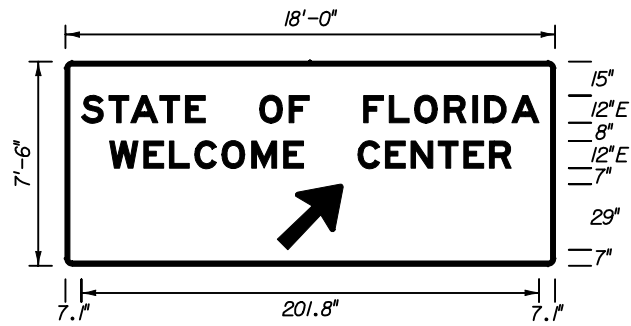

FTP-11-04
18' X 7'-6"
3" Radii 2" Border
Series E Legend
Blue Background
White Legend & Border

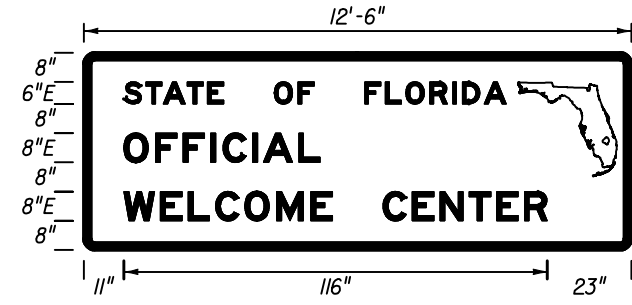

FTP-12-04
12'-6" X 4'-6"
3" Radii 2" Border
Series E Legend
Blue Background
White Legend & Border

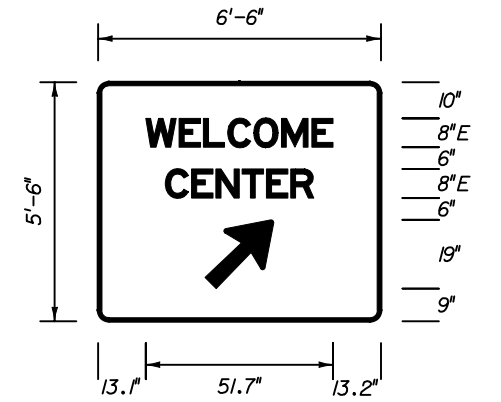

FTP-13-04
6'-6" X 5'-6"
3" Radii 2" Border
8" Series E Legend
Blue Background
White Legend & Border

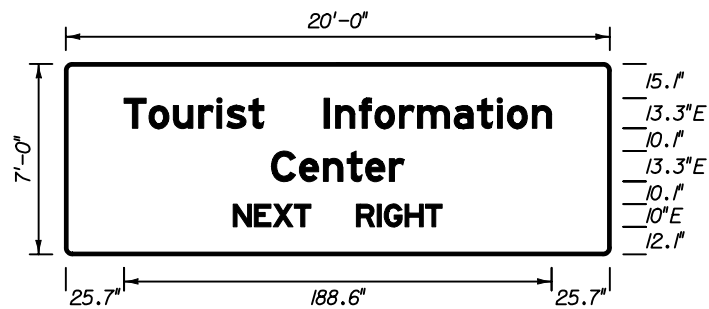

FTP-14-04
20' X 7'
3" Radii 2" Border
Series E Legend
Blue Background
White Legend & Border

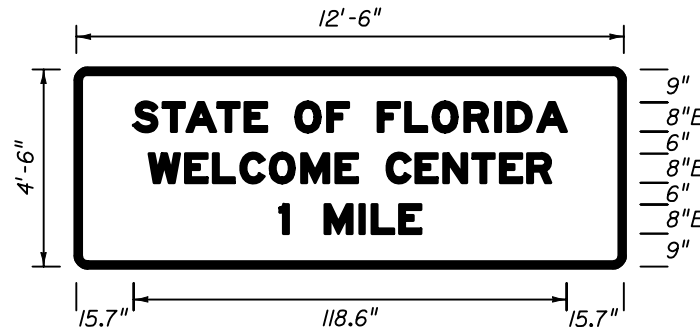

FTP-15A-04
12'-6" X 4'-6"
3" Radii 2" Border
8" Series E Legend
Blue Background
White Legend & Border

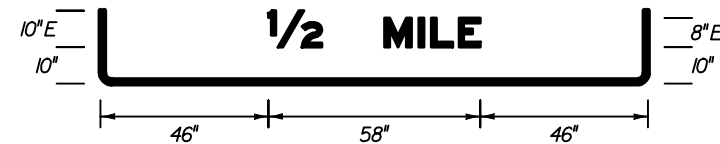

FTP-15B-04
12'-6" X 5'
3" Radii 2" Border
8" Series E Legend
Blue Background
White Legend & Border

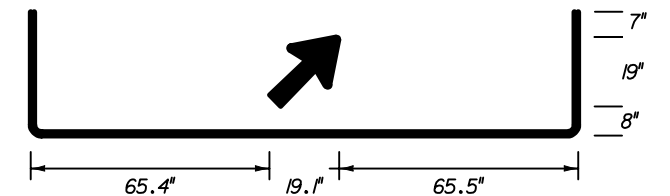

FTP-15C-04
12'-6" X 5'-6"
3" Radii 2" Border
Blue Background
White Legend & Border

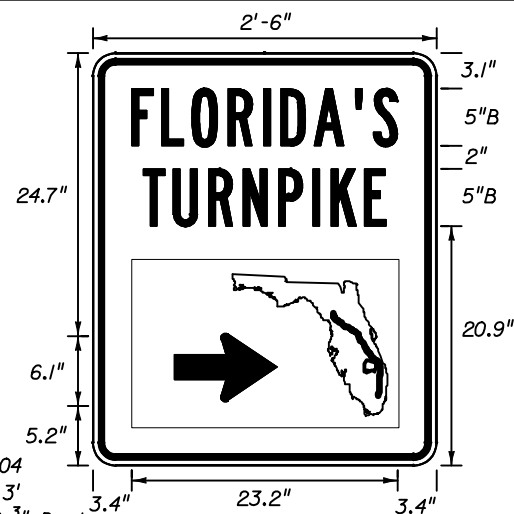

FTP-16-04
2'-6" X 3'
1 1/2" Radii 3/4" Border
5" Series B Legend
Green Background
White Legend & Border

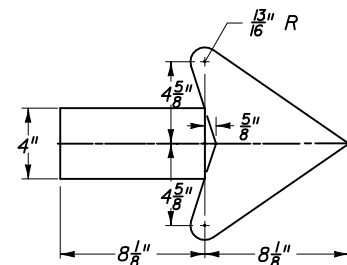

ARROW DETAIL
FOR SIGN FTP-16-04

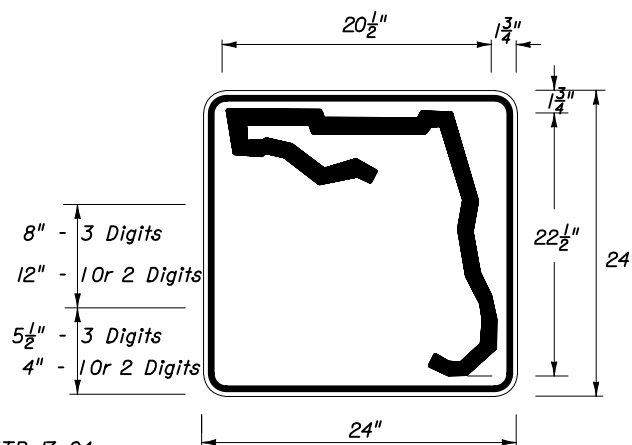

FTP-17-04
2' X 2'
1 1/2" Radii 3/4" Border
White Background
Black Legend & Border

See Sheet 3 of 10
For Additional Details.

STATE OF FLORIDA DEPARTMENT OF TRANSPORTATION				
SPECIAL SIGN DETAILS				
Designed By	Names	Dates	Approved By <i>Clark A. Scott</i> State Traffic Standards Engineer	
Drawn By			Revision	Sheet No. Index No.
Checked By			04	2 of 10 17355

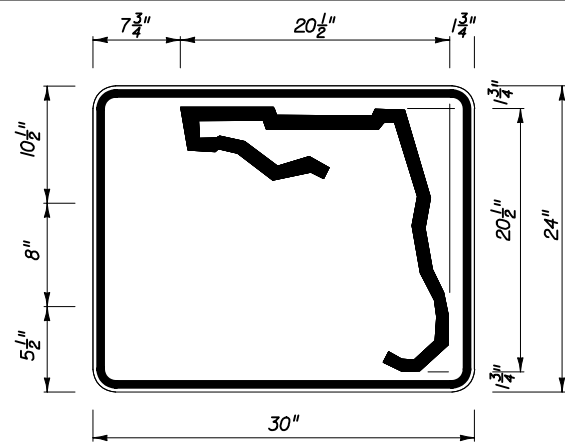

3 or 4 DIGITS

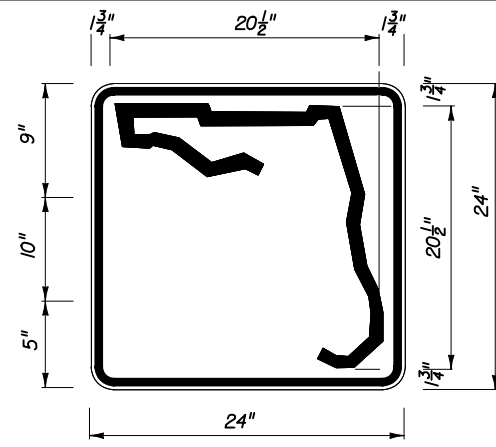

1 or 2 DIGITS

DIGITS	NUMERAL SIZE	SERIES	PANEL SIZE
1-2	10"	D	24" x 24"
3	8"	C	30" x 24"
4	8"	C	30" x 24"

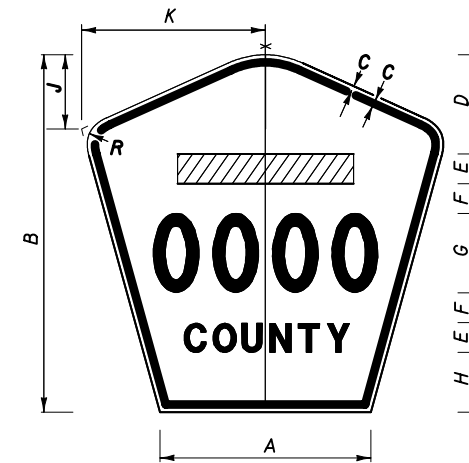

- Notes :
1. All Legend Series "D".
 2. Color: Yellow Legend and Border on Blue Background.
 3. When used on a guide sign, marker must be overlaid on a rectangular Yellow Background as shown in chart. **

INDEPENDENT USE OTHER THAN FREEWAY

SIGN	DIMENSIONS												**
	A	B	C	D	E	F	G	H	J	K	R	S	
4 DIGIT POST MOUNTED	21 1/4"	36"	1/2"	8"	3"	3"	8"	8"	7 1/2"	18 1/2"	1 3/8"	7 1/2"	
2 DIGIT OVERHEAD	21 1/4"	36"	3/4"	8"	3"	3"	12"	4"	7 1/2"	18 1/2"	1 3/8"	7 1/2"	40" x 41"
3 DIGIT OVERHEAD	29 1/4"	36"	3/4"	8"	3"	3"	12"	4"	8"	21 3/8"	2 1/4"	8 1/4"	40" x 44"
4 DIGIT OVERHEAD	36 3/4"	42"	3/4"	11"	3"	3"	12"	7"	10 1/2"	26"	2 1/4"	8 1/2"	42" x 52"

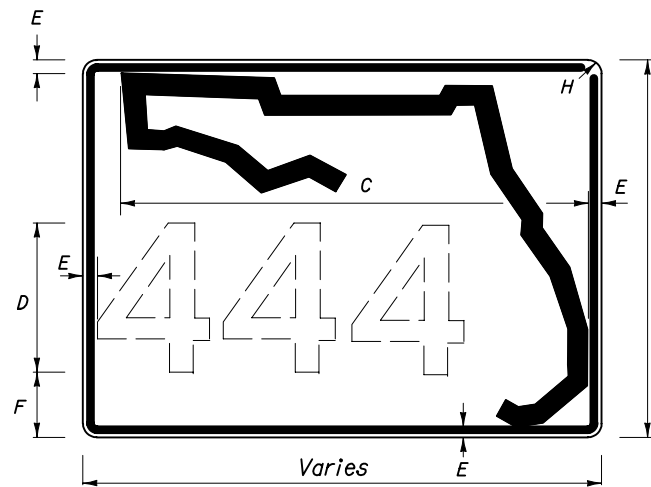

3 OR MORE DIGITS

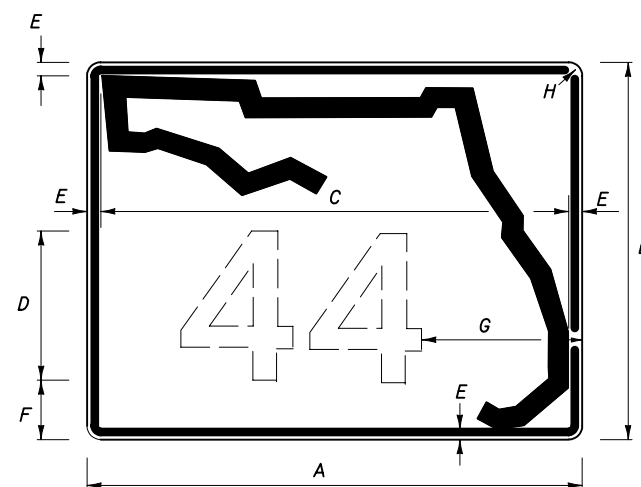

1 OR 2 DIGITS

A	B	C	D	E	F	G	H
30"	24"	26"	12"	1 1/4"	2 3/4"	8 1/4"	1 1/4"
36"	30"	32"	15"	1 1/4"	3 1/4"	8 3/4"	1 1/4"
42"	36"	38"	15"	1 1/4"	6 1/4"	11"	1 1/4"

GUIDE SIGN USE

- Notes: 1. Florida marker shall have Black Legend with White Background.
 2. Stroke width of State outline to be 1" for independent use and 1/4" for Guide Sign.
 3. Numbers are series D.

FLORIDA ROUTE MARKER
FTP-17-04

MI-5 COUNTY ROUTE MARKER DETAIL
FTP-18-04

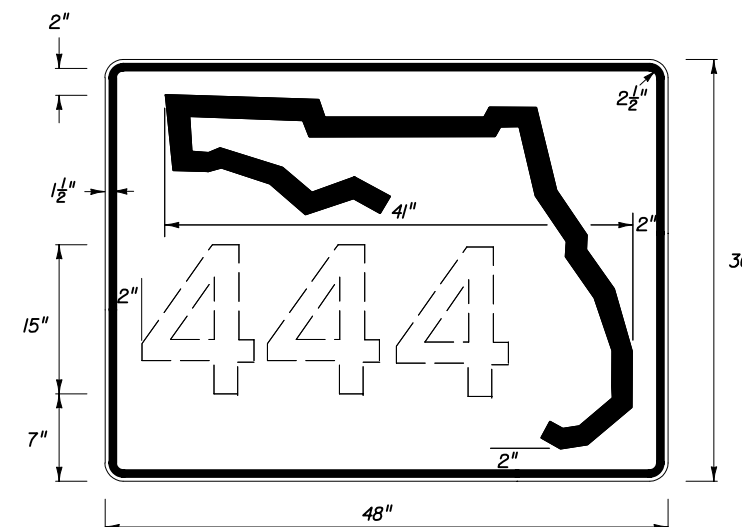

1-3 DIGITS 15" SERIES C
 4 DIGITS 12" SERIES C
 INDEPENDENT USE FOR FREEWAY

STATE OF FLORIDA DEPARTMENT OF TRANSPORTATION				
SPECIAL SIGN DETAILS				
Names	Dates	Approved By		
Designed By		 State Traffic Standards Engineer		
Drawn By		Revision	Sheet No.	Index No.
Checked By		04	3 of 10	17355

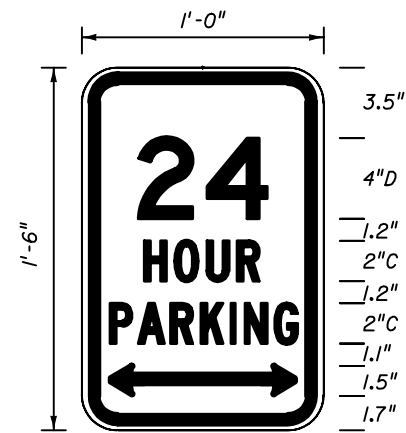

FTP-19-04
1' X 1'-6"
1 1/2" Radii
3/8" Border 3/8" Inset
Top 4" Series D
Bottom 2" Series C
White Background Green Legend & Border

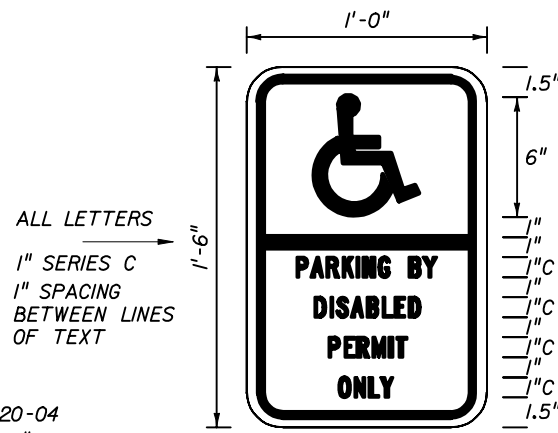

FTP-20-04
1' X 1'-6"
1 1/2" Radii 3/8" Border 3/8" Inset
1" Series C Legend
Color Top Bottom
Background Blue White
Legend and Border White Black

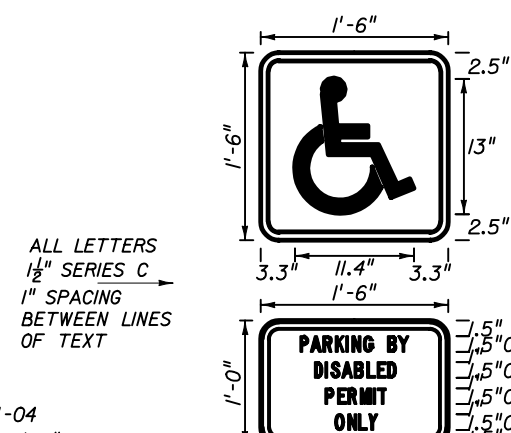

FTP-21-04
1'-6" X 2'-6"
1 1/2" Radii 5/8" Border 3/8" Inset
1 1/2" Series C Legend
Color Top Bottom
Background Blue White
Legend and Border White Black

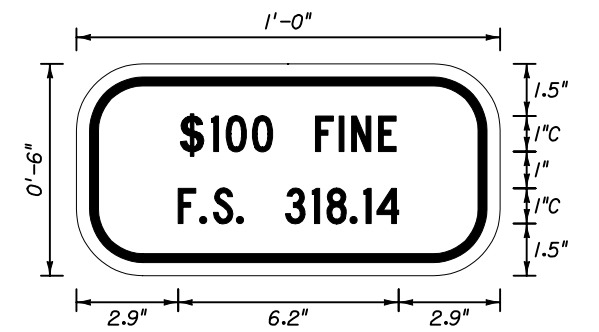

FTP-22-04
1' X 6"
1 1/2" Radii 3/8" Border 3/8" Inset
1" Series C
White Background
Black Legend & Border
Supplemental panel
for the FTP-20-04
and FTP-21-04 signs

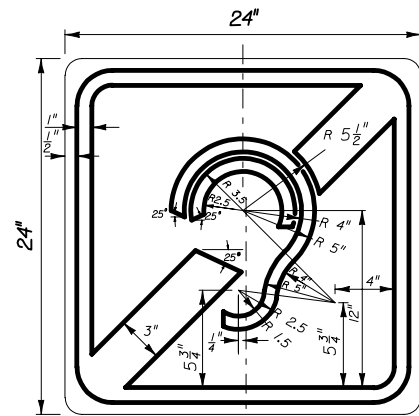

FTP-23-04 INTERNATIONAL SYMBOL OF ACCESS FOR HEARING LOSS
24" X 24"
1 1/2" Radii
Blue Background
White Legend & Border

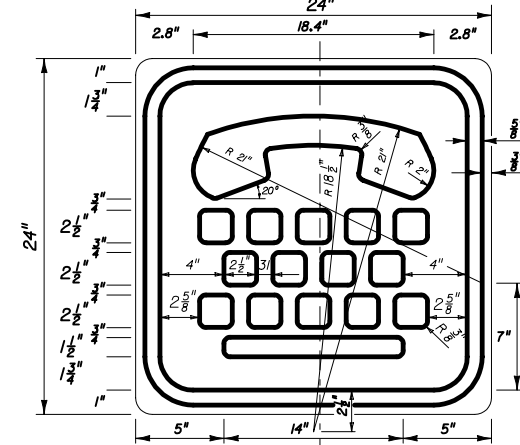

FTP-24-04
2' X 2'
1 1/2" Radii
Blue Background
White Legend & Border

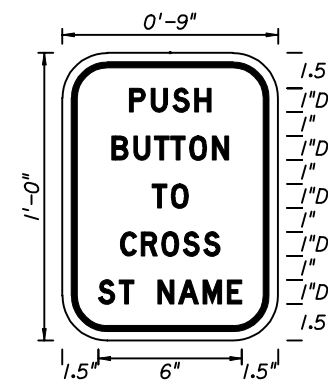

FTP-25-04
9" X 1'
1 1/2" Radii 3/8" Border 3/8" Inset
1" Series D Legend
White Background
Black Legend & Border

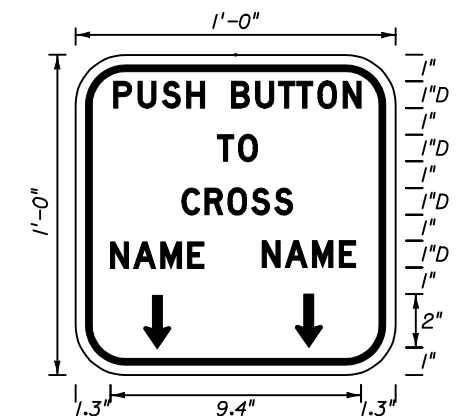

FTP-26-04
1' X 1'
1 1/2" Radii 3/8" Border 3/8" Inset
1" Series D Legend
White Background
Black Legend & Border

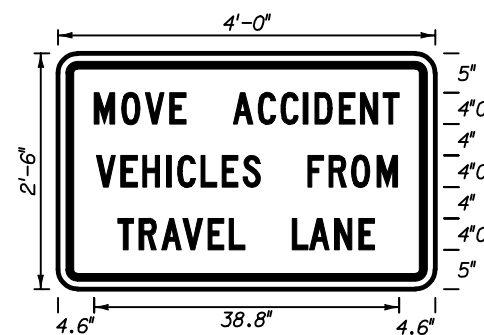

FTP-27-04
4' X 2'-6"
2" Radii 3/4" Border
4" Series C Legend
White Background
Black Legend & Border

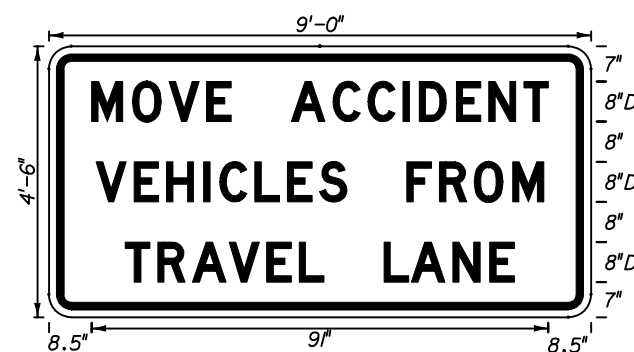

FTP-28-04
9' X 4'-6"
3" Radii 3/4" Border
8" Series D Legend
White Background
Black Legend & Border

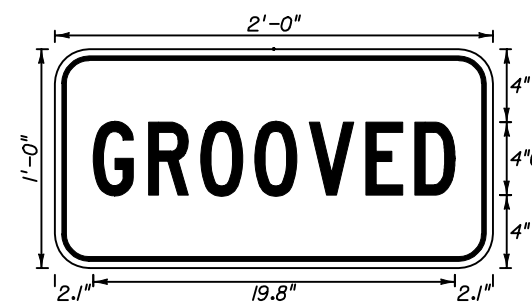

FTP-29-04
2' X 1'
1 1/2" Radii 5/8" Border 3/8" Inset
4" Series C Legend
Yellow Background
Black Legend & Border

STATE OF FLORIDA DEPARTMENT OF TRANSPORTATION				
SPECIAL SIGN DETAILS				
Designed By	Names	Dates	Approved By <i>Clark A. Scott</i> State Traffic Standards Engineer	
Drawn By			Revision	Sheet No. Index No.
Checked By			04	4 of 10 17355

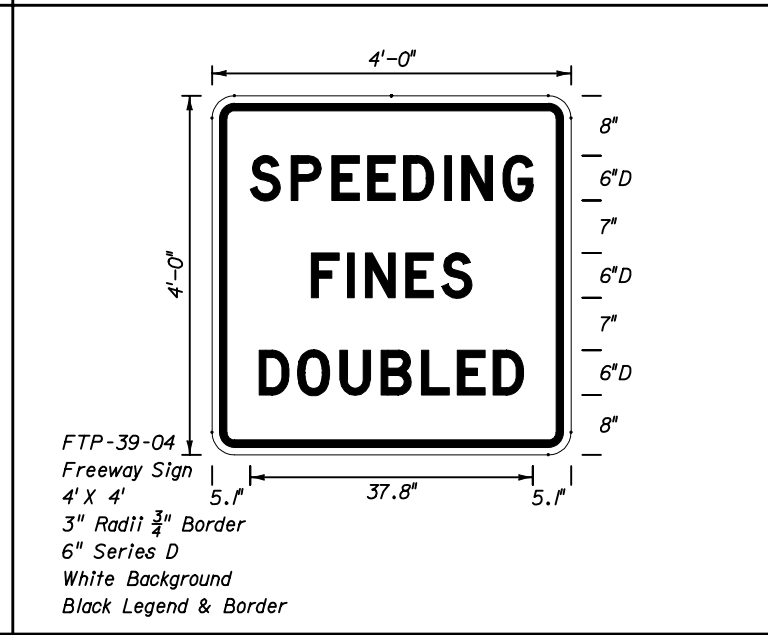
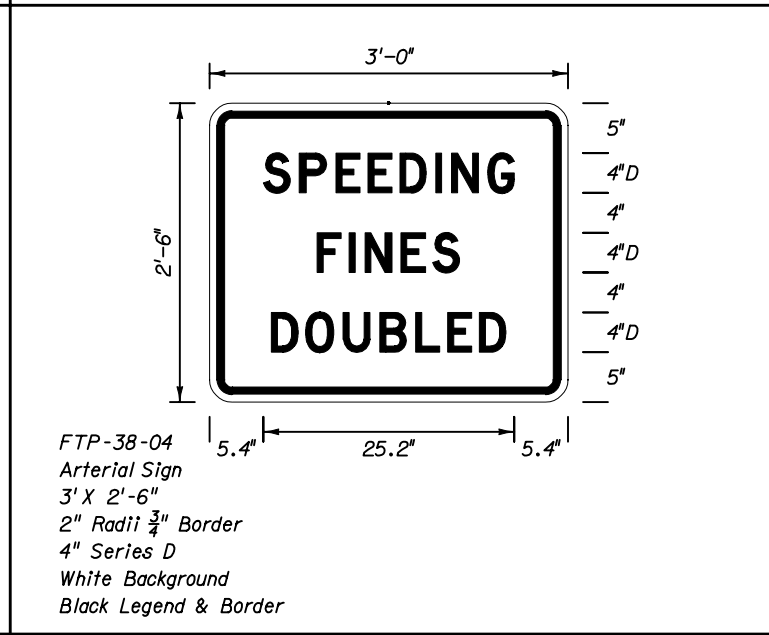
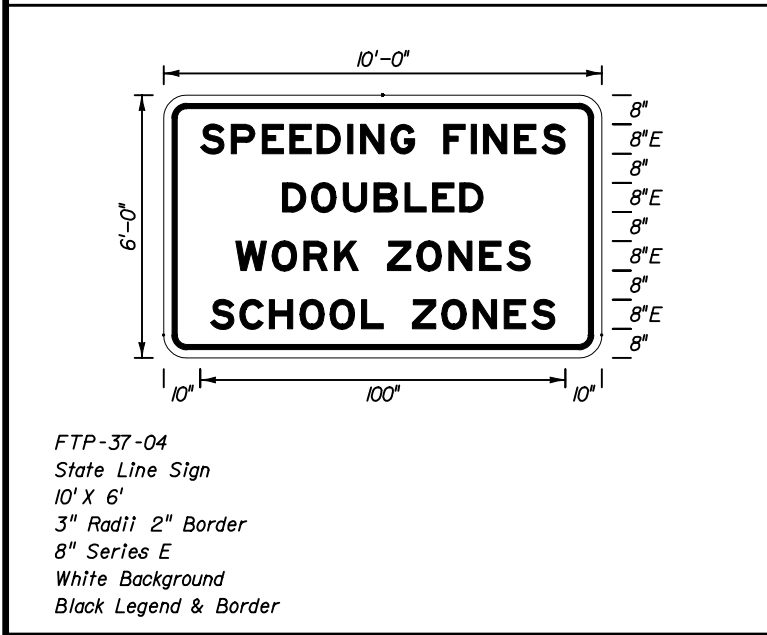
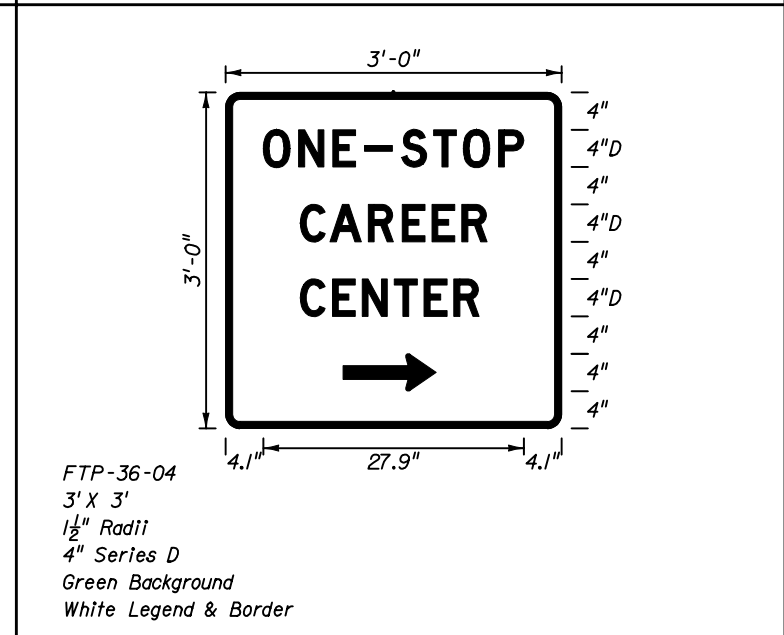
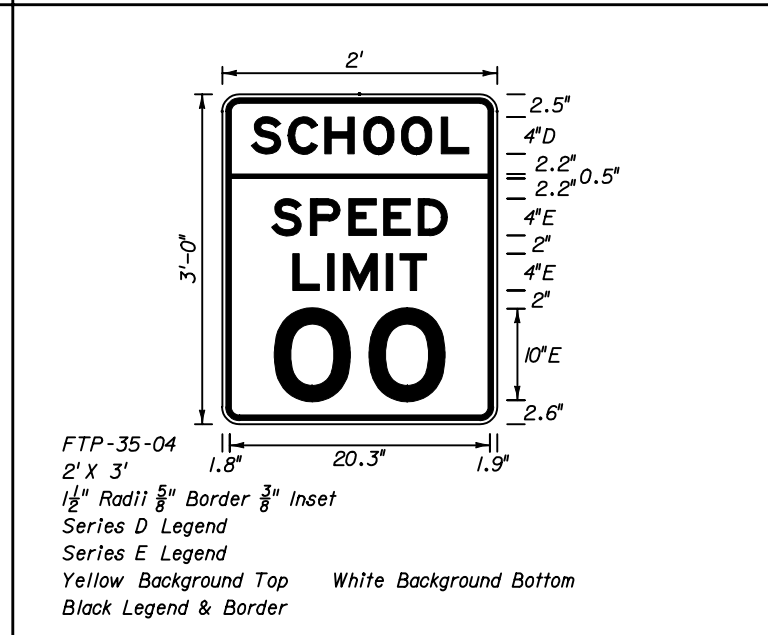
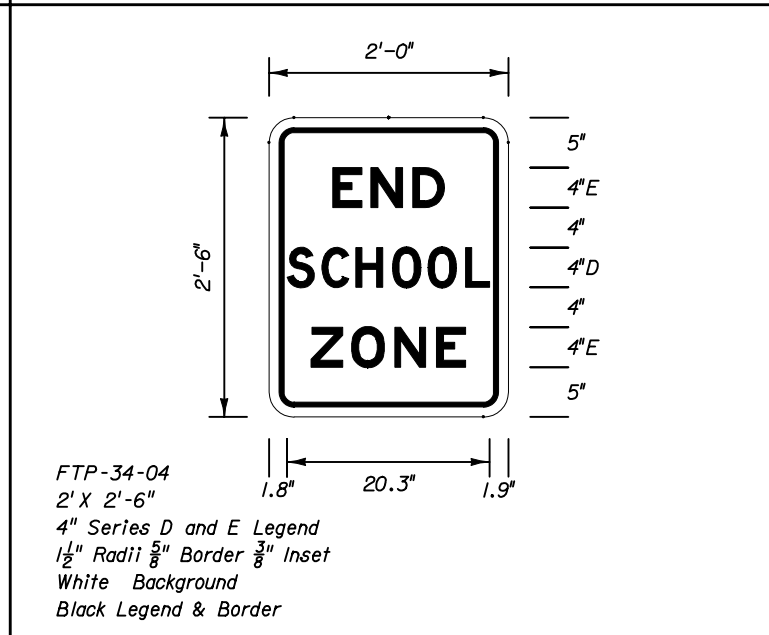
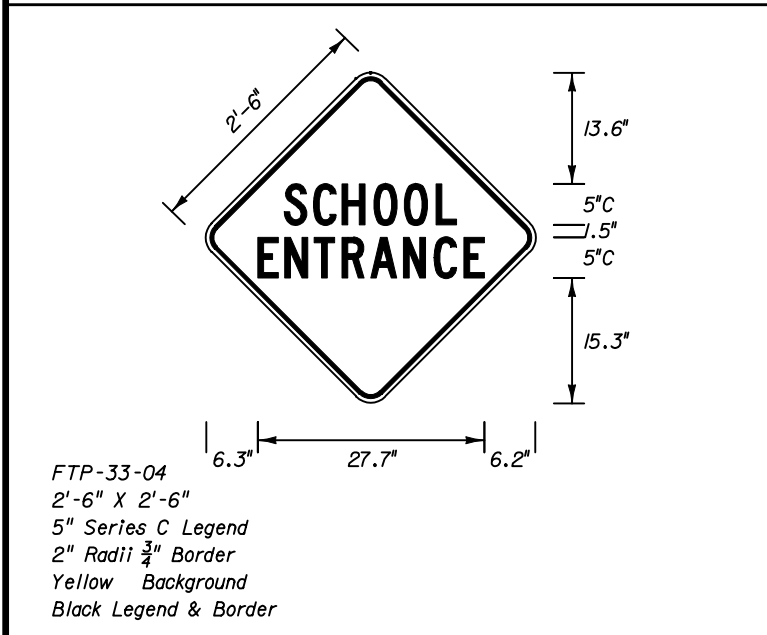
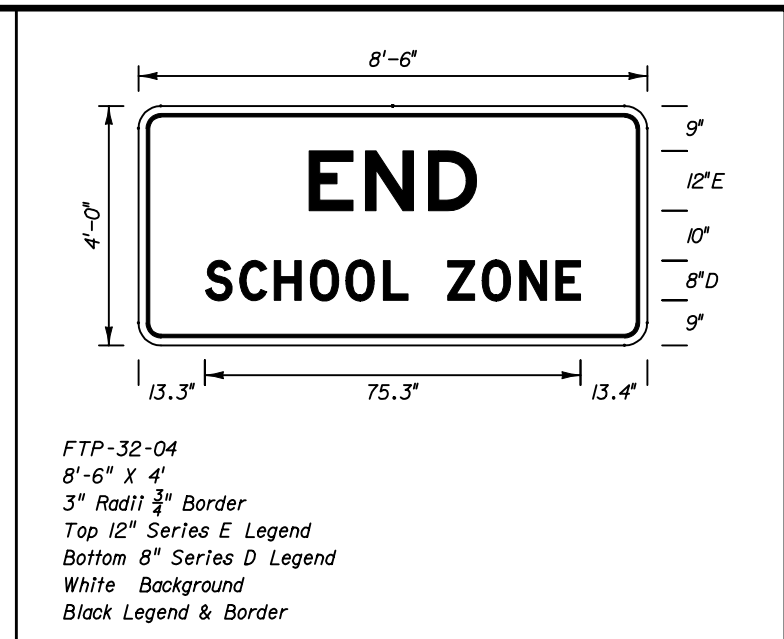
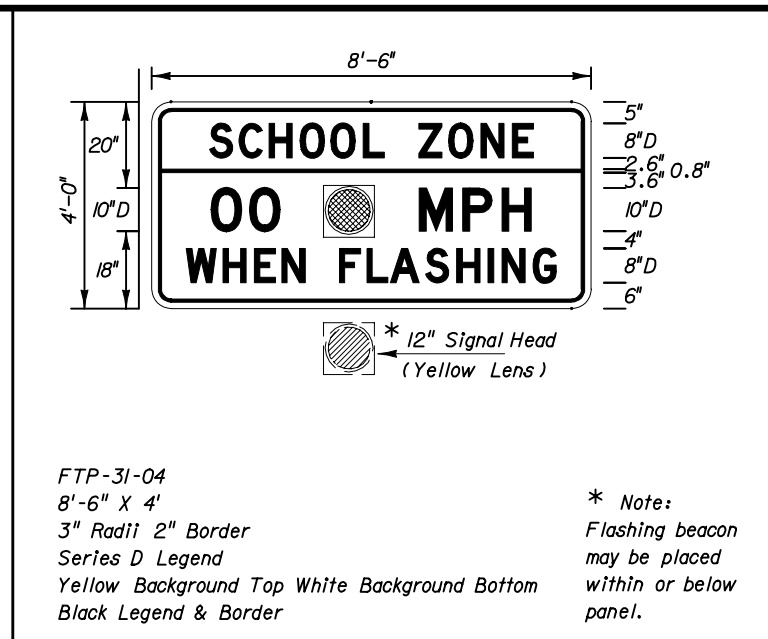
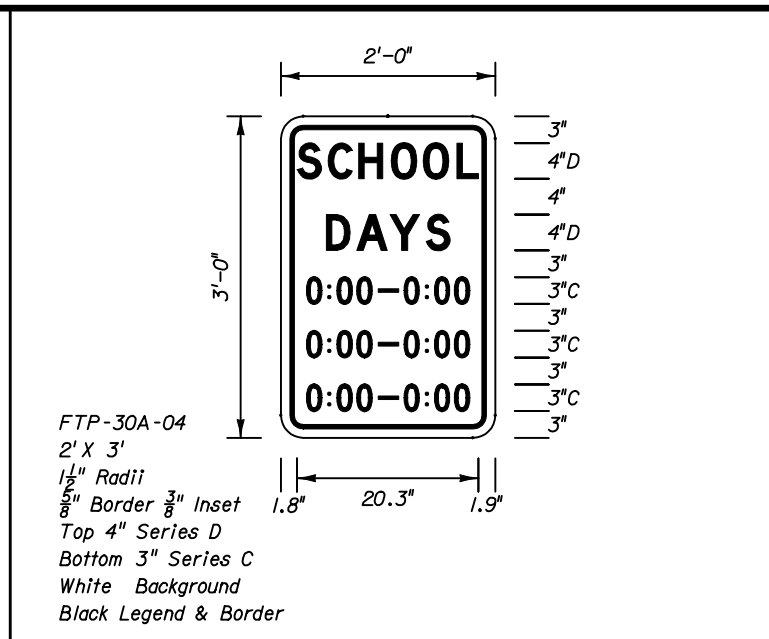
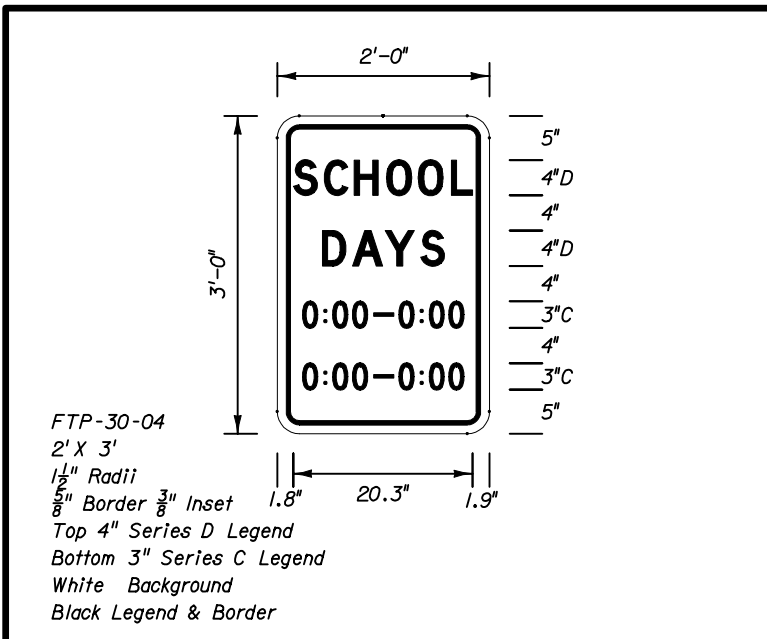

STATE OF FLORIDA DEPARTMENT OF TRANSPORTATION				
SPECIAL SIGN DETAILS				
Designed By	Names	Dates	Approved By <i>Charles A. Scott</i> State Traffic Standards Engineer	
Drawn By			Revision	Sheet No. Index No.
Checked By			04	5 of 10 17355



FTP-40-04
3'-6" X 4'
1 1/2" Radii 3/4" Border
3" Series C Legend
6" Series C Legend
White Background
Black Legend & Border



FTP-41-04
2'-6" X 3'
1 1/2" Radii 3/4" Border
2" Series C Legend
4" Series C Legend
White Background
Black Legend & Border

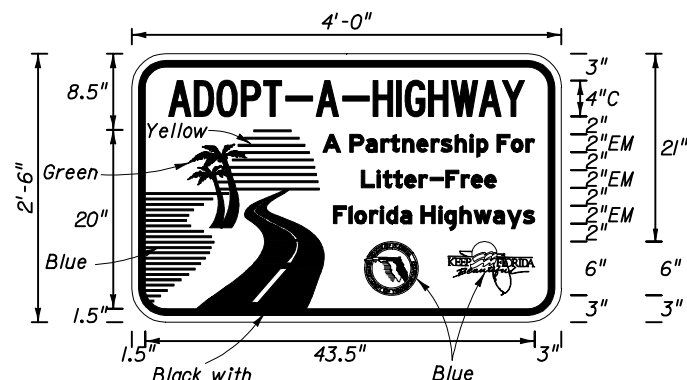

FTP-42-04
4' X 2'-6"
3" Radii
4" Series C Legend
2" Series EM Legend
White Background
Blue Legend & Border

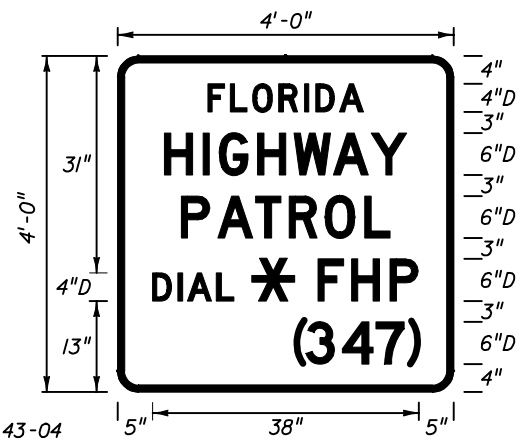

FTP-43-04
4' X 4'
3" Radii 1" Border
Series D Legend
Blue Background
White Legend & Border



FTP-44-04
9' X 6'
9" Radii 3/4" Border
8" Series D Legend
White Background
Black Legend & Border



FTP-45-04
4' X 3'
1 1/2" Radii 3/4" Border
4" Series C Legend
White Background
Black Legend & Border

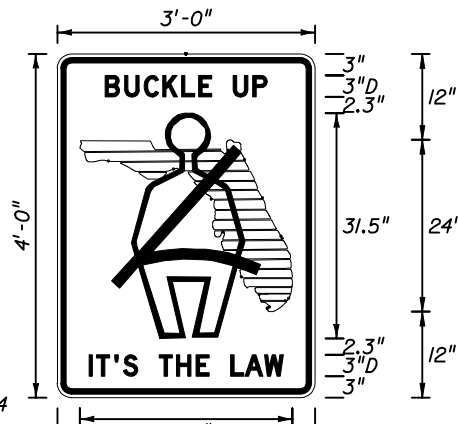

FTP-46-04
3' X 4'
1 1/2" Radii 3/4" Border
3" Series D Legend
White Background
Black Legend, Border & Man Belt Symbol
Florida Shield Green

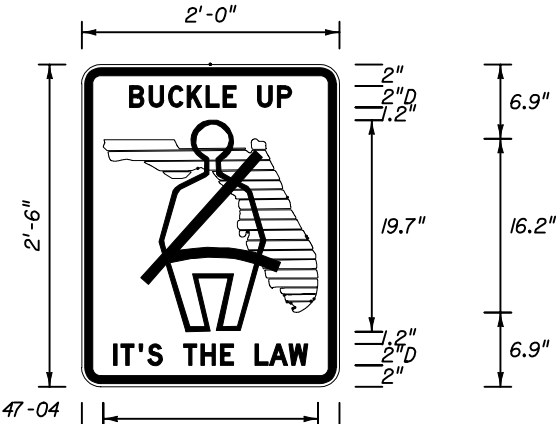

FTP-47-04
2' X 2'-6"
1 1/2" Radii 5/8" Border 3/8" Inset
2" Series D Legend
White Background
Black Legend, Border & Man Belt Symbol
Florida Shield Green



FTP-48-04
3'-6" X 5'
3" Radii
4" Series C Legend
Green Background
White Legend, Border & Symbol

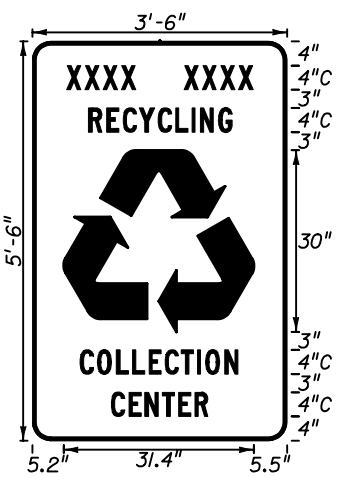

FTP-49-04
3'-6" X 5'-6"
3" Radii
4" Series C Legend
Green Background
White Legend, Border & Symbol
Municipality Name Optional

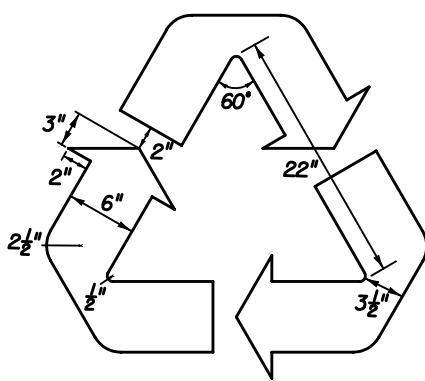

DETAIL for FTP-48-04 and FTP-49-04

STATE OF FLORIDA DEPARTMENT OF TRANSPORTATION				
SPECIAL SIGN DETAILS				
Designed By	Names	Dates	Approved By	
Drawn By			 State Traffic Standards Engineer	
Checked By			Revision	Sheet No. / Index No.
			04	6 of 10 / 17355

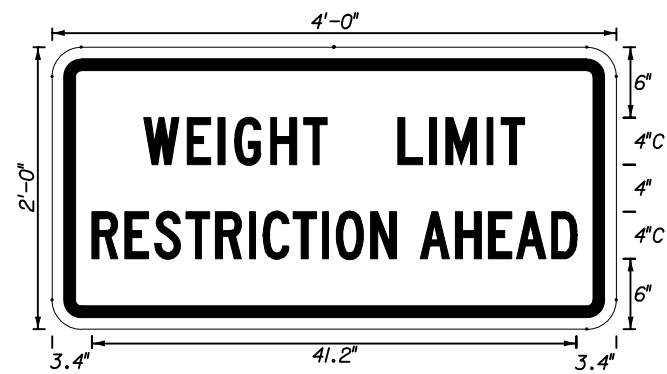

FTP-50-04
4' X 2'
1/2" Radii 3/4" Border
4" Series C Legend
Yellow Background
Black Legend & Border

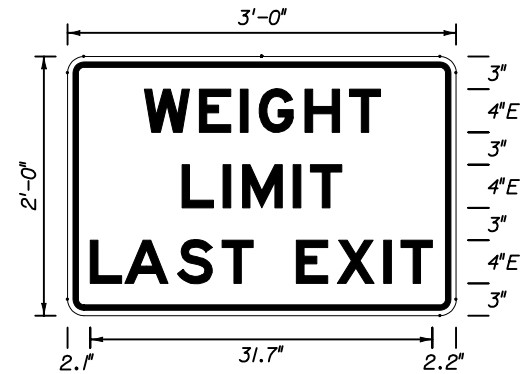

FTP-51-04
3' X 2'
1/2" Radii 3/4" Border
4" Series E Legend
White Background
Black Legend & Border

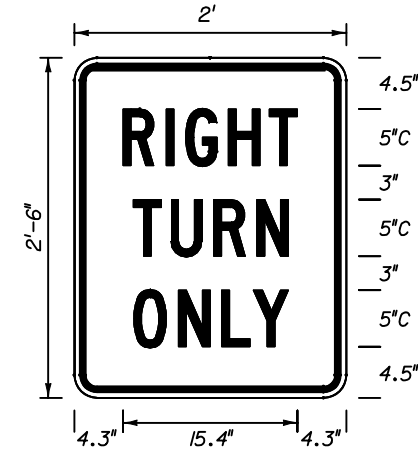

FTP-52-04
2' X 2'-6"
1/2" Radii 5/8" Border 3/8" Inset
5" Series C Legend
White Background
Black Legend & Border

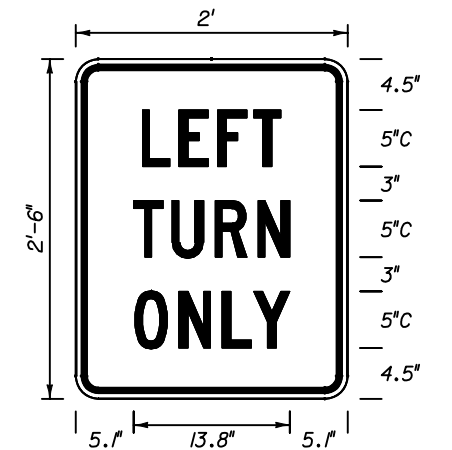

FTP-53-04
2' X 2'-6"
1/2" Radii 5/8" Border 3/8" Inset
5" Series C Legend
White Background
Black Legend & Border

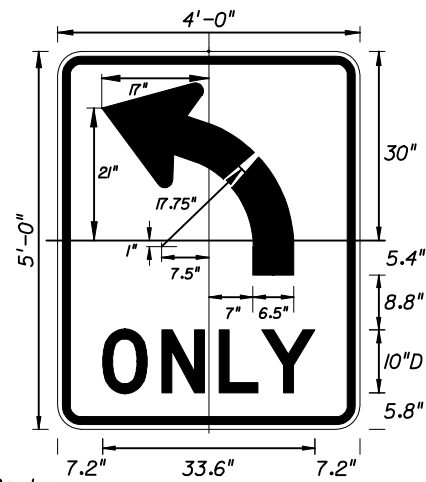

FTP-54-04
4' X 5'
3" Radii 3/4" Border
10" Series D Legend
White Background
Black Legend & Border

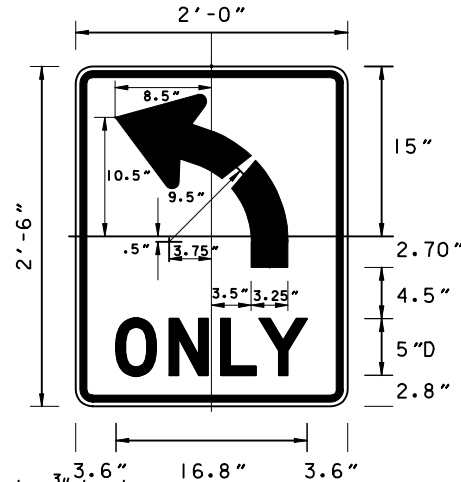

FTP-55-04
2' X 2'-6"
1/4" Radii 5/8" Border 3/8" Inset
5" Series D Legend
White Background
Black Legend & Border

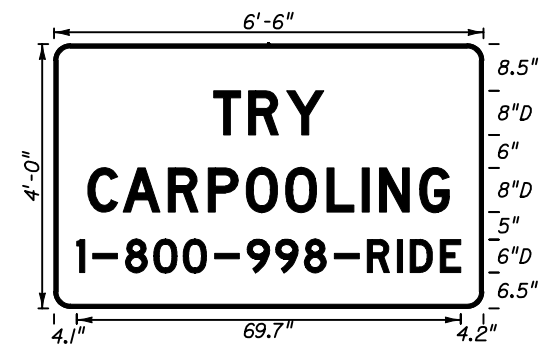

FTP-56-04
6'-6" X 4'
3" Radii
8" Series D Legend
6" Series D Legend
Blue Background
White Legend & Border

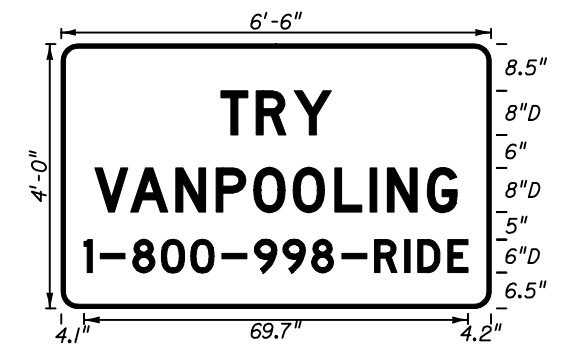

FTP-57-04
6'-6" X 4'
3" Radii
8" Series D Legend
6" Series D Legend
Blue Background
White Legend & Border

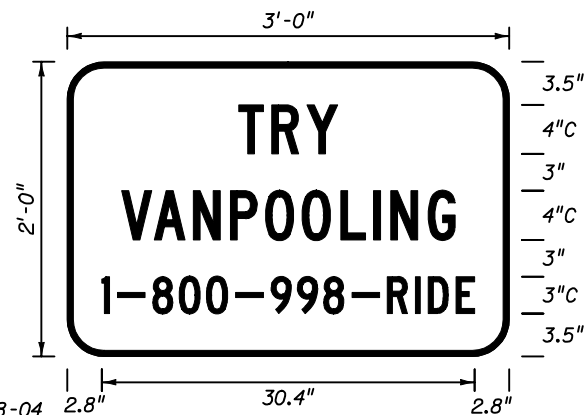

FTP-58-04
3' X 2'
3" Radii
4" Series C Legend
3" Series C Legend
Blue Background
White Legend & Border

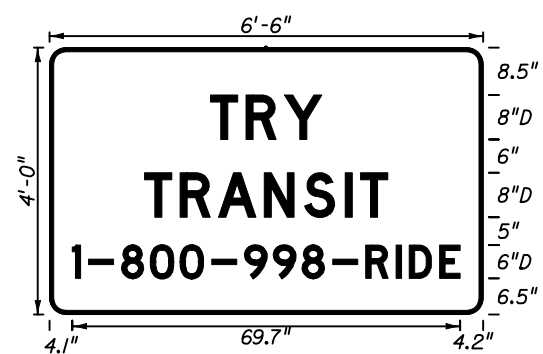

FTP-59-04
6'-6" X 4'
3" Radii
8" Series D Legend
6" Series D Legend
Blue Background
White Legend & Border

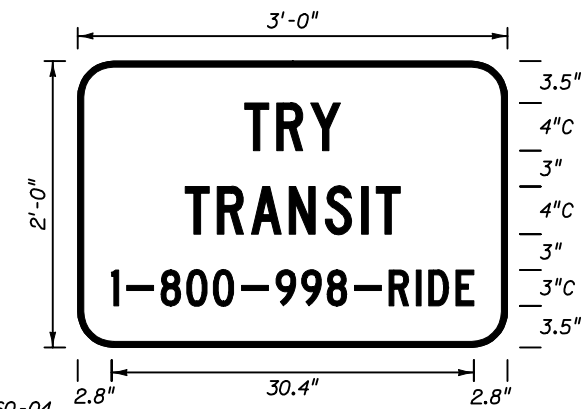

FTP-60-04
3' X 2'
3" Radii
4" Series C Legend
3" Series C Legend
Blue Background
White Legend & Border

STATE OF FLORIDA DEPARTMENT OF TRANSPORTATION				
SPECIAL SIGN DETAILS				
Names	Dates	Approved By		
Designed By		 State Traffic Standards Engineer		
Drawn By		Revision	Sheet No.	Index No.
Checked By		04	7 of 10	17355

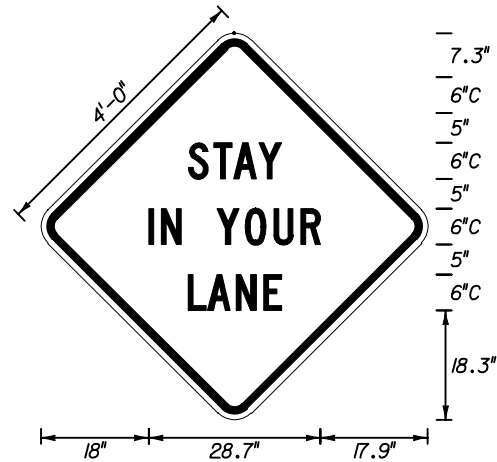

MOT-1-04
4' X 4'
3" Radii 3/4" Border
6" Series C Legend
Orange Background
Black Legend & Border

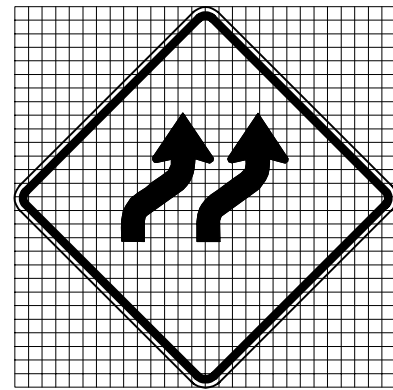

MOT-2-04
4' X 4'
3" Radii 3/4" Border
Grid = 2" X 2"
Orange Background
Black Arrows & Border

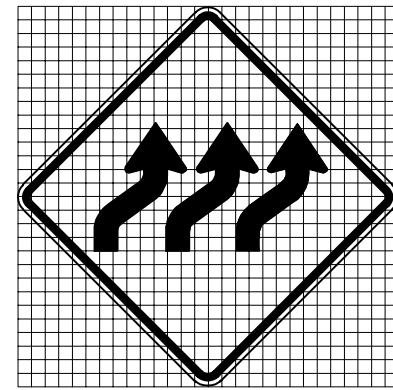

MOT-3-04
4' X 4'
3" Radii 3/4" Border
Grid = 2" X 2"
Orange Background
Black Arrows & Border

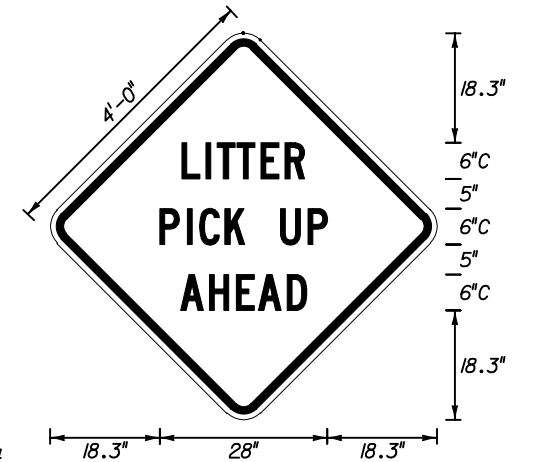

MOT-4-04
4' X 4'
3" Radii 3/4" Border
6" Series C Legend
Orange Background
Black Arrows & Border

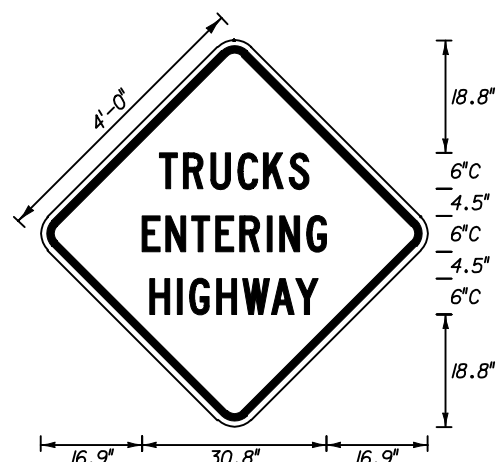

MOT-5-04
4' X 4'
3" Radii 3/4" Border
6" Series C Legend
Orange Background
Black Legend & Border

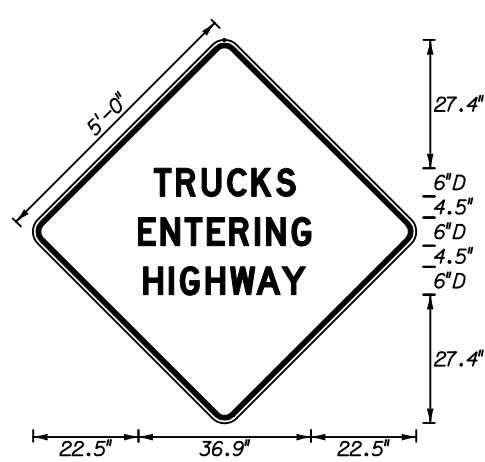

MOT-6-04
5' X 5'
3" Radii 1" Border
6" Series D Legend
Orange Background
Black Legend & Border

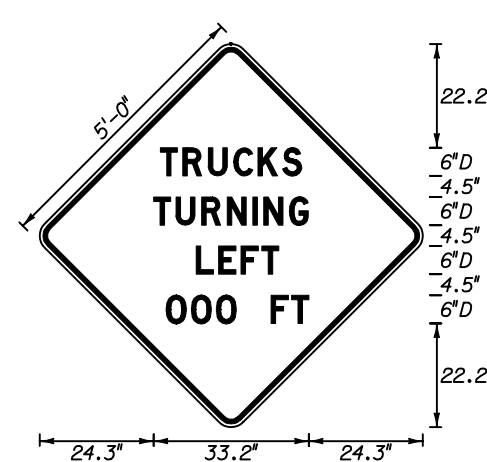

MOT-7-04
5' X 5'
3" Radii 1" Border
6" Series D Legend
Orange Background
Black Legend & Border

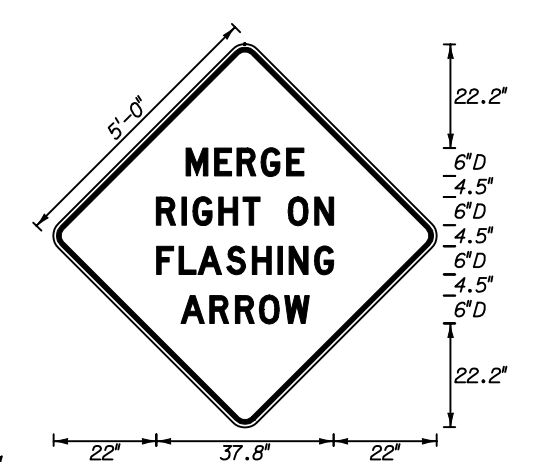

MOT-8-04
5' X 5'
3" Radii 1" Border
6" Series D Legend
Orange Background
Black Legend & Border

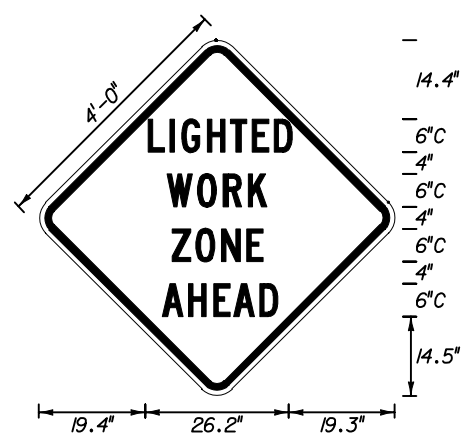

MOT-9-04
4' X 4'
3" Radii 3/4" Border
6" Series C Legend
Orange Background
Black Legend & Border

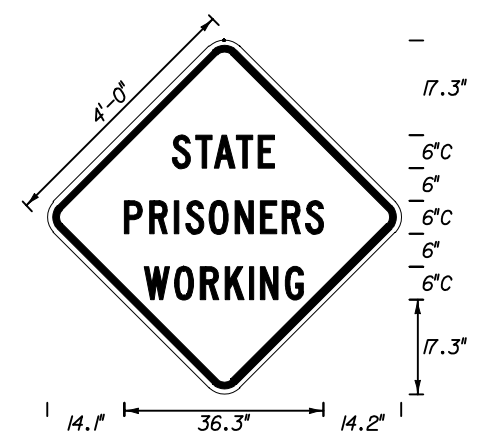

MOT-10-04
4' X 4'
3" Radii 3/4" Border
6" Series C Legend
Orange Background
Black Legend & Border

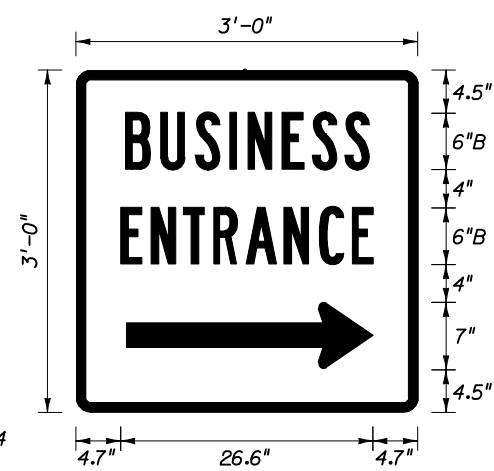

MOT-11-04
3' X 3'
1 1/2" Radii 3/4" Border
6" Series B Legend
Blue Background
White Legend & Border

STATE OF FLORIDA DEPARTMENT OF TRANSPORTATION				
SPECIAL SIGN DETAILS (MAINTENANCE OF TRAFFIC)				
Designed By	Names	Dates	Approved By <i>Charles A. Scott</i> State Traffic Standards Engineer	
Drawn By			Revision	Sheet No. Index No.
Checked By			04	9 of 10 17355

