

FTP - 1
2' X 2'-6"
1 1/2" Radii 3/4" Border
5" Series C Legend
White Background
Black Legend & Border

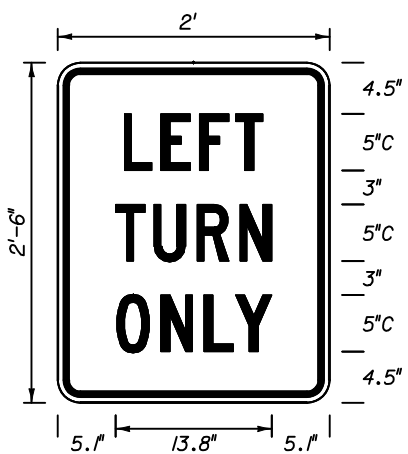

FTP - 2
2' X 2'-6"
1 1/2" Radii 3/4" Border
5" Series C Legend
White Background
Black Legend & Border

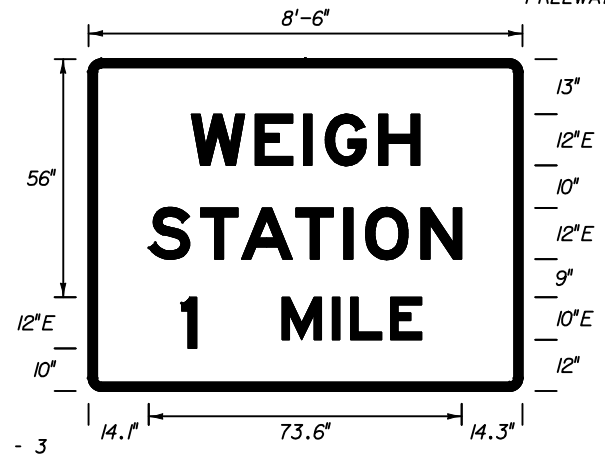

FTP - 3
8'-6" X 5'-6"
3" Radii 2" Border
Series E Legend
Green Background
White Legend & Border

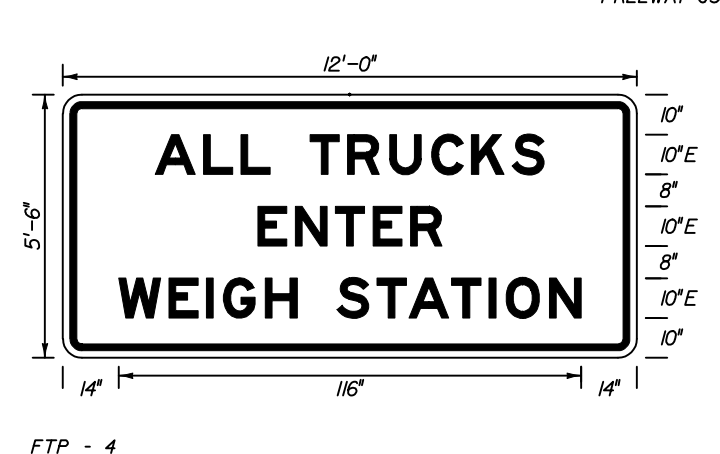

FTP - 4
12' X 5'-6"
3" Radii 2" Border
10" Series E Legend
White Background
Black Legend & Border

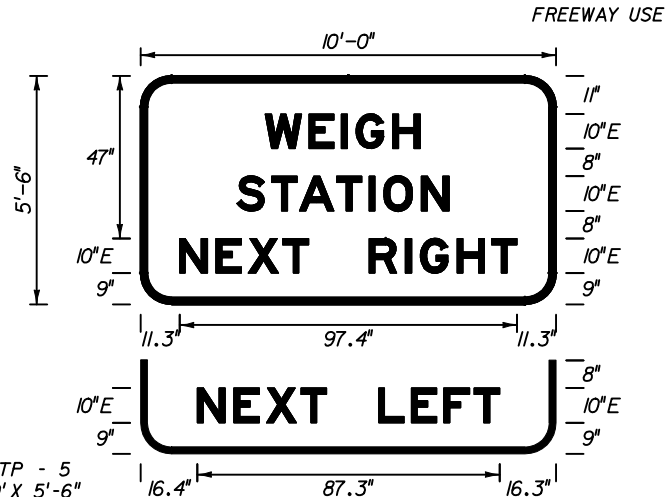

FTP - 5
10' X 5'-6"
3" Radii 2" Border
10" Series E Legend
Green Background
White Legend & Border

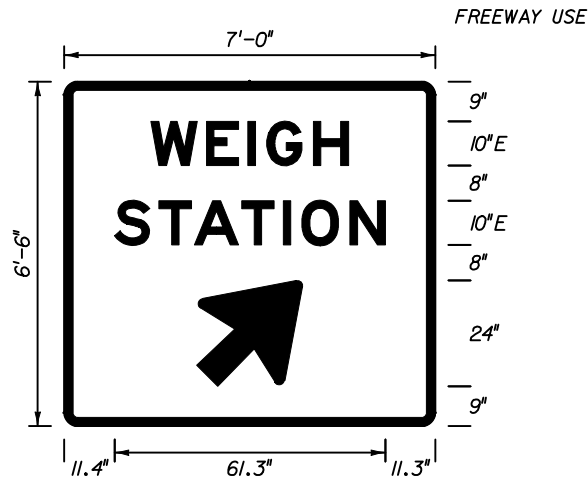

FTP - 6
7' X 6'-6"
3" Radii 2" Border
10" Series E Legend
Green Background
White Legend & Border

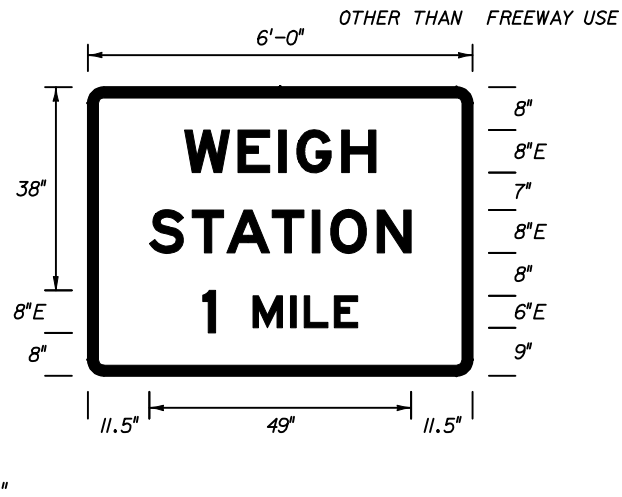

FTP - 7
6' X 4'-6"
3" Radii 2" Border
Series E Legend
Green Background
White Legend & Border

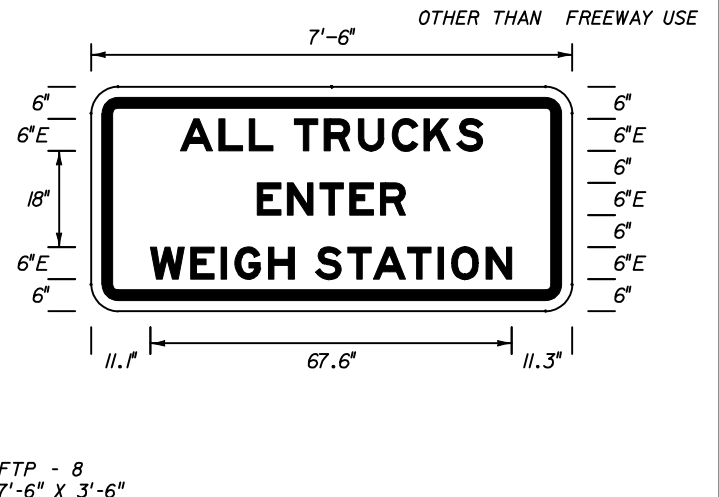

FTP - 8
7'-6" X 3'-6"
3" Radii 2" Border
6" Series E Legend
White Background
Black Legend & Border

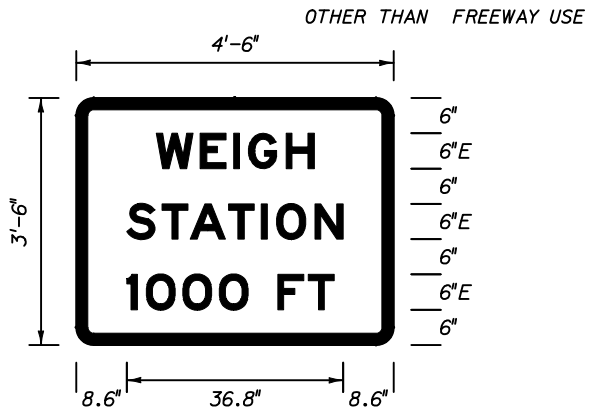

FTP - 9
4'-6" X 3'-6"
3" Radii 2" Border
6" Series E Legend
Green Background
White Legend & Border

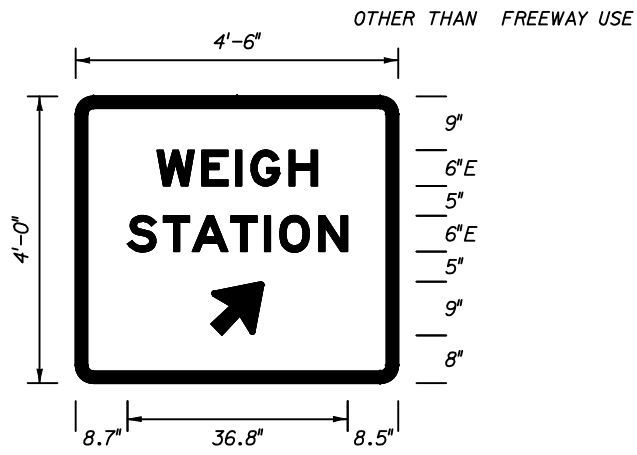

FTP - 10
4'-6" X 4'-0"
3" Radii 2" Border
6" Series E Legend
Green Background
White Legend & Border
FTP - 10A - Right Arrow
FTP - 10B - Left Arrow

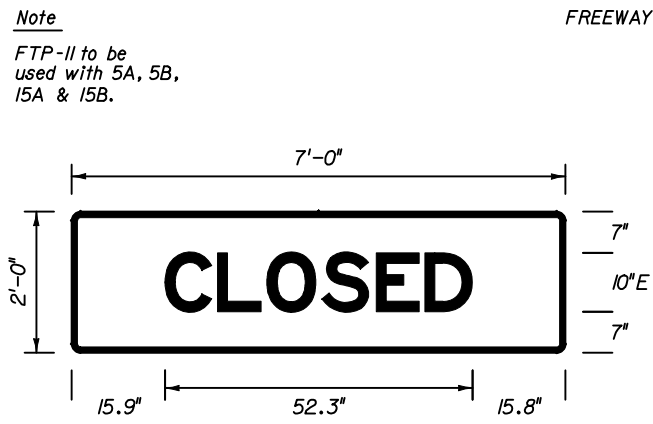

Note
FTP-11 to be used with 5A, 5B, 15A & 15B.
FTP - 11
7' X 2'
1 1/2" Radii 2" Border
10" Series E Legend
Green Background
White Legend & Border

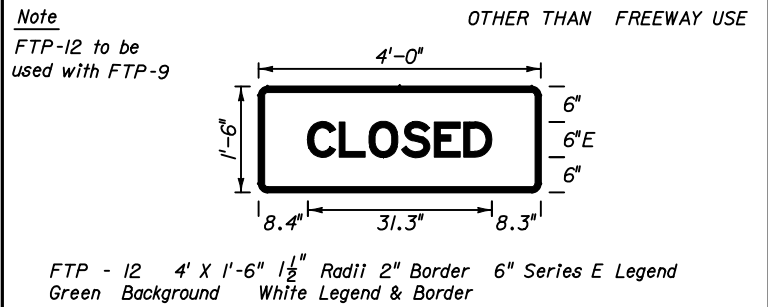

Note
FTP-12 to be used with FTP-9
FTP - 12
4' X 1'-6"
1 1/2" Radii 2" Border
6" Series E Legend
Green Background
White Legend & Border

STATE OF FLORIDA DEPARTMENT OF TRANSPORTATION				
SPECIAL SIGN DETAILS				
Designed By	Names	Dates	Approved By <i>Charles Scott</i>	
Drawn By			State Traffic Standards Engineer	
Checked By			Revision	Sheet No. Index No.
			00	1 of 14 17355

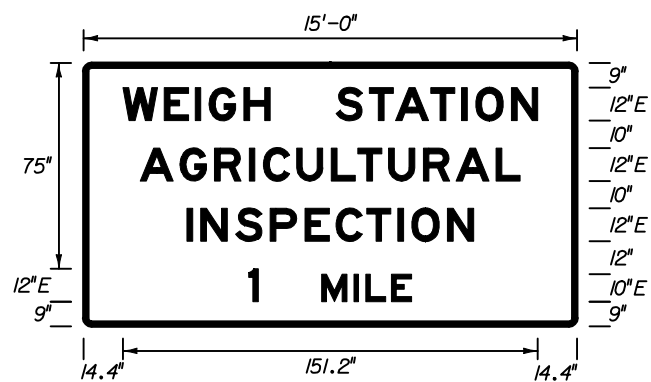

FTP - 13
15' X 8'
3" Radii 2" Border
Series E Legend
Green Background
White Legend & Border

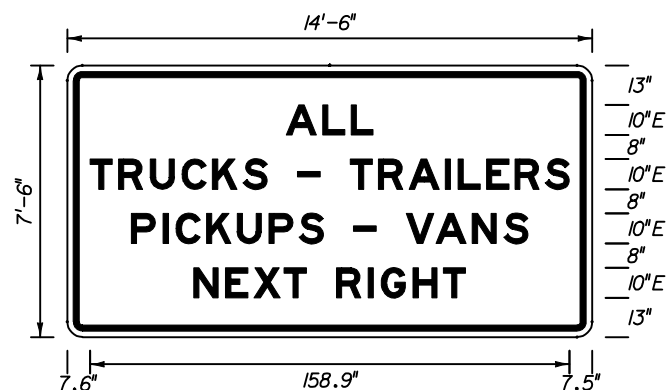

FTP - 14A
14'-6" X 7'-6"
3" Radii 2" Border
10" Series E Legend
White Background
Black Legend & Border
On Interstate Station,
Delete Pickups-Vans,
and reduce Sign height
accordingly.



FTP - 14B
14'-6" X 7'-6"
3" Radii 2" Border
10" Series E Legend
White Background
Black Legend & Border

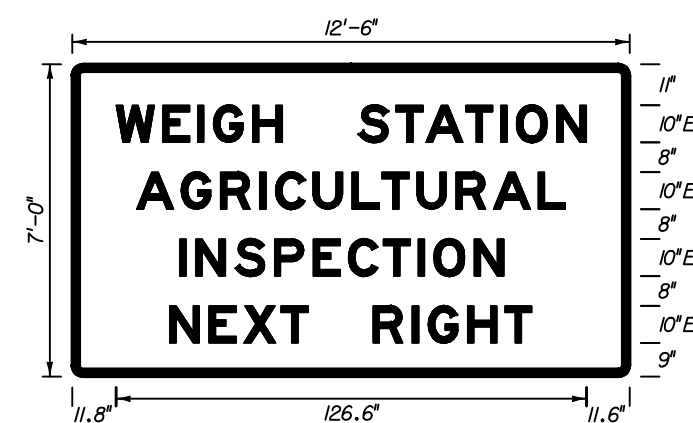

FTP - 15A
12'-6" X 7'
3" Radii 2" Border
10" Series E Legend
Green Background
White Legend & Border



FTP - 15B
12'-6" X 7'
3" Radii 2" Border
Series E Legend
Green Background
White Legend & Border

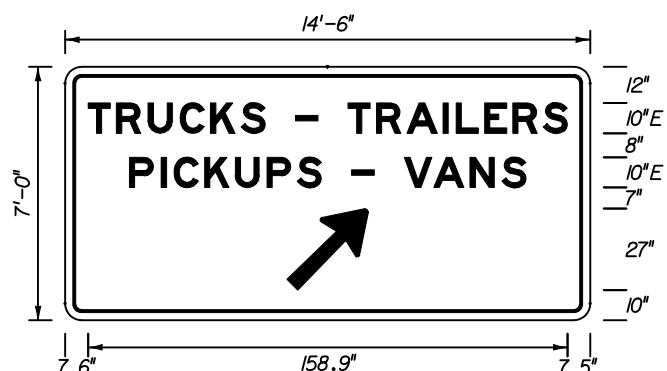

FTP - 16
14'-6" X 7'
3" Radii 2" Border
Series E Legend
Blue Background
White Legend & Border
FTP - 16A - RIGHT ARROW
FTP - 16B - LEFT ARROW

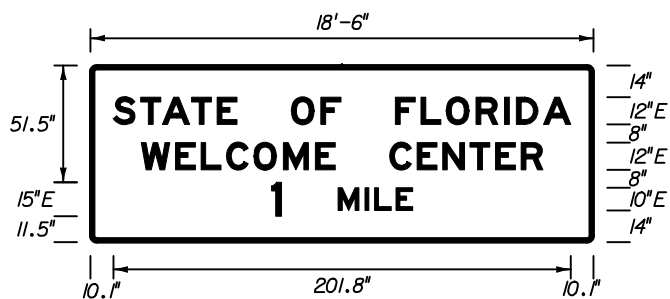

FTP - 17
18'-6" X 6'-6"
3" Radii 2" Border
Series E Legend
Blue Background
White Legend & Border

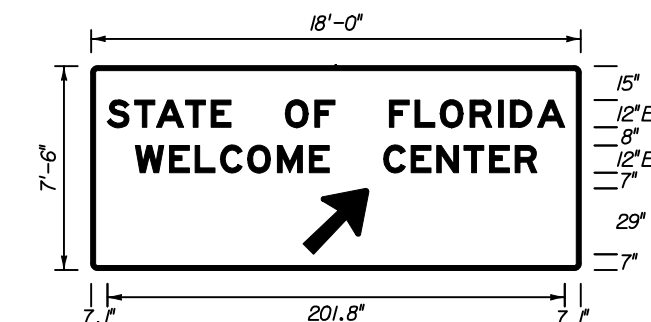

FTP - 18
18' X 7'-6"
3" Radii 2" Border
Series E Legend
Blue Background
White Legend & Border

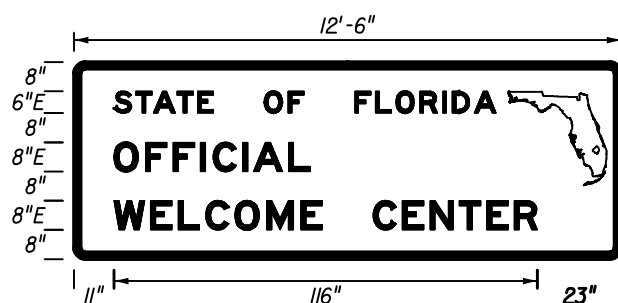

FTP - 19
12'-6" X 4'-6"
3" Radii 2" Border
Series E Legend
Blue Background
White Legend & Border



FTP - 20
6'-6" X 5'-6"
3" Radii 2" Border
Series E Legend
Blue Background
White Legend & Border

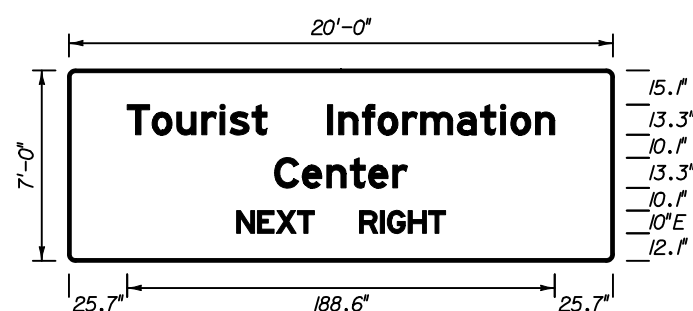

FTP - 21
20' X 7'
3" Radii 2" Border
Blue Background
White Legend & Border

STATE OF FLORIDA DEPARTMENT OF TRANSPORTATION				
SPECIAL SIGN DETAILS				
Designed By	Names	Dates	Approved By <i>Charles A. Scott</i>	
Drawn By			State Traffic Standards Engineer	
Checked By			Revision	Sheet No. Index No.
			00	2 of 14 17355

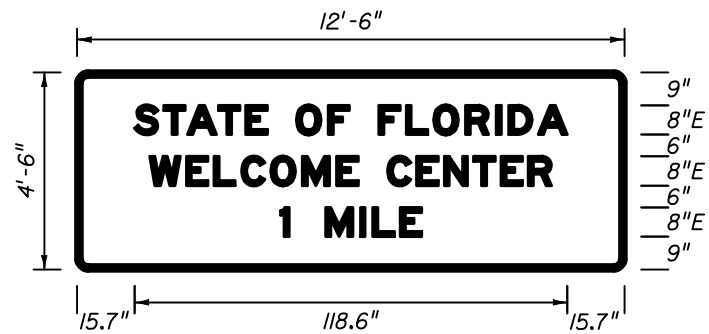

FTP - 22A
12'-6" X 4'-6"
3" Radii 2" Border
8" Series E Legend
Blue Background
White Legend & Border

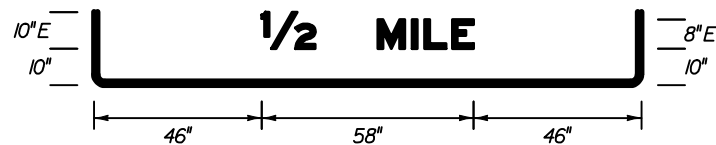

FTP - 22B
12'-6" X 5'
3" Radii 2" Border
8" Series E Legend
Blue Background
White Legend & Border

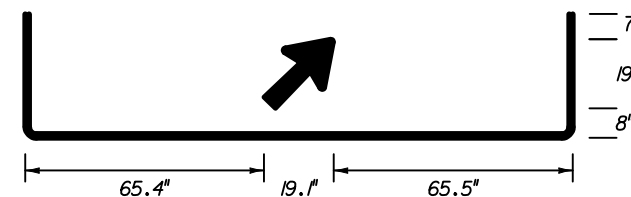

FTP - 23
12'-6" X 5'-6"
3" Radii 2" Border
Blue Background
White Legend & Border



FTP - 24
1' X 1'-6"
1/2" Radii 3/4" Border
White Background
Green Legend & Border

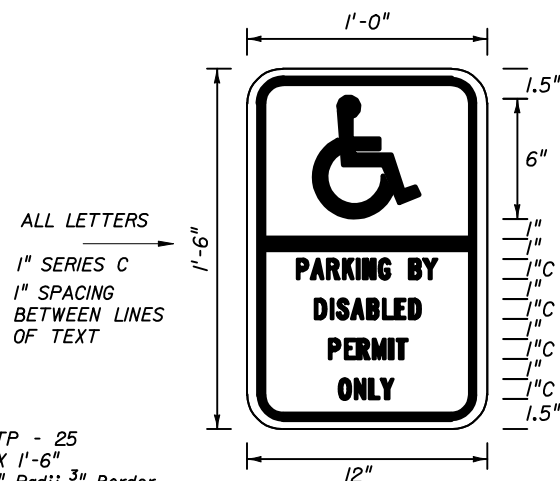

FTP - 25
1' X 1'-6"
1/2" Radii 3/4" Border
1" Series C Legend
Color
Background
Legend and Border

Top Blue
Bottom White
Background White
Legend and Border Black

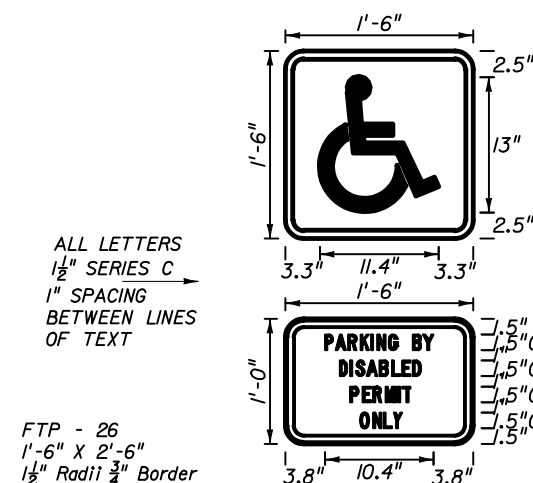

FTP - 26
1'-6" X 2'-6"
1/2" Radii 3/4" Border
1/2" Series C Legend
Color
Background
Legend and Border

Top Blue
Bottom White
Background White
Legend and Border Black

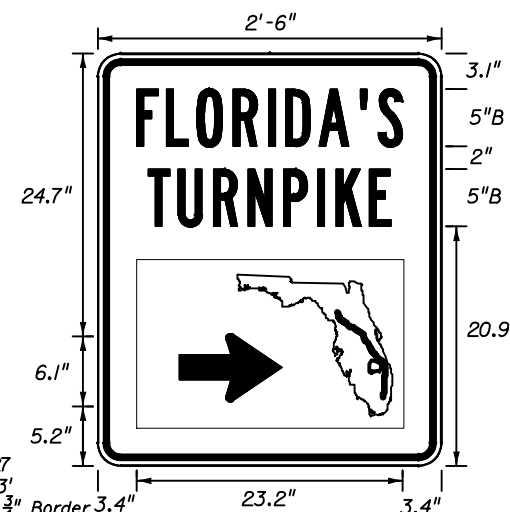

FTP - 27
2'-6" X 3'
1/2" Radii 3/4" Border 3.4"
Green Background
White Legend & Border

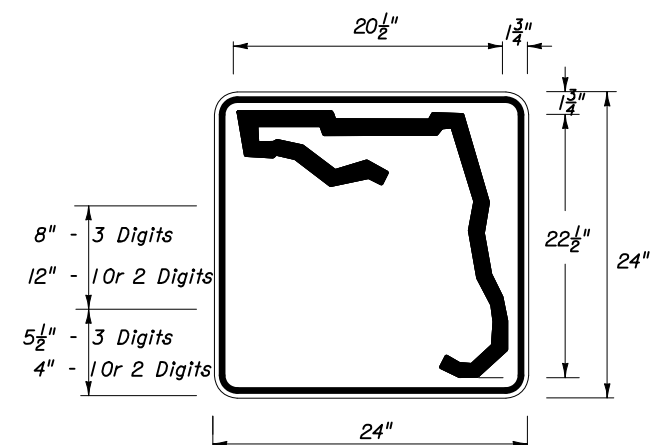

FTP - 28
2' X 2'
1/2" Radii 3/4" Border
White Background
Black Legend & Border

See Sheet 4 For Additional Details



FTP - 29
2'-6" X 2'-6"
Blue Background
Yellow Legend & Border

SEE SHEET 4 FOR DETAILS.

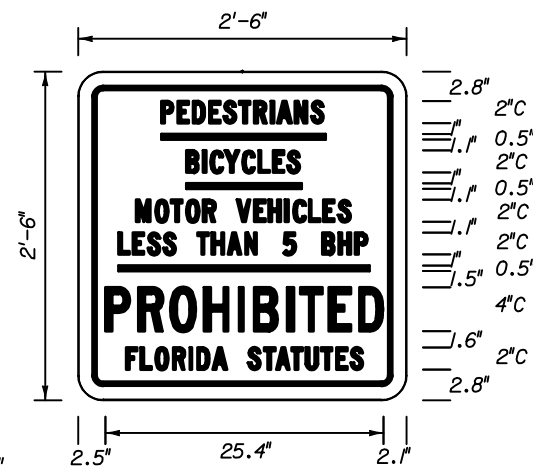

* 2" Series C
** 4" Series C

FTP - 30
2'-6" X 2'-6"
1/2" Radii 3/4" Border
White Background
Black Legend & Border

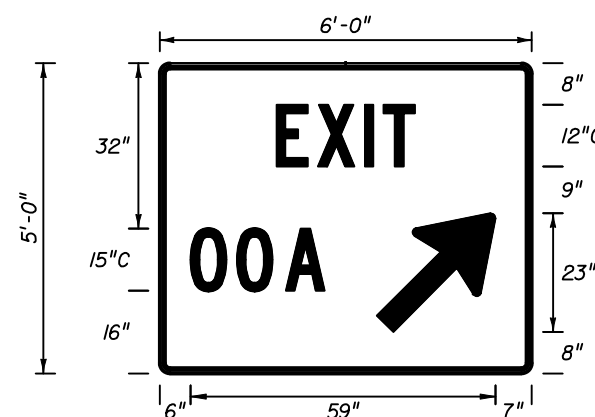

FTP - 31
6' X 5'
3" Radii 2" Border
Series C Legend
Green Background
White Legend & Border

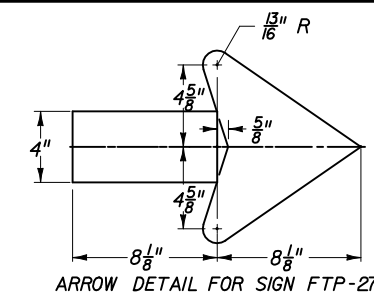

ARROW DETAIL FOR SIGN FTP-27

STATE OF FLORIDA DEPARTMENT OF TRANSPORTATION

SPECIAL SIGN DETAILS

Names	Dates	Approved By <i>Charles A. Scott</i>		
Designed By		State Traffic Standards Engineer		
Drawn By		Revision	Sheet No.	Index No.
Checked By		00	3 of 14	17355

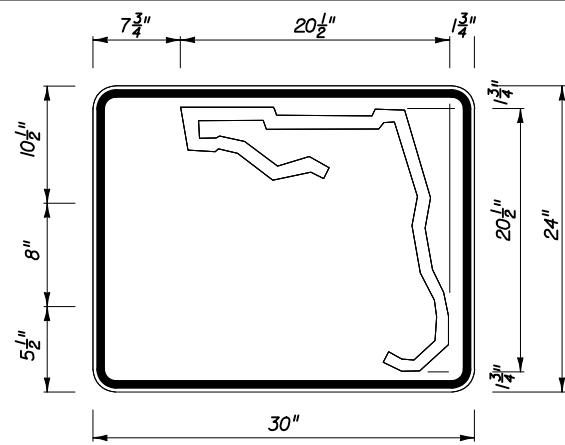

3 or 4 DIGITS

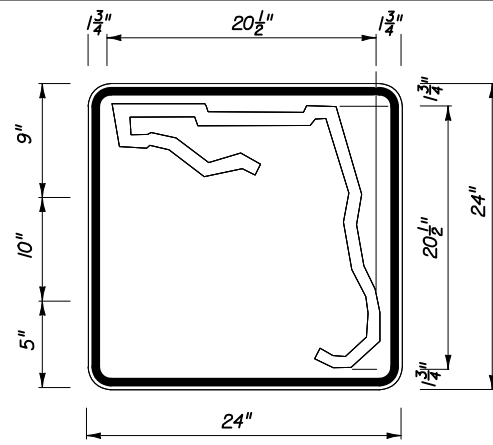

1 or 2 DIGITS

DIGITS	NUMERAL SIZE	SERIES	PANEL SIZE
1-2	10"	D	24" x 24"
3	8"	C	24" x 30"
4	8"	C	24" x 30"

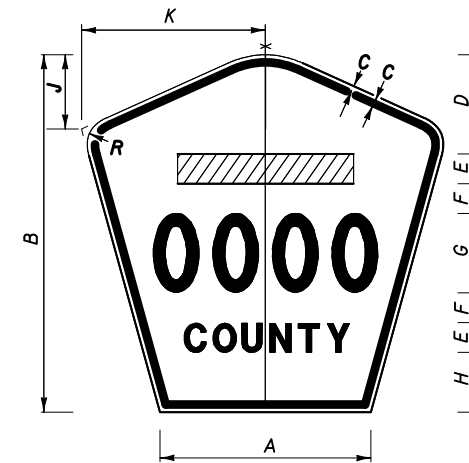

- Notes :
- All Legend Series "D".
 - Color: Yellow Legend and Border on Blue Background.
 - When used on a guide sign, marker must be overlaid on a rectangular Yellow Background as shown in chart. **

INDEPENDENT USE OTHER THAN FREEWAY

SIGN	DIMENSIONS												**
	A	B	C	D	E	F	G	H	J	K	R	S	
1 & 2 DIGIT POST MOUNTED	14 3/16"	24"	1/2"	5"	2"	2"	8"	3"	5 1/8"	12 3/8"	1 1/4"	5 5/8"	
3 DIGIT POST MOUNTED	17 3/4"	30"	1/2"	7 1/4"	2 1/2"	2 1/2"	8"	4 3/4"	6 1/2"	15 1/2"	1 1/4"	6 5/8"	
4 DIGIT POST MOUNTED	21 1/4"	36"	1/2"	8"	3"	3"	8"	8"	7 1/2"	18 1/2"	1 3/8"	7 1/2"	
2 DIGIT OVERHEAD	21 1/4"	36"	3/4"	8"	3"	3"	12"	4"	7 1/2"	18 1/2"	1 3/8"	7 1/2"	*** 40" x 41"
3 DIGIT OVERHEAD	29 1/4"	36"	3/4"	8"	3"	3"	12"	4"	8"	21 3/8"	2 1/4"	8 1/4"	*** 40" x 44"
4 DIGIT OVERHEAD	36 3/4"	42"	3/4"	11"	3"	3"	12"	7"	10 1/2"	26"	2 1/4"	8 1/2"	*** 42" x 52"

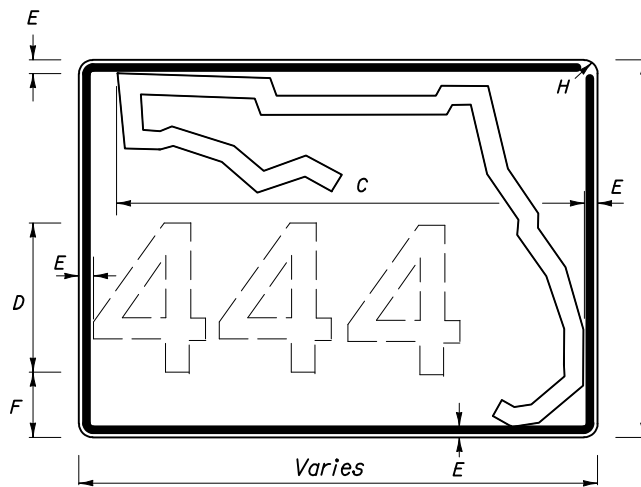

3 OR MORE DIGITS

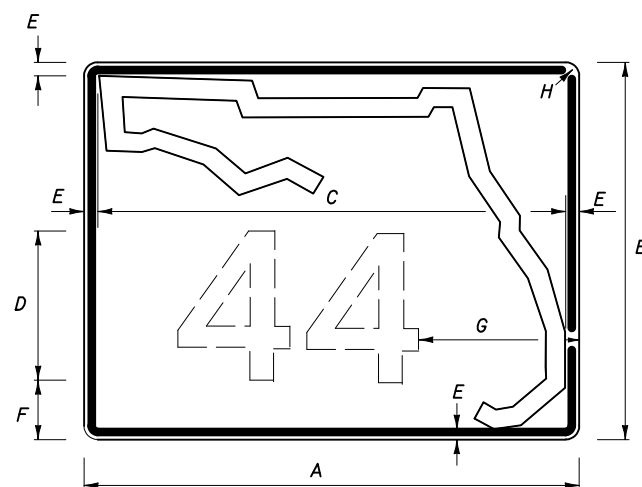

1 OR 2 DIGITS

A	B	C	D	E	F	G	H
30"	24"	26"	12"	1 1/4"	2 3/4"	8 1/4"	1 1/4"
36"	30"	32"	15"	1 1/4"	3 1/4"	8 3/4"	1 1/4"
42"	36"	38"	15"	1 1/4"	6 1/4"	11"	1 1/4"

GUIDE SIGN USE

- Notes: 1. Florida marker shall have Black Legend with White Background.
 2. Stroke width of State outline to be 1" for independent use and 1/4" for Guide Sign.
 3. Numbers are series D.

FLORIDA ROUTE MARKER
FTP - 28

COUNTY ROUTE MARKER DETAIL
FTP - 29

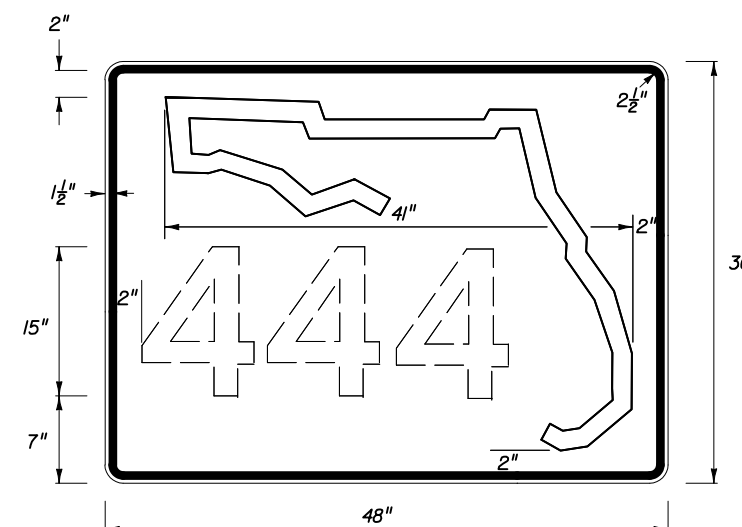

1-3 DIGITS 15" SERIES C
 4 DIGITS 12" SERIES C
 INDEPENDENT USE FOR FREEWAY

STATE OF FLORIDA DEPARTMENT OF TRANSPORTATION				
SPECIAL SIGN DETAILS				
Names	Dates	Approved By		
Designed By		 State Traffic Standards Engineer		
Drawn By		Revision	Sheet No.	Index No.
Checked By		00	4 of 14	17355

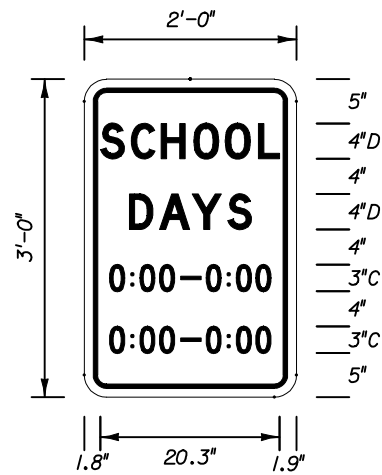

FTP - 32
2' X 3'
1 1/2" Radii 3/4" Border
White Background
Black Legend & Border

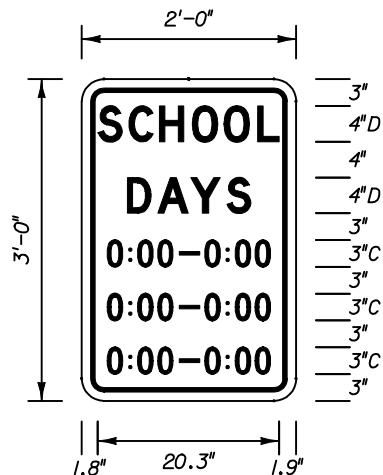

FTP - 32A
2' X 3'
1 1/2" Radii 3/4" Border
White Background
Black Legend & Border

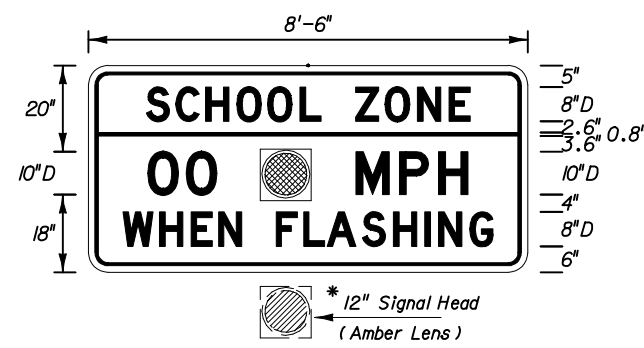

FTP - 33
8'-6" X 4'
3" Radii 2" Border
Series D Legend
Yellow Background Top White Background Bottom
Black Legend & Border

* Note:
Flashing beacon may
be placed within or
below panel.

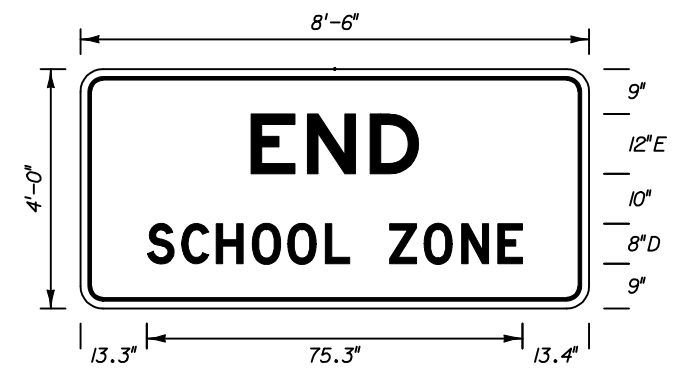

FTP - 34
8'-6" X 4'
3" Radii 3/4" Border
White Background
Black Legend & Border

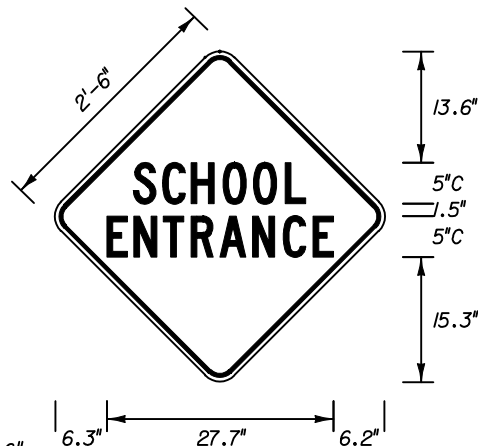

FTP - 35
2'-6" X 2'-6"
5" Series C Legend
2" Radii 3/4" Border
Yellow Background
Black Legend & Border

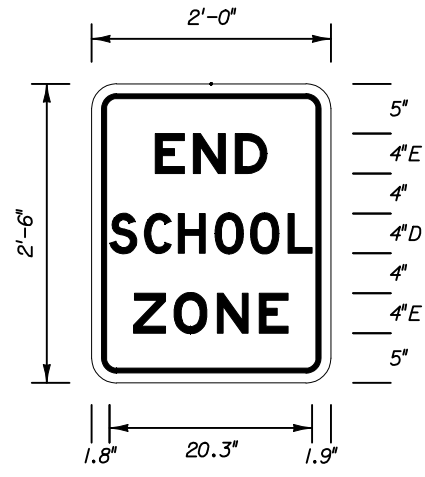

FTP - 36
2' X 2'-6"
4" Series D and E Legend
1 1/2" Radii 3/4" Border
White Background
Black Legend & Border

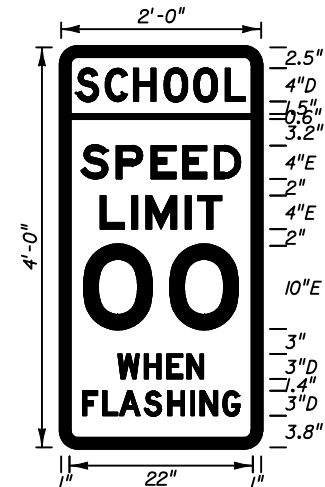

FTP - 37
2' X 4'
1 1/2" Radii 3/4" Border
Top Background Yellow Bottom Background White
Black Legend & Border Top and Bottom

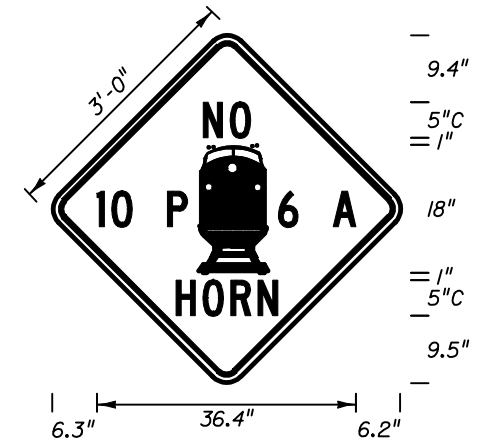

FTP - 38
3' X 3'
2" Radii 3/4" Border
5" Series C Legend
Yellow Background
Black Legend & Border



FTP - 38A
3' X 2'
Series C Legend
2" Radii 3/4" Border
Yellow Background
Black Legend & Border



FTP - 38B
3' X 3'
Series C Legend
2" Radii 3/4" Border
Yellow Background
Black Legend & Border

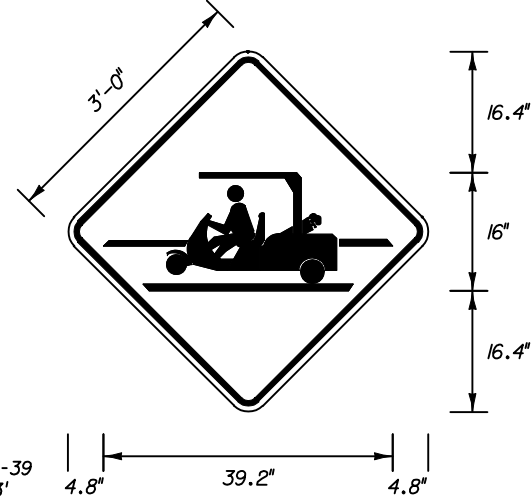

FTP - 39
3' X 3'
2" Radii 3/4" Border
Yellow Background
Black Legend & Border

Remove the two crosswalk
stripes for advance warning sign.

STATE OF FLORIDA DEPARTMENT OF TRANSPORTATION				
SPECIAL SIGN DETAILS				
Designed By	Names	Dates	Approved By <i>Charles Scott</i>	
Drawn By			State Traffic Standards Engineer	
Checked By	Revision	Sheet No.	Index No.	
	00	5 of 14	17355	

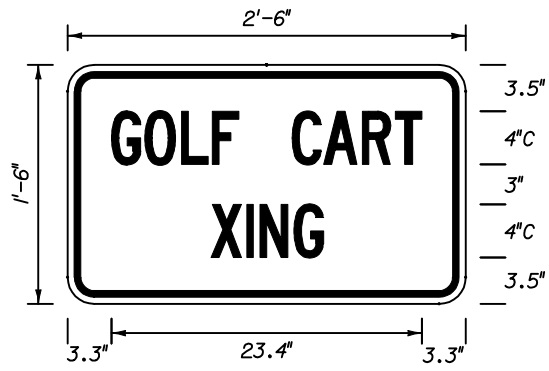

FTP - 39A
2'-6" X 1'-6"
1 1/2" Radii 3/4" Border
4" Series C Legend
Yellow Background
Black Legend & Border



FTP - 40
3' X 3'
2" Radii 3/4" Border
Yellow Background
Black Legend & Border

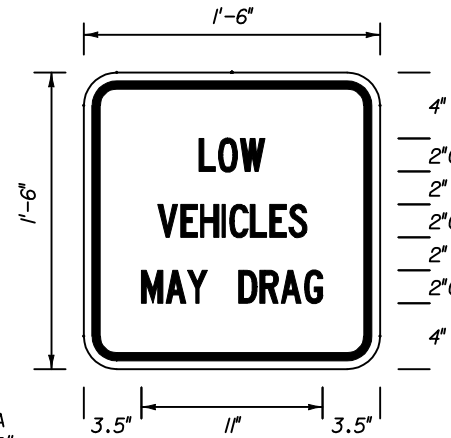

FTP - 40A
1'-6" X 1'-6"
1 1/2" Radii 3/4" Border
2" Series C Legend
Yellow Background
Black Legend & Border

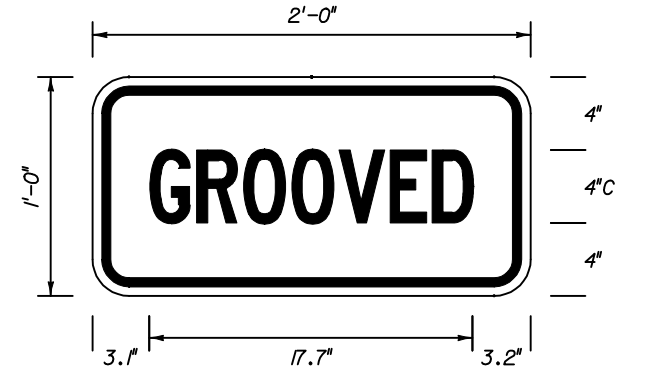

FTP - 41
2' X 1'
1 1/2" Radii 3/4" Border
4" Series C Legend
Yellow Background
Black Legend & Border

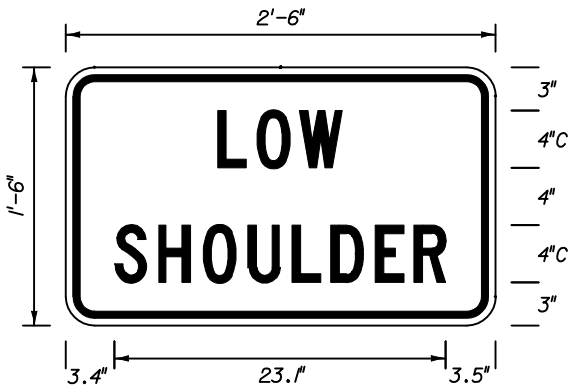

FTP - 42
2'-6" X 1'-6"
1 1/2" Radii 3/4" Border
4" Series C Legend
Yellow Background
Black Legend & Border

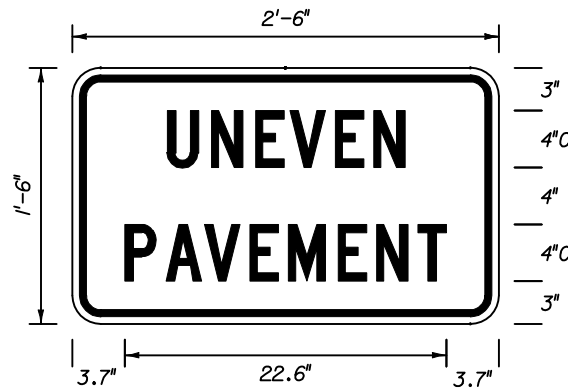

FTP - 43
2'-6" X 1'-6"
1 1/2" Radii 3/4" Border
4" Series C Legend
Yellow Background
Black Legend & Border

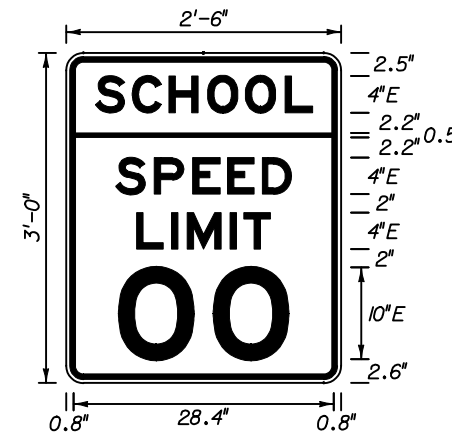

FTP - 44
2'-6" X 3'
1 1/2" Radii 3/4" Border
Series E Legend
Yellow Background Top White Background Bottom
Black Legend & Border

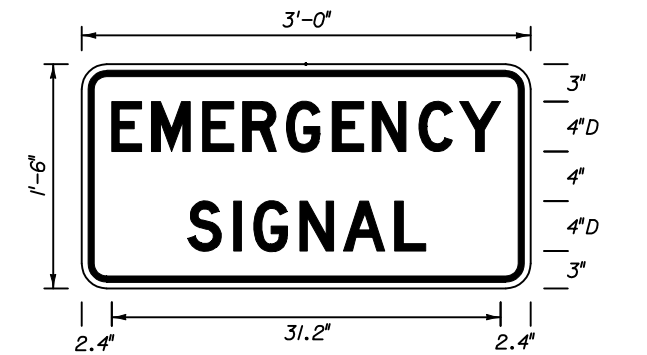

FTP - 45
3' X 1'-6"
1 1/2" Radii 3/4" Border
4" Series D Legend
Yellow Background
Black Legend & Border

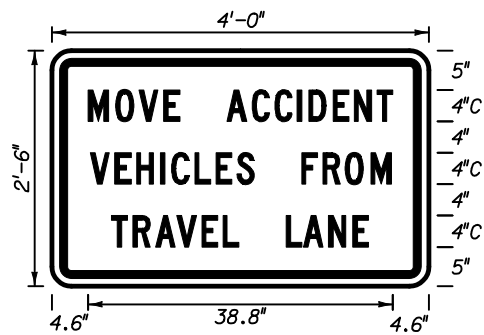

FTP - 46
4' X 2'-6"
2" Radii 3/4" Border
4" Series C Legend
White Background
Black Legend & Border

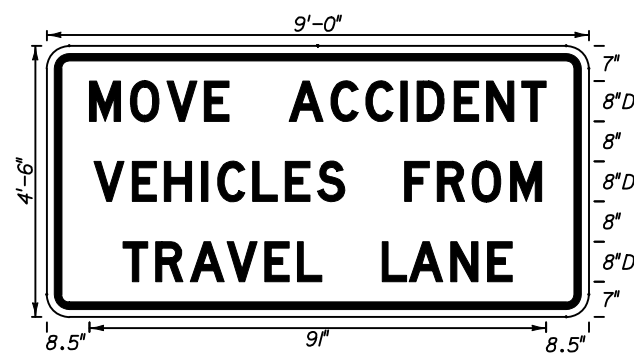

FTP - 46A
9' X 4'-6"
3" Radii 3/4" Border
8" Series D Legend
White Background
Black Legend & Border

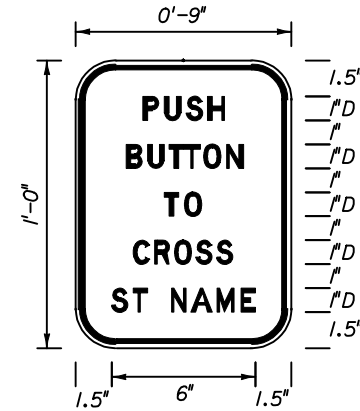

FTP - 47
9" X 12"
1 1/2" Radii 3/4" Border
1" Series D Legend
White Background
Black Legend & Border

STATE OF FLORIDA DEPARTMENT OF TRANSPORTATION				
SPECIAL SIGN DETAILS				
Names	Dates	Approved By <i>Charles A. Scott</i>		
Designed By		State Traffic Standards Engineer		
Drawn By		Revision	Sheet No.	Index No.
Checked By		00	6 of 14	17355

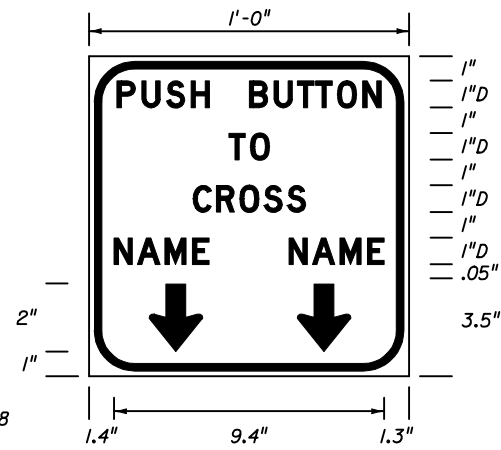

FTP - 48
1' X 1'
1/2" Radii 3/4" Border
1" Series D Legend
White Background
Black Legend & Border

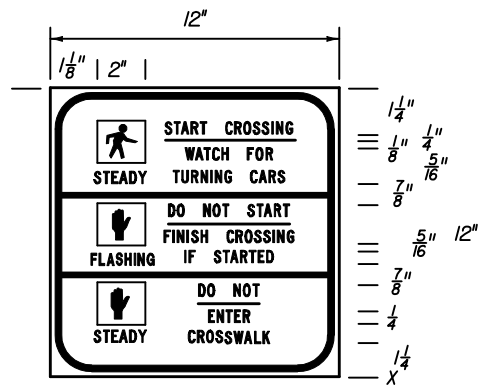

FTP - 49
1' X 1'
1/2" Radii 3/4" Border
Series C Legend
White Background
Black Legend & Border

Notes for FTP 49:

1. Text for FTP 49 shall be 1/2".
2. Spacing between lines of legend shall be 5/16" except as noted.
3. Underbar spacing as detailed.
4. Colors shall be White background with Black legend and border.
International Walk Symbol White on Black background.
International Don't Walk Symbol Orange on Black background.

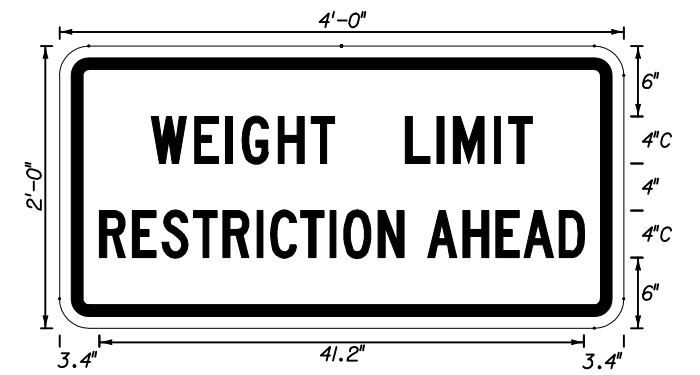

FTP - 50
4' X 2'
1/2" Radii 3/4" Border
4" Series C
Yellow Background
Black Legend & Border

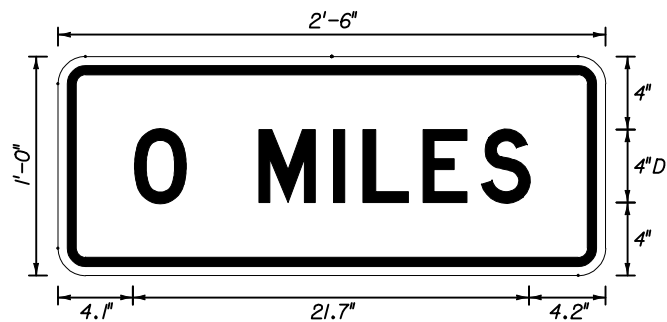

FTP - 51
2'-6" X 1'
1/2" Radii 3/4" Border
4" Series D
White Background
Black Legend & Border

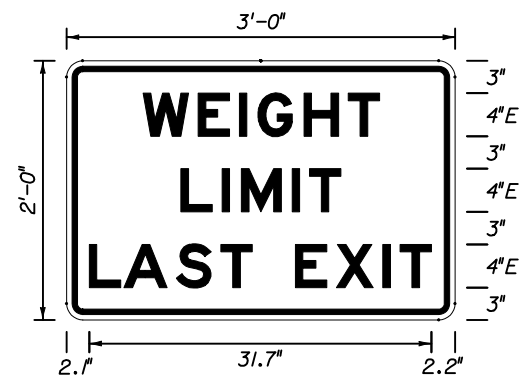

FTP - 52
3' X 2'
1/2" Radii 3/4" Border
4" Series E
White Background
Black Legend & Border

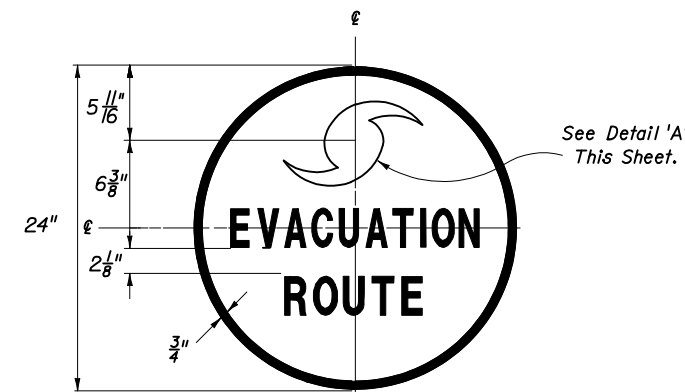

FTP - 53
2' Diameter
3/4" Border
3" Series C
Blue Background
White Legend, Border & Symbol

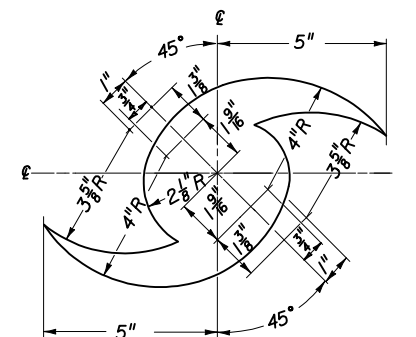

DETAIL 'A' for FTP - 53

Symbol

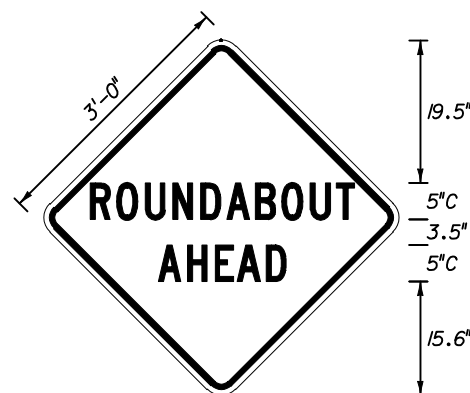

FTP - 54
3' X 3'
2" Radii 3/4" Border
5" Series D
Yellow Background
Black Legend & Border

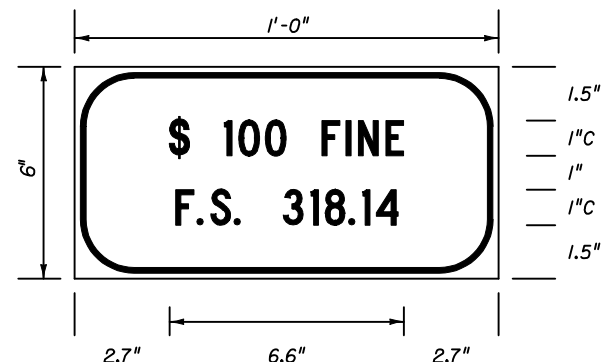

FTP - 55
1' X 6"
1/2" Radii 3/4" Border
1" Series C
White Background
Black Legend & Border
Supplemental panel for the FTP-25 and FTP-26 signs

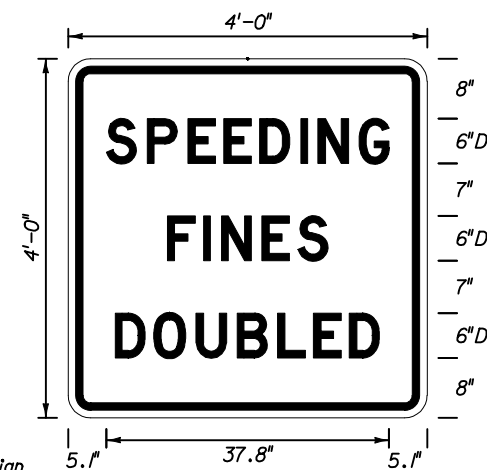

FTP - 56
Freeway Sign
4' X 4'
3" Radii 3/4" Border
6" Series D
White Background
Black Legend & Border

STATE OF FLORIDA DEPARTMENT OF TRANSPORTATION				
SPECIAL SIGN DETAILS				
Designed By	Names	Dates	Approved By <i>Clark A. Scott</i>	
Drawn By			State Traffic Standards Engineer	
Checked By	Revision	Sheet No.	Index No.	
	00	7 of 14	17355	

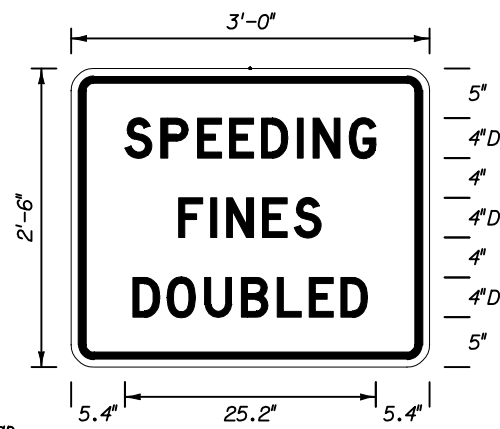

FTP - 57
Arterial Sign
3' X 2'-6"
2" Radii 3/4" Border
4" Series D
White Background
Black Legend & Border

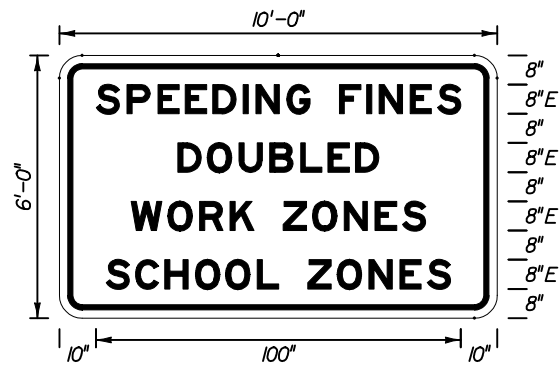

FTP - 58
State Line Sign
10' X 6'
3" Radii 2" Border
8" Series E
White Background
Black Legend & Border

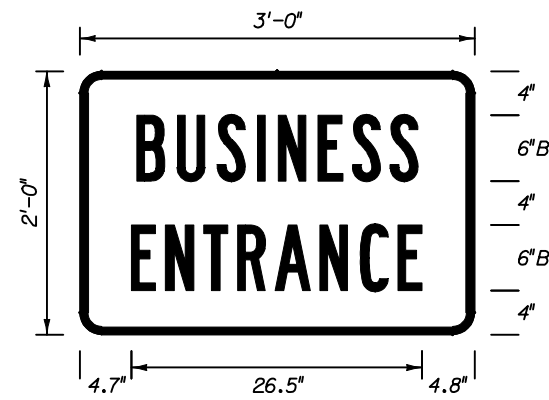

FTP - 59
3' X 2'
1 1/2" Radii 3/4" Border
6" Series B
Blue Background
White Legend & Border

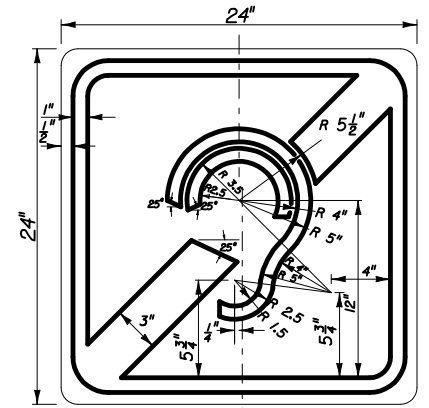

FTP - 60 INTERNATIONAL SYMBOL OF ACCESS FOR HEARING LOSS
24" X 24"
1 1/2" Radii 3/4" Border
Blue Background
White Legend & Border

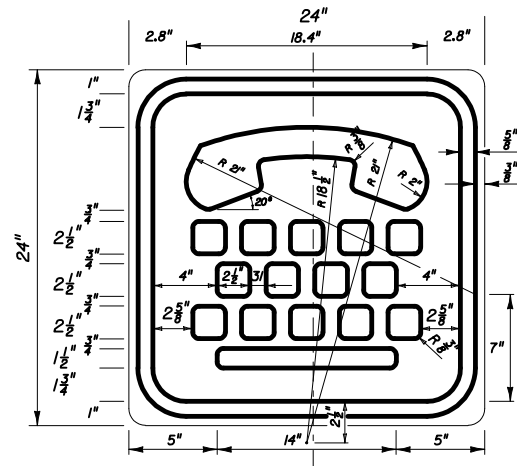

FTP - 61
2' X 2'
1 1/2" Radii 3/4" Border
Blue Background
White Legend & Border

INTERNATIONAL TDD SYMBOL

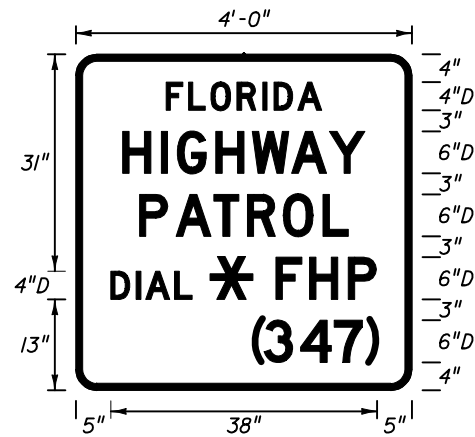

FTP - 62
4' X 4'
3" Radii 1" Border
Series D
Blue Background
White Legend & Border

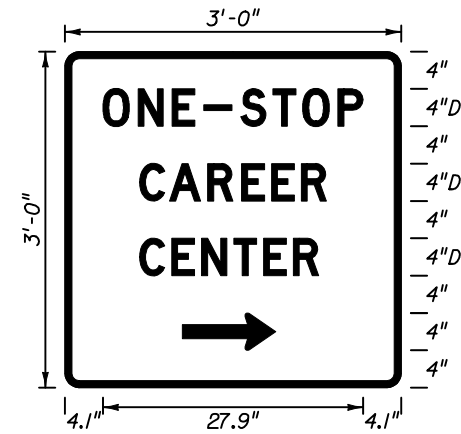

FTP - 63
3' X 3'
1 1/2" Radii
4" Series D
Green Background
White Legend & Border

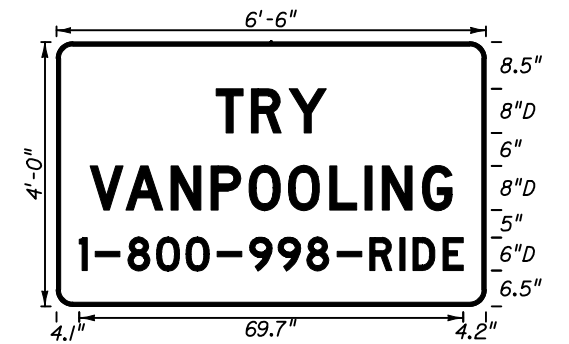

FTP - 64
6'-6" X 4'
3" Radii
8" Series D
6" Series D
Blue Background
White Legend & Border

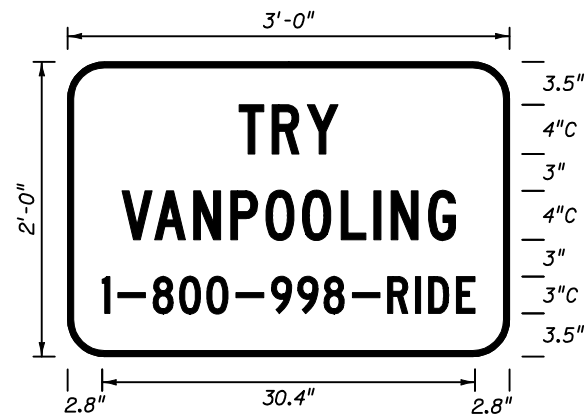

FTP - 65
3' X 2'
3" Radii
4" Series C
3" Series C
Blue Background
White Legend & Border

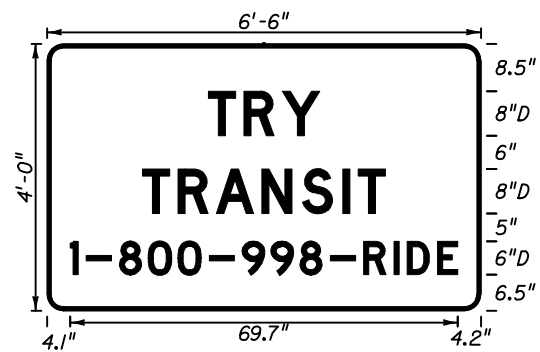

FTP - 66
6'-6" X 4'
3" Radii
8" Series D
6" Series D
Blue Background
White Legend & Border

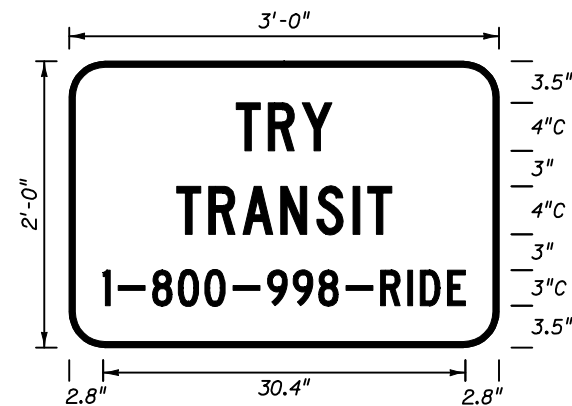

FTP - 67
3' X 2'
3" Radii
4" Series C
3" Series C
Blue Background
White Legend & Border

STATE OF FLORIDA DEPARTMENT OF TRANSPORTATION

SPECIAL SIGN DETAILS

Names	Dates	Approved By		
Designed By		 State Traffic Standards Engineer		
Drawn By				
Checked By				
		Revision	Sheet No.	Index No.
		02	8 of 14	17355



FTP - 68
6'-6" X 4'
3" Radii
8" Series D
6" Series D
Blue Background
White Legend & Border

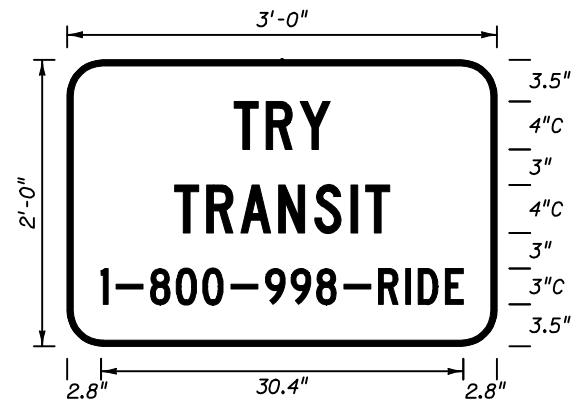

FTP - 69
3' X 2'
3" Radii
4" Series C
3" Series C
Blue Background
White Legend & Border



FTP - 70
3'-6" X 4'
1 1/2" Radii 3/4" Border
3" Series C
6" Series C
White Background
Black Legend & Border



FTP - 71
2'-6" X 3'
1 1/2" Radii 3/4" Border
2" Series C
4" Series C
White Background
Black Legend & Border



FTP - 72
9' X 6'
9" Radii 3/4" Border
8" Series D
White Background
Black Legend & Border



FTP - 73
4' X 3'
1 1/2" Radii 3/4" Border
4" Series C
White Background
Black Legend & Border

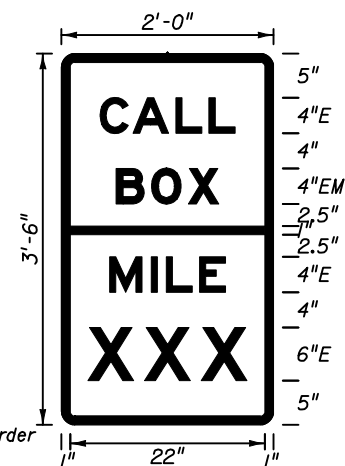

FTP - 74
2' X 3'-6"
1 1/2" Radii
Top
4" Series E
4" Series EM
Blue Background
White legend & Border
Bottom
4" Series E
6" Series E
Green Background
White Legend & Border

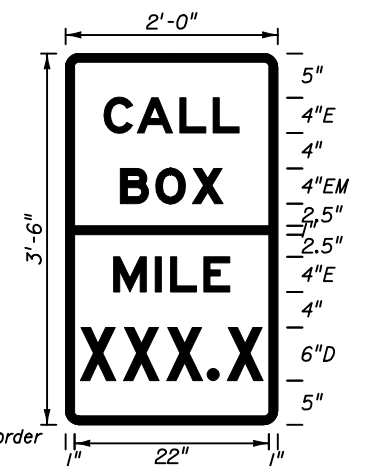

FTP - 75
2' X 3'-6"
1 1/2" Radii
Top
4" Series E
4" Series EM
Blue Background
White legend & Border
Bottom
4" Series E
6" Series D
Green Background
White Legend & Border

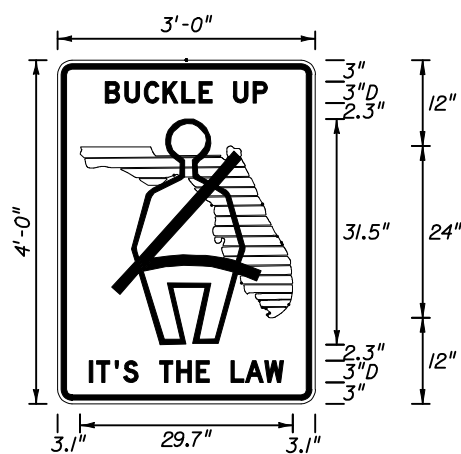

FTP - 76
3' X 4'
1 1/2" Radii 3/4" Border
3" Series D
White Background
Black Legend, Border & Man Belt Symbol
Florida Shield Green

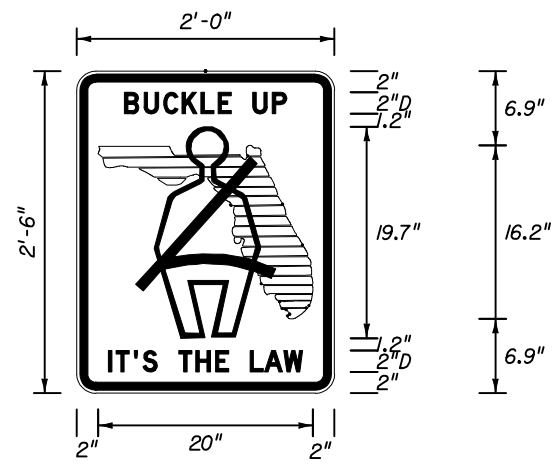

FTP - 77
3' X 4'
1 1/2" Radii 3/4" Border
2" Series D
White Background
Black Legend, Border & Man Belt Symbol
Florida Shield Green

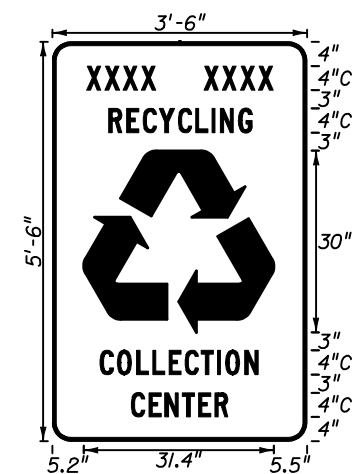

FTP - 78
3'-6" X 5'-6"
3" Radii
4" Series C
Green Background
White Legend, Border & Symbol
Municipality Name Optional

STATE OF FLORIDA DEPARTMENT OF TRANSPORTATION				
SPECIAL SIGN DETAILS				
Names	Dates	Approved By <i>Clark A. Scott</i>		
Designed By		State Traffic Standards Engineer		
Drawn By		Revision	Sheet No.	Index No.
Checked By		02	9 of 14	17355



See Detail 'B'
This Sheet.

FTP - 79
3'-6" X 5'
3" Radii
4" Series C
Green Background
White Legend, Border & Symbol

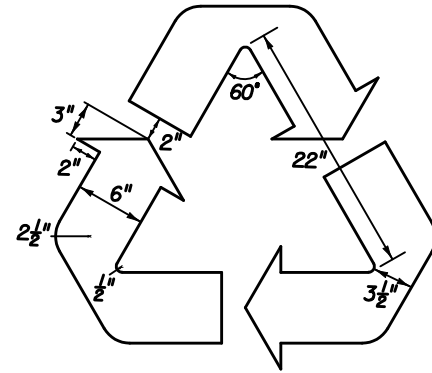

DETAIL 'B' for FTP - 79

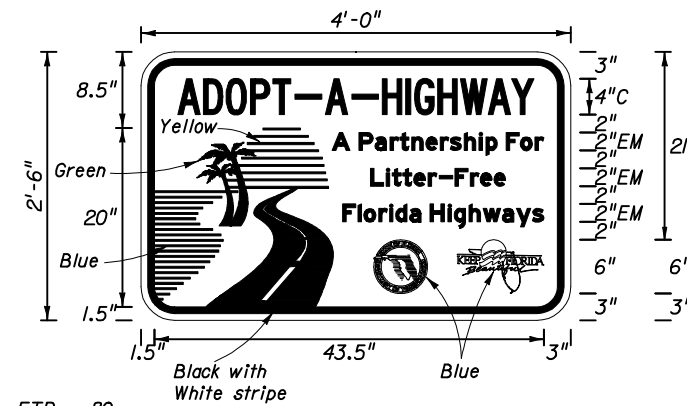

FTP - 80
4" X 2"-6"
3" Radii
4" Series C
2" Series EM
White Background
Blue Legend & Border

STATE OF FLORIDA DEPARTMENT OF TRANSPORTATION

SPECIAL SIGN DETAILS

Designed By	Names	Dates	Approved By
Drawn By			<i>Clark A. Scott</i>
Checked By			State Traffic Standards Engineer
	Revision	Sheet No.	Index No.
	02	10 of 14	17355

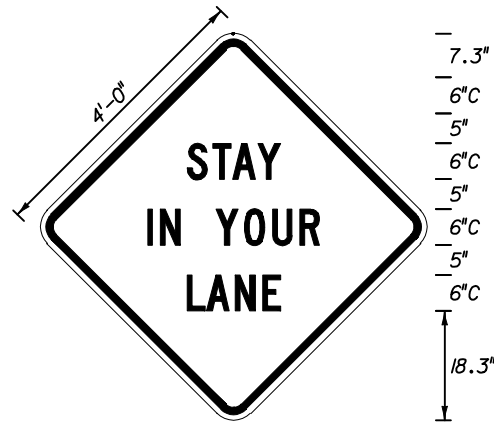

MOT - 1
4' X 4'
3" Radii $\frac{3}{4}$ " Border
6" Series C Legend
Orange Background
Black Legend & Border

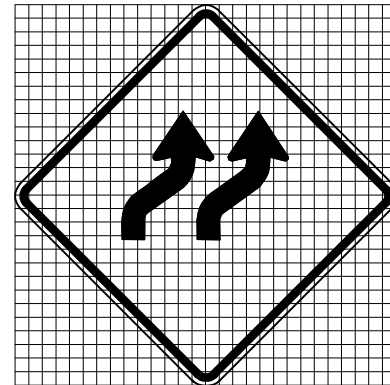

MOT - 2
4' X 4'
3" Radii $\frac{3}{4}$ " Border
Grid = 2" X 2"
Orange Background
Black Arrows & Border

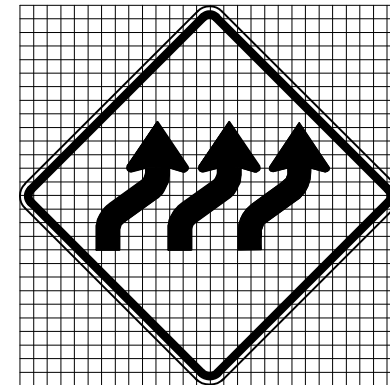

MOT - 3
4' X 4'
3" Radii $\frac{3}{4}$ " Border
Grid = 2" X 2"
Orange Background
Black Arrows & Border

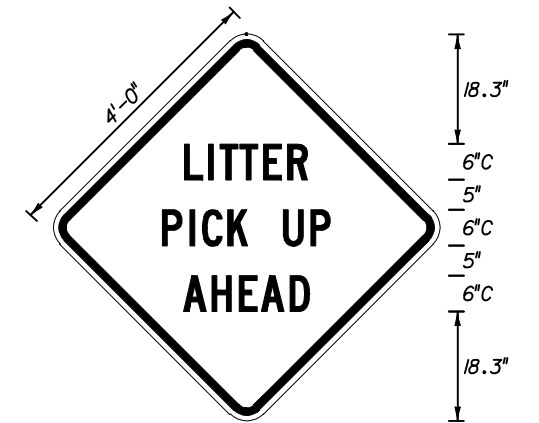

MOT - 4
4' X 4'
3" Radii $\frac{3}{4}$ " Border
Orange Background
Black Arrows & Border

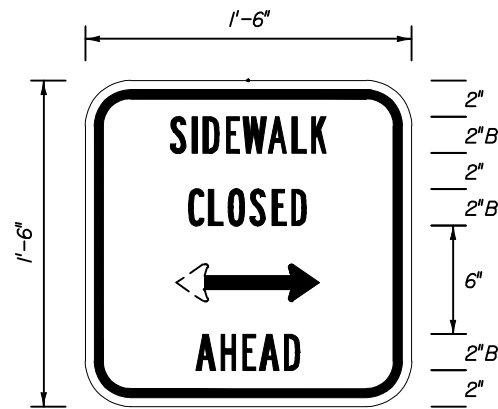

MOT - 5
1'-6" X 1'-6"
2" Radii $\frac{3}{4}$ " Border
2" Series B Legend
White Background
Black Legend & Border

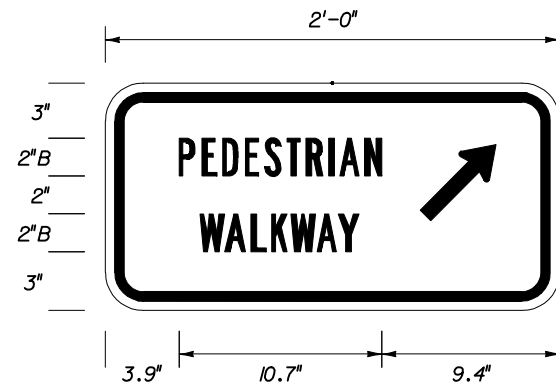

MOT - 6
2' X 1'
1 1/2" Radii $\frac{3}{4}$ " Border
2" Series B Legend
White Background
Black Legend & Border

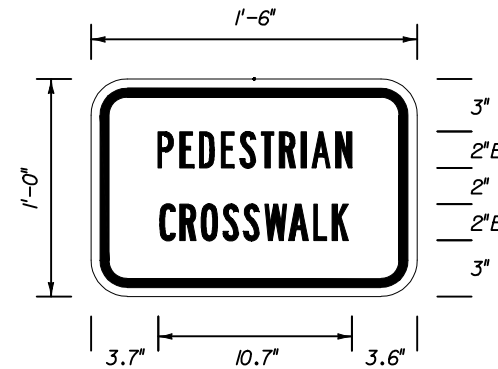

MOT - 7
1'-6" X 1'
1 1/2" Radii $\frac{3}{4}$ " Border
2" Series B Legend
White Background
Black Legend & Border

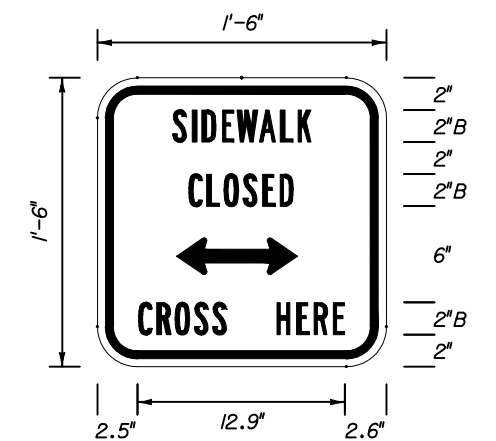

MOT - 8
1'-6" X 1'-6"
2 1/4" Radii $\frac{3}{4}$ " Border
2" Series B Legend
White Background
Black Legend & Border

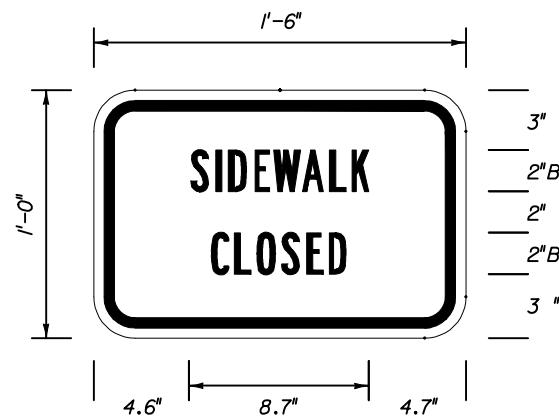

MOT - 9
1'-6" X 1'
1 1/2" Radii $\frac{3}{4}$ " Border
2" Series B Legend
White Background
Black Legend & Border

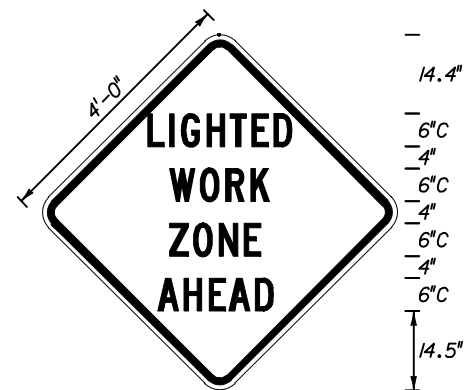

MOT - 10
4' X 4'
3" Radii $\frac{3}{4}$ " Border
6" Series C Legend
Orange Background
Black Legend & Border

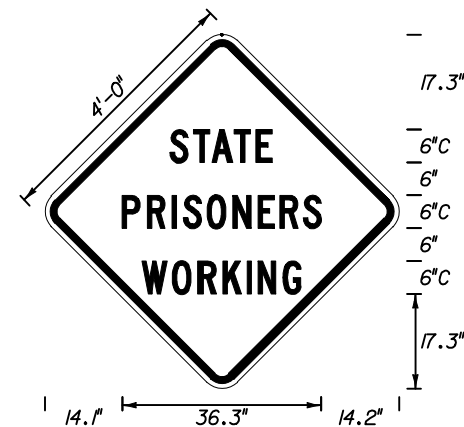

MOT - 11
4' X 4'
3" Radii $\frac{3}{4}$ " Border
6" Series C Legend
Orange Background
Black Legend & Border

STATE OF FLORIDA DEPARTMENT OF TRANSPORTATION				
SPECIAL SIGN DETAILS				
Designed By	Names	Dates	Approved By <i>Charles A. Scott</i>	
Drawn By			State Traffic Standards Engineer	
Checked By			Revision	Sheet No. Index No.
			00	11 of 14 17355

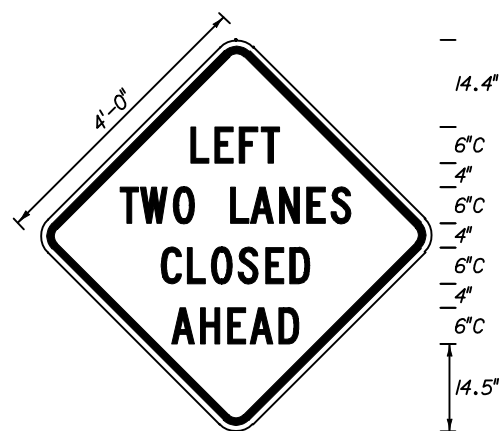

MOT - 12
4' X 4'
3" Radii 3/4" Border
6" Series C Legend
Orange Background
Black Legend & Border

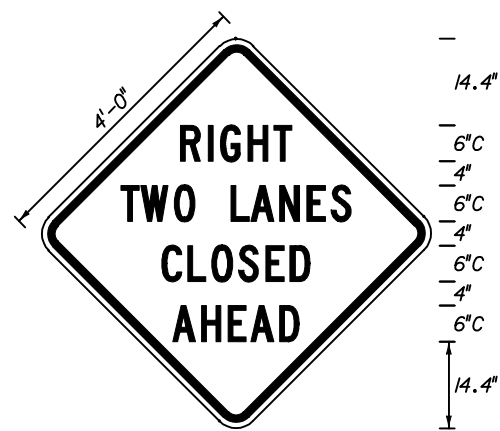

MOT - 13
4' X 4'
3" Radii 3/4" Border
6" Series C Legend
Orange Background
Black Legend & Border

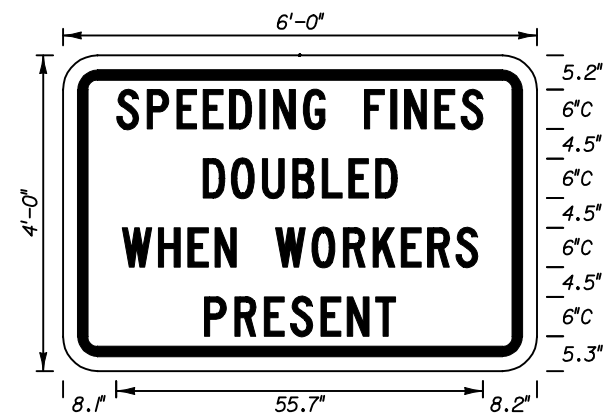

MOT - 14
6' X 4'
3" Radii 3/4" Border
6" Series C Legend
White Background
Black Legend & Border

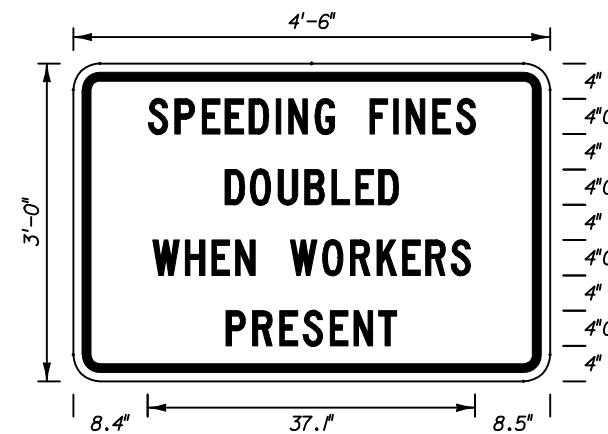

MOT - 15
4'-6" X 3'
3" Radii 3/4" Border
4" Series C Legend
White Background
Black Legend & Border

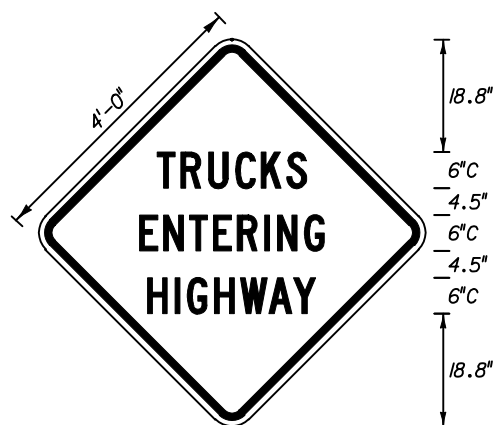

MOT - 16
4' X 4'
3" Radii 3/4" Border
6" Series C Legend
Orange Background
Black Legend & Border

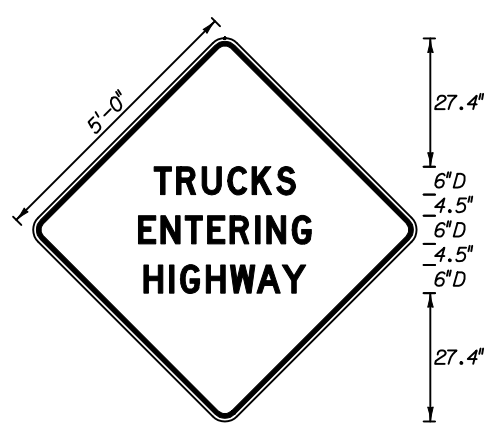

MOT - 17
5' X 5'
3" Radii 1" Border
6" Series D Legend
Orange Background
Black Legend & Border

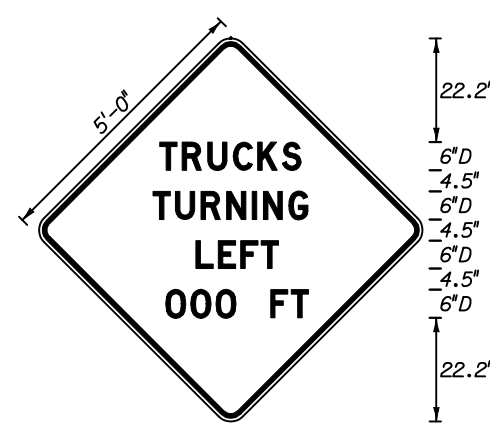

MOT - 18
5' X 5'
3" Radii 1" Border
6" Series D Legend
Orange Background
Black Legend & Border

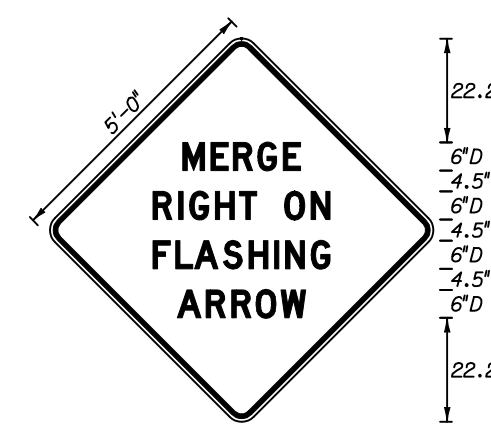

MOT - 19
5' X 5'
3" Radii 1" Border
6" Series D Legend
Orange Background
Black Legend & Border

STATE OF FLORIDA DEPARTMENT OF TRANSPORTATION				
SPECIAL SIGN DETAILS				
Designed By	Names	Dates	Approved By <i>Clark A. Scott</i> State Traffic Standards Engineer	
Drawn By			Revision	Sheet No. Index No.
Checked By			02	12 of 14 17355

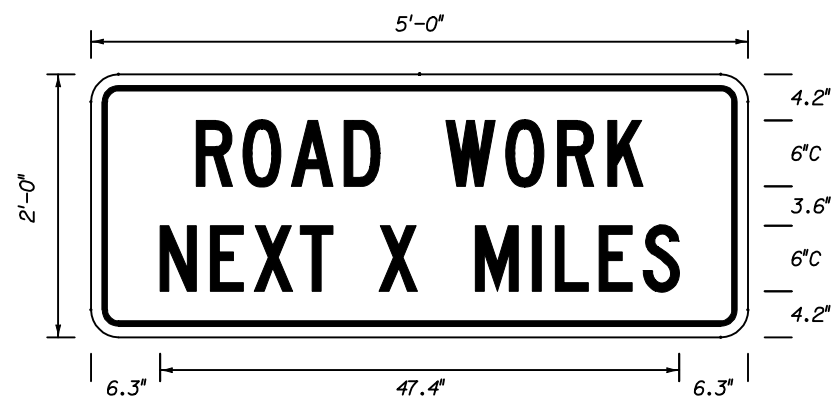

G20-1
5' X 2'
1.5 Radii .75 Border
6" Series C Legend
Orange Background
Black Legend & Border

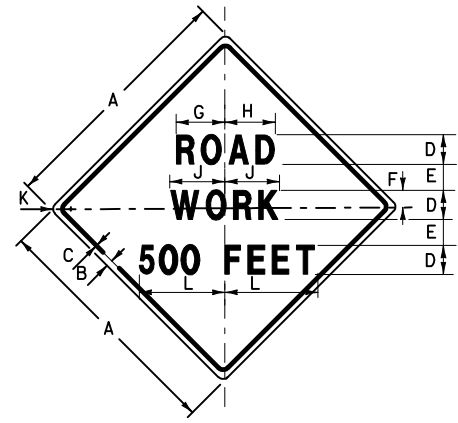

W20-1A
LEGEND AND BORDER: BLACK
BACKGROUND: ORANGE

DIMENSIONS IN INCHES										
A	B	C	D	E	F	G	H	J	K	L
36	$\frac{5}{8}$	$\frac{7}{8}$	5D	$3\frac{1}{2}$	$3\frac{1}{4}$	$8\frac{3}{8}$	$8\frac{7}{8}$	9	$2\frac{1}{4}$	$17\frac{1}{4}$
48	$\frac{3}{4}$	$1\frac{1}{4}$	7D	$4\frac{3}{4}$	$4\frac{1}{2}$	$11\frac{11}{16}$	$12\frac{7}{16}$	$12\frac{5}{8}$	3	24

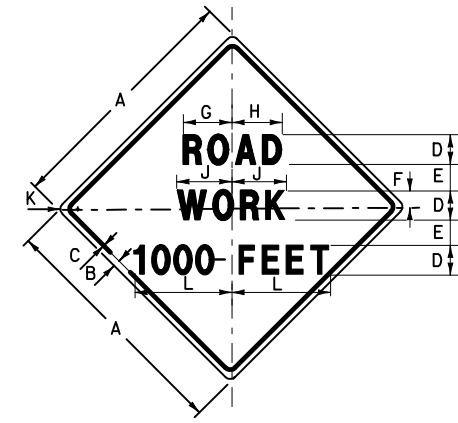

W20-1B
LEGEND AND BORDER: BLACK
BACKGROUND: ORANGE

DIMENSIONS IN INCHES										
A	B	C	D	E	F	G	H	J	K	L
36	$\frac{5}{8}$	$\frac{7}{8}$	5D	$3\frac{1}{2}$	$3\frac{1}{4}$	$8\frac{3}{8}$	$8\frac{7}{8}$	9	$2\frac{1}{4}$	$18\frac{3}{8}$
48	$\frac{3}{4}$	$1\frac{1}{4}$	7D	$4\frac{3}{4}$	$4\frac{1}{2}$	$11\frac{11}{16}$	$12\frac{5}{8}$	$12\frac{5}{8}$	3	$25\frac{7}{8}$

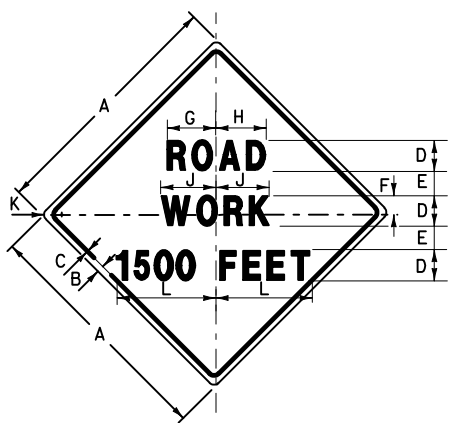

W20-1C
LEGEND AND BORDER: BLACK
BACKGROUND: ORANGE

DIMENSIONS IN INCHES										
A	B	C	D	E	F	G	H	J	K	L
36	$\frac{5}{8}$	$\frac{7}{8}$	5D	$3\frac{1}{2}$	$3\frac{1}{4}$	$8\frac{3}{8}$	$8\frac{7}{8}$	9	$2\frac{1}{4}$	$18\frac{3}{8}$
48	$\frac{3}{4}$	$1\frac{1}{4}$	7D	$4\frac{3}{4}$	$4\frac{1}{2}$	$11\frac{11}{16}$	$12\frac{7}{16}$	$12\frac{5}{8}$	3	$25\frac{3}{4}$

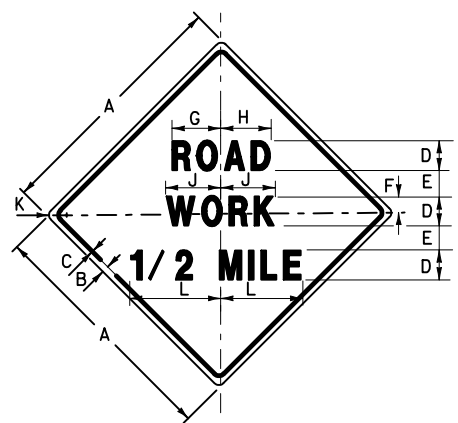

W20-1D
LEGEND AND BORDER: BLACK
BACKGROUND: ORANGE

DIMENSIONS IN INCHES										
A	B	C	D	E	F	G	H	J	K	L
36	$\frac{5}{8}$	$\frac{7}{8}$	5D	$3\frac{1}{2}$	$3\frac{1}{4}$	$8\frac{3}{8}$	$8\frac{7}{8}$	9	$2\frac{1}{4}$	$16\frac{3}{4}$
48	$\frac{3}{4}$	$1\frac{1}{4}$	7D	$4\frac{3}{4}$	$4\frac{1}{2}$	$11\frac{11}{16}$	$12\frac{7}{16}$	$12\frac{5}{8}$	3	22

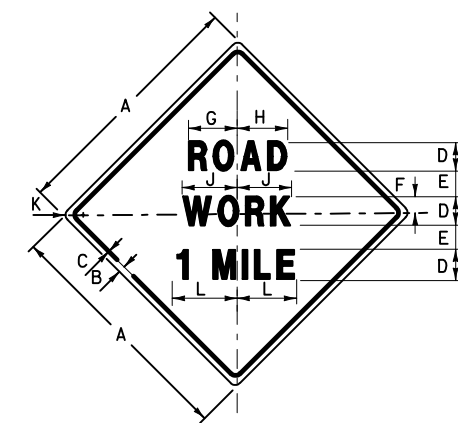

W20-1E
LEGEND AND BORDER: BLACK
BACKGROUND: ORANGE

DIMENSIONS IN INCHES										
A	B	C	D	E	F	G	H	J	K	L
36	$\frac{5}{8}$	$\frac{7}{8}$	5D	$3\frac{1}{2}$	$3\frac{1}{4}$	$8\frac{3}{8}$	$8\frac{7}{8}$	9	$2\frac{1}{4}$	$11\frac{3}{8}$
48	$\frac{3}{4}$	$1\frac{1}{4}$	7D	$4\frac{3}{4}$	$4\frac{1}{2}$	$11\frac{11}{16}$	$12\frac{5}{8}$	$12\frac{5}{8}$	3	$15\frac{7}{8}$

STATE OF FLORIDA DEPARTMENT OF TRANSPORTATION

SPECIAL SIGN DETAILS

Names	Dates	Approved By	<i>Charles Scott</i>	
Designed By		State Traffic Standards Engineer		
Drawn By		Revision	Sheet No.	Index No.
Checked By		00	13 of 14	17355

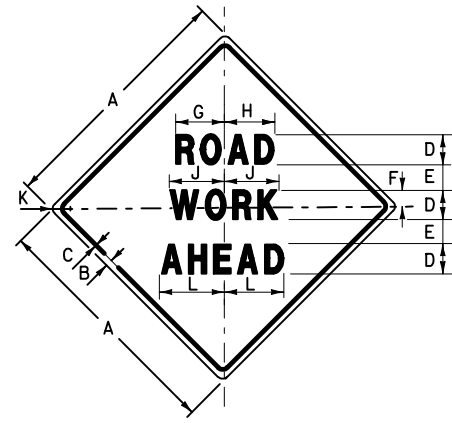

W20-IF
 LEGEND AND BORDER: BLACK
 BACKGROUND: ORANGE

DIMENSIONS IN INCHES										
A	B	C	D	E	F	G	H	J	K	L
36	$\frac{5}{8}$	$\frac{7}{8}$	5D	$3\frac{1}{2}$	$3\frac{1}{4}$	$8\frac{3}{8}$	$8\frac{7}{8}$	9	$2\frac{1}{4}$	11
48	$\frac{3}{4}$	$1\frac{1}{4}$	7D	$4\frac{3}{4}$	$4\frac{1}{2}$	$11\frac{11}{16}$	$12\frac{7}{16}$	$12\frac{5}{8}$	3	$15\frac{1}{4}$

STATE OF FLORIDA DEPARTMENT OF TRANSPORTATION

SPECIAL SIGN DETAILS

Designed By	Names	Dates	Approved By
Drawn By			<i>Charles Scott</i> State Traffic Standards Engineer
Checked By	Revision	Sheet No.	Index No.
	00	14 of 14	17355