



# Florida Department of Transportation

JEB BUSH  
GOVERNOR

605 Suwannee Street  
Tallahassee, FL 32399-0450

THOMAS F. BARRY, JR.  
SECRETARY

MS-32

**DATE:** December 17, 1999

**TO:** Registered Plans Preparation Manual Holders

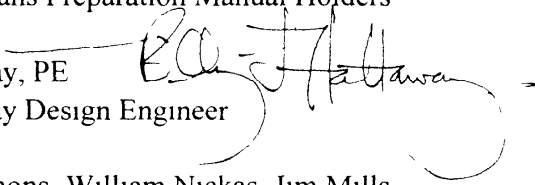
**FROM:** Billy Hattaway, PE   
State Roadway Design Engineer

**CC:** Freddie Simmons, William Nickas, Jim Mills

**SUBJECT:** IMPLEMENTATION - PLANS PREPARATION MANUAL  
JANUARY 2000 UPDATES

The January, 2000 Updates include

- 1 Revisions to Plans Preparation Manual, Volume I Metric, January, 1998
- 2 Revisions to Plans Preparation Manual Volume II Metric, January, 1999
- 3 New edition Plans Preparation Manual Volume I English, January, 2000
- 4 New edition Plans Preparation Manual Volume II English, January, 2000

The new English version is nearly identical to the Metric version except for units of measure. The major changes in design requirements included in both the Metric revisions and the new English edition are to be implemented as follows

---

## **Volume I, Chapter 1, Section 1.7 .1 Transportation Design for Livable Communities**

### SUMMARY OF CHANGE

New section added to reference the Department's Policy Statement regarding Transportation Design for Livable Communities (Topic Number 000-625-060). All designs are to consider TDLC features when such features are desired, appropriate and feasible.

### IMPLEMENTATION

This Policy Statement was implemented December 22, 1998

This change applies to both Metric and English Projects

---

**Volume I Chapter 2, Section 2 1 4 Pedestrian and Bicycle Facilities**

SUMMARY OF CHANGE

Section 2 1 4 1 was added to address sidewalk requirements

Section 2 1 4 2 addresses bicycle requirements and includes a new requirement for an undesignated bicycle lane between a right turn lane and the through lane at intersections

IMPLEMENTATION

Requirements for pedestrian and bicycle facilities have been previously implemented. The new requirement for undesignated bicycle lanes at intersections is effective on all projects beginning design as of January 1, 2000.

This change applies to both Metric and English Projects

---

**Volume I Chapter 3, Earthwork**

SUMMARY OF CHANGE

Chapter 3 has been rewritten to address several major changes to the selection of earthwork pay items and information to be included in plans. Changes include:

- 1 Pay for all Cut Operations as Regular Excavation or Regular Excavation (Lump Sum), Do not differentiate between suitable and unsuitable
- 2 Pay for all Fill Operations as Embankment or Borrow Excavation (Truck Measure)
- 3 Pay for all material excavated below the finished grading template as Subsoil Excavation, do not differentiate between suitable and unsuitable
- 4 When quantities are large, pay for Lateral Ditch and/or Channel Excavation separately. See the Basis of Estimates Handbook for additional information.

IMPLEMENTATION

These changes are to be implemented on all projects beginning with the July, 2000 letting.

These changes apply to both Metric and English Projects

---

**Volume I Chapter 4, Section 4.3.1 Roadside Barriers - Warrants**

SUMMARY OF CHANGE

**Implementation of January, 2000 Updates to the Plans Preparation Manual  
December 17, 1999**

Added bullet on roadside barrier requirements for vertical dropoffs created by retaining walls  
Provides new design criteria values for curbed sections with drop offs

**IMPLEMENTATION**

The general requirement that roadside vertical dropoffs be addressed is a clarification and is not new  
New design criteria values for curbed sections are to be implemented on all projects beginning design  
as of January 1, 2000

This change applies to both Metric and English Projects

---

**Volume I Chapter 7, Section 7 4.4 Controller Assemblies**

**SUMMARY OF CHANGE**

Added guidance that future intersection expansion should be considered in the design of controller  
assemblies Also added guidance on expansion versus replacement when existing controller assemblies  
are to be upgraded

**IMPLEMENTATION**

This change is effective on all projects beginning design as of January 1, 2000

This change applies to both Metric and English Projects

---

**Volume I Chapter 8, Section 8.3.3 Pedestrian Railings, Section 8 4 4 Bicycle Railings, and 8 7  
Shared Use Paths**

**SUMMARY OF CHANGE**

Sections were changed to address pedestrian and bicycle railing requirements The pipe handrail  
shown in Index 520 is suitable for dropoffs up to 30" For vertical dropoffs greater than 30", a handrail  
design conforming to ADA requirements and AASHTO rail requirements shall be provided

**IMPLEMENTATION**

This change is to be implemented on all projects beginning with the July, 2000 letting

This change applies to both Metric and English Projects

---

**Volume I Chapter 10, Section 10 14 4 Work Zone Traffic Control - Pedestrians and Bicyclists**

SUMMARY OF CHANGE

Section 10 14 4 has been changed to provide improved direction on accommodating pedestrians and bicyclist in work zones

IMPLEMENTATION

This change is a clarification to existing requirements

This change applies to both Metric and English Projects

---

**Volume I Chapter 13, Section 13 5 2 Projects Involving Bridges with Lead Based Paint**

SUMMARY OF CHANGE

Section 13 5 2 has been changed to clarify project manager responsibilities and contract document requirements for projects with lead based paint

IMPLEMENTATION

This change is a clarification to existing requirements

This change applies to both Metric and English Projects

---

**Volume I Chapter 19, Section 19 1 Sealing Design Documents - General**

SUMMARY OF CHANGE

Section 19 1 has been changed to address Landscape Architect sealing requirements (Chapter 481, Part II, Florida Statutes, and Rule Chapter 61G10-11 010(2))

IMPLEMENTATION

This change addresses existing requirements

This change applies to both Metric and English Projects

---

**Volume I Chapter 19, Section 19 2 2 Electronic Sealing**

SUMMARY OF CHANGE

Section 19 2 2 has been added to address electronic sealing

IMPLEMENTATION

Electronic sealing is applicable when required as a project deliverable

This change applies to both Metric and English Projects

---

**Volume I Chapter 19, Section 19 4 1 Sealing Design Documents - Plans**

SUMMARY OF CHANGE

Section 19 4 1 has been changed to address the disposition of revised plan sheets

IMPLEMENTATION

This change is effective immediately and has been implemented by the Central Office Plans Processing section

This change applies to both Metric and English Projects

---

**Volume I Chapter 20, Section 20.3.1 Plans Processing - District Activities**

SUMMARY OF CHANGE

Section 20 3 1 has been added to provide general information on District Plans Processing prior to submitting contract plans to Tallahassee

IMPLEMENTATION

This change provides general information on typical plans processing activities. Each District should be contacted for specific requirements regarding plans processing

This change applies to both Metric and English Projects

---

**Volume I Chapter 20, Section 20.4 Revisions to the Contract Plans Package**

SUMMARY OF CHANGE

Section 20.4 has been changed to clarify the recording, processing and dating of revisions. Corresponding changes have been made to the Revision Memo (Exhibit 20-C).

IMPLEMENTATION

This change should be implemented as soon as practical on all projects. Full implementation is required on all projects beginning with the July, 2000 letting.

This change applies to both Metric and English Projects.

---

**Volume I Chapter 24, Federal Aid Project Certification**

SUMMARY OF CHANGE

Chapter 24 has been re-written to reflect FDOT's current Exemption Agreement with FHWA as provided for by Federal law. All federal aid projects developed in accordance with the exemption process are exempt from FHWA oversight, except for new or reconstruction projects on the Interstate System with cost estimates greater than \$1 million.

IMPLEMENTATION

The current Exemption Agreement was adopted April 26, 1999.

This change applies to both Metric and English Projects.

---

**Volume I Chapter 25, Section 25.4.11.1 c) P.I.'s without Curves**

SUMMARY OF CHANGE

Section 25.4.11.1 c) was added to address maximum deflection without curves. The same maximum deflection without curves that applies to new construction, also applies to RRR projects.

IMPLEMENTATION

**Implementation of January, 2000 Updates to the Plans Preparation Manual  
December 17, 1999**

This change is effective on all projects beginning design as of January 1, 2000

This change applies to both Metric and English Projects

---

**Volume I Chapter 25, Section 25.4.14 Horizontal Clearance**

SUMMARY OF CHANGE

Section 25.4.14 on Horizontal Clearance was changed for clarification. The discussion on Clear Zone formerly in Section 25.4.15 is deleted and revised discussion on Clear Zone is included with 25.4.14. Horizontal Clearance tables are provided similar to Chapter 2.

IMPLEMENTATION

This change is effective on all projects beginning design as of January 1, 2000

This change applies to both Metric and English Projects

---

**Volume I Chapter 25, Section 25.4.15 Control Zones**

SUMMARY OF CHANGE

The discussion on Clear Zone was deleted from 25.4.15 and new discussion provided in 25.4.14. Section 25.4.15 is now entitled "Control Zones" and provides discussion and descriptions of Control Zones. Requirements are compatible with the new Utility Accommodation Manual.

IMPLEMENTATION

This change is effective on all projects beginning design as of January 1, 2000. For utility installations, the application of control zones was implemented with adoption of the January, 1999 Utility Accommodation Manual.

This change applies to both Metric and English Projects

---

**Volume I Chapter 25, Section 25.4.26 Roadside Safety Hardware**

SUMMARY OF CHANGE

Section 25.4.26, Roadside Safety Hardware has been added to address roadside safety hardware

**Implementation of January, 2000 Updates to the Plans Preparation Manual  
December 17, 1999**

requirements on RRR projects

**IMPLEMENTATION**

This change provides clarification to previously implemented requirements and is effective immediately on all RRR projects

This change applies to both Metric and English Projects

---

**Volume I Chapter 30 Section 30 1 Retaining Walls**

**SUMMARY OF CHANGE**

Section 30 1, Purpose, has been changed to include reference to the requirement for roadside barriers to shield drop offs created by retaining walls Also added is a reference to the requirement for handrails or fences for bicyclists and pedestrians when retaining walls are located within the right of way

**IMPLEMENTATION**

This change is effective on all projects beginning design as of January 1, 2000

This change applies to both Metric and English Projects

---

**Volume I Chapter 31 Geosynthetic Design**

**SUMMARY OF CHANGE**

Chapter 31, Geosynthetic Design is a new chapter addressing design procedures to be followed for designing and preparing plans for geosynthetic reinforced soil slopes, and geosynthetic reinforced foundations over soft soils The process to be followed involves providing a generic design in the plans rather than contacting individual suppliers to obtain designs for inclusion in the plans New pay items have been established

**IMPLEMENTATION**

This change is effective on all projects beginning with the July, 2000 letting See the 1999 Basis of Estimates Handbook, July 1999 update for additional information

This change applies to both Metric and English Projects

---



**Volume II Chapter 1, Section 1 3, Displaying Information and Data**

SUMMARY OF CHANGE

In the English version, the title (Application of the Metric System) was changed and the content of this section was edited for English

IMPLEMENTATION

This change is a clarification for use with the new English PPM

---

**Volume II Chapter 1, Section 1 4, Base Sheet Format**

SUMMARY OF CHANGE

A new base sheet format with 3/4" margins on each side. Grids can be plotted with minor grids turned on or off. If minor grids are plotted, they are to be half toned.

IMPLEMENTATION

This change is effective on all projects beginning design when the new CADD software release is available.

This change applies to both Metric and English Projects

---

**Volume II Chapter 10, Section 10.2 1 Centerline**

SUMMARY OF CHANGE

Recommendations for scales and the format for showing centerline stationing and tick marks have been added.

IMPLEMENTATION

This change involves recommendations that may be used on projects beginning immediately.

This change applies to English Projects. Similar recommendations are not provided in the Metric edition of Volume II.

---

**Volume II Chapter 10, Exhibit 10-1, General Notes for Roadway Plan and Roadway Plan-Profile Sheets**

SUMMARY OF CHANGE

The benchmark datum information required in General Note 1 has been changed to include NAVD 88 when applicable

IMPLEMENTATION

This change is effective immediately

This change applies to both Metric and English Projects

---

**Volume II Chapter 11, Section 11 7 At-Grade Railroad Crossings**

SUMMARY OF CHANGE

Section 11 7 has been added to provide guidance on providing supplemental profiles for at grade railroad crossings

IMPLEMENTATION

This change involves recommendations that may be used on projects beginning immediately

This change applies to both Metric and English Projects

---

**Volume II Chapter 18, Roadway Cross Sections, Section 18 2 Required Information**

SUMMARY OF CHANGE

Chapter 18 has been changed to be consistent with new procedures for earthwork described in Volume I, Chapter 3

IMPLEMENTATION

This change is effective on all projects beginning with the July, 2000 letting

This change applies to both Metric and English Projects

---

**Volume II Chapter 23, Section 23 7 2 Overhead Signs and Support Structure**

SUMMARY OF CHANGE

Section 23 7 2 has been changed to clarify required information to be included in plans for overhead signs and support structures

IMPLEMENTATION

This change involves a clarification to existing requirements and is effective immediately

This change applies to both Metric and English Projects

---

**Volume II Chapter 26 Landscape Plans, Section 26 1, General**

SUMMARY OF CHANGE

Section 26 1 has been changed to reference signing and sealing requirements for Landscape Architects

IMPLEMENTATION

This change involves a clarification to existing requirements and is effective immediately

This change applies to both Metric and English Projects

---

All other changes in the January, 2000 Plans Preparation Manual updates package primarily consist of minor editing for clarification and/or error corrections

If you have any questions please contact this office, 850-414-4318, Suncom 994-4318

# PLANS PREPARATION MANUAL

## VOLUME I - ENGLISH

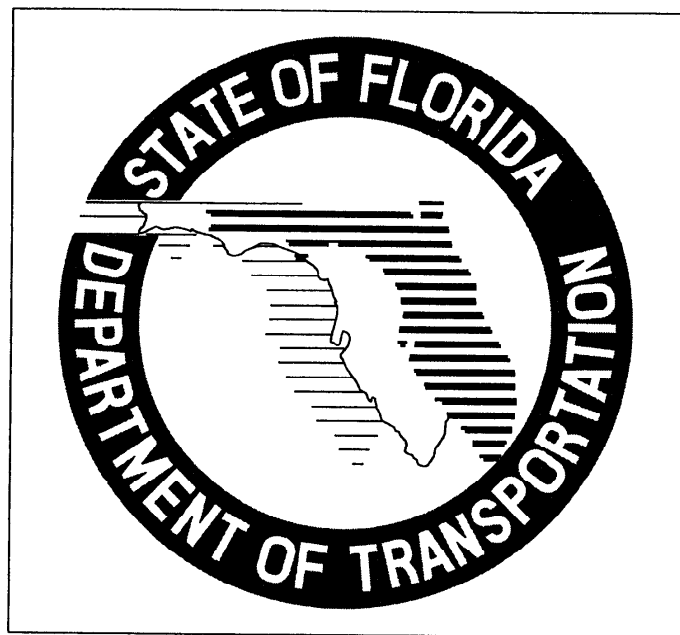

©HighwayMap Sep. 17 01 1024

**ROADWAY DESIGN OFFICE**

**TALLAHASSEE, FLORIDA**

**JANUARY 2000**

# REGISTRATION FORM

PLEASE RETURN TO ADDRESS BELOW

## PLANS PREPARATION MANUAL

VOLUME I - ENGLISH (JANUARY 2000)

NAME OF PPM HOLDER \_\_\_\_\_

NAME OF FIRM OR  
D.O.T. DISTRICT \_\_\_\_\_

STREET ADDRESS & MAIL STATION \_\_\_\_\_

TELEPHONE \_\_\_\_\_

Please remove this sheet from your Manual and provide the requested information as soon as possible. This will register you as a PPM holder and ensure that addenda and revisions may be forwarded as necessary.

Please return to

**Florida Department of Transportation  
Roadway Design Office  
Mail Station 32  
605 Suwannee Street  
Tallahassee, Florida 32399-0450  
Telephone: (850) 414-4318  
FAX (850) 922-9293  
SC 994-4318 SC FAX 292-9293**

STATE OF FLORIDA DEPARTMENT OF TRANSPORTATION

**SUGGESTIONS AND COMMENTS  
PLANS PREPARATION MANUAL  
VOLUME I - ENGLISH**

**NAME OF FIRM OR  
FDOT DEPARTMENT:**

---

---

**ADDRESS:**

---

---

---

---

**NAME OF PERSON  
RESPONSIBLE FOR  
SUGGESTIONS OR  
COMMENTS:**

---

**TELEPHONE NO.:**

---

**FAX NO.:**

---

**SUGGESTIONS  
OR COMMENTS:**

---

---

---

---

---

---

---

---

---

---

(Comments or Suggestions may be attached as marked up copies of pages from the manual)

**Please complete the requested information on a copy of this sheet and return to:**

**FLORIDA DEPARTMENT OF TRANSPORTATION  
ROADWAY DESIGN OFFICE  
MAIL STATION 32  
605 SUWANNEE STREET  
TALLAHASSEE, FLORIDA 32399-0450  
FAX NUMBER (850) 922-9293**

## Table of Contents

### INTRODUCTION

<b>CHAPTER 1</b>	<b>DESIGN CONTROLS</b>
<b>CHAPTER 2</b>	<b>DESIGN GEOMETRICS AND CRITERIA</b>
<b>CHAPTER 3</b>	<b>EARTHWORK</b>
<b>CHAPTER 4</b>	<b>ROADSIDE SAFETY</b>
<b>CHAPTER 5</b>	<b>UTILITIES</b>
<b>CHAPTER 6</b>	<b>RAILROAD CROSSING</b>
<b>CHAPTER 7</b>	<b>SIGNING, MARKING, LIGHTING AND SIGNALS</b>
<b>CHAPTER 8</b>	<b>PEDESTRIAN AND BICYCLE FACILITIES</b>
<b>CHAPTER 9</b>	<b>LANDSCAPING</b>
<b>CHAPTER 10</b>	<b>WORK ZONE TRAFFIC CONTROL</b>
<b>CHAPTER 11</b>	<b>STORM WATER POLLUTION PREVENTION PLAN</b>
<b>CHAPTER 12</b>	<b>RIGHT OF WAY</b>
<b>CHAPTER 13</b>	<b>INITIAL ENGINEERING DESIGN PROCESS</b>
<b>CHAPTER 14</b>	<b>FINAL ENGINEERING DESIGN PROCESS</b>
<b>CHAPTER 15</b>	<b>UPDATE ENGINEERING DESIGN PROCESS</b>
<b>CHAPTER 16</b>	<b>DESIGN SUBMITTALS</b>
<b>CHAPTER 17</b>	<b>ENGINEERING DESIGN ESTIMATE PROCESS</b>
<b>CHAPTER 18</b>	<b>QUALITY ASSURANCE &amp; QUALITY CONTROL</b>
<b>CHAPTER 19</b>	<b>SEALING DESIGN DOCUMENTS</b>
<b>CHAPTER 20</b>	<b>PLANS PROCESSING AND REVISIONS</b>
<b>CHAPTER 21</b>	<b>(RESERVED)</b>
<b>CHAPTER 22</b>	<b>ARCHITECTURAL PLANS</b>
<b>CHAPTER 23</b>	<b>DESIGN EXCEPTIONS AND DESIGN VARIATIONS</b>
<b>CHAPTER 24</b>	<b>FEDERAL AID PROJECT CERTIFICATION</b>
<b>CHAPTER 25</b>	<b>FLORIDA'S DESIGN CRITERIA FOR RESURFACING, RESTORATION AND REHABILITATION (RRR) OF STREETS AND HIGHWAYS</b>
<b>CHAPTER 26</b>	<b>BRIDGE PROJECT DEVELOPMENT</b>
<b>CHAPTER 27</b>	<b>HYDRAULIC DATA AND U.S. COAST GUARD PERMITS</b>
<b>CHAPTER 28</b>	<b>SHOP AND ERECTION DRAWINGS</b>
<b>CHAPTER 29</b>	<b>MISCELLANEOUS STRUCTURES</b>
<b>CHAPTER 30</b>	<b>RETAINING WALLS</b>
<b>CHAPTER 31</b>	<b>GEOSYNTHETIC DESIGN</b>

## INTRODUCTION

### PLANS PREPARATION MANUAL, VOLUME I - ENGLISH

#### **PURPOSE:**

This *Plans Preparation Manual, Volume I-English* sets forth geometric and other design criteria, as well as procedures, for Florida Department of Transportation (FDOT) projects. The information contained herein applies to the preparation of contract plans for roadways and structures.

#### **AUTHORITY:**

Section 334.044(2), Florida Statutes

#### **SCOPE:**

This procedure impacts anyone preparing roadway and structures construction plans for the Department.

#### **GENERAL INFORMATION:**

Chapter 334 of the Florida Statutes, as part of the *Florida Transportation Code*, establishes the responsibilities of the State, counties, and municipalities for the planning and development of the transportation systems serving the people of Florida, with the objective of assuring development of an integrated, balanced statewide system. The Code's purpose is to protect the safety and general welfare of the people of the State and to preserve and improve all transportation facilities in Florida. Under Section 334.044, the Code sets forth the powers and duties of the Department of Transportation including to adopt rules, procedures and standards for the conduct of its business operations and the implementation of any provisions of law for which the Department is responsible.

#### **PROCEDURE:**

The criteria in this manual represent requirements for the State Highway System which must be met for the design of FDOT projects unless approved exceptions or variations are obtained in accordance with procedures outlined in this manual.



Roadway and structures design is primarily a matter of sound application of acceptable engineering criteria and standards. While the criteria contained in this manual provide a basis for uniform design practice for typical roadway design situations, precise standards which would apply to individual situations must rely on good engineering practice and analyses.

Situations will exist where these criteria will not apply. The inappropriate use of and adherence to these criteria does not exempt the engineer from the professional responsibility of developing an appropriate design. The engineer is responsible for identifying those criteria which may not apply to a particular design, and for obtaining the necessary exception or variation to achieve proper design.

## 1 PLANS PREPARATION MANUAL, VOLUME I - ENGLISH MANUAL ORGANIZATION

### a Background

The Florida Department of Transportation *Plans Preparation Manual (PPM)* was published in the current format in January, 1998. The criteria in the 1998 PPM was given in metric units.

### b Organization

The *Plans Preparation Manual - English* is a two volume manual. Volume I contains the design criteria and process and Volume II contains material concerning plans preparation and assembly.

## 2 DISTRIBUTION

This document is distributed through **FDOT Maps and Publications Sales**.

Copies may be obtained from

Florida Department of Transportation  
Maps and Publications Sales  
Mail Station 12  
605 Suwannee Street  
Tallahassee, FL 32399-0450

Telephone (850) 414-4050  
SUNCOM 994-4050  
FAX Number (850) 487-4099  
<http://www.dot.state.fl.us> (Then click on "Maps and Publications")

For updates and manual registration information contact

Roadway Design Office  
Mail Station 32  
Telephone (850) 414-4310  
SUNCOM 994-4310  
FAX Number (850) 922-9293

### 3 REVISIONS AND UPDATES

*Plans Preparation Manual* holders are encouraged to submit comments and suggestions for changes to the manual to the Roadway Design Office. When ideas or suggestions are received they will be reviewed by appropriate Roadway and/or Structures Design staff in a timely manner and will be coordinated with other offices affected by the proposed change. Items warranting immediate change will be made with the approval of the State Roadway Design Engineer in the form of a Design Bulletin.

**Design Bulletins** for the *Plans Preparation Manual* are numbered and distributed to all official *Plans Preparation Manual* holders. Design Bulletins have a maximum life of two hundred seventy (270) days. Within this time period either an official manual revision will be distributed or the Design Bulletin will become void.

Structures design issues which are subject to modification and revision will be processed in coordination with the Structures Design Office.

Proposed revisions are distributed in draft form to the District Design Engineers (DDE). The DDE coordinates the review of the proposed revisions with other affected district offices such as Structures Design. The goal is to obtain a majority opinion before revisions are made.

The Roadway Design Office will also coordinate proposed revisions or additions with affected offices within the Central Office. Substantive revisions that result in policy change will be coordinated with the Executive Committee for concurrence.

Revisions are voted on jointly by the District Design Engineers and the State Roadway Design Engineer (for Roadway Design issues) or the State Structures Design Engineer (for Structures Design issues). Each district will have one vote and the central office will have two votes, for a total of ten votes. Requirements mandated by FHWA or State Rules will not be subject to this majority vote.

All revisions and updates will be coordinated with the Organization and Procedures Office prior to distribution to ensure conformance with and incorporation into the Department's Standard Operating System

The adopted revisions and addenda will be distributed to registered holders of the manual

**TRAINING:**

None required

**FORMS ACCESS:**

Documents marked as **SAMPLES** provide only a starting point allowing users to change or alter the document as needed to fit specific situations. Samples are not official forms of the Department

# Chapter 1

## DESIGN CONTROLS

1.1	General .....	1-1
1.2	Traffic .....	1-1
1.3	Capacity and Level of Service .....	1-2
1.4	Roadway Functional Classification .....	1-3
1.5	RRR Design .....	1-3
1.6	Design Consistency and Driver Expectancy .....	1-4
1.7	Transportation Design for Livable Communities .....	1-5
	1.7.1 Policy Statement .....	1-5
	1.7.2 Aesthetics .....	1-6
1.8	Access Management .....	1-6
1.9	Design Speed .....	1-11

## Tables

1.8.1 Freeway Interchange Spacing .....	1-9
1.8.2 Arterial Access Management Classifications & Standards .....	1-9
1.8.3 Interim Standards (newly constructed or transferred roads) ...	1-10
1.8.4 Corner Clearance at Intersections, Isolated Corner Properties .	1-10
1.9.1 Design Speed State Highway System - Non-FIHS Facilities ...	1-12
1.9.2 Minimum Design Speed FIHS Facilities .....	1-12

# Chapter 1

## DESIGN CONTROLS

### 1.1 General

Designs for highway and street projects are normally based on established design controls for the various elements of the project, such as width of roadway, side slopes, horizontal and vertical alignment, drainage considerations and intersecting roads. Selection of the appropriate criteria and standards is influenced by traffic volume and composition, desired levels of service, functional classification, terrain features, roadside developments, environmental considerations and other individual characteristics.

The identification of applicable design controls is basic to providing the desired level of service, optimum safety, and cost effectiveness.

### 1.2 Traffic

It is the Department's responsibility to provide for an interconnected transportation system to insure the mobility of people and goods. In order to achieve these objectives, designers must determine if the proposed improvements will satisfy future needs by comparing the forecast directional hourly volume with the traffic handling capacity of an improved facility. Project traffic forecasts and capacity are used to establish the number of through lanes, length of auxiliary lanes, signalization timings, right-of-way requirements, etc., so that the facility will operate at an acceptable level of service through the design year.

Roadway geometric design shall be based on project traffic for the design year. The design year for new construction and reconstruction projects should be 20 years after the project is opened to traffic. The Design Hourly Volume (DHV) shall be the 30th highest hour.

Also, the traffic forecast is used in pavement design to determine the vehicular loadings on the pavement. The proposed pavement design must provide structural strength through the pavement's service life. On pavement rehabilitation, the design year for pavement design varies from 8 to 20 years based on the type of construction. The pavement design manuals provide guidance.

Traffic forecasts are developed during the Project Development and Environmental (PD&E) study of a project. A Traffic Report is generally required. When a PD&E study is not conducted, traffic forecasts must be prepared during the plans design process. Project traffic used for design must be attested to as shown in **Chapter 19**.

The following traffic information should be available to the designer prior to or very early

### in the design process

- 1 AADT for the current year, opening year (completion of construction) and design year
- 2 Existing hourly traffic volumes over minimum of 24 hour period, including peak hour turning movements and pedestrian counts
- 3 Directional distribution factor ( $D_{30}$ )
- 4 30th highest hour factor ( $K_{30}$ )
- 5 Truck factors (T) for daily and peak hour
- 6 Design speed and proposed posted speed
- 7 Design vehicle for geometric design
- 8 Turning movements and diagrams for existing and proposed signalized intersections
- 9 Special or unique traffic conditions, including during construction
- 10 Crash history, including analyses at high crash locations within the project limits
- 11 Recommendations regarding parking or other traffic restrictions

## 1.3 Capacity and Level of Service

The AASHTO publication ***A Policy on Geometric Design of Highways and Streets*** and the Transportation Research Board ***Highway Capacity Manual*** provide the detailed analysis and calculation guides necessary for the number and configurations of lanes required and the resulting levels of service provided. As illustrated in those texts, gradients, roadside developments, number, spacing and types of crossings and intersections, traffic volumes, and signalization patterns all greatly influence capacity and levels of services. Those factors, in addition to the roadway functional classification, have a direct influence on the design speed to be adopted at the preliminary design level.

Design of signalized intersections should ensure an adequate Level of Service through the design year of the facility, especially when right-of-way acquisition is being considered. The capacity of an at-grade arterial or collector is primarily controlled by its ability to move traffic through signalized intersections, rather than the mid-block through lane capacity.

The planning and the operational analyses methods in the ***Highway Capacity Manual*** may be used for design of signalized intersections. The planning analysis method generates a projection of the intersection capacity and an approximate signal timing plan. The designer must provide information or assumptions on basic intersection geometrics,

lane utilization, movement-specific traffic volumes, etc. The primary output of the operational analysis method is Level of Service at a signalized intersection, however, this method can alternatively output geometric requirements, signal timing or service flow volumes.

It is emphasized that signal timing is interactive with geometric design. That is, changes to geometrics such as adding a turn lane, must consider changes to the signal timing simultaneously. Department approved software, including the Highway Capacity Software, should be used to simulate the operation of independent or interconnected signals. Output from these programs can be used for the analysis and evaluation of proposed designs.

## 1.4 Roadway Functional Classification

The AASHTO *Policy on Geometric Design* presents an excellent discussion on highway functional classifications. *Florida Statutes, Title XXVI, Chapters 334, 335 and 336* give similar definitions, and establish classifications for road design in the State of Florida.

The Systems Planning Office, in compliance with *Rule Chapter 14-97* and the Florida Statutes, has developed a comprehensive Access Management Classification system for all segments of the State Highway System. The purpose is to enhance the functional integrity of the State Highway System, protect public safety and provide improved mobility of goods and people.

Functional and Access Management classification and the standards required by them are predetermined controls over which the designer has little choice.

These standards are minimum values, and values above the minimum should be used where possible and practical.

## 1.5 RRR Design

**Interstate Highways and Freeways** - Design standards applicable for these facilities are new construction standards, with the following exceptions:

- The standards used for horizontal alignment, vertical alignment, and widths of median, traveled way and shoulders may be the AASHTO interstate standards that were in effect at the time of original construction or inclusion into the interstate system.
- Mainline bridges may remain in place if they have minimum cross sections consisting of 12 ft lanes, 10 ft shoulder on the right and 3 ft shoulder on the left. For mainline bridges (over 200 ft), the offset to the face of parapet or bridge rail on both the left and right is 3 ft (minimum) measured from the edge of the nearest



traveled lane Bridge railing shall meet or be upgraded in accordance with the requirements of the **Structures Design Guidelines (SDG)**

Existing bridges can remain in place if the operating rating capacity can safely service the system for an additional 20-year service life

**State Highway System** - Design standards applicable for the State Highway System facilities, other than interstate and freeways, are contained in this manual The chapter on **Resurfacing, Restoration, and Rehabilitation (RRR)** replaces the **1988 RRR Manual**.

## 1.6 Design Consistency and Driver Expectancy

Design consistency is achieved when the geometric features of the roadway are consistent with the operational characteristics expected by the driver Inconsistencies normally relate to

- changes in design speed
- changes in cross section
- incompatibility in geometry and operational requirements

Changes in design speed may occur on a given stretch of roadway because portions of the highway were built as separate projects over an extended period of time Inconsistencies may be due to a number of factors changes in standards or FDOT policy, reclassification of the facility, and lack of necessary funding

There are two major types of design inconsistencies relative to cross section These are point inconsistencies and a general incompatibility between cross section and alignment A point inconsistency may be, for example, the narrowing of lane widths, a narrow bridge, a lane drop, or a change from multilane section to two lanes

A cross sectional inconsistency is usually the result of upgrading a highway cross section without upgrading the alignment Sometimes pavements are widened and shoulders added on an older two lane highway The wider cross section on an old alignment might convey a conflicting message to the driver and lead to an inappropriate expectancy based on the visual aspects of the cross section, because cross section features can be more apparent than the alignment

Of course, this is not to say that widening creates unsafe conditions Widening alone can measurably improve the safety characteristics of a road, particularly on very narrow, low-volume roads Designers should, however, be aware of potential inconsistencies that frequently can be overcome with relatively low cost treatments In the case of widened roads on old alignments, pavement markings, warning signs, and delineation devices can be very helpful to the driver

Inconsistencies may also relate to incompatibility in geometric and operational

requirements. Occasionally elements of the design appear to have been selected for the purpose of fitting together the geometric components conveniently and economically rather than for the purpose of satisfying operational requirements. An example of an inconsistency resulting from the incompatibility is a direct entry ramp which is intended to permit vehicles to enter the stream of traffic without coming to a complete stop but which, in reality, forces the vehicle to stop when a gap in the traffic stream is not immediately available.

Design inconsistencies can result in driver uncertainty, an increase in response time and an increase in the probability of inappropriate driver response.

Driver expectancy relates to the readiness of the driver to respond to events, situations, or the presentation of information. It can be defined as an inclination, based on previous experience, to respond in a set manner to a roadway or traffic situation. It should be stressed that the initial response is to the expected situation rather than the actual one.

Expectancy can affect the perception and use of information. In most circumstances, the expected and actual conditions are the same. However, when design inconsistencies occur and a driver's expectancy is incorrect, it takes longer to respond properly, there may be no response, or the response may be inappropriate to actual conditions.

There are certain elements in the design of various components of the roadway which particularly affect design consistency, driver expectancy, and vehicular operation. These components include horizontal and vertical alignment, embankments and slopes, shoulders, crown and cross slope, superelevation, bridge widths, signing and delineation, guardrail and placement of utility poles or light supports.

## **1.7 Transportation Design for Livable Communities (TDLC)**

### **1.7.1 Policy Statement**

In accordance with the Department's *Policy Statement for Transportation Design for Livable Communities (Topic 000-625-060)*, designs should consider the incorporation of TDLC features on the State Highway System when such features are desired, appropriate and feasible. TDLC features shall be based upon consideration of the following principles:

- Safety of pedestrians, bicyclists, motorists and public transit users
- Balancing community values and mobility needs
- Efficient use of energy resources
- Protection of the natural and manmade environment
- Coordinated land use and transportation planning
- Local and state economic development goals
- Complementing and enhancing existing standards, systems and processes

The incorporation of such features is a shared responsibility between the Department and local government. Design criteria in this manual should be used when implementing TDLC features.

### **1.7.2 Aesthetics**

Highways are built first and foremost for functional purposes, but the designer should be sensitive to how the highway will be perceived by the users. Designing-in aesthetics is more than just providing for landscape plantings. The roadway should blend into the landscape, avoiding large cuts and fills, and round side slopes into the existing terrain. Horizontal and vertical alignment should be coordinated so that a driver has an opportunity to gain a sense of the local environment. Combinations of horizontal and crest vertical curves, and broken-back curves should be avoided. Excessively long tangent sections become monotonous. Either curvature or other features should be added to maintain drivers' interest.

Application of the clear zone concept discussed in the chapter on Roadside Safety will result in a clean, uncluttered and pleasing roadside. Landscaping of the roadside should be considered early in the design process, so that plantings blend in with the geometric design. The Landscaping chapter of this volume discusses landscape design criteria. At times extra right-of-way may be obtained for treatments if the need is identified early. Retention/detention ponds and other wetlands can be attractive if well-designed and placed in a location where they can be viewed from the roadway.

Vistas of exceptional beauty should be accentuated by the roadway geometrics. Ideally, such vistas should be on the outside of horizontal curves, without excessive roadside appurtenances and signs to clutter the view.

"Streetscaping" techniques in urban areas include an emphasis on pedestrian accommodation, trees and other plantings, access control, careful signing, and zoning restrictions on commercial signs. Parkways and other roads specifically intended for pleasing aesthetics should be designed by a multidisciplinary team including landscape architects and planners.

## **1.8 Access Management**

Unregulated access to the State Highway System was determined to be one of the contributing factors to congestion and functional deterioration of the system. Regulation of access was necessary to preserve the functional integrity of the State Highway System and to promote the safe and efficient movement of people and goods within the state. Under *F.S. 335.18*, the Legislature authorized the Department to develop rules to

administer the "State Highway System Access Management Act " These are **Rule 14-96** and **14-97** In addition, the Department has adopted the **Median Opening Decision Process, Topic Number 625-010-020**, and the **Access Management and Median Opening Decision Principles and Process Directive, Topic Number 625-010-021**, which further define the principles and processes for the Department to implement the Access Management Statute and Rules

Each district has established an Access Management Review Committee to guide actions in access management and median decisions through all the Department's processes, and has assigned various offices the responsibility to permit connections and administer other parts of the program In order to adhere to the program, the designer must be familiar with the statute, the rules, adopted procedures and directives, and the district program In addition to driveway connections, features such as median openings affect safe and efficient operation It is critical that the designer know what access classification has been assigned to the highway segment under design and to determine what roadway features and access connection modifications are appropriate to adhere to the program

During the PD&E phase, a conceptual access management plan is prepared for the preferred alternative Access management issues are also addressed in the Preliminary Engineering (P E ) Report The designer should review these documents and the existing access management classification for information on access management decisions made during the PD&E process

During the development of construction plans, the designer should evaluate the access connections within the project limits Driveways and median openings should be considered in the analysis of safety and operational problems Modifications or closures to access may be the solution in certain cases **Rule 14-96.003 (3) & (4)** and **14-96.015** gives the Department the authority to alter, relocate or replace connections in order to meet current Department standards Furthermore, **Section 14-96.011** of the Rule allows the FDOT to revoke a permit "if the connection causes a safety or operational problem on the State Highway System substantiated by an engineering study "

**Rule 14-97** also provides guidance on the treatment of existing features in the highway improvement process

**14-97.003(1)(b)**

***(b) For the purpose of the interim standards for the assignment of an access classification to a segment of highway by the Department pursuant to Rule 14-97.004, permitted connections and those unpermitted connections exempted pursuant to Section 335.187(1), Florida Statutes, existing median openings, and signals are not required to meet the interim standards of the assigned classification. Such features will generally remain in place. These features shall be brought into reasonable***

***conformance with the standards of the assigned classification or the interim standards where new connection permits are granted for significant changes in property use, or as changes to the roadway design allow. Applicants issued permits based on the interim standards as set forth in Rule 14-97.004 shall not have to reapply for a new permit after formal classification of the roadway segment unless significant change pursuant to Rule Chapter 14-96 and Rule 14-97.002 has occurred***

In some cases where revisions are necessary due to operational or safety problems, it may not be possible to totally upgrade a median opening or connection to the newest standards because of existing conditions or constraints. In these cases, the designer should provide the best solution, based on good engineering practice. Early identification of access and median opening location in relation to individual parcels should be completed before appraisal. Access Management Directive 625-010-021 requires the following:

- (a) Any significant change to driveway access will be shown in plans or the driveway will be replaced in the same location, width and configuration (number of lanes)
- (b) Access design and impacts to a right-of-way acquisition parcel should be determined prior to appraisal
- (c) Changes to access details or decisions must be coordinated with District Right of Way and General Counsel's offices in addition to the Access Management Review Committee

Every owner of property which abuts a road on the State Highway System has a right to reasonable access to the abutting state highway but does not have a right to unregulated access to such highway. A means of reasonable access cannot be denied except on the basis of safety and operational concerns as provided in **s. 335.184**. Nothing in **s. 335.184** limits the Department's authority to restrict the operational characteristics of a particular means of access. Service roads provide reasonable access. Corner property can be given direct access by a "right-in" and/or "right-out" connection to the highway. More restricted access must be supported by a study that documents safety and operational problems.

It should be noted that if there are any conflicts between these guidelines and the statute and rules, the statute and rules shall govern.

## FLORIDA DOT ACCESS MANAGEMENT GUIDELINES RULE 14-97

**Table 1.8.1 Freeway Interchange Spacing**

Access Class	Area Type	Segment Location	Interchange Spacing (miles)
1	Area Type 1	CBD & CBD Fringe For Cities In Urbanized Areas	1 0
	Area Type 2	Existing Urbanized Areas Other Than Area Type 1	2 0
	Area Type 3	Transitioning Urbanized Areas And Urban Areas Other Than Area Type 1 or 2	3 0
	Area Type 4	Rural Areas	6 0

**Table 1.8.2 Arterial Access Management Classifications & Standards**

Access Class	Medians "Restrictive" physically prevent vehicle crossing. "Non-Restrictive" allow turns across at any point.	Connection Spacing (feet)		Median Opening Spacing (feet)		Signal Spacing (feet)
		>45 mph	≤45 mph	Directional	Full	
2	Restrictive with Service Roads	1320	660	1320	2640	2640
3	Restrictive	660	440	1320	2640	2640
4	Non-Restrictive	660	440			2640
5	Restrictive	440	245	660	*2640/ 1320	*2640/1320
6	Non-Restrictive	440	245			1320
7	Both Median Types	125		330	660	1320

\* 2640 feet for >45 mph , 1320 feet for ≤45 mph

**Table 1.8.3 Interim Standards  
 (newly constructed or transferred roads)**

Posted Speed (mph)	Connection Spacing (feet)	Median Opening Spacing (feet)		Signal Spacing (feet)
		Directional	Full	
35 mph or less "Special Cases"	125	330	660	1320
35 mph or less	245	660	1320	1320
36 - 45 mph	440	660	1320	1320
Over 45 mph	660	1320	2640	1320

**Table 1.8.4 Corner Clearance at Intersections  
 Isolated Corner Properties**

Median	Position	Access Allowed	Minimum (feet)	
<b>RESTRICTIVE</b>	Approaching Intersection	Right In/Out	115	Class 7 & Special Cases
	Approaching Intersection	Right In Only	75	
	Departing Intersection	Right In/Out	230	125
	Departing Intersection	Right Out Only	100	
<b>NON- RESTRICTIVE</b>	Approaching Intersection	Full Access	230	125
	Approaching Intersection	Right In Only	100	
	Departing Intersection	Full Access	230	125
	Departing Intersection	Right Out Only	100	

## 1.9 Design Speed

Design speed is a principal design control which regulates the selection of many of the project standards used to design a roadway project. The selection of an appropriate design speed must consider many factors. The AASHTO *“A Policy on Geometric Design of Highways and Streets,”* has a thorough discussion on design speed and these factors.

As a principal design control, design speed must be selected very early in the design process and must be documented in the project design file. Every effort should be made to **use as high a design speed as practical** to attain a desired degree of safety, mobility and efficiency. A design speed 5 to 10 mph greater than the expected posted speed will generally compensate for off-peak and overrunning speeds that can be expected. Design speed should never be less than the expected posted or legal speed limit. While the selected design speed will establish minimum geometric requirements necessary for safe operation (e.g., minimum horizontal curve radius and sight distance), this does not preclude the use of improved geometry (flatter curves or greater sight distances) where such improvements can be provided as a part of economic design. Increments of 5 mph should be used when selecting design speeds.

Definitions for high speed and low speed are provided in **Chapter 2**. Curbed sections are normally not used on high speed facilities. However, it is recommended a design speed of 50 mph be used on curbed sections when posted speeds as high as 45 mph are anticipated.

**Table 1.9.1** provides a recommended range of design speeds for new construction and reconstruction projects on the State Highway System except for facilities on the Florida Intrastate Highway System (FIHS). Design Speed for facilities on the FIHS shall meet or exceed the values in **Table 1.9.2**.

For design speed on RRR projects on the State Highway System, see **Chapter 25**. **Chapter 25** may be used for RRR projects on the FIHS. However, the minimum design speed in **Table 1.9.2** should be used when practicable, consistent with proposed improvements defined for the facility in the *Corridor Management Plan*. See **Topic Number 525-030-250, Procedure for the Development of the Florida Intrastate Highway System** for requirements.



**Table 1.9.1 Design Speed  
 State Highway System - Non-FIHS Facilities**

Facility		Design Speed (mph)
Freeways	Rural	70
	Urban	50 - 70
Arterials	Rural	55 - 70
	Urban	40 - 60
Collectors	Rural	55 - 65
	Urban	35 - 50

**Table 1.9.2 Minimum Design Speed  
 Florida Intrastate Highway System Facilities**

Facility		Minimum Design Speed (mph)
Interstate and Freeways	Rural and Urban	70
	Urbanized	60
Arterials	Rural	65
	Urban and Urbanized	50

**Note:** Design Speeds for FIHS facilities less than the above minimums shall be approved by the State Highway Engineer in accordance with the **FIHS Procedure (Topic No. 525-030-250)**.

## Chapter 2

### DESIGN GEOMETRICS AND CRITERIA

2.0	General	2-1
2.1	Lanes	2-3
2.1.1	Through or Travel Lanes	2-3
2.1.2	Other Lane Widths	2-3
2.1.3	Ramp Traveled Way Widths	2-3
2.1.4	Pedestrian and Bicycle Facilities	2-4
2.1.5	Cross Slopes	2-4
2.1.6	Roadway Pavement	2-5
2.1.7	Transitions of Pavement Widths	2-5
2.1.8	Maximum Number of Lanes on the State Highway System	2-5
2.2	Medians	2-5
2.2.1	Median Width for Roadways	2-5
2.2.2	Multilane Facility Median Policy	2-5
2.2.3	Median Treatments on Bridges	2-6
2.3	Shoulders	2-6
2.3.1	Limits of Friction Course on Shoulders	2-7
2.3.2	Shoulder Warning Devices (Rumble Strips)	2-7
2.4	Roadside Slopes	2-8
2.5	Borders	2-8
2.6	Grades	2-9
2.7	Sight Distance	2-10

2.8	Curves	2-10
2.8.1	Horizontal Curves	2-10
2.8.1.1	Supplemental Alignment Control (Mainline)	2-10
2.8.1.2	Supplemental Alignment Control (Intersections)	2-12
2.8.1.3	Roadway Transitions	2-12
2.8.2	Vertical Curves	2-12
2.9	Superelevation	2-13
2.10	Vertical Clearance	2-14
2.10.1	Vertical Clearance over Water	2-14
2.11	Horizontal Clearance and Clear Zone	2-15
2.12	(Reserved)	2-16
2.13	Intersections	2-16
2.13.1	Circular Intersections (Roundabouts)	2-16
2.13.2	Queue Length for Unsignalized Intersections	2-17
2.14	Interchanges	2-17
2.14.1	Limited Access Limits at Interchanges	2-17
2.14.2	Median Openings at Interchanges	2-18
2.14.3	Ramp Widths	2-18
2.15	Lighting Criteria	2-19
	Glossary of Terms	2-20

## Chapter 2

### DESIGN GEOMETRICS AND CRITERIA

#### 2.0 General

The implementation of design criteria is outlined in the following text

- 1 **Design Criteria:** The design criteria presented in this manual are intended as the principal source of criteria for the design of new construction or major reconstruction projects on the Florida State Highway System

These criteria are presented by subject for major design elements as fixed values or a range of acceptable values as defined by qualifiers

Where design criteria appear in the *Roadway and Traffic Design Standards*, they will be consistent with the criteria in this manual. In addition, some criteria will remain in the other chapters of this manual. When conflicts are discovered, they should be brought to the attention of the State Roadway Design Engineer or State Structures Design Engineer, as applicable, for resolution.

Design criteria for Resurfacing, Restoration, and Rehabilitation (RRR) is presented in **Chapter 25** of this manual and is applicable only on programmed RRR projects

Facilities on the Florida Intrastate Highway System (FIHS) are subject to special standards and criteria for number of lanes, design speed, access, level of service, and other requirements. These are identified in *Topic Number 525-030-250, Procedure for the Development of the Florida Intrastate Highway System*.

- 2 **Design Controls:** Design controls are characteristics and conditions that influence or regulate the selection of the criteria for project standards. It is the designer's responsibility to recognize and apply those controls applicable to the project.
- 3 **Design Standards:** The specific values selected from the design criteria become the design standards for a design project. These standards will be identified and documented by the designer.
- 4 **Project Parameters:** The properties or specific conditions with limits which require modification of design standards within these limits. The designer is responsible for establishing and documenting any project parameters and their limits, as part of the justification for deviations from project standards.

Many design standard considerations are related directly to the design speed, including vertical and horizontal geometry and required sight distances. The minimum design values are very closely related to traffic safety and cannot be compromised without an approved design exception or design variation. See **Chapter 23**.

Roadway and bridge typical sections developed for projects must reflect the values and properties outlined in Items 1-4 of this section. These typical sections shall include the location and limits of such features as lanes, medians, shoulders, curbs, sidewalks, barriers, railings, etc. **Section 16.2.3** of this manual gives the requirements for approval and concurrence of typical section packages.

Coordination is of primary importance on projects which contain both roadway and bridge typical sections. The Roadway and Structures Offices must address the compatibility of the typical section features mentioned above, and provide for an integrated design and review process for the project.

Example roadway typical sections are included in the exhibits in the back of the manual. Partial bridge sections, **Figures 2.0.1- 2.0.4**, at the beginning of the tables and figures section of this chapter, provide criteria regarding lanes, medians, and shoulders for various facilities. Subsequent sections of this chapter contain specific information and criteria regarding these and other typical section elements, as well as geometric features of both roadways and bridges.

**Figure Cross Reference**

<b>Table/Figure Number</b>	<b>Figure</b>	<b>Page</b>
Figure 2 0 1	Partial Bridge Sections, Divided Highways & Ramps	2-23
Figure 2 0 2	Bridge Section, Crowned Section (Flush Shoulders)	2-24
Figure 2 0 3	Partial Bridge Sections, Divided & Crowned (Urban)	2-25
Figure 2 0 4	Bridge Section, Crowned Median (Urban)	2-26

## 2.1 Lanes

Florida Department of Transportation (FDOT) criteria for lane widths and pavement slopes are given by highway type and area, through lanes, auxiliary lanes and other special lanes. Conditions and controls affecting the selection of project standards are listed in the criteria tables and figures.

### Criteria Tables and Figures Cross Reference

Table/Figure Number	Title	Page
Table 2 1 1	Lane Widths	2-27
Table 2 1 2	Lane Widths - Special	2-28
Table 2 1 3	Ramp Widths	2-28
Table 2 1 4	Maximum Number of Lanes on the State Highway System to be Provided by Department Funds	2-29
Figure 2 1 1	Standard Pavement Cross Slopes	2-30

#### 2.1.1 Through or Travel Lanes

Standard practice is to provide lane widths as wide as practical, up to 12 feet.

#### 2.1.2 Other Lane Widths

Collector-distributor lanes and auxiliary lanes for speed change, turning, storage for turning, weaving and other purposes supplementary to through-traffic movement should be of the same width as the through lanes.

#### 2.1.3 Ramp Traveled Way Widths

Ramp widths for tangent and large radii (500 ft or greater) sections are given in the criteria tables and figures. Ramp widths in other areas such as terminals are controlled by the curvature and the vehicle type selected as the design control and are given in **Table 2.14.1, Ramp Widths**. Typical details for ramp terminals are provided in the *Roadway and Traffic Design Standards*.

## 2.1.4 Pedestrian and Bicycle Facilities

### 2.1.4.1 Sidewalks

Sidewalks shall be considered on all projects in urbanized areas. Although the standard sidewalk width is 5 feet, it may be desirable to create wider sidewalks in business districts, near schools or where there are other significant pedestrian attractors. The District Bicycle/Pedestrian Coordinator shall be consulted during design to establish appropriate pedestrian elements on a project by project basis. **Chapter 8** contains additional guidelines for sidewalks.

### 2.1.4.2 Bicycle Facilities

Bicycle facilities shall be considered on all projects. Within an urbanized area or on projects with curb and gutter the bicycle facility shall be either designated or undesignated bike lanes. Bicycle lanes on the approaches to bridges should be continued across the structure. On projects in rural areas without curb either a bike lane or a paved shoulder shall be provided as a bicycle facility. However, when a project includes an intersection with a right turn lane an undesignated bike lane is to be included between the through lanes and the right turn lane.

The District Bicycle Coordinator should be consulted during design to establish appropriate bike elements, if any, on a project by project basis.

**Chapter 8** contains definitions for designated and undesignated bicycle lanes as well as additional guidelines for the accommodation of bicycles.

## 2.1.5 Cross Slopes

For roadways the maximum number of travel lanes with cross slope in one direction is three lanes. The algebraic difference in cross slope between adjacent through lanes should not exceed 0.04.

**Chapter 4** on **Roadside Safety** and **Chapter 8** on **Bicycle and Pedestrian Facilities** contain additional procedures and guidelines on slope design.

Cross slopes on bridges shall be on a uniform, straight-line rate, typically 0.02, in each traffic direction, with no break in slope. The straight-line slope shall be applied uniformly over all travel lanes and required shoulders in each direction of travel. Bridges with one-way traffic shall have one, uniform cross slope, while bridges with two-way traffic may be designed with a crowned bridge deck section.

This cross slope criteria applies to all bridge decks whether of cast-in-place concrete, precast concrete, or open steel decking.

Transitions shall be used to adjust for differences in cross-slope between the approach roadway section and the required straight-line slope for bridge decks. Whenever possible the transition should be accomplished on the roadway section, outside the limits of the bridge and approach slabs. This will require detailing of the transition(s) in the roadway plans. Coordination between the Roadway and Structures designers in the development of transitions is required to ensure compatibility and harmonizing at bridge approaches.

## 2.1.6 Roadway Pavement

The type of pavement usually is determined by analysis of the volume and composition of traffic, the soil conditions, the availability of materials, the initial cost and the estimated cost of maintenance

Criteria and procedures for selecting the type of pavement and the structural design of the various surfacing courses are discussed in the pavement design manuals

## 2.1.7 Transitions of Pavement Widths

When new pavement widths are not substantially greater than the joining pavement, grade differentials are slight and future widening is expected, striped transitions may be considered. An alternative approach is an abrupt change in width, with appropriate pavement markings, reflectors and rumble strips. The *Roadway and Traffic Design Standards* contain additional criteria and details.

## 2.1.8 Maximum Number of Lanes on the State Highway System

For the maximum number of lanes on the state highway system to be provided by Department funds, see the criteria tables and figures.

## 2.2 Medians

### 2.2.1 Median Width for Roadways

Median widths for roadways are given in the criteria tables and figures.

#### Tables and Figures Cross Reference

Table/Figure Number	Title	Page
Table 2 2 1	Median Widths	2-31

### 2.2.2 Multilane Facility Median Policy

All multilane facilities shall be designed with a raised or restrictive median except four-lane sections with design speeds of 40 mph or less. Facilities having design speeds of 40 mph or less are to include sections of raised or restrictive median for enhancing vehicular and pedestrian safety, improving traffic efficiency, and attainment of the standards of the Access Management Classification of that highway system.



### 2.2.3 Median Treatments on Bridges

For divided highways, the District will determine the desired distance between structures. **Figures 2.0.1 and 2.0.3** in this chapter, indicate that a full deck is recommended if the open space between the bridges is 20 ft or less and required when less than 10 ft. For structures with less than 20 ft of clearance, consult with District Structures and Facilities Maintenance before making a final decision.

Each District Office, in deciding on a single structure deck or twin bridges, must take into account the inspection and maintenance capabilities of its personnel and equipment. If the total width for a single structure exceeds the capacity of district maintenance equipment (approximately 60 ft reach), twin structures may be specified and the open distance between structures determined by the practical capability of the maintenance and inspection equipment. This is particularly important for girder superstructures because those areas that cannot be reached by topside equipment might require catwalks, ladders or other access features. Such features will add to the cost of superstructures and must be accounted for in the initial selection of alternates.

## 2.3 Shoulders

Roadway shoulder width, slope and superelevation criteria are provided in the criteria tables and figures. Paved outside shoulders, 5 ft in width, are required on all new construction, reconstruction and lane addition projects for all highways except freeways, which generally require a 10 ft paved outside shoulder.

Specific widths have also been adopted for interstate, expressway, single and double lane ramps and collector-distributor road shoulders. Total shoulder widths, paved shoulder widths, and widths of paved shoulder separations between through pavement edge and the near edge of any shoulder gutter are given for both right (outside) and left (inside) edges of the roadway. See Shoulders in the criteria tables and figures.

#### Criteria Tables and Figures Cross Reference

Table/Figure Number	Title	Page
Table 2 3 1	Shoulder Widths and Slopes - Freeways	2-32
Table 2 3 2	Shoulder Widths and Slopes - Arterials Divided	2-33
Table 2 3 3	Shoulder Widths and Slopes - Arterials Undivided	2-34
Table 2 3 4	Shoulder Widths and Slopes - Collectors Divided & Undivided	2-35
Figure 2 3 1	Shoulder Superelevation	2-36
Figure 2 3 2	Typical Paving Under Bridge for Outside Shoulders	2-37

**Roadway and Traffic Design Standards, Index 104**, provides additional details for paved shoulders.

**Figures 2.0.1 and 2.0.2** include criteria for shoulder widths on various bridge sections. Where these widths differ from those required for roadways or ramps, decisions about the final values chosen for the project must be coordinated between the Roadway and Structures Design Offices.

Generally, the outside shoulder width for bridges should be the same width as the approach roadway shoulder up to a maximum of 10 ft. On roadway alignments having 12 ft shoulders with continuous barrier walls and closely spaced bridges, a 12 ft bridge shoulder width may be considered. The decision to use 12 ft bridge shoulder widths should be coordinated with the District Design Engineer.

For shoulder cross slope criteria on bridges see **Section 2.1.5** of this chapter.

It is desirable to pave the median section and a 10 ft outside shoulder under overpass bridges. In addition, miscellaneous asphalt should be placed from the paved shoulder to the slope pavement. This pavement will provide additional safety, enhance drainage, reduce maintenance and improve appearance. See **Figure 2.3.2**.

For paved shoulders at railroad crossings see **Roadway and Traffic Design Standards, Index 560**.

### **2.3.1 Limits of Friction Course on Paved Shoulders**

Friction courses on limited access facilities shall be extended 1 ft onto both the median and outside paved shoulders of roadways.

Friction courses shall be extended the full width of the paved shoulder on non-limited access highways because of bicyclist usage. Terminating the friction course at the edge of travel lane or within the paved shoulder should be avoided to accommodate bicycles.

### **2.3.2 Shoulder Warning Devices (Rumble Strips)**

The safety of freeways and other limited access facilities on the State highway system is to be enhanced by the installation of shoulder warning devices in the form of rumble strips. Projects on limited access facilities shall include the construction of ground-in rumble strips. Several types of applications have been tested. The ground-in strips provide the desired warning to the driver and consistency in application has been possible using this construction process.

These ground-in strips are installed using two patterns. The skip array is the standard array. These are used on both inside and outside shoulders on divided highway sections. The continuous array shall be constructed in advance of bridge ends for a distance of 1000 ft or back to the gore recovery area for mainline interchange bridges. Other areas may be specified in plans.

Methods and types of application other than described above and in **Roadway and Traffic Design Standards, Index 518** shall not be used unless concurred in by the State Roadway Design Engineer. Approval will be considered only with sufficient documented

justification for deviation from the standard

**Roadway and Traffic Design Standards, Index 518** has been prepared to provide all needed details. This index also gives standards for raised rumble strips for use at structures where the bridge shoulder width is less than the width of the useable shoulder on the approach roadway. Notes for locations of raised rumble strip applications are also included on the index.

## 2.4 Roadside Slopes

Criteria and details are included in the criteria tables and figures and in **Chapter 4**

### Criteria Tables and Figures Cross Reference

Table/Figure Number	Title	Page
Table 2 4 1	Roadside Slopes	2-38

## 2.5 Borders

Border widths for new construction or major reconstruction where R/W acquisition is required are provided in the criteria tables and figures.

### Criteria Tables and Figures Cross Reference

Table/Figure Number	Title	Page
Table 2 5 1	Highways with Flush Shoulders	2-39
Table 2 5 2	Highways with Curbs and Curb and Gutter	2-40

On highways with flush shoulders the border is measured from the shoulder point to the right-of-way line. Border widths are to accommodate (1) roadside design components such as signing, drainage features, guardrail, fencing and recovery area, (2) the construction and maintenance of the facility and (3) permitted public utilities.

On highways with curb or curb and gutter, the border is measured from the lip of the gutter (or face of curb when there is not a gutter) to the right-of-way line. The border provides space for a buffer between vehicles and pedestrians, sidewalks with ADA provisions, traffic control devices, fire hydrants, storm drainage features, bus and transit features, permitted public utilities and space for aesthetic features such as sod and other landscape items. The functional needs and safety of the urban highway are of primary importance.

Projects involving bridges will require coordination to match the features of the roadway with those of the bridge.

On existing streets and highways where R/W cannot be acquired or where the decision has been made to simply maintain and preserve the facility, the border area must be reserved.

for the functional and safety needs of the facility. Extraordinary design effort will be required to meet ADA requirements, driveway construction and the other essential features. Spot R/W acquisitions may be required along the corridor to accommodate these essential components. The absolute minimum border under these conditions is 8 ft.

## 2.6 Grades

The profile grade line defines the vertical alignment for roadway and bridge construction. As with other design elements, the characteristics of vertical alignment are influenced greatly by basic controls related to design speed, traffic volumes, functional classification, drainage and terrain conditions. Within these basic controls, several general criteria must be considered.

**Criteria Tables and Figures Cross Reference**

<b>Table/Figure Number</b>	<b>Title</b>	<b>Page</b>
Table 2.6.1	Maximum Grades	2-41
Table 2.6.2	Maximum Changes in Grade without Vertical Curves	2-41
Table 2.6.3	Criteria for Grade Datum	2-42
Table 2.6.4	Grade Criteria for Curb and Gutter Sections	2-42

Minimum clearances for structures over railroads are given in **Table 2.10.1**. Additional information, including at-grade crossings, is given in **Chapter 6**.

The Department's minimum for structure clearance over all highways is given in the criteria tables and figures. Exceptions to this policy shall be permitted only when justified by extenuating circumstances and approved as a variation or exception.

Clearance required above design high water for roadway base courses is given in the criteria tables and figures. The limiting relationships between shoulder/pavement elevations vs. water elevations are discussed in the **FDOT Drainage Manual (Topic No. 625-040-001)**.

Grades for structures over water shall be designed to provide the desirable vertical clearance as stipulated in **Section 2.10** of this chapter.

The **Roadway and Traffic Design Standards** lists utility clearances and minimum covers and maximum fill heights for all types of culverts.

## 2.7 Sight Distance

Minimum stopping and passing sight distances are given in the criteria tables and figures

### Criteria Tables and Figures Cross Reference

Table/Figure Number	Title	Page
Table 2 7 1	Minimum Stopping Sight Distance	2-43
Table 2 7 2	Minimum Passing Sight Distance	2-43

## 2.8 Curves

### 2.8.1 Horizontal Curves

Design speed is the principal factor controlling horizontal alignment. Several geometric standards related to design speed are very specific. Other criteria cannot be defined as specifically and require that judgments be made by designers in consideration of local conditions.

#### 2.8.1.1 Supplemental Alignment Control (Mainline)

On projects which include roadways and bridges, coordination between the Roadway and Structures Design Offices may be necessary for those horizontal alignment issues affecting the location or geometry of the structure(s).

If possible, horizontal curves, PI's and superelevation transitions should not be placed within the limits of a structure or approach slabs. Because of the impact on the structure framing, spiral curves or alignments that result in skews greater than 45 degrees should be avoided. When skews greater than 45 degrees and/or spirals are necessary, specific justification shall be submitted to the District Design Engineer for concurrence, prior to proceeding with the alignment. For alignments that result in skews greater than 45 degrees, alternate framing concepts that relieve the severe skew effect should be considered. This may consist of longer bridges, placing framing members normal to the skew, etc.

Placement of stationing equations within the limits of a structure should be avoided on contract plans. Such equations unnecessarily increase the probability of error in both the design and construction phase.

Further guidelines have been established by the Department for lengths of horizontal curves, maximum deflections without curves, redirection of through lanes at intersections and minimum transition lengths between reverse curves. The criteria given are intended for use in establishing minimum lengths for both rural and urban conditions. See criteria tables and figures.

**Criteria Tables and Figures Cross Reference**

<b>Table/Figure Number</b>	<b>Title</b>	<b>Page</b>
Table 2 8 1a	Maximum Deflections without Horizontal Curves	2-44
Table 2 8 1b	Maximum Offset Deflection for Through Lanes Through Intersections	2-44
Table 2 8 2a	Length of Horizontal Curves	2-45
Table 2 8 2b	Arc Length of Compound Curves with One-Half/Double Radii - Turning Roadways	2-45
Table 2 8 3	Maximum Curvature of Horizontal Curve	2-46
Table 2 8 4	Maximum Horizontal Curvature Using 0 02 Cross Slopes	2-46

For small deflection angles ( $5^\circ$  or less) curves should be suitably lengthened to avoid the distracting appearance of a kink. Curves should be at least 500 ft long for a central angle of  $5^\circ$  and the minimum increased 100 ft for each  $1^\circ$  decrease in the central angle ( $900$  ft for a  $1^\circ$  central angle). This treatment may not be practical in developed or environmentally sensitive areas or for major modifications of existing facilities.

For design, the aesthetic control given above should be considered where practical, but may be compromised where other considerations warrant such action. Discernment of alignment changes in an urban setting is normally minimal due to the masking effects of development, traffic signs, various items of interest and similar distracting stimuli.

For information on the maximum deflection without a curve, see **Table 2.8.1**

When superelevation is required for curves in opposite directions on a common tangent, a suitable distance is required between the curves. This suitable tangent length should be determined as follows:

- 80% of the transition for each curve should be located on the tangent
- The suitable tangent length is the sum of the two 80% distances, or greater
- Where alignment constraints dictate a less than desirable tangent length between curves, an adjustment of the 80/20 superelevation transition treatment is allowed (where up to 50% of the transition may be placed on the curve)

The use of compound curves in horizontal alignment should be avoided where simple curves can be used. When compound curves are necessary on open highways, the ratio of the flatter radius to the sharper radius should not exceed 1.5:1. For turning roadways and intersections a ratio of 2:1 (where the flatter radius precedes the sharper radius in the direction of travel) is acceptable.

The length for compound curves for turning roadways when followed by a curve of one-half radius or preceded by a curve of double radius should be as shown in **Table 2.8.2b**

### 2.8.1.2 Supplemental Alignment Control (Intersections)

For redirection or offset deflection of through lanes through intersections see the values given in **Table 2.8.1b** Curves are not required for these angular breaks However, short curves may be desirable at each end, especially if pavement markings are used through the intersection to provide positive guidance to the motorist

### 2.8.1.3 Roadway Transitions

Transition details have been developed and included in the **Roadway and Traffic Design Standards** Transitions on curved alignment will require special design details in the contract plans

## 2.8.2 Vertical Curves

Minimum lengths for crest and sag vertical curves are provided in the criteria tables and figures

### Criteria Tables and Figures Cross Reference

Table/Figure Number	Title	Page
Table 2 8 5	Minimum Lengths of Crest Vertical Curves Based on Stopping Sight Distance	2-47
Table 2 8 6	Minimum Lengths of Sag Vertical Curves Based on Stopping Sight Distance and Headlight Sight Distance	2-48

## 2.9 Superelevation

Superelevation rates of 0.10 maximum (rural) and 0.05 maximum (urban) are used by the Department on the State Highway System. Charts for these rates are in the criteria tables and figures. Additional data is contained in the *Roadway and Traffic Design Standards, Indexes 510 and 511*.

The standard superelevation transition places 80% of the transition on the tangent and 20% on the curve. In special situations this treatment can be adjusted to allow up to 50% of the transition to be placed on the curve.

### Criteria Tables and Figures Cross Reference

Table/Figure Number	Title	Page
Table 2.9.1	Superelevation Rates for Rural Highways, Urban Freeways and High Speed Urban Highways	2-49
Figure 2.9.1	Superelevation Rates for Rural Highways, Urban Freeways and High Speed Urban Highways	2-50
Table 2.9.2	Superelevation Rates for Urban Highways, and High Speed Urban Streets	2-51
Figure 2.9.2	Superelevation Rates for Urban Highways, and High Speed Urban Streets	2-52
Table 2.9.3	Superelevation Transition Slope Rates for Rural Highways, Urban Freeways and High Speed Urban Highways	2-53
Table 2.9.4	Superelevation Transition Slope Rates for Urban Highways and High Speed Urban Streets	2-53



## 2.10 Vertical Clearance

Minimum vertical clearances, with the exception of structures over water (see **Section 2.10.1**), are contained in the criteria tables and figures

### Criteria Tables and Figures Cross Reference

Table/Figure Number	Title	Page
Figure 2 10 1	Clearances - Rural & Urban Freeways, Arterials and Collectors, with Projected 20-yr ADT 1500 or Greater	2-54
Figure 2 10 2	Clearances - Rural Arterials and Collectors, with Projected 20-yr ADT Less than 1500	2-55
Figure 2 10 3	Clearances - Urban Arterials and Collectors (Without Curb & Gutter)	2-56
Figure 2 10 4	Clearances - Urban Arterials and Collectors (Curb & Gutter)	2-57
Table 2 10 1	Vertical Clearances for Bridges	2-58
Table 2 10 2	Minimum Vertical Clearances for Signs	2-59
Table 2 10 3	Minimum Vertical Clearances for Signals	2-59

### 2.10.1 Vertical Clearance over Water

The minimum vertical clearance for structures over water are as follows

#### Environment:

1) For concrete superstructures classified as moderately aggressive or extremely aggressive due to chloride content, the minimum vertical clearance is 13 ft above Mean High Water (MHW)

2) For steel superstructures, the minimum vertical clearance shall be obtained from the District Maintenance Engineer, but shall not be less than those specified above for the concrete superstructures

#### Drainage:

The minimum vertical clearance requirement shall also conform with the ***FDOT Drainage Manual, Chapter 4 (Topic No. 625-040-001)***

### **Navigation:**

The minimum vertical clearance for navigational purposes shall be determined in accordance with the ***FDOT Drainage Manual, Chapter 4***, unless the agency having jurisdiction over the waterway has a more stringent requirement

Information on the Normal High Water, control water elevation, or Mean High Water can be obtained from the appropriate Drainage Design Engineer

Widening of existing structures which do not meet the minimum vertical clearance criteria stated above (either before or after the widening) may be justified hydraulically and/or economically. However, the encroachment of vertical clearance criteria may be limited and must be approved by the agency having jurisdiction over the navigable waterway

## **2.11 Horizontal Clearance and Clear Zone**

Horizontal clearance is the lateral distance from a specified point on the roadway such as the edge of travel lane or face of curb, to a roadside feature or object. Horizontal Clearance applies to rural and urban highways with either flush shoulders or with curbs. Horizontal clearance requirements vary depending on the type of roadway and the feature or object.

For roadways with flush shoulders, horizontal clearance requirements for certain features and objects are based on the clear zone width. That is, the feature or object is to be outside the clear zone. Clear zone is the roadside area available for safe use by errant vehicles. This zone may consist of a shoulder, a recoverable slope, a non-recoverable slope, and/or a clear runout area. Clear zone is further described in **Chapter 4**.

For roadways with curbs, the presence of curb conflicts with the clear zone concept and it is often not practical to provide full clear zone widths due to restricted right of way. Therefore, while there are specific horizontal clearance requirements for curbed roadways, these are not based on clear zone widths.

Roadway horizontal clearances and clear zone requirements are contained in the criteria tables and figures.

### Criteria Tables and Figures Cross Reference

Table/Figure Number	Title	Page
Table 2 11 1	Horizontal Clearance for Traffic Control Signs	2-60
Table 2 11 2	Horizontal Clearance for Light Poles	2-60
Table 2 11 3	Horizontal Clearance for Utility Installations	2-60
Table 2 11 4	Horizontal Clearance to Signal Poles and Controller Cabinets for Signals	2-61
Table 2 11 5	Horizontal Clearance to Trees	2-61
Table 2 11 6	Horizontal Clearance to Bridge Piers and Abutments	2-61
Table 2 11 7	Horizontal Clearance to Railroad Grade Crossing Traffic Control Devices	2-61
Table 2 11 8	Horizontal Clearance to Other Roadside Obstacles	2-61
Figure 2 11 1	Horizontal Clearance to Guardrail	2-62
Table 2 11 9	Clear Zone Widths	2-63
Table 2 11 10	Clear Zone Widths on Curved Alignments on Highways with Flush Shoulders	2-64

For horizontal clearances where roadways overpass railroads refer to **Chapter 6** of this manual

## 2.12 (Reserved)

## 2.13 Intersections

Design guides and criteria presented heretofore are also applicable to the proper design of intersections

### 2.13.1 Circular Intersections (Roundabouts)

The circular intersection with all yield control is another design concept for the designer to consider. Two critical elements of the small circular traffic pattern with a central island are as follows:

- Entry is by gap acceptance by having a yield condition at all entry legs
- Speeds through the intersection are 25 mph or less

The use of this design is best for low speed facilities. Its use should be documented by a complete intersection analysis and study, including alternate types of design.

The **Florida Roundabout Guide** (available through FDOT Maps and Publication Sales) presents a methodology for identifying appropriate roundabout sites and estimating roundabout capacity and delay. It describes the design principles and standards to which roundabouts installed on state roadways must conform and offers guidelines for operational features such as signing, marking, lighting, landscaping, etc.

All roundabout designs must be approved by the State Roadway Design Engineer.

### 2.13.2 Queue Length for Unsignalized Intersections

Turn lanes should comply with **Roadway and Traffic Design Standards, Index 301** to the extent practical. The available queue length provided should be based on a traffic study.

For low volume intersections where a traffic study is not justified, a minimum queue length of 50 ft (2 vehicles) should be provided for rural areas and small urban areas, for other urban areas a minimum queue length of 100 ft (4 vehicles) should be provided.

## 2.14 Interchanges

Design guides and criteria presented heretofore and in the **Roadway and Traffic Design Standards** are also applicable to the proper design of interchanges with their inherent ramps, speed change, merging and weaving lanes. Where diamond ramps and partial cloverleaf arrangements intersect the crossroad at grade, an at-grade intersection is formed. In urbanized areas, high speed ramps, weaving areas and acceleration lanes are not appropriate. These ramp terminals should be designed as intersections consistent with the design speed and character of the roadway.

### Criteria Tables and Figures Cross Reference

Table/Figure Number	Title	Page
Table 2 14 1	Ramp Widths - Turning Roadways	2-65

### 2.14.1 Limited Access Right of Way Limits at Interchanges

The following criteria will be used in establishing limited access limits along cross roads at interchanges:

For rural interchanges, limited access will extend along the cross road to a point 300 ft minimum beyond the end of the acceleration or deceleration taper. In the event these points are not opposite, the point most remote from the project will be the control and the limited access on both sides will end at that station along the cross road. Where no taper is used, the limited access will be carried to a point 300 ft minimum beyond the radius point of the return. In this case also, the radius point

most remote from the project will control

For interchanges in urban areas, the criteria given above will apply except that the limited access will end a minimum of 100 ft beyond the end of taper or the radius point of the return

For unsymmetrical interchanges such as half-diamonds and partial cloverleaves, etc , the limited access right-of-way along the cross road on that side having no ramp will extend to a point opposite that point controlled by the ramp.

Limited access along cross roads overpassing (no interchange) limited access facilities shall be extended approximately 200 feet, measured from the mainline right of way line, along the cross road The fence is generally tied into the cross road structure end bent unless required along the cross road

Any reduction in the values shown above for limited access limits must be approved by FHWA for interstate projects and by the District Design Engineer for non-interstate limited access facilities

**Access Management Rule 14-97 standards (14-97.003(1)j)** regulate the location of driveway connections and median openings in interchange areas on arterial roads This standard should be applied in accordance with the District procedures for implementing the Rule, and should not be confused with minimum requirements for limited access right of way

### **2.14.2 Median Openings at Interchanges**

Median opening locations at interchanges on arterial roads must consider **Access Management Rule 14-97 (14-97.003(1)j)2** which states "The minimum distance to the first median opening shall be at least 1320 feet as measured from the end of the taper of the egress ramp " This standard is to be applied in accordance with the FDOT median opening decision process As a minimum, for all cross road facilities at interchanges in both rural and urban areas, a median opening may be centered no less than 50 ft beyond the end of limited access except that a minimum distance of 660 ft to the ramp median opening will be required In no case should access be permitted between the interchange proper and the median opening as established by this criteria

### **2.14.3 Ramp Widths**

Ramp widths for interchange ramp terminal design are given in **Table 2.14.1**

## 2.15 Lighting Criteria

Lighting Criteria is contained in the criteria tables and figures and in **Chapter 7**

### Criteria Tables and Figures Cross Reference

<b>Table/Figure Number</b>	<b>Title</b>	<b>Page</b>
Table 2 15 1	Conventional Lighting - Roadways	2-66
Table 2 15 2	Highmast Lighting - Roadways	2-66
Table 2 15 3	Underdeck Lighting - Roadways	2-66
Table 2 15 4	Rest Area Lighting	2-67
Table 2 15 5	Mounting Height Restrictions	2-67

## Glossary of Terms

In the application of the criteria in this manual, the following definitions are assigned for consistency of understanding and interpretation

- 1 **Arterials:** Divided or undivided, relatively continuous routes that primarily serve through traffic, high traffic volumes, and long average trip lengths. Traffic movement is of primary importance, with abutting land access of secondary importance. Arterials include expressways without full control of access, US numbered routes and principal state routes. May be classified as urban or rural.
- 2 **Auxiliary Lane:** The designated widths of roadway pavement marked to separate speed change, turning, passing and climbing maneuvers from through traffic. They may also provide short capacity segments.
- 3 **C-D Roads:** Collector-Distributor Roads are limited access roadways provided within a single interchange, or continuously through two or more interchanges on a freeway segment. They provide access to and from the freeway, and reduce and control the number of ingress and egress points on the through freeway. They are similar to continuous frontage roads except that access to abutting property is not permitted.
- 4 **Collectors:** Divided or undivided routes which serve to link arterial routes with local roads or major traffic generators. They serve as transition link between mobility needs and land use needs. Collectors include minor state routes, major county roads, and major urban and suburban streets.
- 5 **FIHS:** Florida Intrastate Highway System. An interconnected statewide system of limited access facilities and controlled access facilities developed and managed by the Department to meet standards and criteria established for the FIHS. It is part of the State Highway System, and is developed for high-speed and high-volume traffic movements. The FIHS also accommodates High-Occupancy Vehicles (HOVs), express bus transit and in some corridors, interregional and high speed intercity passenger rail service. Access to abutting land is subordinate to movement of traffic and such access must be prohibited or highly regulated.
- 6 **Freeways:** Divided arterial highways, with full control of access. Movement of traffic free of interference and conflicts is of primary importance. Essential elements include medians, grade separations, interchanges, and, in some cases, collector-distributor roads and frontage roads. Freeways include Interstate, toll road and expressway systems. May be classified as urban or rural.
- 7 **HOV Lane:** Special designated widths of pavement marked to provide travel lanes for high occupancy vehicles (HOV). They may be directly adjacent to other travel lanes or separated.
- 8 **Local Roads:** Routes which provide high access to abutting property, low average traffic volumes, short average trip lengths and on which through traffic movements are not of primary importance. Local roads include minor county roads, minor urban and suburban subdivision streets, and graded or unimproved roads.
- 9 **Rural Areas:** Places outside the boundaries of concentrated populations that

accommodate higher speeds, longer trip lengths and freedom of movement, and are relatively free of street and highway networks Rural environments are surroundings of similar characteristics

- 10 **Streets:** The local system which provides direct access to residential neighborhoods and business districts, connects these areas to the higher order road systems and offers the highest access to abutting property, sometimes deliberately discouraging through-traffic movement and high speeds

**Note:** Local roads and streets are not generally a part of the State Highway System and therefore, may not be governed by the FDOT roadway design criteria, but by the *Manual of Uniform Minimum Standards for Design, Construction and Maintenance for Streets and Highways* and/or criteria established by the local government

- 11 **Traffic Lane/Traveled Way:** The designated widths of roadway pavement, exclusive of shoulders, marked to separate opposing traffic or vehicles traveling in the same direction Traffic lanes include through travel lanes, auxiliary lanes, turn lanes, weaving, passing, and climbing lanes They provide space for passenger cars, trucks, buses, recreational vehicles and, in some cases, bicycles
- 12 **Travel Lane** The designated widths of roadway pavement marked to carry through traffic and to separate it from opposing traffic or traffic occupying other traffic lanes Generally, travel lanes equate to the basic number of lanes for a facility
- 13 **Roadway:** The portion of a highway, including shoulders, for vehicular use A divided highway has two or more roadways
- 14 **Urban Areas** Places within boundaries of concentrated populations, where density of street and highway networks, travel speeds, nature and composition of vehicles and pedestrian traffic dictate street and highway characteristics that promote lower speeds, better circulation movements, more delineation and traffic guidance devices, shorter trip lengths and provisions for pedestrians and bicycles Urban environments are surroundings of similar characteristics
- 15 **Urbanized Areas** Transitional zones between rural and urban areas, with characteristics approaching or similar to urban areas
- 16 **High Speed:** Descriptive term used to summarize all conditions governing the selection of Design Speeds 50 mph and greater
- 17 **Low Speed:** Descriptive term used to summarize all conditions governing the selection of Design Speed of less than 50 mph
- 18 **Truck Traffic** When significant, heavy, substantial, high percent, etc truck traffic is used as a qualifying control, it shall mean 10% of the AADT or 10% of the daily count (24 hr )
- 19 **Low Volume and High Volume** Descriptive term used to describe certain operating characteristics and driver expectancy on highways Criteria for some elements are selected according to these qualifying controls Standards for these controls are given in the following table



**STANDARDS FOR LOW AND HIGH VOLUME HIGHWAYS  
 IN ANNUAL AVERAGE DAILY VOLUMES**

<b>HIGHWAY TYPE</b>	<b>LOW VOLUME AADT</b>	<b>HIGH VOLUME AADT</b>
<b>FREEWAY - URBAN</b>		
4-LANE FACILITY	57,000	69,000
6-LANE FACILITY	86,000	103,000
8-LANE FACILITY	114,000	138,000
<b>FREEWAY - RURAL</b>		
4-LANE FACILITY	46,000	56,000
6-LANE FACILITY	69,000	83,000
8-LANE FACILITY	92,000	111,000
<b>ARTERIALS - URBAN</b>		
2-LANE FACILITY	16,000	20,000
4-LANE FACILITY	37,000	43,000
6-LANE FACILITY	55,000	64,000
8-LANE FACILITY	69,000	80,000
<b>ARTERIALS - RURAL</b>		
2-LANE FACILITY	9,000	14,000
4-LANE FACILITY	38,000	47,000
6-LANE FACILITY	58,000	71,000
<b>COLLECTOR - URBAN</b>		
2-LANE FACILITY	11,000	16,000
4-LANE FACILITY	37,000	45,000
<b>COLLECTOR - RURAL</b>		
2-LANE FACILITY	8,000	13,000
4-LANE FACILITY	30,000	38,000
<b>LOW VOLUME</b>	FACILITIES ARE HIGHWAY TYPES WITH PROJECTED DESIGN YEAR AADT VOLUME EQUAL TO OR LESS THAN THE LOW VOLUME VALUES SHOWN	
<b>HIGH VOLUME</b>	FACILITIES ARE HIGHWAY TYPES WITH PROJECTED DESIGN YEAR AADT VOLUME EQUAL TO OR GREATER THAN THE HIGH VOLUME VALUES SHOWN	

**Figure 2.0.1 Partial Bridge Sections**

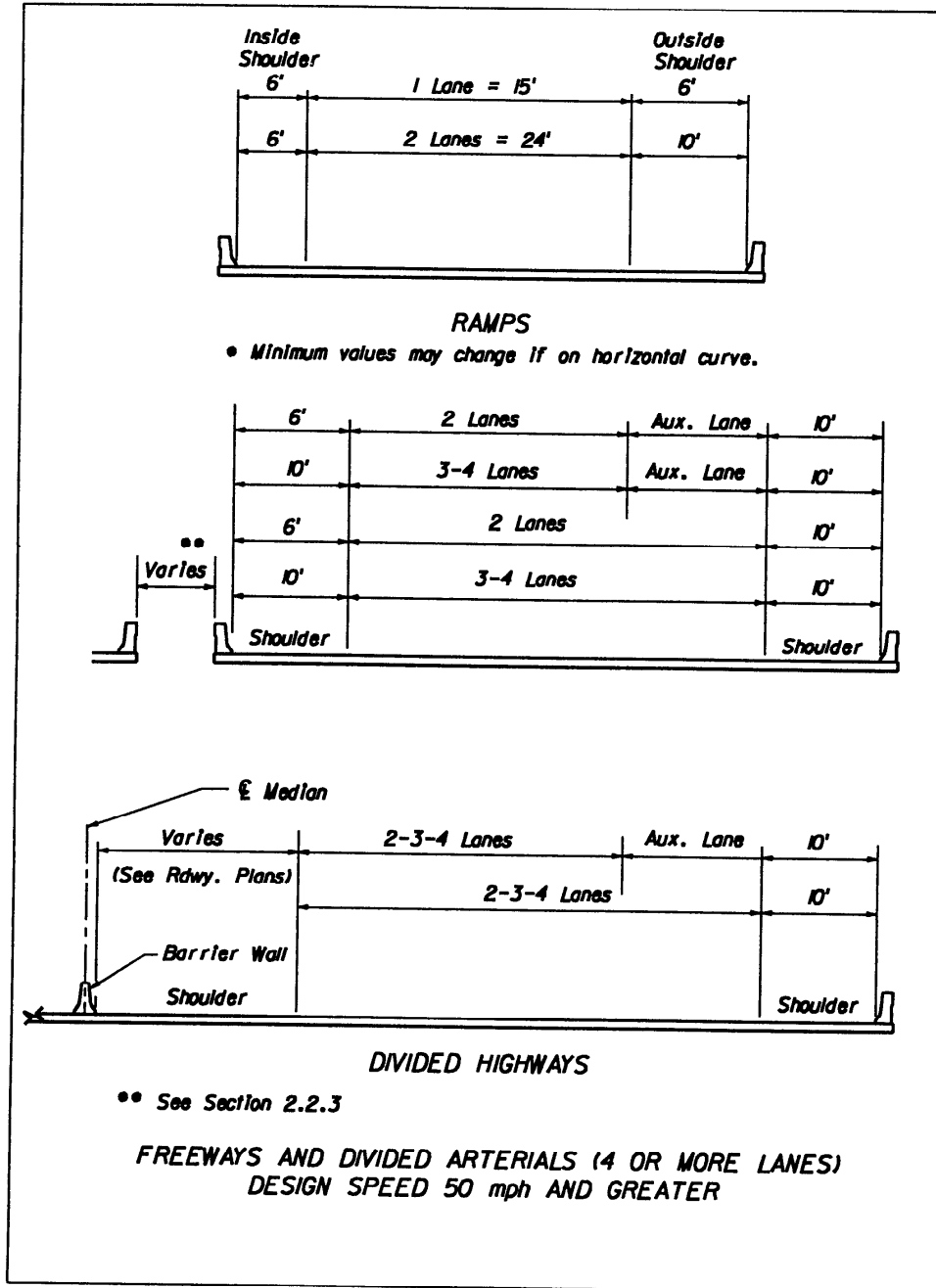

**Figure 2.0.2 Bridge Section**

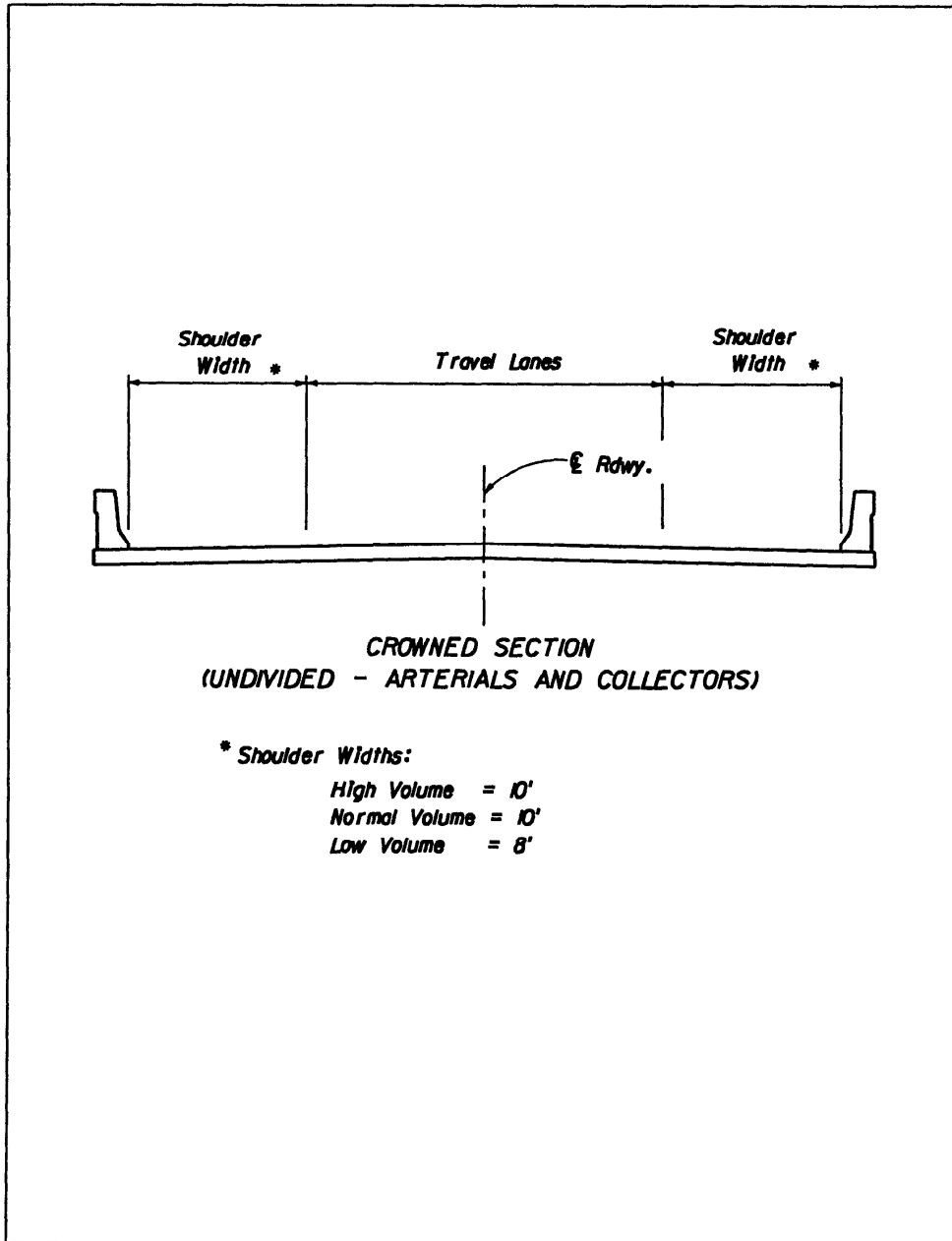

**Figure 2.03 Partial Bridge Sections**

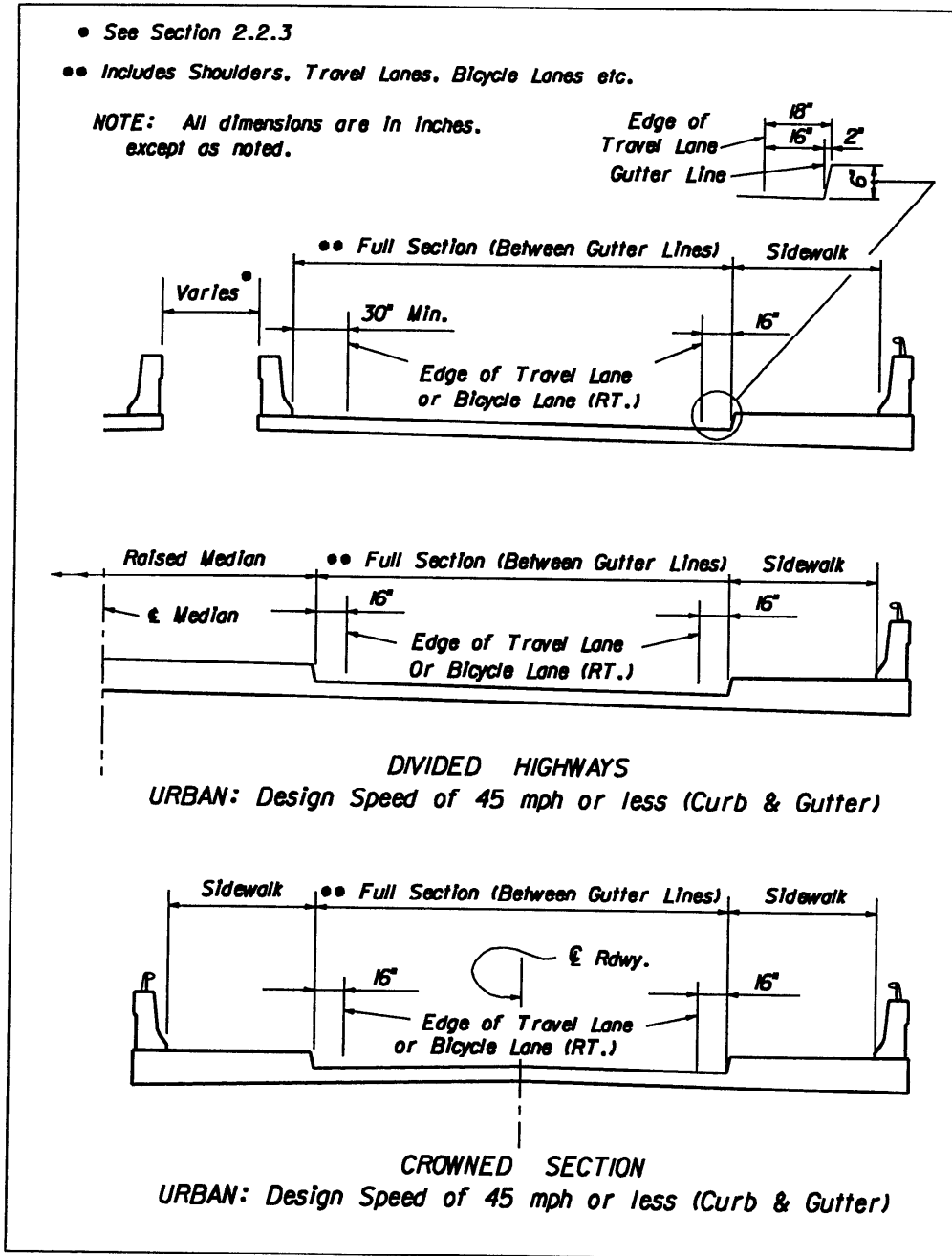
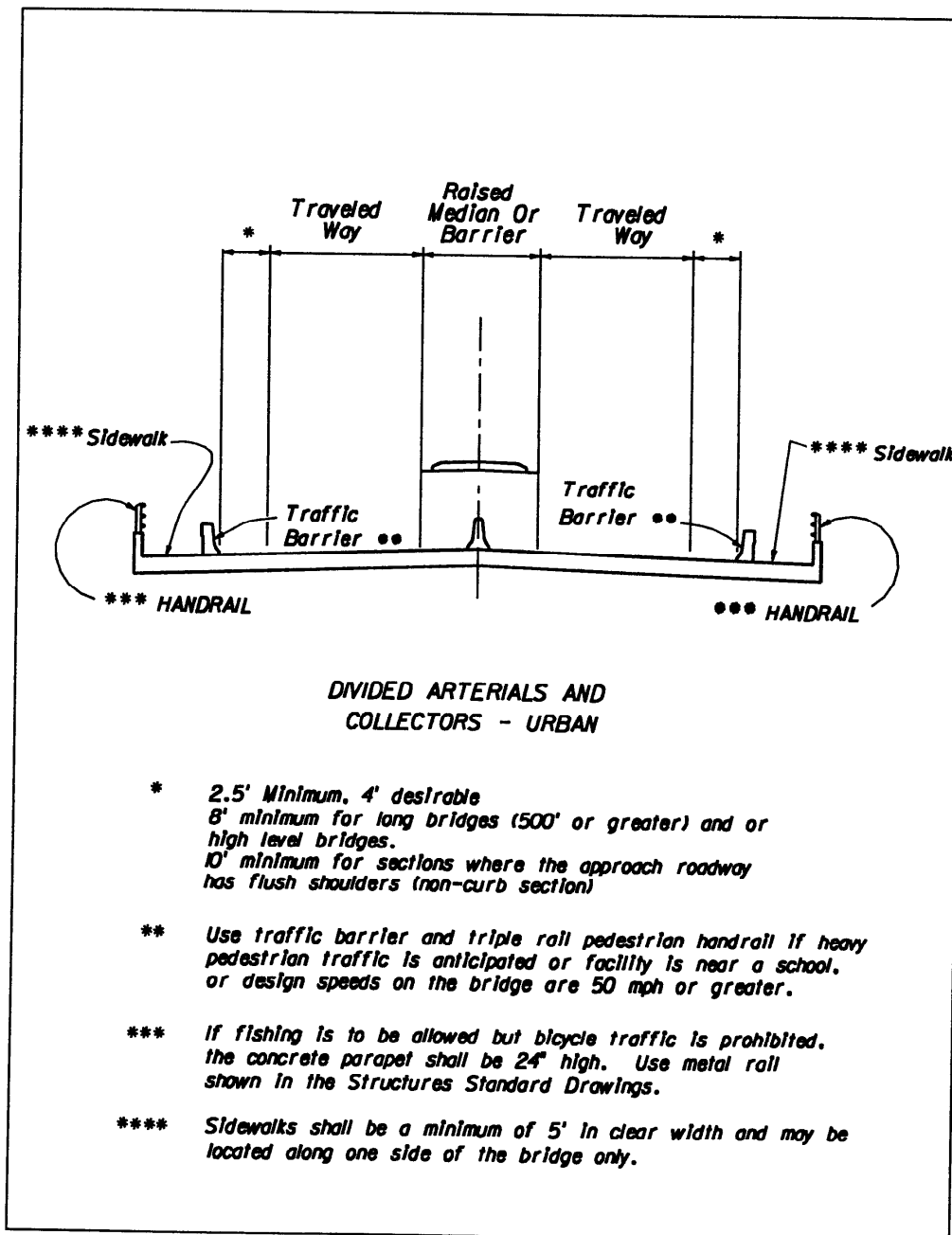

Figure 2.0.4 Bridge Section



## 2.1 Lanes

**Table 2.1.1 Lane Widths**

LANE WIDTHS (FEET)						
FACILITY		THROUGH OR TRAVEL	AUXILIARY			
TYPE	AREA		SPEED CHANGE	TURNING (LT/RT/MED)	PASSING	CLIMBING
FREEWAY	Rural	12	12	----	----	12
	Urban	12	12	----	----	12
ARTERIAL	Rural	12	12	12	12	12
	Urban	12 <sub>1</sub>	12 <sub>1</sub>	12 <sub>1,4</sub>	12 <sub>1</sub>	12
COLLECTOR	Rural	12 <sub>6</sub>	11 <sub>2</sub>	11 <sub>2,4</sub>	11 <sub>2,5</sub>	12
	Urban	11 <sub>3</sub>	11 <sub>3</sub>	11 <sub>3,4</sub>	11 <sub>3</sub>	12

1 11 ft permitted on non-FIHS roads if one of these conditions exist

- R/W and existing conditions are stringent controls
- Facility operates on interrupted flow conditions
- Design speed 40 mph or less
- Intersection capacity not adversely affected
- Truck volume 10% or less

2 12 ft lanes for all 2-lane rural

3 12 ft lanes in industrial areas when R/W is available

4 With severe R/W controls, 10 ft turning lanes may be used where design speeds are 40 mph or less and the intersection is controlled by traffic signals Median turn lanes shall not exceed 15 ft

5 12 ft when truck volume more than 10%

6 11 ft for low volume AADT

## 2.1 Lanes

**Table 2.1.2 Lane Widths - Special**

LANE WIDTHS (FEET)					
FACILITY		SPECIAL			
TYPE	AREA	HOV	BICYCLE	OFF SYSTEM DETOUR	URBAN MULTI- PURPOSE <sub>5</sub>
FREEWAY	Rural	12	----	11 <sub>4</sub>	----
	Urban	12	----	11 <sub>4</sub>	----
ARTERIAL	Rural	12	5 <sub>2</sub>	11	----
	Urban	12	4 <sub>3</sub>	11	8 <sub>6</sub>
COLLECTOR	Rural	----	5 <sub>2</sub>	11	----
	Urban	----	4 <sub>3</sub>	11	8 <sub>6</sub>

1 Separated or concurrent flow  
 2 Designated or undesignated shoulder pavement  
 3 Designated or undesignated  
 4 For Freeway detours, at least one 12 ft lane must be provided in each direction  
 5 Urban multi-purpose lanes are usually used as refuge lanes but may be used for loading zones, bus stops, emergency access and other purposes. Parking that adversely impacts capacity or safety is to be eliminated whenever practical. Standard parking width is measured from lip of gutter, with a minimum width of 8 ft measured from face of curb  
 6 10 ft to 12 ft lanes for commercial and transit vehicles

**Table 2.1.3 Ramp Widths**

RAMP WIDTHS (RAMP PROPER) FOR TANGENT AND LARGE RADII (≥500 ft.) SECTIONS	
ONE LANE RAMPS	15 ft
TWO LANE RAMPS	24 ft

For ramp widths at turning roadways see **Table 2.14.1**

## 2.1 Lanes

**Table 2.1.4 Maximum Number of Lanes on the State Highway System to be Provided by Department Funds**

FLORIDA INTRASTATE HIGHWAY SYSTEM (FIHS)	URBANIZED AREAS	NON-URBANIZED AREAS
Turnpike Mainline <sub>1</sub>	N/A	4 Lanes
Limited Access Highways <sub>2</sub>	10 Lanes <sub>3</sub>	6 Lanes
Controlled Access Highways <sub>4</sub>	6 Lanes (4 Minimum)	6 Lanes (4 Minimum)
FLORIDA NON-INTRASTATE HIGHWAY SYSTEM	URBANIZED AREAS	NON-URBANIZED AREAS
Limited Access Highways	10 Lanes <sub>3</sub>	6 Lanes
Other State Highways <sub>5</sub>	6 lanes	4 Lanes

**Footnotes:**

- 1 "Turnpike Mainline" - means Florida's Turnpike from the vicinity of the Palm Beach/Martin County line to Kissimmee
- 2 "Limited Access" includes the Interstate System, Turnpike facilities not on the Turnpike Mainline, and additional limited access facilities on the State Highway System
- 3 Limited access facilities will be limited to six lanes. In all urbanized areas with populations greater than 200,000 persons, in addition to these six lanes, the ultimate improvement may include up to four physically separated exclusive lanes (two in each direction) for through traffic, public transit vehicles and other high occupancy vehicles. Where provided, access to and egress from these exclusive lanes within the urbanized area will be restricted to public transit and high occupancy vehicles.
- 4 Florida Intrastate Highway System (FIHS) Controlled Access facilities will be a minimum of four and a maximum of six lanes with a restricted median. Interim upgrades to existing two lane facilities will be considered.
- 5 Other non-FIHS state highways will be limited to six lanes in urbanized areas greater than 50,000 population and four lanes outside such urbanized areas.

**General Notes:**

- 1 Any needed capacity beyond the maximum number of lanes may be provided by other transportation alternatives and strategies and acquisition of sufficient right of way for alternative transportation options. Emphasis on the development of intercity rail service will be placed on the following corridors:
  - Tampa - Orlando
  - Miami - Tampa
  - Orlando - Miami
  - Orlando - Jacksonville
 Additional corridors may be added based on favorable rail-related market/ridership assessments.
- 2 Exceptions to this Policy (Topic No. 000-525-040-a, s. 335.02(3), F.S.) will be addressed on a case by case basis, with final approval resting with the Secretary of Transportation.



## 2.1 Lanes

**Figure 2.1.1 Standard Pavement Cross Slopes**

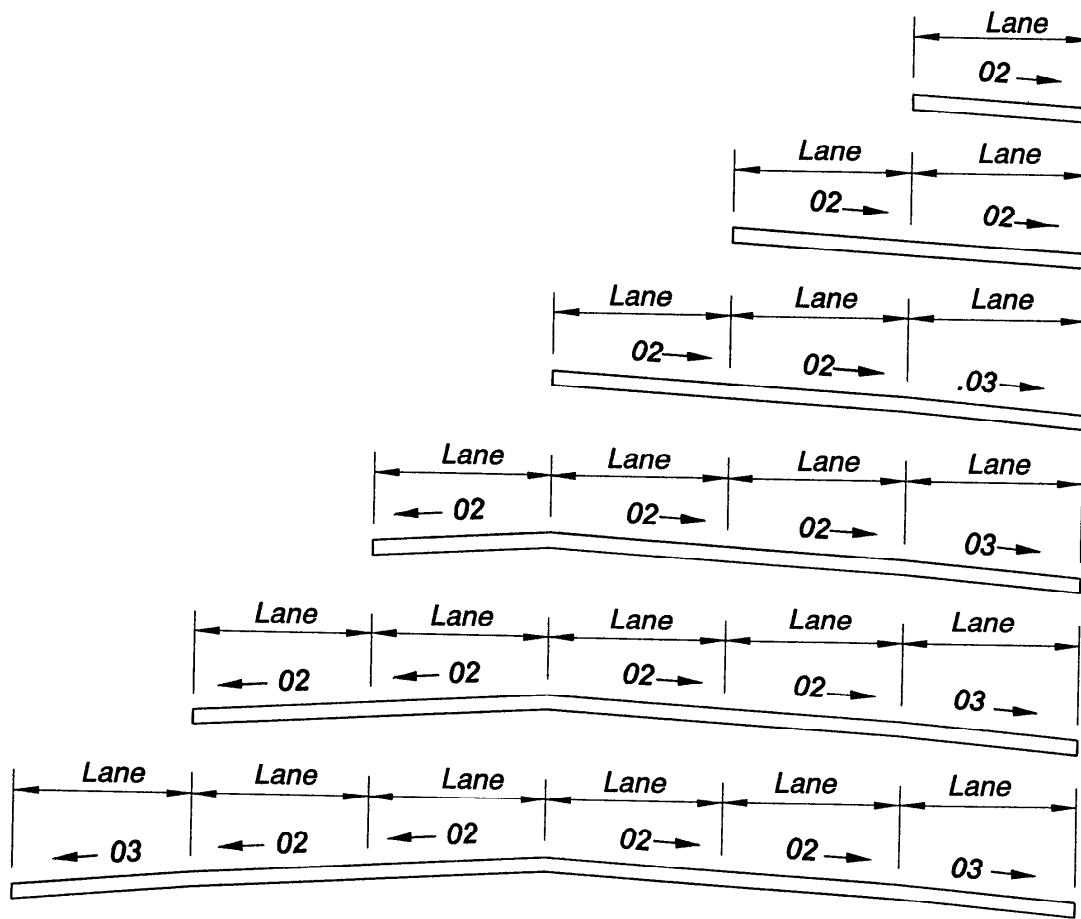

### All Lanes One Direction

These sections show only the standard slopes for adjoining travel lanes, they do not prescribe needed lanes, lane usage or typical section requirements other than lane slope. These slopes are not applicable to parabolic crowns.

Maximum pavement cross slopes on tangent sections are  
 0.04 for design speeds of 45 mph or less  
 0.03 for design speeds greater than 45 mph

The change in cross slope between adjacent through lanes shall not exceed 0.04

Slopes on multi-purpose lanes may be 0.03 to 0.05. Portions of multi-purpose lanes that are reserved for parking and access isles for the physically handicapped shall have cross slopes not exceeding 1.50 (0.02) in all directions.

## 2.2 Medians

**Table 2.2.1 Median Widths**

<b>MEDIAN WIDTHS (FEET)</b>	
<b>TYPE FACILITY</b>	<b>WIDTH</b>
<b>FREEWAYS</b>	
Interstate, Without Barrier	64 <sub>1</sub>
Other Freeways, Without Barrier	
Design Speed $\geq$ 60 mph	60
Design Speed $<$ 60 mph	40
All, With Barrier, All Design Speeds	26 <sub>2</sub>
<b>ARTERIAL AND COLLECTORS</b>	
Design Speed $>$ 45 mph	40 <sub>5</sub>
Design Speed $\leq$ 45 mph	22 <sub>3</sub>
Paved And Painted For Left Turns	12 <sub>4</sub>
<p>Median width is the distance between the inside (median) edge of the travel lane of each roadway</p> <p>1 88 ft when future lanes planned</p> <p>2 Based on 2 ft median barrier and 12 ft shoulder</p> <p>3 On reconstruction projects where existing curb locations are fixed due to severe right of way constraints, the minimum width may be reduced to 19.5 ft for design speeds = 45 mph, and to 15.5 ft for design speeds <math>\leq</math> 40 mph</p> <p>4 Restricted to 5-lane sections with design speeds <math>\leq</math> 40 mph On reconstruction projects where existing curb locations are fixed due to severe right of way constraints, the minimum width may be reduced to 10 ft These flush medians are to include sections of raised, restrictive median for pedestrian refuge and to conform with Section 2.2.2 of this manual and the Access Management Rules</p> <p>5 Curb sections with design speed of 50 mph which are posted at 45 mph or less may be 22 ft</p>	

## 2.3 Shoulders

**Table 2.3.1 Shoulder Widths and Slopes - Freeways**

HIGHWAY TYPE		WIDTH (FEET)								SLOPES		
		WITHOUT SHOULDER GUTTER				WITH SHOULDER GUTTER						
		FULL WIDTH		PAVED WIDTH		FULL WIDTH		PAVED WIDTH		NORMAL <sub>1</sub>		
		Outside	Median or Left	Outside	Median or Left	Outside	Median or Left	Outside	Median or Left	Outside	Median or Left	
FREEWAYS (Lanes One Way)	4-Lane or More	12	12	10	10	15 5	15 5	8	8	06	06	
	3-Lane	12	12	10	10	15 5	15 5	8	8		05	
	2-Lane	12	8	10	4	15 5	13 5	8	6			
	HOV Lane	N/A	14	N/A	10	N/A	N/A	N/A	N/A	N/A	05 <sub>2</sub>	
	1-Lane Ramp	6	6	4	2	11 5	11 5	4 <sub>3</sub>	4	06	05	
	2-Lane Ramp Non-Interstate	10	8	8	4	15 5	13 5	8	6			
	2-Lane Ramp Interstate	12	8	10	4	15 5	13 5	8	6			
	C-D Road 1-Lane	6	6	4	2	11 5	11 5	4	4			
	C-D Road 2-Lane	12	8	10	4	15 5	13 5	8	6			
	C-D Road 3-Lane	12	12	10	10	15 5	15 5	8	8			
	C-D Road > 3-Lane	12	12	10	10	15 5	15 5	8	8			06
	Auxiliary Lane Climbing & Weaving	3 6	N/A	10	N/A	15 5	N/A	8	N/A			N/A
	Auxiliary Lane Mainline Terminal											
	1-Lane Ramp	8	N/A	6	N/A	11 5	N/A	4	N/A			N/A
2-Lane Ramp	12	N/A	10	N/A	15 5	N/A	8	N/A	N/A			
Frontage Road	See COLLECTORS Table 2 3 4											
	For Local Roads And Streets See The FDOT "Manual Of Uniform Mimimum Standards For Design, Construction And Maintenance For Streets and Highways "											

1	Shoulders shall extend 4 ft back of shoulder gutter and at a 0 06 slope back toward the gutter
2	0 06 when 4 lanes or more combined
3	Shoulder pavement less than 6 ft in width that adjoins shoulder gutter shall be the same type, depth and slope as the ramp pavement

## 2.3 Shoulders

**Table 2.3.2 Shoulder Widths and Slopes - Arterials Divided**

HIGHWAY TYPE		WIDTH (FEET)								SLOPES	
		WITHOUT SHOULDER GUTTER				WITH SHOULDER GUTTER					
		FULL WIDTH		PAVED WIDTH		FULL WIDTH		PAVED WIDTH		NORMAL <sub>1</sub>	
		Outside	Median or Left	Outside <sub>2</sub>	Median or Left	Outside	Median or Left	Outside	Median or Left	Outside	Median or Left
ARTERIALS Divided (Lanes One Way)	4-Lane	12 10 8	12 10 8	5 5 5	4 4 4	15 5 15 5 15 5	15 5 15 5 13 5	8 8 6	8 8 6	06	
	3-Lane	12 10 8	12 10 8	5 5 5	0 <sub>4</sub> 0 <sub>4</sub> 0 <sub>4</sub>	15 5 15 5 13 5	15 5 15 5 13 5	8 8 6	8 8 6		05
	2-Lane	12 10 8	8 8 6	5 5 5	0 <sub>4</sub> 0 <sub>4</sub> 0 <sub>4</sub>	15 5 15 5 13 5	13 5 13 5 11 5	8 8 6	6 6 4		
	1-Lane Ramp	6	6	5	2	11 5	11 5	4 <sub>3</sub>	4		
	2-Lane Ramp	10	6	5	2	15 5	13 5	8	6		
	C-D Road 1-Lane	6	6	5	2	11 5	11 5	4	4	06	
	C-D Road 2-Lane	8	6	5	0	13 5	11 5	6	4		
	Auxiliary Lane Climbing & Weaving	Same As Travel Lanes	N/A	Same As Travel Lanes	N/A	Same As Travel Lanes	N/A	Same As Travel Lanes	N/A	N/A	N/A
	Auxiliary Lane Mainline Terminal 1-Lane Ramp 2-Lane Ramp	8 12	N/A N/A	5 10	N/A N/A	11 5 15 5	N/A N/A	4 8	N/A N/A	N/A N/A	N/A N/A
	Auxiliary Lane At-Grade Intersection	Same As Travel Lanes	Same As Travel Lanes	5	0	11 5	N/A	4	N/A	N/A	05- 06
Frontage Road	See <b>Collectors</b> Table 2 3 4 For Local Roads And Streets see the FDOT "Manual Of Uniform Minimum Standards For Design, Construction And Maintenance For Street And Highways "										

1 Shoulders shall extend 4 ft back of shoulder gutter and have a 0 06 slope back toward the gutter  
 2 Shoulder shall be paved full width through rail-highway at-grade crossings, extending a minimum distance of 50 ft on each side of the crossing measured from the outside rail For additional information see Standard Index No 17882  
 3 Shoulder pavement less than 6 ft in width and adjoining shoulder gutter shall be the same type, depth and slope as the ramp pavement  
 4 Paved 2 ft wide where turf is difficult to establish Paved 4 ft wide (a) in sag vertical curves, 100 ft minimum either side of the low point, and (b) on the low side of superelevated traffic lanes extending through the curves and approximately 300 ft beyond the PC and PT

**LEGEND** X High Volume Highways  
**FOR** X Normal Volume Highways  
**VALUES** X Low Volume Highway

## 2.3 Shoulders

**Table 2.3.3 Shoulder Widths and Slopes - Arterials Undivided**

HIGHWAY TYPE		WIDTHS (FEET)				SLOPES
		WITHOUT SHOULDER GUTTER		WITH SHOULDER GUTTER		NORMAL <sub>1</sub>
		FULL WIDTH	PAVED WIDTH <sub>2</sub>	FULL WIDTH	PAVED WIDTH	
ARTERIALS Undivided (lanes Two-Way)	Multi-Lane <sub>3</sub>	12 10 8	5 5 5	15 5 15 5 13 5	8 8 6	06
	2-Lane	12 10 8	5 5 5	15 5 15 5 13 5	8 8 6	
	Auxiliary Lane At-Grade Intersections	Same As Travel Lanes	5	11 5	4	
	Frontage Road	See <b>COLLECTORS</b> Table 2 3 4  For Local Roads And Streets See The FDOT "Manual Of Uniform Minimum Standards For Design, Construction And Maintenance For Streets And Highways "				
1	Shoulders shall extend 4 ft back of shoulder gutter and have a 0 06 slope back toward the gutter					
2	Shoulder shall be paved full width through rail-highway at-grade crossings, extending a minimum distance of 50 ft on each side of the crossing measured from the outside rail For additional information see Standard Index No 17882					
3	All multi-lane facilities shall conform with Section 2 2 2 of this manual					
<b>LEGEND</b>	X	High Volume Highways				
<b>FOR</b>	X	Normal Volume Highways				
<b>VALUES</b>	X	Low Volume Highways				

## 2.3 Shoulders

**Table 2.3.4 Shoulder Widths and Slopes - Collectors Divided and Undivided**

HIGHWAY TYPE		WIDTHS (FEET)								SLOPES	
		WITHOUT SHOULDER GUTTER				WITH SHOULDER GUTTER					
		FULL WIDTH		PAVED WIDTH		FULL WIDTH		PAVED WIDTH		NORMAL <sub>1</sub>	
		Outside	Median Or Left	Outside <sub>2</sub>	Median Or Left	Outside	Median Or Left	Outside	Median Or Left	Outside	Median Or Left
COLLECTORS Divided (Lanes One-Way)	3-Lane	12 10 8	12 10 8	5 5 5	0 <sub>3</sub> 0 <sub>3</sub> 0 <sub>3</sub>	15 5 15 5 13 5	15 5 15 5 15 5	8 8 6	8 8 6	06	05
	2-lane	12 10 8	8 8 6	5 5 5	0 <sub>3</sub> 0 <sub>3</sub> 0 <sub>3</sub>	15 5 15 5 13 5	13 5 13 5 11 5	8 8 6	6 6 4		
	Auxiliary Lane At-Grade Intersection	Same As Travel Lanes	Same As Travel Lanes	5	4	11 5	N/A	4	N/A		
COLLECTORS Undivided (Lanes Two-Way)	Multi-Lane <sub>4</sub>	12 10 8		5 5 5		15 5 15 5 13 5		8 8 6		06	
	2-Lane	12 10 8		5 5 5		15 5 15 5 13 5		8 8 6			
	Auxiliary Lane At-Grade Intersection	Same As Travel Lanes		Same As Travel Lanes		11 5		4			

1 Shoulders shall extend 4 ft back of shoulder gutter and have a 0 06 slope back toward the gutter

2 Shoulder shall be paved full width though rail-highway at-grade crossings, extending a minimum distance of 50 ft on each side of the crossing measured from the outside rail For additional information see Standard Index No 17882

3 The median shoulder may be paved 2 ft wide in areas of the State where establishing and maintaining turf is difficult, however, shoulders shall be paved 4 ft wide (a) in sag vertical curves, 100 ft minimum either side of the low point, and (b) on the low side of superelevated traffic lanes, extending through the curve and approximately 300 ft beyond the PC and PT

4 All multi-lane facilities shall conform with Section 2 2 2 of this manual

**LEGEND** X High Volume Highways  
**FOR** X Normal Volume Highways  
**VALUES** X Low Volume Highways

## 2.3 Shoulders

Figure 2.3.1 Shoulder Superelevation

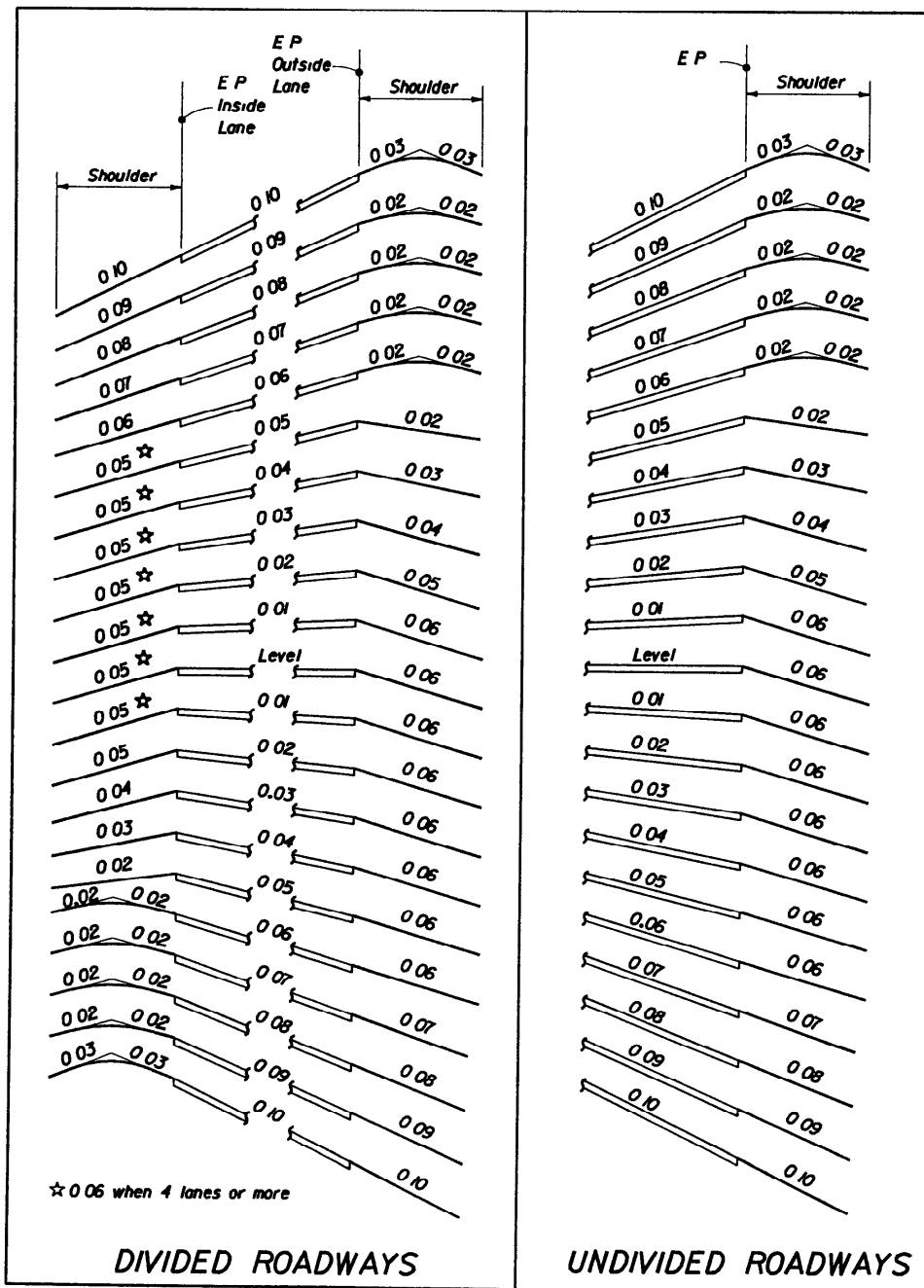

## 2.3 Shoulders

Figure 2 3 2 Typical Paving Under Bridge For Outside Shoulders

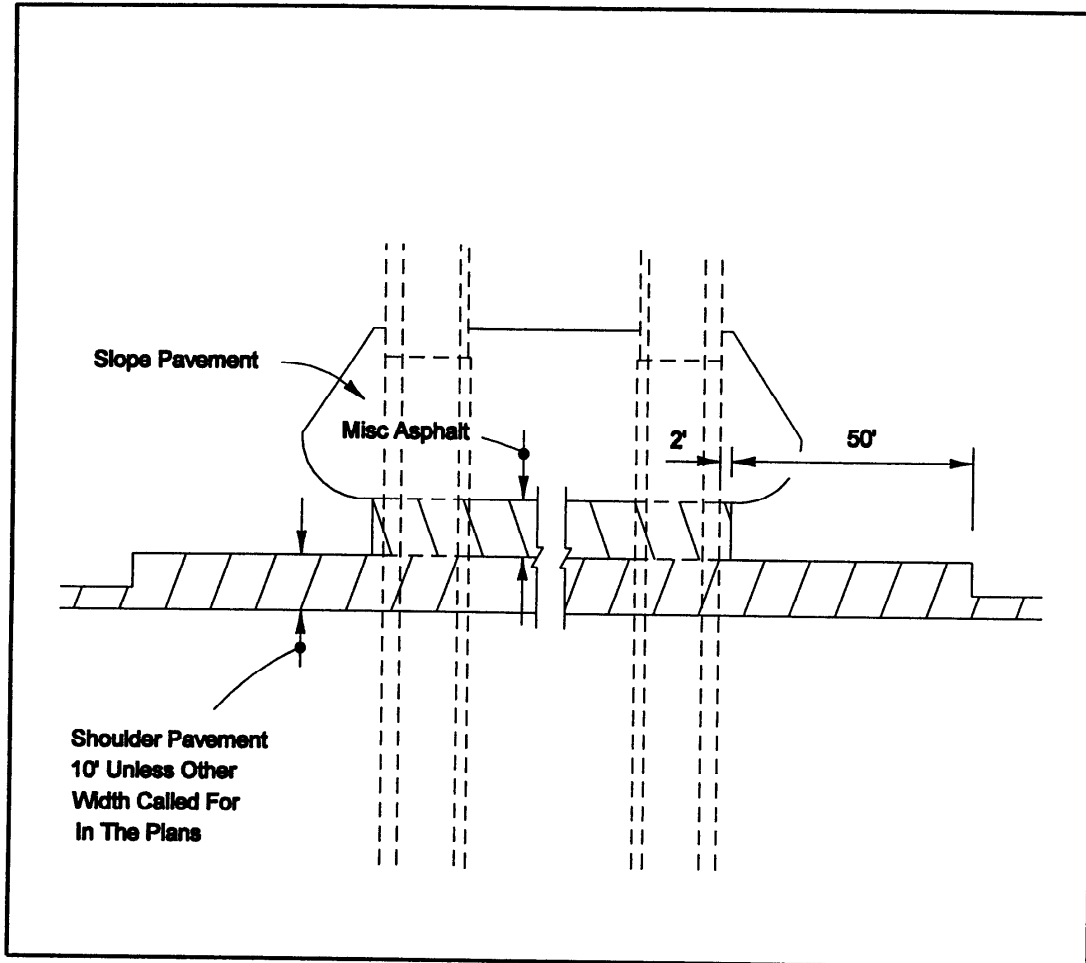



## 2.4 Roadside Slopes

Table 2.4.1 Roadside Slopes

TYPE OF FACILITY	RURAL & URBAN FREEWAYS, RURAL ARTERIALS AND COLLECTORS, WITH PROJECTED 20 YEAR AADT OF 1500 OR GREATER		RURAL ARTERIALS AND COLLECTORS WITH PROJECTED 20 YR. AADT LESS THAN 1500 AND RURAL LOCALS, URBAN ARTERIALS AND COLLECTORS WITHOUT CURB & GUTTER		URBAN ARTERIALS AND COLLECTORS WITH CURB & GUTTER	
	DESIGN SPEED 45 mph OR GREATER		ALL SPEEDS		DESIGN SPEED 45 mph OR LESS	
	Height of Fill (feet) *	Rate	Height of Fill (feet) *	Rate	Height of Fill (feet) *	Rate
Front Slope	0-5 5-10 10-20 >20	1 6 1 6 to edge of CZ and 1 4 1 6 to edge of CZ and 1 3 1 2 (with guardrail)	0-5 5 - 20	1 6 except where R/W is insufficient, then 1 6 to edge of CZ and 1 3 will be permitted 1 6 to edge of CZ and 1 3 except where R/W is insufficient then 1 2 will be permitted	All	1 2 to suit property owner, not flatter than 1 6 R/W cost must considered for high fill sections in urban areas
Back Slope	All	1 4 or 1 3 with a standard width trapezoidal ditch and 1 6 front slope	All	1 4 when R/W permits or 1 3	All	1 2 or to suit property owner Not flatter than 1 6
Transverse Slopes	All	1 10 or flatter (freeways) 1 4 (others)	All	1 4	All	1 4

\* Height of Fill is the vertical distance from the edge of the outside travel lane to the toe of front slope

## 2.5 Borders

**Table 2.5.1 Highways with Flush Shoulders**

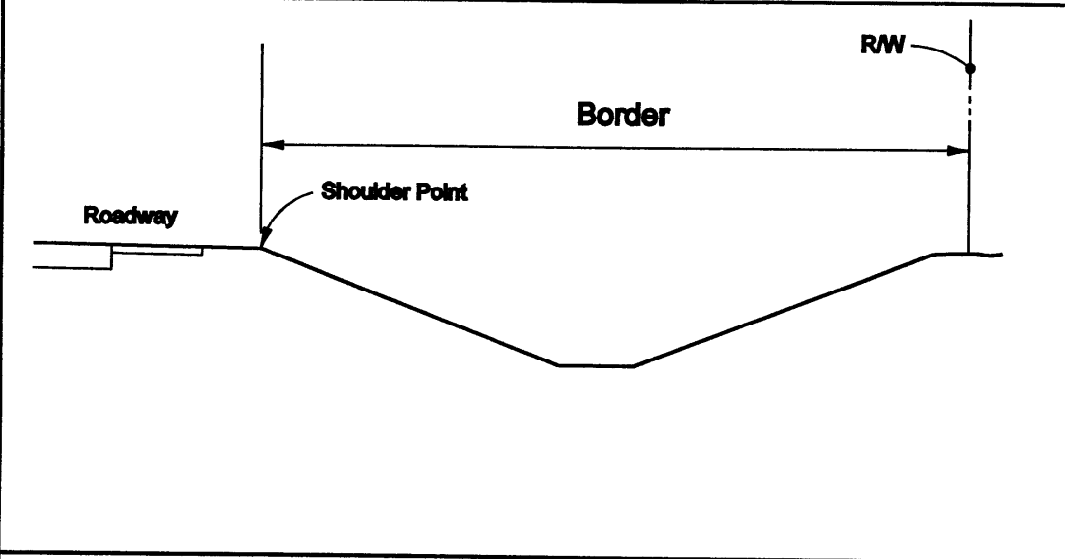

<b>BORDER</b>	
<b>TYPE FACILITY</b>	<b>WIDTH (FEET)</b>
<b>FREEWAYS (INCLUDING INTERCHANGE RAMPS)</b>	<b>82</b>
<b>ARTERIALS COLLECTORS Design Speed &gt; 45 mph</b>	<b>40</b>
<b>ARTERIALS COLLECTORS Design Speed ≤ 45 mph</b>	<b>33</b>

## 2.5 Borders

**Table 2.5.2 Highways with Curbs and Curb and Gutter**

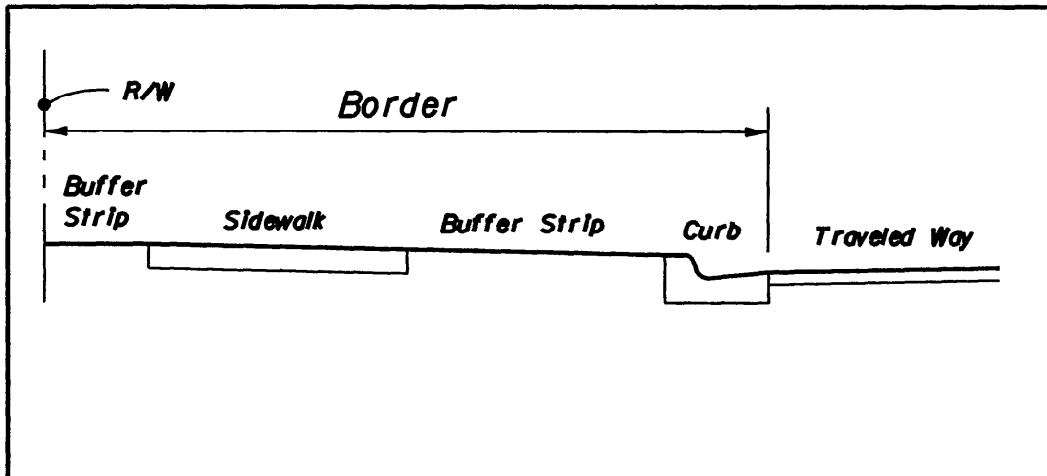

The diagram illustrates the cross-section of a highway border. From left to right, it shows the Right-of-Way (R/W) boundary, a Buffer Strip, a Sidewalk, another Buffer Strip, a Curb, and the Traveled Way. The entire area from the R/W boundary to the Curb is labeled as the 'Border'.

<b>BORDER</b>		
<b>TYPE FACILITY</b>	<b>MINIMUM WIDTH (FEET)</b>	
	<b>TRAVEL LANES AT CURB</b>	<b>BIKE LANES OR OTHER AUXILIARY LANES AT CURB</b>
<b>ARTERIALS COLLECTORS</b> <i>Design Speed <math>\geq 45</math> mph</i>	14	12
<b>ARTERIALS COLLECTORS</b> <i>Design Speed <math>\leq 40</math> mph</i>	12	10
<b>URBAN COLLECTOR STREETS</b> <i>Design Speed <math>\leq 30</math> mph</i>	10	8

## 2.6 Grades

**Table 2.6.1 Maximum Grades**

MAXIMUM GRADES IN PERCENT												
TYPE OF HIGHWAY	AREA	DESIGN SPEED (mph)										
		FLAT TERRAIN					ROLLING TERRAIN					
		30	40	45	50	60	70	30	40	50	60	70
FREEWAYS <sub>1</sub>	Rural	---	---	4	4	3	3	---	---	5	4	4
	Urban	---	---	4	4	3	3	---	---	5	4	4
ARTERIALS <sub>3</sub>	Rural	---	5	5	4	3	3	---	6	5	4	4
	Urban	8	7	7	6	5	---	9	8	7	6	---
COLLECTORS <sub>3</sub>	Rural	7	7	7	6	5	4	9	8	7	6	5
	Urban	9	9	9	7	6	5	11	10	8	7	6
	Industrial <sub>2</sub>	4	4	4	3	3	---	5	5	4	4	---
FRONTAGE ROAD	Require Same Criteria As Collectors											
RAMPS	DESIGN SPEED (mph)	< 20		25 to 30		35 to 40		45 to 50				
	GRADES (%)	6 to 8		5 to 7		4 to 6		3 to 5				
One-Way Descending Grades On Ramps May Be 2% Greater, In Special Cases												
1 Interstate designed to 70 mph will be restricted to 3% maximum grade 2 Areas with significant (10% or more) heavy truck traffic 3 On 2-lane highways critical length of upgrades shall not be exceeded Critical lengths are those which reduce the speeds of 300 lb/hp trucks by more than 10 mph												

**Table 2.6.2 Maximum Change in Grade Without Vertical Curves**

DESIGN SPEED (mph)	20	30	40	45	50	60	65	70
MAXIMUM CHANGE IN GRADE IN PERCENT	1 20	1 00	80	70	60	40	30	20

## 2.6 Grades

**Table 2.6.3 Criteria for Grade Datum**

<b>ROADWAY BASE CLEARANCE ABOVE DESIGN HIGH WATER ELEVATION</b>	
<b>TYPE FACILITY</b>	<b>REQUIRED CLEARANCE</b>
Freeways and Rural Multi-lane Mainline	3 ft
Ramps (proper)	2 ft
Low Point on Ramps at Cross Roads	1 ft
Rural Two-lane with Design Year ADT Greater than 1500 VPD	2 ft
All Other Facilities Including Urban	1 ft

**Table 2.6.4 Grade Criteria for Curb and Gutter Sections**

<b>GRADES ON CURB AND GUTTER SECTIONS</b>	
Minimum Distance Required between VPI's	250 ft
Minimum Grade (%)	0.3 %

(See **Table 2.6.1** for Maximum Grades)

## 2.7 Sight Distance

**Table 2.7.1 Minimum Stopping Sight Distance**

<b>MINIMUM STOPPING SIGHT DISTANCE (FEET)</b> (Based on height of eye of 3.5 ft and height of object 6 inches above road surface)														
<b>DESIGN SPEED (mph)</b>	<b>GRADES OF 2% OR LESS</b>													
	<b>FREEWAYS</b>							<b>ARTERIALS</b>	<b>COLLECTORS</b>					
	<b>Interstate</b>			<b>Other</b>										
30	----			----				----	200					
35	----			----				250	225					
40	----			----				300	275					
45	----			375				350	325					
50	----			450				400	400					
55	550			500				475	450					
60	625			575				550	500					
65	700			625				600	----					
70	800			725				700	----					
<b>ADJUSTMENT IN DISTANCE FOR GRADES GREATER THAN 2%</b>														
<b>DESIGN SPEED (mph)</b>	<b>INCREASE IN LENGTH FOR DOWNGRADE (ft)</b>							<b>DECREASE IN LENGTH FOR UPGRADE (ft)</b>						
	<b>Grades</b>													
	<b>3%</b>	<b>4%</b>	<b>5%</b>	<b>6%</b>	<b>7%</b>	<b>8%</b>	<b>9%</b>	<b>3%</b>	<b>4%</b>	<b>5%</b>	<b>6%</b>	<b>7%</b>	<b>8%</b>	<b>9%</b>
30	10	10	10	20	20	30	30	10	10	10	10	10	10	20
35	10	20	20	30	30	40	40	10	10	10	20	20	20	20
40	20	20	30	40	50	60	70	10	20	20	20	20	30	30
45	20	30	40	50	60	80	90	20	20	20	30	30	40	40
50	30	40	60	70	80	100	----	20	30	30	40	40	50	----
55	40	50	70	80	100	120	----	20	30	40	40	50	50	----
60	50	70	90	110	130	----	----	30	40	50	50	60	----	----
65	60	80	100	130	150	----	----	30	40	50	60	70	----	----
70	70	100	130	160	----	----	----	40	50	60	70	----	----	----

**Table 2.7.2 Minimum Passing Sight Distance**

<b>MINIMUM PASSING SIGHT DISTANCE (FEET)</b> (Based on height of eye of 3.5 ft. and height of object 4.25 ft. above road surface)									
<b>Design Speed (mph)</b>	<b>30</b>	<b>35</b>	<b>40</b>	<b>45</b>	<b>50</b>	<b>55</b>	<b>60</b>	<b>65</b>	<b>70</b>
2-Lane, 2-Way Facilities	1100	1300	1500	1650	1800	1950	2100	2300	2500

## 2.8 Curves

### 2.8.1 Horizontal Curves

**Table 2.8.1a Maximum Deflections Without Horizontal Curves**

<b>MAXIMUM DEFLECTION WITHOUT CURVE (DMS)</b>			
<b>TYPE FACILITY</b>		<b>V ≥ 45 mph</b>	<b>V ≤ 40 mph</b>
Freeways		0° 45' 00"	N/A
Arterials And Collectors	Without Curb & Gutter	0° 45' 00"	2° 00' 00"
	With Curb & Gutter	1° 00' 00"	2° 00' 00"
Where V=Design Speed (mph)			

**Table 2.8.1b Maximum Deflection for Through Lanes Through Intersections**

<b>Design speed (mph)</b>	<b>20</b>	<b>25</b>	<b>30</b>	<b>35</b>	<b>45</b>
Maximum Deflection	16°00'	11°00'	8°00'	6°00'	3°00'

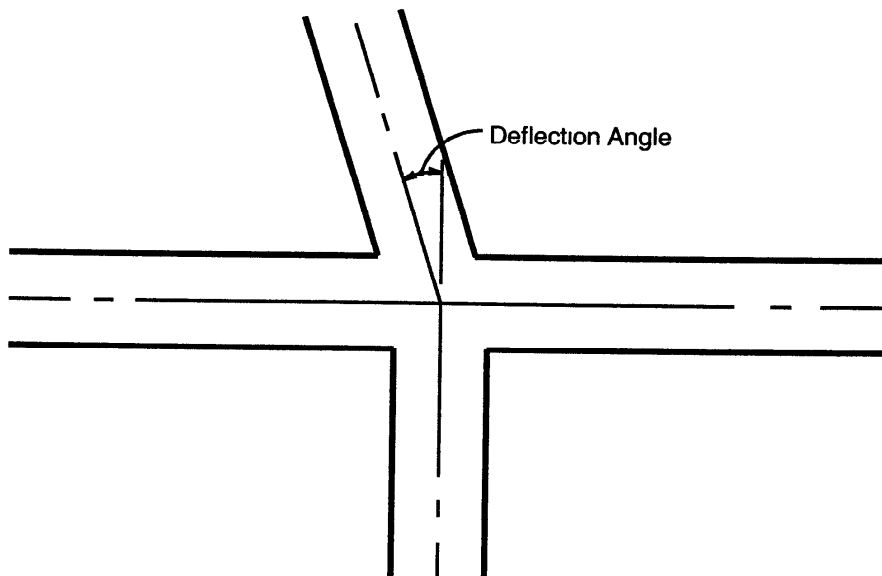

## 2.8 Curves

### 2.8.1 Horizontal Curves

**Table 2.8.2a Length of Horizontal Curves**

<b>LENGTH OF CURVE (FEET)</b>	
Freeways	$30V_1$
Arterials	$15V_2$
Collectors	$15V_2$
Where V=Design Speed (mph)	
1 When $30V$ cannot be attained, the greatest attainable length shall be used, but not less than $15V$	
2 When $15V$ cannot be attained, the greatest attainable length shall be used, but not less than 400 ft	
Curve length shall provide full superelevation within the curve of not less than 200 ft (Rural) or 100 ft (Urban)	

**Table 2.8.2b Arc Length (in feet) of Compound Curves with One-Half/Double Radii - Turning Roadways**

<b>Radius (ft.)</b>	<b>100</b>	<b>150</b>	<b>200</b>	<b>250</b>	<b>300</b>	<b>400</b>	<b>≥500</b>
Minimum Length	40	50	65	85	100	115	150
Desirable Length	65	65	100	115	150	180	200



## 2.8 Curves

### 2.8.1 Horizontal Curves

**Table 2.8.3 Maximum Curvature of Horizontal Curve  
 (Using Limiting Values of "e" and "f")**

<b>MAXIMUM CURVATURE (Degrees)</b>			
<b>Design Speed (mph)</b>	<b>RURAL ENVIRONMENT (e max=0.10)</b>	<b>URBAN ENVIRONMENT (e max=0.05)</b>	
		<b>Without Curb And Gutter</b>	<b>With Curb And Gutter</b>
30	24° 45'	20° 00'	20° 00'
35	17° 45'	14° 15'	14° 15'
40	13° 15'	10° 45'	10° 45'
45	10° 15'	8° 15'	8° 15'
50	8° 15'	6° 30'	6° 30'
55	6° 30'	5° 00'	---
60	5° 15'	---	---
65	4° 15'	---	---
70	3° 30'	---	---
Interstate 3° 00' (Maximum Curvature) (e max=0.10)			

**Table 2.8.4 Maximum Horizontal Curvature  
 Using 0.02 Cross Slopes**

<b>MAXIMUM CURVATURE (Degrees)</b>	
<b>Design Speed (mph)</b>	<b>Curvature</b>
30	1° 30'
40	1° 00'
45	0° 30'
50	0° 30'
55	0° 30'
60	0° 15'
65	0° 15'
70	0° 15'

## 2.8 Curves

### 2.8.2 Vertical Curves

**Table 2.8.5 Minimum Lengths of Crest Vertical Curves  
 Based on Stopping Sight Distance**

K VALUES FOR CREST CURVES						
Design Speed (mph)	FREEWAYS		ARTERIALS	COLLECTORS		
	Interstate	Other				
30	---	---	30	30		
35	---	---	50	40		
40	---	---	70	60		
45	---	110	90	80		
50	---	150	130	120		
55	220	190	170	150		
60	300	250	230	190		
65	380	320	280	230		
70	500	400	370	---		
<p><b>Length, L = KA</b>                      Where L = Minimum Length (Feet)                      K = Constant                      A = Algebraic Difference In Grades, Percent</p>						
Interstates	Lengths of crest vertical curves on Interstate mainlines are not to be less than 1000 ft for open highways and 1800 ft within interchanges					
Service Interchanges	K values for ramp crest vertical curves at freeway terminals are not to be less than the freeway K values. K values for other ramp crest vertical curves are not to be less than arterial K values					
System Interchanges	K values for all crest vertical curves on systems interchanges are not to be less than the K values of the higher system					
Arterials and Collectors	The minimum lengths of crest vertical curves for highways with design speeds of 50 mph or greater are as follows					
	Design Speed (mph)	50	55	60	65	70
	Minimum Length (ft)	300	350	400	450	500
All Facilities	The lengths of crest vertical curves are not to be less than 3 times the design speed (mph) expressed in feet					

## 2.8 Curves

### 2.8.2 Vertical Curves

**Table 2.8.6 Minimum Lengths of Sag Vertical Curves  
 Based on Stopping Sight Distance and Headlight Sight Distance**

K VALUES FOR SAG CURVES						
Design Speed (mph)	FREEWAYS		ARTERIALS	COLLECTORS		
	Interstate	Other				
30	---	---	40	40		
35	---	---	50	50		
40	---	---	60	60		
45	---	80	80	70		
50	---	100	90	90		
55	130	120	110	100		
60	150	140	130	120		
65	170	160	150	130		
70	200	180	170	---		
<p><b>Length, <math>L = KA</math></b>                      Where <math>L</math> = Minimum Length (feet)  <math>K</math> = Constant  <math>A</math> = Algebraic Difference In Grades, Percent</p>						
Interstates	Lengths of sag vertical curves on Interstate mainlines are not to be less than 800 ft					
Service Interchanges	K values for ramp sag vertical curves at freeway terminals are not to be less than the freeway K values K values for other ramp sag vertical curves are not to be less than arterial k values					
System Interchanges	K values for all sag vertical curves on systems interchanges are not to be less than the K values of the higher system					
Arterials and Collectors	The minimum lengths of sag vertical curves for highways with design speeds of 50 mph or greater are as follows					
	Design Speed (mph)	50	55	60	65	70
	Minimum Length (ft)	200	250	300	350	400
All Facilities	The lengths of sag vertical curves are not to be less than 3 times the design speed (mph) expressed in feet					

## 2.9 Superelevation

**Table 2.9.1 Superelevation Rates for Rural Highways  
 Urban Freeways and Highspeed Urban Highways ( $e_{max} = 0.10$ )**

TABULATED VALUES							
Degree of Curve <i>D</i>	Radius <i>R</i> (ft)	DESIGN SPEED (mph)					
		30	40	50	60	65	70
0° 15'	22,918	NC	NC	NC	NC	NC	NC
0° 30'	11,459	NC	NC	NC	RC	RC	RC
0° 45'	7,639	NC	NC	021	030	033	037
1° 00'	5,730	NC	NC	021	030	033	037
1° 30'	3,820	NC	021	031	043	048	054
2° 00'	2,865	RC	028	040	055	062	070
2° 30'	2,292	021	034	049	067	075	085
3° 00'	1,910	025	040	057	077	087	096
3° 30'	1,637	029	046	065	086	095	100
4° 00'	1,432	033	051	072	093	099	Dmax =
5° 00'	1,146	040	061	083	098	Dmax =	3° 30'
6° 00'	955	046	070	092	Dmax =	4° 15'	
7° 00'	819	053	078	098	5° 15'		
8° 00'	716	058	084	100			
9° 00'	637	063	089	Dmax =			
10° 00'	573	068	094	8° 15'			
11° 00'	521	072	097				
12° 00'	477	076	099				
13° 00'	441	080	100				
14° 00'	409	083	Dmax =				
15° 00'	382	089	13° 15'				
16° 00'	358	093					
18° 00'	318	097					
20° 00'	286	099					
22° 00'	260	100					
		Dmax =					
		24° 45'					

NC = Normal Crown ( -0 02 )

RC = Reverse Crown ( +0 02 )

Rates for intermediate *D*'s are to be interpolated

## 2.9 Superelevation

**Figure 2.9.1 Superelevation Rate For Rural Highways  
 Urban Freeways And High Speed Urban Highways ( $e_{max}=0.10$ )**

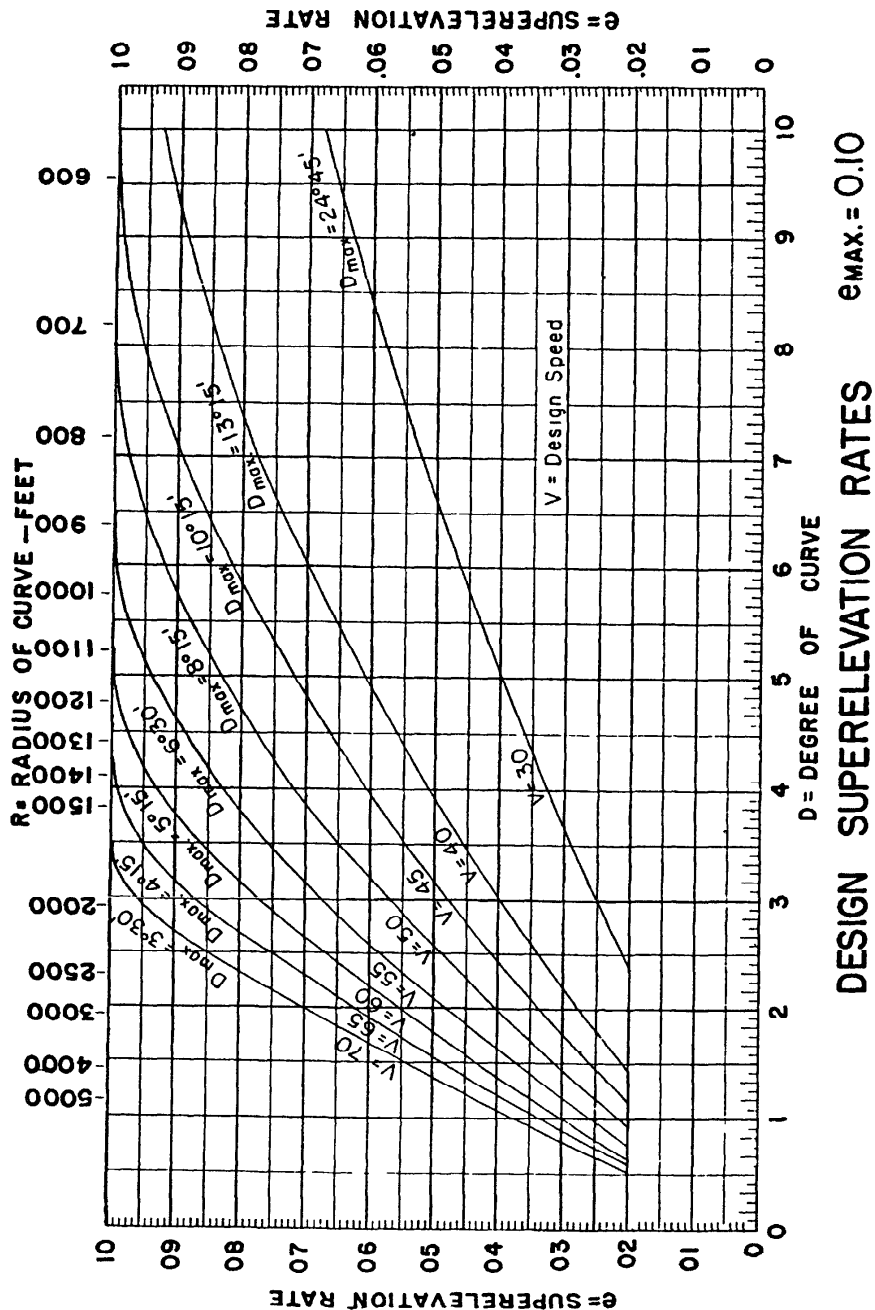

## 2.9 Superelevation

**Table 2.9.2 Superelevation Rates for Urban Highways  
 and High Speed Urban Streets ( $e_{max} = 0.05$ )**

TABULATED VALUES						
Degree of Curve <i>D</i>	Radius <i>R</i> (ft)	DESIGN SPEED (mph)				
		30	35	40	45	50
2° 00'	2,865	NC	NC	NC	NC	NC
2° 15'	2,546					RC
2° 45'	2,083				NC	
3° 00'	1,910				RC	
3° 45'	1,528			NC		
4° 00'	1,432			RC		
4° 45'	1,206					RC
5° 00'	1,146		NC			023
5° 15'	1,091		RC			027
5° 30'	1,042					030
5° 45'	996					035
6° 00'	955				RC	040
6° 15'	917				022	045
6° 30'	881				024	050
6° 45'	849				027	Dmax = 6° 30'
7° 00'	819	NC			030	
7° 15'	790	RC			033	
7° 30'	764				037	
7° 45'	739				041	Dmax = 8° 15'
8° 00'	716			RC	045	
8° 15'	694			022	050	
8° 30'	674			025		
8° 45'	655			027		
9° 00'	637			030		
9° 30'	603			034		
10° 00'	573			040		
10° 30'	546		RC	047		
11° 00'	521		023	Dmax = 10° 45'		
11° 30'	498		026			
12° 00'	477		030			
13° 00'	441		036			
14° 00'	409	RC	045			
15° 00'	382	023	Dmax = 14° 45'			
16° 00'	358	027				
17° 00'	337	032				
18° 00'	318	038				
19° 00'	302	043				
20° 00'	286	050				
		Dmax = 20° 00'				

NC = Normal Crown ( -0 02 )    RC = Reverse Crown ( +0 02 )

## 2.9 Superelevation

**Figure 2.9.2 Superelevation Rates For Urban Highways  
 And High Speed Urban Streets ( $e_{max}=0.05$ )**

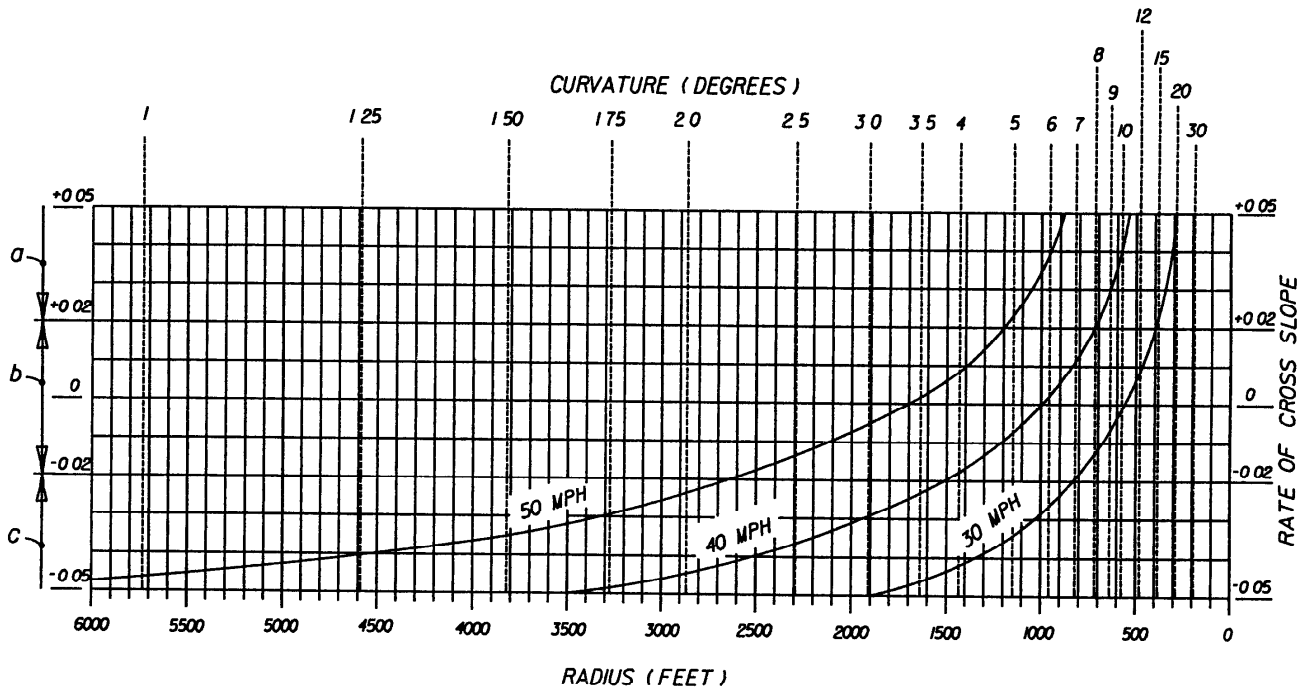

- a When the speed curves and the degree of curve lines intersect above this line, the pavement is to be superelevated (positive slope) at the rates indicated at the lines intersecting points
- b When the speed curves and the degree of curve lines intersect between these limits, the pavement is to be superelevated at the rate of 0.02 (positive slope)
- c When the speed curves and the degree of curve lines intersect below this line The pavement is to have normal crown (typically 0.02 and 0.03 downward slopes)

## 2.9 Superelevation

**Table 2.9.3 Superelevation Transition Slope Rates for Rural Highways, Urban Freeways and High Speed Urban Highways**

<b>SLOPE RATES FOR STRAIGHT LINE SUPERELEVATION TRANSITIONS</b>			
<b>SECTION</b>	<b>Design Speed (mph)</b>		
	<b>45-50</b>	<b>55-60</b>	<b>65-70</b>
	<b>SLOPE RATES</b>		
2 Lane & 4 Lane	1 200	1 225	1 250
6 Lane	1 160	1 180	1 200
8 Lane	1 150	1 170	1 190
<p>The length of superlevation transition is to be determined by the relative slope rate between the travel way edge of pavement and the profile grade, except that the minimum length of transition shall be 100 feet</p> <p>For additional information on transitions, see the <i>Roadway and Traffic Design Standards, Index 510</i></p>			

**Table 2.9.4 Superelevation Transition Slope Rates for Urban Highways and High Speed Urban Streets**

<b>SLOPE RATES FOR STRAIGHT LINE SUPERELEVATION TRANSITIONS</b>	
30 mph	1 100
40 mph	1 125
45-50 mph <sup>1</sup>	1 150
<p>1 A slope rate of 1 125 may be used for 45 mph under restricted conditions</p> <p>The length of superlevation transition is to be determined by the relative slope rate between the travel way edge of pavement and the profile grade, except that the minimum length of transition shall be 50 ft for design speeds under 40 mph and 75 ft for design speeds of 40 mph or greater For additional information on transitions, see the <i>Roadway and Traffic Design Standards, Index 511</i></p>	



Figure 2.10.1 Clearances

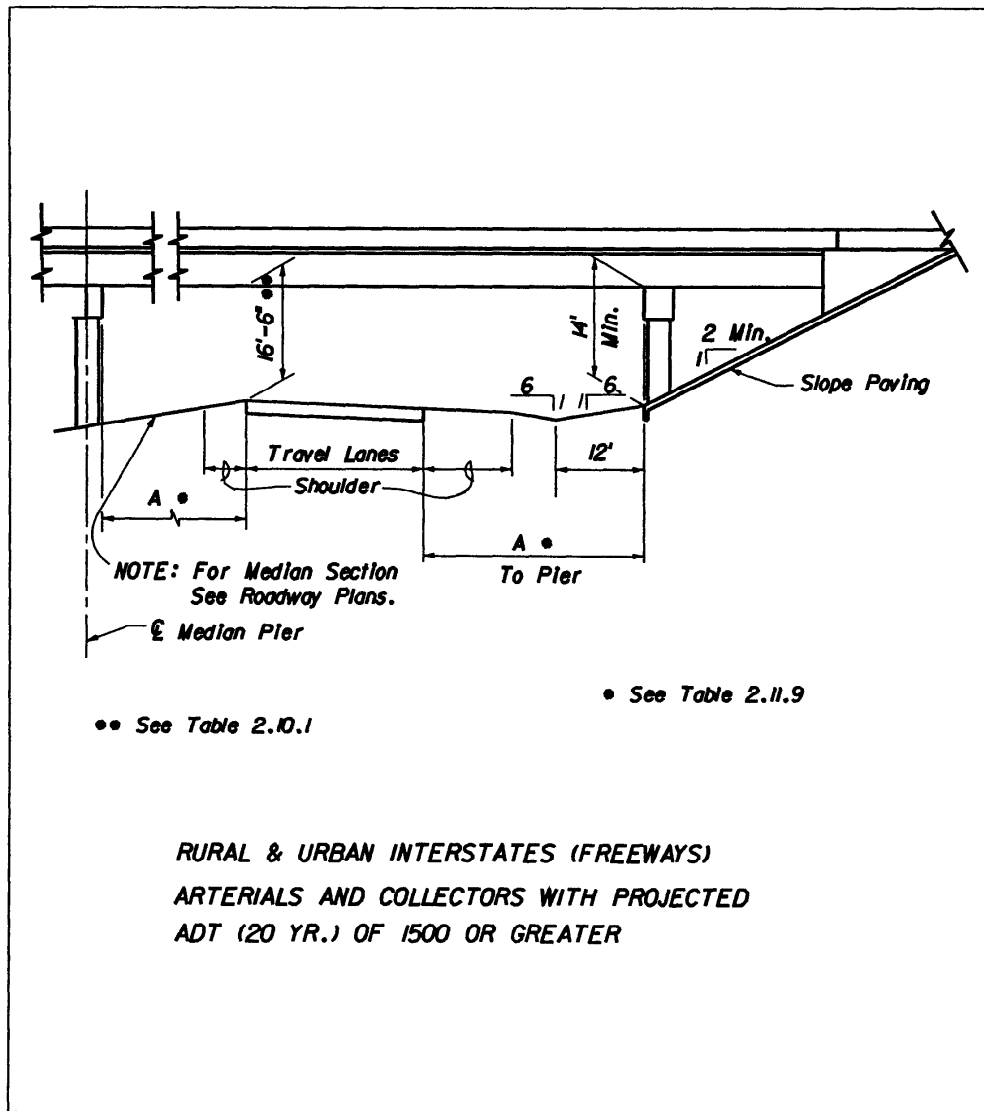

Figure 2 10 2 Clearances

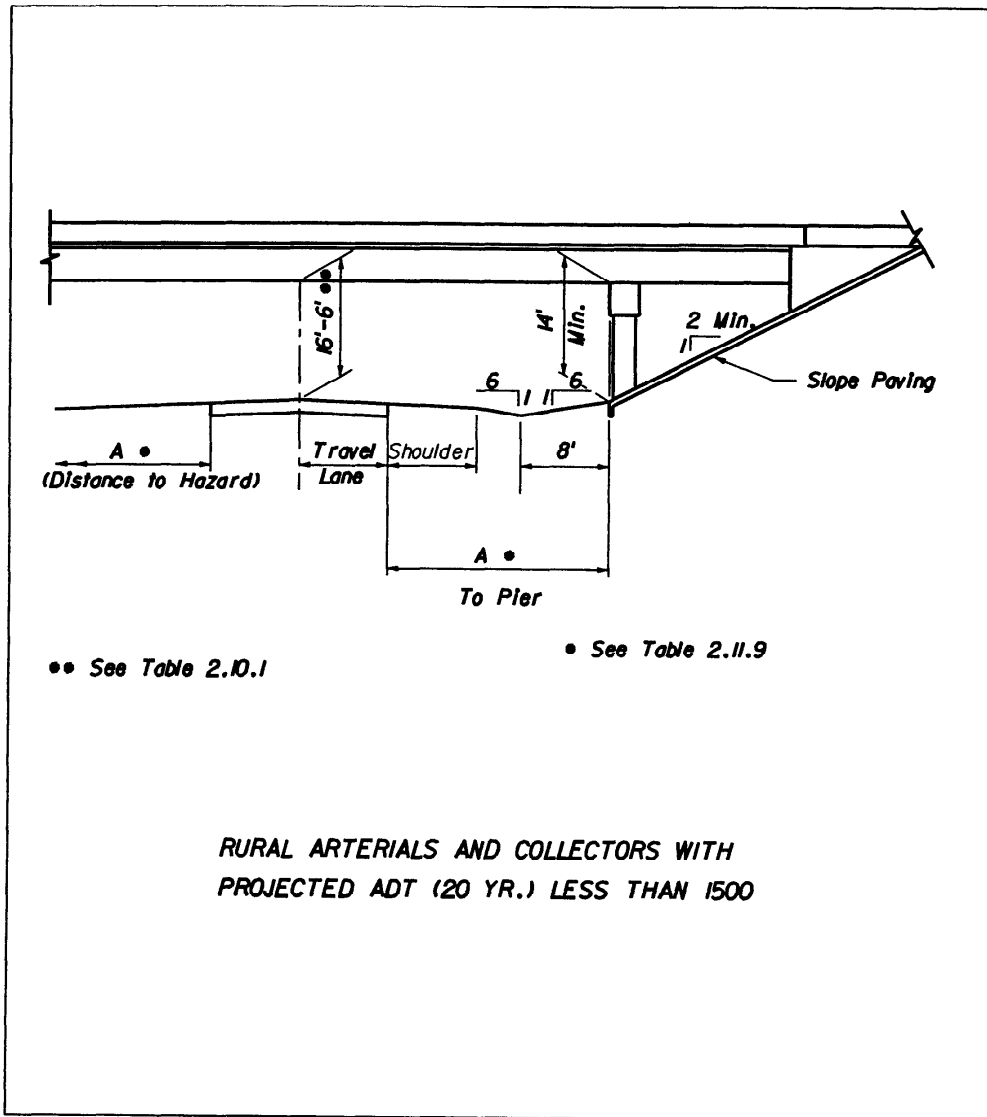

Figure 2 10 3 Clearances

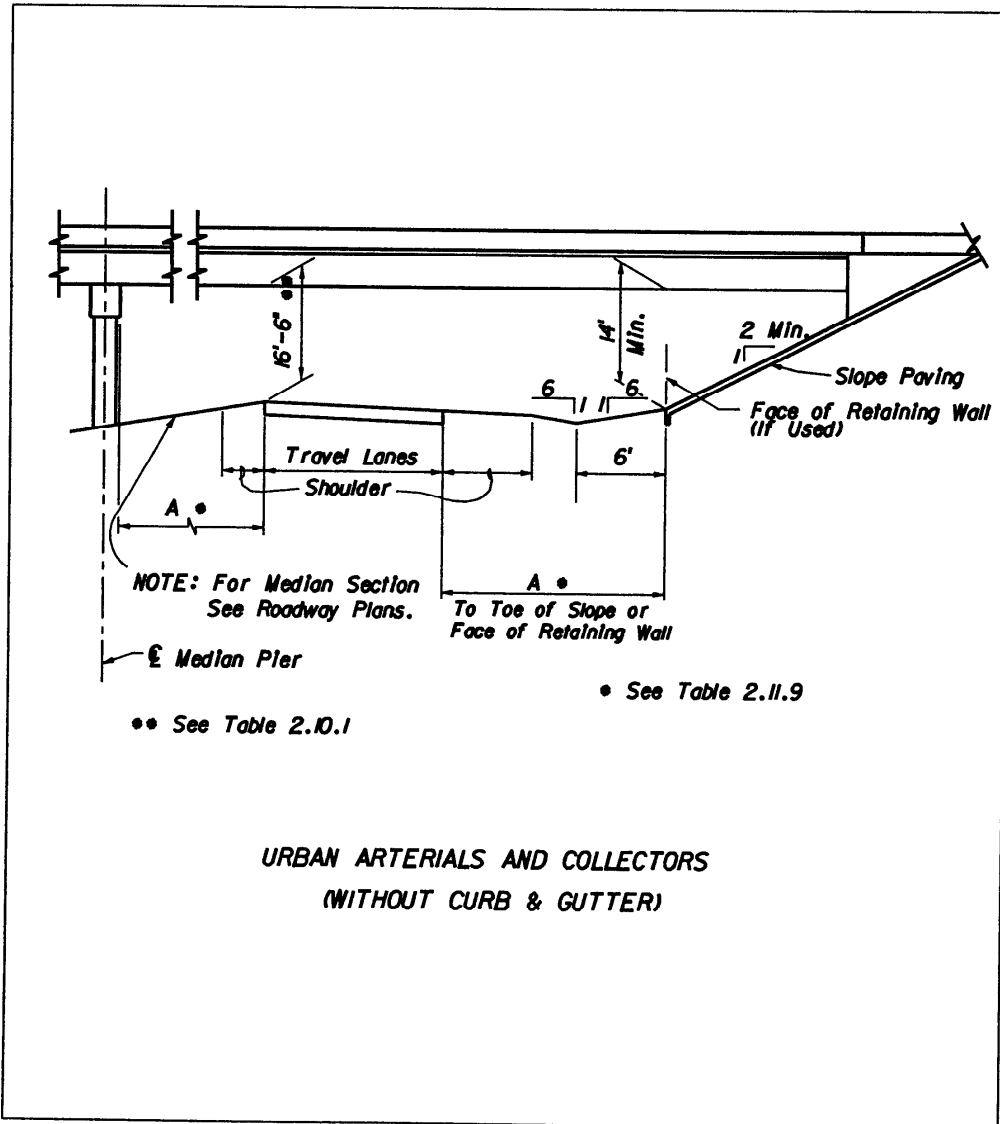
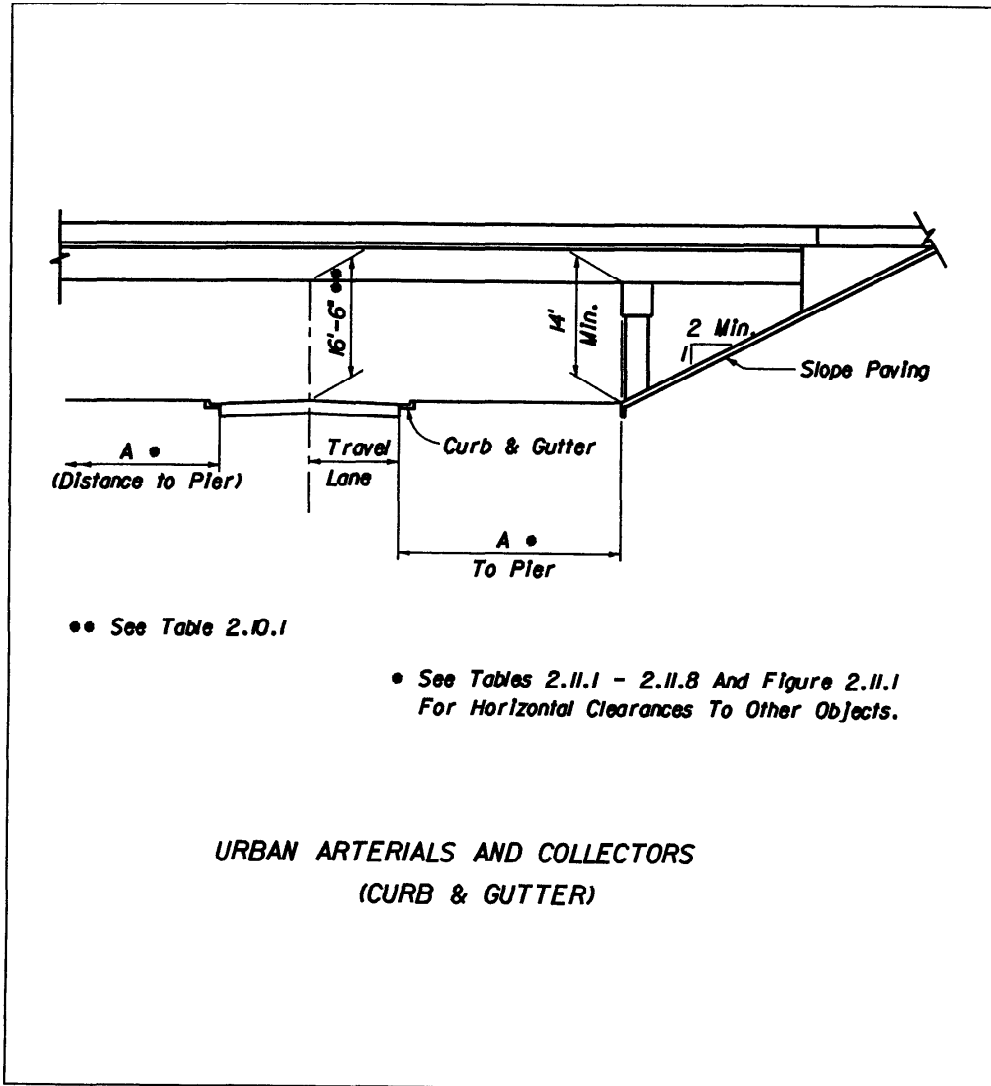

Figure 2.10.4 Clearances



## 2.10 Vertical Clearances

**Table 2.10.1 Vertical Clearances for Bridges**

FACILITY TYPE	CLEARANCE <sup>1,4,5</sup> (FEET)			
	Roadway Or Railroad Over Roadway <sup>2</sup>	Roadway Over Railroad <sup>3,4</sup>	Pedestrian Over Roadway <sup>2</sup>	Pedestrian Over Railroad <sup>3</sup>
Freeways, Arterials Collectors & Others	16'-6"	23'-6"	17'-6"	23'-6"
<p>1 Clearance Measurement The least vertical distance between the bridge structure and the surface of the roadway (traffic lanes and shoulders) or the top of the highest rail</p> <p>2 Includes Future Underpass Resurfacing 6" over pavements</p> <p>3 Includes Rail Resurfacing (Track Raised) 12" for conventional railroads Others-see footnote No 4 and <b>Section 6.3.5 of Chapter 6</b></p> <p>4 Over High Speed Rail Systems See Department guidelines and specifications for Intermediate Class Rail Operations entitled <b>Standard Specifications For The Design And Construction Of Railways</b></p> <p>5 Clearance Over Waterways See Department <b>Drainage Manual, Topic No. 625-040-001, Chapter 4</b> and <b>Section 2.10.1</b> of this chapter</p>				

## 2.10 Vertical Clearances

**Table 2.10.2 Minimum Vertical Clearances for Signs**

SIGNS	CLEARANCE <sup>1</sup>
<b>Overhead Sign Structures</b>	17'-6" over the entire width of the pavement and shoulder to the lowest sign component

1 Includes 6" for future resurfacing on rural sections

**Table 2.10.3 Minimum Vertical Clearances for Signals**

SIGNALS	CLEARANCE <sup>1</sup>
<b>Span Wire Mounted</b>	17'-6" between the pavement and the bottom of any signal assembly
<b>Mast Arm Mounted</b>	17'-6" over the entire width of the pavement and shoulder to the lowest signal or low point of the arm
<b>Truss Mounted</b>	17'-6" over the entire width of the pavement and shoulders to the lowest signal or lowest member of the horizontal truss

1 Includes 6" for future resurfacing on rural sections

## 2.11 Horizontal Clearances

**Table 2.11.1 Horizontal Clearance for Traffic Control Signs**

<b>PLACEMENT</b>	Placement shall be in accordance with the <b>Roadway and Traffic Design Standards</b> . Placement within sidewalks shall be such that an unobstructed sidewalk width of 4 ft or more (not including the width of curb) is provided.
<b>SUPPORTS</b>	Supports, except overhead sign supports, shall be frangible or breakaway. When practicable, sign supports should be located behind barriers that are justified for other reasons. Overhead sign supports shall be located outside the clear zone unless shielded.

**Table 2.11.2 Horizontal Clearance for Light Poles**

<b>CONVENTIONAL LIGHTING</b>	<p>Not in the median except in conjunction with barriers that are justified for other reasons.</p> <p>Rural (Flush Shoulders)                  20 ft from the travel lane, 14 ft from auxiliary lane                  (may be clear zone width when clear zone is less than 20 ft)</p> <p>Urban (Curb and Gutter)                  From right of way line to 4 ft back of face of curb (may be 2.5 ft back of face of curb when all other alternatives are deemed impractical).                  Placement within sidewalks shall be such that an unobstructed sidewalk width of 4 ft or more (not including the width of curb) is provided.</p>
<b>HIGH MAST LIGHTING</b>	Outside of the clear zone unless shielded.

**Table 2.11.3 Horizontal Clearance for Utility Installations**

<p>Shall not be located within the limited access right of way, except as allowed by the <b>Telecommunications Policy, (Topic No. 000-625-025)</b></p> <p>Shall not be located in the median</p> <p>Flush Shoulders                  Not within the clear zone. Install as close as practical to the right of way without aerial encroachments onto private property.</p> <p>Curb or Curb and Gutter                  At the R/W line or as close to the R/W line as practical. Must maintain 4 ft clear from face of curb. Placement within sidewalks shall be such that an unobstructed sidewalk width of 4 ft or more (not including the width of the curb) is provided.</p> <p>See the <b>Utility Accommodation Manual, (Topic No. 710-020-001)</b> for additional information.</p>
---

## 2.11 Horizontal Clearances

**Table 2.11.4 Horizontal Clearance to Signal Poles and Controller Cabinets for Signals**

Shall not be located in medians

Should be located as far from traffic lanes as practical. Placement within sidewalks shall be such that an unobstructed sidewalk width of 4 ft or more (not including the width of curb) is provided

**Table 2.11.5 - Horizontal Clearance to Trees**

Minimum Horizontal Clearance to trees where the diameter is or is expected to be greater than 4 inches measured 6 inches above the ground shall be

Flush Shoulders  
Outside the clear zone

Curb or Curb and Gutter  
4 ft from face of outside curbs  
6 ft from edge of inside traffic lane where median curb is present

**Table 2.11.6 Horizontal Clearance to Bridge Piers and Abutments**

Minimum Horizontal Clearance to Bridge Piers and Abutments

Flush Shoulders  
Outside the clear zone

Curb or Curb and Gutter  
16 ft from the edge of the travel lane

**Table 2.11.7 Horizontal Clearance to Railroad Grade Crossing Traffic Control Devices**

Placement shall be in accordance with the *Roadway and Traffic Design Standards*.

**Table 2.11.8 Horizontal Clearance to Other Roadside Obstacles**

Minimum Horizontal Clearance to other roadside obstacles

Flush Shoulders  
Outside the clear zone

Curb or Curb and Gutter  
4 ft back of face of curb May be 2.5 ft back of face of curb when all other alternatives are deemed impractical

Note Horizontal Clearance to mailboxes is specified in the construction details contained in **Index No. 532**



## 2.11 Horizontal Clearances

Figure 2.11.1 Clearance to Guardrail

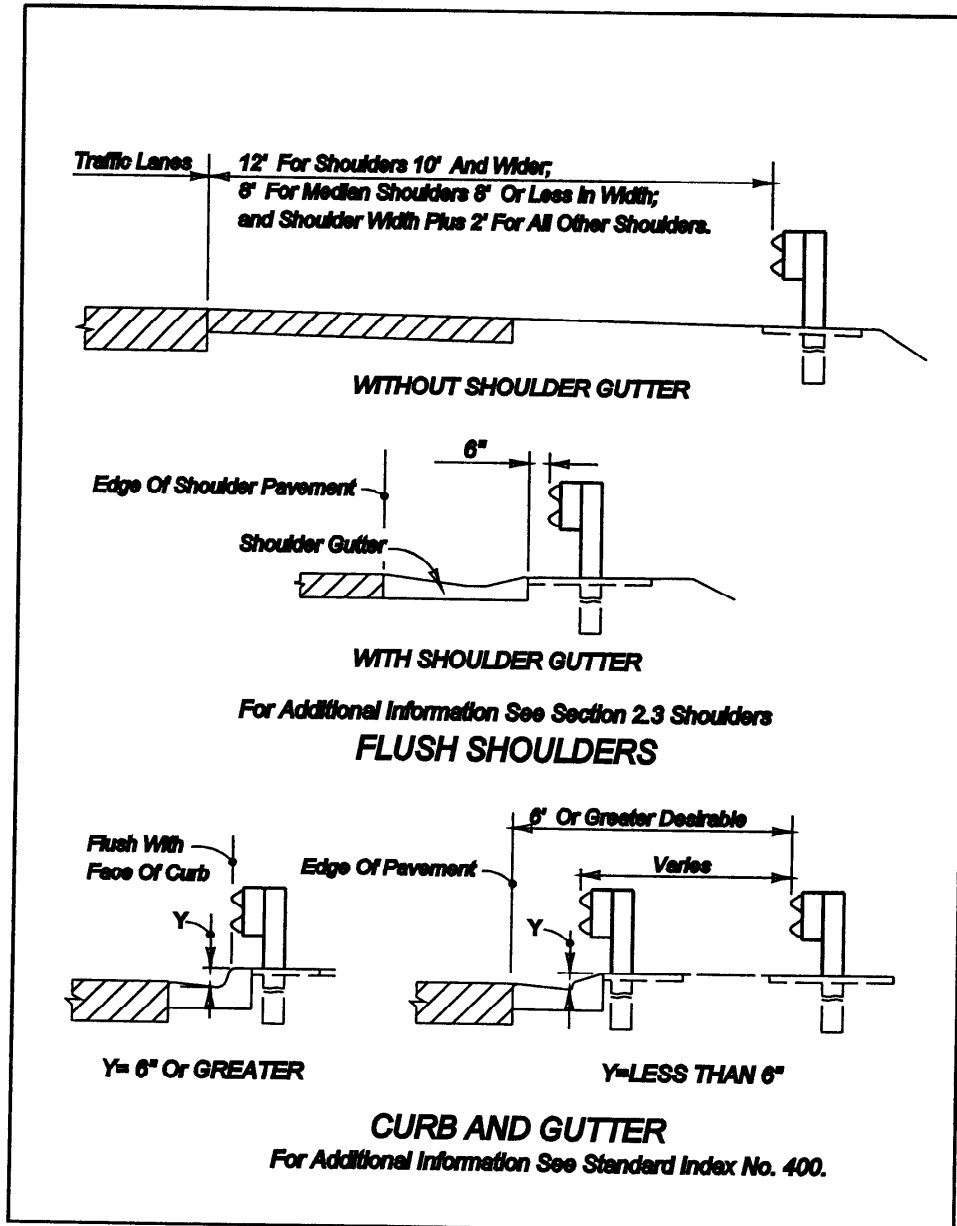

## 2.11 Horizontal Clearances

Table 2.11.9 Clear Zone Widths

CLEAR ZONE WIDTH (FEET)				
DESIGN SPEED (mph)	≥ 1500 AADT		< 1500 AADT	
	TRAVEL LANES & MULTI-LANE RAMPS	AUXILIARY LANES & SINGLE LANE RAMPS	TRAVEL LANES & MULTI-LANE RAMPS	AUXILIARY LANES & SINGLE LANE RAMPS
< 45	18	10	16	10
45	24	14	20	14
50	24	14	20	14
55	30	18	24	14
> 55	36	24	30	18

Above clear zone widths are for side slopes of 1 4 or flatter. Applies to highways with flush shoulders only. May be in rural or urban locations.

AA DT=Mainline 20 years projected annual average daily traffic

Where accident history indicates need, or where specific site investigation shows definitive accident potential, clear zone widths shall be adjusted on the outside of horizontal curves with flush shoulders in accordance with Table 2 11 10

Clear zone widths are measured from the edge of the traveled way

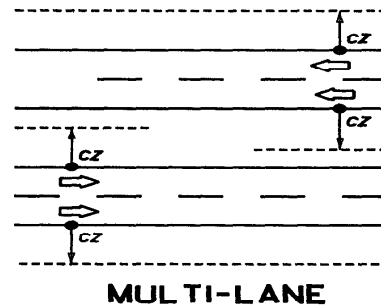
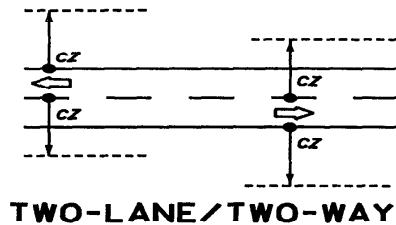

## MEASUREMENT OF CLEAR ZONE

**TABLE 2.11.10 Clear Zone Widths For Curved Alignments  
On Highways With Flush Shoulders**

**TABLE I**

D	CLEAR ZONE OF CURVED ALIGNMENT ( CZ <sub>c</sub> ), FEET																						
	DESIGN SPEED ( Vmph ) And Clear Zone ( CZ, Feet )																						
	30	35	40	45	50	55	60	65	70	75	80	85	90	95	100	105							
Tangent	10	16	18	10	16	18	10	16	18	14	20	24	14	20	24	18	24	30	36	18	24	30	36
0° 15'	10	16	18	10	16	18	10	16	18	14	20	24	14	20	24	18	24	30	36	18	24	30	36
0° 30'	10	16	18	10	16	18	10	16	18	14	20	24	14	20	24	18	24	30	36	18	24	30	36
0° 45'	10	16	18	10	16	18	10	16	18	14	21	25	15	19	23	19	25	31	38	19	25	31	37
1° 00'	10	16	18	10	16	19	10	16	19	15	21	25	15	19	23	19	25	32	39	20	26	33	38
1° 30'	10	16	18	10	16	19	10	17	19	15	21	25	15	20	26	20	27	33	40	20	27	34	40
2° 00'	10	17	19	11	17	19	11	17	19	15	21	26	16	20	27	21	28	35	41	21	28	36	43
2° 30'	11	17	19	11	17	20	11	17	20	16	22	27	17	21	29	21	29	36	43	22	29	37	44
3° 00'	11	17	19	11	17	20	11	18	20	16	23	28	17	21	29	22	30	37	44	23	31	38	46
3° 30'	11	17	19	11	18	20	11	18	20	16	23	28	18	23	30	24	32	40	48	24	32	40	48
4° 00'	11	17	20	11	18	20	12	18	21	17	24	29	18	23	31	25	33	41	49	25	33	42	50
4° 15'																							
5° 00'	11	18	20	11	18	21	12	19	21	17	25	30	18	26	31	19	25	33	41	26	35	44	53
5° 15'																							
6° 00'	11	18	20	12	19	21	12	20	22	18	26	31	19	27	33	20	26	35	43	27	36	44	53
6° 30'																							
7° 00'	12	18	21	12	19	22	13	20	23	19	27	32	20	28	34								
8° 00'	12	19	21	12	20	22	13	21	23	19	28	33	21	30	36								
8° 15'																							
9° 00'	12	19	21	13	20	23	13	21	24	20	29	34											
10° 00'	12	19	22	13	20	23	14	22	25	21	29	35											
10° 15'																							
11° 00'	12	20	22	13	21	24	14	22	25														
12° 00'	13	20	23	14	21	24	15	23	26														
13° 00'	13	20	23	14	22	25	15	24	27														
13° 15'																							
14° 00'	13	21	23	14	22	25																	
16° 00'	13	21	24	14	22	25																	
17° 45'																							
18° 00'	14	22	25																				
20° 00'	14	22	25																				
22° 00'	14	23	26																				
24° 00'	15	24	27																				
24° 45'	15	24	27																				

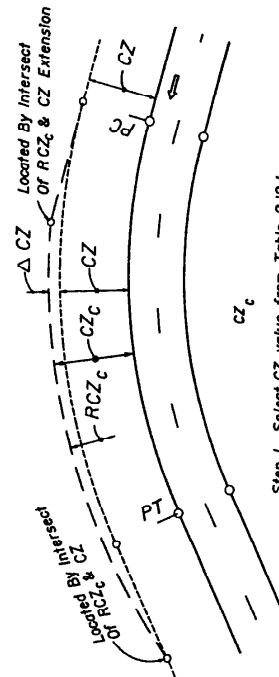

- Step 1 Select CZ value from Table 2.12.1
- Step 2 In Table above locate the "Design Speed" and "Tangent" CZ values that match the speed and CZ value from Step 1
- Step 3 Move down the radius column to the radius under consideration then across the table to the column found under Step 2 to find the CZ<sub>c</sub> value

**2.12 (Reserved)**

**2.13 (Reserved)**

**2.14 Interchanges**

**Table 2.14.1 Ramp Widths - Turning Roadways**

<b>RAMP WIDTHS</b>			
<b>RADIUS To Inside of Curve (FEET)</b>	<b>1-LANE</b>		<b>2-LANE</b>
	<b>Traveled Way Width<sub>1</sub> Case I-C</b>	<b>Traveled Way Width + Outside Paved Shoulder Width Case II-B</b>	<b>Traveled Way Width<sub>1</sub> Case III-A</b>
<b>FEET</b>			
50	23	25	29
75	19	23	27
100	18	22	26
150	18	21	25
200	16	21	25
300	16	20	24
400	16	20	24
500 +	15	20	24

For widths on the ramp proper see **Table 2.1.3**

For case application, see **AASHTO** and the **Roadway and Traffic Design Standards, Index 525**.

- 1 Do not deduct for the presence of stabilized or paved shoulder

## 2.15 Lighting Criteria

**Table 2.15.1 Conventional Lighting - Roadways**

ROADWAY CLASSIFICATIONS	ILLUMINATION LEVEL AVERAGE INITIAL (H.F.C)	UNIFORMITY RATIOS	
		AVG./MIN.	MAX./MIN.
INTERSTATE, EXPRESSWAY, FREEWAY & MAJOR ARTERIALS	15	4:1 or Less	10:1 or Less
ALL OTHER ROADWAYS	10	4:1 or Less	10:1 or Less
* PEDESTRIAN WAYS AND BICYCLE LANES	25	4:1 or Less	10:1 or Less

**Note.** These values should be considered standard, but should be increased if necessary to maintain an acceptable uniformity ratio. The maximum value should be one and one-half values.

\* This assumes a separate facility. Facilities adjacent to a vehicular roadway should use the levels for that roadway.

**Table 2.15.2 Highmast Lighting - Roadways**

ROADWAY CLASSIFICATIONS	ILLUMINATION LEVEL AVERAGE INITIAL (H.F.C)	UNIFORMITY RATIOS	
		AVG./MIN.	MAX./MIN.
INTERSTATE, EXPRESSWAY, FREEWAY & MAJOR ARTERIALS	0.8 to 1.0	3:1 or Less	10:1 or Less
ALL OTHER ROADWAYS	0.8 to 1.0	3:1 or Less	10:1 or Less

**Table 2.15.3 Underdeck Lighting - Roadways**

LUMINAIRE TYPE	LIGHT SOURCE	MOUNTING LOCATION
PIER CAP	150 watt to 250 watt HPS	Pier or Pier Cap
PENDANT HUNG	150 watt to 250 watt HPS	Bridge Deck

**Note:** The light levels for underdeck lighting shall be equal to the adjacent roadway lighting.

Underdeck lighting is accomplished by mounting either pier cap or pendant hung fixtures under the bridge structure.

Pier cap luminaires should be installed when bridge piers are located less than 15 ft. from edge of travel lane.

Pendant hung luminaires shall be mounted to the bottom of the bridge deck and should suspend where 50% of the lamp is below bridge beam.

## 2.15 Lighting Criteria

**Table 2.15.4 Rest Area Lighting**

AREA ILLUMINATED	ILLUMINATION LEVEL AVERAGE INITIAL (H.F.C.)	UNIFORMITY RATIOS	
		AVG./MIN	MAX./MIN.
ENTRANCE & EXIT	1 5	4 1 or Less	10 1 or Less
INTERIOR ROADWAYS	1 5	4 1 or Less	10 1 or Less
PARKING AREAS	1 5	4 1 or Less	10 1 or Less

**Table 2.15.5 Mounting Height Restrictions**

LUMINAIRE WATTAGE	LIGHT SOURCE	MOUNTING HEIGHT (MIN) (FEET)
150	High Pressure Sodium (HPS)	25
200	High Pressure Sodium (HPS)	30
250	High Pressure Sodium (HPS)	30
400	High Pressure Sodium (HPS)	40
750	High Pressure Sodium (HPS)	50
1000	High Pressure Sodium (HPS)	80

## Chapter 3

### EARTHWORK

3.1	General . . . . .	3-1
3.2	Classification of Soils . . . . .	3-4
3.3	Cross Sections - A Design Tool . . . . .	3-4
3.4	Earthwork Quantities . . . . .	3-5
3.4.1	Method of Calculating . . . . .	3-5
3.4.2	Earthwork Tabulation . . . . .	3-5
3.4.3	Earthwork Accuracy . . . . .	3-6
3.4.3.1	Projects with horizontal and vertical controlled cross sections . . . . .	3-6
3.4.3.2	Projects without horizontal and vertical controlled cross sections . . . . .	3-7
3.4.4	Variation in Quantities . . . . .	3-7
3.5	Earthwork Items of Payment . . . . .	3-8
3.5.1	Guidelines for Selecting Pay Items . . . . .	3-8
3.5.2	Regular Excavation . . . . .	3-9
3.5.3	Embankment . . . . .	3-10
3.5.4	Subsoil Excavation . . . . .	3-10
3.5.5	Lateral Ditch Excavation . . . . .	3-10
3.5.6	Channel Excavation . . . . .	3-11
3.5.7	Borrow Excavation (Truck Measure) . . . . .	3-11
3.5.8	Regular Excavation (RRR Projects Only) - Lump Sum . . . . .	3-12
3.5.9	Summary of Earthwork . . . . .	3-12
Exhibit 3-A	. . . . .	3-3
Exhibit 3-B	. . . . .	3-9

## Chapter 3

### EARTHWORK

#### 3.1 General Introduction

The Department is changing it's philosophy on several issues that involve earthwork. This chapter has been completely rewritten to include the changes which will simplify how the department addresses earthwork on a project. This introduction, highlighting the changes, has been included in the manual to summarize the changes at a glance. Complete review of this chapter is recommended prior to plans preparation utilizing earthwork on a project.

#### Summary of Major Changes to Earthwork

- 1 Pay for all Cut Operations as Regular Excavation (CY) or Regular Excavation (Lump Sum), Do not differentiate between suitable and unsuitable
- 2 Pay for all Fill Operations as Embankment or Borrow Excavation (Truck Measure)
- 3 Permanently Block the Pay Item for Borrow Excavation (Pit Measure)
- 4 Pay for all material excavated below the finished grading template as Subsoil Excavation, Do not differentiate between suitable and unsuitable
- 5 Pay for subsoil excavation and backfill will be separate using the English method **THIS WILL BE IMPLEMENTED ON ALL METRIC PROJECTS EFFECTIVE WITH THE JULY 2000 LETTING.**
- 6 When quantities are large, pay for Lateral Ditch and/or Channel Excavation separately
- 7 When calculating the quantity of Borrow Excavation (Truck Measure) do not subtract the quantity of Regular Excavation on the project
- 8 Show soil survey borings on the Cross Section Sheets (Do not show limit lines **except** the lower limits of the removal of organic and/or plastic material to determine the quantities of subsoil excavation )
- 9 Revise the Earthwork Column format on the Cross Section Sheets Show Subsoil Exc - Regular Exc - Embankment (Do not create columns for material classification) on the right side. There will be no earthwork columns on the left side
- 10 Identify Pond Excavation Limits and guidance in the PPM



- 11 Material utilization will be left up to the Contractor Adjusting quantities of material to compensate for Traffic Control or Sequence Phasing, is no longer required

### 3.1.1 General

Earthwork is a generic term for all items of work, materials and operations required to construct the excavated areas and the embankments of a project **Sections 120 and 125** of the **Standard Specifications** define the terms, method of measure, basis of payment and pay items associated with earthwork

In general, earthwork on a highway project consists of

**Embankment –** Compacted fill material needed to construct the roadway, excluding the base and pavement portions of the roadway and shoulders

**Regular Excavation –** Excavation necessary for the construction of the roadway, ditches, ponds, channel changes, etc

**Subsoil Excavation -** Excavation, removal and disposal of any material that is unsuitable in its original position and that is excavated below the finished grading template

The most important roadway operation involving earthwork is constructing the roadbed The roadbed is constructed by excavating soil from cut sections and placing soil as embankments in fill sections In cut sections, the roadbed is built below the original ground - the original ground is excavated to the elevation of the proposed roadbed In fill sections, the roadbed is built above the original ground - the earth fill is on an embankment

The finished grading template is defined as the finished shoulder and slope lines and bottom of the completed base or rigid pavement for most pavements The Department occasionally uses stabilized bases and sand bituminous road mixes For these, consider the finished grading template as the top of the finished base, shoulders and slopes

**SEE STANDARD INDEXES 500 AND 505**

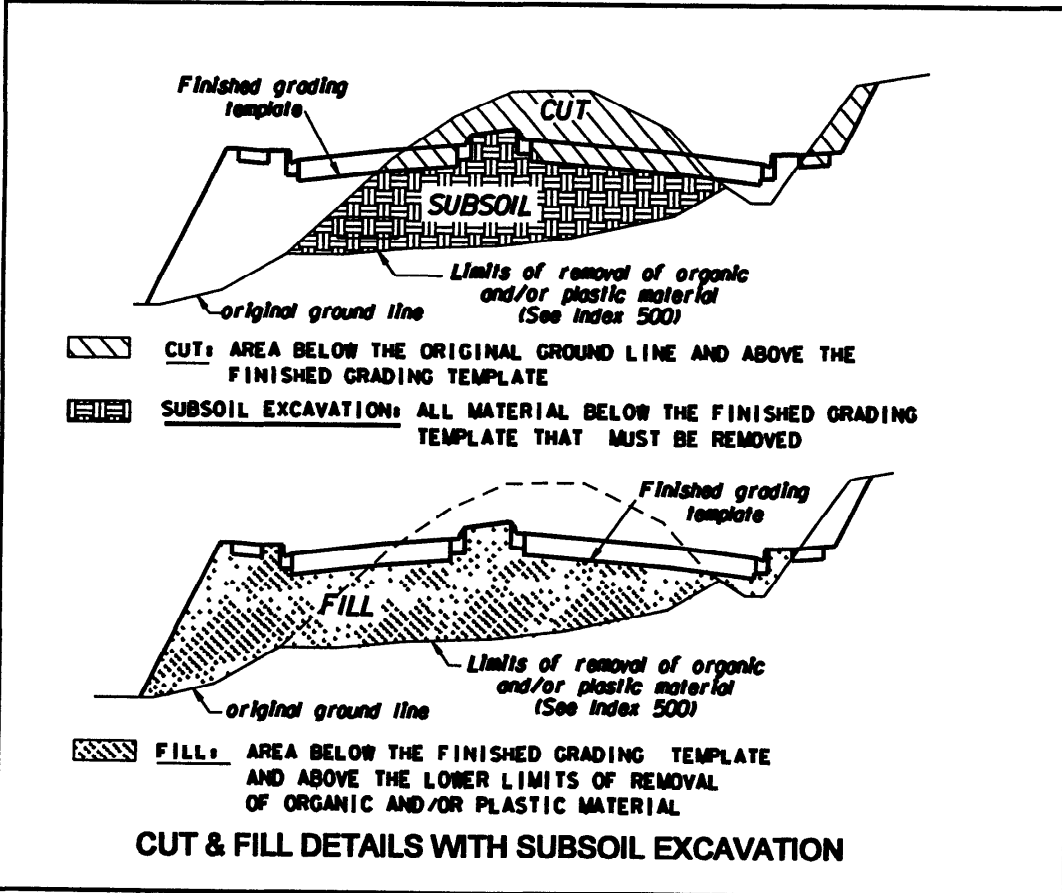
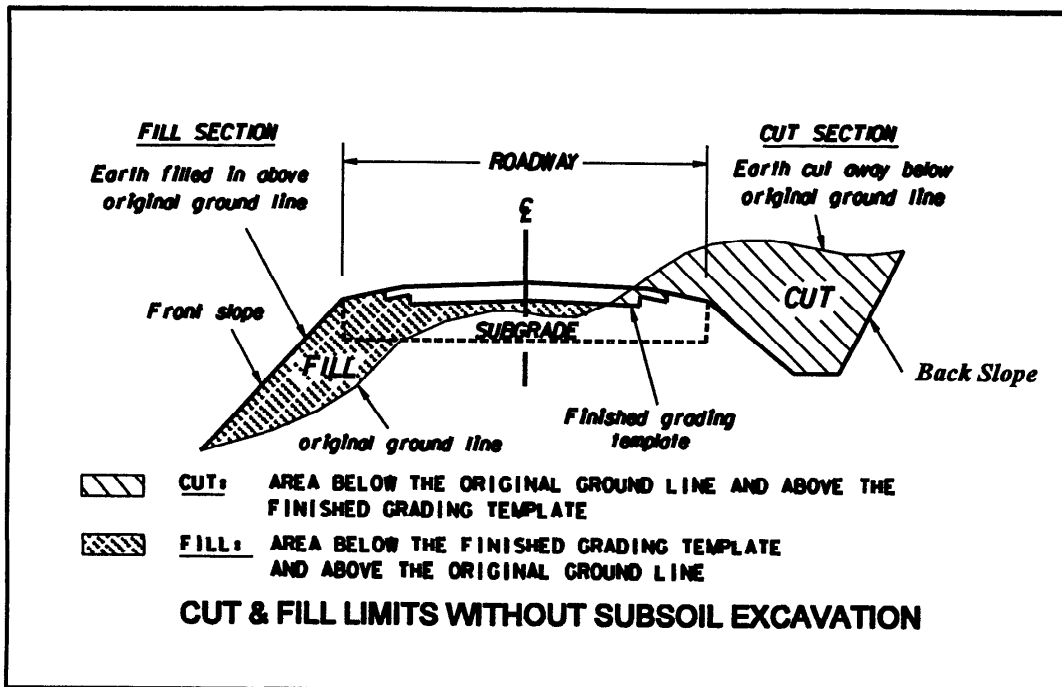

## 3.2 Classification of Soils

The Department uses a system of soil classification which places materials into groups and subgroups based on soil fracture, liquid limit and plasticity index. This classification determines if and where the materials may be placed or left in their original position on a project. The soils survey, testing and classification of materials must be performed by a qualified geotechnical laboratory. The plans will include the information about the soil classification on the soil survey sheet and by showing the boring data soil boxes on the cross section sheets. If it is determined that an organic or plastic material must be removed below the finished grading template, the lower limits of removal of organic or plastic material will be shown to determine the area and volume of subsoil excavation. For more details, see the ***Volume II of this manual*** and ***Index 505, Roadway and Traffic Design Standards***.

## 3.3 Cross Sections - A Design Tool

The details of cut and fill of earthwork are shown on the cross sections. The cross sections of the existing surface are usually obtained by location field survey or photogrammetry. The finished profile grades, typical section details, pavement design details, superelevation and horizontal alignments are used in combination to develop the finished template at each location where an existing cross section was obtained or generated. Sometimes it is advisable to develop and plot intermediate cross sections or half-sections to accurately determine quantities.

Cross sections cannot be finalized until late in the design process. However, preliminary cross section templates, developed early in the design process, can assist the designer in establishing many of the other design elements such as guardrail, shoulder gutter, inlets and special ditch grades. Preliminary cross sections are also used in performing the Soils Survey. Cross section templates should be plotted as soon as the alignment, grades and typical section details are established.

The interval selected for showing cross sections in the plans will vary according to project specific factors. For new construction and reconstruction the normal interval for cross sections is 100 feet for rural projects and 50 feet for urban projects. These intervals may also be appropriate on RRR projects depending on the variability of earthwork along the project. Other factors which may influence the frequency of cross sections include the presence of intersections, extent of driveway and turnout construction or reconstruction, ADA related work, drainage improvements, etc.

For resurfacing and minor widening and resurfacing projects, refer to **Section 3.5.8** of this chapter.

Additional criteria used for plotting the earthwork details are found in the ***Standard Specifications, Section 120***; the ***Roadway and Traffic Design Standards, Indexes 500*** and ***505***; and ***Volume II of this manual***.

### 3.4 Earthwork Quantities

#### 3.4.1 Method of Calculating

Earthwork quantities can be accurately determined by computer or by manual calculation, if proper care is taken. Therefore, the specifications allow it to be designated for payment as the original plan quantity unless determined to be substantially in error. Earthwork quantities are calculated by the method of average end areas.

$$\text{CUBIC YARDS} = \frac{\text{EA1} + \text{EA2}}{2} \times \text{LENGTH} \div 27$$

Each set of end areas for the different types of earthwork (subsoil excavation, regular excavation and embankment) are calculated separately and shown in the appropriate column on the cross section sheets, as indicated in *Volume II of this manual*.

#### 3.4.2 Earthwork Tabulation

Areas and volume for subsoil excavation, regular excavation and embankment are tabulated on the right hand side of the cross section sheet. The designer must be familiar with the control lines for earthwork operations in order to properly delineate and calculate earthwork quantities.

Format for the Tabulation of Earthwork Quantities

(Show the appropriate tabulation on the right side of the sheet)

#### Projects With Limited or No Cross Sections

See Example in Section 3-5.7
------------------------------

#### Projects With Cross Sections

SUBSOIL EXC		REGULAR EXC		EMBK	
A	V	A	V	A	V

### 3.4.3 Earthwork Accuracy

There are two methods of documenting the earthwork quantities for projects. The most accurate and preferred method involves the preparation of cross sections to define the quantities of earthwork involved. This method is mandatory on all new construction and major reconstruction projects. The other method, using working typical sections, is only to be used on RRR type projects where it has been determined that the project is a candidate for payment by Regular Excavation, Lump Sum. It is critical that the designer choose which method is best suited for their project with input from construction.

The calculation of earthwork volumes is not simple but, when performed with care and properly checked, many of the inaccuracies common in earthwork quantity calculations can be avoided. The primary causes for inaccurate earthwork quantities are found to be errors in calculating end areas and choosing inappropriate intervals between the cross sections. Correct methods and techniques for computing earthwork quantities will eliminate the gross errors.

#### 3.4.3.1 Projects with horizontal and vertical controlled cross sections

- 1 Calculate end areas and volumes by computer, when possible, and print the calculations for verification and future use by others.
- 2 Plot cross section details at the largest scale the sheets will permit. Care should also be taken when plotting slopes that extend over long distances.
- 3 If end areas are calculated from cross sections manually, show the breakdown of areas, etc. on work sheets and include these as backup in the computation book.
- 4 When computing volumes, determine lengths between sets of end areas to compensate for volumes that do not run the entire lengths between the normal station lengths.
- 5 Properly use match lines and turning lines to divide end areas when separate lengths should be used to calculate volumes.
- 6 Reduce the interval between cross sections to 25 feet or less on ramps or sharp turning roadways, or determine and use the centroid of the section as the length for computing volumes.
- 7 Exclude bridge spans, large culverts or other exceptions where earthwork is not required.
- 8 Include quantities for fill slopes under bridges, at guardrail installations and at culvert extensions. Show extended shoulder slope on cross sections at guardrail locations (not steeper than 10 to 1 per ***Roadway and Traffic Design Standards, Index 400***).
- 9 Make sure that fill for all subsoil excavation is included in either the embankment or borrow excavation (truck measure) quantities.

### **3.4.3.2 Projects without horizontal and vertical controlled cross sections**

- 1 Include working typical cross sections in the computation book at all locations where there is a change in either the existing or proposed templates
- 2 Working typicals should include the station limits of the typical, and the end areas of all cut and fill sections Working typicals may be placed in the plans, but are not required
- 3 The thickness of the base box is calculated on the most probable base option A plan note should also be shown in the plans stating which option was used for calculating the earthwork quantities
- 4 Extra fill material needed for the extended shoulder for guardrail placement should be documented in the computation book with the final quantity being tabulated on the summary of earthwork The quantity should be based on working typical sections showing the extended shoulder slope on cross sections at guardrail locations (not steeper than 1 to 10 per *Roadway and Traffic Design Standards, Index 400*)

### **3.4.4 Variation in Quantities**

When detailing and determining earthwork quantities, the designer shall use the most probable base option within the optional base group A plan note should also be shown in the plans stating which option was used for plotting the cross sections and calculating the earthwork quantities The Specifications do not allow adjustment of the earthwork quantities that were designated to be paid as plan quantity because a base of different depth was chosen during construction

### 3.5 Earthwork Items of Payment

#### 3.5.1 Guidelines for Selecting Earthwork Pay Items

Guidelines for Selecting Earthwork Pay Items				
Description		Control Lines	Recommended Pay Item	
			Projects with Cross Sections	Project with Limited or No Cross Sections
Earthwork operations <b>above</b> the original ground line and <b>below</b> the finished grading template	Fill	from original ground to the finished grading template	Embankment (CY)	Borrow Excavation (Truck Measure) (CY)
Earthwork operations <b>below</b> the original ground line and <b>above</b> the finished grading template	Cut	from original ground to the finished grading template	Regular Excavation (CY)	Regular Excavation (3-R Projects) (LS)
Earthwork operations <b>below</b> the original ground line and <b>below</b> the finished grading template	Cut	from the finished grading template or original ground, whichever is lower, to the lower limits of removal of organic or plastic material	Subsoil Excavation (CY)	Subsoil Excavation (CY)
	Fill	from the lower limits of removal of organic or plastic material removed to the finished grading template	Embankment (CY)	Borrow Excavation (Truck Measure) (CY)
With significant quantities of lateral ditch or channel excavation the designer may select to pay for separately		from finished ground to the finished grading template	Lateral Ditch Exc Channel Exc (CY)	N/A

### 3.5.2 Regular Excavation

This is the most general classification of earthwork excavation. When Lateral Ditch or Channel excavation pay items are not called for in the plans, the total quantity of all excavation shall be paid for as Regular Excavation. Regular Excavation may include roadway, pond and ditch excavation. Roadway Excavation consists of the net volume of material excavated between the original ground surface line and the finished grading template of the roadway.

Retention or detention areas that require considerable excavation should be summarized separately and added to the Regular Excavation. This is especially important if there is a large quantity and the area is removed from the project by some distance.

Some environmental permits now require that the plans call for excavating additional depth below the finish elevation of the bottom of a pond or ditch. They also require that the area of extra depth be replaced with "blanket material" that will either allow for percolation or not allow for percolation as required by the permit. The drawing below shows the limits of pay for excavation in this situation. The depth and type of fill material must be identified in the plans.

## POND TEMPLATE

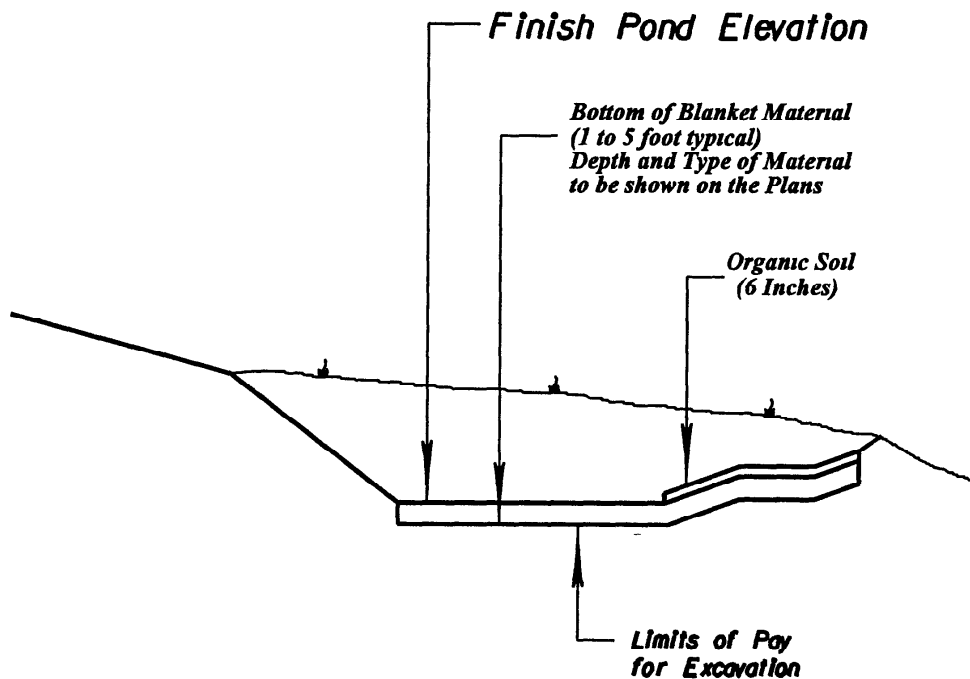



### 3.5.3 Embankment

This item includes placing material above the original ground line, or above the lower limits of removal of organic and/or plastic material to the finished grading template

### 3.5.4 Subsoil Excavation

Subsoil Excavation consists of the excavation and disposal of any material that in its original position is excavated below the finished grading template or original ground, whichever is lower

The soils investigation survey documents the organic and/or plastic material found on the project. Likewise, the cross sections and the earthwork calculations must use the lower limits of removal of organic or plastic material in determining the quantities for Subsoil Excavation

Subsoil excavation areas and volumes shall be tabulated on the right side of the cross section sheets. The fill quantities (areas and volumes) shall include areas and volumes required to fill the excavated areas created by subsoil removal. See example given in Section 3.1 of this chapter

The payment for subsoil excavation shall not be included in the pay quantities for other items no matter how small the subsoil quantities

Embankment (fill) or Regular Excavation (cut) should be used in conjunction with the pay item Subsoil Excavation. Both Embankment and Regular Excavation are plan quantity items. The quantities are based on line and grades shown in the plans and would allow construction personnel to field verify the quantities of material used on a project. Subsoil Excavation is a field measure item, and the final pay quantity will be determined by cross section taken when the removal of the material is completed

### 3.5.5 Lateral Ditch Excavation

Excavation required to construct inlet and outlet ditches at structures, changes in channels of streams and ditches parallel to the right of way, but separated from the roadway template, may be designated by the designer as Lateral Ditch Excavation

On projects with very little of this type of excavation, this earthwork is usually included in the Regular or Roadway Excavation. If there is a significant amount of Lateral Ditch Excavation, it should be detailed, calculated and summarized on separate cross section sheets and shown separately in the Earthwork Summary. For more details on lateral ditch cross sections, see the Volume II of this manual

Excavation included for payment or that will be bid as work under **Section 125 (Excavation for Structures)** must not be included again in Lateral Ditch or other excavation pay items

### 3.5.6 Channel Excavation

The pay item for Channel Excavation consists of the excavation and satisfactory disposal of all material from the limits of the channel as shown in the plans. This work is generally called for by the plans and has lines, grades, typical sections and other details shown for excavating a channel change or a major modification to an existing channel or stream. This work may be significantly different from regular excavation or lateral ditch excavation, requiring draglines, barges or other special equipment. It should be detailed, calculated and summarized separately, in most cases.

### 3.5.7 Borrow Excavation (Truck Measure)

Borrow Excavation is the pay item used to indicate that the contractor is to furnish earthwork material from areas provided by him and generally outside the project limits, including material with a specific minimum bearing value for building up existing shoulders, when appropriate for the project.

Borrow material, if available, may be obtained from within the right of way of the project. Obtaining material from the project right of way shall not create an unsafe condition or unprotected hazard. Proper design criteria shall be applied to proposed excavation areas which will fill with water. The proposed borrow areas shall be reviewed and coordinated with the District Environmental Coordinator to minimize environmental disturbance and promote a future original appearance.

When the designer chooses the method of payment as Borrow Excavation (Truck Measure), a fill adjustment must be made to the net total fill material calculated from the plans, to allow for handling. An additional adjustment (truck) is added to obtain a representative volume of material required. This is not a plan quantity item, but it is very important that the most realistic determination of quantities possible be calculated by the designer. Recommendations on fill and truck adjustment percentages should always be obtained from the District Materials and Construction Offices during the design process.

EXAMPLE	Fill (From Working Typical)	253 CY
	Fill Adjustment (+35%) (253 x 0.35)	<u>89 CY</u>
	Fill	342 CY
	Truck Adjustment (+25%) (342 x 0.25)	<u>86 CY</u>
	Borrow Excavation (Pay Item)	428 CY

### 3.5.8 Regular Excavation (RRR Projects Only) - Lump Sum

The Pay Item for Regular Excavation (RRR Projects Only) - Lump Sum is to be used on resurfacing or minor widening and resurfacing (RRR) projects which conform to the following guidelines

- There are limited or no cross sections on the project
- Existing typicals are reasonably consistent throughout the project
- If utility adjustments are a consideration on the project, the designer will need to be sure that sufficient data is available to allow the utility to be relocated or adjusted
- There are no right of way requirements on the project
- There is no change in the existing horizontal or vertical alignment
- There are no major special ditches on the project.
- There are no major intersection modifications
- Show quantity of Excavation in Summary Box, but pay for as 1 Lump Sum

Regular Excavation (RRR Projects Only) - Lump Sum can be used on projects other than RRR, but only if they are minor projects complying with the same listed guidelines

Earthwork will be paid for as Borrow Excavation (Truck Measure) and Regular Excavation (RRR Projects Only) – Lump Sum. The designer will calculate these quantities based on information obtained from the field and the proposed typical section. The designer must conduct a thorough field review to ensure existing field conditions are accurately reflected in earthwork estimates.

### 3.5.9 Summary of Earthwork

The last sheet in each group or cross section group (mainline, sidestreet, pond 1, etc ) should tabulate the totals for each earthwork operation (subsoil excavation, regular excavation and embankment)

Below is an example of a summary of earthwork box for projects with cross sections. The summary should document all the groups totals in one location. This summary should be shown on the Summary of Quantities Sheet.

SUMMARY OF EARTHWORK (CUBIC YARDS)	
ROADWAY EXCAVATION, Mainline	10,000
ROADWAY EXCAVATION, Sidestreet Name	800
REGULAR EXCAVATION, Pond # 1	1,005
REGULAR EXCAVATION FROM LATERAL DITCHES	5,000
<b>TOTAL REGULAR EXCAVATION</b>	<b>6,805</b>
EMBANKMENT, Mainline	20,000
EMBANKMENT, Sidestreet	7,000
<b>TOTAL EMBANKMENT</b>	<b>27,000</b>
SUBSOIL EXCAVATION, Mainline	2,080
SUBSOIL EXCAVATION, Sidestreet Name	<u>1,100</u>
<b>TOTAL SUBSOIL EXCAVATION</b>	<b>3,180</b>

Below is an example of a summary of earthwork box that should be used for projects with limited or no cross sections. This summary should be shown on the Summary of Quantities Sheet. The summary should show all quantities and adjustments.

SUMMARY OF EARTHWORK (CUBIC YARDS)	
FILL	253
GUARDRAIL LOCATIONS	70
CROSS DRAINS	<u>100</u>
	423
FILL ADJUSTMENT (35%) (423 x 0.35)	+ <u>148</u>
FILL	571
TRUCK ADJUSTMENT (25%) (571 x 0.25)	+ <u>143</u>
TOTAL BORROW EXCAVATION	714
Excavation	200

The pay items used will be    Regular Excavation (RRR Projects Only)    1 (LS)  
    Borrow Excavation (Truck Measure)    714 CY

## Chapter 4

### ROADSIDE SAFETY

4.1	Clear Zone . . . . .	4-1
4.1.1	Clear Zone Concept . . . . .	4-1
4.1.2	Clear Zone Criteria . . . . .	4-2
4.2	Canal Hazard Standards . . . . .	4-4
4.3	Roadside Barriers . . . . .	4-7
4.3.1	Warrants . . . . .	4-7
4.3.2	Barrier Selection . . . . .	4-8
4.3.3	End Treatments . . . . .	4-8
4.3.4	Transitions . . . . .	4-9
4.3.5	Placement . . . . .	4-9
4.3.6	Upgrading Existing Barrier Systems . . . . .	4-10
4.3.6.1	Resetting Guardrail . . . . .	4-11
4.4	Median Barriers . . . . .	4-12
4.4.1	Warrants . . . . .	4-12
4.4.2	Selection . . . . .	4-12
4.4.3	End Treatments . . . . .	4-12
4.5	Crash Cushions . . . . .	4-12
4.5.1	Warrants . . . . .	4-12
4.5.2	Selection . . . . .	4-13
4.5.3	Design . . . . .	4-14
4.6	Roadside Appurtenances . . . . .	4-14
4.6.1	Sign Supports . . . . .	4-14
4.6.2	Mailbox Supports . . . . .	4-14

---

4 6 3	Other Appurtenances . . . . .	4-14
4.6.4	Location Criteria . . . . .	4-15
4 6.5	Bus Benches and Transit Shelters . . . . .	4-15
Figure 4.1.2	Recovery Area and Clear Zone Distance . . . . .	4-3
Exhibit 4-A	Minimum Standards for Canal Hazards . . . . .	4-5
Exhibit 4-B	Minimum Standards for Canal Hazards . . . . .	4-6
Table 4.3.1	Minimum Offset of Barriers . . . . .	4-10

## Chapter 4

### ROADSIDE SAFETY

#### 4.1 Clear Zone

##### 4.1.1 Clear Zone Concept

A significant number of accidents involve a single vehicle leaving the roadway and either overturning or colliding with a fixed object. A roadside that is traversable and unobstructed by fixed objects will allow vehicles that leave the roadway to recover safely. The designer should provide as much traversable and unobstructed area (clear zone) as practical.

Roadsides are considered traversable if a vehicle can traverse them without seriously endangering the occupants. Roadside are considered recoverable if there is a reasonable probability of regaining control of a vehicle or bringing it to a safe stop.

If natural or man-made hazards, including slopes steeper than 1:3, occur within the clear zone, the designer should attempt the following treatments, in order of priority:

- 1 Eliminate the hazard
  - A Remove the hazard
  - B Relocate the hazard outside the clear zone
  - C Make the hazard traversable or crashworthy
- 2 Shield the hazard with a longitudinal barrier or crash cushion. This treatment should only be taken if the barrier or crash cushion presents a lesser hazard.
- 3 Leave the hazard unshielded. This treatment should be taken only if a barrier or crash cushion is more hazardous than the hazard, if the likelihood of striking the hazard is very small or if the expense of treatment outweighs the benefits in terms of accident reduction.

If accident data or safety reports indicate that early treatment of the hazards will result in fewer or less severe accidents, designers should consider directing that those treatments be accomplished as the first order of work, if feasible and practical.



### **4.1.2 Clear Zone Criteria**

Criteria have been developed with the objective of providing the necessary recovery area for the vehicles that might leave the roadway. The criteria are based on limited empirical data which was then extrapolated for a wide range of conditions. The criteria represent a reasonable degree of roadside safety, but they are neither absolute nor precise. These criteria must be applied with judgement. In some cases, the clear zone can be adjusted greater or less than the criteria. In all cases, the most clear zone that can be practically provided is desirable.

**Chapter 2** includes criteria for clear zones, as well as other design criteria related to highway safety for new construction or reconstruction projects.

If a non-recoverable slope encroaches the clear zone, then a clear runout area should be provided beyond the toe of slope equal to the width of the encroachment. A minimum of 10 ft of clear runout area beyond the toe of slope should be provided.

**Chapter 25** provides clear zone criteria for RRR type projects.

**Figure 4.1.2 Recovery Area And Clear Zone Distance**

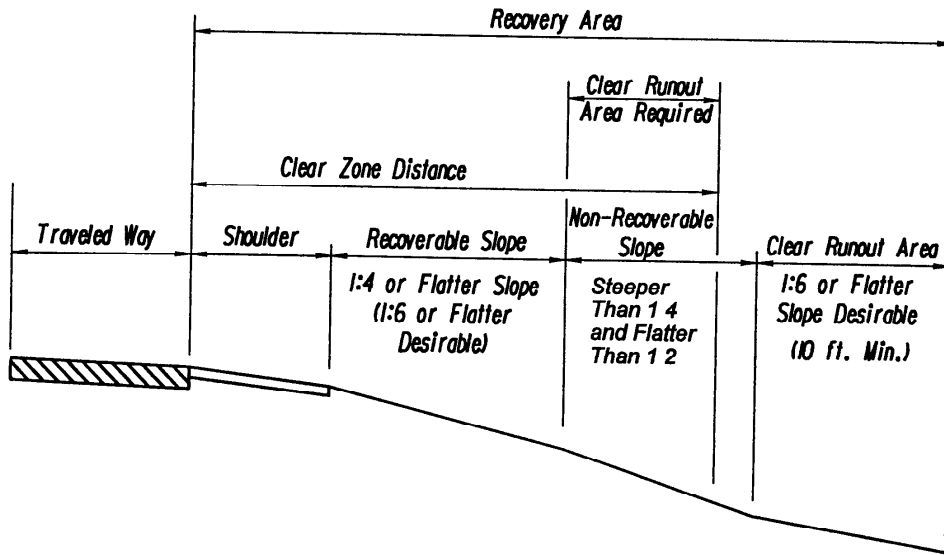

*Note: These slope values are for nomenclature only.  
See Chapter 2, Table 2.4.1 for new construction slope criteria.  
See Chapter 25 for RRR slope criteria.*

*Example of a Parallel Embankment Slope Design. This figure illustrates a recoverable slope followed by a non-recoverable slope. Since the clear zone distance extends onto a non-recoverable slope, the portion of the clear zone distance on such a slope may be provided beyond the non-recoverable slope if practical. This clear runout area would then be included in the total recovery area. The clear runout may be reduced in width based on existing conditions or site investigations. Such a variable sloped typical section is often used as a compromise between roadside safety and economics.*

## 4.2 Canal Hazard Standards

Canals are defined as an open ditch parallel to the roadway for a minimum distance of 1000 ft and with a seasonal water depth in excess of 3 ft for extended periods of time (24 hours or more)

The distance from the outside edge of the through travel lane to the top of the canal side slope nearest the road will be no less than 60 feet for highways with design speeds of 50 mph or greater. For highways with design speeds less than 50 MPH this minimum distance may be reduced to 50 ft for rural highways or 40 feet for urban (curb and gutter) highways. When new canal or roadway alignment is required, distances greater than those above should be provided, if possible, to accommodate possible future improvements to the roadway (widening, etc.)

On fill sections, a flat berm (maximum 1:10 slope) of width no less than 20 feet will be provided between the toe of the roadway front slope and the top of the canal side slope nearest the roadway. This minimum berm width applies to all types of highways, both rural and urban (curb and gutter) construction. (See **Exhibits 4-A & 4-B**)

When the slope between the roadway and the "extended period of time" water surface is 1:6 or flatter, the minimum distance can be measured from the edge of the through lane to the "extended period of time" water surface and a berm is not required.

In sections with ditch cuts, 20 feet will be provided between the toe of the front slope and the top of the canal.

Guardrail or other protective devices shall be installed 5 feet from the canal front slope where it is not possible to meet the above minimum criteria. The design is complicated when clear zone and slope criteria are combined with canal hazard criteria. Extreme caution must be taken to ensure that all criteria are met.

If the minimum standards for canal hazards cannot be met, then the standard guardrail treatments as provided in the **Roadway and Traffic Design Standards** should be used.

### MINIMUM STANDARDS FOR CANAL HAZARDS

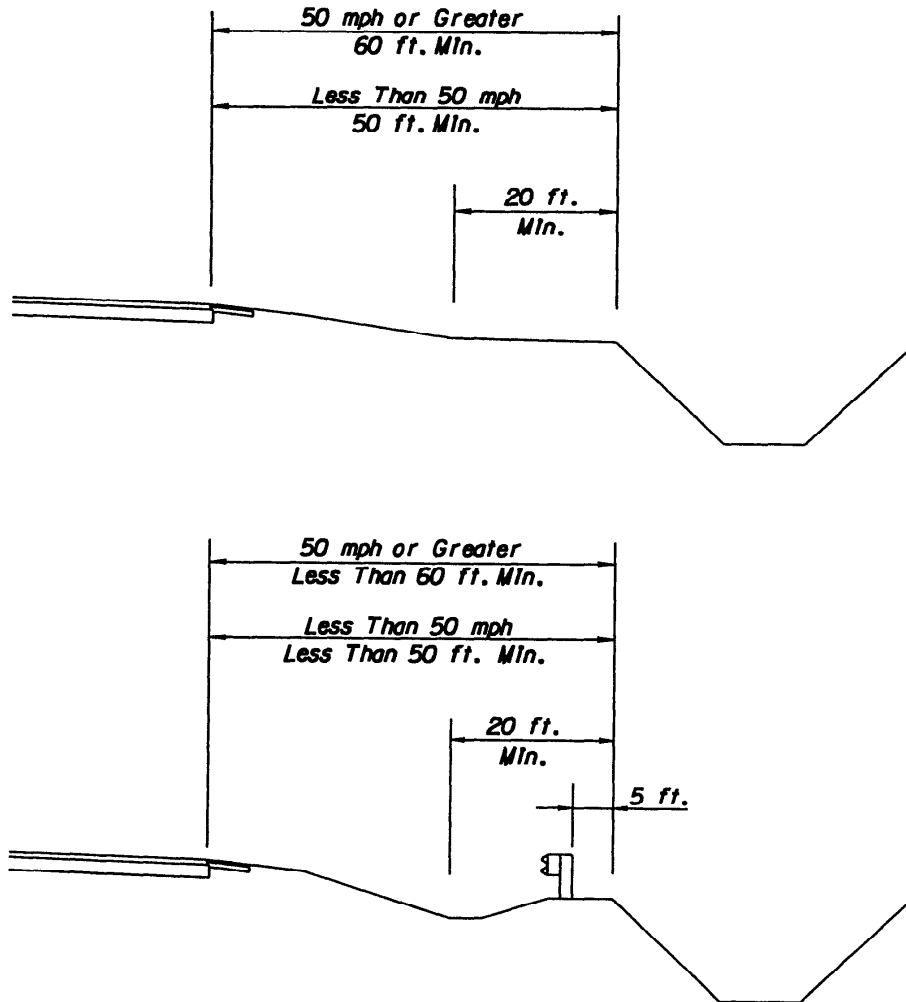
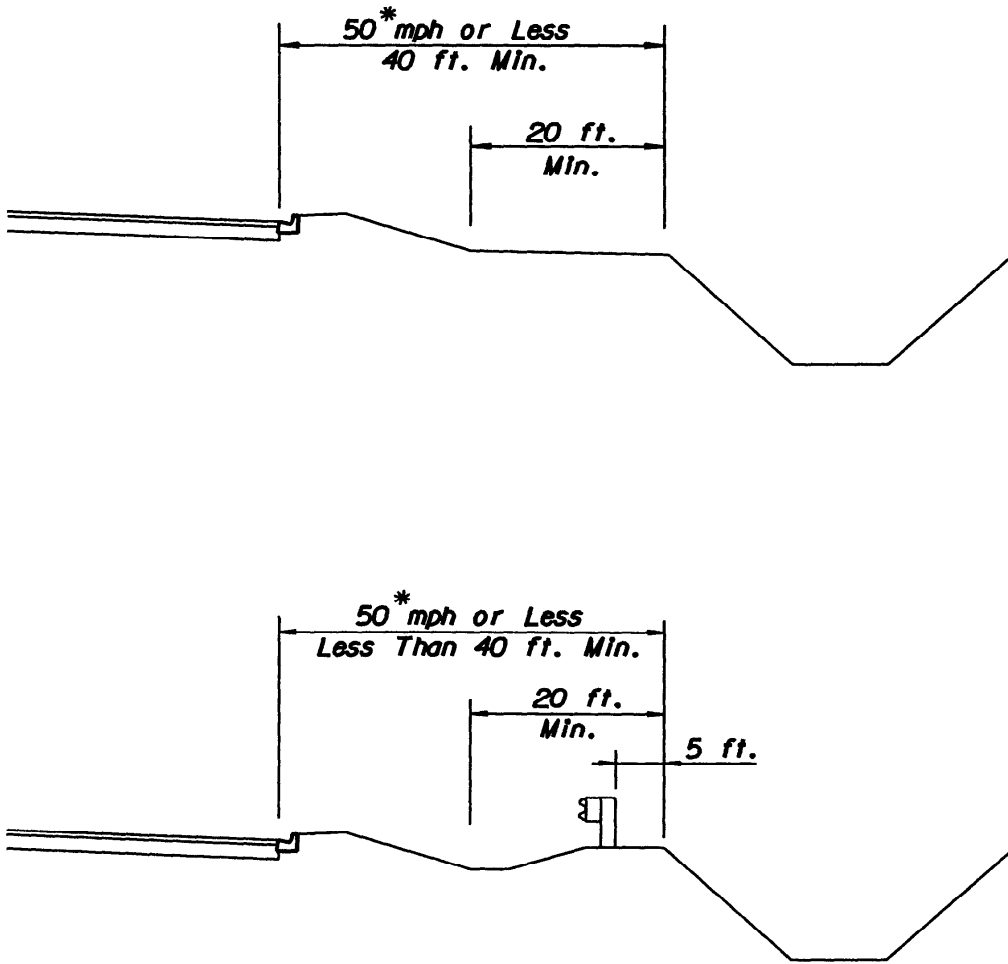

Exhibit 4-A

### MINIMUM STANDARDS FOR CANAL HAZARDS



\* Posted speeds not to be greater than 45 mph.

Exhibit 4-B

## 4.3 Roadside Barriers

### 4.3.1 Warrants

Roadside barriers are warranted when hazards exist within the clear zone, cannot be cost effectively eliminated or corrected and collisions with the hazards will be more serious than collisions with the barriers

The length of advancement and length of need necessary to properly shield the hazard must be determined on an installation by installation basis as indicated in the ***Roadway and Traffic Design Standards***

The following conditions within the clear zone are normally considered more hazardous than a roadside barrier

- Fill slopes steeper than 1 3
- Vertical dropoffs created by retaining walls on roadways with flush shoulder sections For curbed sections, a roadside barrier is required for dropoffs greater than 5 ft high created by retaining walls located within 16 ft of a traffic lane
- Bridge piers, abutments and railing ends
- Non-traversable culverts, pipes and headwalls
- Non-traversable parallel or perpendicular ditches and canals
- Bodies of water other than parallel ditches and canals that the engineer determines to be hazardous
- Parallel retaining walls with protrusions or other potential snagging features
- Retaining walls at an approach angle with the edge of pavement larger than 7 degrees (1 8)
- Non-breakaway sign or luminaire supports
- Trees greater than 4 inches in diameter measured 6 inches above the ground at maturity
- Utility poles
- Rigid protrusions above the ground in excess of 4 inches in height

In addition to the above hazards, there may be other situations that warrant barrier consideration, such as nearby pedestrian or bicycle facilities, schools, residences or businesses

### 4.3.2 Barrier Selection

Acceptable standard roadside barriers are detailed in the ***Roadway and Traffic Design Standards***. They include

- Standard blocked-out W-beam on wood post (strong post)
- Standard blocked-out W-beam on "C" steel post (strong post)
- Standard blocked-out W-beam on wide flange steel post (strong post)
- Blocked-out Thrie-Beam on any of the above post systems
- Standard concrete barrier wall

Most guardrail installations will be blocked-out W-beam on wood or steel posts. The Thrie-Beam guardrail should be considered when additional rail depth is needed because of a potential to under-ride the rail or because additional height may be needed. Other barrier designs may be required by specific site conditions. These must be called for and detailed on a project by project basis.

### 4.3.3 End Treatments

Longitudinal barrier ends which are not crash worthy can present serious hazards if they terminate within the clear zone. The FDOT's crash worthy end treatments and application criteria are detailed in the ***Roadway and Traffic Design Standards***. Other end treatments may be required under special circumstances. Special details will be required in the plans, when this is the case.

- It is very important that the flare with offset be provided exactly as shown in the ***Roadway and Traffic Design Standards***. The end offset should be measured off a projection of the face of guardrail alignment. The maximum allowable cross slope in front of the rail is 1:10, including the area in front of and the upstream approach to the end anchorage assembly.
- Non-crash worthy end treatments will be used outside the clear zone, and at downstream terminations which are outside the clear zone of the opposing traffic flow. The Type II end anchorage is non-crash worthy and, therefore, may **NOT** be used as an approach terminal end treatment unless other end shielding is provided.
- Thrie-beam and concrete barrier wall will be terminated as shown in the ***Roadway and Traffic Design Standards***.

#### 4.3.4 Transitions

Whenever standard W-beam or Thrie-beam guardrail transitions into bridge rail or concrete barrier wall, a transition section is necessary. Transitions must include sound structural connections, nested beams and additional posts for increased stiffness, as shown in the ***Roadway and Traffic Design Standards***. Standard flares should be introduced upstream of the transition section. Care must be taken in the details of the junction of the two barrier types to avoid snag points.

#### 4.3.5 Placement

The primary design factors associated with guardrail placement are

- Lateral offset from the edge of pavement
- Terrain effects
- Flare rate
- Length of advancement
- Length of need

The standard offset is the shoulder width plus 2 ft, not to exceed 12 ft. Alternate guardrail offset locations are shown in the ***Roadway and Traffic Design Standards***.

A 2 ft distance from the back of the barrier posts to the shoulder line or slope break is desirable for post support.

The length of advancement is dependent on the design speed, the offset distance to the face of guardrail and the lesser distance (a) to the back of the hazard or (b) to the clear zone needed. The designer must establish this advancement need for all installations on the project. On all facilities the guardrail needs must consider traffic from both directions.

A barrier should not be located so close to the hazard that it is shielding that the hazard is within the dynamic deflection distance of the barrier. The dynamic deflection of standard barriers are shown in Table 4 3-1.



**Table 4.3.1 Minimum Offset of Barriers  
(Measured from the face of the barrier)**

<b>BARRIER TYPE</b>	<b>OFFSET (ft)</b>
W-Beam with Post Spacing @ 6'-3"	4 0
W-Beam with Post Spacing @ 3'-1 1/2"	3 0
Thrie-Beam with Post Spacing @ 6'-3"	3 3
Thrie-Beam with Post Spacing @ 3'-1 1/2"	2 6
Barrier Wall	0
Double W-Beams (Nested) with Post Spacing @ 3'-1 1/2"	2 6
Double W-Beams (Nested) with Post Spacing @ 1'-6 3/4"	2 3

Curbs shall not be placed in the front of barriers. When guardrail is necessary, the guardrail shall be located at the face of the curb or in front of it.

Barriers should not be placed on slopes steeper than 1:10. This is particularly important for barrier ends shielded by crash worthy devices.

#### **4.3.6 Upgrading Existing Barrier Systems**

Deficient roadside barriers are generally upgraded in conjunction with other roadway work, such as RRR projects, or through spot or system wide safety improvement projects. In each case the designer must determine the scope and extent of the barrier upgrading to be accomplished. In making this determination, the existing installation should be investigated for what work is necessary to make the installation structurally and functionally adequate. The investigation should consider:

- 1) Whether there is a need for the barrier. If cost effective, the hazard should be removed, relocated, or re-designed and the barrier removed.
- 2) Length of Need
- 3) Proper rail height

- 4) Proper flare rate
- 5) Adequate offset at terminal end
- 6) Proper deflection distance between the barrier and the shielded object
- 7) Proper placement with respect to traffic lane
- 8) Proper placement with respect to curb
- 9) Placement on proper slope
- 10) Adequate clear runout area behind yielding terminals
- 11) The overall condition of the guardrail/barrier installation
- 12) Post type, condition and spacing
- 13) Existing unshielded hazards For spot improvements, only those existing unshielded hazards in the immediate vicinity of the installation being addressed should be reviewed For RRR projects, all existing roadside hazards within the project corridor should be reviewed for treatment needs

In some cases the deficiencies will be so obvious that the best course of action is readily apparent However, many times the deficiencies may be marginal and a decision on the scope and extent of the barrier upgrading will be based on engineering judgement Factors which should be considered are

- nature and extent of barrier deficiency
- past accident history
- cost effectiveness of recommended improvement
- whether future scheduled reconstruction or RRR work in the 5 year work program will address deficiency

#### 4.3.6.1 Resetting Guardrail

For those projects that include the resetting of guardrail, refer to the **Standard Specifications**, the **Basis of Estimates Handbook**, and the **Roadway and Traffic Design Standards** for pay items, notes and quantity calculations

## **4.4 Median Barriers**

### **4.4.1 Warrants**

A median barrier shall be provided on Interstate and expressway facilities where reconstruction reduces the median width to less than the standard for the facility. No variations or exceptions to this criteria will be approved.

### **4.4.2 Selection**

The same barrier types as discussed in **Section 4.3.2** are available as median barriers. In general, the concrete barrier wall is preferable in narrow medians.

### **4.4.3 End Treatments**

Median barriers can be terminated with any of the treatments discussed in **Section 4.3.3**.

## **4.5 Crash Cushions**

Crash cushions are attenuating devices that may be non-redirective or redirective.

### **4.5.1 Warrants**

Hazards within the clear zone which present a more serious collision potential than a crash cushion, are warrants for the installation of a crash cushion.

#### 4.5.2 Selection

The following types of crash cushions are currently standardized for use

- QuadGuard
- ADIEM 350
- Crash Attenuating Terminal (CAT 350)
- Brakemaster 350
- Inertial Impact Attenuators (Sand Barrels)
- Work Zone Guardrail Energy Absorbing Terminal (G-R-E-A-T cz)
- Vehicle Arresting Barrier (DRAGNET)
- REACT 350

The ***Roadway and Traffic Design Standards*** and manufacturer's publications provide detailed information about these systems. Each system has its own unique physical and functional characteristics. The designer shall indicate in the plans the system to be used at each location. The design engineer shall consider the following factors when selecting a system for a particular location:

- Site characteristics
- Structural and safety characteristics of candidate systems
- Initial and replacement/repair costs
- Expected frequency of collisions
- Maintenance characteristics

Site characteristics and economics dictate the crash cushion selection. Sand barrels are relatively low in initial cost, but usually must be completely replaced when struck, so are more appropriate in locations with a low likelihood of collision. The other systems have higher initial costs but can be repaired after collisions relatively cheaply, so are more appropriate where frequent collisions are expected. The ability of maintenance forces to perform routine maintenance and to place a crashed system back into service quickly should be a major consideration. Crash cushions that require stocking unusual and expensive parts or that are complex to replace should not be selected.

### 4.5.3 Design

Crash cushion suppliers normally provide design assistance for their system. These systems must decelerate both small automobiles and standard size pickup trucks from the established design speed of the facility to a gradual stop. If the **AASHTO Roadside Design Guide** charts are used, the maximum average deceleration level should not exceed approximately 7 g's.

All terrain within the likely approach of a vehicle should be relatively flat. An impacting vehicle should strike the unit at normal height, with the vehicle's suspension system neither collapsed nor extended. Curbs exceeding 4 inches in height shall not be used in the approach area of a crash cushion.

Sand barrels do not have redirection capability. They may be used for temporary barrier wall end shielding in accordance with **Standard Index 417**. For shielding on other temporary and all permanent installations, they must be custom engineered for each independent installation and detailed in the plans.

Care must be taken that the design of a crash cushion system does not create a hazard to opposing traffic.

The nose of all crash cushions shall be delineated with reflective material or standard object markers, as indicated in the **Roadway and Traffic Design Standards**.

## 4.6 Roadside Appurtenances

### 4.6.1 Sign Supports

All sign supports, except overhead cantilever, truss type or bridge or barrier wall mounted, shall be either breakaway or frangible as defined in the **AASHTO Standard Specifications for Structural Supports for Highway Signs, Luminaires and Traffic Signals** and the **AASHTO Roadside Design Guide**. Sign supports shall be of an acceptable and crash worthy design as described in the **Roadway and Traffic Design Standards**. Supports not meeting the frangibility or breakaway criteria should not be installed within the clear zone. Sign supports not meeting these requirements which must be installed within the clear zone shall be protected by a barrier or crash cushion.

### 4.6.2 Mailbox Supports

Mailbox supports shall be of an acceptable crash worthy design, as described in **Roadway and Traffic Design Standards**.

### 4.6.3 Other Appurtenances

The **Roadway and Traffic Design Standards** contain design criteria for numerous other roadside appurtenances.

#### **4.6.4 Location Criteria**

Most breakaway mechanisms are designed to be impacted at bumper height, typically about 20 inches above the ground. If impacted at a significantly higher point, the bending moment in the breakaway base may be sufficient to bind the mechanism, resulting in non-activation of the breakaway device. For this reason, it is important that breakaway supports not be located in ditches or on steep slopes where a vehicle is likely to be partially in sprung suspension at the time of impact.

#### **4.6.5 Bus Benches and Transit Shelters**

These features are discussed in Section III of the *Florida Manual of Uniform Minimum Standards for Design, Construction and Maintenance for Streets and Highways (Green Book)*.

## Chapter 5

### UTILITIES

5.1	General .....	5-1
5.2	Utility Accommodation Manual .....	5-1
5.3	Location of Existing Utilities .....	5-2
5.3.1	Levels of Utility Locates .....	5-3
5.4	Subsurface Utility Engineering .....	5-4
5.5	Coordination Process .....	5-4

## Chapter 5

# UTILITIES

### 5.1 General

The Department has the responsibility to maintain state highways as necessary to preserve the integrity, operational safety and function of the highway facility. Since the manner in which utilities cross or otherwise occupy highway right of way can materially affect the safe operation, maintenance and appearance of the highway, it is necessary that such use of the right-of-way be authorized and reasonably regulated. By Florida Statutes, utilities, whether public or privately owned, aerial or underground are permitted by the Department to be accommodated within the right-of-way on the State Highway System. For limited access highways, parallel utilities within the right-of-way are not allowed except for utilities serving facilities required for operating the transportation system. Lateral crossings are allowed by permit only (see ***Utilities Topic # 710-020-001, Utility Accommodation Manual***).

The designer should make every effort to design a project that will accommodate all existing utilities and new utilities to be constructed concurrently with the project. The selection of typical section features, horizontal alignment and location of storm sewer lines are areas that can sometimes be varied without violating safety standards and design criteria. Design features which reduce or avoid utility conflicts may involve increased cost, however, those costs may be offset by savings in construction time and the total associated cost savings for the FDOT project and the utilities.

### 5.2 Utility Accommodation Manual

Utility owners are required to obtain utility permits for the installation and maintenance of utility facilities within the right-of-way of any State Highway System. These permits will be issued and approved by FDOT in conformity with the ***Utility Accommodation Manual***. This includes utility work required by FDOT projects. The designer may be involved in the coordination of this process.

The Department's ***Utility Accommodation Manual*** is established to regulate the location, manner, installation and adjustment of utility facilities along, across, under or on right-of-way under the jurisdiction of the FDOT. This manual also establishes the process for issuing permits for such work which is in the interest of safety, protection, utilization and future development of the highways with due consideration given to public service afforded.



by adequate and economical utility installations as authorized under **Section 337.403, Florida Statutes** and **Florida Administrative Code Rule 14-46.001**. Adherence shall be required under the circumstances set forth in the **Utility Accommodation Manual**

Additional guidance for accommodating utilities within the highway rights-of-way are given in the AASHTO publications **A Guide for Accommodating Utilities within Highway Right-of-Way** and **A Policy on Geometric Design of Highways and Streets** and in the TRB publication **Policies for Accommodation of Utilities on Highway Rights-of-Way**

### **5.3 Location of Existing Utilities**

Determining the location of existing utilities on State highway right-of-way is a cooperative effort between the FDOT and the utility owners. The degree of effort on the part of the FDOT and the utility owner will vary with the type of project, the utility, and availability of existing location information. As a minimum the location of existing major utilities is required on new construction, reconstruction, and add lane projects.

Major existing utilities are those principal underground and aerial utilities that potentially conflict with construction activities and scheduling. The presence of major utilities shall be determined on each project by the utility owner. Service connections and laterals are not normally considered major utilities.

It is the responsibility of the design engineer with the assistance of the District Utility Engineer and construction personnel to determine the locations and levels of locate where utility information is needed. Levels of locates are defined in **Section 5.3.1**. It is the responsibility of the utility owner to provide up through a Level "B" locate on request. In some instances the utility owner can provide Level "A" locate information. If Level "A" locate information is necessary and cannot be provided by the utility owner, the measurement and documentation for the level "A" locate will be obtained by the FDOT, consultants, or others by established agreement.

Existing major underground utilities which are suspected to be located within one meter of proposed construction operations which would threaten the utility should be considered for Level "A" locate information. The decision to allow utilities to remain within one meter of new construction operations should be made by the Design Engineer in consultation with the District Utility Engineer and appropriate construction personnel.

### 5.3.1 Levels of Utility Locates

The following identifies the level of utility locates in ascending order

Level "D" - Existing Records

Level "C" - Surface Visible Feature Survey

Level "B" - Designating

Level "A" - Locating

**Level "D" locates** - Information obtained solely from a review of utility records. The comprehensiveness and accuracy of such information is highly limited. Even when existing information for a utility in a particular area is accurate, there are often other underground systems that are not shown on any records. Level "D" may be appropriately used early in the development of a project to determine the presence of utilities.

**Level "C" locates** - Information obtained to augment Level "D" information. This involves topographic surveying of visible, above-ground utility features -- poles, hydrants, valve boxes, circuit breakers, etc -- and entering the topographic data into the CADD system. Level "C" may be appropriately used early in the development of a project and will provide better data than Level "D" information alone. Designers must be very cautious when working on projects using information for underground utilities that is based only on Levels "D" and "C" locates.

**Level "B" locates** - Information obtained through the use of designating technologies (e.g., geophysical prospecting technologies). This is an application using scanning technologies, most of which have very specific capabilities. Applying a variety of techniques is essential to the process of preparing a comprehensive *horizontal* map of utilities and other underground structures on the site. Designating technologies are capable of providing good horizontal information but provide limited vertical information.

**Level "A" locates** - Provide the highest level of accuracy of utility locations in three dimensions. This level may apply manual, mechanical or nondestructive (e.g., vacuum excavation) methods to physically expose utilities for measurement and data recording. Levels "B", "C", and "D" locates are incorporated in Level "A" locates. The designer should obtain Level "A" locates at highway/utility conflict points where verified information is necessary.

## **5.4 Subsurface Utility Engineering**

Subsurface utility engineering (SUE) is an established engineering technology that can provide horizontal and vertical locations of underground utilities to produce an accurate picture of underground infrastructure. The techniques of SUE may be appropriate for certain FDOT projects where Levels "A" and "B" locates are determined to be essential.

## **5.5 Coordination Process**

Coordination between the Department and the utility owners is to be accomplished through the District Utility Engineer during the initial and final engineering design processes. Refer to **Chapters 13 through 16** of this manual for the design and review processes.

## Chapter 6

### RAILROAD CROSSING

6.1	General	6-1
6.2	At-Grade Crossings	6-1
6.2.1	Devices	6-1
6.2.2	Surfaces	6-2
6.3	Grade Separations	6-2
6.3.1	Criteria	6-3
6.3.2	Bridge Width	6-3
6.3.3	Horizontal Clearances to Face of Structures	6-3
6.3.3.1	Adjustments for Track Geometry	6-4
6.3.3.2	Adjustments for Physical Obstructions	6-4
6.3.3.3	Required Foundation Clearances	6-4
6.3.4	Crash Walls	6-5
6.3.5	Vertical Clearance	6-6
6.3.6	Special Considerations	6-6
6.3.7	Widening of Existing Overpasses	6-6
Table 6.3.3	Horizontal Clearances for Railroads	6-4

#### Figures

6.1	Track Section	6-8
6.2	Crash Wall Elevation	6-9
6.3	Section Thru Tracks	6-10

## Chapter 6

# RAILROAD CROSSING

### 6.1 General

A railroad-highway crossing, like any highway-highway intersection, involves either a crossing at-grade or a separation of grades. This chapter provides standard requirements for crossings at other than high-speed railways. Crossing requirements for high-speed railways must be coordinated with the Department's Rail Office on a project-specific basis.

The following three major railroad companies currently operate in the State of Florida:

- CSX Transportation, Incorporated
- Florida East Coast Railway Company
- Norfolk Southern Corporation

Ten shortline railroad companies and three terminal switching companies also operate in the State of Florida.

### 6.2 At-Grade Crossings

Selection of the warning devices to be used is a function of the geometrics of railroad-highway grade crossing, including the alignment, profile, sight distance and cross section of both the roadway and the railroad. Railroad grade crossing angles should be as near 90 degrees as practical.

Design Criteria and Standards are given in the Department's *Railroad Procedures Manual*. Design considerations are discussed in Chapter IX of the *AASHTO Policy on Geometric Design*.

#### 6.2.1 Devices

Traffic control devices for railroad-highway grade crossings consist primarily of signs, pavement markings, flashing light signals and automatic gates. A large number of significant variables must be considered in determining the types of warning device to be installed at a railroad grade crossing. The type of highway, volume of vehicular traffic, volume of railroad traffic, speed of vehicular traffic, volume of pedestrian traffic, accident record, and geometrics of the crossing are some of the factors influencing the choice of

warning devices to be provided at the railroad crossing

Standards and criteria for design, placement, installment and operation of these devices are covered in the **Manual on Uniform Traffic Control Devices (MUTCD)** and the Department's **Railroad Procedure Manual**. The Department's **Roadway and Traffic Design Standards** should also be consulted in the design of railroad crossings

### 6.2.2 Surfaces

The highway traveled way at a railroad crossing should be constructed for a suitable length with all-weather surfacing. A roadway section equal to the current or proposed cross section of the approach roadway should be carried across the crossing. The crossing surface itself should have a riding quality equivalent to that of the approach roadway. When selecting the type of crossing and the material to be used in its construction, consideration should be given to the character and volume of traffic using the highway. The Department's **Highway-Railroad Grade Crossing Material Selection Handbook** should be consulted in selecting the material.

The **Roadway and Traffic Design Standards, Index 560** contains details for the construction of crossings.

### 6.3 Grade Separations

For underpasses, the bridge carries the railway and must be designed and constructed to carry railway loadings in conformance with the **American Railway Engineering and Maintenance Association (AREMA) Manual for Railway Engineering**, latest edition. For overpasses, the bridge carries highway traffic and must be designed and constructed to carry highway loadings. In either case, adequate clearances between the facilities must be provided.

Clearances, geometrics, utilities, provisions for future tracks, and maintenance road requirements for off-track equipment will involve negotiations with the governing railroad company. The railroad's review and approval, including need for and location of crash walls, shall be based on the completed BDR/30% Structures Plans prepared by the SDO, District Structures Design Engineer, or their consultant.

### **6.3.1 Criteria**

The Structures Plans shall be prepared in accordance with the criteria obtained from the governing railroad company, the *Plans Preparation Manual*, and the *Structures Detailing Manual*

See **Figure 6-1** for dimensions which must be obtained from the railroad company before preparing the BDR/30% Structures Plans

The District Rail Coordinator is an additional reference source available to the designer

### **6.3.2 Bridge Width**

For overpasses, the highway bridge width is determined from the approved typical section for the proposed bridge. Details for underpasses will depend on the specific project.

### **6.3.3 Horizontal Clearances to Face of Structures**

Horizontal clearances shall be measured in accordance with **Figure 6.1**. The governing railroad company occasionally may accept a waiver from normal clearance requirements if justified, i.e., for designs involving widening or replacement of existing overpasses. The FDOT's Rail Office should be consulted if such action is being considered.

The minimum horizontal clearances measured from the centerline of outside track to the face of pier cap, bent cap, or any other adjacent structure are shown in **Table 6.3.3**, but must be adjusted for certain physical features and obstructions as described hereinafter.

**Table 6.3.3 Horizontal Clearances for Railroads**

<b>Minimum Clearance Requirements</b>	<b>Normal Section</b>	<b>With 8 ft. Req'd. Clearance for Off-Track Equip.</b>	<b>Temporary Falsework Opening</b>
With Crash Walls	18 ft	22 ft	10 ft
Without Crash Walls	25 ft	25 ft	N/A

The additional 8 ft horizontal clearance for off-track equipment shall be provided only when specifically requested in writing by the railroad. In the event there is any doubt, the FDOT's Rail Office should be consulted.

**6.3.3.1 Adjustments for Track Geometry**

When the track is on a curve, the minimum horizontal clearance shall be increased at a rate of 1.5 inches for each degree of curvature. When the track is superelevated, clearances on the inside of the curve will be increased by 3.5 inches horizontally per inch of superelevation. For extremely short radius curves, the **AREMA** requirements shall be consulted to assure proper clearance.

**6.3.3.2 Adjustments for Physical Obstructions**

Columns or piles should be kept out of the ditch to prevent obstruction of drainage. Horizontal clearance should be provided to avoid the need for crash walls unless extenuating circumstances dictate otherwise.

**Figure 6.1** shows horizontal dimensions from the centerline of track to the points of intersection of a horizontal plane at the rail elevation with the embankment slope. This criteria may be used to establish the preliminary bridge length which normally is also the length of bridge eligible for FHWA participation, however, surrounding topography, hydraulic conditions, and economic or structural considerations may warrant a decrease or an increase of these dimensions. These dimensions must be coordinated with the governing railroad company.

**6.3.3.3 Required Foundation Clearances**

Edges of footings shall not be closer than 11 ft from centerline of the track to provide adequate room for sheeting.



### 6.3.4 Crash Walls

Except as stated below, crash walls are required for all bridges over railroads in which any part of the substructure above the ground is to be constructed closer than 25 ft from the centerline of the track measured perpendicular to the track, unless the size of the pier satisfies the criteria for piers of heavy construction as listed below. Multiple column piers with individual columns meeting the requirements of heavy construction as defined below do not require crash walls.

The crash wall shall be constructed integral with the pier or bent and shall have a smooth face. Piles for the crash wall shall be driven to the minimum penetration required by the FDOT Specifications.

Crash walls shall meet the following requirements:

- Crash walls for piers within 25 ft clear from the centerline of the track shall have a minimum height of 6 ft above the top of rail. Crash walls shall be at least 36 inches thick and at least 12 ft long.
- When required for multi-column piers, the crash wall shall connect the columns and extend at least 12 inches beyond the outermost columns, parallel to the track.
- Crash walls shall be anchored to the footings and columns as applicable and shall extend to at least 4 ft below the lowest surrounding grade if not supported on piles. Walls supported on piles shall extend 6 inches below the lowest surrounding grade. Piles in crash walls shall be at least 18 inches prestressed piles of a size used in the bridge and shall be driven to the minimum penetration required in **Section 455** of the Specifications.
- A pier or column shall be considered of heavy construction if it has a minimum cross-sectional area of 17 square ft. The minimum dimension shall be 3 ft, and the larger dimension of rectangular piers or columns shall be parallel to the track.
- Consideration may be given to providing protection for bridge piers located more than 25 ft from the centerline of track as conditions warrant. In making this determination, account shall be taken of such factors as horizontal and vertical alignment of the track, embankment height, and an assessment of the consequences of serious damage in the case of a collision.

The lengthening of existing piers or bents with crash walls to accommodate bridge widening shall have the crash walls extended, and the extension shall meet the requirements for new construction.

Existing piers or bents with less than 25 ft of clearance and without crash walls, which are lengthened to accommodate bridge widening shall have separate crash walls constructed at the ends of the pier or bent. The crash walls should be added to both ends of the pier or bent even if the lengthening of the pier or bent was confined to one end only.

### 6.3.5 Vertical Clearance

Minimum vertical clearances for overpasses are given in **Table 2.10.1, Chapter 2** of this manual. Vertical clearance is the least distance between the bottom of the superstructure and the top of the highest rail utilized anywhere within the horizontal clearance zone determined by **Section 6.3.3 and Table 6.3.3**. If a track is identified as an electrified railroad, the minimum vertical clearance shall be 24 ft. This provision is based on the FDOT's **South Florida Rail Corridor Clearance Policy for 25 KV service (Topic No. 000-725-003)**. In addition to existing electrified railroads, this provision applies to tracks identified as candidates for future electrification.

### 6.3.6 Special Considerations

- Shoring and Cribbing requirements during construction should be accounted for in the preparation of the preliminary plans to assure compliance with the clearance criteria set forth herein. See **Figure 6.3**.

NOTE: Anything (e.g., cofferdams, footings, excavation, etc.) encroaching within 10 ft of centerline of the track requires approval of the governing railroad.

- Overpasses for electrified railroads may require protection screens.
- Sometimes the substructure supports may be located between tracks or an outside track and the off-track equipment road.
- Drainage from the section of the bridge above railroad right-of-way shall be drained away from the railroad right-of-way. When open scuppers are provided on the bridge, none shall be closer than 25 ft from the centerline of the nearest track.

### 6.3.7 Widening of Existing Overpasses

The requirements for widening existing overpasses are as follows:

- If existing horizontal or vertical clearances are less than those required for

a new structure, it is required that the new portion of the structure be designed so as not to encroach into the existing clearances

- Permanent vertical clearances will have to take into account the track grade and the cross slope of the bridge superstructure. Therefore, it is generally more desirable to widen on the ascending side of the bridge cross slope
- Permanent horizontal clearances will have to take into account horizontal curves and substructures that are not presently parallel to the track
- Temporary construction clearances are particularly critical where existing clearances are already substandard. If vertical and horizontal clearances less than 22 ft and 10 ft, respectively, are necessary, they will have to be approved on an individual basis. On high volume main lines, it may not be possible to reduce already restricted vertical clearances
- If widening requires construction of new widened approach fills, it is required that the same consideration be given to drainage design as required on new bridges. If new substructures provide less than 25 ft horizontal clearance from center line of track, they must be designed with crash wall protection except as stated above

The BDR/30% Structures Plans shall show a cross section at right angles to the centerline of the track where the centerline of bridge intersects the centerline of track. In situations where the substructure is not parallel to the track, or the track is curved, sections perpendicular to the centerline of the tracks shall be furnished at each substructure end

If the Railroad is in an existing cut section, plan approvals will be considered by the governing railroad on an individual location basis. Factors to be considered will be the length, depth, and type material of the existing cut section, in addition to all of the previously mentioned factors

Figure 6-1 Track Section

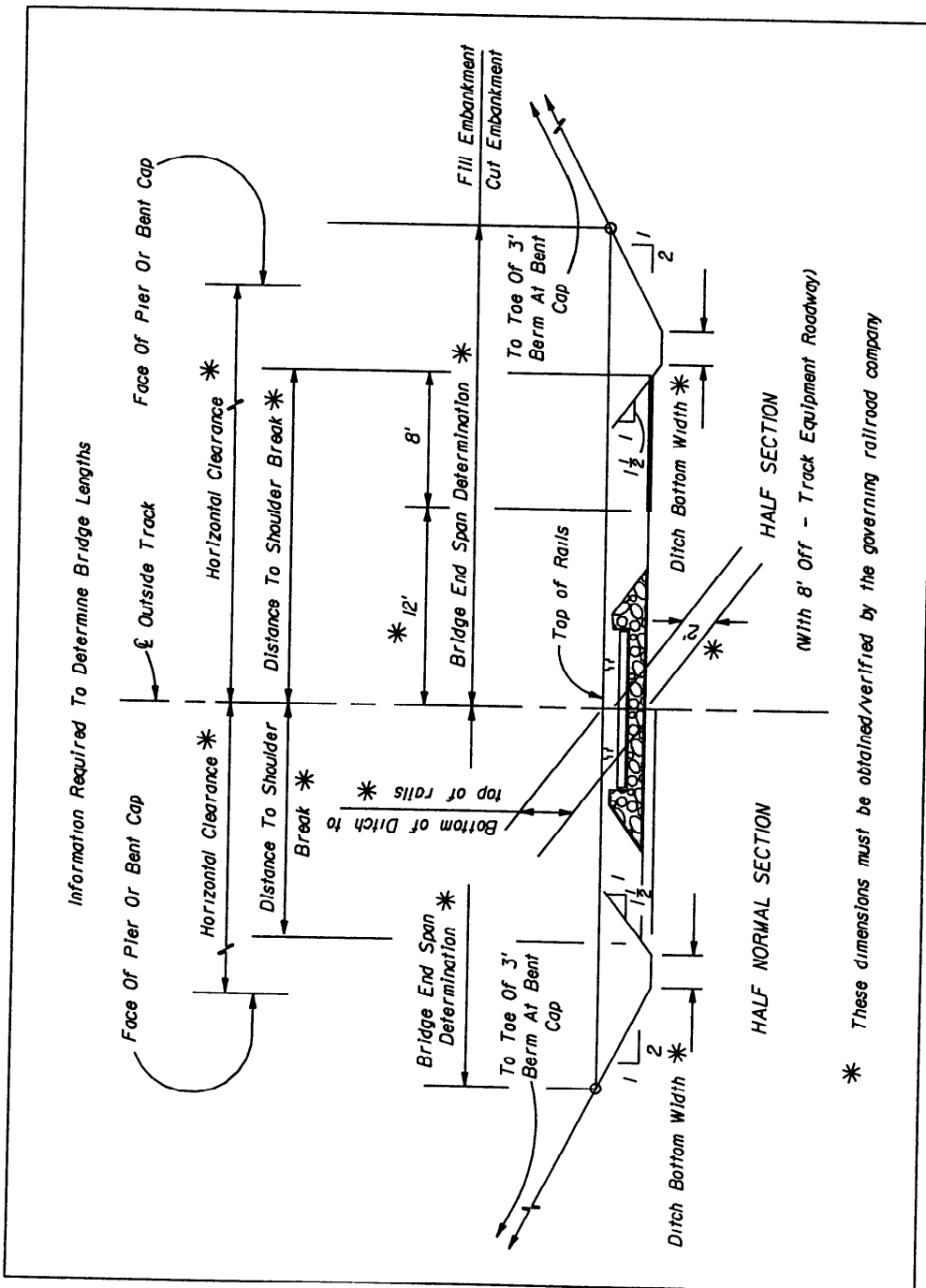
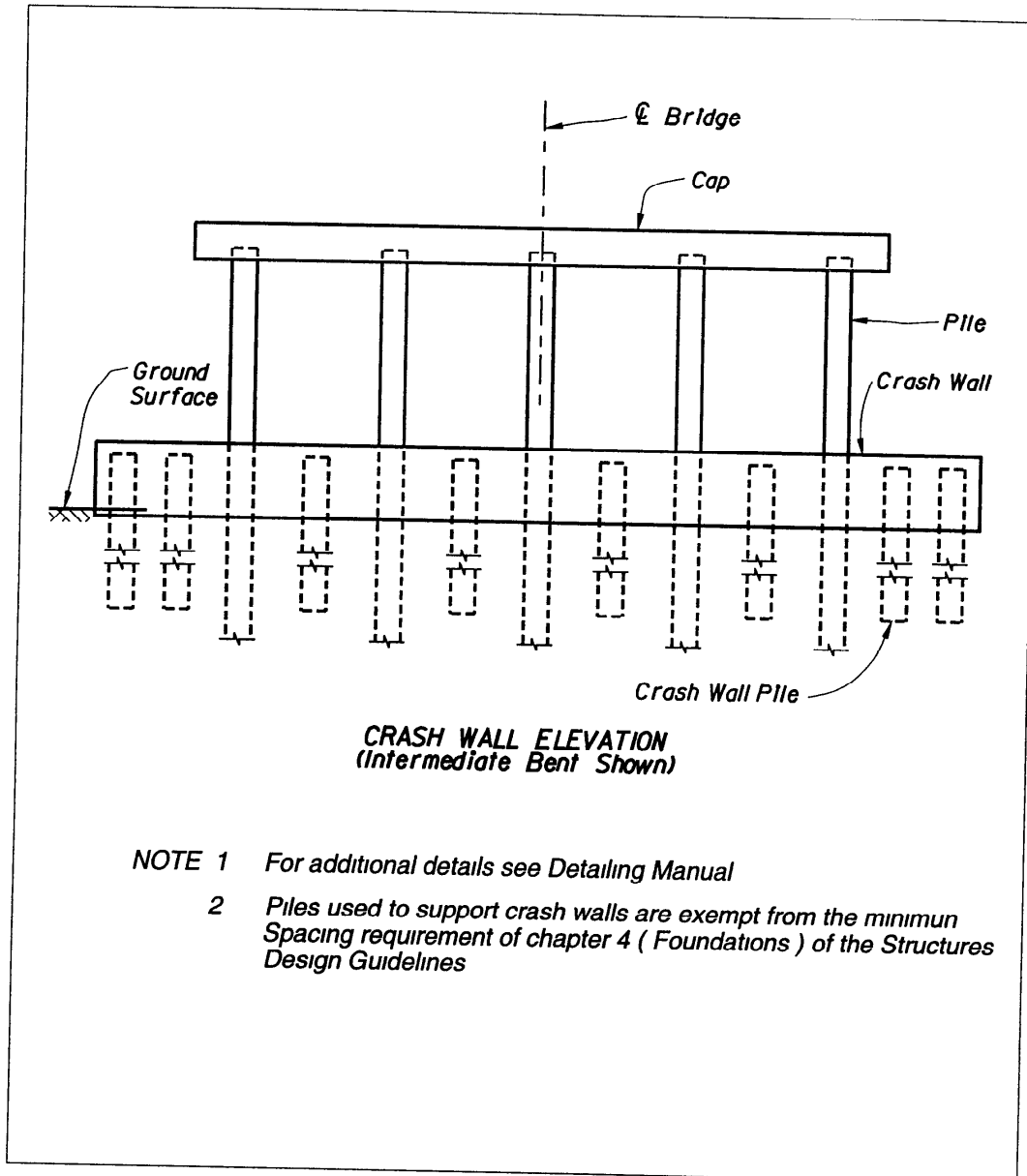
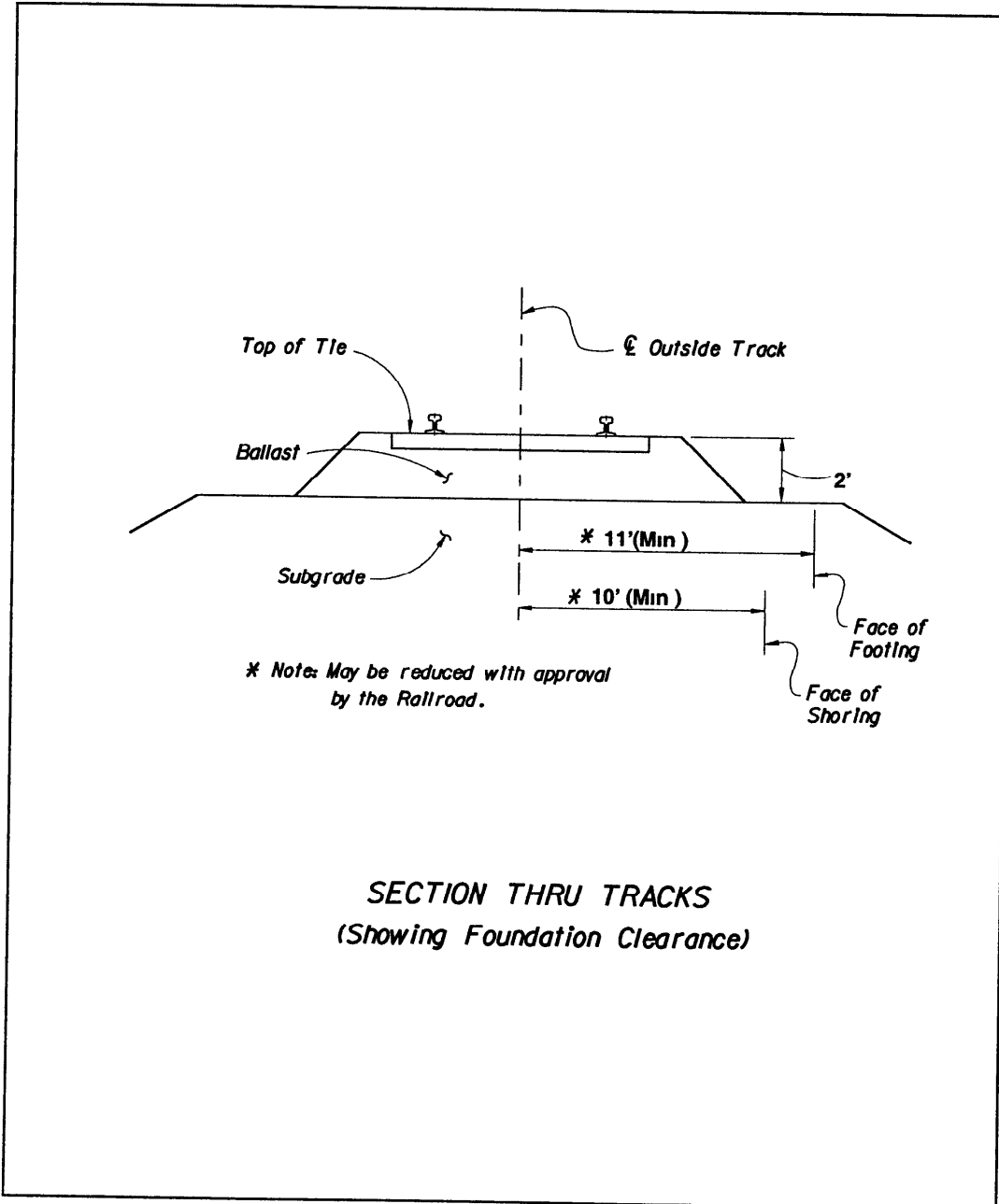

Figure 6-2 Crash Wall Elevation



**Figure 6.3 Section Thru Tracks**



## Chapter 7

### SIGNING, MARKING, LIGHTING AND SIGNALS

7.1	General	7-1
7.2	Signing and/or Pavement Marking	7-1
7.2.1	Design Criteria	7-2
7.2.2	Wind Loading Criteria - Signs	7-2
7.2.3	No-passing Zones	7-3
7.2.4	Use of Local Street Names on Guide Signs	7-4
7.2.5	Signing and Marking Project Coordination	7-4
7.2.6	Foundation Criteria	7-5
7.3	Lighting	7-5
7.3.1	Design Criteria	7-5
7.3.2	Pole Design Criteria	7-6
7.3.3	Foundations Criteria	7-6
7.3.4	Wind Loading Criteria - Lighting	7-6
7.3.5	Lighting Project Coordination	7-6
7.3.6	Voltage Drop Criteria	7-7
7.4	Traffic Signals	7-7
7.4.1	Design Criteria	7-8
7.4.2	Certification and Specialty Items	7-8
7.4.3	Stop Line Location	7-9
7.4.4	Controller Assemblies	7-9
7.4.5	Left Turn Treatments	7-10
7.4.6	Signal Preemption	7-11
7.4.7	Intersection Design - Lane Configuration	7-12
7.4.8	Signal Loops	7-13

- 7.4.9 Electrical Bonding . . . . . 7-14
- 7.4.10 Wind Loading - Traffic Signals . . . . . 7-14
- 7.4.11 Foundation Criteria . . . . . 7-14
- 7.4.12 Mast Arm Supports . . . . . 7-14
- 7.4.13 Traffic Signal Project Coordination . . . . . 7-14
  
- 7.5 Foundation Design . . . . . 7-15
  
- Table 7.2.1.1 . . . . . 7-2**



## Chapter 7

### SIGNING, MARKING, LIGHTING AND SIGNALS

#### 7.1 General

Traffic control devices are necessary to help ensure highway safety by providing the orderly and predictable movement of all traffic, motorized and non-motorized, throughout the highway transportation system, and to provide such guidance and warnings as are needed to ensure the safe and informed operation of individual elements of the traffic stream. The design and layout of signs, signals, pavement marking and lighting should complement the basic highway design.

#### 7.2 Signing and/or Pavement Marking

The designer responsible for a signing and/or pavement marking project should be aware that the design must comply with various standards. In addition to Department Standard Specifications, the following standards should be consulted:

**Manual on Uniform Traffic Control Devices (MUTCD)** - The **MUTCD** was adopted by the Department as the uniform system of traffic control for use on the streets and highways of the State. This action was in compliance with **Chapter 316.0745** of the **Florida Statutes**. The **MUTCD** is therefore the basic guide for signing and marking. The requirements of the **MUTCD** must be met, as a minimum, on all roads in the State.

**Standard Highway Signs, FHWA** - This manual contains detailed drawings of all standard highway signs. Each sign is identified by a unique designation. Signs not included in this manual or in the **Roadway and Traffic Design Standards** must be detailed in the plans.

**Standard Specifications for Structural Supports for Highway Signs, Luminaires and Traffic Signals, AASHTO** and **Structures Design Guidelines, FDOT** - These documents provide structural design criteria.

**Roadway and Traffic Design Standards** - These standards are composed of a number of standard drawings or indexes which address specific situations which occur on a large majority of construction projects.

**Manual on Uniform Traffic Studies (MUTS)** - This is a Department publication containing documentation for several types of traffic studies. This manual provides a systematic data collection procedure for the studies described.

### 7.2.1 Design Criteria

The **MUTCD** and the **Roadway and Traffic Design Standards** should be consulted for sign location. All signs not bridge or barrier wall mounted and installed within the clear recovery zone, must be frangible or protected by an approved barrier. The **Roadside Safety** chapter of this manual contains detailed instructions on safety design.

Post sizes for single column signs are covered in the **Roadway and Traffic Design Standards**. The supports for multi-post signs are not in that reference and must be included in the plans. The designer must provide post sizes and length for each multi-post sign. The Structures Design Office has written a program for personal computers that calculates post sizes and length for multi-post signs. This program may be used for these calculations.

The design for all overhead sign structures and foundations shall be included in the plans. Refer to **Section 7.5, Foundation Design**, and **Chapter 29** for more information.

When specified, signs will be illuminated with 175 watt mercury vapor Deluxe White Lamps. The following table gives the number of luminaires for various sign widths. See **Roadway and Traffic Design Standard Index 17505** for spacing details and mounting location.

Table 7.2.1.1

Sign Width (ft)	To 10	To 21	To 32	To 43
Luminaires	1	2	3	4

### 7.2.2 Wind Loading Criteria - Signs

The wind loadings given below are based on the **AASHTO Standard Specification For Structural Supports For Highway Signs, Luminaires and Traffic Signals**. The Counties are listed by wind loading for the appropriate sign type.

### **GROUND SIGNS:**

60 mph	Alachua, Baker, Bay, Bradford, Calhoun, Clay, Columbia, Escambia, Gadsden, Gilchrist, Hamilton, Holmes, Lafayette, Lake, Leon, Liberty, Jackson, Jefferson, Madison, Marion, Okaloosa, Putnam, Santa Rosa, Sumter, Suwannee, Union, Walton, Washington
70 mph	Citrus, DeSoto, Dixie, Duval, Flagler, Franklin, Glades, Gulf, Hardee, Hendry, Hernando, Highlands, Hillsborough, Levy, Nassau, Okeechobee, Orange, Osceola, Pasco, Pinellas, Polk, Seminole, St Johns, Taylor, Wakulla
80 mph	Brevard, Charlotte, Collier, Indian River, Lee, Manatee, Martin, Palm Beach, Sarasota, St Lucie, Volusia
90 mph	Broward, Dade, Monroe

### **OVERHEAD SIGNS:**

See **Chapter 29**

### **7.2.3 No-passing Zones**

The procedures required by the Department for determining the limits of no-passing zones are contained in the ***Manual on Uniform Traffic Studies, (MUTS)***. The requirements of this manual must be followed

Limits of pavement markings for no-passing zones shall be established by one of the following methods

- 1 On projects where existing roadway conditions (vertical and horizontal alignments) are to remain unaltered by construction, the no-passing zones study shall be accomplished as part of the design phase. This will be either by in-house staff or included in design consultant contracts

The limits of the no-passing zones shall be included in the contract documents, and a note to this effect shown on the plans

- 2 On projects with new or altered vertical and horizontal alignments, limits for no-passing zones shall be established during construction. The required traffic study and field determination of limits shall be performed through the design consultant as a post design service, or as part of a district wide consultant contract for such services

When this service is included as part of post design services, sufficient time shall be included to accomplish the required field operations without delaying or interfering with the construction process

#### **7.2.4 Use of Local Street Names on Guide Signs**

The normal practice is to use route numbers on guide signs to designate roadways. In some areas, the local names for certain roadways are more familiar than the route number. For this situation, the local street name may be used. However, some roadways are known by more than one name as well as the route number. In many instances, the existing sign panel is not large enough to accommodate the street name and would require a new panel. For these reasons, the decision to use local names on guide signs must be evaluated on a case by case basis. It is recommended that the District Traffic Operations Engineer be contacted for input in these decisions.

#### **7.2.5 Signing and Marking Project Coordination**

Coordination with other offices and other agencies is a very important aspect of project design. The offices discussed in this section are not intended to be an all inclusive list with which the designer should coordinate, but are those that are typically involved in a signing and marking project.

**Roadway Design** - The designer of a signing and marking project receives the base sheets for design from the roadway designer, who can also provide any required cross sections. If the signing project is not an active roadway design project, base sheets may be obtained from existing plans.

**Utilities** - The District Utilities Engineer provides the coordination between the designer and the various utilities involved in the project. The Utilities Section can also identify potential conflicts with overhead and underground utilities or verify those which have previously been identified. The District Utilities Engineer should be contacted as early in the design phase as possible.

**Structures Design** - The Engineer of Record for Structures Design provides the design of the sign structures for overhead cantilever and overhead truss sign assemblies. This includes the design of the foundation for these structures. The Engineer of Record must be contacted early in the design phase to allow adequate time for coordination with the Geotechnical Engineer in obtaining the necessary soils information.

## 7.2.6 Foundation Criteria

Refer to **Section 7.5, Foundation Design**, for geotechnical requirements

## 7.3 Lighting

The designer responsible for a highway lighting project should be aware that the design must comply with various standards. In addition to the Department's Standard Specifications, the following standards should be consulted:

***An Information Guide for Roadway Lighting***, AASHTO -- This is the basic guide for highway lighting. It includes information on warranting conditions and design criteria.

***Standard Specifications for Structural Supports for Highway Signs, Luminaires and Traffic Signals***, AASHTO -- This specification contains the strength requirements of the poles and bracket arms for the various wind loadings in Florida as well as the frangibility requirements. All luminaire supports, poles and bracket arms must be in compliance with these specifications.

***Roadway and Traffic Design Standards*** -- These indexes are composed of a number of standard drawings or indexes which address specific situations which occur on a large majority of construction projects.

### 7.3.1 Design Criteria

The AASHTO ***Guide for Roadway Lighting*** permits either the illuminance technique or the luminance technique to be used in the design of highway lighting. The luminance technique requires a more complex design process and a knowledge of the reflective characteristics of the pavement surface used. These reflective characteristics change as the pavement ages and with variations in weather conditions. The Department has elected to use the illuminance technique for lighting design. The design values for light levels given by the AASHTO ***Guide for Roadway Lighting*** are maintained values. The light levels given in this criteria have been adjusted and are listed as average initial lux. This, in effect, sets the maintenance factor to be used in the calculation process to a value of 1.

Mounting height (M H) for conventional lighting is the vertical distance from the roadway to the light source, regardless of lateral placement of the pole. Pole setback is the horizontal distance from the edge of the travel lane to the pole.

Refer to **Chapter 29** for more information.

### 7.3.2 Pole Design Criteria

**Chapter 2** specifies the minimum horizontal clearances for light poles. High mast lighting poles should not be located in gore areas within the runout length as defined in the **AASHTO Roadside Design Guide**. Engineering judgement should be used when locating high mast poles adjacent to bridges and high fills. All conventional height poles shall be frangible unless bridge or barrier wall mounted.

Frangible pole installations shall not be used in areas of heavy pedestrian traffic where the hazard of a falling pole is a greater hazard to others than it is to the motorist. See **Roadway and Traffic Design Standards** for frangibility requirements.

The installation of lighting in certain locations (e.g. adjacent to residential areas) may require the luminaires to be shielded. This is especially true for high mast poles.

Poles on bridges over open bodies of water or on causeway sections should be considered for dampers. These poles are subject to sustained winds of a critical velocity which may induce vibrations in the pole.

### 7.3.3 Foundations Criteria

Refer to **Section 7.5, Foundation Design**, for geotechnical requirements and **Chapter 29** for additional design information.

### 7.3.4 Wind Loading Criteria - Lighting

See **Chapter 29**.

### 7.3.5 Lighting Project Coordination

Coordination with other offices and other agencies is a very important aspect of project design. The offices discussed in this section are not intended to be an all inclusive list with which the designer should coordinate, instead it includes offices that are normally involved in projects.

**Roadway Design** - Normally the designer of a lighting project receives the base sheets for lighting design from the roadway designer. The roadway designer can also provide any required cross sections. If the lighting project is not an active roadway design project, base sheets may be obtained from existing plans.

**Utilities** - The District Utilities Engineer provides the coordination between the designer and the various utilities involved in the project. This usually is limited to agreements with the power company for electrical service. The Utilities Section can also identify potential conflicts with overhead and underground utilities or verify those which have previously been identified.

The Utilities Engineer should be contacted as soon as pole locations are set and the electrical load has been determined. The designer should indicate a preferred location for the electrical service.

**Drainage** - When the locations of high mast poles are established, they should be checked with the Drainage Section to determine if high water level is a problem. High mast poles are often located in the center of interchange loops. These same areas may be used as drainage retention areas. Coordination with the Drainage Section will alleviate this type problem.

**Structures Design** - Conventional height poles require the standard base shown in the Roadway and Traffic Design Standards and Standard Specifications. A foundation design is only required in special cases. High mast poles, on the other hand, require foundation designs for each location. Soil bores are required for this design. The Engineer of Record for Structures Design provides the foundation design for high mast poles. He must be contacted early in the design phase to allow adequate time for coordination with the Geotechnical Engineer in obtaining necessary soils information.

**Chapter 14- 64 of the Department Rules** established the maintenance responsibility of lighting systems not on limited access or toll facilities as a local government function.

Normally the District Traffic Operations Engineer in conjunction with the District Utilities Engineer obtains the required maintenance agreements. The designer should coordinate with these offices to ensure that this activity is either underway or scheduled.

Any lighting project, especially high mast, adjacent to or in the vicinity of an airport, may be a potential problem. Any lighting project within 3 miles of an airport should be discussed with the Office of Public Transportation, Aviation Office to determine if a problem exists.

### **7.3.6 Voltage Drop Criteria**

When determining conductor sizes for lighting circuits, the maximum allowable voltage drop from the service point on any one circuit is 7%.

## **7.4 Traffic Signals**

The designer responsible for a traffic signal project should be aware that the design must

comply with various standards. In addition to the Department's Standard Specifications, the following standards should be consulted:

**Manual on Uniform Traffic Control Devices (MUTCD), FHWA** - The **MUTCD** was adopted by the Department as the uniform system of traffic control for use on the streets and highways of the State. The action was in compliance with **Chapter 316.0745** of the **Florida Statutes**. The **MUTCD** is therefore the basic guide for traffic signals. The requirements of the **MUTCD** must be met, as a minimum, on all roads in the State.

**Standard Specifications for Structural Supports for Highway Signs, Luminaires and Traffic Signals AASHTO** and **Chapter 29** of this manual - These documents provide structural design criteria.

**Roadway and Traffic Design Standards** - These standards are composed of a number of standard drawings or indexes which address specific situations which occur on a large majority of constructions.

#### 7.4.1 Design Criteria

The design of traffic signal mast arms and foundations shall be included in the plans. Refer to **Section 7.5, Foundation Design**, and **Chapter 29** for more information.

The **MUTCD**, as noted above, has been adopted as the uniform system of traffic control for use on the streets and highways of the state. The **MUTCD** is the basic guide for traffic signal design, therefore, the traffic signal designer should be familiar with this document. The criteria below supplement the **MUTCD**.

#### 7.4.2 Certification and Specialty Items

Traffic signal equipment installed in Florida is required to be certified by the Department. The Office of Traffic Engineering in the Central Office is charged with the responsibility of certifying traffic control equipment. The designer of a traffic signal project, if requiring new equipment types or types not normally used, should contact Traffic Engineering in Tallahassee to determine the certification status of the equipment. Non-certified equipment cannot be used.

Standard specifications have not been developed for all signal equipment. Some items are project dependent and the development of standard specifications is difficult. Specifications for these items must be developed on a project by project basis and included in the contract as a special provision. Some of these specialty items are included on the Department's approved products list. For these items, detailed specifications are not required. The Office of Traffic Engineering should be consulted on these items.



### 7.4.3 Stop Line Location

A stop line which is not properly located invites violation by the motorist. The **MUTCD** specifies the minimum and maximum distances from the signal head to the stop line for adequate visibility. The traffic signal designer must insure that this requirement is met.

Instead of relocating the signal heads, the stop lines at many intersections have been moved from their proper location to comply with these requirements. The tendency for the motorist is not to stop at the new stop line location, but rather to creep beyond the stop line. This could in some cases result in valid calls being dropped, thereby increasing delay and decreasing the overall efficiency of the intersection.

The first step in the design process should be to locate crosswalks and stop lines properly. Then the signal head location should be determined to meet the **MUTCD** requirements. This may require changing the mounting configuration. A box span, for example, may be required where a diagonal span would normally be installed.

### 7.4.4 Controller Assemblies

**Controller Timings:** The development of controller timings is a basic part of traffic signal design. A recent ruling from the Board of Professional Engineers stated that the development of timings is considered engineering and therefore requires the signature and seal of a professional engineer.

All traffic signal designs prepared for or by the Department shall include initial timings of all controllers. This is also true for signals to be included in local systems. If the timings in the plans are not implemented, it will be the responsibility of the agency providing the timings to insure they were prepared under the supervision of a professional engineer.

**Future Intersection Expansion:** Any planned intersection improvements, should be considered in the signal design. The controller type, cabinet type and the number of load switches are examples of design features which may be affected by future intersection improvements. It is the responsibility of the signal design engineer to determine if the current design should include capabilities for future improvements.

**Upgrade of Existing Controller Assemblies:** For projects requiring an upgrade to an existing controller assembly, the assembly may either be expanded or replaced. Minor expansions include the addition of load switches, new controller timings, and/or new controller unit if the cabinet is properly wired. These may be made in the field, therefore, expansion is the logical choice. On the other hand, major expansions include cabinet rewiring or any work requiring the removal of the cabinet back panel.

Major expansions shall not be made in the field and replacement of the assembly is required. The designer may wish to contact the District Traffic Operations Engineer before making the decision to expand or replace an existing controller assembly.

#### 7.4.5 Left Turn Treatments

The guidelines given below should be followed when determining signal treatments for left turns.

- **Single Turn Lane**

**Restrictive/Permissive Phasing** - A five-section cluster should be used for this location. The head should be installed over the lane line between the left turn lane and through lane. The five-section cluster can serve as one of the two indications required for the through traffic.

**Restrictive Phasing** - A separate signal head for the left turn lane with red, yellow and green arrow indications should be positioned over the center of the left turn lane.

- **Dual Turn Lanes**

Only restrictive phasing should be used. Permissive movements should not be allowed for dual turn lanes. A single three-section head with red, yellow, and green arrow indications should be centered over each turn lane. These heads are in addition to the dual indications required for the thru movement.

- **Separated Turn and Thru Lanes**

Turn lanes that are separated from the thru lanes more than 12 ft by a raised or painted island shall not be operated in the permissive mode.

- **Single Lane Approach on Stem of "T"**

Two three-section heads are required as minimum. All indications must be circular in this situation.

- **Two Approach Lanes on Stem of "T"**

**Option #1** The approach may display two three-section heads with circular indications on all sections.

**Option #2** The approach may display a five-section cluster in conjunction with a three-section head. If the lanes are exclusive left and right turn lanes, then the five-section cluster should be placed over the center of the lane line and the three-section head over the major movement lane. If one of the lanes is a shared left and right lane, then the five-section cluster should be placed over the center

of this lane and the three-section head over the center of the other lane

**Option #3:** The approach may display two three-section heads for the major movement and a single three-section head for the secondary movement

- **Three Approach lanes on Stem of "T"**

**Option #1** The approach may display two three-section heads for the major movement and one for the secondary movement (Exclusive left and right turn lanes)

**Option #2:** The approach may display a five-section cluster in conjunction with three-section head (exclusive left and right turn lanes) The five-section cluster should be placed over the center of the lane line separating the left turn lane(s) from the right turn lane(s) The three-section head should be placed over the other lane line to provide dual indication for the major movement

**Option #3:** When the middle lane is a shared left and right turn lane, then a five-section cluster should be placed over the center of this lane and a three-section head placed over each of the other two lanes Each head must contain green and yellow arrow indications in this situation

**NOTE:**

- 1 For all cases, the approach shall display "dual indications" This means that there must be at least two heads with identical indications on the major approach For example, if a green arrow is displayed on one head of the major movement or approach then a green arrow must be displayed on the second head
- 2 The same signal display option should be used throughout an urban area to provide consistency in display to the motorist
- 3 The use of advance and/or overhead lane use signs should be used as a supplement to pavement arrows on stems of signalized "T" intersections

### 7.4.6 Signal Preemption

The engineer responsible for the design of a traffic signal project should, as a matter of routine, check each intersection to determine if the need for signal preemption is present

Intersections located within 500 ft of moveable span bridges or railroad crossings should be considered for preemption Those located at distances greater than 500 ft should also be considered if the queues frequently extend to the moveable span or crossing

Intersections near fire stations require individual study This is necessary to determine the interaction between the fire station vehicles and the intersection operation This information

must be known before the preemption sequence can be developed

### 7.4.7 Intersection Design - Lane Configuration

The engineer responsible for the traffic signal design may be asked to verify the number and configuration of traffic lanes required for an intersection to function properly when signalized

The results are dependent upon the traffic volumes used in the analysis. The traffic used for this calculation shall be the design hourly volume based on the 30th highest hour (k factor) and not a peak to daily (P/D) ratio based on a 24 hour count. The k factor volumes account for traffic variations through the year, and, in most cases, are higher than P/D volumes.

The K, D, and T factors convert the two-way AADT volumes to a one-way Design Hourly Volume (DHV). This is appropriate for the total approach movements. The AM and PM peak turning movement counts on each approach should be addressed individually. Current turning movement counts should be taken to determine the percentage of turns for each approach. These percentages should then be applied to the DHV for each approach volume to determine the turning volumes which should be used for the turn lane design calculations. These values should be compared to the movement counts supplied by Planning and the greater of the two values used for the design of turn lanes. The District Planning Office should be contacted to determine if recent counts are available and also if any use changes are planned which would require adjustments to the turn percentages found in the current counts.

Storage lanes for left turns can affect the capacity and safety of intersections. The storage length of a left turn lane is a critical design element. The queue of left turn vehicles in a storage lane of inadequate length may extend into the through lanes. The result is loss of capacity for the through lanes. The queue of through vehicles may also extend beyond the entrance of a short left turn storage lane, blocking access to the storage lane. Either case results in a less efficient operation of the intersection and may cause last minute lane changes, thereby increasing the possibility of conflicts.

Turn lanes should comply with ***Roadway and Traffic Design Standards, Index 301*** to the extent practical. The available queue length provided should be based on a traffic study.

The important factors which determine the length needed for a left turn storage lane are

- The design year volume for the peak hour (see discussion above)
- An estimate for the number of cycles per hour

NOTE: If the cycle length increases, the length of the storage for the same traffic

also increases

- The signal phasing and timing

There are several techniques used to determine necessary storage length. The following are suggested guidelines for left turn lanes:

- Where protected left turn phasing is provided, an exclusive turn lane should be provided
- Left turn lanes should be provided when turn volumes exceed 100 vehicles per hour (VPH) and may be considered for lesser volumes if space permits
- For signalized intersections, the following formula may be used, assuming an average vehicle length of 25 feet

$$Q = \frac{(20)(DHV)(25)}{N}$$

Where

Q = design length for left turn storage in ft

DHV = left turn volume during design peak hour, in VPH

N = number of cycles per hour for peak hour, use N = 30 as default

Computer programs, such as TRANSYT-7F, are used to develop signal phasing and timing. One of the outputs of these programs is the queue length. For projects where traffic signal timing is included as a part of the project, the output of these programs should be considered in determining storage length.

- Where left turn volumes exceed 300 vph, a double left turn should be considered
- When right of way has already been purchased, and the designer has to choose between a long wide grass median or a long left turn lane, the storage length for the left turn should be as long as practical without hindering other access

Right turn lanes are provided for many of the same reasons as left turn lanes. Right turns are, however, generally made more efficiently than left turns. Right turn storage lanes should be considered when right turn volume exceeds 300 vph and the adjacent through volume also exceeds 300 vehicles per hour per lane (vphpl).

#### 7.4.8 Signal Loops

Traffic signal loops are detailed in *Roadway and Traffic Design Standards, Index 17781*. These loops are standard and will be appropriate for most locations.

The traffic signals for each intersection should be individually designed. The requirement

for type and placement of loops is a part of this design. The above standard allows for some variation in size and placement of the standard loops. These modifications are intended to be used only when required by the design of a particular location.

#### **7.4.9 Electrical Bonding**

**Roadway and Traffic Design Standards, Index 17736** requires a bond wire connecting all poles, controllers, mast arms and pedestrian signal pedestals. The designer is reminded that this conductor must be included in the pay items and quantities.

#### **7.4.10 Wind Loading - Traffic Signals**

See **Chapter 29**.

#### **7.4.11 Foundation Criteria**

Refer to **Section 7.5, Foundation Design**, for geotechnical requirements.

#### **7.4.12 Mast Arm Supports**

The Department's **Mast Arm Signal Support Policy Statement (Topic No. 000-625-020)** states that all new signals installed on the State Highway System that are within the approximate ten mile coastline boundary defined by the State Traffic Engineering Office Implementation Guidelines shall be supported by mast arms with the signal head(s) rigidly attached to the mast arm.

The designer should be familiar with this policy statement. Deviations to this Policy are to be handled as Variations in accordance with **Chapter 23** of this manual.

#### **7.4.13 Traffic Signal Project Coordination**

Coordination with other offices and other agencies is a very important aspect of project design. The offices discussed in this section are not intended to be an all inclusive list with which the designer should coordinate, instead it includes offices that are normally involved in projects.

**Roadway Design** - Normally the designer of a signal project receives the base sheets for design from the roadway designer. The roadway designer can also provide any required cross sections. If the signal project is not an active roadway design project, base sheets may be obtained from existing plans.

**Utilities** - The District Utilities Engineer provides the coordination between the designer and the various utilities involved in the project. This usually is limited to agreements with the power company for electrical service. The Utilities Section can also identify potential conflicts with overhead and underground utilities or verify those which have previously been identified.

The Utilities Engineer should be contacted early in the design phase. The designer should indicate a preferred location for the electrical service.

**Structures Design** - The Engineer of Record for Structures Design provides the design of the traffic signal mast arms and strain poles. This includes the design of the foundation for these structures. The Engineer of Record must be contacted early in the design phase to allow adequate time for coordination with the Geotechnical Engineer in obtaining the necessary soils information.

**Pedestrian Coordinator** - The pedestrian coordinator should be consulted to be sure that all of the pedestrian concerns have been fully addressed.

## 7.5 Foundation Design

Foundation design and drawings for overhead sign structures, high mast light poles, traffic signal mast arms and strain poles shall be the responsibility of the Structures Engineer of Record (EOR). The Geotechnical Engineer shall provide the EOR the following soils information (this information may be derived from the borings of other nearby structures or from roadway borings)

- 1 Soil Type
- 2 Effective Unit Weight of the Soil
- 3 Seasonal High Water Table Elevation
- 4 Effective Friction Angle of the Soil (if applicable)
- 5 Cohesion Value (if applicable)
- 6 Allowable Bearing Capacity (if applicable)

The above soils information shall be included in the plans. Additionally, Soil Boring Data Sheets shall be included in the plans, except for strain poles. This will provide the Contractor with the conditions for which the foundations were designed as compared to actual on-site conditions and establish criteria for any future analysis of the foundations.

For Roadway Lighting Foundations refer to ***Roadway and Traffic Design Standards, Index 17503*** Additionally, for projects allowing the screw type foundation as an alternate, the Geotechnical Engineer shall determine whether the soil characteristics meet the requirements of **Section 715** of the **Specifications** If it is determined that the soil conditions do not allow the use of the screw type foundation as shown in **Section 715**, an appropriate design shall be provided or a note shall be added to the plans station "Use of the screw type foundation is not allowed on this project "



## Chapter 8

### PEDESTRIAN AND BICYCLE FACILITIES

8.1 General . . . . .	8-1
8.2 References . . . . .	8-1
8.3 Pedestrian Facilities . . . . .	8-2
8.3.1 Sidewalks . . . . .	8-2
8.3.2 Disability Considerations . . . . .	8-3
8.3.3 Pedestrian Railings . . . . .	8-3
8.4 Bicycle Facilities . . . . .	8-3
8.4.1 Bicycle Lanes (Designated) . . . . .	8-4
8.4.2 Bicycle Lanes (Undesignated) . . . . .	8-4
8.4.3 Bicycle Route System . . . . .	8-5
8.4.4 Bicycle Railings . . . . .	8-5
8.5 Drainage and Utility Considerations . . . . .	8-5
8.6 Bridges, Overpasses and Underpasses . . . . .	8-5
8.7 Shared Use Paths . . . . .	8-6
8.8 Florida Intrastate Highway System . . . . .	8-7
Figure 8.1 Pedestrian Bridge Typical Section . . . . .	8-8

## Chapter 8

### PEDESTRIAN AND BICYCLE FACILITIES

#### 8.1 General

It is the goal of the Department and in accordance with **Section 335.065(1)(a), Florida Statutes**, that "Bicycle and pedestrian ways shall be given full consideration in the planning and development of transportation facilities, including the incorporation of such ways into state, regional, and local transportation plans and programs. Bicycle and pedestrian ways shall be established in conjunction with construction, reconstruction, or other change of any state transportation facility, and special emphasis shall be given to projects within 1 mile of an urban area."

Pedestrian and bicycle facilities must be given full consideration on all proposed projects including Resurfacing, Restoration and Rehabilitation (RRR), safety, and traffic operation projects. Their inclusion on intersection reconstruction projects is particularly important as these may be excepted out of later roadway projects. Where an existing route for bicyclists is present it shall be maintained. Decisions on appropriate pedestrian and bicycle facilities shall be determined with input from the District Pedestrian/Bicycle Coordinators and District Americans with Disabilities Act (ADA) Coordinators. Exceptions must be fully supported and documented in the project records.

#### 8.2 References

***Manual on Uniform Traffic Control Devices (MUTCD)***  
***Roadway and Traffic Design Standards***  
***FDOT Pedestrian Planning and Design Handbook***  
***FDOT Bicycle Facilities Planning and Design Handbook***  
***FDOT Trail Intersection Design Handbook***  
***AASHTO Guide for Bicycle Facilities***  
***Highway Capacity Manual***  
***Americans With Disabilities Act (ADA)/Florida Accessibility Code for Building Construction (FACBC)***  
***Uniform Vehicle Code(UVC)***  
***AASHTO Guide Specifications for Design of Pedestrian Bridges***

## 8.3 Pedestrian Facilities

All roadways and bridges where pedestrian travel is expected should have separate walking areas such as sidewalks or shared use paths that are outside the vehicle travel lanes. Refer to **Section 8.7** for shared use paths.

### 8.3.1 Sidewalks

Sidewalks are walkways parallel to the roadway and designed for use by pedestrians. As a general practice, sidewalks should be constructed along both sides of arterial roadways that are not provided with shoulders, even though pedestrian traffic may be light. Exceptions may be made to the construction of sidewalks on both sides of the street when the roadway parallels a railroad or drainage canal and pedestrians would not be expected. If sidewalks are constructed on the approaches to bridges, they should be continued across the structure. If continuous sidewalks are constructed on only one side of the street, pedestrians should be provided access to transit facilities located on the opposite side of the street.

The minimum width of a sidewalk shall be 5 ft when separated from the curb by a buffer strip. The minimum separation for a 5 ft sidewalk from the back of curb is 2 ft. The buffer strip should be 6 ft where possible to eliminate the need to narrow or reroute sidewalks around driveways. If the sidewalk is located adjacent to the curb the minimum width of sidewalk is 6 ft. Grades on sidewalks should not exceed 5% when not adjacent to a travel way. There should be enough sidewalk cross slope to allow for adequate drainage, however the maximum shall be no more than 2% to comply with ADA requirements.

Particular attention should be given to pedestrian accommodations at the termini of each project. If full accommodations cannot be provided due to the limited scope or an existing sidewalk isn't present at the termini, then temporary measures should be considered such as extend sidewalk and project limits to next appropriate pedestrian crossing or access point. If special accommodations are made, it is equally important to address these measures on the adjoining projects. In all cases, the District Pedestrian Coordinator should be contacted to make a determination regarding continuous passage.

On roadways with flush shoulders, the minimum width of sidewalk is 5 ft.

On existing roadways with flush shoulders, sidewalks or pedestrian pathways should be placed as far from the roadway as practical in the following sequence of desirability:

- Outside of the highway right-of-way in a separate, offsite and/or parallel facility

- At or near the right-of-way line
- Outside of the clear zone
- As far from edge of driving lane as practical

For new roadway construction with flush shoulders, the sidewalk should be outside of the clear zone

### **8.3.2 Disability Considerations**

Pedestrian facilities must be designed in accordance with ADA to accommodate the physically and visually challenged citizens whose mobility is dependent on wheelchairs and other devices. In areas with sidewalks, curb ramps shall be incorporated at locations where a marked crosswalk adjoins the sidewalk. *Index No. 304* of the *Roadway and Traffic Design Standards* sets forth requirements.

To assist pedestrians who are visually or mobility impaired, curb ramps should be parallel to the crossing. By providing ramps parallel to the crossing, the pedestrian is directed into the crossing. At intersections where more than one road is crossed, each crossing should have a separate curb ramp. Under no circumstance should a curb ramp be installed allowing a pedestrian to enter a crossing without providing a curb cut (or at grade sidewalk if no curb is present) on the opposite side of the crossing.

### **8.3.3 Pedestrian Railings**

Handrails or fences shall be provided for vertical dropoffs exceeding 10". The pipe handrail shown in *Index 520* is suitable for dropoffs up to 30". For vertical dropoffs greater than 30", a handrail design conforming to ADA requirements and AASHTO pedestrian rail requirements shall be provided.

## **8.4 Bicycle Facilities**

The bicycle has become an important element for consideration in the highway design process. The emphasis in bicycle planning has changed from the attempts to provide completely separate facilities for bicyclists, to the growing recognition that bicyclists are legitimate users of the roadway. Appropriately designed and located bicycle facilities play an important role in encouraging safe bicycle travel. Bicycle facility needs include bicycle

lanes, route systems, and separate paths with the appropriate signs, control devices, parking facilities, etc. Measures that can considerably enhance a route's safety and capacity for bicycle traffic are

- 1 Paved shoulders, either designated or undesignated as bike lanes
- 2 Wider outside lanes (if no shoulders)
- 3 Bicycle-safe drainage grates
- 4 Manhole covers flush with grade
- 5 Maintaining a smooth, clean riding surface
- 6 Bicycle corridors on off-system routes

#### **8.4.1 Bicycle Lanes (Designated)**

A bicycle lane is a portion of the roadway designated by striping, signing and/or pavement markings for the exclusive use of bicyclists

Under ideal conditions, the minimum bicycle lane width is 4 ft. However, on an urban curbed street where a parking lane is provided the minimum bicycle lane width is 5 ft.

Designated bicycle lanes are to be marked with signs and pavement markings. Standard FDOT striping is shown in the *Roadway and Traffic Design Standards*. Designated lane signs shall be used in accordance to the *MUTCD*.

See **Chapter 2** for shoulder width criteria when bicycle use is anticipated.

Wide curb lanes no longer meet FDOT requirements. In some conditions, such as RRR projects, they may be the only practical option. If possible, on existing multi-lane facilities without bicycle lanes, and if truck volumes are low, consideration should be given to reducing vehicle lane width to 11 ft and providing a bicycle lane. Bicycle lanes can be provided by widening existing roadways, paving shoulder areas, eliminating parking, or using emergency lanes normally provided for disabled vehicles.

#### **8.4.2 Bicycle Lanes (Undesignated)**

An undesignated bicycle lane is the same as a designated bicycle lane except the signing and preferential lane symbols (pavement messages) are not included.

### **8.4.3 Bicycle Route Systems**

Bicycle route systems are linked by signs to aid bicyclists. Bicycle route systems are ineffectual unless signs are highly specific, giving a clear indication of destination. It may be advantageous to sign some urban and rural roadways as bicycle route system. Bicycle route signing should not end at a barrier. Information directing the bicyclists around the barrier should be provided.

The decision whether to provide bicycle route systems should be based on the advisability of encouraging bicycle use on a particular road, instead of on parallel and adjacent highways. The roadway width, along with factors such as volume, speed, types of traffic, parking conditions, grade and sight distance, should be considered when determining the feasibility of bicycle route systems. Roadway improvements such as adequate pavement width, drainage grates, railroad crossings, pavement surface, maintenance schedules and signals responsive to bicycles should always be considered before a roadway is identified as a bicycle route system. Further guidance on signing bicycle route systems is provided in the *MUTCD*.

### **8.4.4 Bicycle Railings**

Handrails or fences shall be provided for vertical dropoffs exceeding 10". The pipe handrail shown in *Index 520* is suitable for dropoffs up to 30". For dropoffs greater than 30", a handrail design conforming to ADA requirements and AASHTO bicycle rail requirements shall be provided.

## **8.5 Drainage and Utility Considerations**

Drainage inlets, grates and utility covers are potential problems to bicyclists. When a new roadway is designed, all such grates and covers should be kept out of the bicyclists' expected path. Refer to *Roadway and Traffic Design Standards* for required grates and inlet tops.

See **Chapter 2** for horizontal clearances for light poles.

## **8.6 Bridges, Overpasses and Underpasses**

A bridge, an overpass, or an underpass may be necessary to provide pedestrian/bicycle continuity to shared use paths.

Overpasses and bridges for shared use paths should be covered or screened to reduce

the likelihood of objects being dropped or thrown onto the roadway below See **Figure 8.1** for typical detail The overpass or bridge design shall be in accordance with the criteria established below

- 1 **AASHTO Guide Specifications for Design of Pedestrian Bridges**
- 2 For vertical clearances see **Chapter 2, Table 2.10.1**
- 3 The minimum walkway width on a pedestrian overpass is 8 ft On new structures, the minimum clear width should be the same as the approach trail width The desirable clear width should include the minimum 2 ft wide clear area on each side
- 4 Chain link (enclosed type) should be provided across the entire walkway Use of chain link fence on ramps of the pedestrian bridges will be determined on a project by project basis
- 5 Pedestrian ramps should be provided at all pedestrian separation structures When possible, a stairway can be provided in addition to a ramp Maximum grade of ramps shall be 8 33% Intermediate level platforms 5 ft long shall be provided at maximum 30 ft intervals Additionally, a level platform 5 ft long at the top and 6 ft long at the bottom shall be provided
- 6 Provide full-length pedestrian handrails on both sides of the ramp

Pedestrian underpasses are generally undesirable, however, if one is required, the geometrics and lighting requirements should be discussed with the FDOT Project Manager and the District Pedestrian/Bicycle Coordinator Local law enforcement personnel may need to be consulted to assure public safety, emergency accessibility and other desirable features

## **8.7 Shared Use Paths**

These off-the-roadway paths are heavily used and should be designed to accommodate increasing volumes of users, including the occasional maintenance vehicle Shared use paths can be expected to attract people of all ages, from very young children to the very elderly, to the physically challenged Typical path users may include bicyclists, walkers, runners, rollerbladers, skateboarders, wheelchair users, baby strollers, dog walkers , etc Shared use paths can be one-way or two-way paths

The minimum width of a one-directional shared use path is 5 ft and in most cases the path will be used as a two-way facility unless effective measures are taken to assure one-way operation Without such design and enforcement, the designer should assume the path will be used as two-way and design accordingly Under most conditions the minimum recommended width for a two-directional multi-use path is 12 ft

The minimum horizontal clearance of 4 ft from nearest edge of path is desirable to provide distance from trees, poles, walls, fences, guardrails, or other lateral obstructions. A 2 ft width graded area should be maintained adjacent to both sides of the path. Edge drop-offs should be eliminated. Handrails or fences shall be provided for vertical dropoffs exceeding 10". The pipe handrail shown in *Index 520* is suitable for dropoffs up to 30". For vertical dropoffs greater than 30", a handrail design conforming to ADA requirements and AASHTO pedestrian/bicycle rail requirements shall be provided.

The minimum vertical clearance to obstructions should be 8 ft. However, vertical clearance may need to be greater to permit passage of maintenance vehicles and in underpasses and tunnels, a clearance of 10 ft is desirable.

A wide separation between a shared use path and adjacent highway is desirable to confirm to both the bicyclists and motorists that the path functions as an independent way for bicycles. When this separation is not possible and the distance between the edge of roadway and trail is less than 5 ft, a suitable physical divider may be considered. Where used, dividers should be a minimum of 4.5 ft high to prevent bicyclists from toppling over it.

Grades should be kept to a minimum. Grades greater than 5% are undesirable. Grades can be increased to 6% for bridges where wide trail widths are provided and which permit adequate recovery before an intersection or other conflict point.

Lighting for shared use paths is important and should be considered where use at night is expected, and at highway intersections. Lighting should also be considered through underpasses or tunnels.

## 8.8 Florida Intrastate Highway System

The Department procedure, *Development of the Florida Intrastate Highway System (FIHS)(Topic No. 525-030-250)*, gives the following guidance relating to the provisions of bicycle and pedestrian facilities on the FIHS:

"Bicycle and pedestrian facilities shall not be provided on FIHS limited access roadways. For FIHS controlled access facilities, the safe movement of bicycles and pedestrians must be carefully considered and accommodated in such a way as to have no adverse impact to safety, capacity or speed. Separate, offsite, and/or parallel facilities, shall be used where practical and feasible. Bicycle facilities shall be consistent with the requirements of the *Florida Bicycle Facilities Planning and Design Handbook*."



**Figure 8-1 Pedestrian Bridge Typical Section**

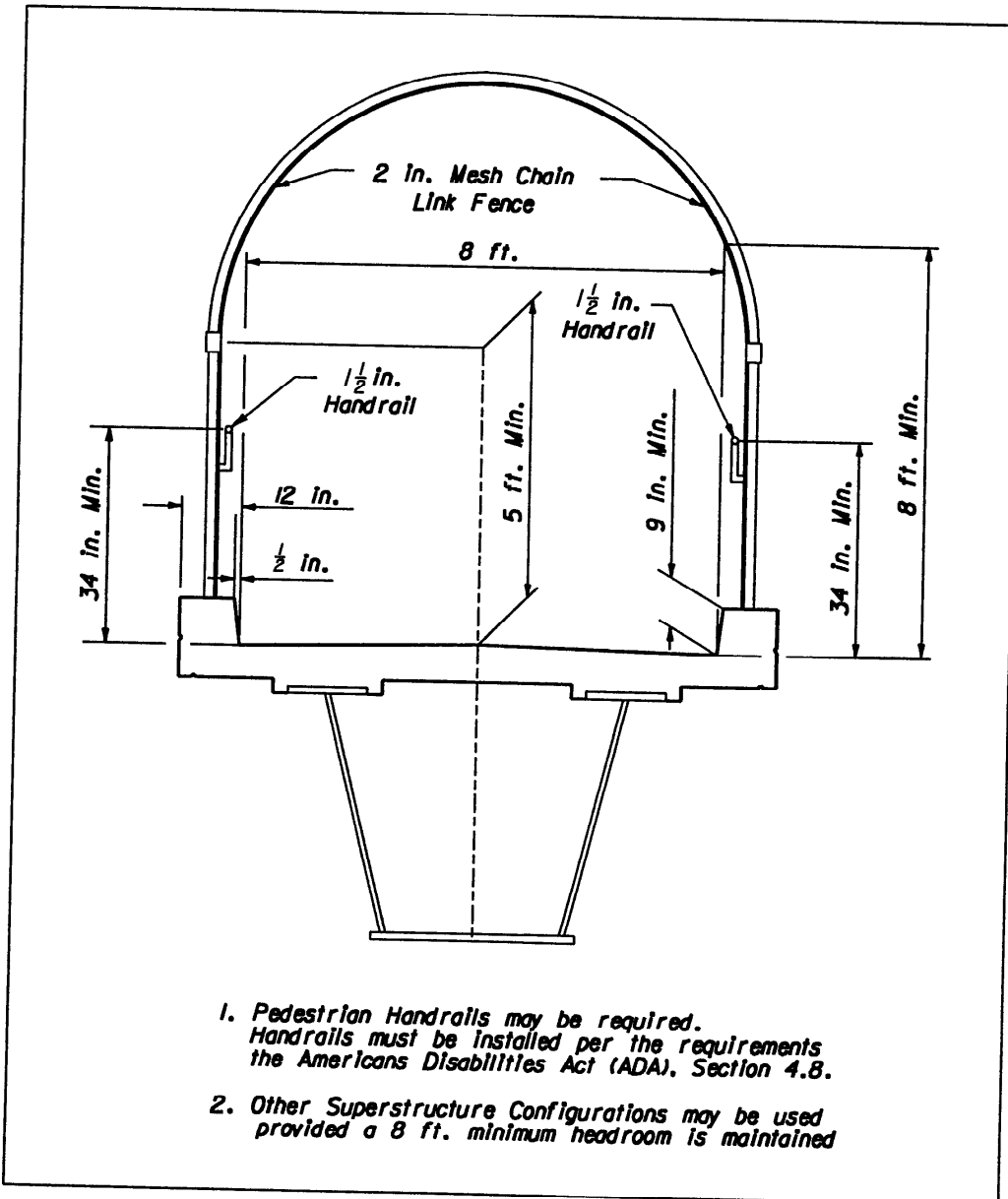

## **Chapter 9**

# **LANDSCAPING**

9.1 General ..... 9-1

## Chapter 9

### LANDSCAPING

#### 9.1 General

The complete highway is one wherein the elements of design, construction and maintenance have been integrated to provide a facility that possesses utility, safety, beauty and economy. The highway should be considered as an element of the total environment, not apart from it or in conflict with it. All highway-oriented disciplines should collaborate at each stage of highway corridor selection, location, and design to obtain the maximum beneficial potential of the highway, its roadsides, and its environment.

The highway roadside is an integral unit of a total highway facility. The term "roadside" generally refers to the area between the outer edge of the roadway and the right-of-way boundary. It could include extensive areas in a wide median of a divided highway. Roadside development is the treatment given to the roadside to conserve, enhance, and effectively display the natural beauty of the landscape through which the highway passes. It should provide safety, utility, economy, and highway-related recreation facilities by means of proper location, design, construction, and maintenance.

Because the potential for conflict between the highway and environmental values is greatest in urban areas, it is essential that special attention be given to the multiple use-joint development possibilities in areas over, under, and adjacent to the highway to ensure that land and space above the highway provides the greatest benefit to the greatest number.

Landscape development should be in keeping with the character of the highway and its environment. Programs include the following general areas of improvement:

- Preservation of existing vegetation
- Transplanting of existing vegetation where feasible
- Planting of new vegetation
- Selective clearing and thinning
- Regeneration of natural plant species and material

The objectives in planting or the retention and preservation of natural growth on roadsides are closely related. In essence, they are to provide vegetation that will be an aid to esthetics and safety, aid in lowering construction and maintenance costs, and create interest, usefulness, and beauty for the pleasure and satisfaction of the traveling public.

Landscaping of urban highways and streets assumes additional importance by mitigating many of the nuisances associated with urban traffic. Landscaping should be arranged to permit sufficiently wide, clear, and safe pedestrian walkways. Combinations of turf, shrubs, and trees are desirable in border areas along the roadway. However, care should be exercised to ensure that requirements for sight distances and clearance to obstructions are observed, especially at intersections.

Further information concerning landscape development and erosion control is presented in **AASHTO's A Guide for Highway Landscape and Environmental Design**. The Department's **Roadway and Traffic Design Standards Booklet** sets forth specific criteria and standards for erosion control and roadside landscaping. The Department's **Landscaping Guidelines (Topic No. 650-050-001)** provides the general criteria for use in the development of landscaping plans for roadway projects.

## **Chapter 10**

### **WORK ZONE TRAFFIC CONTROL**

10.1	General .. .. .	10-1
10.2	References .. .	10-1
10.3	Comprehensive Work Zone Traffic Control Planning .....	10-1
10.4	Traffic Control Plans (TCP) . . . . .	10-2
10.5	TCP Development . . . . .	10-4
10.6	Coordination .....	10-6
10.6.1	Phase Submittals . . . . .	10-7
10.7	Work Zone Traffic Control Training .....	10-7
10.7.1	Background .. .	10-7
10.7.2	Training Requirements .....	10-7
10.8	Traffic Control Devices .....	10-8
10.9	Signs . . . . .	10-8
10.9.1	Advance Warning Signs .....	10-8
10.9.2	Length of Construction Sign .....	10-9
10.9.3	Existing Signs .. .	10-9
10.10	Lighting Units .....	10-9
10.10.1	Warning Lights .....	10-9
10.10.2	Advance Warning Arrow Panels .....	10-10
10.10.3	Variable Message Signs .....	10-10
10.10.4	Traffic Signals . . . . .	10-12

---

10.11	Channelizing Devices . . . . .	10-16
10.11.1	Type III Barricades . . . . .	10-16
10.11.2	Separation Devices . . . . .	10-16
10.11.3	Channelizing Device Alternates . . . . .	10-16
10.12	Pavement Markings . . . . .	10-16
10.12.1	Removing Pavement Markings . . . . .	10-16
10.12.2	Reflectorized Raised Pavement Marker (RPM) . . . . .	10-16
10.12.3	Work Zone Markings . . . . .	10-16
10.13	Safety Appurtenances for Work Zones . . . . .	10-17
10.13.1	Traffic Barriers . . . . .	10-17
10.13.2	Portable Concrete Safety Shape (Temporary Barrier Walls) . . . . .	10-17
10.13.3	End Treatments . . . . .	10-18
10.13.4	Modifications of Existing Barriers . . . . .	10-18
10.13.5	Crash Cushions . . . . .	10-18
10.13.6	Temporary Curb . . . . .	10-18
10.14	Traffic Control Plan Details . . . . .	10-19
10.14.1	Taper Lengths . . . . .	10-19
10.14.2	Intersecting Road Signing and Signals . . . . .	10-20
10.14.3	Sight Distance To Delineation Devices . . . . .	10-20
10.14.4	Pedestrians and Bicyclists . . . . .	10-20
10.14.4.1	Pedestrian Considerations . . . . .	10-20
10.14.4.2	Bicycle Considerations . . . . .	10-21
10.14.5	Superelevation . . . . .	10-21
10.14.6	Lane Widths . . . . .	10-22
10.14.7	Lane Closure Analysis . . . . .	10-22
10.14.8	Detours, Diversions, & Lane Shifts . . . . .	10-34
10.14.9	Above Ground Hazards . . . . .	10-34
10.14.10	Drop-offs in Work Zones . . . . .	10-34
10.14.11	Narrow Bridges and Roadways . . . . .	10-35
10.14.12	Existing Highway Lighting . . . . .	10-35
10.14.13	Work Area Access . . . . .	10-35

10.14.14	Railroads . . . . .	10-35
10 14.15	Pay Items and Quantities . . . . .	10-35
10.15	Speed Zoning . . . . .	10-36
10.15.1	Regulatory Speeds in Work Zones . . . . .	10-36
10.16	Law Enforcement Services . . . . .	10-37
10.16.1	Use of On-Duty FHP (Limited Access Only) . . . . .	10-37
10.16.2	Use of Off-Duty Law Enforcement . . . . .	10-38
10.16.3	Coordination, Documentation and Payment . . . . .	10-38
10.16.4	Other Uses of Law Enforcement . . . . .	10-39
Exhibit 10-A	Lane Closures . . . . .	10-23 Thru 10-33

## Chapter 10

# WORK ZONE TRAFFIC CONTROL

### 10.1 General

The need to improve the capacity of, and to rehabilitate Florida's highways, has greatly increased the frequency of highway construction taking place immediately adjacent to or under traffic. The traveling public, as well as construction and inspection personnel, are exposed to conflicts that may become hazardous. In addition to the safety issue, the potential delays to the public, as traffic is interrupted by construction, can be significant. As a result, the Department places a great deal of emphasis upon ensuring that all traffic, including motorists, bicyclists and pedestrians can be accommodated through construction zones with minimum delay and exposure to unsafe conditions.

### 10.2 References

The following references contain the basic criteria and other required information for work zone traffic control in Florida:

- The ***Manual on Uniform Traffic Control Devices for Streets and Highways, (MUTCD)***, Federal Highway Administration. Part VI of the ***MUTCD*** deals specifically with work zone traffic control. Other parts of the ***MUTCD*** may also be useful in designing a traffic control plan.
- ***Policy on Geometric Design of Highways and Streets, AASHTO***
- ***Roadside Design Guide, AASHTO, Chapter 9***
- ***Roadway and Traffic Design Standards, Index Series 600, 415***
- ***Standard Specifications for Road and Bridge Construction***
- ***Basis of Estimate Handbook***

### 10.3 Comprehensive Work Zone Traffic Control Planning

Consideration of traffic control must begin at the Project Development and Environmental (PD&E) study stage. Impacts on traffic, traffic handling options, constructability, and design features and constraints, as they affect traffic, are to be evaluated for each alternate alignment studied. The preliminary engineering report must specifically address work zone traffic control.



Traffic control considerations must begin in the early stages of design, using the work zone traffic control material from the PD&E study as the basis. As the design progresses, the following should be considered:

**Design features and constraints** Length of the project, lane configuration, bike lanes, sidewalks and grade differentials between existing and proposed, interchanges and intersections, pavement materials, storm sewers, roadway lighting, utilities and bridge features are some of the design element decisions that might be influenced by work zone traffic control considerations.

**Contract specifications** Provisions such as time restrictions on construction activities, incentive-disincentive clauses, daily, weekly and seasonal restrictions and special materials may be necessary. Public relations activities such as media releases, television and radio spots, handbills, and highway advisory radio may be specified.

**Other actions** Actions may need to be taken by the Department prior to or during construction that may not be a contract requirement. Examples are dealing with the media and local businesses, provisions for mass transit options to commuters, service patrols, improvements to alternate routes, coordination with other projects and maintenance activities, and special inspection requirements.

**Public input.** On very large and complicated projects, it may be necessary to involve the public through informal public meetings to be held early in the design of a project. Close coordination with city and county officials may be necessary. Citizen and business advisory committees may be established as sources of input.

**Utility work** If contract utility work is anticipated in conjunction with or during the highway construction, the Traffic Control Plan (TCP) must account for and adequately protect all work activities. The phasing of construction activities must be compatible with the utility work. Utilities, whose work affects traffic, are required to have a TCP by FHWA. This requires early and effective coordination with utilities.

#### 10.4 Traffic Control Plans (TCP)

A TCP is a set of specific plan sheets, references to standard (typical) layouts, and/or notes on roadway plans describing how traffic will be controlled through a work zone. All projects and work on highways, roads and streets shall have a traffic control plan, as required by Florida Statute and Federal regulations. All work shall be executed under the established plan and Department approved procedures. The TCP is the result of considerations and investigations made in the development of a comprehensive plan for accommodating traffic through the construction zone. These considerations include the design itself, contract specifications, and plan sheets.

TCP sheets detail the proper delineation of traffic through the work zone during all construction phases. The complexity of the TCP varies with the complexity of the traffic problems associated with a project. Many situations can be covered adequately with references to specific sections from the *Manual on Uniform Traffic Control Devices (MUTCD)*, or *Roadway and Traffic Design Standards, Series 600*. Specific TCP sheets

shall be required in the plans set whenever project conditions are not specifically addressed in a typical layout from the manuals noted above. This is usually the case for complex projects, therefore references to the **Roadway and Traffic Design Standards**, as well as specific TCP sheets, will likely be necessary.

A traffic control plan should address the appropriate following information for the mainline and any affected cross roads, side streets, and ramps:

- 1 the location of all advance warning signs and lighting units
- 2 temporary pavement markings, (including RPM's)
- 3 location of temporary barriers and attenuators
- 4 temporary drainage design
- 5 channelizing devices at special locations
- 6 locations for special devices such as variable message signs (VMS), arrow panels, and temporary signals
- 7 VMS messages for each phase
- 8 signal timing for each phase, including method of temporary actuation if needed (Check with Traffic Operations Engineer)
- 9 location and geometry for transitions, detours, and diversions
- 10 typical sections for each phase of work on all projects, except simple resurfacing projects, in order to show lane widths, offsets, barrier locations and other features influencing traffic control
- 11 the proposed regulatory speed(s) for each phase
- 12 reference to appropriate **Roadway and Traffic Design Standards** or **MUTCD** drawings whenever applicable
- 13 appropriate quantities, pay items and pay item notes
- 14 resolve any conflicts between permanent signing and markings and work zone signing and markings
- 15 key strategies such as service patrol, police, public service announcements, Highway Advisory Radio, night work, etc
- 16 good plan notes
- 17 address the need for maintaining existing roadway lighting
- 18 work area access plan

**Chapter 19, Volume II, Plans Preparation and Assembly**, explains the required information for specific TCP sheets.

Consideration must also be given to adjoining, intersecting or sequential work zones. This can be a particular problem with maintenance operations, bridge or roadway projects under

different contracts, operations of other jurisdictions or utilities. When such work must take place, the operations must be coordinated and taken into account in the TCP so that the motorist encounters one, consistently designed, work zone.

TCP's for project designs "on the shelf" must be updated prior to contract letting.

## **10.5 TCP Development**

The following step-by-step process should be followed by designers when preparing traffic control plans:

### **STEP #1 Understand the Project**

- Field reviews by designers should be required
- Review the scope
- Examine the plans (Phase I to Phase II)
- Look at plan-profiles and cross-sections for general understanding
- Review PD&E study for any constraints
- Consider bicycle/pedestrian needs during construction
- For complex projects consider developing a TCP study and other possible strategies such as public awareness campaigns, alternate route improvements, service patrols, etc.

### **STEP #2 Develop Project Specific Objectives**

What are your objectives? Examples might be:

- use barrier wall to separate workers from traffic
- close road if adequate detour exists
- maintaining 2-way traffic at all times
- maintaining existing roadway capacity during peaks
- maintaining business/resident access
- provide bike/pedestrian access
- minimize wetland impacts
- expedite construction

### **STEP #3 Brainstorm TCP Alternatives**

Develop some rough alternatives considering what could be used to accomplish the work, such as constructing temporary pavement and/or temporary detours, using auxiliary lanes, placing 2-way traffic on one side of divided facility, using detour routes, etc Also, south side as opposed to north side on an east-west roadway Don't worry that an alternate doesn't meet all objectives

Designers should check condition of any proposed detour routes If off state system, may need agreement with locals

### **STEP #4 Develop a Construction Phasing Concept**

- Examine existing facility versus what is to be built This is a major task on jobs other than resurfacing
- Coordinate with bridge designers
- Color or mark the plan and profile sheets to show existing roadway versus new construction Then, check station by station, the plan sheet against cross-section sheets Make notes on plan sheets as to drop offs or other problems Use profile grade lines or centerlines for reference points
- List out major tasks to be completed, such as
  - construct new WB Roadway
  - construct new EB Roadway
  - construct frontage roads
  - construct bridge/flyover

**NOTE** The designer may need input from construction personnel or even contractors representatives in determining construction phases

- Make notes on plan sheets or notepad as to "decisions" that you make along the way

### **STEP #5 Examine/Analyze Alternatives Which Meet Objectives (for each phase).**

Next, consider how you could achieve the proposed alternatives and meet the stated objectives

- Examine pros and cons of various alternatives
- Consider how much work and expense is involved for each alternative
- Consider detour/transition locations, signal operations during construction, how to handle buses, bicycles, pedestrians, service vehicles, etc

### **STEP #6 Develop Detailed TCP**

Select the most feasible alternative for each phase Add details such as

- detour/transition geometrics and locations

- if lane closures are needed, use the lane closure technique discussed in **Section 10.14.7** to determine time frame for closures
- advanced signing scheme and locations, revisions needed to existing signs - including guide signs, and proposed signs for all work activities - lane closures, detours, etc , on mainline, side roads, cross-roads and ramps
- need for portable traffic signals, variable message signs, and barriers
- how existing operations will be maintained - side streets, businesses, residents, bikes, pedestrians, buses - bus stops, etc
- revisions to signal phasing and/or timing during each TCP phase
- regulatory speed desired for each phase
- all pay items and quantities needed for TCP
- how existing auxiliary lanes will be used and any restriction necessary during construction
- typical sections for each phase
- outline key strategies to be used
  - a service patrol
  - b police
  - c public service announcements
  - d Highway Advisory Radio
  - e night work
- need for alternate route improvements

## 10.6 Coordination

Work zone traffic control can be a complex undertaking that requires the coordination of a number of agencies and other interested parties. Planning and coordination must begin early in a project design.

Traffic control is a joint responsibility of design (both roadway and bridge), construction and traffic operations personnel. Coordination is necessary by all three parties in the development of TCPs. Both traffic operations and construction personnel must routinely review TCPs during Initial Engineering (Phase I to Phase II plans) to ensure that the plan is sound and constructable and bid items are complete and quantities reasonable. With subsequent reviews of Phase III plans, Designers are also encouraged to contact contractors for ideas on Traffic Control Plans.

Traffic control plans should also be reviewed with other appropriate offices such as maintenance, FHWA, community awareness teams, public, businesses, freeway

coordinator management teams, and local agencies **Initial reviews should be made by construction and traffic operations no later than the Phase II plans stage with subsequent reviews of Phase III plans.** Input from local engineering and law enforcement agencies should be obtained early in the process, such as during the PD&E study and the Phase I plans stage

Adjoining work zones may not have sufficient spacing for standard placement of signs and other traffic control devices within their traffic control zones. These situations can occur when separate contracts adjoin each other (separate bridge and roadway contracts are a typical example), utility work performed separately from roadway work or when maintenance activities are performed adjacent to a construction project. Where such restraints or conflicts occur, or are likely to occur, the designer should try to resolve the conflicts in order to prevent misunderstanding on the part of the traveling public.

### 10.6.1 Phase Submittals

TCP phase submittals should include the following

- **Phase I** - a typical section for each phase as well as a description of the phasing sequence and work involved
- **Phase II** - a majority of the TCP completed (75-90%), including the information outlined in **Section 10.4** of this chapter, and a list of the pay items needed
- **Phase III** - a final TCP, including all notes, pay items and preliminary quantities

**(Note:** The construction office estimates the duration for each phase of construction during Phase III review. The designer will finalize the quantities in the plans, comp book, and CES after receiving the estimated durations for construction.)

## 10.7 Work Zone Traffic Control Training

### 10.7.1 Background

Work zone traffic control is an important function affecting the safety of the traveling public, contractor personnel and equipment, and department employees. Every reasonable effort should be made to eliminate or reduce involvement in crashes within work zones. Proper traffic control training is vital to achieving this objective.

The Department's Maintenance of Traffic Committee consists of representatives from Roadway Design, Construction, Safety, Maintenance, Traffic Engineering, Value Engineering and FHWA. Its purpose is to develop, review or revise procedures, standards and specifications regarding work zone traffic control to maximize efficiency and enhance safety of motorists, bicyclists, pedestrians, and workers within the work zone.

### 10.7.2 Training Requirements

The Department's Maintenance of Traffic Committee has prescribed work zone traffic control training requirements for Department employees and shall furnish training course information and requirements to each District's Human Resource Development Manager

Every employee, including consultants, whose activities affect maintenance and construction work zone safety, from upper-level management through construction and maintenance field personnel, shall complete appropriate training as prescribed above and as required by **Department Procedure Number 750-030-006**

District Design, Construction, and Maintenance Engineers shall ensure that employees, including consultant personnel, who are responsible for traffic control plan design, implementation, inspection or supervision of the design, selection, placement, or maintenance of traffic control schemes and devices in work zones have been certified under the provisions of this procedure

## 10.8 Traffic Control Devices

Traffic control devices/methods that are available for use include

- Signs (warning, regulatory and guide)
- Lighting units (arrow panels, barricade and sign lights, illumination devices, temporary signals and variable message signs)
- Channelizing devices (cones, tubular markers, plastic drums, vertical panels, and Types I, II and III barricades)
- Markings (pavement markings, raised pavement markings, delineators, and removal of conflicting markings)
- Safety appurtenances (portable concrete barriers, guardrail and crash cushions) - See **AASHTO Roadside Design Guide (Chapter 9)**
- Flaggers
- Law Enforcement
- Guardrail attached to barrels for work zones < 45 mph - See **AASHTO Roadside Design Guide**.

The **MUTCD** contains detailed instructions on the use of traffic control devices. Special design considerations applicable to Florida are discussed in the following sections

Traffic control devices should not be placed in locations where they will block sidewalks or bike lanes

## 10.9 Signs

Sign messages for speed limits and distances are to be posted in English units

### 10.9.1 Advance Warning Signs

The TCP should identify the advance construction warning signs, including legends and location. These include signs such as "Road Work Ahead" and "Road Work One Mile". The TCP should provide the advanced warning signs, legends and locations for all proposed operations which require signing. These include diversions, detours, lane closures, and lane shifts, on the mainline as well as crossroads. The sequence for advance signing should be from general to more specific. As an example: Road Work Ahead (general), Left Lane Closed Ahead (more specific), Merge Right (specific).



## 10.9.2 Length of Construction Sign

The length of construction sign (G20-1) bearing the legend "Road Work Next Miles" is required for all projects of more than 2 miles in length. The sign shall be located at begin construction points.

## 10.9.3 Existing Signs

Existing (regulatory, warning, etc.) signs that conflict with the TCP shall be removed or relocated to complement the work zone conditions (i.e., if a stop sign on an existing side road is needed, use the existing sign and show the location that it is to be relocated to). Existing guide signs should be modified as necessary. It is good practice to revise existing guide signs by using black on orange panels to show changes made necessary by the construction operations.

If permanent guide signs are to be removed during construction, provisions should be made for temporary guide signing. The temporary sign should be black on orange with the legend designed in accordance with **MUTCD** requirements for permanent guide signing whenever possible.

## 10.10 Lighting Units

### 10.10.1 Warning Lights

Warning lights shall be in accordance with the **Roadway and Traffic Design Standards, Index 600**.

#### Type A Flashing

To be mounted on Vertical Panel, Barricade, or Drums to mark an obstruction adjacent to or in the intended travel way. It is to be paid for as part of the device that it is mounted on.

#### Type B Flashing

To be mounted on the first and second advanced warning signs where two or more signs are used, as well as on advanced warning signs of intersecting roads. Type B Warning lights are to be paid for as High Intensity Flashing Lights (Temporary- Type B).

#### Steady-Burn Type C

Steady Burn lights are to be placed on channelizing devices and barrier wall to delineate the traveled way on lane closures, lane changes, diversion curves and other similar conditions. On channelizing devices (Vertical Panels, Barricades, and Drums), their payment is included as part of the device. For use on Barrier wall, they are to be paid for separately as Lights, Temporary, Barrier Wall Mount (Type C, Steady Burn). Their spacing on barrier wall is as follows:

Transitions - 50 ft on center

Curves - 100 ft on center

Tangents - 200 ft on center (Note Curves flat enough to maintain a normal 2% cross-slope are to have steady burn lights placed at the same spacing as tangents)

### 10.10.2 Advance Warning Arrow Panels

Arrow panels shall be used to supplement other devices for all lane closures on high-speed (55 mph or greater) and high-traffic density multilane roadways. The use of arrow panels should be considered for all other multi-lane closures. These devices are also useful for short-term operations, such as during work zone installation and removal. Arrow panels should not be used in lane shift situations. Research has shown that motorists tend to change lanes (on multi-lane facilities) whenever an arrow panel is used to indicate a lane shift. Since this "response" is not desired, the arrow panel should not be used for lane shift situations on multi-lane roadways. Refer to current *MUTCD* for further information.

Arrow panel locations shall be shown on the TCP, along with any necessary notes concerning the use of this device.

### 10.10.3 Variable Message Signs

Variable message signs (VMS) may be used to supplement a traffic control zone. As a supplemental device, it cannot be used to replace any required sign or other device. These devices can be useful in providing information to the motorist about construction schedules, alternate routes, expected delays, and detours. Variable message signs should be considered for use in complex, high-density work zones. Messages must be simple, with a minimum number of words and lines and should require no more than two displays of no more than three lines each with 8 characters per line. The TCP shall include the location and messages to be displayed.

The message displayed should be visible and legible to the motorist at a minimum distance of 900 ft on approach to the signs. All messages should be cycled so that two message cycles are displayed to a driver while approaching the sign from 900 ft at 55 mph.

The VMS units may be used

- To supplement conventional traffic control devices in construction work areas and should be placed approximately 500 to 800 ft in advance of potential traffic problems, or
- 0.5 to 2 miles in advance of complex traffic control schemes which require new and/or unusual traffic patterns for the motorists.

A VMS is required for night time work that takes place within 4 ft of the traveled way.

---

## Typical Conditions

Consistent with the factors described above, VMS messages should be considered under the following conditions

- 1 Road closures
- 2 Ramp closures
- 3 Delays one hour or longer created by
  - a congestion
  - b crashes
  - c lane closures
  - d two-way traffic on divided highway
  - e multiple lane closures
  - f unexpected shifts in alignment

## Message Selection

Programmed messages should provide appropriate messages for the conditions likely to be encountered. A worksheet is provided and may be placed in the TCP. The following items must be carefully considered in the development of a message

- 1 **Message elements - not necessarily in order**
  - a problem statement (where?)
  - b effect statement (what?)
  - c attention statement (who?)
  - d action statement (do?)
- 2 **Message format**
  - a will vary depending on content
  - b "where" or "what" will generally lead
  - c "who" and "do" follow in that order
  - d "who" often understood from "where"
- 3 **Display format**
  - a discrete, with entire message displayed at once is most desirable
  - b sequential is OK, 2 part maximum
  - c run-on moving displays prohibited
  - d one abbreviation per panel display desirable, two abbreviations are maximum. Route designation is considered as one abbreviation and one word. Guidelines for abbreviations are provided on the following pages

#### **10.10.4 Traffic Signals**

Frequently portable or temporary traffic signals will be a preferred alternative to a flagger. Also, existing signal operations may need to be revised to accommodate the construction operations. The TCP should identify the specific alterations (physical location and timing) necessary for existing signals and the location and timing of portable signals. It shall include signal installation plans for each phase of construction. The signal installation plan shall include both the initial signal operation plan and the initial timing adjustments. Traffic control signal requirements or responsibilities shall be included in the Technical Special Provisions. Signal displays and location must meet **MUTCD** requirements. If temporary signals are used where a pedestrian crossing is present, either existing or temporary, the pedestrian must be accommodated in the signal timing.

Temporary Signal Plans or modification to existing signals should be reviewed by the appropriate section in the district for structural soundness and signal function.

## VARIABLE MESSAGE SIGNS WORKSHEET

Location of board \_\_\_\_\_

Used from \_\_\_\_\_ - \_\_\_\_\_ - \_\_\_\_\_ at \_\_\_\_\_ am/pm  
to \_\_\_\_\_ - \_\_\_\_\_ - \_\_\_\_\_ at \_\_\_\_\_ am/pm

Message programmed by \_\_\_\_\_

### MESSAGE 1

--	--	--	--	--	--	--	--

--	--	--	--	--	--	--	--

--	--	--	--	--	--	--	--

### MESSAGE 2

--	--	--	--	--	--	--	--

--	--	--	--	--	--	--	--

--	--	--	--	--	--	--	--

#### Timing

Message 1 will run \_\_\_\_\_ seconds  
Message 2 will run \_\_\_\_\_ seconds

## STANDARD ABBREVIATIONS FOR USE ON VARIABLE MESSAGE SIGNS

Standard abbreviations easily understood are

<u>WORD</u>	<u>ABBREV.</u>	<u>WORD</u>	<u>ABBREV.</u>
Boulevard	BLVD	Normal	NORM
Center	CNTR	Parking	PKING
Emergency	EMER	Road	RD
Entrance, Enter	ENT	Service	SERV
Expressway	EXPWY	Shoulder	SHLDR
Freeway	FRWY, FWY	Slippery	SLIP
Highway	HWY	Speed	SPD
Information	INFO	Traffic	TRAF
Left	LFT	Travelers	TRVLRS
Maintenance	MAINT	Warning	WARN

Other abbreviations are easily understood whenever they appear in conjunction with a particular word commonly associated with it. These words and abbreviations are as follows

<u>WORD</u>	<u>ABBREV.</u>	<u>PROMPT</u>
Access	ACCS	Road
Ahead	AHD	Fog*
Blocked	BLKD	Lane*
Bridge	BRDG	[Name]*
Chemical	CHEM	Spill
Construction	CONST	Ahead
Exit	EX, EXT	Next*
Express	EXP	Lane
Hazardous	HAZ	Driving
Interstate	I	[Number]
Major	MAJ	Accident
Mile	MI	[Number]*
Minor	MNR	Accident
Minute(s)	MIN	[Number]*
Oversized	OVRSZ	Load
Prepare	PREP	To Stop
Pavement	PVMT	Wet*
Quality	QLTY	Air*
Route	RT	Best*
Turnpike	TRNPK	[Name]*
Vehicle	VEH	Stalled*
Cardinal Directions	N,E,S,W	[Number]
Upper, Lower	UPR, LWR	Level

\* = Prompt word given first

The following abbreviations are understood with a **prompt** word by about 75% of the drivers. These abbreviations may require some public education prior to usage.

<u>WORD</u>	<u>ABBREV.</u>	<u>PROMPT</u>
Condition	COND	Traffic*
Congested	CONG	Traffic
Downtown	DWNTN	Traffic
Frontage	FRNTG	Road
Local	LOC	Traffic
Northbound	N-BND	Traffic
Roadwork	RDWK	Ahead [Distance]
Temporary	TEMP	Route
Township	TWNSHP	Limits

\* = Prompt word given first

Certain abbreviations are prone to inviting confusion because another word is abbreviated or could be abbreviated in the same way. **DO NOT USE THESE ABBREVIATIONS:**

<u>ABBREV.</u>	<u>INTENDED WORD</u>	<u>WORD ERRONEOUSLY GIVEN</u>
WRNG	Warning	Wrong
ACC	Accident	Access (Road)
DLY	Delay	Daily
LT	Light (Traffic)	Left
STAD	Stadium	Standard
L	Left	Lane (Merge)
PARK	Parking	Park
RED	Reduce	Red
POLL	Pollution (Index)	Poll
FDR	Feeder	Federal
LOC	Local	Location
TEMP	Temporary	Temperature
CLRS	Clears	Colors

## **10.11 Channelizing Devices**

### **10.11.1 Type III Barricades**

Two Type III barricades should be used to block off or close a roadway. Whenever two barricades are used together, only one warning light is required on each barricade.

### **10.11.2 Separation Devices**

Placing two lane two-way operations (traffic) (TLTWO) on one roadway of a normally divided highway should be a last resort (see *MUTCD*) and should be done with special care.

When traffic control must be maintained on one roadway of a normally divided highway, opposing traffic shall be separated either with portable barrier wall or Temporary Traffic Separators (see the *Roadway and Traffic Design Standards, Index 614*). The use of striping, raised pavement markers, and complementary signing, either alone or in combination is not considered acceptable for separation purposes.

### **10.11.3 Channelizing Device Alternates**

It is intended that cones, Type I and II barricades, vertical panels, drums and tubular markers be considered as alternative channelizing devices to be used at the contractor's option. The only exceptions to this are that tubular markers are not allowed at night and the use of cones at night is restricted. (See the *Roadway and Traffic Design Standards, Index 600 & 614*). The designer should not further restrict the options of channelizing devices.

## **10.12 Pavement Markings**

### **10.12.1 Removing Pavement Markings**

Existing pavement markings that conflict with temporary work zone traffic patterns must be obliterated where operations will exceed one work period. Painting over existing pavement markings is not permitted.

### **10.12.2 Reflectorized Raised Pavement Marker (RPM)**

Raised Pavement Markers (RPM) are required as a supplement to all lane lines during construction. For further direction on the use of RPM's in the work zone the designer should refer to the *Roadway and Traffic Design Standards, Index 600*.

### **10.12.3 Work Zone Markings**

Markings for work zones include "Removable" and "Non-Removable" markings. **Section**



**102-3.3 of the Specifications** describes when each type is required. A separate pay item number is used for each. The designer should be aware of this information and provide appropriate pay items in the plans.

The designer should also consider using Type S Asphalt and/or milling with Type S Asphalt for covering/removing unneeded markings, especially in areas such as diversions or crossovers. Some construction phase durations may be long enough to require use of interim friction courses. When these type issues arise, the designer should work with the District Pavement Design Engineer, to determine what combination of pavement options best complements the Maintenance of Traffic with the final pavement design.

## **10.13 Safety Appurtenances for Work Zones**

### **10.13.1 Traffic Barriers**

Work zone traffic barriers are designed either as permanent barriers or as temporary barriers that can be easily relocated. They have four specific functions: to protect traffic from entering work areas, such as excavations or material storage sites, to provide positive protection for workers, to separate two-way traffic, and to protect construction such as false work for bridges and other exposed objects. The designer should anticipate when and where barriers will be needed and include this information and the quantities on the plans.

### **10.13.2 Portable Concrete Safety Shape (Temporary Barrier Walls)**

Portable concrete safety shape barriers, also known as portable concrete barriers (PCB's), are widely used in work zones to protect motorists as well as workers. However, improper use of these barriers can provide a "false sense of security" for both the motorist and the worker. Therefore, care must be taken in their design, installation and maintenance. Installation instructions and flare rates are given in the *Roadway and Traffic Design Standards, Index 415 and Index 600*.

To perform properly and redirect vehicles, the PCB system must be capable of withstanding severe impacts. The PCB's weakest point is its connector which includes the physical connection and mating faces of adjoining barriers or guardrail. When a PCB system is used to mitigate a dropoff condition, the surface that the PCB is placed on shall have a cross-slope of 1:10 or flatter carried a minimum of 2 ft behind the barrier. When the designer proposes temporary barrier walls, the cross-slope should be checked and temporary earthwork shown in the plans if necessary for the proper placement of the barrier system. When PCB's are used on bridges, it should connect to the bridge deck as shown by the special detail on the *Roadway and Traffic Design Standards, Index 415*.

The designer should show or note the location of all temporary barrier wall in the plans. The plans should also include a work area access plan for those projects with median work which is shielded with barrier wall.

### 10.13.3 End Treatments

The desirable treatments for exposed ends of barriers are

- connecting to an existing barrier (smooth, structural connections are required - Refer to the ***Roadway and Traffic Design Standards, Indexes 410 and 415***) or
- attaching a crashworthy terminal such as a crash cushion or
- flaring away to the edge of the clear zone (For Work Zone Clear zones, see The ***Roadway and Traffic Design Standards, Index 600***)

### 10.13.4 Modifications of Existing Barriers

When 2-way traffic is placed on a facility that is normally one-way, the existing permanent or temporary barriers will be modified as necessary to ensure their proper crashworthiness during the temporary situation. This will include eliminating non-crashworthy end treatments, snag points or other protrusions normally angled away or hidden from approaching vehicles.

### 10.13.5 Crash Cushions

Crash cushions in work zones may be used in the same manner as at permanent highway installations. Crash cushions are used to protect the motorists from the exposed ends of barriers, fixed objects and other hazards within the clear zone. Two types of stationary crash cushions are commonly used, Inertia Attenuators (i.e. sand filled plastic barrel systems), and redirective systems such as the QuadGuard or the REACT 350.

The designer must determine the need for crash cushions, select the appropriate type, and provide the necessary details and quantities in the plans. Selection of a system should be the result of an analysis of site condition (i.e. space and need). The GREAT and REACT 350 will shield a hazard by redirecting vehicles or absorbing end-on hits. Sand barrels do not have redirection capability and can only shield a hazard by absorbing end-on hits. End protection other than approved redirective crash cushions must be custom engineered for each independent installation and detailed in the plans. The ***Roadway and Traffic Design Standards*** and the ***AASHTO Roadside Design Guide*** can be consulted for more information.

### 10.13.6 Temporary Curb

In work zones where the posted speed is 45 mph or less, Temporary Curb (refer to the ***Roadway and Traffic Design Standards, Index 600***) may be used to protect drop-offs to depths of 4 ft. In urban conditions with frequent driveways, temporary curb may be desirable over temporary barrier wall due to its lower profile, thus allowing for better sight distance. Also, the ends of temporary curb do not require crash cushions for protection.

## 10.14 Traffic Control Plan Details

The *Roadway and Traffic Design Standards, Indexes 601 through 660*, are layouts of work zone traffic control for typical conditions. These indexes should be referenced only if project conditions are nearly the same as the typical layout. Otherwise, specific plan sheets or details must be prepared. Some conditions that will require specific plan sheets include

- Construction work zones near railroad crossings
- Work not covered by a typical layout
- Nighttime work requiring special lighting, oversized or additional devices
- Ramps and intersections that interrupt the standard layout
- Sight distance restrictions such as horizontal or vertical curves
- Lane or shoulder configurations that do not match the standards
- Special considerations during installation, intermediate traffic shifts and removal
- Complex projects, including add-lane projects, that involve many phases, traffic shifts, entrances and exits

When designing layouts, the following shall be considered

### 10.14.1 Taper Lengths

Minimum taper lengths shall be calculated by the formulas for transition distances given on the *Roadway and Traffic Design Standards, Index 600*

"L" is the length of the taper, "W" is the width of the closed lane and "S" is the posted regulatory speed for the work zone. Both L and W are measured in feet. Speeds are given in the Index.

**Table 10.14.1** (taken from *MUTCD*) gives the criteria for the lengths of the various taper types

**Table 10.14.1 Taper Length Criteria for Work Zones**

Type of Taper	Taper Length
<b>UPSTREAM TAPERS</b>	
Merging Taper	L Minimum
Shifting Taper	1/2 L Minimum
Shoulder Taper	1/3 L Minimum
Two-way Traffic Taper	100 ft Maximum
<b>DOWNSTREAM TAPERS</b>	
	100 ft per lane (use is optional)

## **10.14.2 Intersecting Road Signing and Signals**

Signing for the control of traffic entering and leaving work zones by way of intersecting highways, roads and streets shall be adequate to make drivers aware of work zone conditions. Under no condition will intersecting leg signing be less than a "Road Work Ahead" sign for approaching vehicles and an "End Construction" sign for departure vehicles. The designer should remember to include these signs in the estimated quantity for Construction warning signs.

Existing traffic signal operations that require modification in order to carry out work zone traffic control shall be as approved by the District Traffic Operations Engineer (DTOE). If lane shifts occur, signal heads may have to be adjusted to maintain proper position. The DTOE should also determine the need for temporary loops for traffic actuated signals. The TCP should include all necessary signal adjustments.

## **10.14.3 Sight Distance To Delineation Devices**

Merging (lane closure) tapers should be obvious to drivers. If restricted sight distance is a problem (e.g., a sharp vertical or horizontal curve approaching the closed lane), the taper should begin well in advance of the view obstruction. The beginning of tapers should not be hidden behind curves.

## **10.14.4 Pedestrians and Bicyclists**

### **10.14.4.1 Pedestrian Considerations**

Where an existing pedestrian way is located within a work zone, it must be maintained.

There are three threshold considerations in planning for pedestrian safety in work zones on highways and streets:

- Pedestrians should not be led into direct conflicts with work site vehicles, equipment or operations.
- Pedestrians should not be led into direct conflicts with mainline traffic moving through or around the work site.
- Pedestrians should be provided with a safe, convenient travel path that replicates as nearly as possible the most desirable characteristics of sidewalks or footpaths.

Pedestrian accommodations through work zones must include provisions for the disabled. Temporary traffic control devices for vehicular traffic should not be allowed within the pedestrians' travel path.

Signing should be used to direct pedestrians to safe street crossings in advance of an encounter with a work zone. Signs should be placed at intersections so pedestrians, particularly in high-traffic-volume urban and suburban areas, are not confronted with mid-block crossings.

### 10.14.4.2 Bicycle Considerations

When an existing bicycle way is located within a work zone, it must be maintained

There are several considerations in planning for bicyclists in work zones on highways and streets

- Bicyclists should not be led into direct conflicts with mainline traffic, work site vehicles, or equipment moving through or around traffic control zones
- Bicyclists should be provided with a travel route that replicates the most desirable characteristics of a wide paved shoulder or bike lane through or around the work zone
- If the work zone interrupts the continuity of an existing shared use path or bike route system, signs directing bicyclists through or around the work zone and back to the path or route should be provided
- The bicyclist should not be directed onto the same path used by pedestrians

### 10.14.5 Superelevation

Horizontal curves constructed in conjunction with temporary work zone diversions, transitions, and crossovers should have the required superelevation. Under conditions where superelevation is not used, the minimum radii that can be applied are listed in the **Table 10.14.2**. Superelevation must be included with the design whenever the minimum radii cannot be achieved.

**Table 10.14.2 Minimum Radii for  
Normal 0.02 Cross Slopes**

SPEED (mph)	MINIMUM RADIUS (feet)
65	3130
60	2400
55	1840
50	1390
45	1080
40	820
35	610
30	430

### 10.14.6 Lane Widths

Existing lane widths of through roadways should be maintained through work zone travel ways wherever practical. The minimum widths for work zone travel lanes shall be 10 ft for all roadways other than Interstate. On Interstate highways the minimum width for work zone travel lanes shall be 11 ft except at least one 12 ft lane in each direction shall be provided.

### 10.14.7 Lane Closure Analysis

The lane closure analysis is a process used by designers to calculate the peak hour traffic volume and the restricted capacity for open road and signalized intersections. The analysis will determine if a lane closure should or should not be allowed and the time of day or night a lane closure could occur without excessive travel delay.

For all projects under reconstruction, the existing number of lanes shall remain open to traffic when construction is not active.

For construction on Limited Access facilities, the Traffic Control Plan will keep the existing number of traffic lanes open at all times throughout the duration of the construction project. No lane closures in excess of one work day shall be permitted on Limited Access construction where only two traveled lanes in one direction exist. If it becomes necessary to have a long term lane closure on a four lane Interstate, sufficient documentation shall be provided to the District Secretary for her/his approval.

**Exhibit 10-A** includes the **Lane Closure Analysis Worksheets** and two sample analyses. The **Sample Lane Closure Worksheet (Exhibit 10-A, sheet 3 of 11)** has been cross-referenced to the **Lane Closure Symbols and Definitions Sheet (Exhibit 10-A, sheets 1 & 2 of 11)** with circled numbers. The circled numbers correspond to the numbers of the symbols and definitions. The symbols and definition sheet shows the designer where to find the necessary information to fill out the Lane Closure Worksheet.

Fill out the top part of the Lane Closure Worksheet and complete the formulas to calculate the hourly percentage of traffic at which a lane closure will be permitted. Transfer these percentages to the graph on the **Lane Closure 24 Hour Counts Sheet (Exhibit 10-A, sheet 5 of 11)**. Draw a line across the graph representing the percentage for both open road and signalized intersections (see **Exhibit 10-A, sheet 7 of 11**). Plot the hourly percentages (hourly volume divided by total volume) on the graph. Any hourly percentage extending above the restricted capacity percentage lines for open road or signalized intersections indicated lane closure problems. The bottom of the graph gives times for AM and PM. By coordinating the lane closure problem areas to the time of day, a designer knows when to restrict lane closure.

Many of Florida's roadways have directional peak hour traffic volumes, with inbound morning traffic and outbound afternoon traffic. Doing a composite lane closure analysis would in many cases require night work. However, if a separate lane closure analysis is calculated for inbound and outbound separately, a lane closure may be allowed and the contractor could work in daylight hours. (See **Exhibits 10-A, sheet 10 of 11** and **10-A, sheet 11 of 11**.)

## LANE CLOSURES

### Symbols and Definitions

- 1 **ATC** = Actual Traffic Counts Use current traffic counts Traffic counts can be obtained from the Office of Planning, or you may need to get traffic counts done The designer needs hourly traffic volumes with a total traffic volume for a 24 hour period (see **Exhibit 10-A, sheet 7 of 11**)
- 2 **P/D** = Peak Traffic to Daily Traffic Ratio Highest hourly volume divided by the total twenty four hour volume Convert the percentage to a decimal on the Lane Closure Worksheet (see **Exhibit 10-A, sheet 7 of 11**)
- 3 **D** = Directional Distribution of peak hour traffic on multi-laned roads This factor does not apply to a two lane roadway converted to two way, one lane The directional distribution can be obtained from the Office of Planning
- 4 **PSCF** = Peak Season Conversion Factor Many counties in Florida have a significant variance in seasonal traffic The designer should use the highest PSCF for the construction period The Office of Planning has tables showing Peak Season Conversion Factors for every county in Florida (See sample table of values on **Exhibit 10-A, Sheet 4 of 11**)
- 5 **RTF** = Remaining Traffic Factor is the percentage of traffic that will not be diverted onto other facilities during a lane closure Convert the percentage to a decimal on the Lane Closure Worksheet This is an estimate that the designer must make on his own, or with help from the Office of Planning Range 0% for all traffic diverted to 100% for none diverted
- 6 **G/C** = Ratio of Green to Cycle Time This factor is to be applied when lane closure is through or within 600 ft of a signalized intersection The Office of Traffic Engineering has timing cycles for all traffic signals
- 7 **V** = Peak Hour Traffic Volume The designer calculates the peak hour traffic volume by multiplying the actual traffic count, times peak to daily traffic ratio, times directional factor, times peak seasonal factor, times remaining traffic factor This calculation will give the designer the expected traffic volume of a roadway at the anticipated time of a lane closure

**Exhibit 10-A, Sheet 1 Of 11**

- 8 **C** = Capacity of a 2L, 4L or 6L roadway with one lane closed, and the remaining lane(s) unrestricted by lateral obstructions The capacity of a 4L or 6L roadway is based on lane closure in only one direction (see Lane Closure Capacity Table on **Exhibit 10-A, sheet 3 of 11**)
  
- 9 **RC** = Restricting Capacity of the above facilities by site specific limitations detailed in the Traffic Control Plans (TCP) which apply to travel lane width, lateral clearance and the work zone factor The work zone factor only applies to two lane roadways (see the tables on **Exhibit 10-A, sheet 4 of 11** to obtain the Obstruction Factor and Work Zone Factor)
  
- 10 **OF** = Obstruction Factor which reduces the capacity of the remaining travel lane(s) by restricting one or both of the following components Travel lane width less than 12 ft and lateral clearance less than 6 ft (see TCP and Obstruction Factor Table in **Exhibit 10-A, sheet 4 of 11**)
  
- 11 **WZF** = Work Zone Factor (WZF) is directly proportional to the work zone length (WZL) The capacity is reduced by restricting traffic movement to a single lane while opposing traffic queues The WZF and WZL only apply to a two lane roadway converted to two way, one lane (see the Work Zone Factor Table on **Exhibit 10-A, sheet 4 of 11**)
  
- 12 **TLW** = Travel Lane Width is used to determine the obstruction factor (see TCP and the Obstruction Factor Table on **Exhibit 10-A, sheet 4 of 11**)
  
- 13 **LC** = Lateral Clearance is the distance from the edge of the travel lane to the obstruction The lateral clearance is used to determine the obstruction factor (see MOT plans and Obstruction Factor Table on **Exhibit 10-A, sheet 4 of 11**)

**Exhibit 10-A, Sheet 2 of 11**



### LANE CLOSURE WORKSHEET

FINANCIAL PROJECT ID \_\_\_\_\_ STATE PROJECT NO \_\_\_\_\_

FAPNO \_\_\_\_\_

WPI NO \_\_\_\_\_ COUNTY \_\_\_\_\_ DESIGNER \_\_\_\_\_

NO EXISTING LANES \_\_\_\_\_ SCOPEOFWORK \_\_\_\_\_

Calculate the peak hour traffic volume (V)

$$V = ATC \underline{1} \times P/D \underline{2} \times D \underline{3} \times PSCF \underline{4} \times RTF \underline{5} = \underline{7}$$

#### LANE CLOSURE CAPACITY TABLE

Capacity © of an Existing 2 Lane-Converted to 2 Way, 1 Lane = 1400 VPH  
 Capacity © of an Existing 4 Lane-Converted to 2 Way, 1 Lane = 1300 VPH  
 Capacity © of an Existing 6 Lane-Converted to 2 Way, 2 Lane = 3600 VPH

Factors restricting capacity

TLW 12 LC 13 WZF \_\_\_\_\_ G/C 6

Calculate the Restricted Capacity (RC) at the Lane Closure Site by multiplying the appropriate 2L, 4L, or 6L Capacity © from the Table above by the Obstruction Factor (OF) and the Work Zone Factor (WZF). If the Lane Closure is through or within 600 ft. of a signalized intersection, multiply the RC by the G/C Ratio

$$RC \text{ (Open Road)} = C \underline{8} \times OF \underline{10} \times WZF \underline{11} = \underline{9}$$

$$RC \text{ (Signalized)} = RC \text{ (Open Road)} \underline{9} \times G/C \underline{6} = \underline{9}$$

If  $V > RC$ , there is no restriction on Lane Closure

If  $V > RC$ , calculate the hourly percentage of ADT at which Lane Closure will be permitted

$$\% = \frac{RC \text{ (Open Road)} \underline{9}}{\text{ATC} \underline{1} \times P/D \underline{2} \times D \underline{3} \times PSCF \underline{4} \times RTF \underline{5}} = \underline{\hspace{2cm}}$$

$$\text{Signalized \%} = \text{Open Road \%} \times G/C \underline{6} = \underline{\hspace{2cm}}$$

Plot 24 hour traffic to determine when Lane Closure permitted (See Exhibit 10-A, Sheet 5 of 11)

NOTE For Existing 2 Lane Roadways, D = 1.00

Work Zone Factor (WZF) applies only to 2 Lane Roadways

For RTF < 1.00, briefly describe alternate route \_\_\_\_\_

**Lane Closures - Capacity Adjustment Factors PSCF Sample**

WK	DATES	SF	PSCF	WK	DATES	SF	PSCF
18	04/26 - 05/02/98	0 89	1 11	27	06/28 - 07/04/98	0 69	0 90
19	05/03 - 05/09/98	0 88	1 15	28	07/05 - 07/11/98	0 67	0 87
20	05/10 - 05/16/98	0 91	1 19	29	07/12 - 07/18/98	0 65	0 85
21	05/17 - 05/23/98	0 86	1 12	30	07/19 - 07/25/98	0 70	0 91
22	05/24 - 05/30/98	0 89	1 16	31	07/26 - 08/01/98	0 75	0 98
23	05/31 - 06/06/98	0 83	1 08	32	08/02 - 08/08/98	0 81	1 06
24	06/07 - 06/13/98	0 78	1 02	33	08/09 - 08/15/98	0 86	1 12
25	06/14 - 06/20/98	0 73	0 95	34	08/16 - 08/22/98	0 91	1 19
26	06/21 - 06/27/98	0 71	0 92	35	08/23 - 08/29/98	0 92	1 20

**Note:** The week of 08/23/98 is the Peak Week for the construction period

**Obstruction Factors (OF)**

Lateral Clearance (LC) (feet)	Travel Lane Width (TLW) (feet)			
	12	11	10	9
6	1 00	0 96	0 90	0 80
4	0 98	0 94	0 87	0 77
2	0 94	0 90	0 83	0 72
0 0	0 86	0 82	0 75	0 65

**Work Zone Factors (WZF)**

WZL (ft.)	WZF	WZL (ft.)	WZF	WZL (ft.)	WZF
200	0 98	2200	0 81	4200	0 64
400	0 97	2400	0 80	4400	0 63
600	0 95	2600	0 78	4600	0 61
800	0 93	2800	0 76	4800	0 59
1000	0 92	3000	0 74	5000	0 57
1200	0 90	3200	0 73	5200	0 56
1400	0 88	3400	0 71	5400	0 54
1600	0 86	3600	0 69	5600	0 53
1800	0 85	3800	0 68	5800	0 51
2000	0 83	4000	0 66	6000	0 50

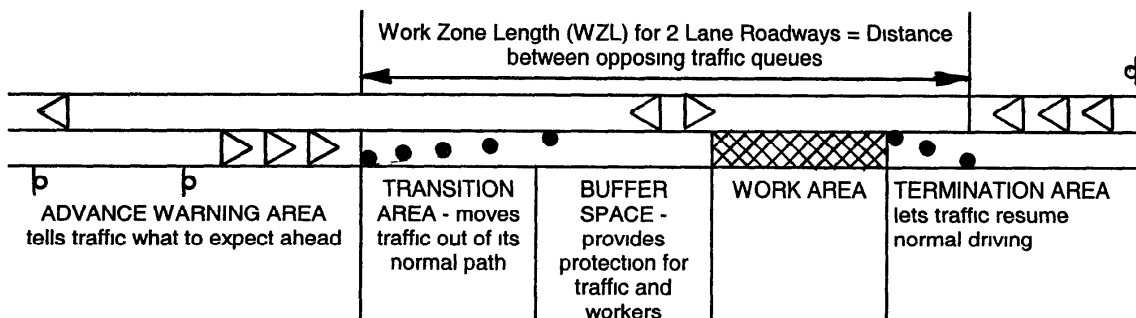

**Exhibit 10-A, Sheet 4 of 11**

**LANE CLOSURES**  
 24 HOUR COUNTS

TIME	AM HOURLY VOLUME	ATC %	PM HOURLY VOLUME	ATC %	DATE
12 - 1	_____	_____	_____	_____	_____
1 - 2	_____	_____	_____	_____	_____
2 - 3	_____	_____	_____	_____	_____
3 - 4	_____	_____	_____	_____	DESIGNER _____
4 - 5	_____	_____	_____	_____	_____
5 - 6	_____	_____	_____	_____	_____
6 - 7	_____	_____	_____	_____	PROJECT NO _____
7 - 8	_____	_____	_____	_____	_____
8 - 9	_____	_____	_____	_____	_____
9 - 10	_____	_____	_____	_____	_____
10 - 11	_____	_____	_____	_____	_____
11 - 12	_____	_____	_____	_____	_____
		TOTAL	_____	_____	LOCATION _____

**HOURLY VARIATION OF DAILY TRAFFIC**

-CONCLUSION-  
 ROUND TO THE  
 NEAREST 1/2 HOUR  
 CONSERVATIVELY

OPEN ROAD LANE  
 CLOSURE

SIGNALIZED LANE  
 CLOSURE

Exhibit 10-A, Sheet 5 of 11

**LANE CLOSURE WORKSHEET**

FINANCIAL PROJECT ID \_\_\_\_\_ STATE PROJECT NO 12345-6789  
 FAP NO NA  
 WPI NO 1234567 COUNTY TROPIC DESIGNER YATES  
 NO EXISTING LANES \_\_\_\_\_ SCOPE OF WORK Widen  
and Resurface

Calculate the peak hour traffic volume (V)

$V = ATC \underline{15000} \times P/D \underline{0.083} \times D \underline{NA} \times PSCF \underline{1.20} \times RTF \underline{0.75} = \underline{1120}$

**LANE CLOSURE CAPACITY TABLE**

Capacity<sup>©</sup> of an Existing 2 Lane-Converted to 2 Way, 1 Lane = 1400VPH  
 Capacity<sup>©</sup> of an Existing 4 Lane-Converted to 1 Way, 1 Lane = 1800VPH  
 Capacity<sup>©</sup> of an Existing 6 Lane-Converted to 1 Way, 2 Lane = 3600VPH  
 Factors restricting Capacity

TLW 10 LC 4 WZL 2100 G/C 0.64

Calculate the Restricted Capacity (RC) at the Lane Closure Site by multiplying the appropriate 2L, 4L, or 6L Capacity<sup>©</sup> from the Table above by the Obstruction Factor (OF) and the Work Zone Factor (WZF). If the Lane Closure is through or within 600 ft. of a signalized intersection, multiply the RC by the G/C Ratio

$RC \text{ (Open Road)} = C \underline{1400} \times OF \underline{0.87} \times WZF \underline{0.82} = \underline{999}$

$RC \text{ (Signalized)} = RC \text{ (Open Road)} \underline{999} \times G/C \underline{0.64} = \underline{639}$

If  $V \leq RC$ , there is no restriction on Lane Closure

If  $V > RC$ , calculate the hourly percentage of ADT at which Lane Closure will be permitted

$\% = \frac{RC \text{ (Open Road)} \underline{999}}{ATC \underline{15000} \times D \underline{1.00} \times PSCF \underline{1.20} \times RTF \underline{0.75}} = \underline{7.40} \%$

$\text{Signalized \%} = \text{Open Road \%} \underline{7.40} \times G/C \underline{0.64} = \underline{4.74}$

Plot 24 hour traffic to determine when Lane Closure permitted (See Exhibit 10-A, Sheet 5 of 11)

NOTE For Existing 2 Lane Roadways, D = 1.00

Work Zone Factor (WZF) applies only to 2 Lane Roadways

For  $RC < 100$ , briefly describe alternate route 25% of existing

traffic diverted on Bullard Blvd., north on Newhall

Lane, then east on Xanders Expressway.

Exhibit 10-A, Sheet 6 of 11

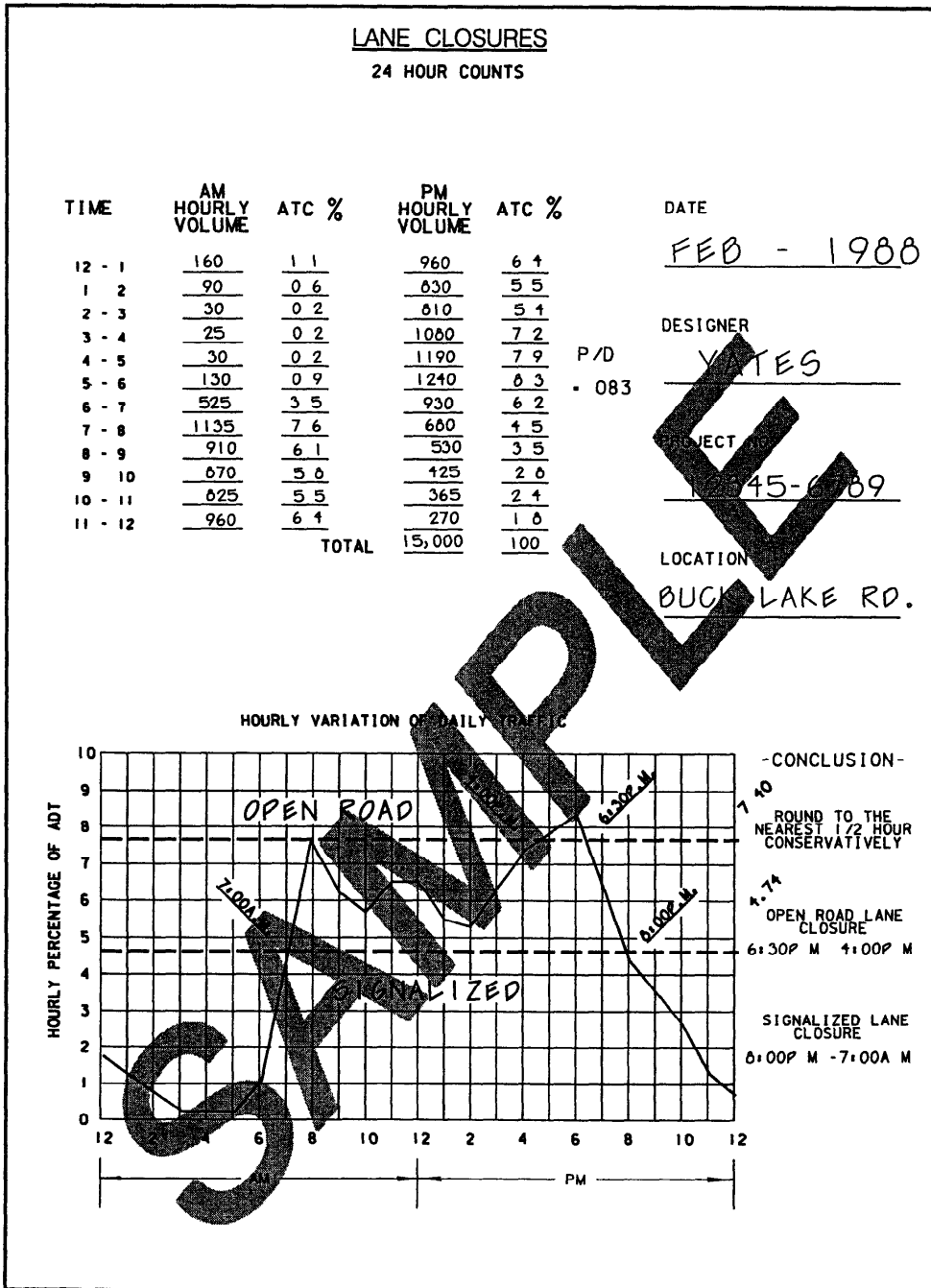

Exhibit 10-A, Sheet 7 of 11

### LANE CLOSURE WORKSHEET

FINANCIAL PROJECT ID \_\_\_\_\_ STATE PROJECT NO 12345-6789  
 FAP NO NA  
 WPI NO 1234567 COUNTY Tropic DESIGNER Giddens  
 NO EXISTING LANES 4 SCOPE OF WORK Resurface

Calculate the peak hour traffic volume (V)

$$V = ATC \underline{30000} \times P/D \underline{0.083} \times D \underline{0.55} \times PSCF \underline{1.20} \times RTF \underline{1.00} = \underline{1643}$$

#### LANE CLOSURE CAPACITY TABLE

Capacity© of an Existing 2 Lane-Converted to 2 Way, 1 Lane = 1400VPH  
 Capacity© of an Existing 4 Lane-Converted to 1 Way, 1 Lane = 1800VPH  
 Capacity© of an Existing 6 Lane-Converted to 1 Way, 2 Lane = 3600VPH

Factors restricting Capacity

TLW 11 LC 6 WZL NA for 4L G/C 0.74

Calculate the Restricted Capacity (RC) at the Lane Closure Site by multiplying the appropriate 2L, 4L, or 6L Capacity © from the Table above by the Obstruction Factor (OF) and the Work Zone Factor (WZF) If the Lane Closure is through or within 600 ft of a signalized intersection, multiply the RC by the G/C Ratio

$$RC \text{ (Open Road)} = C \underline{1800} \times OF \underline{0.96} \times WZF \underline{1.00} = \underline{2817}$$

$$RC \text{ (Signalized)} = RC \text{ (Open Road)} \underline{1728} \times G/C \underline{0.74} = \underline{1279}$$

If  $V \leq RC$ , there is no restriction on Lane Closure

If  $V > RC$ , calculate the hourly percentage of ADT at which Lane Closure will be permitted

$$\% = \frac{RC \text{ (Open Road)} \underline{1728}}{ATC \underline{30000}} = \underline{8.73} \%$$

$$ATC \underline{30000} \times D \underline{0.55} \times PSCF \underline{1.20} \times RTF \underline{1.00}$$

$$\text{Signalized \%} = \text{Open Road \%} \underline{8.73} \times G/C \underline{0.74} = \underline{6.46}$$

Plot 24 hour traffic to determine when Lane Closure permitted (See Exhibit 10-A, Sheet 5 of 11)

**NOTE** For Existing 2 Lane Roadways, D = 1.00

Work Zone Factor (WZF) applies only to 2 Lane Roadways

For RTF < 1.00, briefly describe alternate route NA

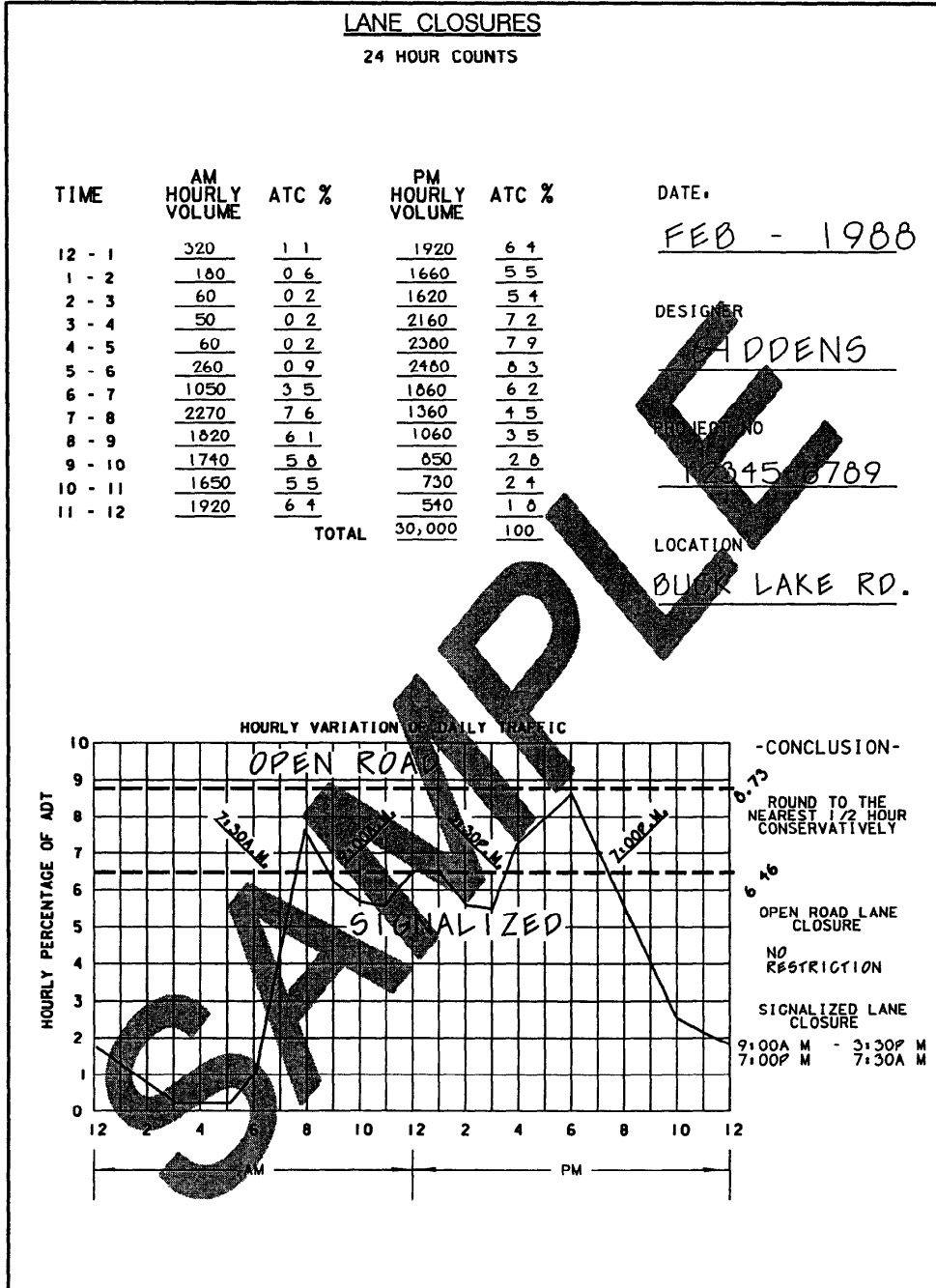

Exhibit 10-A, Sheet 9 of 11

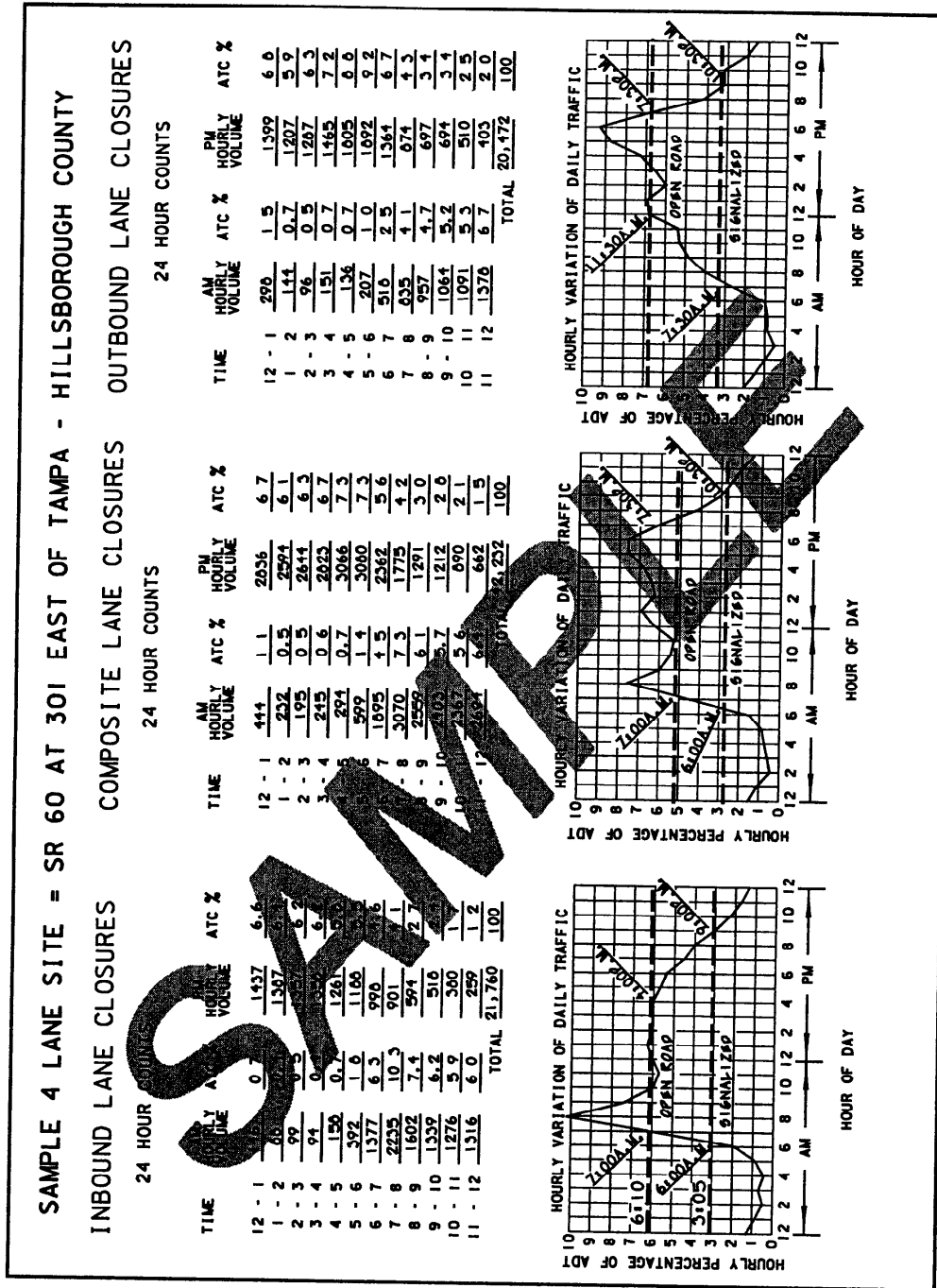

Exhibit 10-A, Sheet 10 of 11



<b>LANE CLOSURE WORKSHEET SUMMARY</b>			
<b>LANE SAMPLE WITH SIGNIFICANT AM-PM PEAKS</b>			
<b>SAMPLES = INBOUND (WB), COMPOSITE (EB &amp; WB), OUTBOUND (EB)</b>			
<b>SITE = SR 60 @ US 301 EAST OF TAMPA, HILLSBOROUGH CO.</b>			
<b>COMPONENT</b>	<b>INBOUND</b>	<b>COMPOSITE</b>	<b>OUTBOUND</b>
ADT	21 760	42 232	20 472
P/D	0 103	0 073	0 092
D	1 00	0 60	1 00
PSCF	1 17	1 17	1 17
RTF	1 00	1 00	1 00
V	2622	2 64	2203
TLW	12	12	12
LC	0	0	0
C	1800	1800	1800
OF	0 86	0 86	0 86
RC (OPEN ROAD)	1548	1548	1548
G/C	0 50	0 50	0 50
RC (SIGNAL)	774	774	774
% OPEN ROAD	6 10	5 20	6 50
% SIGNAL	3 05	2 60	3 25
LANE CLOSURE (OPEN ROAD)	7 00 A M 4:00 P M	7 00 A M 7 30 P M	11 30 A M 7 30 P M
LANE CLOSURE (SIGNAL)	6 00 A M 9:00 P M	6 00 A M 10 30 P M	7 30 A M 10 30 P M

Exhibit 10-A, Sheet 11 of 11

## 10.14.8 Detours, Diversions, & Lane Shifts

A **detour** is the redirection of traffic onto an alternate route, using state roads, county roads, or city streets, to bypass the work zone. A **diversion** is a special detour onto a temporary roadway adjacent to the existing or permanent roadway. A **lane shift** is the redirection of traffic onto a section of the permanent roadway or shoulder.

Detour signing is usually done under the direction of the traffic engineer who has authority over the roadway to be used. The detour should be signed clearly so drivers can traverse the entire detour and return to the original roadway. When detours are required, the geometry of the detour route should be compared against the type of traffic being routed through the detour. For example, detouring of traffic which includes large trucks will require certain pavement widths, turning radius, and overhead clearance (including low power lines, span wires, and low hanging tree limbs). The structural capacity of the detour pavement should also be considered.

The designer has two methods of paying for diversions: by (1) using the "special detour" lump sum pay item or (2) using the lump sum Maintenance of Traffic (MOT) pay item. When the special detour pay item is used, the work and quantities included for pay under the item are to be tabulated and noted in the plans. The special detour pay item is intended to be used in all situations where traffic is shifted one lane width or more onto temporary pavement.

A Diversion, which is to be signed as a lane shift, will be paid for under Special Detour, Pay Item 102-2 (Lump Sum). The *Basis of Estimates Handbook* should be referenced to make sure that the appropriate items are included in this lump sum.

TCPs shall include sufficient detail for diversion geometry. Diversions should be designed with shoulders (2 ft min) whenever practical. The radius of curvature and taper lengths shall be shown. Diversions should be designed and operated as close to the normal speed as possible. When speed reductions are necessary, the reduction should be in 5 mph increments. The recommended minimum radius of curvature (without superelevation) for diversions is shown in **Table 10.14.2**.

## 10.14.9 Above Ground Hazards

An above ground hazard is anything that is greater than 4 inches in height and is firm and unyielding or doesn't meet breakaway requirements. For treatment of an above ground hazard, see the *Roadway and Traffic Design Standards, Index 600*.

## 10.14.10 Drop-offs in Work Zones

Acceptable warning and barrier devices for traffic control at drop-offs in work areas are detailed in the *Roadway and Traffic Design Standards, Index 600*.

The designer should anticipate dropoffs which are likely to occur during construction and provide the appropriate devices. For those projects where barrier wall would be needed and yet it is not practical, such as highly developed urban areas where numerous driveways exist, the designer should consider adding plan notes that require conditions be returned to acceptable grade by the end of the day's operation.

### **10.14.11 Narrow Bridges and Roadways**

Simultaneously working on both sides of a bridge (bridge widening, etc ) Or roadway may be hazardous due to the narrow widths of some bridges and roads Consideration should be given to specifying that work be done only on one side at a time, particularly on high speed roadways In some situations, the installation of barrier wall on both shoulders can totally eliminate any shoulder or refuge area The designer should consider whether or not this restriction of the effective width is acceptable and consistent with the desired operational ability of the facility

### **10.14.12 Existing Highway Lighting**

If the project has existing roadway lighting, the designer shall prepare a specification that completely describes what is to be done with the existing lighting during all phases of construction Give detailed information on any poles that have to be relocated or any new conduit or conductors that would have to be installed A field survey should be conducted to establish the condition of the existing system and what responsibility the contractor will have in bringing the existing lighting system back to an acceptable condition

The designer should use the appropriate pay items and quantities for all work to be done for maintaining existing lighting throughout construction

### **10.14.13 Work Area Access**

The TCP may need to include a work area access plan, if necessary This is a constructability issue in which the designer addresses the question of how the contractor is to get materials and equipment into the work area safely This is a particularly critical issue on high speed facilities (such as the Interstate) where barrier wall is used to protect median work areas Some consideration may be given to the design and construction of temporary acceleration and deceleration lanes for the construction equipment.

### **10.14.14 Railroads**

Railroad crossings that are affected by a construction project must be evaluated to ensure that the Traffic Control Plan does not cause queuing of traffic across the railroad tracks Evaluate the Plan's signal timing, tapers, lane closures and distance to intersections as compared to projected peak traffic volumes The effects of the traffic control plan on interconnected traffic signals and railroad signals must be evaluated to avoid conflicting or ineffective signal controls

### **10.14.15 Pay Items and Quantities**

The ***Basis of Estimates Handbook*** has been updated to provide better instructions on calculating many of the MOT quantities

## 10.15 Speed Zoning

### 10.15.1 Regulatory Speeds in Work Zones

Regulatory speeds should be established to route vehicles safely through the work zone as close to normal highway speed as possible. Traffic Control Plans (TCPs) for all projects must include specific regulatory speeds for each phase of work. This can either be the posted speed or a reduced speed. The speed shall be noted in the TCPs; this includes indicating the existing speed if no reduction is made. By virtue of **Florida Statute 316.187**, all regulatory speeds must be established on the basis of a traffic and engineering investigation. Designers should only reduce speed when the temporary geometry requires it. The justification for establishing work zone regulatory speeds different from normal speed limits must be included in the project file. The TCP and the project file will suffice as the traffic and engineering investigation.

When field conditions warrant speed reductions different from those shown in the TCP, the contractor may submit to the project engineer for approval by the Department, a signed and sealed study to justify the need for further reducing the posted speed or the engineer may request the District Traffic Operations Engineer (DTOE) to investigate the need. It will not be necessary for the DTOE to issue regulations for regulatory speeds in work zones due to the revised provisions of **Florida Statute 316.0745(2)(b)**.

Regulatory speed signs in rural areas (Interstate and Non-Interstate) are to be preceded by a "Reduce Speed Ahead" sign positioned as follows:

- Interstate (Rural) - 1000 ft in advance
- Non-Interstate (Rural) - 500 ft in advance

Urban areas, ordinarily do not require an advance sign, however, the sign may be included at the designer's option.

The "Regulatory Speed" and "Reduce Speed Ahead" signs are to be paid for under the pay item for Construction Work Zone Signs (per each per day).

If the existing regulatory speed is to be used, consideration should be given to supplementing the existing signs when the construction work zone is between existing regulatory speed signs. For projects where the reduced speed conditions exist for greater than 1 mile in rural areas (Non-Interstate) and on Rural or Urban Interstate, additional regulatory speed signs are to be placed at no more than 1 mile intervals. Engineering judgement should be used in the placement of additional signs. For urban situations (Non-Interstate), additional regulatory speed signs are to be placed at a maximum of 1000 ft apart.

The regulatory speed should not be reduced more than 10 mph below the posted speed, and never below the minimum statutory speed for the class of facility, without the approval of the District Traffic Operations Engineer and the appropriate District Director. (See the

***Roadway and Traffic Design Standards, Index 600).***

To ensure credibility with motorists and enforcement agencies, temporary regulatory speed signs shall be removed or covered as soon as the conditions requiring the reduced speed no longer exist. Once they are removed or covered, the speed existing prior to construction will automatically go back into effect unless new speed limit signing is provided for in the plans. On projects with interspaced work activities (such as interstate resurfacing) speed reductions should be located in proximity to those activities which merit a reduced speed, and not “blanketed” for the entire project.

**The TCP phase notes shall indicate when to remove the regulatory reduced speed limit signs.**

When the regulatory speed is changed in a work zone, the permanent speed limit signs are to be removed or covered during the period when the work zone regulatory speed zones are in effect.

## **10.16 Law Enforcement Services**

Work zones may require law enforcement services to protect both the workers and motorists during construction or maintenance activities. The need for these services should be considered during the development of the Traffic Control Plans. The service needed could involve On-duty FHP for speed enforcement, Off-duty law enforcement for traffic control, or a combination of the two.

A contractual agreement between the FDOT and the Florida Department of Highway Safety and Motor Vehicles (DHSMV) was entered into for the use of On-duty FHP to exclusively enforce the speed limit in specified work zones (REF Contract #B-8970).

Off-duty law enforcement services are to be used for traffic control only. The Off-duty law enforcement officers may be acquired from local law enforcement agencies or by the hire-back of Off-duty Florida Highway Patrol officers. Such Off-duty law enforcement services shall not include patrolling or speed enforcement. It should never be assumed that the presence of Off-duty law enforcement will deter speeding. The use of Off-duty law enforcement may be called for on a project which also uses On-duty FHP.

### **10.16.1 Use of On-Duty FHP**

The Department has determined that construction or maintenance activities on limited access facilities that divert, restrict, or significantly impair vehicular movement through work zones may require patrolling of On-duty FHP specifically for speed enforcement to provide a safer environment for both workers and motorists. Speed enforcement by On-duty FHP may also be warranted, for the safety of the motorists, through some work zones during times when construction or maintenance activities are not in progress.

Conditions on limited access facilities to consider for the use of On-duty FHP may include, but not be limited to

- a work zone requiring reduced speeds
- work zones where barrier wall is used adjacent to through traffic
- night time work zones
- areas with intense commuter use where peak hour traffic will require speed enforcement
- a work zone in which workers are exposed to nearby high speed traffic
- work zones similar to the ***Roadway and Traffic Design Standards, Indexes 609, 613, 616, and 651*** as they would apply to limited access facilities

### **10.16.2 Use of Off-Duty Law Enforcement**

There are certain construction activities that impede traffic flows such that supplemental **traffic control** is desirable. Uniformed law enforcement officers are respected by motorists, therefore, it may be in the best interest of the situation to utilize Off-duty law enforcement officer(s) as a supplement to traffic control devices to assist the motorists and provide a safer work zone.

Conditions to consider for the use of Off-duty law enforcement may include, but not be limited to

- work within high use signalized intersections
- high volume urban roadways with lane closures during peak hour traffic
- any work zone in highly congested urban areas, including areas where traffic is in close proximity to construction workers and equipment

### **10.16.3 Coordination, Documentation and Payment**

On each individual project, the designer and/or the project manager shall coordinate with the district construction office to determine if law enforcement services will be justified. On limited access projects, the associated FHP Troop commander shall also be included in the coordination.

Once the determination has been made that law enforcement will be used on a project, the designer/project manager and the construction engineer shall develop supporting documentation for each MOT phase including the conditions requiring the law enforcement services, the number of personnel, the man-hours, and any other requirements that may be established. The supporting documentation for On-duty FHP

and Off-duty law enforcement will be kept separate

The documentation for On-duty FHP will be shown in the Computation Book only and there will be no reference made to these services in the plans except as shown on the CES

On-duty FHP can be used on non-limited access highways provided that the District Director of Operations has approved its use

On-duty FHP will be paid for under pay item 999-1

For Off-duty law enforcement, the TCP shall clearly indicate the intended use of the officer(s) during each phase of construction, the need for the service, the number of officers needed, and the required man-hours. Off-duty law enforcement will be paid for under pay item or 102-10. Complete documentation that complies with the TCP shall be included in the Computation Book.

The initial coordination between the designer/project manager and construction shall take place prior to Phase II. The final determination of man-hours and final documentation shall be accomplished at the same time that construction days are set.

#### **10.16.4 Other Uses of Law Enforcement**

The contractor may choose to use law enforcement services beyond the details of the TCP for situations that assist with mobilization, de-mobilization, MOT set-up, and other instances where he prefers the use of law enforcement.

The contractor is responsible for the coordination of these uses and will be included under the Lump Sum Maintenance of Traffic pay item. These contractor required services are not to be included in the Department's contract pay items for law enforcement services.

## Chapter 11

### STORM WATER POLLUTION PREVENTION PLAN

11 1	General	11-1
11 2	Narrative Description	11-2
11.2.1	Sight Description	11-3
11.2.2	Controls	11-3
11 2.3	Maintenance, Inspection and Non-Storm Water Discharges	11-4
11 3	Site Map	11-4
11.4	Summary of Quantities	11-5



## Chapter 11

### STORM WATER POLLUTION PREVENTION PLAN

#### 11.1 General

A Storm Water Pollution Prevention Plan (SWPPP) shall be developed as part of the contract plans for each FDOT construction project site that disturbs two or more hectares of total land area and that discharges to waters of the United States

The site specific SWPPP is a requirement of the Florida General Permit issued and made effective by the Environmental Protection Agency (EPA) on April 3, 1998. In order to use the General Permit the FDOT must

- 1 Prepare a plan that assures compliance with the terms and conditions of the General Permit, which includes the State of Florida Department of Environmental Protection (DEP) requirements. This includes obtaining a storm water quality permit, if appropriate
- 2 File a Notice of Intent (NOI) which documents our intent to be authorized as a permittee under the terms and conditions of the General Permit

The SWPPP will be prepared by the responsible design engineer under the direction of the District Design Engineer or the District Consultant Project Management Supervisor (if this person reports directly to the Director of Production). The SWPPP will be prepared in consultation with Drainage, Construction and Environmental personnel, as required.

Distribution of the NOI, SWPPP and signed certification statements will be in accordance with Environmental Management procedures.

The objectives of the SWPPP are to

- Prevent erosion where construction activities are occurring
- Prevent pollutants from mixing with storm water
- Prevent pollutants from being discharged by trapping them on-site, before they can affect the receiving waters

The SWPPP consists of three major phases listed below. The first two (2) are performed during the design phase and are a joint effort between design, construction, and other departments, as necessary. The third is the responsibility of Construction and the contractor.

- 1 Site evaluation and characterization
- 2 Assessment, selection/description of control measures and design details to address the objectives
- 3 Implementation of actions, schedules and design details

The SWPPP will include a narrative description, outlined in Section 11.2, and a site map, described in Section 11.3. Additional information can be found in the **FDOT Erosion and Sediment Control Handbook** and in workshop training material.

## 11.2 Narrative Description

The SWPPP shall identify potential sources of pollution which may reasonably be expected to affect the quality of storm water discharges from the construction site. In addition, the SWPPP shall describe and ensure the implementation of practices which will be used to reduce the pollutants in storm water discharges and assure compliance with the terms and conditions of the General Permit.

Prepare the SWPPP narrative on 8.5" X 11" paper to be included in the specifications package or as a series of notes on a plan sheet (sheets). Use the following outline to prepare the narrative.

### Storm Water Pollution Prevention Plan

- 1 Site Description
  - a Nature of Construction Activity
  - b Sequence of Major Soil Disturbing Activities
  - c Area Estimates
  - d Runoff Data
  - e Site Map
  - f Receiving Waters

- 2 Controls

- a Erosion and Sediment Controls
    - (1) Stabilization Practices
    - (2) Structural Practices
  - b Storm Water Management
  - c Other Controls
    - (1) Waste Disposal
    - (2) Off-Site Vehicle Tracking
    - (3) State or Local Regulations
    - (4) Application of Fertilizers and Pesticides
    - (5) Toxic Substances
  - d State and Local Plans
- 3 Maintenance
  - 4 Inspection
  - 5 Non-Storm Water Discharges

When the narrative is included in the specifications, the cover sheet of the narrative shall be sealed. When the narrative is included as plan sheets, each sheet shall be sealed.

### **11.2.1 Site Description**

The SWPPP shall provide a description of the site, construction activities, and potential pollutant sources. The area estimates shall include the total project area and the area expected to be disturbed. The runoff data shall include the rational runoff coefficient before, during, and after construction, the drainage area for each outfall, and existing data describing the soil or the quality of discharge from the site. The narrative discussion of the site map is discussed in **Section 11.3**. The location of each outfall, in terms of latitude and longitude, shall be given to the nearest 15 seconds. The name of the receiving waters for each outfall shall be given, as well as the wetland area on the site.

### **11.2.2 Controls**

The SWPPP shall include a description of the controls that will be implemented at the construction site. For each of the major activities identified in Part 1 b of the site description narrative, describe the timing of the implementation of control measures during the construction process. Also describe the storm water management measures that will be installed during construction to control pollutants in the storm water discharges that will occur after

construction

The narrative for some of the other controls will be supplied by the contractor at the pre-construction conference. A plan for off-site vehicle tracking is an exception and must be included in the SWPPP prepared during design.

Any Water Management District or Local Water Management permits obtained in connection with the project should be noted.

### **11.2.3 Maintenance, Inspection and Non-Storm Water Discharges**

Include a description of any maintenance requirements that are not stated in the standard specifications. Include the inspection requirements, which will be either requirements of EPA or the applicable requirements of another regulatory agency, whichever is more stringent. If special procedures have been developed to minimize turbidity associated with normal construction dewatering, include a description of those procedures.

## **11.3 Site Map**

The following information shall be shown on a site map:

- Drainage patterns
- Approximate slopes
- Areas of soil disturbance
- Areas that may not be disturbed
- Locations of major controls identified in the plan
- Areas that are to be stabilized against erosion
- Surface waters (including wetlands)
- Locations where storm water is discharged to a surface water

There are three methods that may be used to develop the required site map:

- 1 Use the construction plans as the site map
- 2 Use the construction plans with some additional special sheets
- 3 Prepare a site map separately from the construction plans

All the information required above is shown in a typical set of construction plans except the drainage patterns and the locations of major temporary controls. If an optional Drainage Map is included in the construction plans, then the drainage patterns will also be shown. Use method two or three if the Drainage Map is not included.

Method One can be used if the Drainage Maps are included and the major temporary controls are shown somewhere in the construction plans. The preferred location to show the controls is on the Maintenance of Traffic (MOT) sheets. If the MOT sheets are not adequate, then the controls may be shown on the Plan and Profile sheets. If they are not adequate or are too cluttered, then use method two or three.

Method Two uses special sheets to show information required by the General Permit that is not shown any other place in the construction plans. This will usually be the locations of the controls and the drainage patterns. Use a plan view with baseline information and sufficient topo to locate the controls.

Method Three will be used when Plan and Profile sheets are not prepared for the project. A topographic map or aerial photo must be prepared as a base for the site map. Maps of the vicinity of the site may be available from the local government or the Water Management District. As a last resort, a USGS quadrangle map may be used as the base map.

The narrative description of the site map (part 1 e of the outline) shall describe the option chosen for the site map. If options 1 or 2 are chosen, the narrative shall list the construction plan sheet numbers where the site map information required by the General Permit can be found.

Regardless of the method used to prepare the site map, details should be prepared for all controls that are not detailed in the Roadway and Traffic Design Standards. The details should show the work intended, where and how the control is to be placed, and any other special design details required. Any Technical Special Provisions required by the erosion control items of work should be prepared as part of the specifications package.

## **11.4 Summary of Quantities**

The Summary of Quantities - Erosion Control items shall be prepared to document what, where and how much material and work is required for the contractor to implement all phases of the Plan. These items shall be input to the CES with the regular roadway quantities.



## Chapter 12

### RIGHT OF WAY

#### 12.1 General

To assist the roadway designer's understanding of right of way (R/W) requirements which must be addressed during the project development and design phases of projects, the following terms are briefly defined as an introduction

**Right of Way** is real property or an interest therein, donated or acquired by purchase or condemnation, to accommodate transportation improvements. Fee simple is the strongest interest available to the Department and is sought for most permanent highway facilities. When improvements are designed which will fall outside of the existing R/W boundaries, additional lands must be identified and acquired. All necessary right of way and easements must be in Department ownership prior to advertisement of the project for letting.

**Limited Access R/W** is purchased for facilities such as Interstate and Expressways. This limits public access to interchange connection-points designed with entrance and exit ramps and limits access to motorized vehicular traffic. Pedestrians and bicycles are restricted in the interest of traffic capacity and safety.

**Controlled Access R/W** is acquired for the remaining State Highway System. This permits the general public and land owners along the corridors reasonable access, but in a controlled pattern that will facilitate the movement of through traffic.

**Perpetual Easements** (perpetual right of use over, under or through the property of another) are used when permanent structures or improvements are to be constructed and maintained on parcels where acquisition of fee title would be impractical, i.e., when acquisition of the fee would cause excessive severance damages due to green area or setback requirements or where underground structures are to be constructed which will not impair the surface utility of the land. A sight triangle or drainage facility are examples of features that may require a perpetual easement. Condemnation powers may be utilized to acquire necessary perpetual easements.

**Temporary Easements** (a temporary right of use over, under or through the property of another) are used when it is necessary to temporarily occupy a parcel for a specific purpose such as construction of temporary detours, stock piling materials or parking equipment. No improvement which requires maintenance by the Department beyond the term of the easement can be constructed on a temporary easement.

**License Agreements** (permission to do a particular thing which without the license would not be allowable) are used to gain access to adjoining properties for sloping, grading, tying in, harmonizing and reconnecting existing features of the licensor's property with the highway improvements to be constructed. This work is solely for the benefit of the property.

owner The Department does not compensate for license agreements. If the owner refuses to execute the agreement, the Department will not perform the work.

Licenses are included here as real property interests for convenience, but they are not real property interests. A license, with respect to real property, is a privilege to go on the premises for a certain purpose but does not vest any title in the licensee.

## **12.2 Procedures for Establishing R/W Requirements**

The procedures for addressing R/W requirements require engineering analyses, economic comparisons and professional judgements. Consultation with the District R/W Surveyor and District R/W Manager is required. One excellent method of providing the consultation is the "R/W Partnering" concept with all parties that have a vested interest participating in the decision making process.

### **12.2.1 Open Cut and Fill Roadway Sections**

R/W requirements along the project boundaries are dictated by the actual construction limits plus a reasonable maintenance buffer. The roadway cut and fill slopes, drainage ditch slopes and other construction elements are used to define the construction limits, which are generally shown on the roadway cross sections. R/W requirements are determined by reviewing the plotted cross sections after the roadway and drainage design elements have been established and major revisions are highly unlikely.

The procedures should, at this point, include a joint review of the proposed R/W, including a field review if necessary. The design details and the property information must be reviewed by the designer, personnel from the R/W Office and the R/W Mapping Office. This review should be scheduled during the Phase II design process as defined in this manual and should address such issues as:

- 1 Will additional R/W be required for project access or maintenance of the facility? Check pond sites, high embankment slopes, bridges, outfalls, canals and similar sites.
- 2 Can acquisitions be avoided or design modified to avoid substantial damages to remainder property or businesses? Examples include designing retaining walls or by adjusting slopes or grades to reduce the difference in elevation between the remainder and the project grade at the R/W line.
- 3 Can the roadway grades be revised or connections relocated so access to the remainders can be constructed without damaging the use of the remainder, thereby minimizing or avoiding severance and business damages caused by altering the access?
- 4 Can drainage facilities (outfalls, ponds, ditches, etc.) be maintained without



- additional R/W space? Can uneconomic remainders be used for storm water treatment?
- 5 Check the suitability and cost effectiveness of stormwater treatment facilities and the status of permit approval
  - 6 What type of legal instruments are likely to be required to secure the appropriate property rights for the project?
  - 7 Review the status of R/W activities by others in the project area. Avoid multiple acquisitions from the same owner at ramp terminals, intersections and by future FDOT projects
  - 8 Check for potentials of hazardous materials, "4F" parcels, utility easements, landlocked remainders and parcels which could be eliminated
  - 9 Check for acquisitions involving existing treatment systems which could be mitigated within the FDOT system
  - 10 Discuss the possibility of advance acquisition of any parcel where development is imminent
  - 11 Check for incidental work which will fall outside of R/W such as trenching, wall forms, or equipment maneuvering space
  - 12 Check for availability of offsite property owned by FDOT which could be used for mitigation sites
  - 13 Discuss status of any R/W being claimed by maintenance pursuant to Section 95 361 F S (Maintenance Statute)

### **12.2.2 Curb and Gutter Roadway Sections**

Establishing R/W requirements in urban sections will generally follow very similar procedures as the open roadway section projects. The analysis and decision making is complicated by more property owners, generally higher property values, businesses and more complex access management problems.

The roadway and drainage design must be developed to a point where all major elements of the project (including signalization poles, lighting poles and overhead sign foundations) are firmly fixed. On projects with sidewalks and driveway connections, the design elements can be accurately established ONLY if proper survey data has been obtained for the designer's use. Profile elevations along the proposed R/W line and back of sidewalk and half-sections or profiles at each driveway location should be obtained as a minimum standard practice.

The design engineer must perform the design work required to establish the project profile grades and the back of sidewalk grades to minimize the grade differences at the R/W line.

Areas of superelevation must be analyzed very carefully. Split profile grades or other design strategies may be required to accommodate the proposed construction of the facility within minimum R/W limits.

The developed drainage and roadway design elements should be plotted on the plan sheets and the cross sections, which will establish the preliminary R/W requirements along the project boundaries as indicated by the construction limits. A good quality control review and a joint review with R/W appraisers and R/W Mapping personnel at this time will assist in determining the final R/W requirements. The same issues listed earlier in these procedures should be addressed.

The design engineer cannot assume the property owner's intentions or disposition with respect to his property. The designer must design the highway facility within the existing R/W or request acquisition of R/W to accommodate the project elements. The most economical means of constructing the project should always be the objective. Alternate design studies will be required in many locations to determine if additional R/W should be purchased, a retaining wall constructed or modified slopes and barrier system should be considered. A reasonable estimate of R/W costs or damages expected must be obtained from the R/W Office in order to make such a design study. Alternate construction methods may be shown on the plans as preferred and alternate methods.

### 12.2.3 Access Management

Access to the Department's facilities is an important element of the design and R/W determination procedures. Access Management is discussed in **Chapter 1, Section 1.8** of this manual. The designer must understand and follow the **Access Management Rules (14-96 and 14-97)** and the procedures and directives adopted (**Topic Numbers 625-010-020 and 625-010-021**) to implement the objectives of those rules. Identification of access and median opening location in relation to individual parcels should be completed before appraisal.

The following activities should be accomplished by the Designer:

1. The access classification of the roadway segment and the connection category of the driveways must be determined. The designer must be aware of the nature, type, frequency of trips and number of vehicles utilizing the driveway.
2. The designer must make a determination as to which driveways are in conformance, which are to be maintained, which are to be closed and which are to be modified to bring them into compliance.
3. The designer must obtain sufficient field survey data to establish the highway grades, horizontal alignment and the existing ground elevations in the vicinity of the driveway location. The data necessary to accurately design the driveway.

connection and determine an acceptable tie-in with the existing surface should be obtained as a minimum

- 4 The designer should develop the most economical driveway design which will conform to the standards and the requirements of the access management objectives. Alternate designs and locations may be required to meet the property needs. Generally, the best option can be reached by negotiating with the property owner and/or tenant in a give and take atmosphere.

Driveway connections must be addressed in consultation with R/W personnel, generally appraisers or review appraisers. This fact should not be overlooked on projects such as resurfacing, etc. on which there may not be any other R/W requirements. R/W related decisions to be made about driveway connections, probably on a case by case basis, include

- 1 If the driveway can be harmonized without impacting the value or the utility of the property, the Department should make a good faith offer to provide a suitable connection, at FDOT expense, in exchange for the permission to enter the land during construction for the purpose of doing the construction.
- 2 If providing the driveway connection reduces the remainder value or utility of the property and no other acquisition of that property is contemplated for the project, a temporary easement will be requested and shown on the plans. The Office of R/W will see that the proper instruments are executed to enter onto the property for purposes of construction and to compensate the owner for damages, if any are due. If other acquisition of that property is proposed, these instruments should include the entry and compensation, if any, for the driveway.
- 3 If it can not be determined during design that the harmonization work will reduce the remainder value or utility of the property, the owner can negotiate or claim damages through inverse condemnation during construction. This is not a desirable position for the Department, therefore the decision to employ this approach should be carefully considered.
- 4 Design should always, in their consultation with R/W personnel, make a determination if a fee taking or permanent easement is in the public interest to protect the facility. If a permanent easement will protect the facility and still give the owner some utility in the easement area, this may reduce the severance and business damages incurred.

#### **12.2.4 Procedures for Decision Making**

To assist in the decision process related to R/W requirements and instruments to be used the following guidelines from the Office of Right of Way may be used during the joint review process

- 1 License agreements should be used only if the following conditions can be met
  - The improvements or changes contemplated are minor in nature and are for the benefit of the property owner,
  - No compensation will be offered to the property owner,
  - None of the improvements are required for the construction of the transportation facility and removal of, or change to the improvements will not be detrimental to the facility,
  - The property owner is or will be fully informed of the nature and extent of the proposed improvements and has no objections, and,
  - The transportation facility can be constructed without adverse impact on safety or operation
- 2 Temporary Easements should be used under the following conditions
  - Where grading, tying in and harmonizing are necessary to avoid or minimize damage to the property,
  - The contemplated improvements or uses of the property owner's land are required only during the period of construction of the transportation facility,
  - The changes or improvements to the property owner's land are temporary and removal or alteration of the improvements subsequent to construction would not be detrimental to the facility, and,
  - After construction is complete, there will be no need for periodic re-entry onto the property for maintenance or other purposes
- 3 Fee Simple R/W purchase should be used when the following conditions exist
  - The planned improvements to the property owner's land are required as a part of construction of the transportation facility,
  - The improvement on that land must remain in place as a part of the facility, and,
  - Periodic re-entry to the property is required for maintenance or repair
- 4 Perpetual Easements may be considered as an alternative to fee simple purchase in the R/W process if the owner may continue to enjoy some benefits of the property without impairing the Department's use and the total acquisition costs to the Department are less than the cost of acquiring fee

### **12.2.5 Transmittal of R/W Requirements**

R/W requirements should be finalized before transmitting them to the R/W Mapping Office for preparation of R/W maps. All R/W requirement transmittals should be in writing and clearly indicate in the memo and on the plans which parcels have been finalized and which parcels are still pending. An effort should be made to transmit final R/W requirements in usable segments. Priority should be given to the major, expensive or complex acquisitions that are going to require more time to acquire and complete the relocation of the occupants. Advanced design effort and final R/W requirement determination may expedite meeting production ready dates. It is desirable to transmit requirements as early as possible in the plans development.

All R/W requirements that are firm (primarily mainline construction limits) should be transmitted by Phase II. All other requirements that generally involve more detailed design completion (i.e., outfalls, pond locations, corner clips, access needs, etc.) must be submitted by the Phase III stage completion of the roadway design plans.

All R/W requirements must be transmitted by the completion of the Phase III roadway design plans.

### **12.3 Process for Establishing Right of Way Requirements**

Establishing right of way requirements is a design process, but requires close coordination with other functions that have input to the project development and design of the project.

The Engineer of Record is responsible and must ensure that representatives from the appropriate functional areas are involved in the determination process. They must also ensure that a review of the final R/W requirements is performed. The "R/W Partnering" concept is an excellent method of ensuring that the proper consultation and input is received.

Generally, the R/W needs-determination will involve Roadway, Bridge and Drainage Design, Permits, Utilities, R/W appraisers, R/W Mapping and Legal functions. On consultant designed projects, the project manager's role as lead coordinator is especially critical.

#### **12.3.1 New or Major Reconstruction Projects**

These projects generally have Project Development and Environmental (P D & E) activities and Right of Way activities identified in the Work Program.

The project development process must address R/W requirements and perform sufficient preliminary engineering design to obtain preliminary cost estimates from the R/W Office. This may require that the P D & E consultant or in-house scope of services include work

such as

- 1 Preliminary roadway grades & geometric design
- 2 Conceptual Drainage design and layout
- 3 Analysis of major access management issues
- 4 R/W Survey, property lines and limited Topo
- 5 R/W Mapping and property research activities
- 6 Preliminary R/W cost estimates work

This early identification of potential R/W requirements, approximate costs and work effort to complete R/W activities will greatly improve both cost estimates and schedules of projects. Also, involving R/W mapping and appraisers will assist in developing better project alternatives.

R/W requirements identified during the project development phase should not be considered firmly set. The R/W Office cannot be requested to begin R/W mapping or appraisal activities based on these requirements, without extraordinary efforts by the designer to support the acquisition process as in advance acquisition.

### **12.3.2 Reconstruction Projects With Anticipated R/W Requirements**

These projects may not have a formal P D & E study, but they were determined during Work Program development to require some R/W acquisition. Most projects will require some environmental re-evaluation effort and all projects should have some preliminary engineering to better define objectives, scope and R/W requirements. The following general process, as it relates to R/W requirements should be established by design.

#### **PHASE I**

- 1 R/W Mapping will provide preliminary maps showing properties and all existing R/W lines for the project. These should be requested by the designer or by the project manager, on consultant projects.
- 2 The roadway designer will define project horizontal and vertical alignment and relate the existing R/W lines to the project as necessary to set R/W limits.

#### **PHASE II**

- 1 The roadway designer will identify proposed R/W requirements as indicated by the completed design details such as the following:
  - Limits of construction slopes for roadway and bridges
  - Cross section elements, ditches, curb returns and sidewalks
  - Driveway and street connections

- 2 The drainage designer will identify proposed R/W requirements as indicated by the completed drainage features
  - Retention or Detention Ponds
  - Mitigation of environmental issues
  - Drainage outfalls, sediment basins, etc

The designer will review all proposed R/W requirements with the R/W Mapping Office. This should be performed during the Phase II design activities in order to make decisions on how each parcel of proposed R/W will be acquired. These decisions will impact which design approach is taken. The issues to be discussed and decisions to be considered are detailed in **Section 12.2** of these procedures.

- 3 As R/W requirements are determined, the information is furnished to the R/W Mapping Office by memo documenting clearly which R/W is final and which is pending. The R/W Mapping Office will use only the final requirements transmitted to prepare R/W maps. See **Section 12.2.5**.

### **PHASE III**

- 1 By the completion of Phase III design, all R/W requirements will be identified and transmitted to the R/W Mapping Office.
- 2 After transmittal of final R/W requirements to the R/W Mapping Office, design changes that affect R/W must be coordinated with the R/W Mapping Office, in a timely manner.

**The R/W shown on the roadway plans must be in exact agreement with the R/W Maps.**

It is essential that close coordination be maintained with R/W personnel in order to ensure that design changes affecting R/W are transmitted promptly.

### **12.3.3 Projects Without an Identified R/W Phase**

Many improvements to highway projects are intended to be accomplished within the existing R/W. The widening or widening and resurfacing projects are examples. Such projects must be evaluated very carefully and very early in the roadway design process.

The addition of R/W requirements can have a tremendous impact on the schedule and on the anticipated costs of a highway improvement project.

R/W Mapping should be consulted on all projects to ensure that the proposed construction lies completely within the existing R/W and no Trustees of the Internal Improvement Trust Fund parcels or maintenance surveys are required.

For all projects determined to be completely within existing R/W the project manager or

District R/W Surveyor as appropriate, shall notify the District R/W Manager, in writing, that no R/W is required. This notification will serve as the basis for the District R/W Manager's certification that all necessary R/W is available for construction.

If unanticipated R/W requirements are identified during design, the production management staff and the R/W Mapping Office should be notified as soon as the requirements are determined. The production management staff will then give direction as to continuing with the design and acquisition. If acquisition continues, it will follow the previously discussed procedures.



### Figure 12.3.3 R/W Requirements Generalized Process Flow Diagram

(Each function must have well defined written procedures for the development, quality control, coordination and regular exchange of product evaluation )

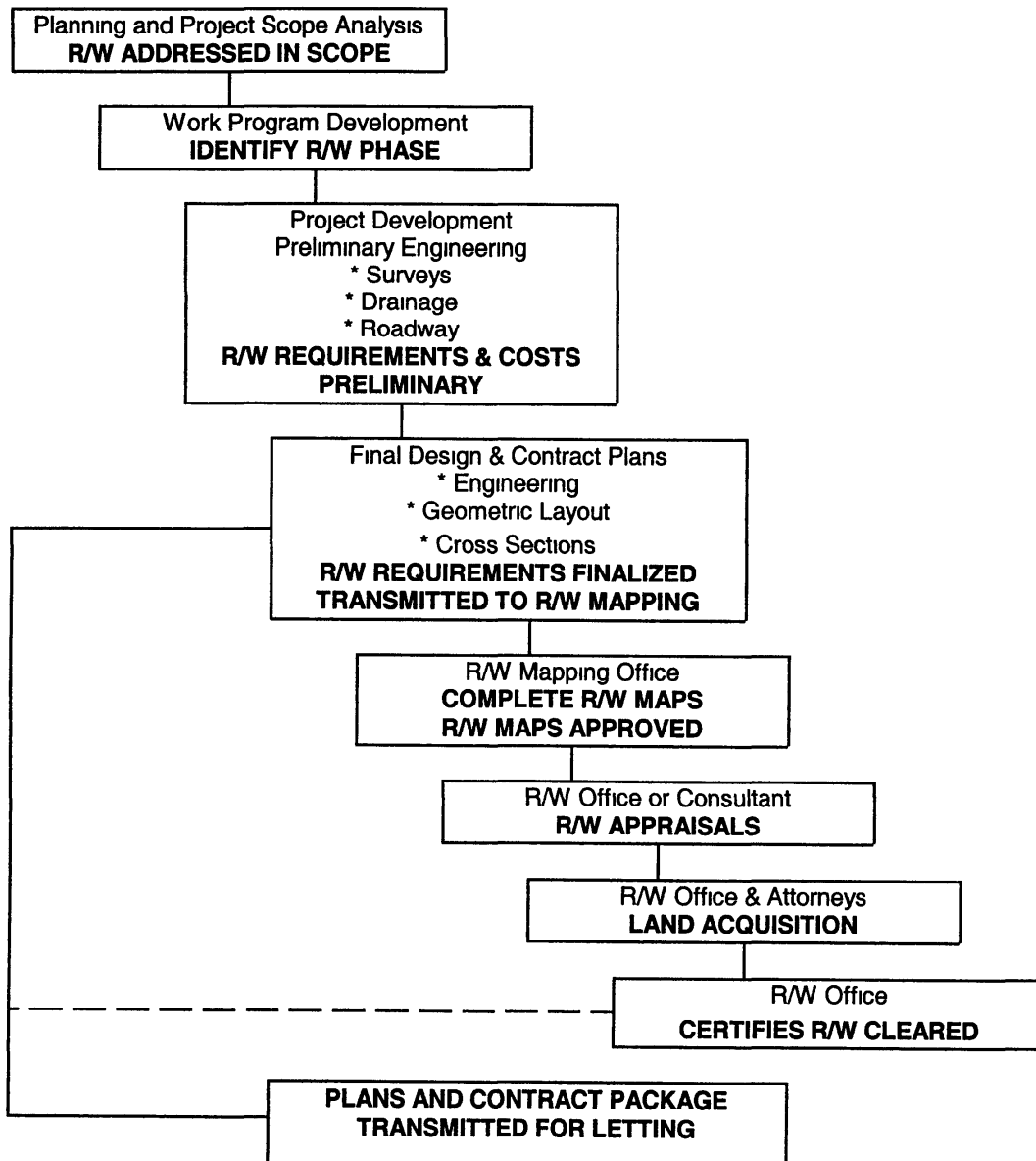

---

## Chapter 13

### INITIAL ENGINEERING DESIGN PROCESS

13.1	General .....	13-1
13.2	Initial Engineering Design (Phase I) .....	13-1
13.3	Scope, Objectives, Schedule and Budget .....	13-2
13.4	Project Design Controls and Standards .....	13-3
13.5	Support Services .....	13-4
13.5.1	Aviation Office Coordination .....	13-5
13.5.2	Projects Involving Bridges With Lead Based Paint ..	13-5
13.6	Preliminary Geometry, Grades, and Cross Sections .....	13-6

## MAJOR ACTIVITIES - INITIAL ENGINEERING DESIGN PROCESS

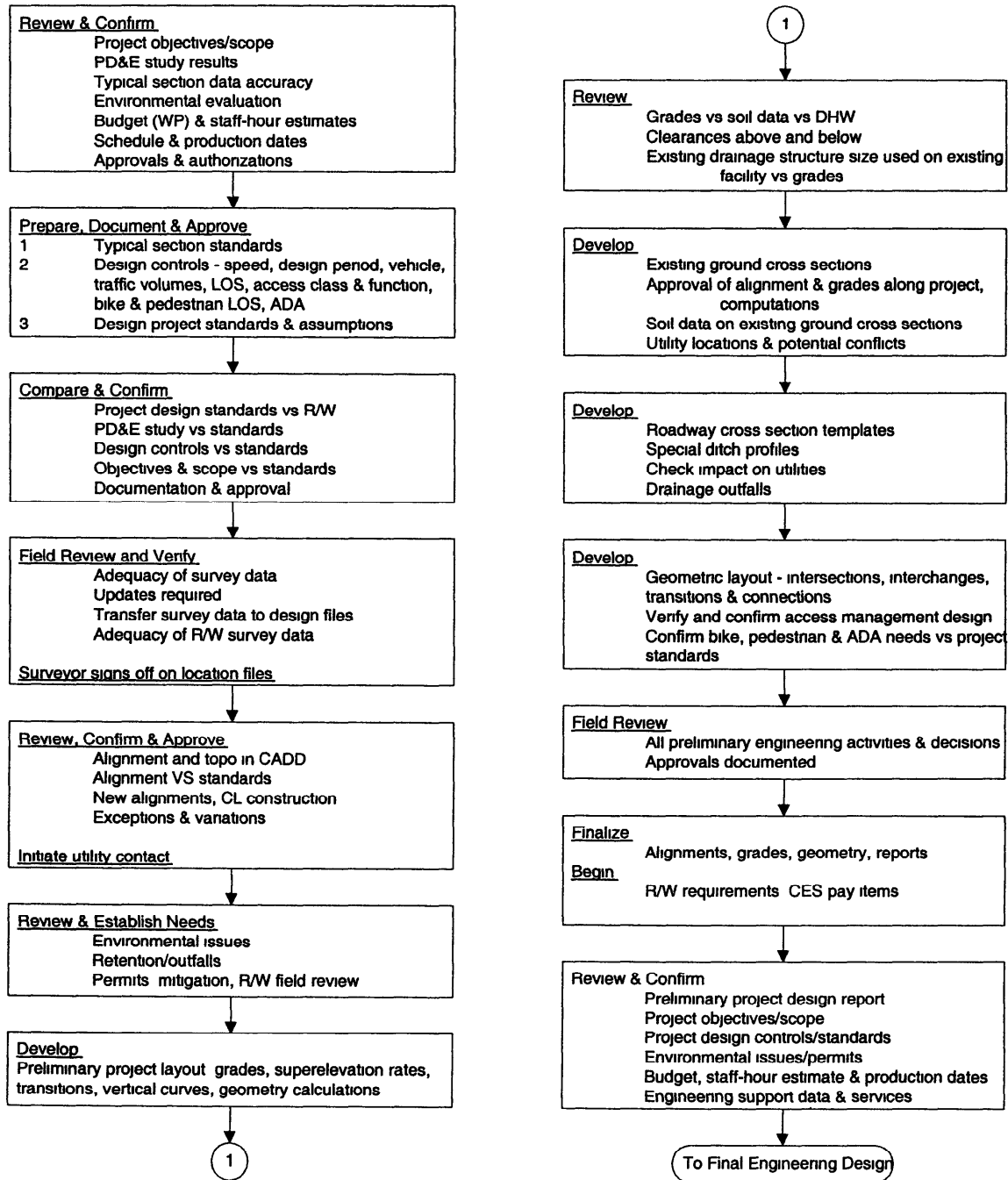

## Chapter 13

### INITIAL ENGINEERING DESIGN PROCESS

#### 13.1 General

The engineering design process (Final Design Phase), as discussed in this and following chapters, is the development and contract preparation phase of highway construction projects. It begins with the approval of the Project Location/Design and ends with the construction letting. It also includes the update process when the construction plans and specifications are ready and on hold in the district and require revising to make them contract ready. Throughout this design process, quality control will be exercised by those responsible for the engineering design and plans preparation activities by having a plan-do-check routine for each and every significant task or operation.

The engineering and design activities and the schedules depend on the type of project and the required effort to accomplish the desired objectives. Projects can be designated as three basic types:

- **New Construction** - A highway or bridge project along a new corridor on new alignments, horizontal and vertical
- **Add Lanes and Reconstruct** - A highway project along an existing facility to add lanes, widen or add bridges, improve intersections, and, in general, upgrade and improve the capacity and safety of the facility
- **Other Projects** - May include Resurfacing, Restoration and Rehabilitation (RRR), Local Agency Program (LAP), or other projects such as a highway and/or enhancement projects - A highway and/or bridge project undertaken to extend the service life of an existing facility and to enhance the safety of the facility. These projects generally do not require a PD&E phase. The scopes are so varied that it is difficult to define them, except project by project. They can vary in magnitude from installing highway lighting for enhanced safety or resurfacing pavement to extend the service life, to minor lane and shoulder widening, bridge rail modification or intersection improvements. These projects may also include bike paths, sidewalks and landscaping projects.

#### 13.2 Initial Engineering Design (Phase I)

It is important to distinguish the initial engineering design activities from planning and the preliminary engineering done during the Project Development (PD&E) phase. If a PD&E

phase has been completed, some of the activities discussed here may have been performed to varying levels during that phase. The information contained in the preliminary engineering report should be considered as the starting point for the initial engineering phase. In the case where there was not a PD&E phase, the initial engineering design activities must establish the project scope, controls and standards, R/W needs, and major design elements necessary to determine that we have a viable project and R/W can be cleared.

**Generally**, the initial engineering process **should** accomplish or complete the following activities:

- Completely and fully define and document the objectives of the project and the scope of activities to accomplish them. This will almost always require an on-site review.
- Develop and document a realistic staff-hour estimate and production schedule to accomplish the scope of activities identified.
- Establish and document the design controls, assumptions, project design standards, exceptions, and variations. Significant changes to previously approved PD&E elements may result in a re-evaluation of the environmental document. Discuss with the District Environmental Office.
- Identify and document additional engineering and support services.
- Determine and document the structural design requirements.
- Determine and document if R/W is required.
- Establish and document the review procedure and number of submittals, if different from guidelines provided in this manual.
- Establish preliminary geometry, grades, and cross sections.

### **13.3 Scope, Objectives, Schedule and Budget**

The project manager and other FDOT managers are responsible for the development, review and approval of the project objectives, scope of work, and schedule in accordance with the ***Project Management Guidelines***. They also must verify that required funds are in the work program.

The project objectives and scope are best confirmed and/or completed by

1. Reviewing the PD&E study recommendations, conclusions and commitments, if they exist.
2. Performing a field review of the project with the project manager and personnel.

- from other FDOT offices, such as Roadway Design, Traffic Operations, Safety, R/W Engineering, Utilities, Maintenance and Construction, as appropriate
- 3 Requesting a review of the draft scope of services activities by FDOT offices, such as maintenance, construction, design, traffic operations, access management, etc
  - 4 Developing the scope of services sufficient to advertise for professional services  
After the scope of services is completed and approved, the schedule and budget may be confirmed and/or updated by the engineer/project manager and approved by the appropriate district manager
  - 5 After consultant selection or in-house assignment, the designer or consultant should review and confirm the scope by completing steps one through four above

### **13.4 Project Design Controls and Standards**

Among the activities the Engineer of Record will accomplish on a project are the identification of the given design controls and the selection of the appropriate design standards. These will be documented in the project file(s).

The design controls as addressed in this manual and AASHTO include such things as design speed, design vehicle, design period, traffic volume and service level, functional classification of the corridor, the access class, and other factors that control the selection of project standards that will ensure the facility will function safely at the level desired and expected by the motorists.

Establishing the project standards is one of the first requirements of the engineering design process. The decisions, assumptions and calculations for the design are based on these factors. All project standards shall be documented in the project file(s).

The preliminary engineering report (PD&E) or concept report may include some of the controls and standards to be used on the project. These values should be reviewed, confirmed as valid and consistent with the overall corridor or system, and documented. Significant changes to approved PD&E elements of design may require a re-evaluation of the environmental document.

If project standards must be used that do not meet recommended values, these must be documented and receive approval/concurrence by the appropriate FDOT and/or FHWA engineer. These are either exceptions or variations as described in **Chapter 23** of this manual and must be maintained in the project file(s).

When all project standards are selected, documented, and agreed upon, the engineer should get the District Design Engineer to concur that the appropriate standards are being

used The Typical Section package will include some of the project standards Those not included, and all known exception/variation justification shall be documented in the project file(s)

### **13.5 Support Services**

Any information or support services that have been provided must be reviewed by the Engineer of Record to determine the completeness of the information Conditions and data may have changed drastically if they are not current

Technical data required for the design of a roadway project can be available from various sources, such as

- Surveys - design, topographical, aerial, drainage, right of way location, soil, utilities
- Traffic Data
- Pavement Design
- Environmental Documents
- Original Plans
- Accident Data
- Access Management Classification

During the design process, the project will require coordination with different sections or departments When engineering decisions, information, or other support services are required from FDOT functional areas, it is the project manager's responsibility to coordinate and facilitate the request and expedite a timely response The functional areas include

- |                                |                             |
|--------------------------------|-----------------------------|
| • Planning and Programs        | • Right Of Way              |
| • Surveying and Mapping        | • FHWA                      |
| • Traffic Plans                | • Value Engineering         |
| • Geotechnical                 | • Traffic Operations        |
| • Drainage                     | • Environmental Mgmt Office |
| • Maintenance                  | • Access Management         |
| • Construction                 | • Structures                |
| • Utilities                    | • Safety                    |
| • Estimates and Specifications | • Plans Review              |

### **13.5.1 Aviation Office Coordination**

Federal law requires that notice of construction must go to the Federal Aviation Administration (FAA) under the following circumstances

- 1 Any construction or alteration or associated construction equipment of more than 200 feet in height above the ground level at its site, or
- 2 Any construction or alteration of greater height than an imaginary surface extending outward and upward at 1 to 100 for a horizontal distance of 20,000 feet from the nearest point of the nearest runway of any public or military airport

For assistance, contact

F D O T Aviation Office  
605 Suwannee Street, M S 46  
Tallahassee, FL 32399-0450  
(850) 414-4500 SC 994-4500

### **13.5.2 Projects Involving Bridges With Lead Based Paint**

For a project which involves the repair, repainting or replacement of a steel bridge which contains lead based paint, the Design Project Manager shall contact the State Corrosion Engineer in the State Materials Office to determine if the bridge contains lead or other hazardous elements. The State Corrosion Engineer will furnish a site specific specification for disposition of the lead based paint waste for that particular project.

The Design Project Manager must provide the site specific specification to the Engineer of Record who is preparing the contract plans and specifications. The Engineer of Record must ensure that the project specifications conform to the site specific specifications and that they prohibit the use of lead based paint. A mandatory pre-bid conference is not required unless special conditions exist and the district determines one is needed.

The Design Project Manager shall notify the Contracts office (State or District) that the project requires the contractor to show proof of qualification before receipt of the bid proposal if 51% or more of the project is painting or at the time of award if less than 51% of the project is painting. The Contractor must have a QP2 Category A certification, from the Society of Protective Coatings (SSPC), for painting projects. For structure removal projects, consult with the Construction Office (State or District) to determine if QP2 Category A certification will be required, or a less stringent qualification. The contractor will be required to present proof of qualification prior to beginning any structure removal work and not at award. Qualifications for both painting and structure removal projects must



be noted in the advertisement and specification

### **13.6 Preliminary Geometry, Grades, and Cross Sections**

To establish geometry, grades, and cross-sections, the following activities should be accomplished or near completion

- Supporting data such as surveys, traffic and pavement evaluation data
- Typical sections and pavement design
- Standards, variations and exceptions
- PD&E and environmental commitments addressed and if necessary, re-evaluation
- Need for R/W phase addressed
- Utility initial contact and survey data

The initial engineering design activities to establish the preliminary project plans are

- Set and calculate the horizontal alignment
- Set the proposed profile grade lines
- Develop preliminary cross sections at selected intervals or control locations
- Develop preliminary layout of roadway, intersections, interchanges, transitions, and connections
- Field review all proposed preliminary engineering layout and decisions for conflicts, R/W needs, connections, updates and additional needs

The initial engineering review (Phase I) is used to obtain confirmation and approval of the objectives, scope, standards, decisions, and assumptions to be used as the basis for the engineering and design. The Engineer now has the decisions and direction necessary to perform final engineering. If this is not the case, the necessary initial engineering activities must be accomplished before continuing to the final design process.

The results of the above activities should be that

- Structures can now be given the horizontal and vertical alignment and clearance requirements for bridges
- R/W Engineering can be furnished with mainline R/W requirements for the project
- Plan and profile sheets can be clipped
- Traffic plans development can be initiated
- Cross sections, grades and alignments, as required, can be provided to the drainage section

- Work sheets, as needed, can be provided to the permits section for initial evaluation
- Utility owners can be provided plans, profiles and cross sections as required to identify/verify and designate their existing utilities
- The CES pay item listing can be initiated by identifying the items of work involved at this point

## **Chapter 14**

### **FINAL ENGINEERING DESIGN PROCESS**

14.1	General	14-1
14.2	Final Engineering Design	14-1
14.3	Contract Plans Preparation	14-2
14.4	Specifications and Special Provisions	14-3
14.5	Pay Items and Summaries of Quantities	14-3
14.6	Assemble Contract Plans Package	14-3

MAJOR ACTIVITIES

FINAL ENGINEERING DESIGN PROCESS

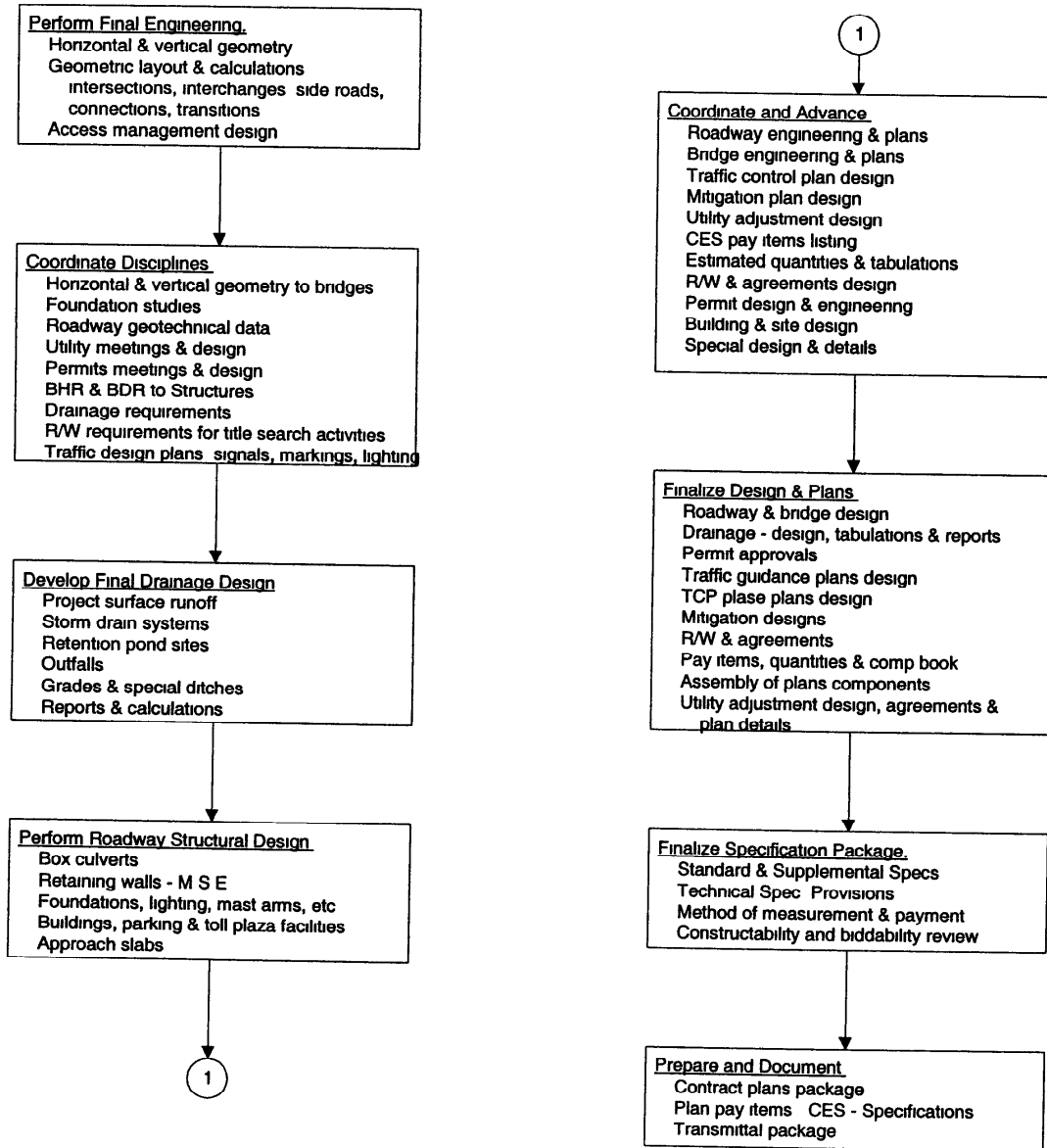

## Chapter 14

### FINAL ENGINEERING DESIGN PROCESS

#### 14.1 General

The final engineering design process follows the initial engineering design process and review (see **Chapters 13** and **16**) The final engineering design phase should be roughly 50% of the total effort The primary objective of the final engineering design phase is to prepare contract plans and specifications that can be used to bid and construct the project with a minimum of field changes, delays, and cost overruns

#### 14.2 Final Engineering Design

The Engineer and Project Manager must coordinate all activities to ensure that the quality, accuracy, and appropriate decisions go into the performance of each step The project quality control should include a plan-do-check routine for each set of activities or operations

The major design activities include, but are not limited to, the following

- Pavement design
- Drainage design
- Structural (bridge) design
- Structural (roadway) design
- Roadway design including access management, earthwork, geometrics, etc
- Traffic plans design including signing, marking, signals, lighting, etc
- Utility adjustment design
- Permit preparation design including ponds, mitigation, etc
- Traffic control plans (work zone) design
- R/W requirements design
- Building and site design including landscaping, ADA, etc
- Estimates and computation book preparation

- Specifications and special provisions
- Landscaping design

Project stationing information is to be checked and entered into the Work Program Administration (WPA) system during final engineering design. This information is important for tying construction records, such as material coring, sampling and testing to other databases. The information is entered by stations which are related to roadway mile post for later information retrieval.

The project designer is responsible for finalizing the project stationing. The District Design Engineer should designate an individual to be responsible for coordinating the input of stationing information into the WPA system.

The station equations and begin/end stations are entered into the WPATS27A computer screen under IMS on DOTNET. Update access to this screen is granted through the Work Program Development Office in Tallahassee. While entering the station information, it is important to check to see if the mile post limits in WPA are still accurate. This can be accomplished by reviewing the WPATS27A computer screen. If the project length has changed, the District Work Program Office should be advised to correct the mile posts.

This information will become increasingly important as Geographic Information Systems increase in use and project locations are automatically mapped based on mile post limits.

### **14.3 Contract Plans Preparation**

The outcomes of the engineering design activities are component sets of contract plans developed using CADD. The major component sets may include:

- Roadway
- Signing and Pavement Marking
- Signalization
- Lighting
- Landscape
- Utility Joint Participation Agreement Plans
- Architectural Plans
- Structures Plans

These component sets, the specifications package, and the CES pay item listing and

quantities are assembled and packaged as the construction contract letting documents

#### **14.4 Specifications and Special Provisions**

The Engineer of Record must develop engineering designs that can be constructed, controlled, measured and paid for under the current edition of the FDOT Standard Specifications for Road and Bridge Construction. In the event the work required is not covered by the standard specifications or the supplements and special provisions thereto, the Engineer must develop Technical Special Provisions to be made part of the contract for this project. The Engineer can obtain Department procedural guidance to assist with the preparation.

#### **14.5 Pay Items and Summaries of Quantities**

As the engineering plans and specifications are prepared, the quantities are calculated, tabulated, and summarized by Pay Item (of work) as stipulated by specifications and the Basis of Estimates Handbook. The Contract Estimating System (CES) is updated as quantities are determined and summarized.

#### **14.6 Assemble Contract Plans Package**

The completed plans, specifications, and District estimate are transmitted to the central office for letting or they are assembled and held in the district for district advertisement and letting. **Chapter 20** of this manual provides further guidance on the contents of the transmittal.

## **Chapter 15**

### **UPDATE ENGINEERING DESIGN PROCESS**

15.1	General . . . . .	15-1
15.2	Design Update Review and Decision Process . . . . .	15-1
15.3	Updating Engineering Design and Documents . . . . .	15-2
15.4	Revised Contract Plans Package . . . . .	15-2



## MAJOR ACTIVITIES

### UPDATE ENGINEERING DESIGN PROCESS

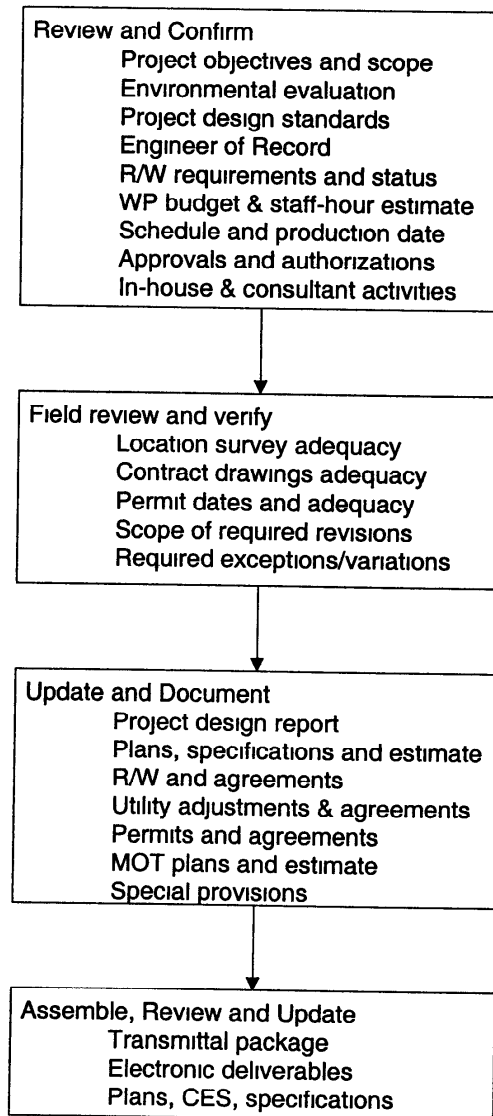

## Chapter 15

### UPDATE ENGINEERING DESIGN PROCESS

#### 15.1 General

The update engineering design process begins when a final contract plans, specification and estimates (PS&E) package has been on the shelf for any significant period (approximately nine months). The update process depends on the type of project, the adequacy and appropriateness of the original design controls and standards, and the original scope and objectives. The extent of the update process should be determined based on both engineering and management input.

#### 15.2 Design Update Review and Decision Process

An engineering review of the PS&E and proposed contract documents must be made to determine the activities required to update the package and get it ready for letting.

- The original project objectives, scope and standards must be reviewed and compared with current corridor conditions, as well as growth rate and patterns, to determine if the project design is still valid.
- Original environmental evaluations and commitments must be weighed against current requirements.
- Permit date and terms must be weighed against current requirements.
- R/W certifications and agreements must be reviewed and the status of documents confirmed.
- Contract plans must be reviewed for current requirements, including standard indexes, specifications, pay items and design criteria.
- Agreements with outside entities such as utility owners, maintaining agencies and local agencies must be reviewed.

If the decision is that engineering updates are required, the scope, staff-hour estimate, schedule, cost estimate, and other activities described in **Chapter 13** of this manual should be followed to the extent necessary to define the scope and schedule for the update process.

### **15.3 Updating Engineering Design and Documents**

The actual engineering design activities necessary to update the plans package will vary from project to project. They must be fully described in the professional services contract, if one is to be used. If done in-house, a fully defined scope of work must be developed to determine resources and schedule needed for the update.

All reports, calculations, assumptions, and engineering decisions that support the changes to plans, specifications, or other documents must be signed and sealed by the Engineer updating the engineering plans, specifications and documents. All changes to the plans must be approved by the responsible engineer in charge of the work and receive the concurrence of the District Design Engineer, Structures Design Engineer, or Consultant Project Management Engineer, as appropriate for the type of change. Updated documentation of all approvals and concurrences shall be in the project file.

### **15.4 Revised Contract Plans Package**

In addition to the required engineering changes which may be necessary, the contract transmittal package must be reviewed and updated to current status.

- All component plans sets are made current and sealed
- Specifications and special provisions are made current
- The CADD electronic files are revised
- The CES, computation book, and pay item summaries are made current
- The contract file is made current

## Chapter 16

### DESIGN SUBMITTALS

16.1	General . . . . .	16-1
16.2	Design Documentation Submittals . . . . .	16-4
16.2.1	Field Survey Data . . . . .	16-4
16.2.2	Project Traffic . . . . .	16-4
16.2.3	Typical Section Package . . . . .	16-5
16.2.4	Preliminary Drainage Design . . . . .	16-9
16.2.5	Preliminary Geometry and Grades . . . . .	16-9
16.2.6	Preliminary Traffic Control Plan . . . . .	16-9
16.2.7	Pavement Selection and Design . . . . .	16-10
16.2.8	Preliminary Utilities . . . . .	16-10
16.3	Structures Submittals . . . . .	16-10
16.3.1	Request for Structural Design (Bridges and Retaining Walls) . . . . .	16-10
16.3.2	Bridges . . . . .	16-11
16.3.3	Other Structural Submittals and Reviews . . . . .	16-11
16.4	Plans Phase Reviews . . . . .	16-12
Exhibit A	List of Requests and Contacts . . . . .	16-2
Exhibit B	Typical Section Package . . . . .	16-14

## **Chapter 16**

### **DESIGN SUBMITTALS**

#### **16.1 General**

The design process will require various submittals to transfer technical information and decisions between the Engineer of Record (EOR), certain Department personnel, and functional areas. The Project Manager is responsible for the adequacy of the submittals or requests and for the coordination of reviews between the Department and the EOR. Each office head including the District Construction and Maintenance Engineers should assume direct responsibility for assigning reviewers and meeting the review schedules. To the extent practical, the contract scope of work should list the information to be furnished by FDOT functional areas and submittals (number and type) required of the EOR. **Exhibit A** is a partial list of functional areas with typical submittals and requests.

## EXHIBIT A - List of Requests and Contacts

During the design process, various items of information may be required from different sections or departments. The following is a list of some of those items and their source.

### A) Planning

Request pavement design (18 Kip ESAL)  
Request project traffic  
Request turning movements for intersections  
Request updates of project traffic (as needed)  
Railroad contact (Phase I and III)  
Plans transmittal letter data (railroad)  
Notification that project is in vicinity of a traffic monitoring site

### B) Traffic Plans/Traffic Operations

Request turns and counts for intersection design  
Notification that project includes milling  
Signing & pavement marking plans (Phase I, II, III)  
Traffic signal plans (Phase I, II, III) & signal warrant  
Lighting plans (Phase I, II) & justification report  
Pedestrian and bicycle project traffic  
Safety/crash analysis and recommendations  
Operational and capacity review of design plans

### C) Geotechnical

Request pavement design soil information  
Request roadway soil survey  
Soils data  
Request foundation investigations  
Request dynaflect testing  
Phase III review, if unsuitable soils exist  
Soils and foundation recommendations  
PH and soils resistivity for culvert material selection  
Request pavement composition and milling recommendations  
Review if any changes are made in alignment, grade or typical section  
Bridge Geotechnical Report

### D) Surveying and Mapping

Request survey

### E) Drainage

Request grade and high water review  
Conceptual drainage plan & assumptions  
Bridge Hydraulics Report  
Request drainage design  
Request final drainage review  
Permit review  
SWPPP  
Erosion Control Plan

### F) Maintenance

Pavement design comments  
Phase I Plans review & response  
Phase II Plans review & response  
Phase III Plans review & response

### G) Construction

Pavement design comments  
Phase I Plans review & response  
Phase II Plans review (constructability) & response  
Phase III Plans review (biddability) & response  
Submit traffic control plan request  
Contract time

### H) R/W Surveying and Mapping

Submit title search request  
Request existing right-of-way maps  
Transmit right-of-way requirements  
Final right-of-way check  
Plans transmittal letter data

### I) Utilities

Preliminary (First) contact (Phase I)  
Pre-Design conference and contact (Phase II)  
Final contact (Phase III)  
Horizontal and vertical verification of utilities  
Plans transmittal letter data (utilities)  
Number of sets of final prints for utility companies

**J) Estimates and Specifications**

Preliminary estimate (LRE)  
Preliminary estimate (Phase I)  
Preliminary estimate (Phase II)  
Preliminary estimate (Phase III)  
Complete estimate (Phase IV)

**K) Right-Of-Way Department**

Project schedule updates as needed  
R/W estimates as needed  
Pre-Proposal appraisal conference  
Field questions from R/W agents as needed  
Plans transmittal letter data  
Phase I Plans Review (by Appraiser)  
Phase II Plans Review (by Appraiser)  
Phase III Plans Review (by Appraiser)  
Phase IV Plans Review (by Appraiser)

**L) FHWA (if not exempt)**

Phase I Plans review & response  
Phase II Plans review & response  
Phase III Plans review & response  
Phase IV Plans review & response  
Submit for typical section approval  
Submit for pavement design approval  
Submit exception request letters  
R/W review

**M) Value Engineering (\$2,000,000+)**

Phase I & II reviews

**N) Environmental**

Hazardous waste determination  
SWPPP  
Erosion Control Plan  
Mitigation Plans

**O) Materials**

Environmental Classifications  
Type of Structural Steel (existing)  
Existence of Lead-Based Paint

**P) Bridge**

Phase I, Bridge Analysis, review & response  
Phase II Plans review & response  
BDR/30% Plans review and response  
60% Plans review & response  
90% Plans review & response  
100% Plans review & response

## **16.2 Design Documentation Submittals**

During the engineering processes there is the need to submit information to specific Department personnel for the purpose of making timely decisions and confirming the project objectives. Preferably these submittals will take place as these activities are completed so that issues do not go unresolved before subsequent activities begin. The following are some submittals that should take place during initial engineering. Ideally these engineering type submittals should be done in lieu of traditional phase plans reviews.

### **16.2.1 Field Survey Data**

The following are typical field survey data which should be evaluated by the designer for sufficient breadth and accuracy to complete the proposed design.

- Design location survey data including horizontal and vertical control, alignments, reference points, utilities, natural and manmade features, and topography or general shape of the terrain
- Digitized aerial survey data, especially for large areas such as drainage maps
- Drainage design survey data from site inspection and historical records
- Right of Way and related property (land) survey data, including property owners and acreage
- Geotechnical studies and foundation and soils report, including physical properties and classifications of soils, together with recommendations related to foundations, pavement and drainage design
- Bridge data sheet surveys, channel alignment survey data and bathymetric data

### **16.2.2 Project Traffic**

In the development of roadway plans, project traffic is primarily used to justify the number of through lanes, geometric improvements to intersections, traffic signal timings, and pavement design. The number of through lanes is usually determined during the project development phase, based on Average Annual Daily Traffic (AADT) and factors included in the typical section. Vehicular traffic data provided in the plans typical section includes AADT for the current year, opening year and the design year. Also included are the design hour factor (K is the proportion of AADT occurring during the 30th highest hour of the year), the directional distribution (D is the percent of two way peak hour traffic that occurs in the



peak direction), and truck factors (T is the percent that trucks constitute of vehicular traffic) for the peak hour and a 24 hour period. The source and methods used to produce this data must be documented.

Intersection improvements and signal timings require additional information on turning volumes. The ***FDOT Project Traffic Forecasting Procedure*** describes the input data required, explains the procedure to forecast turning volumes, and provides examples. A Project Traffic Report may be required. Manual and mechanical counts provide input on the number of vehicles and pedestrians using an intersection. At proposed (non-existing) major intersections, turning volumes are estimated using transportation planning models or other means. Forecasts provide designers the information required to determine the need for turning lanes, turning bay length, signal timings, and pedestrian crossings. Also, the designer establishes right-of-way requirements based on documented needs to satisfy design year volumes.

In pavement design, the designer requires AADT forecasts for the year a project opens to traffic and for the design year. AADT, together with percent trucks (24 hour period) and other factors used by the Department, provides information on the pavement loadings used in pavement design. The ***FDOT Project Traffic Forecasting Procedure*** provides additional information.

### **16.2.3 Typical Section Package**

All projects which add or alter cross section elements, and all resurfacing projects, require the preparation and concurrence of a typical section package.

The typical section package shall be prepared and sealed by the responsible engineer.

The typical section package is the instrument for formal review and concurrence of the proposed project cross sectional elements by the appropriate FDOT District Design Engineer. Review and concurrence of the typical section package by the FHWA Transportation Engineer is required on projects which have FHWA oversight (see **Chapter 24** for determination of FHWA oversight).

The purpose of the typical section package review and approval process is to

- Establish typical transverse geometry
- Consider safety related issues
- Ensure compatibility between the bridge typical section and the roadway typical section

The typical section package consists of a Project Controls Sheet and Project Identification/

**Proposed Typical Section Sheet** The Project Identification/ Proposed Typical Section Sheet should not be confused with the Typical Section Plan Sheet which is part of the Contract Plans Set and is discussed in **Volume II, Chapter 6** The Project Controls Sheet contains the project data which serves as a basis for selecting criteria and establishing project standards for cross-sectional elements The Project Identification/Proposed Typical Section Sheet contains data which uniquely identifies the project, a detail of the proposed typical cross section with critical dimensions and cross sectional elements labeled, and signature blocks

Usually, Project Identification/ Proposed Typical Section Sheets will be prepared for the main roadway and bridges However, additional Project Identification/ Proposed Typical Section Sheets shall be required if

- a change in the number of through lanes occurs
- flush shoulders change to curbing or vice versa
- a crossroad which may affect a structure exists
- major work of significant length is being done on an intersecting roadway

Additional Project Identification/ Proposed Typical Section Sheets may be required if

- a change in design speed occurs within the project limits

The proposed typical sections for roadway and bridges are to be submitted by the responsible engineer for concurrence by the District Design Engineer Coordination with the District Structures Design Engineer is also required on all bridge typical sections The roadway and bridge typical sections shall be submitted together to ensure compatibility

The typical section package for both roadway and bridges shall be approved as part of the Project Development & Environmental (PD&E) process Typical section package preparation, and coordination between the responsible PD&E engineer and the District Design Engineer, must occur during the development of project alternatives prior to preferred alternative selection The responsible PD&E engineer shall prepare, seal and submit the typical section package for concurrence Typical section package concurrence by the District Design Engineer shall be obtained after the preferred alternative is selected A copy of the approved typical section package shall be included as part of the PD&E Final Preliminary Engineering Report

For projects which do not contain a PD&E phase, the typical section package shall be prepared, sealed and submitted by the responsible engineer for concurrence by the District Design Engineer The typical section package should be concurred with prior to the final engineering process

**Exhibit B** contains example typical section package sheets. The following is an outline of the information which is required as part of the typical section package submittal. This information is critical for proper evaluation by the District Design Engineer. Missing information may require a resubmittal of the typical section package.

**The following information is required on the project controls sheet:**

- Financial Project ID
- County
- Project Description
- Functional Classification
- Highway System
- Access Classification
- Traffic Data (AADT, for Current, Opening and Design Year, Design Speed, Posted Speed, K, D and T Factors)
- Potential Exceptions and Variations related to the typical section elements
- List Major Structures Requiring Independent Structures Design (including location and description)
- List Major Utilities within project corridor
- List other information pertinent to the design of the project

**The following information is required on the project identification/proposed typical section sheet:**

**Project Identification:**

- Financial Project ID
- State Project No (If assigned)
- Federal Aid Project No (If assigned)
- Work Program Item (if assigned)
- Road Designation
- County Name
- Limits (In Milepost)
- Project Description

**Proposed Roadway Typical Section Drawing**

- ◆ Design Speed

- ◆ Limits (station limits of the typical section shown if available)
- ◆ Lanes (dimension width, show cross slope of each lane, label bike and HOV lanes)
- ◆ R/W Line (graphically show, label and dimension from centerline const )
- ◆ Shoulder (dimension width, show cross slope, paved shoulder is dimensioned and labeled separately)
- ◆ Curb (graphically show curb, label curb type )
- ◆ Median (dimension width, show slopes, graphically show whether median is typically depressed or raised)
- ◆ Centerline Construction and/or Baseline Survey (graphically show and label)
- ◆ Profile Grade Line (label)
- ◆ Slopes (dimension and label)
- ◆ Border Width (dimension and label for new construction)
- ◆ Ditches (show typical front slope and typical back slope, dimension typical ditch width and depth, and label)
- ◆ Natural Ground Line (graphically show and label)
- ◆ Pavement and Roadbed (graphically show)
- ◆ Barriers (graphically show, dimension, and label)
- ◆ Sidewalk (graphically show, dimension, and label)

**Proposed Structure Typical Section Drawing:**

- ◆ Design Speed
- ◆ Bridge Description w/ Crossing Information
- ◆ Lanes (dimension widths, and show cross slope of each lane, label bike or HOV lanes)
- ◆ R/W Line (graphically show, label and dimension from centerline const )
- ◆ Shoulder (dimension, show cross slope, and label)
- ◆ Gutter (dimension width, and graphically show)
- ◆ Median (dimension width, show slopes, graphically show whether median is typically depressed or raised)
- ◆ Centerline Construction and/or Baseline Survey (graphically show and label)
- ◆ Bridge Deck (graphically show, dimension)
- ◆ Profile Grade Line (label)
- ◆ Barriers (graphically show including railing, dimension width, and label)
- ◆ Sidewalk (graphically show, dimension width, and label)

The typical section package sheets are in the FDOT Engineering CADD Systems Software

#### **16.2.4 Preliminary Drainage Design**

On projects where the drainage design is a critical element the following items should require a preliminary submittal

- Design High Water Report
- Pond Siting Report
- Documentation of preliminary drainage coordination with permitting agencies
- Information that is essential to proper evaluation of drainage design concepts such as seasonal high ground water, soil types, existing cross-drain peak design stages, historical pavement failure, flood plain elevation, present water elevations, drainage areas, etc

#### **16.2.5 Preliminary Geometry and Grades**

On projects where connections to the facility make grades a critical element, back of sidewalk profiles, project profile grades, base clearance above design high water calculations, driveways, and side street geometry should be a required preliminary submittal. The Districts may require the designer to present the project geometry and grade to a geometry and grade technical review team to encourage productive dialogue and proper communication regarding these design issues. If a bridge exists within the project limits, the early input of the structural designer as to approach grades and clearance needs should be coordinated to ensure proper bridge design.

#### **16.2.6 Preliminary Traffic Control Plan**

On projects where the traffic control plan is a critical element the following items should require a preliminary submittal

- Typical sections of each construction phase with information that is essential to proper evaluation of each construction phase such as location and nature of proper construction drainage, regulatory speed, location of work zone, proposed traffic control devices, number, width and location of maintained traffic, maximum drop off, maintenance of existing lighting
- Documentation addressing possible innovative construction techniques, need for temporary detours, hazardous material excavation, temporary structures, etc
- Documentation of coordination with the local community i.e. city and county transportation engineers, businesses, police, hospitals, civic centers or arena

operations, fire department, schools, mass transit, etc

### **16.2.7 Pavement Selection and Design**

The pavement selection and design should be completed as early in the process as possible. The ***Rigid and Flexible Pavement Design Manuals*** are available through the Maps & Publications Section.

### **16.2.8 Preliminary Utilities**

On projects where utility coordination is a critical element the following early involvement activities should be required:

- Before Phase I plans submittal, early involvement can be obtained by coordinating a review of the utility information in the topographic survey. This review may be accomplished by distribution of the topographic survey to all Utility Owners through the District Utility Office for mark-ups and confirmation of existing facilities.
- Once the designer has reviewed the early topographic survey mark-ups a meeting should be held with the Utility Owners, District Utility Office and the designer to discuss errors, omissions, and future plans of the utilities already identified within the corridor. This will allow the designer the ability to prioritize which utilities will ultimately impact his design.

## **16.3 Structures Submittals**

Structures design elements also go through decision-making reviews at various stages of the design as listed below:

### **16.3.1 Coordination of Structural Design - (Bridges and Retaining Walls)**

All requests for structural design should include roadway plan and profile sheets showing horizontal and vertical alignment and cross sections within 500 feet of each end of the bridge or ends of retaining walls. Horizontal curvature that is on or near the end of the bridge or retaining wall must be shown. Non-standard superelevation transition details or other special profiles must be included if any part or all of the transition is on the bridge or wall. The approved typical section is required.

Provisions for access to property near the end of bridges and adjustments to avoid costly right-of-way takings should be resolved

### 16.3.2 Bridges

Bridge design begins when the Phase 1 bridge geotechnical report is complete and proceeds on a schedule which allows simultaneous review of the final (90%) bridge plans and the Phase III roadway plans. All structures design work is coordinated through the District Structures Design Engineer or the State Structures Design Office in the Central Office, depending on the category or complexity of the structure. A typical section of the facility crossing, horizontal and vertical clearances required and the profile grades shall be determined prior to beginning structures design. For complete details and requirements for structural designs and plans preparation, the reader is referred to **Chapter 26** of this manual and the ***Structures Detailing Manual*** issued by the State Structures Design Office.

Generally, the completion and review of bridge designs are accomplished in the following phases:

- BDR/30% Structures Plans
- 60% Structures Plans (Foundation submittal for all Structures and full) (submittal for Category 2 or unusual structures only)
- 90% Structures Plans
- 100% Structures Plans

These reviews should be coordinated with the phase reviews of the roadway plans. The latest set of structural plans shall be submitted with the Phase II roadway plans submittal. This joint submittal at Phase II roadway plans review is to ensure that roadway and bridge structures plans are consistent, i.e., widths, superelevation transitions, vertical and horizontal alignment, and work zone traffic control agree. The precise number and type of plans submittals depends on the complexity of the design and/or the sensitivity of the project. Each submittal shall include written responses to the comments received on the previous submittal.

### 16.3.3 Other Structural Submittals and Reviews

In addition to bridge plans, structures plans may include retaining walls, sheet piling, noise barrier walls, box culverts, pedestrian overpasses, temporary bridges, and special structural appurtenances.

For projects where bridges and other structures plans are involved, preliminary and final plan submittals (usually along with bridge plans) should be handled according to the instructions for structures plans submittals covered in **Chapters 26** and **30** of this manual.

For projects where retaining walls are required along with roadway plans only (no bridge in the project), the Engineer of Record shall follow the procedure outlined in **Chapter 30** of this manual. The submittal of detailed control plans should occur as early in the design process as possible.

Where the District Roadway Office cannot carry out the structural review or verify the review as proper by a consultant, such review may be requested from the District Structures Design Office or the State Structures Design Office.

## **16.4 Plans Phase Reviews**

The number of submittals and phase reviews shall be determined on a project-by-project basis and shall be defined in the scope. Submittals allow functional areas to review the development of the project as contained in the scope.

Formal plans phase review requirements are covered in the District Quality Control Plan. Reviews should include Department personnel that can assist in making timely decisions and confirm that the requirements have been met for their discipline. Ideally, reviews should be driven by the engineering process and should occur when there is a need for input or a decision to complete a critical activity before progressing with the design. Some of these activities are discussed in **Section 16.2** of this chapter. Reviews are complete when the comments from all the various offices have been resolved and have been documented as required in **Chapter 24**.

Constructability and biddability reviews by the District Construction Office shall be included at appropriate stages of the phase review process. Procedures for these reviews are provided in the ***Construction Project Administration Manual (Topic No. 700-000-000)***.

Minor projects, such as resurfacing, should typically have two plans phase reviews. The two reviews should consist of a decision-making phase review on the scope and intent of the project and a final plans phase review for constructability/biddability. One of these will be an on-site review.

On complex projects plans phase reviews may be required at the Phase I, II and III stages and a final check at Phase IV. Two on-site reviews will be required. Generally, one of the site reviews is held early in the initial engineering phase.

**Section 2.3 of Chapter 2, Volume II** of this manual outlines, in detail, the sequence for contract plans preparation and assembly required by the several design phase submittals. Also included in the chapter is information required to be presented on various plan sheets included with each submittal.

When the plans are in compliance with all phase review requirements and are considered final, they are to be submitted in accordance with the process described in **Chapter 20** of this volume.



<b>PROJECT IDENTIFICATION</b>													
<b>FINANCIAL PROJECT ID</b> _____ <b>COUNTY</b> _____													
<b>PROJECT DESCRIPTION</b> _____													
<b>PROJECT CONTROLS</b>													
<p style="text-align: center;"><b><u>FUNCTIONAL CLASSIFICATION</u></b></p> <p>( ) RURAL                      ( ) URBAN                      ( ) FREEWAY/EXPWY      ( ) MAJOR COLL                      ( ) PRINCIPAL ART        ( ) MINOR COLL                      ( ) MINOR ART              ( ) LOCAL</p>	<p style="text-align: center;"><b><u>HIGHWAY SYSTEM</u></b></p> <p>Yes    No                      ( )    ( ) NATIONAL HIGHWAY SYSTEM                      ( )    ( ) FLORIDA INTRASTATE HIGHWAY SYSTEM                      ( )    ( ) STATE HIGHWAY SYSTEM                      ( )    ( ) OFF STATE HIGHWAY SYSTEM</p>												
<p style="text-align: center;"><b><u>ACCESS CLASSIFICATION</u></b></p> <p>( ) 1 - FREEWAY                      ( ) 2 - RESTRICTIVE w/Service Roads                      ( ) 3 - RESTRICTIVE w/660 ft Connecting Spacing                      ( ) 4 - NON-RESTRICTIVE w/2640 ft Signal Spacing                      ( ) 5 - RESTRICTIVE w/440 ft Connection Spacing                      ( ) 6 - NON-RESTRICTIVE w/1320 ft Signal Spacing                      ( ) 7 - BOTH MEDIAN TYPES</p>	<p style="text-align: center;"><b><u>TRAFFIC</u></b></p> <table style="width: 100%; border-collapse: collapse;"> <thead> <tr> <th></th> <th style="text-align: center;">YEAR</th> <th style="text-align: center;">AADT</th> </tr> </thead> <tbody> <tr> <td>CURRENT</td> <td style="text-align: center;">_____</td> <td style="text-align: center;">_____</td> </tr> <tr> <td>OPENING</td> <td style="text-align: center;">_____</td> <td style="text-align: center;">_____</td> </tr> <tr> <td>DESIGN</td> <td style="text-align: center;">_____</td> <td style="text-align: center;">_____</td> </tr> </tbody> </table> <p style="text-align: center;"><b><u>DISTRIBUTION</u></b></p> <p>DESIGN SPEED _____ K        %                      POSTED SPEED _____ D        %  <span style="margin-left: 150px;">T<sub>24</sub>                      %</span></p>		YEAR	AADT	CURRENT	_____	_____	OPENING	_____	_____	DESIGN	_____	_____
	YEAR	AADT											
CURRENT	_____	_____											
OPENING	_____	_____											
DESIGN	_____	_____											
<b>LIST ANY POTENTIAL EXCEPTIONS AND VARIATIONS RELATED TO TYPICAL SECTION ELEMENTS</b>													
<i>LIST MAJOR STRUCTURES LOCATION/DESCRIPTION - REQUIRING INDEPENDENT STRUCTURE DESIGN</i>													
<i>LIST MAJOR UTILITIES WITHIN PROJECT CORRIDOR.</i>													
<i>LIST OTHER INFORMATION PERTINENT TO DESIGN OF PROJECT</i>													

PROJECT IDENTIFICATION			
FINANCIAL PROJECT ID	WORK PROGRAM ITEM	COUNTY NAME	HILLSBOROUGH
STATE PROJECT NO	ROAD DESIGNATION	LIMITS/MILEPOST	(MP 7.381 TO MP 0.535)
FEDERAL AID PROJECT NO	FEDERAL FUNDS	PROJECT DESCRIPTION	MULTILANE RECONSTRUCTION OF SR 99
FROM CR 239 (CALHOUN BLVD.) TO I-10			
<h3 style="margin: 0;">PROPOSED ROADWAY TYPICAL SECTION</h3> <p style="text-align: center; margin-top: 10px;"><b>DESIGN SPEED = 50 mph</b>  <b>STA. 250+36.00 TO STA. 301+44.91</b></p>			
<b>APPROVED BY</b> Signature Block _____ Date _____ Printed Name _____ Engineer Of Record _____		<b>FDOT CONCURRENCE</b> Signature Block _____ Date _____ Printed Name _____ FDOT District Design Engineer _____	
<b>APPROVED BY</b> Signature Block _____ Date _____ Printed Name _____ Engineer Of Record _____		<b>FHWA CONCURRENCE</b> Signature Block _____ Date _____ Printed Name _____ FHWA Transportation Engineer _____	

Exhibit B, Sheet 2 of 6

<b>PROJECT IDENTIFICATION</b>	
FINANCIAL PROJECT ID <u>000002-1-32-01</u> WORK PROGRAM ITEM <u>7/12/91</u>	COUNTY NAME <u>HILLSBOROUGH</u>
STATE PROJECT NO <u>1001-1539</u> ROAD DESIGNATION <u>SR 99</u>	UNITS/MILEPOST <u>(MP 7.381 TO MP 10.535)</u>
FEDERAL AID PROJECT NO <u>FEDERAL FUNDS</u> PROJECT DESCRIPTION <u>MULTILANE RECONSTRUCTION OF SR 99</u>	FROM <u>CR 239 (CALHOUN BLVD ) TO I-10</u>

**PROPOSED STRUCTURE TYPICAL SECTION**

**DESIGN SPEED = 50 mph**  
**SR 99 BRIDGE OVER TUCKER CANAL**

<b>APPROVED BY</b>	<b>FHWA CONCURRENCE</b>
Signature Block _____ Printed Name _____ Engineer Of Record _____	Signature Block _____ Printed Name _____ FHWA Transportation Engineer _____
Date _____	Date _____

Exhibit B, Sheet 3 of 6

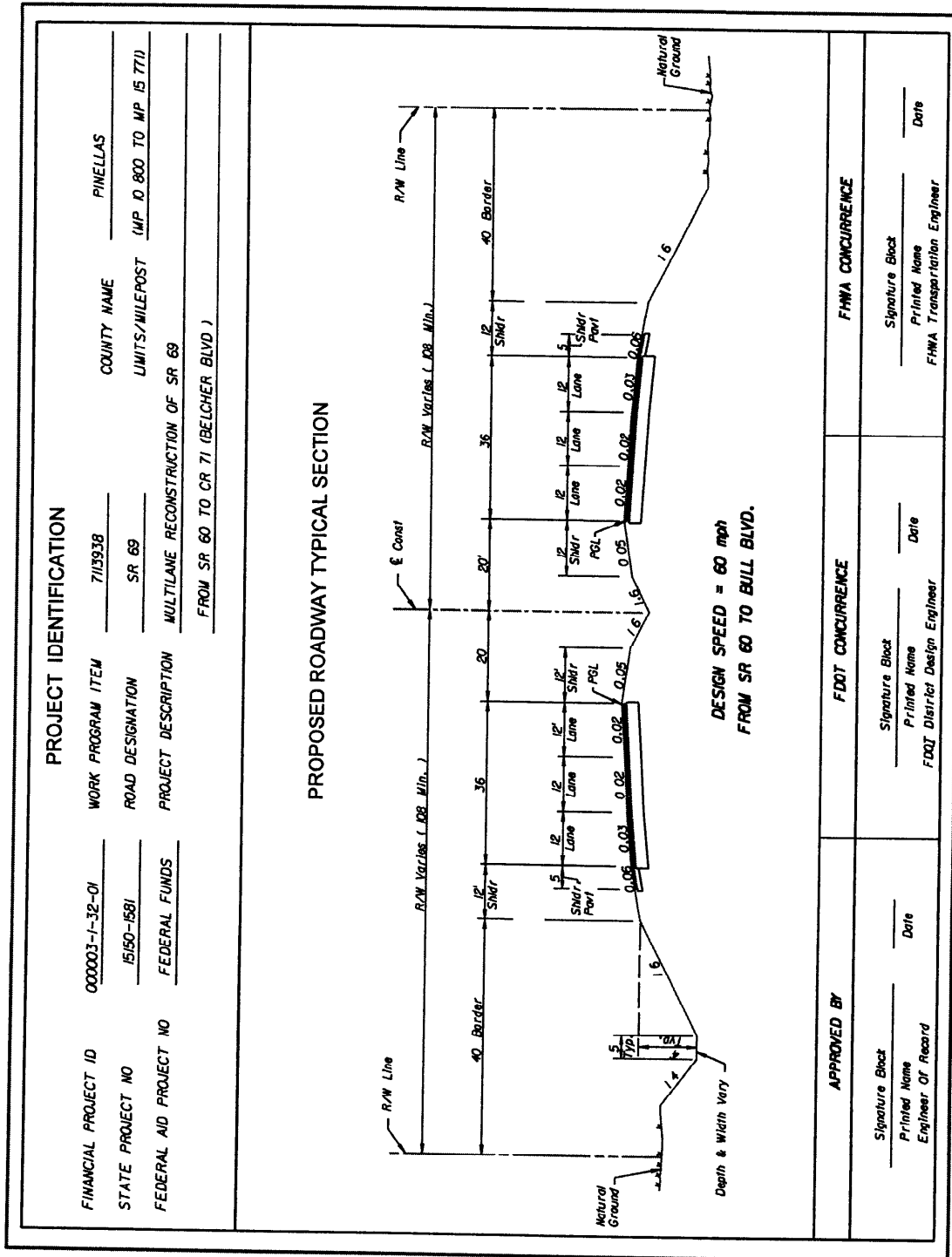

Exhibit B, Sheet 4 of 6

PROJECT IDENTIFICATION			
FINANCIAL PROJECT ID	0000003-1-32-01	WORK PROGRAM ITEM	7113938
STATE PROJECT NO	15150-1581	ROAD DESIGNATION	SR 69
FEDERAL AID PROJECT NO	FEDERAL FUNDS	PROJECT DESCRIPTION	MULTILANE RECONSTRUCTION OF SR 69
			FROM SR 60 TO CR 71 (BELCHER BLVD.)
COUNTY NAME	PINELLAS		
LIMITS/MILEPOST	(MP 10 800 TO MP 15 771)		

### PROPOSED STRUCTURE TYPICAL SECTION

**DESIGN SPEED = 60 mph**

**SR 69 BRIDGE OVER WHATCHAMACALLIT RIVER**

APPROVED BY	FHWA CONCURRENCE
Signature Block _____ Printed Name _____ Engineer Of Record _____ Date _____	Signature Block _____ Printed Name _____ FHWA Transportation Engineer _____ Date _____
Signature Block _____ Printed Name _____ FDOT District Design Engineer _____ Date _____	Signature Block _____ Printed Name _____ Date _____

Exhibit B, Sheet 5 of 6

PROJECT IDENTIFICATION			
FINANCIAL PROJECT ID	000001-1-32-01	WORK PROGRAM ITEM	3113940
STATE PROJECT NO	53150-1581	ROAD DESIGNATION	SR 71
FEDERAL AID PROJECT NO	FEDERAL FUNDS	PROJECT DESCRIPTION	MULTILANE RECONSTRUCTION OF SR 71
		COUNTY NAME	JACKSON
		UNITS/MILEPOST	(MP 1 941 TO MP 5 809)
FROM CR 481 (MONTZ RD ) TO BEAVER CREEK BRIDGE			
<p style="text-align: center;">PROPOSED ROADWAY TYPICAL SECTION</p> <p style="text-align: center;">DESIGN SPEED = 55 mph                  STA. 10+53.00 TO STA. 72+77.00</p>			
APPROVED BY _____ Signature Block Printed Name Engineer Of Record	FDOT CONCURRENCE _____ Signature Block Printed Name FDOT District Design Engineer	FHWA CONCURRENCE _____ Signature Block Printed Name FHWA Transportation Engineer	_____ Date

Exhibit B, Sheet 6 of 6

## Chapter 17

### ENGINEERING DESIGN ESTIMATE PROCESS

17 1	General	17-1
17 2	Pay Item List	17-1
17 3	Contract Estimating System (CES)	17-2
17.4	Estimated Quantities	17-2
17.4.1	Computation Book and Summary of Quantities	17-2
17.4.2	Breakdown of Quantities	17-3
17.4.3	Utility Contract Plans (Joint Project Agreements)	17-3
17 4 4	Plan Notes	17-3
17 5	Specifications (Method of Measurement)	17-4
17 6	Pay Items	17-4
17.6.1	New Pay Items	17-4
17.6.2	Trial Pay item Process	17-5
17 7	Contract Time	17-5
17 8	Alternative Contracting Practices	17-6

# ENGINEERING DESIGN ESTIMATE PROCESS MAJOR ACTIVITIES

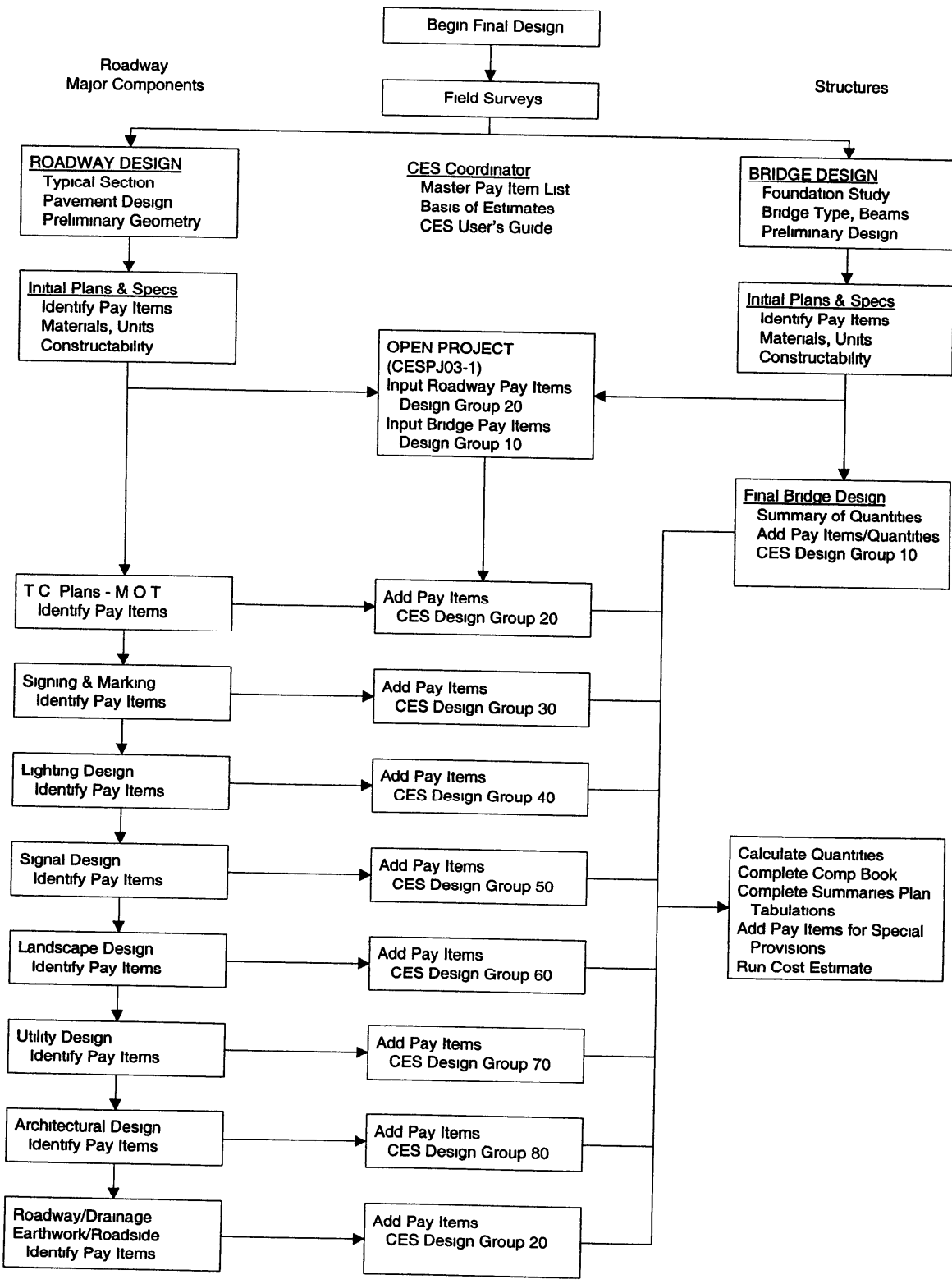



## Chapter 17

# ENGINEERING DESIGN ESTIMATE PROCESS

### 17.1 General

The engineer's estimate of construction cost and contract time is one of the last activities performed on roadway and structures design projects

To do a quality cost estimate, the engineer must have available the following

- the complete contract plans set, including all component sets such as structures, architectural, etc ,
- the complete specifications, including the supplemental specifications and technical special provisions,
- the **Roadway and Traffic Design Standards** booklet referenced on the key sheet of the contract plans,
- the completed computation book for the roadway and structures plans, and
- the current **Basis of Estimates Handbook**

### 17.2 Pay Item List

The Specifications establish the method of measurement, basis of payment and payment items for work specified for road and bridge construction. The **Basis of Estimates Handbook** contains a **Master Pay Item List** as of the cutoff date for the current issue. The only source of **current** information about **Open** pay items is the Master Pay Item List on the CES computer data base. The **Basis of Estimates Handbook** also contains design aids, notes, and computation information to aid the engineer in preparing the cost estimate.

Pay items for the various categories of construction work should be identified as those components are completed. For example, pay items for base and pavement work may be identified as the pavement design is completed. Signal pay items may be identified as the signal design is completed. The engineer doing the design and specifications is knowledgeable about what work is to be done and which pay items are needed. The quantity take-off is generally done at a later date when the plans are final and the tabulations and calculations are done. The persons doing the quantity take-off should also be alert to ensure all pay items have been identified.

The **Master Pay List** shall be utilized to identify payment items on all types of projects,

including resurfacing, widening, safety, bridge, etc. If any work on a project is not covered by existing specifications, then a technical special provision and possibly a new pay item description, unit of measure, and basis of payment may be required. Establishing new pay items is highly regulated and before it is undertaken, the District CES Coordinator where the project is located should be consulted. See **Section 17.6** for more details.

Participating and non-participating portions of work should be determined when identifying pay items so quantity summaries can be set up properly in the CES and computation book.

### **17.3 Contract Estimating System (CES)**

The CES is used to compile and complete a contract cost estimate in the same manner a contractor may prepare a bid, by using labor, equipment and material costs. Procedures and training on the CES programs are available from the Engineering Support Services section of the State Estimates Office in Tallahassee. Contact your District CES Coordinator for more information.

### **17.4 Estimated Quantities**

#### **17.4.1 Computation Book and Summary of Quantities**

Quantities for pay items are tabulated and computed by two methods. They are tabulated and totaled on Summary of Quantity sheets in the plans. If they are not in the plans, then they must be tabulated and calculated on standard computation forms as described in Section I of the ***Basis of Estimates Handbook***. The computation book contains all calculations and summary of quantities organized in pay item sequence for the project. Backup calculations and computer output that substantiate the summary should be filed directly behind the forms. Items calculated using the standard basis of estimate from the ***Basis of Estimates Handbook*** or from Standard Index drawings should be clearly shown in the comp book, especially if several intermediate computations are necessary to arrive at the total quantity. All nonstandard methods should be clearly and completely documented by showing all calculations and the basis of estimating the quantities and a pay item note should be shown in the plans indicating the basis of estimate used.

The original computation book, including the Structures computation book and all backup calculations for roadway and bridge quantities, shall be transmitted to the District Construction Office when the plans are sent for letting.

## **17.4.2 Breakdown of Quantities**

For projects that have partial federal funds, adequate distinction should be clearly made between participating (included in federal aid) and nonparticipating (not included in federal-aid) items. All nonparticipating items with quantities should be identified in the CES and the Computation Book. The method of presenting this information must be of sufficient detail for project personnel to readily distinguish between participating and nonparticipating work, including its physical location on the project. Project personnel must be able to properly account for the necessary separation of quantities. These separated quantities should be properly identified as to participating and nonparticipating work when entered into CES. In a few cases certain lump sum items such as mobilization, maintenance of traffic, etc. may be at least partially Federal Aid nonparticipating depending upon the nature of other nonparticipating items which must be separated. Where it is determined that certain lump sum items should be partially nonparticipating, the percentage assignment of nonparticipating should be negotiated with the FHWA. Upon mutual agreement, this percentage should be reflected when entering data into CES. These items should be determined during early stages of project development.

Where joint project agreements are involved between the Department and a City or County, appropriate participation information regarding this particular phase of the work should be so noted.

When a contract contains more than one Financial Project ID, with or without participating/nonparticipating quantities, the Summary of Pay Items and Summary of Quantities must show the separate quantities for each project. The computation book should clearly distinguish the location of each part of the work. The designer should also verify that the method of payment for an item of work agrees among all projects when projects are combined into a single contract.

## **17.4.3 Utility Contract Plans (Joint Project Agreements)**

When separate plans for utility construction are to be included in the contract, special attention should be given to establishment of pay items and loading CES. Reimbursable work is indicated in the Financial Project ID by phase number 56 and non-reimbursable work is indicated by phase number 52.

## **17.4.4 Plan Notes**

Plan notes are intended to be used to clarify design detail, construction practices or method for payment. In general, plan notes should be kept to a minimum. Only those notes which are job specific should be used. Many of the "old" standard notes have been eliminated recently and incorporated into the specifications. Notes which restate the standard specifications or standard indexes shall not be used. This will help to place proper

emphasis on those notes that are job specific and avoid discrepancy of documents

## **17.5 Specifications (Method of Measurement)**

The Department's current practice is to provide for final payment under the plan quantity concept for a large number of commonly used items. This concept requires that the **estimated quantities be calculated and documented as accurately as possible** (See **Article 9-3.2 of the Specifications**)

The documentation for quantities must be accurate and clear to the contractor. Plan limits, stations and offsets, coordinates, etc. must be detailed so the contractor can stake, layout and control the construction exactly as the engineer calculated the quantities.

Tonnage items are not included in the plan quantity concept. Base and stabilization items for resurfacing, widening and intersection improvement projects may be evaluated for payment under final measurement on a project by project basis. Projects for which the Districts desire to have these items paid under final measurement shall include in the plans transmittal package to Tallahassee, a letter to the State Specifications Engineer, listing the specific items desired to be paid by final measurement.

Allowing final measurement on these items does not release the designer from calculating the quantities as accurately as possible. Field reviews and design surveys are still required, when necessary, to define or establish scope and/or essential topography.

For plan quantity items, the designer shall sign the computation sheet verifying that all backup data and computations are included in the computation book.

## **17.6 Pay Items**

### **17.6.1 New Pay Items**

Before a new pay item is requested, the designer should contact the District CES coordinator to determine if an existing pay item or a pay item that has been blocked temporarily is available to cover the anticipated work.

New construction material and new uses of existing construction materials require specifications and new pay item definitions. The Department has established the following procedure to establish new pay items.

The originator of a new pay item should submit a draft of the pay items specification, any manufacturer's brochures, estimated material and labor cost, a Pay Item Request form, Form 600-000-02, available through the CICS Forms Menu, and any other relevant data.

to the District CES coordinator. This package will be reviewed and forwarded to the Central Office Design CES coordinator. Any inquiries arising during the review will be addressed to the originator through the appropriate CES coordinator. Upon successful completion of review, the package will be forwarded to the specifications office for further review, approval and pay item number assignment, after which it is transmitted to the estimates office for review, approval and entry into the data base system. After the pay item number is entered into the estimates office's database system, the District and Central Office CES coordinators will be notified of the approval.

### 17.6.2 Trial Pay item Process

The Department has determined a need to evaluate new pay items and specifications prior to statewide implementation for certain items. A new process has been developed for **Trial Pay Items**. This process allows for a monitor (Department's expert in a particular field) to be assigned to determine if the new product or process is suitable for statewide use. The Trial Pay Item and specification will be monitored on select projects and revised if necessary. Then they will be implemented or rejected for statewide use. Trial Pay item numbers will be assigned as follows: 29(year) - (Section) - sequential use. Description (Monitor's name)

Trial Pay Items may be used by calling the monitor who has been assigned to evaluate the use of the item. If the monitor approves the item for use, the monitor will E-Mail the Central Offices of Design, Specifications and Estimates approving the use of that Trial Pay Item number with specifications dated mm/dd/yy for a specific project number. As soon as the specification is finalized the monitor will recommend that the item be opened for statewide implementation and a new pay item number will be assigned.

### 17.7 Contract Time

After completion of the design project including the completion of the cost estimate, the plans package is submitted to the district construction office scheduling engineer for establishing the contract duration. Contract duration is the time required for the complete construction of the contract. A copy of the contract time is submitted to the Central Office in Tallahassee with the plans transmittal package. Certain large complex projects should have the desired contract duration established earlier in the design process.

Once the contract time has been established for federal-aid projects, trainee manhours should be computed. The **Basis of Estimates Handbook** has instructions for computing the number of trainees and the number of manhours required. Contract time is also used in calculating quantities for maintenance of traffic items.

## 17.8 Alternative Contracting Practices

It is the intent of the Department to use various techniques on a wide range of project types in order to determine which techniques work the best on each project type. The goal of this program is to reduce the cost and time overruns and thereby reduce the impacts of construction to motorists, businesses and homeowners within the transportation corridor. Most of the Alternative Contracting Practices involve financial incentives to expedite the work. For more detailed instructions refer to the Department's ***Alternative Contracting User's Guide***.

## Chapter 18

### QUALITY ASSURANCE & QUALITY CONTROL

18 1	General . . . . .	18-1
18 2	Quality Assurance . . . . .	18-1
18 2 1	Authority . . . . .	18-1
18 2 2	Accountability . . . . .	18-1
18.2.3	Critical Areas to be Monitored . . . . .	18-2
18 2 4	Documentation . . . . .	18-3
18 2 5	Training . . . . .	18-3
18 3	Quality Control . . . . .	18-3
18 3 1	Authority . . . . .	18-4
18 3 2	Accountability . . . . .	18-4
18 3.3	Critical Areas to be Monitored . . . . .	18-4
18 3.4	Documentation . . . . .	18-5
18.3.5	Training . . . . .	18-5

## Chapter 18

### QUALITY ASSURANCE & QUALITY CONTROL

#### 18.1 General

**Quality Assurance** and **Quality Control** are two processes used to ensure the public receives a quality product. **Quality Assurance** is the responsibility of, and performed by the Central Office. **Quality Control** is a responsibility of the District Offices, and is performed by the Districts and their Agents (Consultants), as appropriate.

#### 18.2 Quality Assurance

**Quality Assurance** is the planned, coordinated and continued activities performed to measure processes against predetermined critical requirements. The objective of **Quality Assurance** is the continual improvement of the total delivery process to enhance quality, productivity and user satisfaction.

##### 18.2.1 Authority

**Florida Statutes Section 20.23(3)(a)** requires a **Quality Assurance Process**. It requires the Central Office to establish departmental policies, rules, procedures and standards and to monitor the implementation in order to ensure uniform compliance and quality performance by the District and Central Office units that implement transportation programs. Also, **Florida Statutes, Section 334.048** states the Legislative intent with respect to the Central Office role in the Department's management accountability and monitoring systems, including corrective actions when appropriate.

##### 18.2.2 Accountability

The State Roadway Design monitoring plan identifies the process, critical areas, criteria used to measure compliance, report format, method of monitoring and tracking, and procedure for follow-up of unresolved issues. The results of the **Quality Assurance** monitoring activities are reported to management in exit interviews and reports. The reports identify areas needing improvement, provide feedback on the effectiveness and appropriateness of established policies, procedures and standards, and recognize areas of outstanding quality. The reports are also used to share improvement ideas between districts, and to maintain consistency in process and practice.

The Central Office shall furnish all the planned and systematic actions necessary to



provide adequate direction to the Districts so that all design products will be the result of predetermined requirements. This involves the establishment of design policies, procedures, standards and guidelines, training, and the monitoring and review of District compliance with these items.

The Central Office shall review each design process and its associated components for assurance that the Districts have adequate control measures in place and are complying with policy, procedures, standards, guidelines and processes. It will also be used for identifying any areas of excellence, noncompliance and need.

### **18.2.3 Critical Areas to be Monitored**

Critical areas to be monitored by the Central Office are based on well-established roadway design policy and practice. These policies, guidelines and accepted practices formulate the criteria used to measure compliance in the areas critical to quality. The minimum frequency of review for a critical area is three years. However, latitude is allowed for the depth and frequency of reviews, based on the individual District's observed performance, review findings or the needs of District management.

The State Roadway Design monitoring plan for Quality Assurance lists the following critical areas to be monitored:

#### **1. Initial Engineering Design Process (See Chapter 13)**

- A Quality Control Activities,
- B Scope Activities,
- C Standards Activities,
- D Design Support Activities,
- E Project Activities

#### **2. Final Engineering Design Process (See Chapter 14)**

- A Quality Control Activities,
- B Review Initial Engineering Design Activities,
- C Engineering Activities,
- D Support Activities

### 3. Update Engineering Design Process (See Chapter 15)

- A Quality Control Activities,
- B Scope Activities,
- C Standards Activities,
- D Engineering Activities,
- E Support Activities

#### 18.2.4 Documentation

The Quality Assurance findings and recommendations will be documented in a report that will be distributed to the District Secretaries and other affected offices. A brief summary of the data will also be entered in the Quality Assurance Reporting (QAR) data base. Summaries of significant issues will be prepared quarterly for upper management.

#### 18.2.5 Training

Training and assistance are also a mandated role of the Central Office units and the Quality Assurance program.

- A **Development:** The Central Office Roadway Design will formulate a training plan based upon District requests or needs as determined by the Quality Assurance reviews.
- B **Delivery:** The Central Office will manage or conduct training courses for District and Consultant personnel as requested, with schedules and locations sensitive to budgets and production schedules.

### 18.3 Quality Control

**Quality Control** is the process performed to ensure conformance with valid requirements. This process includes quality planning, training, providing clear decisions and directions, constant supervision, immediate review of completed activities for accuracy and completeness, and documenting all decisions, assumptions and recommendations.

Each District shall have a **District Quality Control Plan for Roadway Design** and the other production units which addresses broad overall quality initiative. The **District Quality Control Plan** shall identify the organization, responsibility, and accountability used to perform and document overall quality control, including the requirement for a Project

Quality Control Plan on all projects All **Project Quality Control Plans** must address any project specific scope of service needs and be approved by the Project Manager or District Design Engineer as appropriate

In-house and consultant designers and reviewers must recognize quality is the result of several processes It requires many individuals performing many appropriate activities at the right time during the plans development process Quality control does not solely consist of a review after a product is completed Quality requires performing all activities in conformance with valid requirements, no matter how large or small their overall contribution to the design process Good CADD techniques, attention to details and ensuring the plans are correct and useful to the contractor are also essential to quality

### 18.3.1 Authority

**Florida Statute 20.23(4)(b)** requires a **Quality Control Process** It requires that each District shall be accountable for ensuring their District's quality of performance and compliance with all laws, rules, policies, and procedures related to the operation of the department

### 18.3.2 Accountability

- A The **District** shall follow established design policies, procedures, standards and guidelines in the review and preparation of all design products, and review Consultant prepared individual engineering and design for compliance and good engineering practice
- B The **Consultant** is an agent for the District with the primary responsibility for preparation of contract plans Consultants must ensure quality and adherence to established design policies, procedures, standards and guidelines in the review and preparation of all design products for compliance and good engineering practice as directed Project Quality Control Plan by the District

### 18.3.3 Critical Areas to be Monitored

The District shall monitor the Quality Control efforts used by in-house staff and its consultant services units The District shall assure project scopes include an adequate **Project Quality Control Plan**.

### 18.3.4 Documentation

The Districts shall maintain a file containing the current District Quality Control Plan and shall furnish Central Office Design with a copy to be used as part of the critical areas to be reviewed. Every project file will contain a Project Quality Control Plan at the beginning of the Initial Engineering Design Process.

### **18.3.5 Training**

The District shall identify and coordinate training needs of in-house and Consultant services through the appropriate Central Office units.

## Chapter 19

### SEALING DESIGN DOCUMENTS

19.1	General	19- 1
19.2	Sealing of Contract Plans	19- 1
19.2.1	Manual Sealing	19- 2
19.2.2	Electronic Sealing	19- 2
19.3	Sealing Other Engineering Documents	19- 3
19.4	Sealing of Revisions	19- 3
19.4.1	Plans	19- 4
19.4.2	Other Engineering Documents	19- 4
19.5	Support Documents	19- 4
19.5.1	18 KIP Equivalent Single Axle Loads	19- 5
19.5.2	Project Traffic	19- 6

## Chapter 19

### SEALING DESIGN DOCUMENTS

#### 19.1 General

**Section 334.175 of the Florida Statutes**, requires that all design plans and surveys prepared by or for the Department be sealed by the professional engineer, surveyor or architect in responsible charge of the project work **Section 471.025, Florida Statutes**, requires that all final drawings, specifications, plans, reports, or documents prepared or issued by a registered professional engineer and being filed for public record shall be sealed by the registrant. Such professional engineer must be duly registered in the State of Florida.

Professional Engineers shall seal only those documents that conform to acceptable engineering standards and safeguard life, health, property and welfare of the public (**Rule 61G15-19.001, F.A.C.**) A professional engineer may only seal an engineering report, plan, print or specification if that professional engineer was in responsible charge of the preparation and production of the engineering document (**Rule 61G15-23.002, F.A.C.**) Responsible charge means supervisory direction and/or control authority over engineering decisions made personally or by others (**Rule 61G15-18.011, F.A.C.**)

As stated in **Chapter 481, Part II, Florida Statutes** and **Rule Chapter 61G10-11.010(2)** "All plans, specifications or reports, including all permit documents, prepared or issued by the registered landscape architect and filed for public record shall be signed by the registered landscape architect, dated and stamped with his seal."

This chapter explains the Department's requirements for sealing/signing design plans and other design documents prepared by or for the Department. It is the District's responsibility to ensure that all record sets and documents are properly sealed and/or signed.

#### 19.2 Sealing of Contract Plans

A Record Set of the Contract Plans shall be sealed by the Engineer(s) of Record (EOR). The EOR is a Florida registered professional engineer in responsible charge for the preparation of engineering documents. Under the provisions of **Rule 61G15-23.003(2)**, each sheet of the Record Set must be sealed by the EOR. The key sheet or first sheet of

each component of the plans set must be sealed by the EOR who has overall responsibility for that component. However, other sheets may be sealed by a delegated engineer, who in turn becomes the EOR for that portion of the work.

### 19.2.1 Manual Sealing

To properly seal a document, the EOR will sign, write the date immediately under the signature, and seal over the signature and date. The location of this seal should be varied along the bottom of the sheet for convenient storage of a plans set, and to insure that the seal will not obliterate any critical information.

Interim Standard Indexes that have not been altered and that are included in the plans shall not be sealed. All interim and adopted Standard Indexes have been previously sealed and the Record Set is kept in the Roadway Design Office.

Plans prepared by an employee of a Utility or other employees exempted under **Section 471.003, Florida Statutes**, that will be appended to Department plans, are not required to be sealed except as follows. Utility plans that modify or detail attachments to a bridge or other structure belonging to the Department must have the sheets affecting such structure sealed. Plans prepared by non-exempt parties for a Utility, that will be appended to Department plans, must be sealed. For detailed requirements refer to the **Utility Accommodation Manual, Topic No. 710-020-001**.

### 19.2.2 Electronic Sealing

Information stored in electronic files representing plans, specifications, plats, reports, or other documents which must be sealed under the provisions of **Chapter 471, Florida Statutes**, shall be signed, dated and sealed by the professional engineer in responsible charge.

Electronic files may be signed and sealed by creating a "signature" file that contains the engineer's name and PE number, a brief overall description of the engineering documents, and a list of the electronic files to be sealed. Each file in the list shall be identified by its file name utilizing relative Uniform Resource Locators (URL) syntax described in the Internet Architecture Board's Request for Comments (RFC) 1738, December 1994, which can be obtained from the Internet Website <ftp://ftp.isi.edu/in-notes/rfc1738.txt>. Each file shall have an authentication code defined as an SHA-1 message digest described in Federal Information Processing Standard Publication 180-1 "Secure Hash Standard," 1995 April 17, which can be obtained from the Internet Website <http://www.itl.nist.gov/div897/pubs/fip180-1.htm>. A report shall be created that contains the engineer's name and PE number, a brief overall description of the engineering documents in question and the authentication code of the signature file. This report shall

be printed and manually sealed by the professional engineer in responsible charge. The signature file is defined as sealed if its authentication code matches the authentication code on the printed, manually signed, dated and sealed report. Each electronic file listed in a sealed signature file is defined as sealed if the listed authentication code matches the file's computed authentication code.

### **19.3 Sealing Other Engineering Documents**

Other engineering documents include related plans, reports, computations, specifications or criteria, as defined in **Rule 61G15-30.002 (4)**, and used in the development of design plans. Bound engineering documents must be sealed on a signature page or cover letter by the EOR. If a document includes work by more than one EOR, the signature page or cover letter must have an index with sufficient information for the user to be aware of each portion of the document for which each engineer is responsible. To seal a document, the engineer will sign, date immediately under the signature, and seal over the signature and date. With the exception of specifications, any document, report or computations not bound shall have all sheets sealed. Specifications will be sealed in accordance with the Specifications Package Preparation Procedure.

The following engineering documents shall be kept in the district's Project File(s)

- Specifications and Special Provisions
- Pavement Design Package
- Typical Section Package
- Drainage Computations
- Hydraulics Reports
- Bridge Development Report
- Traffic Engineering Reports and Recommendations
- Environmental Reports and Recommendations
- Soil Survey Reports and Geotechnical Report
- Value Engineering Record
- Other Engineering Reports
- Permit Documentation

### **19.4 Sealing of Revisions**

Revisions are a partial modification of an engineering document after a plans package is sent to Tallahassee for contract letting. Whenever practical, revisions should be prepared by the original EOR.



### **19.4.1 Plans**

Revisions to a plans sheet prior to the contract letting shall be prepared as outlined in **Chapter 20**, this manual. Revised sheets will be appended to the plans set.

Any plans sheet revised after the contract letting will be sealed in accordance with the **Construction Project Administration Manual (CPAM), Topic No. 700-000-000**.

### **19.4.2 Other Engineering Documents**

Each revised sheet shall be sealed by the EOR who prepared the revision and placed immediately behind the cover sheet of the sealed document. Specifications will be revised in accordance with the **Specifications Package Preparation Procedure, Topic No. 700-020-010**.

### **19.5 Support Documents**

Engineering decisions are often made on the basis of support documents furnished by non-engineering staff or offices. Two reports prepared in accordance with Department procedures will be attested as follows:

### 19.5.1 18 KIP Equivalent Single Axle Loads (ESAL)

Financial Project ID \_\_\_\_\_

State Road No \_\_\_\_\_

County \_\_\_\_\_

I have reviewed the 18 KIP Equivalent Single Axle Loads to be used for pavement design on this project. I hereby attest that these have been developed in accordance with the FDOT ***Project Traffic Forecasting Procedure*** using historical traffic data and other available information.

\_\_\_\_\_  
Name

\_\_\_\_\_  
Signature

\_\_\_\_\_  
Title

\_\_\_\_\_  
Organizational Unit

\_\_\_\_\_  
Date

### 19.5.2 Project Traffic

Financial Project ID \_\_\_\_\_

State Road No \_\_\_\_\_

County \_\_\_\_\_

I have reviewed the Project Traffic to be used for design of this project. I hereby attest that it has been developed in accordance with the FDOT ***Project Traffic Forecasting Procedure*** using historical traffic data and other available information.

\_\_\_\_\_  
Name

\_\_\_\_\_  
Signature

\_\_\_\_\_  
Title

\_\_\_\_\_  
Organizational Unit

\_\_\_\_\_  
Date

## Chapter 20

### PLANS PROCESSING AND REVISIONS

20.1	General	20- 1
20.2	Glossary	20- 1
20.3	Plans Processing	20- 1
20.3.1	District Activities	20- 1
20.3.2	Submittal to Tallahassee	20- 2
20.4	Revisions to the Plans Package	20- 4
20.5	Resubmittal of Withdrawn Project	20- 7

#### Figures

20.1	District Revisions Process	20- 6
------	----------------------------	-------

#### Exhibits

20-A	Transmittal of Contract Plans Package	20- 8
20-B	Contract File Index	20- 10
20-C	Revision Memo	20-12
20-D	Status of Environmental Certification	20-15
20-E	Plans, Specifications and Computation Book	20-16
20-F	Project Certification to Federal Standards	20-17
20-G	Preliminary Engineering Certification	20-18
20-H	CES Lock Letter	20-19
20-I	Change Memo	20-20

## Chapter 20

### PLANS PROCESSING AND REVISIONS

#### 20.1 General

This chapter describes in general terms the critical activities required to process the contract plans, specifications and estimate for letting. It identifies the documents, transmittal forms and certifications prepared by the district and the various offices that process a plans package. This chapter also outlines the revision process, and the steps to resubmit a project withdrawn from letting.

#### 20.2 Glossary

**Contract Plans** - The plans prepared during the design phase, and used by construction personnel to build a project. When design is complete, the Engineer(s) of Record (EOR) seals a first generation plot of the set of plans and this becomes the legal Record Set in accordance with *Chapter 471 of the Florida Statutes* (see **Chapter 19**, this manual).

**Final Plans** - The Contract Plans after construction is completed, all revisions have been included and with the title on the key sheet changed to Final Plans.

#### 20.3 Plans Processing

##### 20.3.1 District Activities

There are certain plans processing activities which must occur at the District level prior to submitting plans to Tallahassee. These activities have schedule implications which will vary by District. The following activities should be considered as a guide. The District should be contacted for specific requirements.

On the Plans to Specifications Date the project manager submits to the District Specifications section the contract file and a plans package consisting of the following items:

- Original CES Lock Letter (Exhibit 20-H)
- Two copies of the plans (including all components)
- One copy of the Computation Book

- Two copies of the Technical Special Provisions (if applicable)

The contract file consists of the Transmittal of Contract Plans Package memo (Exhibit 20-A) and the Contract File Index (Exhibit 20-B) with attachments

The Specifications section forwards one copy of the plans and the copy of the Computation Book to the District Estimates section. Upon receipt of the plans, the Estimates section locks the CES.

Any modification to the plans or quantities between the Production Date and the Plans to Tallahassee Date will be referred to as Plans Changes. These changes are not revisions. A Change Memo (Exhibit 20-I) is required to notify the District Specifications and Estimates sections of any changes to the plans or quantities.

When changes are necessary, the project manager prepares a Change Memo listing all plan and quantity changes and submits a copy to the District Specifications and Estimates section. The Estimates section unlocks the CES and notifies the project manager, who then has twenty-four hours to make changes to the CES. The project manager submits the original Change Memo and two copies of all changed sheets to the Specifications section.

One week prior to the Plans to Tallahassee Date the Specifications section submits the following items to the project manager, who assembles the Contract Plans Package for mailing:

- Signed/Sealed specification package
- Copies of the specifications package: two for F A projects/one for Non F A projects
- Intent and scope/specialty work
- Two copies of the Specifications Transmittal memo
- Contract file

### **20.3.2 Submittal to Tallahassee**

Districts are responsible for preparing the Contract Plans Package and mailing it to Central Office so that it arrives in the Plans Processing Section of the Specifications Office no later than the due date assigned in the Work Program.

Prior to mailing plans to Central Office the district assembles the Plans Package and insures it is complete, as follows:

- The Transmittal of Contract Plans Package (**Exhibit 20-A**) and applicable documents are attached. If federally funded, includes certification that the project was designed to federal standards (**Exhibit 20-F**)
- An original set of the Contract Plans is sealed in accordance with **Chapter 19**, this manual. All sheets are CADD produced first-generation plots or laser prints, size B (11x17), on good quality multipurpose (typewriter/printer) paper, legible and reproducible. Sheets are punched with two holes (standard holes are 8 1/2 inches apart on the left edge of the sheet), and bound with fasteners such as Chicago Screw Posts. All sheet numbers match the key sheet index, and the Financial Project ID (or State Project number) is correct and consistent on all sheets. On strung projects, the lead key sheet shows the Financial Project IDs that go with the lead project. Also, on strung projects all Summary of Pay Items sheets are included in the lead project. If the project is federally funded, the Sealed Contract Plans Set plus two copies (copies can be from unsealed plans) are provided. If the project is not federally funded, the sealed Contract Plans Set plus one copy are provided.
- On the Sealed Specifications Package, the cover sheet of the Technical Special Provisions and the Storm Water Pollution Prevention Plan are sealed. All sheets listed in the table of contents are present, fastened, legible and reproducible. If the project is federally funded, the sealed Specifications Package plus two copies are included. If not federally funded, only the sealed Specifications Package plus one copy are included. One separate copy of the "Intent and Scope" of the project (a component of the Specifications Package) is provided for Contracts to use in the advertisement.
- Other components of the Plans Package such as Utility Certification, etc

At the time of transmittal of the Plans Package to Central Office the Project Manager (or designated district person) sends a copy of the contract plans set, the specifications package, the original computation book and one copy of the computation book to the District Construction Engineer (**Exhibit 20-E**). The Project Manager keeps a copy of the transmitted documents in the project file(s).

Several activities are required by the units in Central Office to get a project ready for letting. Upon receipt of the Plans Package, the Plans Processing Section checks the package for completeness and stamps the date received on the Transmittal Memo. If incomplete, Plans Processing notifies the district Project Manager to provide the required items. Once

verified as complete, Plans Processing logs-in the Plans Package and distributes it's components to various Central Office units

After the project is awarded, the sealed Contract Plans Set and the sealed Specifications Package are sent to the District Construction Engineer. This sealed Contract Plans Set will be used during construction to show all significant revisions to the plans (including those affecting payments to the contractor)

The Contract Plans set plus all revisions made during construction becomes the Final Plans set. The sealed set (Record Set) of the Final Plans is used by District Final Estimates to make the final payout of a construction project. After the final payout, District Final Estimates mails the sealed Final Plans to the Department of State for microfilming. Once microfilmed, the Department of State destroys the paper based sealed Final Plans, archives the microfilm negative as the Record Set of the Final Plans, sends one copy of the microfilm to the District and another to Central Office.

## 20.4 Revisions to the Contract Plans Package

Design revisions are modifications to the Plans Package after it has been transmitted to Central Office but prior to bid opening. The Project Manager insures a revision is complete as follows (see **Figure 20.1**)

- 1 If the project is federally funded with oversight, obtain concurrence from FHWA prior to making revisions. FHWA concurrence may not be required on minor changes such as in quantities or to relocate a driveway.
- 2 All plans revisions require sealed revised sheet(s). Revisions to plans sheets other than a key sheet are noted in the "revisions" block of each modified sheet, and noted on the lower left corner of the key sheet in the "Revisions" area. (See **Exhibit KS-1, Chapter 3, Volume II**) If the changes to a key sheet only involve notes in the Revisions area, no entry is made in the key sheet revisions block at the lower right corner. The Key Sheet Revisions Block is only used to record changes other than revisions notes. Revisions to component sets such as the Signalization Plans are noted in the revision block of the modified sheet, and on the lead key sheet in the Revisions area. A newly sealed lead key sheet is required when any sheet is revised.
- 3 Prepare the Revision Memo (**Exhibit 20- C**) and describe modifications. Record the revision date for each revised sheet, using the date shown in the



revision block on the sheet. The District Design Engineer, District Consultant Project Management Engineer or the District Structures Design Engineer, as appropriate, reviews and concurs with the revision.

- 4 The District Specifications Engineer reviews the revisions for any effect on the specifications and dates and signs the Revision Memo.
- 5 When more than one revision is expected, hold until all revisions are ready and submit as a package. The Revision Memo is faxed to the State Preliminary Estimates Engineer. Preliminary Estimates unlocks the CES for a 24 hour period, to allow the district or its consultant time to revise the Summary of Pay Items.
- 6 Insure that sealed plans sheets including the Summary of Pay Items and the District Cost Estimate (if Federal Aid) are attached to the Revision Memo. The Engineer of Record seals each revised document in accordance with **Chapter 19, Sealing Design Documents**, of this manual. Include two copies of the Revision Memo with attachments if project has federal funds, but only one copy if no federal funds are involved.
- 7 Mail the signed original Revision Memo with attachments to Plans Processing at Mail Station 75. Send the revised original computation sheets and one copy to the District Construction Engineer. If the original Revision Memo will be received in Plans Processing between 15 and 6 working days prior to letting, the District Secretary must approve by signing the Revision Memo. Revisions within five work days of letting are not allowed since there is no

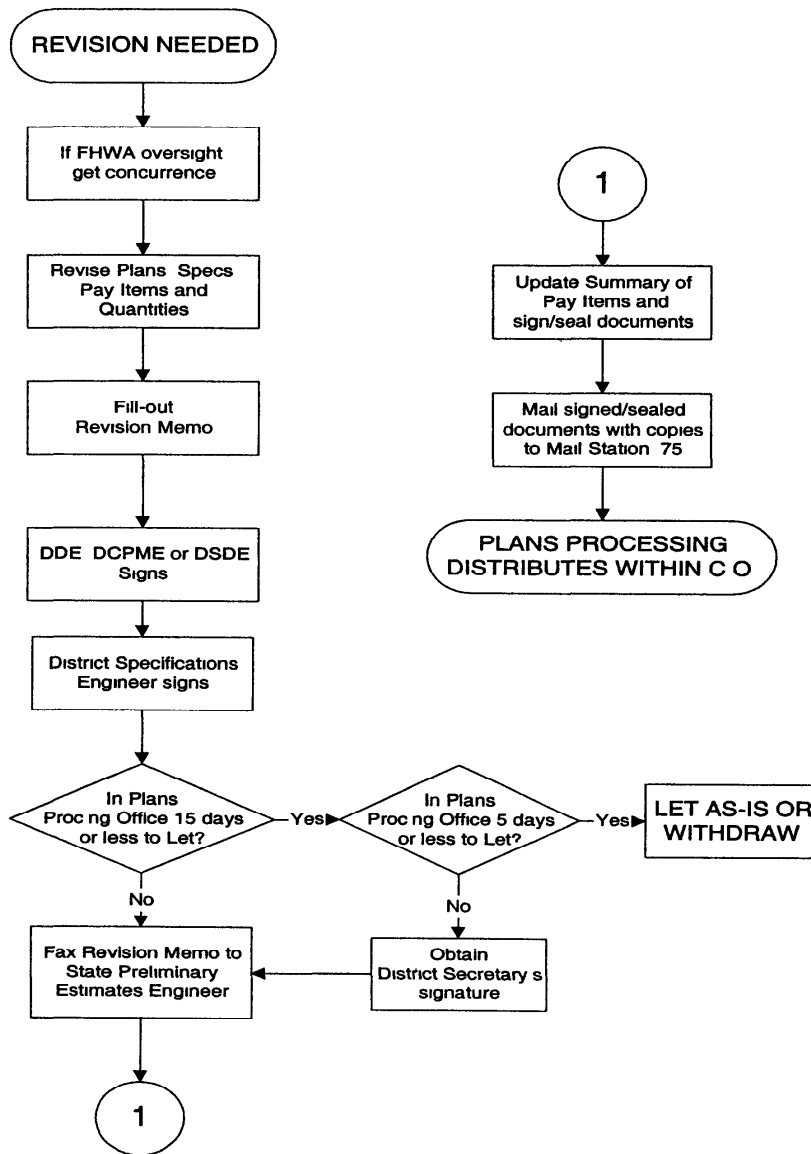

**Figure 20.1 -District Revisions Process**

assurance that all prospective contractors will get these documents on time to consider in their bids. After this date the project must be let as is, or must be withdrawn from letting. Withdrawing the Plans Package after advertisement requires approval by the District Secretary and the State Highway Engineer.

- 8 The revision package includes the Revision Memo and as applicable
  - sealed contract plans sheets including key sheet,
  - revised Summary of Pay Items and the District Cost Estimate (if Federal Aid) (CESPJ27),
  - revised sealed specifications
- 9 Upon receipt of the signed original Revision Memo, Plans Processing checks the revision package for completeness. A copy of the Revision Memo and a copy of the revised sheets are delivered to Preliminary Estimates and, if federally funded, another copy to Federal Aid.

After contract award, revisions are done by district construction in accordance with the ***Construction Project Administration Manual (CPAM), Topic No. 700-000-000***

## **20.5 Resubmittal of Withdrawn Project**

If prior to letting a district requests that the entire Plans Package be returned for major revisions, such project will be resubmitted as follows:

- Resubmit Plans Package as a new transmittal with all required components. On the Transmittal memo, write this note by the Transmittal date: "Resubmitted, Destroy Old Copies". On the lead Key Sheet, write this note on the lower left corner: "Plans Resubmitted on (date)". All copies of project documents in Central Office from the previous submittal will be destroyed. This action requires a total reprint.
- A project withdrawn for a significant period (nine months or longer) will be updated according to the process outlined in **Chapter 15**, this manual.

Plans rejected from letting by the Awards Committee or withdrawn for minor revisions may not need to follow the above process. District coordination with Central Office Production Management is required to reschedule a letting.

DATE \_\_\_\_\_

TO Director, Office of Design  
Attn State Specifications Engineer, Mail Station 75  
FROM \_\_\_\_\_, (Project Manager or other title)

COPIES \_\_\_\_\_

SUBJECT **TRANSMITTAL OF CONTRACT PLANS PACKAGE** Letting (mo/yr) \_\_\_\_\_

Financial Project ID(s) \_\_\_\_\_

State Project No \_\_\_\_\_ (lead number only)

Work Program No \_\_\_\_\_

\* Federal Aid No \_\_\_\_\_

State Road No \_\_\_\_\_

Work Type \_\_\_\_\_

Sealed Contract Plans Set plus 2 copies if federally funded, 1 copy otherwise  
Sealed Specifications Package plus 2 copies if federally funded, 1 copy otherwise  
1 copy of Intent and Scope and Specialty Work  
Contract File Index with Attachments

**This plans package is complete, has no known errors or omissions, has been reviewed for constructability and biddability, and is ready to advertise for construction**

Name \_\_\_\_\_ Signature \_\_\_\_\_  
District Director of Production

\* Place a letter "F" (1"X1") at upper right corner of transmittal for Interstate funds completion, new or reconstruction projects > \$1M, or NHS (off Interstate) new or reconstruction >\$5M

**Exhibit 20-A, Page 1 of 2**

## **REMINDER**

The sealed Contract Plans Set is from first-generation CADD produced plots or laser prints, size B (11x17), on good quality multipurpose (typewriter/printer) paper  
Punch 2 holes (standard holes are 8 1/2 inches apart on the left edge of the sheet), and bind plans sheets with fasteners such as Chicago Screw Posts (do not staple)

Check that all components of the Contract Plans Set are included as listed on the lead key sheet

Check that all sheets are included according to key sheet index(es)

Check that all sheets have the correct Financial Project ID

Check that all sheets are legible and reproducible

On strung projects, check that all Summary of Pay Items sheets go in the lead project and the Financial Project ID of the strung project is shown on the lead key sheet

Check that bridge pay item sheets show bridge numbers and the quantity breakdowns

Organize attachments in the order listed

Mail all documents to Plans Processing at Mail Station 75

**COMPUTATIONS** - Send original computation book and 1 copy to the District Construction Engineer

## CONTRACT FILE INDEX

Financial Project ID \_\_\_\_\_  
State Project No \_\_\_\_\_  
Work Program No \_\_\_\_\_

### ATTACHMENTS (check or expected day of arrival in Central Office)

- \_\_\_\_\_ Calendar Days Recommendation<sup>x</sup>
- \_\_\_\_\_ Preliminary Engineering Certification<sup>x</sup>
- \_\_\_\_\_ Utility Certification
- \_\_\_\_\_ Status of Environmental Certification<sup>x</sup>
- \_\_\_\_\_ Permit Transmittal Memo
- \_\_\_\_\_ Maintenance Agreement, if applicable<sup>x</sup> (number \_\_\_\_\_)
- \_\_\_\_\_ Joint Project Agreement with engineer's estimate, if applicable, 2 copies  
Reimbursable (number \_\_\_\_\_)  
Non-reimbursable (number \_\_\_\_\_)
- \_\_\_\_\_ District Cost Estimate<sup>x</sup>
- \_\_\_\_\_ FA Project Certification to Standards

Yes\_ No\_ Form FHWA-37 has been electronically transmitted<sup>x</sup>

Yes\_ No\_ Project exempt from FHWA oversight under agreement dated April 26, 1999 <sup>x</sup>

Yes\_ No\_ Right of Way Certification was mailed to State R/W Administrator

<sup>x</sup> Include if federally funded.

Name \_\_\_\_\_

Signature \_\_\_\_\_  
Project Manager/Other Title

Exhibit 20-B, Page 1 of 2

## **REMINDER**

### **PROCESS**

Organize attachments in the order listed  
Show the number of Maintenance and Joint Project Agreements  
Show anticipated date of arrival on any item not included in package  
Mail all documents to Plans Processing at Mail Station 75

**Exhibit 20-B, Page 2 of 2**

DATE \_\_\_\_\_ 1 of \_\_\_\_

TO State Specifications Engineer  
Attn Plans Processing, Mail Station 75

FROM \_\_\_\_\_, Project Manager

COPIES TO Specifications, Contracts, Federal Aid, Preliminary Estimates, Reprographics,  
District Construction Engineer (computation book sheets only)

SUBJECT **Revision Memo** - Letting (mo /yr ) \_\_\_\_\_  
Financial Project ID \_\_\_\_\_ (Lead number only)  
State Project No \_\_\_\_\_ (Lead number only)  
WPI No \_\_\_\_\_  
Federal Aid Project Yes \_\_\_ No \_\_\_  
County \_\_\_\_\_ SR No \_\_\_\_\_

Concurred by \_\_\_\_\_ Date \_\_\_\_\_  
DDE DCPME or DSDE

Revisions have been reviewed for effects on the Specifications Package and a package  
revision is \_\_\_ is not \_\_\_ required \_\_\_\_\_ Date \_\_\_\_\_  
District Specifications Engineer

If Federal Oversight, Authorized By \_\_\_\_\_ Date \_\_\_\_\_  
Print Name of FHWA Engineer

REVISIONS TO BE RECEIVED IN PLANS PROCESSING BETWEEN 15 AND 6 WORK  
DAYS BEFORE LETTING, REQUIRE APPROVAL FROM THE DISTRICT SECRETARY  
NO REVISIONS ALLOWED WITHIN 5 WORK DAYS BEFORE LETTING

Approved By \_\_\_\_\_ Date \_\_\_\_\_  
District Secretary

Sheet No (s)	Rev. Date	Description
_____	_____	_____
_____	_____	_____
_____	_____	_____
_____	_____	_____

Central Office Use  
Processed By \_\_\_\_\_



## REMINDER

### PROCESS

Fill out headings

On oversight projects, get FHWA concurrence Print name of FHWA Engineer and date

Get concurrence from the District Design Engineer, District Consultant Project Management Engineer or the District Structures Design Engineer, as appropriate

Get signature of the District Specifications Engineer

If revisions will be received in Plans Processing between 15 and 6 work days before the letting date (bid opening), get approval from the District Secretary Notify Plans Processing No revisions are allowed within 5 work days before letting

Enter the sheet number or the Summary of Pay Items design group and

describe new pay item number with quantity, or

deleted pay item number only, or

revised quantities by entering pay item number with old and new quantities

If adding or deleting a pay item, revise the whole Summary of Pay Items design group to insure any pay item rollover between sheets is properly printed

Fax the Revision Memo to the State Preliminary Estimates Engineer at (850)-487-4584, Suncom 277-4584 to have CES unlocked Make revisions to the Summary of Pay Items within 24 hours after unlocking

Mail Revision Memo with attachments to Plans Processing at Mail Station 75

### ATTACHMENTS

Revised sealed plans sheets including Summary of Pay Items Two copies of revised plans sheets including Summary of Pay Items if federally funded, one if non-federal Revised District Cost Estimate if federally funded

Revised sealed specifications sheets including special provisions

Two copies of revised specifications sheets including special provisions if federally funded, one if non-federal

### COMPUTATIONS

Show Financial Project ID on revised computation book sheets, and mail originals and 1 copy to the District Construction Engineer

DATE \_\_\_\_\_

\_\_ of \_\_

Financial Project ID \_\_\_\_\_

<u>Sheet No (s)</u>	<u>Rev Date</u>	<u>Description</u>
_____	_____	_____
_____	_____	_____
_____	_____	_____
_____	_____	_____
_____	_____	_____
_____	_____	_____
_____	_____	_____
_____	_____	_____
_____	_____	_____
_____	_____	_____
_____	_____	_____
_____	_____	_____
_____	_____	_____
_____	_____	_____
_____	_____	_____
_____	_____	_____
_____	_____	_____
_____	_____	_____
_____	_____	_____
_____	_____	_____
_____	_____	_____
_____	_____	_____
_____	_____	_____
_____	_____	_____
_____	_____	_____

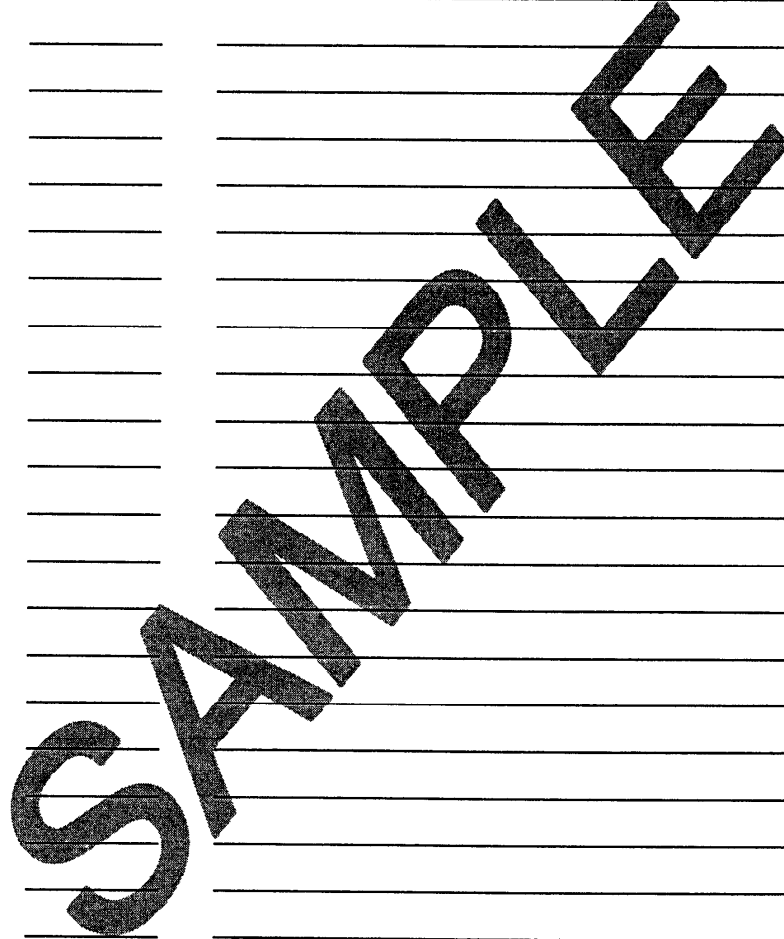

### STATUS OF ENVIRONMENTAL CERTIFICATION

Financial Project ID \_\_\_\_\_

State Project No \_\_\_\_\_

Work Program No \_\_\_\_\_

Federal Aid No \_\_\_\_\_

Project Description \_\_\_\_\_

This project is a Categorical Exclusion under 23 C F R 771.117 (c)

\_\_\_\_\_ Type 1 It was reevaluated on \_\_\_\_\_ and the determination remains valid

\_\_\_\_\_ Programmatic under current FHWA agreement It was reevaluated on \_\_\_\_\_, and the determination remains valid

The environmental document for this project was a (check one)

\_\_\_\_\_ Categorical Exclusion under 23 C F R 771.117(d) (Type 2) approved on \_\_\_\_\_

\_\_\_\_\_ FONSI under 23 C F R 771.121 approved on \_\_\_\_\_

\_\_\_\_\_ Final Negative Declaration approved on \_\_\_\_\_, or

\_\_\_\_\_ Final Environmental Impact Statement under 23 C F R 771.125 approved on \_\_\_\_\_

A reevaluation in accordance with 23 C.F.R 771.129 was approved on \_\_\_\_\_

Signature \_\_\_\_\_ Date \_\_\_\_\_

Environmental Administrator

### Exhibit 20- D

DATE \_\_\_\_\_  
TO \_\_\_\_\_, District Construction Engineer  
FROM \_\_\_\_\_, Project Manager  
SUBJECT **Plans, Specifications and Computation Book**  
Letting (mo/yr) \_\_\_\_\_  
Financial Project ID \_\_\_\_\_  
State Project No \_\_\_\_\_  
WPI No \_\_\_\_\_  
Federal Aid Yes \_\_\_\_ No \_\_\_\_  
County \_\_\_\_\_ State Road No \_\_\_\_\_

Attached are copies of the Contract Plans Set, the Specifications Package, the Original Computation Book and one copy of the Computation Book for use by Construction

**SAMPLE**

**Exhibit 20- E**

### PROJECT CERTIFICATION TO FEDERAL STANDARDS

Financial Project ID \_\_\_\_\_

STATE PROJECT NO \_\_\_\_\_

WPI NO \_\_\_\_\_

F A PROJECT NO \_\_\_\_\_

COUNTY \_\_\_\_\_ State Road No. \_\_\_\_\_

\_\_\_\_\_ The District Director of Production certifies that all work will meet or exceed the standards approved by the Secretary of The U S Department of Transportation under 23 U S C 109(c) I do, hereby, certify to the above statement

\_\_\_\_\_  
District Director of Production \_\_\_\_\_ Date

\_\_\_\_\_ The District Director of Production certifies that all work will meet or exceed, except as noted below, the standards approved by the Secretary of The U S Department of Transportation under 23 U S C 109(c) I do, hereby, certify to the above statement and listed below are the exceptions/variations to the standards

\_\_\_\_\_  
District Director of Production \_\_\_\_\_ Date

<u>Exceptions/Variations</u>	<u>Date of Approval</u>
_____	_____
_____	_____
_____	_____
_____	_____

**Exhibit 20- F**

**MEMORANDUM**

DATE \_\_\_\_\_

TO \_\_\_\_\_, Federal Aid Programs Manager

FROM \_\_\_\_\_, Design Project Manager

COPIES \_\_\_\_\_

SUBJECT **PRELIMINARY ENGINEERING CERTIFICATION (Federal Aid Projects Only)**

Financial Project ID \_\_\_\_\_

State Project No \_\_\_\_\_

Federal Aid No \_\_\_\_\_

Preliminary Engineering (design) was funded with

\_\_\_\_ State Funds

\_\_\_\_ Federal Funds authorized under,

Federal Aid No \_\_\_\_\_

Financial Project ID \_\_\_\_\_

State Proj No \_\_\_\_\_

The following projects designed with the same Preliminary Engineering funds, will be strung to (awarded with) the subject project

Federal Aid No \_\_\_\_\_, Financial Project ID \_\_\_\_\_,

Federal Aid No \_\_\_\_\_, Financial Project ID \_\_\_\_\_

The Preliminary Engineering for the subject project is \_\_\_\_\_ open/ \_\_\_\_\_ closed. If open,

\_\_\_\_\_ it will be closed after PS&E authorization, or

\_\_\_\_\_ it will remain open for additional charges, as follows \_\_\_\_\_

The FDOT Project Manager may be contacted at (phone) \_\_\_\_\_

**Exhibit 20- G**

DATE \_\_\_\_\_  
TO District Specifications Engineer  
FROM \_\_\_\_\_, Project Manager  
COPIES District Estimates Engineer, Production Management, Construction  
SUBJECT **CES Lock Letter**

Letting (mo /yr) \_\_\_\_\_  
Financial Project ID \_\_\_\_\_  
State Project No \_\_\_\_\_ (Lead number only)  
WPI No \_\_\_\_\_  
Federal Aid Project Yes \_\_\_ No \_\_\_  
State Road No \_\_\_\_\_  
County \_\_\_\_\_

Enclosed is a copy of a complete plans set for use by the District Estimates Office  
This project has entered the Specifications Phase

**SAMPLE**

Exhibit 20-H

DATE \_\_\_\_\_ 1 of \_\_\_\_  
TO District Specifications Engineer  
FROM \_\_\_\_\_, Project Manager  
COPIES TO District Estimates Engineer  
SUBJECT **Change Memo**

Letting (mo/yr) \_\_\_\_\_  
Financial Project ID \_\_\_\_\_  
State Project No \_\_\_\_\_ (Lead number only)  
W P I No \_\_\_\_\_  
Federal Aid Project Yes \_\_\_ No \_\_\_  
County \_\_\_\_\_ State Road No \_\_\_\_\_

Changes were made to the plans during the District Specifications Phase. Sheets included replace similar sheets in the Preliminary Estimates plans copy. The changes listed below have been included in the specifications package.

<u>Sheets No (s)</u>	<u>Description of Change</u>
_____	_____
_____	_____
_____	_____
_____	_____
_____	_____
_____	_____
_____	_____
_____	_____
_____	_____
_____	_____
_____	_____
_____	_____
_____	_____
_____	_____
_____	_____
_____	_____
_____	_____
_____	_____
_____	_____
_____	_____
_____	_____

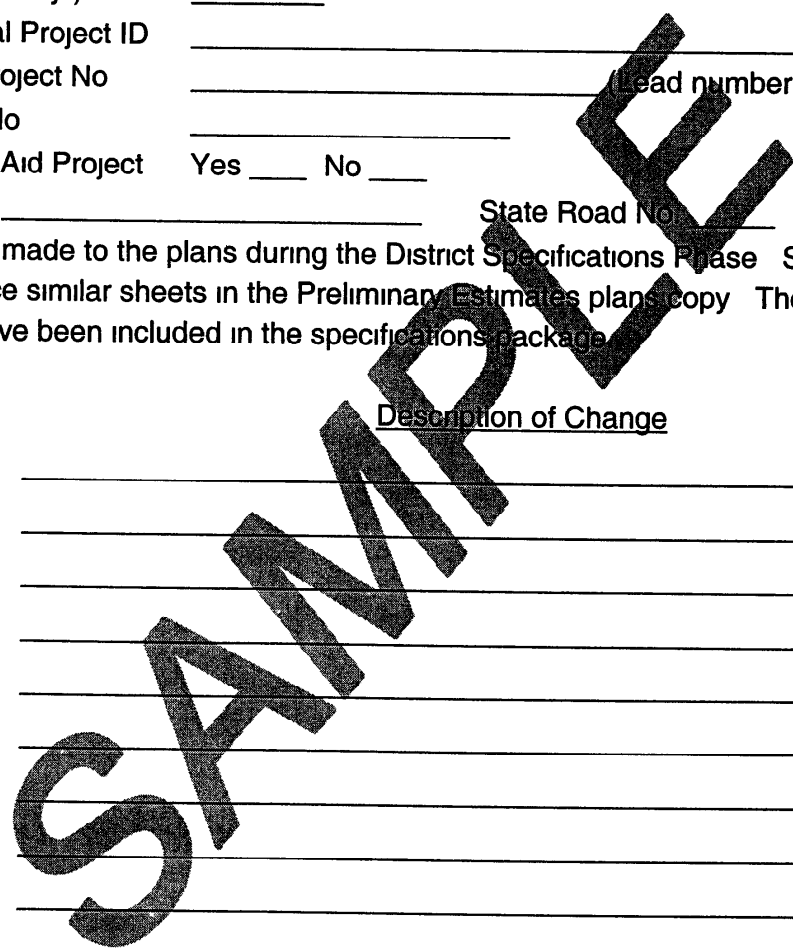



### REMINDER

Changes are modifications to the plans during the Specifications Phase. Insure that these are considered or incorporated into the Specifications and the Summary of Pay Items prior to mailing to the Plans Package to Tallahassee. Changes are not listed on the key sheet nor noted in the revision blocks of the plans sheets, unless done by other than the Engineer of Record.

Describe all changes in this Memo

List all Summary of Pay Items changes to quantities, including additions and deletions

Coordinate all changes with Specifications

**SAMPLE**



## **Chapter 21**

### **(RESERVED)**

**Chapter 22**

**ARCHITECTURAL PLANS**

**(PENDING)**

## Chapter 23

### DESIGN EXCEPTIONS AND DESIGN VARIATIONS

23.1	General	23-1
23.2	Design Exceptions	23-1
23.3	AASHTO Criteria for Critical Design Elements	23-2
23.4	Concurrence and Approval of Design Exceptions	23-10
23.5	Coordination of Design Exceptions	23-10
23.6	Justification and Documentation of Design Exceptions	23-11
23.7	Concurrence Review of Design Exceptions	23-12
23.8	Design Variations	23-12

#### Tables

23.3.1	AASHTO Design Speed (Minimum)	23-3
23.3.2	AASHTO Lane Widths (Minimum)	23-4
23.3.3	AASHTO Shoulder Widths (Minimum)	23-4
23.3.4	AASHTO Bridge Widths (Minimum)	23-5
23.3.5	AASHTO Structural Capacity (Minimum Loadings)	23-6
23.3.6	AASHTO Vertical Clearance (Minimum)	23-6
23.3.7	AASHTO Grades (Minimum and Maximum)	23-7
23.3.8	AASHTO Cross Slope (Minimum and Maximum)	23-7

23.3.9	AASHTO Superelevation (Maximum) . . . . .	23-8
23 3.10	AASHTO Horizontal Alignment . . . . .	23-8
23.3.11	AASHTO Vertical Alignment . . . . .	23-9
23.3.12	AASHTO Stopping Sight Distance . . . . .	23-9
23.3.13	AASHTO Horizontal Clearance (Minimum) . . . . .	23-9

Exhibits

23-A	Sample request letter for Design Exception . . . . .	23-14
23-B	Sample request letter for Design Variation . . . . .	23-15
23-C	Design Exception and Design Variation Flowchart . . . . .	23-16

## Chapter 23

### DESIGN EXCEPTIONS AND DESIGN VARIATIONS

#### 23.1 General

The Department's roadway design criteria and standards are contained in this volume and are usually within the desirable ranges established by AASHTO. The values given in this volume have been accepted by FHWA and govern the design process. When it becomes necessary to deviate from the Department's criteria, early documentation and approval are required. There are two documentation and approval processes, Design Exceptions and Design Variations. When the Department's criteria is met, no Design Exception nor any Design Variation is required. However, when the Department's criteria is not met, a Design Exception or Design Variation is required. This requirement applies to all entities affecting planning, design, construction, maintenance and utility placement.

To expedite the approval of these deviations, it is important that the correct approval processes be used. This chapter includes specific documentation and approval requirements for both the Design Exception and Design Variation approval processes. In both cases, the project file should clearly document the action taken and approval given. To aid in the identification and processing of Design Exceptions and Design Variations a flowchart has been provided ( see **Exhibit 23-C**).

#### 23.2 Design Exceptions

Design Exceptions are required when neither the Department's criteria nor AASHTO's criteria can be met for the following 13 Critical Design Elements

- |   |                     |    |                         |
|---|---------------------|----|-------------------------|
| 1 | Design Speed        | 8  | Cross Slope             |
| 2 | Lane Widths         | 9  | Superelevation          |
| 3 | Shoulder Widths     | 10 | Horizontal Alignment    |
| 4 | Bridge Widths       | 11 | Vertical Alignment      |
| 5 | Structural Capacity | 12 | Stopping Sight Distance |
| 6 | Vertical Clearance  | 13 | Horizontal Clearance    |
| 7 | Grades              |    |                         |

### 23.3 AASHTO Criteria for Critical Design Elements

As an aid to the designer, the following tables may be used as a reference for determining when a Design Exception is required (based on AASHTO criteria), but are in no way intended to replace FDOT design criteria. The page numbers referenced are to AASHTO's ***A Policy on Geometric Design of Highways and Streets 1994*** and are a starting point for researching project criteria.

***A Policy on Geometric Design of Highways and Streets 1994*** provides the minimum criteria adopted by FHWA. Criteria values in this document are exclusively in metric units. Conversions should be based on corresponding English values contained in ***A Policy on Geometric Design of Highways and Streets 1990***. Note that there are differences in certain criteria between the 1994 and 1990 editions and the 1994 edition will govern in case of conflict.

**Criteria Tables Cross Reference**

Table Number	Title	Page
Table 23.3.1	AASHTO Design Speed (Minimum)	23-3
Table 23.3.2	AASHTO Lane Widths (Minimum)	23-4
Table 23.3.3	AASHTO Shoulder Widths (Minimum)	23-4
Table 23.3.4	AASHTO Bridge Widths (Minimum)	23-5
Table 23.3.5	AASHTO Structural Capacity (Minimum Loadings)	23-5
Table 23.3.6	AASHTO Vertical Clearance (Minimum)	23-6
Table 23.3.7	AASHTO Grades	23-6
Table 23.3.8	AASHTO Cross Slope (Minimum and Maximum)	23-7
Table 23.3.9	AASHTO Superelevation	23-7
Table 23.3.10	AASHTO Horizontal Alignment	23-8
Table 23.3.11	AASHTO Vertical Alignment	23-8
Table 23.3.12	AASHTO Stopping Sight Distance	23-9
Table 23.3.13	AASHTO Horizontal Clearance (Minimum)	23-9



**Table 23.3.1 AASHTO Design Speed (Minimum)**

Type Facility	Other Factors	Design Speed (km/h)	AASHTO	
Freeways	Urban	80	pg 556	
	Rural	110		
Urban Arterials	Major	50	pg 67	
	Other	50		
Rural Arterials	Rolling terrain	80	pg 484	
	Level terrain	100		
Urban Collectors		50	pg 471	
Rural Collectors	Level ADT	< 400	60	pg 461, Table VI-1
		400 - 2000	80	
		> 2000	100	
	Rolling ADT	< 400	50	
		400 - 2000	60	
		> 2000	80	
CBD	Major or Minor	50	pg 471	
Ramps	Highway Design Speeds (km/h)		pg 918	
		50		20
		60		30
		70		40
		80		40
		90		50
		100		50
		110		60
	120	70		
Loop Ramps	45 m radius	40	pg 918	
Connections	Direct	60	pg 918	
	Semi-Direct	50		

**Table 23.3.2 AASHTO Lane Widths (Minimum)**

Type Facility	Lane Width (m)	AASHTO
Freeways	3.6	pg 557
Rural Arterial	3.3	pg 335
Urban Arterial	3.0	pg 515
Urban Collectors	3.0	pg 474
Rural Collectors	3.0	pg 465, Tbl VI-4
Low Speed	3.0	pg 335
Residential	2.7	pg 335
Auxiliary	3.0	pg 335, 474
Continuous TWLTL	3.0	pg 335

**Table 23.3.3 AASHTO Shoulder Widths (Minimum)**

Type Facility	Other Factors	Right	Median	AASHTO
Freeways	4 lanes	3.0 m	1.2 m	pg 557
	6 lanes	3.0 m	3.0 m	pg 557
Rural Arterial	DHV > 200	2.4 m		pg 488 Tbl VII-2
	ADT 400-2000	1.8 m		
	ADT < 400	1.2 m		
	Divided highway 4 lanes	2.4 m	1.2 m	pg 497
	Divided highway 6 lanes	2.4 m	2.4m (1.2 m with rigid constraints)	pg 498
Urban Arterial	Low Type	0.6 m		pg 338
	High Type	3.0 m		pg 338
	If barrier curb is used	1.8 m		pg 520
Heavily Traveled	High Speed ( $\geq 80$ km/h)	3.0 m		pg 338
Rural & Urban Collectors	ADT > 2000	2.4 m		pg 465 Tbl VI-4
	ADT 1500-2000	1.8 m		
	ADT 400-1500	1.5 m		
	ADT < 400	0.6 m		

**Table 23.3.4 AASHTO Bridge Widths (Minimum)**

Type Facility	Other Factors	Bridge Widths	AASHTO
Freeways	New Bridges	Approach Roadway Width	pg 559
Rural Arterial	New Bridges (Short)	Approach Roadway Width	pg 487
	Long Bridges ( $\geq 60$ m)	Travel lanes + 1.2m each side	pg 487
	Remain in Place	Travel Lanes + 0.6m each side	pg 487
Urban Arterial	Long ( $\geq 60$ m) with approach offset $< 1.2$ m wide	Curb to curb width of street	pg 524
	Long, with approach offset $> 1.2$ m wide	Travel lane + 1.2 m each side	pg 524
	All new bridges	Curb to curb width of street	pg 524

Type Facility	Other Factors	Bridge Widths		AASHTO
		New or Reconstruction	To Remain	
Rural Collectors	Under 400 ADT	Traveled Way + 0.6m each side <sup>(a)</sup>	6.6m <sup>(b)</sup>	pg 467
Urban	ADT 400-1500	Traveled Way + 1.0m each side <sup>(a)</sup>	6.6m <sup>(b)</sup>	pg 467
Collectors	ADT 1500-2000	Traveled Way + 1.2m each side <sup>(a)(c)</sup>	7.2m <sup>(b)</sup>	pg 467
	ADT $> 2000$	Approach Roadway Width <sup>(a)(c)</sup>	8.4m <sup>(b)</sup>	pg 467

- (a) If the approach roadway has paved shoulders, then the surfaced width shall be carried across the bridge
- (b) Bridges longer than 30 m are to be analyzed individually
- (c) For bridges  $\geq 30$  m in length, the minimum bridge width of traveled way plus 1.0 m on each side is acceptable

**Table 23.3.5 AASHTO Structural Capacity (Minimum Loadings)**

Type Facility	Other Factors	Loading <sup>(a)</sup>	AASHTO
Freeway	----	MS 18/HL-93	pg 558
Rural Arterial	----	MS 18/HL-93	pg 487
Urban Arterial	----	MS 18/HL-93	
Local Roads	New & Reconstruction Bridges Existing Bridges	MS 18/HL-93 MS 13 5/75% of HL-93	pg 423 Tbl V-7 pg 424 Tbl V-8
Collectors	New & Reconstruction Bridges Existing bridges	MS 18HL-93 MS 13 5/75% of HL-93	pg 467 Tbl V-5 pg 467 Tbl V-6

(a) HL-93 is loading from AASHTO LRFD Bridge Design Specifications

**Table 23.3.6 AASHTO Vertical Clearance (Minimum)**

Type Facility	Vertical Clearance (m)	AASHTO
Freeways	4.9 <sup>(a) (b)</sup>	pg 559, 828
Arterial Rural	4.9 <sup>(a) (b)</sup>	pg 487, 559, 828
Urban	4.9 <sup>(a) (b)</sup>	pg 515, 559, 828
Other Highways	4.3 <sup>(b)</sup>	pg 458, 559, 828
Sign Trusses	5.1 <sup>(b)</sup>	pg 559
Pedestrian Overpass	5.1 <sup>(b)</sup>	pg 559
Tunnels Freeways	4.9 <sup>(b)</sup>	pg 388
Other Highways	4.3 <sup>(b)</sup>	pg 388
Railroads	6.6 <sup>(b)</sup>	pg 574

(a) 4.3 m allowed in highly developed urban areas if alternate route has 4.9 m

(b) Minimum value that can be used without a Design Exception. An allowance of 150 mm should be added to vertical clearance to accommodate future resurfacing

**Table 23.3.7 AASHTO Grades**

**Maximum Grades**

Type Facility	Type Terrain	Grades (%) For Design Speed (km/h)							AASHTO
		50	60	70	80	90	100	110	
Freeway <sup>(a)</sup>	Level	-	-	-	4	4	3	3	pg 559 Tbl VIII-1
	Rolling	-	-	-	5	5	4	4	
Rural Arterial	Level	-	5	5	4	4	3	3	pg 485 Tbl VII-1
	Rolling	-	6	6	5	5	4	4	
Urban Arterial	Level	8	7	6	6	5	5	-	pg 514 Tbl VII-4
	Rolling	9	8	7	7	6	6	-	
Rural Collector <sup>(b)</sup>	Level	7	7	7	6	6	5	4	pg 463 Tbl VI-3
	Rolling	9	8	8	7	7	6	5	
Urban Collector <sup>(b)</sup>	Level	9	9	8	7	7	6	5	pg 463 Tbl VI-3
	Rolling	11	10	9	8	8	7	6	

- (a) Grades one percent steeper than the values shown may be used for extreme cases in urban areas where development precludes the use of flatter grades and for one-way down grades
- (b) Maximum grades shown for rural and urban conditions of short lengths (less than 150 m) on one-way down grades and on low-volume rural collectors may be 2% steeper

**Minimum Grades for Urban Curb & Gutter**

Type Facility	Minimum %	AASHTO
Arterials	as required for adequate drainage	pg 514
Collector Roads & Streets	0 30	pg 472
Local Roads & Streets	0 20	pg 430

**Table 23.3.8 AASHTO Cross Slope (Minimum and Maximum)**

Type Facility	Other Factors	Minimum	Maximum	AASHTO
Freeway		0 015	0 025 <sup>(a)</sup>	pg 557
Arterials	Rural	0 015	0 02 <sup>(a)</sup>	pg 487
	Urban	0 015	0 03	pg 514
Divided Highway		0 015	0 02 <sup>(a)</sup>	pg 497
Collectors	Rural	0 015	0 03	pg 464
	Urban	0 015	0 03	pg 472
Shoulders	Paved	0 02	0 06	pg 339
	Gravel	0 04	0 06	pg 339
	Turf	About 0 08 <sup>(b)</sup>	About 0 08 <sup>(b)</sup>	pg 339

- (a) The values given are for up to two lanes in one direction. Additional outside lanes may have cross-slopes of 0 03
- (b) Shoulder cross slopes which meet FDOT criteria do not require a Design Exception

**Table 23.3.9 AASHTO Superelevation (Maximum)**

Type Facility	Superelevation Rate	AASHTO
Open Highways (Rural)	0 12	pg 152
Urban	0 06	pg 152
Low Speed Urban w/severe constraints	None	pg 152
Ramps	See Table Below	

Radius (Meters)	Range in Superelevation Rate for Intersection Curves with Design Speed (km/h) of					
	20	30	40	50	60	70
15	02 - 10	-	-	-	-	-
25	02 - 07	02 - 10	-	-	-	-
50	02 - 05	02 - 08	04 - 10	-	-	-
70	02 - 04	02 - 06	03 - 08	06 - 10	-	-
100	02 - 03	02 - 04	03 - 06	05 - 09	08 - 10	-
150	02 - 03	02 - 03	03 - 05	04 - 07	06 - 09	09 - 10
200	02	02 - 03	02 - 04	03 - 05	05 - 07	07 - 09
300	02	02 - 03	02 - 03	03 - 04	04 - 05	05 - 06
500	02	02	02	02 - 03	03 - 04	04 - 05
700	02	02	02	02	02 - 03	03 - 04
1000	02	02	02	02	02	02 - 03

Preferably use superelevation rate in the upper half or third of the indicated range. For design speeds greater than 70 km/h see the superelevation chart for roadways. These rates are taken from 1994 AASHTO Table IX-12, page 730.

**Table 23.3.10 AASHTO Horizontal Alignment**

Minimum Radius (m) with Superelevation (page 156, Table III-6)

Type Facility	Super-elevation e-max	Minimum Curve Radius (m) for Design Speed (km/h)									
		30	40	50	60	70	80	90	100	110	120
Rural Highways & High Speed	04	35	60	100	150	215	280	375	490	635	870
	06	30	55	90	135	195	250	335	435	560	755
Urban Streets	08	30	50	80	125	175	230	305	395	500	665
	10	25	45	75	115	160	210	275	360	455	595
	12	25	45	70	105	150	195	255	330	415	540

Minimum Radius (m) for Section with Normal Cross Slope (page 172, Table III-12)

Type Facility	Minimum Curve Radius (m) for Design Speed (km/h)									
	30	40	50	60	70	80	90	100	110	120
All	450	800	1110	1520	2000	2480	3010	3680	4240	4690

Minimum Passing Sight Distance (page 462, Table VI-2B)

Design Speed (km/h)								
30	40	50	60	70	80	90	100	110
217	285	345	407	482	541	605	670	728

**Table 23.3.11 AASHTO Vertical Alignment**

(Taken from page 462, Table VI-2A)

Design Speed (km/h)	K Value <sup>(a)</sup> for Vertical Curves Rounded for Design	
	Crest	Sag
30	3	4
40	5	8
50	9	11
60	14	15
70	22	20
80	32	25
90	43	30
100	62	37
110	80	43

(a) The K value is a coefficient by which the algebraic difference in grade may be multiplied to determine the length in meters of the vertical curve which will provide the minimum Stopping Sight Distance

**Table 23.3.12 AASHTO Stopping Sight Distance**

(Taken from page 120, Table III-1)

Design Speed (km/h)	Stopping Sight Distance (m) Computed for Design
30	29.6
40	44.4
50	57.4
60	74.3
70	94.1
80	112.8
90	131.2
100	157.0
110	179.5

**Table 23.3.13 AASHTO Horizontal Clearance (Minimum)**

Feature	Clearance	AASHTO
Bridges	See Table 23.3.4	
Tunnels	1.1 m from edge of traffic lane	pg 387
Underpasses	2-lane Normal shoulder width (to edge of barrier) <sup>(a)</sup> Divided Roadway Normal shoulder (outside or median) width (to edge of barrier) <sup>(a)</sup>	pg 827 Fig X-5
Barrier Wall & Guardrail	Normal shoulder width	pg 827 Fig X-5
Light Poles <sup>(b)</sup>	Rural Outside Clear Zone Urban (Curb & Gutter) 0.5 m from face of curb	pg 310
Sign supports	Outside clear zone (if non-breakaway)	pg 314
Utility Poles <sup>(b)</sup>	Rural (Flush Shoulders) Outside Clear Zone Urban (Curb & Gutter) 0.5 m from face of curb	pg 312 pg 344,438,477
Building Line	4.5 m from elevated roadway (wall)	pg 574

(a) For metal guardrail, add deflection distance

(b) Exceptions for utility poles are to be in accordance with the current *Utility Accommodation Manual* exceptions procedure for horizontal clearance for utility poles

## **23.4 Concurrency and Approval of Design Exceptions**

Design Exceptions on projects having full federal oversight and involvement are recommended by the District Design Engineer for approval by the FHWA Division Administrator (see **Chapter 24**) All other projects are recommended by the Responsible Professional Engineer for approval by the District Design Engineer

Any Design Exception for design speed on the FHWS system shall require concurrence from the State Highway Engineer All other Design Exceptions require concurrence from the State Roadway Design Engineer

Design Exceptions impacting the geometry, vertical clearance, or layout of structures, or superstructure cross-slope require concurrence from the State Structures Design Engineer

Any Design Exception that reduces vertical clearance over an interstate roadway to less than 4.9 meters requires FHWA to coordinate with Military Traffic Management Command (MTMC) before the District Design Engineer can approve the Design Exception

## **23.5 Coordination of Design Exceptions**

In order to allow time to research alternatives and begin the analysis and documentation activities, it is critical that Design Exceptions be identified as early in the process as possible This is preferably done during the PD&E phase for major projects and during the scope development phase for minor projects

When the need for a Design Exception has been determined, the District Design Engineer or Responsible Professional Engineer must coordinate with the State Roadway Design Engineer to obtain conceptual concurrence and any required documentation requested by the State Roadway Design Engineer This coordination can be expedited by reviewing the Design Exception with the district's FDOT Area Design Engineer

For Design Exceptions requiring FHWA approval, the District Design Engineer must also coordinate with FHWA to obtain conceptual concurrence and any required documentation requested by FHWA This is usually done by also reviewing the Design Exception with the district's FHWA Area Engineer It is good practice to review the Design Exception with both the FHWA Area Engineer and the FDOT Area Design Engineer at the same time This will help expedite the approval and concurrence process

It is required that approval be obtained no later than the initial engineering phase



---

## 23.6 Justification and Documentation of Design Exceptions

Once conceptual concurrence of the Design Exception is obtained then justification must be documented. The objective of the justification of Design Exceptions is to demonstrate that the impacts on the operation and safety of the facility are acceptable compared to the impacts and added benefits of meeting the criteria. All Design Exception requests shall be signed and forwarded as per the sample request letter **Exhibit 23-A** and shall include documentation sufficient to justify the request and independently evaluate the operational and safety impacts. To meet State and Federal requirements, any request for a Design Exception must address the following issues, unless otherwise agreed upon during conceptual concurrence reviews.

- Description
  - a) Project description  
(general project information, typical section, etc )
  - b) Description of the Design Exception  
(specific project conditions related to Design Exception, Critical Design Element, acceptable AASHTO value and proposed value for project)
  - c) The compatibility of the design and operation with the adjacent sections
  
- Operational Impacts
  - a) Amount and character of traffic using the facility
  - b) Effect on capacity of the deviation  
(proposed criteria vs AASHTO using an acceptable capacity analysis procedure and calculate reduction for design year, level of service)
  
- Safety Impacts
  - a) Crash History and Analysis  
(location, type, severity, relation to the Design Exception element)  
Crash locations identified on plans or straight line diagrams if plans not available, are required for any exception
  - b) Impacts associated with proposed criteria  
(annualized value of expected economic loss associated with crashes)
  
- Benefit / Cost Analysis

Calculate a benefit / cost analysis which estimates the cost effectiveness of correcting or mitigating a substandard design feature. The benefit is the expected reduction in future accident costs and the cost is the direct construction and maintenance costs associated with the design. These costs are calculated and annualized so that a direct comparison of alternate designs can be made.

A benefit / cost ratio indicates the cost effectiveness of implementing a particular design, however, the final decision is a management decision which considers all

---

factors important to the successful implementation of the Department's mission

The key factors in the analysis are

- a) Evaluation of crashes by type and cause,
- b) Estimate of crash costs (based on property damage and severity of injuries),
- c) Selection of an crash reduction factor,
- d) Selection of a discount rate, (currently at 7%)
- e) Estimate of construction and maintenance costs,
- f) Selection of life of the improvements,
- g) Period of time over which the benefits will be realized

**Chapter 2 of the Roadside Design Guide** and the **FHWA Technical Advisory** titled "Motor Vehicle Accident Costs" and dated October 31, 1994 provide guidance for the benefit / cost analysis

- Conclusion and Recommendation
  - a) The cumulative effect of other deviations from design criteria,
  - b) Safety mitigating measures considered and provided,
  - c) Summarize specific course of action  
(Include conditional requirements such as projects in the work program that will fix deficiency)

## **23.7 Concurrence Review of Design Exceptions**

After the documentation justifying the Design Exception is signed and forwarded to the State Roadway Design Engineer, the Design Exception will be reviewed for completeness and adherence to the requirements of **Sections 23.5** and **23.6**

If the Design Exception complies with all requirements, the concurrence will be signed by the appropriate engineer. When necessary, the Design Exception will be forwarded to FHWA for approval by the State Roadway Design Engineer

Once all signatures are obtained, the Design Exception will be returned to the District Design Engineer or Responsible Professional Engineer. A copy will be retained by the State Roadway Design Engineer

## **23.8 Design Variations**

Design Variations are required when deviations from the Department's criteria occur. However, when any of the 13 Critical Design Elements require a Design Exception, the Exception will be processed in lieu of a Design Variation

---

A Design Variation request must address the following items

- Design criteria vs proposed criteria
- Reason the design criteria is not appropriate
- Justification for the proposed criteria
- Any background information which documents or justifies the request

Requests begin with the Responsible Professional Engineer. Requests are submitted to the District Design Engineer for approval. This approval shall be documented in the project file as per the sample request letter **Exhibit 23-B**. A copy of the approved Design Variation is to be sent to the State Roadway Design Engineer.

Any Design Variation for design speed on the FHWS system shall require concurrence from the State Highway Engineer. Any issue impacting the geometry, vertical clearance, layout of structures or superstructure cross-slope shall require concurrence from the District Structures Design Engineer for Category 1 structures or the State Structures Design Engineer for all other structures.

As with Design Exceptions, it is critical that Design Variations be identified as early in the process as possible, preferably during the PD&E phase for major projects and during the scope development phase for minor projects.

When the need for a Design Variation has been determined, it is required that approval be requested no later than Phase II for major projects, and the initial engineering phase for minor projects.

TO <sup>(a)</sup> \_\_\_\_\_

DATE \_\_\_\_\_

**SUBJECT DESIGN EXCEPTION**

Financial Project ID \_\_\_\_\_  
State Road number \_\_\_\_\_  
Fed Aid No \_\_\_\_\_  
Project description \_\_\_\_\_  
New construction \_\_\_\_\_ RRR \_\_\_\_\_

**Design Exception for the following element**

- Design Speed<sup>(d)</sup>
- Structural Capacity
- Superelevation
- Horizontal Clearance
- Lane Widths
- Vertical Clearance
- Horizontal Alignment
- Shoulder Widths
- Grades
- Vertical Alignment
- Bridge Widths
- Cross Slope
- Stopping Sight Distance

Include a brief statement concerning the project and items of concern

Attach all supporting documentation to this exhibit in accordance with **Section 23.6**

Recommended By <sup>(b)</sup> \_\_\_\_\_ Approval <sup>(c)</sup> \_\_\_\_\_

Concurrence<sup>(d)</sup> \_\_\_\_\_

Concurrence<sup>(e)</sup> \_\_\_\_\_  
State Structures Design Engineer

- (a) Design Exceptions on projects having full federal oversight and involvement are addressed to the FHWA Division Administrator All other Design Exceptions are sent to the District Design Engineer
- (b) Design Exceptions on projects having full federal oversight and involvement are recommended by the District Design Engineer All other Design Exceptions are recommended by the Responsible Professional Engineer
- (c) Design Exceptions on projects having full federal oversight and involvement are approved by the FHWA Division Administrator All other Design Exceptions are approved by the District Design Engineer
- (d) Design Exceptions for Design Speed on the FIHS system requires concurrence from the State Highway Engineer All other Design Exceptions require concurrence from the State Roadway Design Engineer
- (e) Design Exceptions impacting the geometry, vertical clearance, layout of structures, or superstructure cross-slope require concurrence from the State Structures Design Engineer

**Exhibit 23-A**

TO \_\_\_\_\_, District Design Engineer

Date \_\_\_\_\_

**SUBJECT DESIGN VARIATION**

Financial Project ID \_\_\_\_\_  
State Road number \_\_\_\_\_  
Fed Aid No \_\_\_\_\_  
Project description \_\_\_\_\_  
New construction \_\_\_\_\_ RRR \_\_\_\_\_

**Design Variation for the following element**

- Design Speed<sup>(b)</sup>       Lane Widths       Shoulder Widths       Bridge Widths
- Structural Capacity       Vertical clearance       Grades       Cross Slope
- Superelevation       Horizontal Alignment       Vertical Alignment       Stopping Sight Distance
- Horizontal Clearance       Other \_\_\_\_\_

Include a brief statement concerning the project and items of concern

Indicate the design elements for which the Design Variation is being requested, along with a specific description of the Design Variation

Address all issues and each of the Items listed under **Section 23.8**

Attach all supporting documentation to this exhibit

Recommended By \_\_\_\_\_  
Responsible Professional Engineer  
(Name of Consultant Firm)

Approval \_\_\_\_\_  
District Design Engineer

Concurrence<sup>(a)</sup> \_\_\_\_\_  
(State or District) Structures Design Engineer

Concurrence<sup>(b)</sup> \_\_\_\_\_  
State Highway Engineer

(a) Design Variations impacting the geometry, vertical clearance, layout of structures, or superstructure cross-slope require concurrence from the District Structures Design Engineer for Category 1 structures or from the State Structure Design Engineer for all other structures

(b) Design Variations for Design Speed on the FHIS system requires concurrence from the State Highway Engineer

**Exhibit 23-B**

# Design Exceptions and Design Variations Flowchart

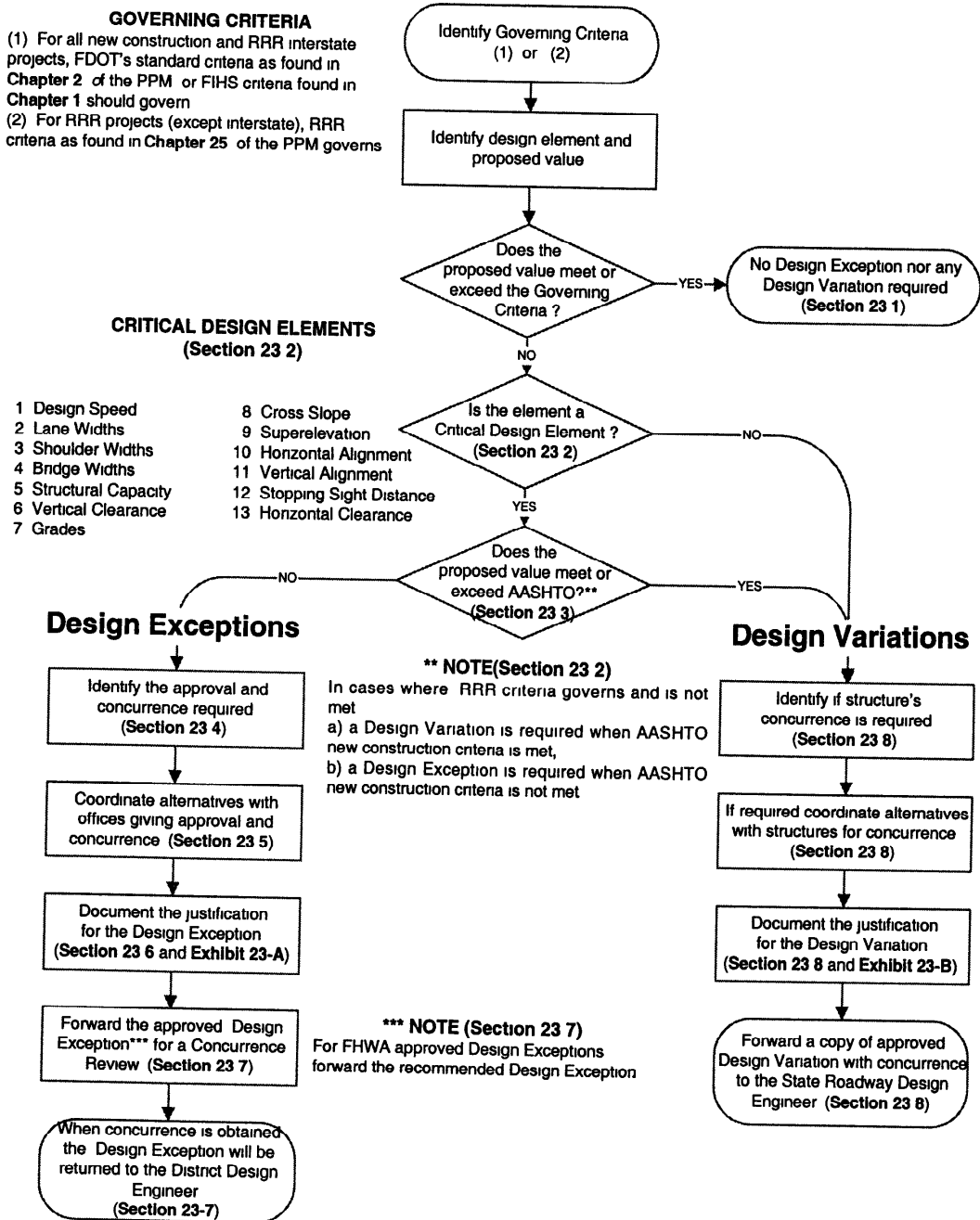

**Exhibit 23-C**

---

## Chapter 24

### FEDERAL AID PROJECT CERTIFICATION

24.1	General . . . . .	24-1
24.2	Exemption Coverage . . . . .	24-1
24.2.1	Exclusions . . . . .	24-2
24.3	Certification Responsibilities . . . . .	24-3
24.4	Certification Documentation and Reviews . . . . .	24-5
24.5	Certification Statement . . . . .	24-5
Exhibit 24-A	. . . . .	24-6
Exhibit 24-B	. . . . .	24-7
Exhibit 24-C	. . . . .	24-8

## Chapter 24

### FEDERAL AID PROJECT CERTIFICATION

#### 24.1 General

The Florida Department of Transportation has a formal agreement with the Federal Highway Administration to administer specific Federal-aid highway projects exempt from FHWA oversight. See **Exemption Agreement and 23 USC 106 Exception Process, Topic Number 625-010-000**. Under this agreement FHWA accepts the Department's certification that the design and construction phases of specific Federal-Aid highway projects on the National Highway System (NHS) have been carried out in accordance with all appropriate Department manuals, guidelines and procedures, and in compliance with all applicable Federal Statutes, Regulations, Executive Orders, and FHWA Directives and Standards. The Department assumes the oversight responsibilities and duties previously performed by FHWA during the final design, award and construction of these federally funded projects.

This agreement does not preclude FHWA access to and review of Federal-aid projects at any time, and does not replace the fundamental provisions of law in Title 23 with respect to the basic structure of the Federal-aid program. FHWA may at any time have access to and review project phases and records under the exemption agreement. In accordance with **23 CFR 17.5**, records will be retained for a minimum of three years or until litigation, claims or audit findings initiated before the three-year period have been resolved.

#### 24.2 Exemption Coverage

The exemption process (permitted under **23 U.S.C. 106**) applies to the design and construction of all Federal-Aid highway projects except new or reconstruction projects on the Interstate System with cost estimates greater than \$1 million. All Interstate RRR and National Highway System projects off the Interstate System are covered under the exemption process.

The Exemption Agreement does not prohibit FHWA's involvement, at the Department's request, in the review of design plans and subsequent participation in construction inspections of major, unusual or innovative structures on Non-Interstate Systems within the State. The Department is encouraged to include FHWA in such projects to the extent



practical

### 24.2.1 Exclusions

Full FHWA oversight procedures will be followed on all Federal Aid construction/reconstruction projects on the Interstate System with cost estimates greater than \$1 million. For these oversight projects, there are certain special features that will require special FHWA review and involvement in addition to normal FHWA reviews. These special features are:

- A Individual structures with an estimated total deck area greater than 125,000 square feet
- B Major storm drainage systems designed to carry more than 200 cfs
- C Storm drainage systems which have a surface detention storage with an accumulated volume greater than five acre-feet
- D Storm water pumping facilities designed to discharge more than 20 cfs
- E Unusual or moveable bridges, unusual hydraulic structures and unusual geotechnical structures

Other areas not exempt from FHWA oversight and not covered under the exemption agreement include:

- Activities for compliance with Section 102 (2)(c) of the National Environmental Policy Act (NEPA) of 1969 (42 USC 4321 et seq.) And 23 CFR 771. Project Evaluations must still be submitted to the FHWA for review and appropriate action as required in 23 CFR 771.129 in accordance with normal procedures as outlined in FDOT's PD&E Guidelines
- Activities for compliance with Section 4(f) of the Department of Transportation Act of 1966, P L 89-665, 49 USC 303
- Activities for compliance with any other federal law other than Title 23
- Highway Safety, Title 23, Chapter 4
- Public Transportation Projects not administered by the FHWA under Title 23
- Civil Rights Act of 1964, 42 USC 2000(d) et seq. And 23 CFR 200 (Title VI), and 23 CFR 230 (EEO)
- Uniform Relocation and Assistance and Real Properties Acquisition Policies Act of 1970, 42 USC 4601, et seq. 23 CFR Parts 710-740 and 49 CFR Part 24 (Administered under the Right of Way Certification Program approved by FHWA for statewide use on August 7, 1998)
- Executive Order 12372, Intergovernmental Review of Federal Programs
- Transportation Planning and Research, 23 USC 134 & 307

- Buy America provisions, 23 CFR 635 10
- Minimum wage provisions, Davis Bacon, 23 USC 113
- Advertising and Award of construction contracts, 23 CFR 112
- Procurement of consultant services, 23 CFR 172
- The use of proprietary or sole source items or materials

### **24.3 Certification Responsibilities**

The final design documents, reports and plans for projects exempt from FHWA oversight will be developed in accordance with all applicable Department manuals, guidelines and procedures, and in compliance with all applicable Federal Statutes, Regulations, Executive Orders, and FHWA Directives and Standards. The Department is responsible for assuring that all appropriate criteria has been adhered to, and for documenting its findings in lieu of FHWA reviews. Several of the major areas and the method to be used by the Department to document the acceptability of various final design activities in place of an FHWA review and approval are

#### **A Typical Section Package**

The typical section package should be prepared as described in **Chapter 16, Sections 16.2.3** and **16.3.2** of this volume. Concurrence by the District Design Engineer documents the acceptability of the package. Concurrence from the District Structures Engineer may also be required on unusual bridge typical sections.

#### **B Pavement Design Package**

The pavement design is developed and approved by the responsible professional engineer in accordance with Department pavement design procedures. Concurrence from the District Design Engineer is required to document the acceptability of the package in lieu of FHWA review and concurrence.

#### **C Bridge Hydraulics Report**

The hydraulics report is developed and approved by the responsible professional engineer in accordance with appropriate design standards. Concurrence from the District Drainage Engineer is required to document the acceptability of the package in lieu of FHWA review and concurrence.

#### **D Bridge Development Report**

The bridge development report is developed and approved by the responsible professional engineer in accordance with appropriate design standards. Concurrence from the District Design, Structures, or Project Management Engineer is required to document the acceptability of the report in lieu of FHWA review and concurrence.

**E Design Plans Phase Reviews**

Plan reviews should be conducted as described in **Chapter 16** of this volume. Concurrence in the resolution of phase review comments from the District Design, Structures, or Project Management Engineer is required to document the acceptability of the reviews in lieu of FHWA review and concurrence (See **Exhibit 24-B** )

**F Design Exceptions**

Design Exceptions on projects not under full FHWA oversight require approval and concurrence as described in Chapter 23 of this volume

**G Special Provisions**

Special provisions, which include project specific and technical special provisions, will be developed and approved by the responsible professional engineer. Concurrence from the District Specifications Engineer is required to document the acceptability of the special provisions in lieu of FHWA review and concurrence (See **Exhibit 24-C** )

**H Plans, Specifications and Estimate**

The plans package, specification package and contract file will be transmitted to Tallahassee as described in **Chapter 20** of this volume. The District Production Director will sign the transmittal letter certifying that the design and plans have been prepared according to the appropriate certification procedures. The specifications package will be approved by the District Specifications Engineer. The Department's official estimate will be approved by the State Estimates Engineer.

**I Authorization to Advertise**

The letter requesting FHWA authorization to advertise for bids and the PS&E package, including reimbursable utility agreements, will be submitted to FHWA by the Federal Aid Office. The Federal Aid Manager will certify in the letter to FHWA that the package was prepared under the appropriate certification procedures. An FHWA PS&E checklist (the Contract File Index, filled out by the District and submitted with the plans package) will be submitted to FHWA.

**J Revisions**

Revisions to the PS&E will be processed as described in **Chapter 20** of this volume. Concurrence from the District Design, Structures, or Project Management Engineer is required to document the acceptability of the revision in lieu of FHWA review and concurrence.

In special cases where programs or projects are developed in the Central Office, an

appropriate Central Office Manager will provide any necessary concurrences in lieu of a District Manager. **Exhibit 24-A** outlines the approval and concurrence procedures used in the exemption process.

#### **24.4 Certification Documentation and Reviews**

FHWA will perform periodic reviews of projects developed under the exemption agreements and may have access to review project phases and records at any time. To support the exemption program, adequate documentation throughout the design phase is critical. All approvals and concurrences outlined in the previous section must be sufficiently documented. A complete, well-organized design project file should be able to support a compliance review. All correspondence and documents must include the federal aid project number. The Quality Assurance procedures described in **Chapter 18** of this volume will be used by the Central Office to monitor district compliance with the certification requirements.

#### **24.5 Certification Statement**

The following statement will be furnished by the District (in the Contract File, see **Chapter 20** exhibits) when plans are transmitted for letting. The same statement will be included in the letter requesting authorization (PR1240/PR2).

"The District Director of Production certifies that all work will meet or exceed, except as noted below, the standards approved by the Secretary of the U.S. Department of Transportation under 23 USC (109)(c)."

A list of all design exceptions, the dates requested and the dates approved must be immediately below the statement. If there were no exceptions on the project, a statement to that effect must be shown immediately below the statement. Copies of the approved design exceptions may be requested, if the Central Office files do not contain copies.

**Approval and Concurrence Process**

<p><b>TYPICAL SECTION PACKAGE</b></p> <p>Approved 6                  Concurrence 3 or 4</p> <p>( PPM Vol I, Chap 16 2 3 )</p>	<p><b>PAVEMENT DESIGN PACKAGE</b></p> <p>Approved 6                  Concurrence 3</p> <p>( Pav't Design Manual )</p>		
<p><b>BRIDGE DEVELOPMENT REPORT</b></p> <p>Approved 6                  Concurrence 3 4 5 or 7</p> <p>( PPM Vol I, Chap 26 )</p>	<p><b>APPROVAL OF PHASE REVIEW PLANS (Roadway and Structures)</b></p> <p>Approved 6                  Concurrence 3 4 5 or 7</p> <p>( PPM Vol I, Chap 16 )</p>		
<p><b>ACCIDENT/SAFETY REVIEW</b></p> <p>Approved Dist Safety Engr</p>	<p><b>SPECIAL PROVISIONS</b></p> <p>Approved 6                  Concurrence 9</p>		
<p><b>DESIGN CRITERIA DESIGN EXCEPTIONS</b></p> <p>Requested 3 or 6                  Concurrence 8, and 7 when needed                  Approved FHWA or 11</p> <p>( PPM Vol I, Chap 23 )</p>	<p><b>BRIDGE HYDRAULICS REPORT</b></p> <p>Approved 6                  Concurrence Dist Drainage Engr</p> <p>( Drainage Manual, Chap 4 )</p>		
<p><b>PLANS, SPECIFICATIONS AND ESTIMATE</b></p> <p><b>PLANS PACKAGE</b>                  Approved 2</p> <p><b>SPECIFICATIONS PACKAGE</b>                  Approved 9</p> <p><b>OFFICIAL ENGINEERS ESTIMATE</b>                  Approved 10</p> <p>( PPM Vol 1, Chap 20 3 )</p>	<p><b>REVISIONS TO PS &amp; E</b></p> <p>Approved 6                  Concurrence 3 4 or 5</p> <p>( PPM Vol I, Chap 20 4 )</p>		
	<p><b>ASSEMBLY OF PS &amp; E &amp; CERTIFICATION OF OTHER REPORTS AS REQUIRED</b></p> <p>Responsibility FA Manager</p>		
<table border="0"> <tr> <td data-bbox="203 1354 730 1596"> <ol style="list-style-type: none"> <li>1 DISTRICT SECRETARY</li> <li>2 DISTRICT PRODUCTION DIRECTOR</li> <li>3 DISTRICT DESIGN ENGINEER</li> <li>4 DISTRICT STRUCTURES DESIGN ENGINEER</li> <li>5 DISTRICT PROJECT MANAGEMENT ENGINEER</li> <li>6 RESPONSIBLE PROFESSIONAL ENGINEER</li> <li>7 STATE STRUCTURES DESIGN ENGINEER</li> <li>8 STATE ROADWAY DESIGN ENGINEER</li> <li>9 DISTRICT SPECIFICATIONS ENGINEER</li> <li>10 STATE ESTIMATES ENGINEER</li> <li>11 STATE DIRECTOR OF DESIGN (for exempt projects)</li> </ol> </td> <td data-bbox="755 1417 1291 1533"> <p><b>NOTE</b>                      In special cases where programs or projects are developed in the Central Office, an appropriate Central Office Manager will provide concurrence in lieu of the District Manager</p> </td> </tr> </table>		<ol style="list-style-type: none"> <li>1 DISTRICT SECRETARY</li> <li>2 DISTRICT PRODUCTION DIRECTOR</li> <li>3 DISTRICT DESIGN ENGINEER</li> <li>4 DISTRICT STRUCTURES DESIGN ENGINEER</li> <li>5 DISTRICT PROJECT MANAGEMENT ENGINEER</li> <li>6 RESPONSIBLE PROFESSIONAL ENGINEER</li> <li>7 STATE STRUCTURES DESIGN ENGINEER</li> <li>8 STATE ROADWAY DESIGN ENGINEER</li> <li>9 DISTRICT SPECIFICATIONS ENGINEER</li> <li>10 STATE ESTIMATES ENGINEER</li> <li>11 STATE DIRECTOR OF DESIGN (for exempt projects)</li> </ol>	<p><b>NOTE</b>                      In special cases where programs or projects are developed in the Central Office, an appropriate Central Office Manager will provide concurrence in lieu of the District Manager</p>
<ol style="list-style-type: none"> <li>1 DISTRICT SECRETARY</li> <li>2 DISTRICT PRODUCTION DIRECTOR</li> <li>3 DISTRICT DESIGN ENGINEER</li> <li>4 DISTRICT STRUCTURES DESIGN ENGINEER</li> <li>5 DISTRICT PROJECT MANAGEMENT ENGINEER</li> <li>6 RESPONSIBLE PROFESSIONAL ENGINEER</li> <li>7 STATE STRUCTURES DESIGN ENGINEER</li> <li>8 STATE ROADWAY DESIGN ENGINEER</li> <li>9 DISTRICT SPECIFICATIONS ENGINEER</li> <li>10 STATE ESTIMATES ENGINEER</li> <li>11 STATE DIRECTOR OF DESIGN (for exempt projects)</li> </ol>	<p><b>NOTE</b>                      In special cases where programs or projects are developed in the Central Office, an appropriate Central Office Manager will provide concurrence in lieu of the District Manager</p>		

**Exhibit 24-A**

DATE

TO (See Below)\*

FROM

COPIES

SUBJECT Response to \_\_\_\_\_ Phase Review

REF Financial Project ID  
W P I Number  
State Project Number  
F A Project Number  
County

In content of letter include a statement confirming that all review comments have been responded to or satisfactorily resolved

Include appropriate copies of review comments, responses and other pertinent data

APPROVED

CONCURRENCE

\_\_\_\_\_  
Responsible Professional Eng  
(Name of Consultant Firm)

\_\_\_\_\_  
\* District Design Engineer  
\* District Structures Engineer  
\* District Project Mgmt Eng

\* As appropriate

**Exhibit 24-B**

DATE

TO District Design, Structures or  
Project Management Engineer

FROM

COPIES State Specifications Engineer

SUBJECT Special Provisions

REF Financial Project ID  
W P I Number  
State Project Number  
F A Project Number  
County

Include detailed information concerning special provisions required

Appropriate section(s) of F D O T Standard Specifications should be referenced

Questions concerning format and content should be directed to the Specifications Office  
of F D O T

APPROVED

CONCURRENCE

\_\_\_\_\_  
Responsible Professional Eng  
(Name of Consultant Firm)

\_\_\_\_\_  
\* District Design Engineer  
\* District Structures Engineer  
\* District Project Mgmt Eng

\* As appropriate

**Exhibit 24-C**

## **Chapter 25**

### **FLORIDA'S DESIGN CRITERIA FOR RESURFACING, RESTORATION AND REHABILITATION (RRR) OF STREETS AND HIGHWAYS**

25.1	Introduction . . . . .	25-1
25 1 1	General . . . . .	25-1
25 1 2	Application . . . . .	25-1
25 2	Planning and Programming RRR Projects . . . . .	25-2
25 2 1	Projects Requiring Right-of-Way . . . . .	25-2
25 2 2	Projects with Bridges within Project Limits . . . . .	25-2
25 2 3	Project Features Requiring Exceptions and Variations . . . . .	25-2
25 3	RRR Project Design Process . . . . .	25-2
25 3 1	Review of Project Purpose . . . . .	25-3
25 3 1 1	Principal Reason(s) for the RRR Project . . . . .	25-3
25 3 1 2	General Nature of Proposed Improvements (Type of Work) . . . . .	25-3
25 3.1 3	Review Project Budget and Priority . . . . .	25-4
25 3 2	Assessment of Conditions . . . . .	25-4
25 3 2 1	Office Reviews . . . . .	25-4
25 3.2.2	Field Reviews . . . . .	25-5
25 3 3	Project Scopes . . . . .	25-6
25 3 4	Review Project Plans . . . . .	25-7
25 3 5	Document the Design Process . . . . .	25-8
25 4	RRR Design Criteria . . . . .	25-8
25 4.1	Design Period . . . . .	25-9
25.4 2	Design Traffic Volume . . . . .	25-9
25 4 3	Pavement Design . . . . .	25-9
25 4 4	Design Speed . . . . .	25-9
25 4 5	Lane and Shoulder Widths . . . . .	25-10



25.4.6	Roadway Cross Slopes . . . . .	25-11
25.4.7	Superelevation . . . . .	25-12
25.4.8	Shoulder Treatment . . . . .	25-12
25.4.9	Side Slopes . . . . .	25-12
25.4.10	Vertical Alignment . . . . .	25-13
25.4.10.1	Vertical Curvature . . . . .	25-14
25.4.10.2	Grades . . . . .	25-14
25.4.11	Horizontal Alignment . . . . .	25-15
25.4.11.1	Horizontal Curves . . . . .	25-16
25.4.11.2	Stopping Sight Distance (Horizontal Curvature)	25-18
25.4.12	Stopping Sight Distance . . . . .	25-19
25.4.13	Vertical Clearance . . . . .	25-19
25.4.14	Horizontal Clearance . . . . .	25-19
25.4.15	Control Zones . . . . .	25-23
25.4.16	Border . . . . .	25-24
25.4.17	Intersections . . . . .	25-24
25.4.18	Drainage . . . . .	25-25
25.4.19	Pedestrian and Bicyclist Needs . . . . .	25-25
25.4.20	Utilities (Underground and Overhead) . . . . .	25-26
25.4.21	At-grade Railroad Crossings . . . . .	25-26
25.4.22	Aesthetics and Landscaping . . . . .	25-26
25.4.23	Highway Lighting . . . . .	25-26
25.4.24	Highway Traffic Control Devices . . . . .	25-27
25.4.25	Bridges . . . . .	25-27
25.4.25.1	Bridge Loading . . . . .	25-27
25.4.25.2	Bridge Width . . . . .	25-27
25.4.25.3	Bridge Railing . . . . .	25-28
25.4.25.4	Vertical Clearance . . . . .	25-28
25.4.25.5	Considerations . . . . .	25-29
25.4.26	Roadside Safety Hardware . . . . .	25-29
25.4.26.1	Longitudinal Barriers, Guardrails, Median Barriers . . . . .	25-29
25.4.26.2	Guardrail to Bridge Rail Transitions . . . . .	25-30
25.4.26.3	Guardrail Terminals . . . . .	25-30

25.4 26 4 Crash Cushions and Attenuators . . . . . 25-30

25 5 Design Exceptions and Variances . . . . . 25-31

Tables

25.4.5.1 Lane and Shoulder Widths - Rural Multilane . . . . . 25-10

25 4.5 2 Lane and Shoulder Widths - Two Lane Rural  
and Urban, Without Curb and Gutter . . . . . 25-11

25 4.5.3 Lane and Shoulder Widths - Urban Multilane  
or Two Lane with Curb and Gutter . . . . . 25-11

25.4.6 Roadway Cross Slopes . . . . . 25-12

25.4.10 Stopping Sight Distance for Vertical Curvature . . . . . 25-15

25.4 11 1 Safe Criteria for State Highway System  
With Maximum Superelevation . . . . . 25-18

25 4.11.2 Stopping Sight Distance for Horizontal Curvature . . . . . 25-18

25.4.14.1 Clear Zone - Flush Shoulders . . . . . 25-20

25 4 14 2 Horizontal Clearance for Traffic Control Signs . . . . . 25-20

25.4.14.3 Horizontal Clearance for Light Poles . . . . . 25-21

25.4.14.4 Horizontal Clearance for Utility Installations . . . . . 25-21

25.4.14.5 Horizontal Clearance to Signal Poles and Controller  
Cabinets for Signals . . . . . 25-21

25.4 14 6 Horizontal Clearance to Trees . . . . . 25-22

25.4.14.7 Horizontal Clearance to Bridge Piers and Abutments . . 25-22

25.4.14 8 Horizontal Clearance to Railroad Grade Crossing  
Traffic Control Devices . . . . . 25-22

25.4.14.9 Horizontal Clearance to Other Roadside Obstacles . . . . 25-23

25 4.25.1 Bridge Loading . . . . . 25-27

25.4.25.2 Clear Width Criteria for Bridges . . . . . 25-28

Exhibits

25-A Control Zones . . . . . 25-32

## Chapter 25

# FLORIDA'S DESIGN CRITERIA FOR RESURFACING, RESTORATION AND REHABILITATION (RRR) OF STREETS AND HIGHWAYS

### 25.1 Introduction

#### 25.1.1 General

Resurfacing, restoration and rehabilitation (RRR) work is defined as work undertaken to extend the service life of an existing highway and/or enhance highway safety. This includes the placement of additional surface materials and/or other work necessary to return an existing roadway to a condition of structural and functional adequacy. Many of the RRR Standards used by the Department are derived from the *National Academy of Sciences "Special Report 214"*. This publication contains many of the methods necessary to make the safety and cost effective evaluations required by this chapter.

RRR projects must be designed and constructed in a manner that will comply with the accessibility standards and requirements set forth in the *Americans with Disabilities Act of 1990 (ADA)*.

#### 25.1.2 Application

The criteria included herein are for all RRR projects except Interstate, freeways, and Florida Intrastate Highway System (FIHS) facilities, and are not intended to apply to new construction or major modifications of existing facilities. Interstate and freeway RRR projects are designed using new construction criteria except that the standards used for horizontal alignment, vertical alignment, widths of median, traveled way and shoulders may be the AASHTO interstate standards that were in effect at the time of original construction or inclusion into the interstate system.

Projects on FIHS facilities are designed using new construction criteria. However, RRR criteria may be applied on controlled access FIHS facilities to the extent permitted by the FIHS Corridor Plan and consistent with the schedule for phased improvements to bring the facility up to new construction criteria.

The RRR criteria may be used for establishing the minimum requirements for intersection improvement projects with the understanding that when right-of-way is adequate, new construction criteria will be used to the maximum extent feasible.

## **25.2 Planning and Programming RRR Projects**

RRR projects must balance a number of competing objectives, the principal ones being the preservation of highways, improved service levels and enhancement of safety. The success in meeting these objectives depends on the quality of individual project designs and project programming decisions.

### **25.2.1 Projects Requiring Right-of-Way**

Facilities programmed for RRR projects should be given a review of the existing right-of-way, roadway, access management, drainage design elements and other improvements to identify locations which require additional right-of-way. For such locations, the design should be expedited to determine actual right-of-way requirements. The designer must coordinate the requirements with the Right-of-Way Office so that necessary areas will be cleared before the project is ready for letting.

### **25.2.2 Projects with Bridges within Project Limits**

Bridges must be reviewed in sufficient detail to clearly establish the cost effective and appropriate changes to be included in the project design effort.

### **25.2.3 Project Features Requiring Exceptions and Variations**

Projects may have features below criteria values which have not been programmed and/or which are determined not to be appropriate to accomplish under this design project. These usually require design exception or variation approval, as appropriate. See Sections 25.3.5 and 25.5.

## **25.3 RRR Project Design Process**

Significant improvements in overall safety can be brought about by a systematic safety conscious design process. The design process is a team effort which requires the expertise of persons familiar with design, safety, maintenance, traffic operations and others. To assure that safety issues are fully addressed on RRR projects, in addition to the usual design process, the following are also required:

- A review of the purpose for which the RRR project was programmed
- An assessment of current safety conditions
- A final scope of work with recommendations for specific safety improvements

- Documentation of the safety design decisions
- Reviews of the design for safety issues

### **25.3.1 Review of Project Purpose**

A RRR project is generated by specific needs or conditions. The designer must become familiar with these needs or conditions at the very beginning of involvement with the project in order to assure that the final scope of work and final design actually accomplish the original purpose of the project. This may involve research of background data or other information that provide the reason, the proposed improvements, estimated project cost and project priority.

#### **25.3.1.1 Principal Reason(s) for the RRR Project**

The following list indicates some, but not all, of the principal reasons that can generate a RRR project.

- a To preserve or extend the life of the existing pavement
- b Improve capacity (without adding continuous through lanes)
- c Improve operating characteristics
- d Site specific crash reduction
- e Section wide crash reduction
- f General safety modifications

#### **25.3.1.2 General Nature of Proposed Improvements (Type of Work)**

In addition to resurfacing, restoration and rehabilitation a project may include one or more of the following types of work as a general improvement. The list is not all inclusive.

- a Widen roadway and bridge lanes
- b Widen or add roadway and bridge shoulders
- c Provide disability access
- d Provide clear zone
- e Upgrade pavement markings
- f Add, update or remove traffic signals

- g Correct skid hazards
- h Replace bridges rated "insufficient"
- i Upgrade bridge rail
- j Upgrade to current Access Management requirements
- k Provide non-vehicular transportation needs
- l Add or extend auxiliary lanes to a roadway
- m Add turn lanes at an intersection or on a roadway
- n Realign an intersection or roadway
- o Replacement of bridges which cannot be widened economically
- p Upgrade at-grade railroad crossings
- q Intersection improvements
- r Removal of parking lanes
- s Other safety improvements

### **25.3.1.3 Review Project Budget and Priority**

The design and construction of a RRR project must be accomplished with expediency and at reasonable cost. Nevertheless, the project design must address all issues of safety, plus preservation of investment, and service to the user. Conditions which are discovered but cannot be resolved within the programmed budget and schedule must be addressed and the decisions documented.

### **25.3.2 Assessment of Conditions**

Before beginning actual design of the project, the designer shall assess current conditions on the project. This assessment shall include both physical conditions and operating conditions plus a safety assessment. Office reviews and field reviews shall be performed as part of the assessment.

#### **25.3.2.1 Office Reviews**

Office reviews shall be conducted to assimilate and analyze data that may be pertinent to the improvements that can be made on the project.

- a Assess Physical Conditions

This assessment should include

- geometrics,
- radius, length, and superelevation of curves,
- typical shoulder treatments,
- cross drain and structure locations,
- location and design of intersections, etc

A review of old plans, as built drawings, Straight Line Diagrams, and other historical records will determine many of the existing conditions

**b Assess Operating Conditions**

This assessment should include

- A summary of legal posted speeds on the project
- Drainage and Maintenance section's verbal or written concerns of past, present and/or anticipated future problems
- Conditions attributable to current control of access

**c Assess Safety**

A review of historical accident and travel statistics shall be performed by a qualified safety specialist. This assessment, with written recommendations, should include

- Identification of significant accident locations, with
  - (a) possible causes
  - (b) suggested corrective measures
- Review of correspondence files for letters of public concern

**25.3.2.2 Field Reviews**

A field review shall be performed by a multi-discipline team. This review should assess physical, operational and safety conditions

**a) Assess Geometric and Physical Conditions**

- Verify office review findings
- Check roadway features such as

- alignment
- cross slope
- superelevation
- lane width
- existing traffic control markings and signs
- side slopes
- clear zones
- shoulder type and width
- intersection elements
- sight distances
- drainage (including erosion problems)
- pavement condition
- highway appurtenances
- other features

b ) Assess Operating Conditions

- verification of posted regulatory speeds
- verification of posted advisory speeds
- verification of reported problems
- observation of operating conditions
- evaluation of access features

c ) Assess Safety Conditions

- observation of known accident locations
- indications of unsafe operations, such as run-off-the-road indications or previous repairs

### **25.3.3 Project Scopes**

Utilizing the office and field review findings, prepare a final scope of work by incorporating, where appropriate, other work including engineering and surveying services not identified in the original scope. Improvements other than resurfacing, restoration or rehabilitation to



be considered are listed below. The list is not all inclusive.

- Remove, relocate or make crashworthy roadside obstacles
- Remove unwarranted guardrail
- Upgrade or replace non-standard guardrail
- Replace or retrofit obsolete bridge rails
- Improve side slopes, slope flattening/stabilizing
- Correct shoulder drop off
- Pave shoulders
- Improve pavement cross slope
- Provide side drain safety modifications
- Increase sight distance at intersections
- Improve pavement markings
- Improve pavement drainage
- Provide or upgrade sidewalks and bikeways
- Upgrade railroad crossings
- Provide or upgrade signalization
- Provide or upgrade lighting
- Upgrade signing and other traffic control devices
- Provide or upgrade curb cuts, ramps and other disability access features
- Reconstruct or close driveways to comply with Access Management standards

#### **25.3.4 Review Project Plans**

RRR design plans are reviewed by other disciplines including a safety specialist. These reviews are detailed in **Chapter 16** of this manual.

### **25.3.5 Document the Design Process**

The designer shall include in the design file all documentation that substantiates the design process and decisions made, including the following information

- 1 A short paragraph which states the overall project purpose. Factors such as principal reason for the project, anticipated project cost, principal work type, general right-of-way needs or provisions, and any special project priorities are appropriately addressed here.
- 2 Documents that detail the existing conditions on the project. Findings of office reviews, field reviews and surveys are assembled here, to document existing geometric and roadside features, operating conditions, traffic volumes, posted speeds, existing pavement markings, signing, safety, etc. A brief overall summary of findings is recommended.
- 3 Document the selected standards based on project intent and conditions. When RRR criteria cannot be met, a design exception/variation is required.
- 4 A summary of safety issues that have been identified for the project and the recommended solution of those issues.
- 5 Reviews of the project design for safety improvements, documenting what was finally accomplished or ruled out of the project subsequent to the scope of work having been completed.
- 6 Those items in the original scope of work for the project which cannot be reasonably accomplished and must be deleted or delayed.

### **25.4 RRR Design Criteria**

Design values and decisions for roadway features should reflect the anticipated service life of the project. The designer has the responsibility to choose the specific design value to be used, taking into consideration its cost-effectiveness, which can range from the minimum RRR Criteria presented herein, to new construction criteria. Design values in the following sub-sections apply to RRR projects only. When specific values are not provided, the standards used in the original construction or subsequent enhancements may be retained except when an upgrade is identified in the project scope.

Designers are encouraged to make a deliberate selection of design values by explicitly addressing issues of safety cost-effectiveness, overall highway consistency in geometric design, design of adjoining segments and expected trends in traffic growth and truck use before specifying design values. The design values indicated in this chapter usually reflect a cost-effective basis for evaluating existing roadway characteristics to determine which

features require upgrading

The design values presented herein are the minimum to be used for a RRR project on the State Highway System without obtaining an exception or variation. See **Section 25.5**

#### **25.4.1 Design Period**

Improvements should be evaluated using a design period which is consistent with the design period selected for the pavement rehabilitation. The design period (service life) for RRR projects should be from 8 - 20 years for projects without milling and 12 - 20 years for projects with milling. See the ***Flexible Pavement Design Manual, Topic No. 625-010-002*** for specific design periods. For skid hazard projects, where other improvements are not made, the design year is the expected year of construction.

#### **25.4.2 Project Traffic Volume**

The design year for traffic volume is the same design year as the year established for service life. Traffic data to be used for design:

- 1 AADT and DHV for mainline (current, post construction and design year),
- 2 K, D and T factors,
- 3 Peak turning movements at signalized and problem intersections and major traffic generators,
- 4 Movements for future traffic generators that are scheduled during the service life should be considered

#### **25.4.3 Pavement Design**

The pavement design procedures are found in

- ***Flexible Pavement Design Manual, Topic No. 625-010-002***
- ***Rigid Pavement Design Manual, Topic No. 625-010-006***
- ***Pavement Type Selection Manual, Topic No. 625-010-005***

#### **25.4.4 Design Speed**

Most highway features are based on design speed. Design speed is the maximum safe speed that can be maintained when conditions are so favorable that the design features

of the highway govern Selection of the design speed must be logical for the type and location of the highway Design speed must not be less than the legal posted speed Design speed must not be dictated by an isolated geometric feature

The design speed used in the original design of the highway should be used for RRR projects If that is not practical, the design speed used should be consistent with comparable projects

Regardless of the original design speed or posted speed, the following are the minimum design speeds

- Rural Facilities 55 mph
- Urban Facilities 30 mph

**Note:** Values for design speeds less than these minimums have been provided in the following tables in the event that lower design speeds can be justified Design speed values are provided for 40 and 65 mph in the design tables These design speeds are to be used to evaluate existing conditions If reconstruction is indicated, the design speed used for design should be selected from those provided in **Chapter 2** of this manual

### 25.4.5 Lane and Shoulder Widths

The minimum lane and shoulder widths allowed are provided in **Tables 25.4.5.1, 25.4.5.2, and 25.4.5.3**

On resurfacing projects, when the original construction was in metric units, hard convert typical section dimensions where existing conditions permit Exception Use direct mathematical (soft) conversion for existing pavement widths in curbed sections, existing right of way widths, and existing median widths

**Table 25.4.5.1 Lane and Shoulder Widths - Rural Multilane**

Design Year ADT	Design Speed (mph)	Minimum Lane Width ( ft )	Minimum Shoulder Width ( ft )
ALL	ALL	12	6

**Table 25.4.5.2 Lane and Shoulder Widths  
 Two Lane Rural and Urban, Without Curb and Gutter**

Design Year ADT	Design Speed (mph)	Minimum Lane Width ( ft )	Minimum Shoulder Width ( ft )
1 - 750	ALL	10 <sub>1</sub>	6
751 - 2000	< 50	11 <sub>2</sub>	6
	≥ 50	12 <sub>2</sub>	6
> 2000	ALL	12 <sub>2</sub>	6

- 1 For rural and urban projects without curb and gutter (regardless of traffic volume), when widening is required, a minimum lane width of 11 ft is required
- 2 May be reduced by 1 ft if trucks < 10% of design year traffic

**Table 25.4.5.3 Lane and Shoulder Widths  
 Urban Multilane or Two Lane with Curb and Gutter**

Design Year ADT	Design Speed (mph)	Minimum Thru Lane ( ft )	Minimum Turn Lane( ft )	Minimum Parking Lane ( ft )
ALL	ALL	10 <sub>1</sub>	9 <sub>2</sub>	7 <sub>3</sub>

- 1 11 ft if Trucks are >10% of Design Year Traffic
- 2 10 ft for 2 Way Left Turn Lanes
- 3 A minimum width of 7 ft measured from face of curb may be left in place Otherwise provide 8 ft minimum, measured from face of curb

## 25.4.6 Roadway Cross-Slopes

The existing pavement cross slope shall be reviewed for compliance with criteria Existing pavement cross slopes shall be field verified by the design location survey Whenever practical, pavement cross-slope shall be constructed to new construction criteria When new construction cross slope criteria cannot be met, documentation in the design file is required and the normal non-superelevated cross-slope used shall be consistent with the values in **Table 25.4.6** Superelevation requirements are covered in **Section 25.4.7**

When cross slope correction is necessary, the designer must work closely with the Pavement Design Engineer and the District Bituminous Engineer to determine the

appropriate method of correction and ensure constructability. Special milling and layering details showing the method of correction shall be shown in the plans. For projects with superelevated sections, details shall address how the transition from normal cross slope to superelevation is to be achieved. Since this type work will often involve variable depth milling and/or asphalt layers, special care in estimating quantities for milling, overbuild, and structural courses will be necessary.

**Table 25.4.6 Roadway Cross-Slopes**

Feature	Standard	Range
Travel Lanes	0.02	0.02 - 0.04 <sup>1</sup>
Shoulders	0.06	0.03 - 0.08 <sup>2</sup>
Parking Lanes	0.05	0.03 - 0.05

- 1 Existing multi-lane curb and gutter sections originally constructed with a parabolic crown section may be resurfaced using a series of tangents with a cross-slope range from 0.015 to 0.05.
- 2 When existing shoulders are to remain, the algebraic difference between the shoulder slope and adjoining roadway pavement slope shall be  $\leq 0.07$ .

### 25.4.7 Superelevation

Roadway and shoulder superelevation shall be provided in accordance with the **Roadway and Traffic Design Standards, Index 510** for rural curves and **Index 511** for urban curves, consistent with **Section 25.4.11.1(b)**.

### 25.4.8 Shoulder Treatment

On projects with rural type (without curb) construction, shoulders, erosion control, sodding and reworking shoulders shall be provided consistent with the criteria for new construction. Paved shoulders shall be provided in accordance with new construction criteria, however the widening of existing 4 ft paved shoulders is optional. For new construction paved shoulder criteria, refer to **Chapter 2** of this manual.

### 25.4.9 Side Slopes

The values selected shall be the flattest that are practical. On RRR projects where existing ditches can be modified for stormwater management purposes, the use of steeper than standard side slopes and additional depth may be cost-effective but would require a variation. Justification must fully address safety, water depth, frequency and duration, as

well as cost-effectiveness. The decision to shield steep side slopes shall be made consistent with the guidelines in the **AASHTO Roadside Design Guide**

#### Front Slopes

- 1.6 are desirable
- 1.4 may be constructed within the clear zone
- 1.3 may be constructed outside the clear zone
- Existing front slopes 1.3 or flatter may remain within the clear zone. Shielding may be required.
- Steeper than 1.3 shall be shielded as per **Roadway and Traffic Design Standards, Index 400, General Notes**.
- Consideration should be given to flattening slopes of 1.3 or steeper at locations where run-off-road type crashes are likely to occur (e.g., on the outsides of horizontal curves)
- The proposed construction should not result in slopes steeper than the existing slopes in violation of the above values.

#### Back Slopes

- 1.4 are desirable
- 1.3 may be constructed in the clear zone
- 1.2 may be constructed outside the clear zone without shielding
- Existing back slopes 1.2 and flatter may remain
- Existing back slopes steeper than 1.3 within the clear zone may require shielding

### 25.4.10 Vertical Alignment

Vertical alignment must be reviewed together with the horizontal alignment to assure that the necessary balance of standards is realized and that the combination is both safe and pleasing.

The alignment should be reviewed to see if the following principles are generally satisfied by the existing vertical alignment:

- the sight distance provided meets or exceeds the values in **Table 25.4.10**, column B

- grades do not significantly affect truck operations
- there are no hidden dips which could obscure traffic or hazards
- steep grades and sharp vertical curves do not exist at or near an intersection
- sufficient grades and, when necessary, special gutter grades exist to adequately drain urban projects
- adequate sight distance exists for traffic signals, e g beyond overpasses, etc

When any of the above conditions do not exist, the designer should evaluate for hazardous conditions and determine if corrective measures are warranted

#### **25.4.10.1 Vertical Curvature**

The designer shall use the method given in **Table 25.4.10** to check the sufficiency of vertical curves and provide any indicated corrective measures. When an evaluation is required, it shall consider

- the nature of potential hazards hidden by a hill crest
- the location of the hazard in relation to the portion of the highway where sight distance falls below new construction criteria
- effectiveness of other options such as relocating or correcting the hazard
- providing warning signs

#### **25.4.10.2 Grades**

Grades which satisfied the standards in effect at the time of construction may be used provided the result is consistent with the design principles in 25.4.10. Grades which are not consistent with these design principles must be evaluated.



**Table 25.4.10 Stopping Sight Distance for Vertical Curvature**

DESIGN SPEED (mph)	STOPPING SIGHT DISTANCE ( ft ) <sup>1</sup>		
	A	B	C
30	200	200	165
35	240	220	200
40	300	270	240
45	350	325	280
50	410	400	325
55	470	450	370
60	530	525	420
65	610	550	455
70	690	625	520

For the design speed, compare the length of the available sight distance to the tabulated values

- a If the length is equal to or greater than the "A" value, the curve is satisfactory
- b If the curve is equal to or greater than the "B" value but less than the "A" value, a study **should** be made to evaluate possible mitigation of hazards requiring driver reaction and/or appropriate treatment such as relocation of the hazard, hazard warning signs, reduced safe speed signs, etc
- c If the length is equal to or greater than the "C" value but less than the "B" value, a study **shall** be made and appropriate treatment such as relocation of the hazard, hazard warning signs, reduced safe speed signs, etc provided Possible reconstruction of the curve should be considered
- d If the value is less than the "C" value, **reconstruction** of the curve is required, or an exception must be obtained

<sup>1</sup> Based on height of eye of 3.5 ft and height of object of 6 inches above road surface

### 25.4.11 Horizontal Alignment

Vertical and horizontal alignment must be reviewed together to assure that the necessary balance of standards is realized and the combination is both safe and pleasing

The designer should review the alignment to identify that the existing alignment generally adheres to the following guidelines

- consistent with no sudden changes from easy to sharp curvature
- sufficient tangent length between reverse curves
- superelevation transitions provided
- maximum curvature is not used
  - on high fills or elevated structures,
  - at or near crest in grade,
  - at or near low points in grade,
  - at the end of long tangents,
  - at or near intersections or points of access or egress,
  - at or near decision points

At all locations where the existing alignment does not adhere to these conditions, the designer should evaluate for hazardous conditions and determine if corrective measures are warranted

#### **25.4.11.1 Horizontal Curves**

Horizontal curves shall be reviewed for horizontal curvature and superelevation. Review existing curves against the values in **Table 25.4.11.1**. Every practical attempt shall be made to upgrade curves which are below State Highway System (SHS) minimum values for new construction. The review should also include an on-site review for evidence of near crashes or operational problems.

##### **a) Horizontal Curvature**

**Condition #1** - Horizontal curves which meet or exceed the SHS minimum radius values are satisfactory unless there is evidence of safety or operational problems.

**Condition #2** - Curves which are below the SHS minimum radius values but meet or exceed the RRR minimum radius values shall be reviewed for specific safety problems at the curve. If the review indicated significant operational or safety problems exist, the curve must be reconstructed. If problems are identified but reconstruction is not warranted, corrective measures shall be included in the project.

**Condition #3** - Those curves which do not meet the RRR minimum radius values must be reconstructed. Reconstructed curves shall meet the criteria for new construction contained in **Chapter 2**. Sufficient time and budget must be

programmed into the RRR project to obtain any right-of-way necessary for reconstruction of the curve

b) **Superelevation**

**Rural Curves** - Existing rural curves not having the indicated superelevation rate on the *Roadway and Traffic Standards, Index 510* shall be corrected to that rate. Other measures appropriate to correct or improve identified safety or operational problems shall be provided.

**Urban Curves** - Existing urban (C&G) curves not having the indicated superelevation rate on the *Roadway and Traffic Design Standards, Index 511* shall be corrected to that rate by reconstruction of the curve or if practical curb adjustment to accommodate overbuild. Other measures appropriate to correct or improve identified safety or operational problems shall be provided.

c) **P.I.'s Without Curves**

Where alignments have P I 's without curves that exceed the new construction values in **Table 2.8.1**, consideration should be given to reconstructing the roadway with suitable curvature.

**Table 25.4.11.1 Safe Criteria for State Highway System  
 With Maximum Superelevation**

DESIGN SPEED (mph)	$e_{max} = 0.10$				$e_{max} = 0.05$			
	SHS		RRR		SHS		RRR	
	$D_{max}$	$R_{min}(ft)$	$D_{max}$	$R_{min}(ft)$	$D_{max}$	$R_{min}(ft)$	$D_{max}$	$R_{min}(ft)$
30	24° 15'	231	30° 30'	188	20° 00'	286	25° 45'	223
35	17° 45'	323	20° 45'	276	14° 15'	402	17° 15'	332
40	13° 15'	432	14° 45'	388	10° 45'	533	12° 15'	468
45	10° 15'	559	11° 00'	521	8° 15'	694	9° 00'	637
50	8° 15'	694	8° 30'	674	6° 30'	881	6° 45'	849
55	6° 30'	881	6° 45'	849	N/A		N/A	
60	5° 15'	1091	5° 30'	1042	N/A		N/A	
65	4° 15'	1348	4° 30'	1273	N/A		N/A	
70	3° 30'	1637	3° 45'	1528'	N/A		N/A	

**25.4.11.2 Stopping Sight Distance (Horizontal Curvature)**

Stopping sight distance shall be provided for all horizontal curvature in accordance with **Table 25.4.11.2**

**Table 25.4.11.2 Stopping Sight Distance for Horizontal Curvature**

DESIGN SPEED (mph)	STOPPING SIGHT DISTANCE (ft) for Horizontal Curvature
30	165
35	200
40	240
45	280
50	325
55	370
60	420
65	455
70	520

### **25.4.12 Stopping Sight Distance**

Stopping sight distance requirements are provided in **Sections 25.4.10**, Vertical Alignment and **25.4.11**, Horizontal Alignment

### **25.4.13 Vertical Clearance**

The following clearances apply to highway bridges and other roadway features over the entire roadway. Entire roadway includes lanes and shoulders.

**Underpass Clearance** - For roadways passing under existing bridges, vertical clearance shall be at least 14 ft over the entire roadway. Signing and warning features shall be provided whenever vertical clearance is less than 14 ft 6 inches.

**Signs and Traffic Control Devices** - Clearances shall be provided consistent with new construction standards.

**Bridges** - Vertical clearance requirements are provided in **Section 25.4.25.4**.

### **25.4.14 Horizontal Clearance**

Horizontal clearance is the lateral distance from a specified point on the roadway such as the edge of the travel lane or face of curb, to a roadside feature or object. Horizontal clearance requirements vary depending on the type of roadway and the feature or object.

For roadways with flush shoulders, horizontal clearance requirements for certain features and objects are based on the clear zone width. That is, the feature or object is to be outside the clear zone. Clear zone is the roadside area available for safe use by errant vehicles. This area may consist of a shoulder, a recoverable slope, a non-recoverable slope, and/or a clear runoff area zone. Clear zone is further described in **Chapter 4**.

For roadways with curbs, the presence of curb conflicts with the clear zone concept and it is often not practical to provide full clear zone widths due to restricted right of way. Therefore, while there are specific horizontal clearance requirements for curbed roadways, these are not based on clear zone widths.

For RRR projects, horizontal clearance requirements and clear zone widths in Control Zones (See **Section 25.4.15**) are based on new construction criteria provided in **Chapter 2, Section 2.11**. In areas outside of Control Zones, new construction criteria shall be used where practical. When new construction criteria cannot be reasonably obtained, horizontal clearance and clear zone widths outside Control Zones may be based on the criteria in **Tables 25.4.14.2 through 25.4.14.9**.

**Table 25.4.14.1 Clear Zone Width (feet)**

DESIGN SPEED (mph)	TRAVEL LANES & MULTI-LANE RAMPS	AUXILIARY LANES & SINGLE LANE RAMPS
< 45	6	6
45 <sup>6</sup>	14	8
> 45	18	8

**GENERAL NOTES**

- 1 In control zones, horizontal clearance widths shall be based on new construction criteria provided in **Chapter 2, Section 2.11.8.**
- 2 When relocation is required to meet minimum clear zone requirements, consideration should be given to providing new construction widths
- 3 Clear zone widths are for side slopes 1 4 and flatter For steeper slopes, provide a clear runout area at toe of fill according to **Chapter 4** of this manual
- 4 When accident history indicates need, or where specific site investigation shows definitive accident potential, clear zone widths shall be adjusted on the outside of horizontal curves with flush shoulders in accordance with **Table 2.12.2**
- 5 Clear zone width is measured from the edge of the traveled way
- 6 May be reduced to <45 mph widths if conditions more nearly approach those for low speed (40 mph or less)

**Table 25.4.14.2 Horizontal Clearance for Traffic Control Signs**

<b>PLACEMENT</b>	Placement shall be in accordance with the <b>Roadway and Traffic Design Standards</b> Placement within sidewalks shall be such that an unobstructed sidewalk width of 4' or more (not including the width of curb) is provided
<b>SUPPORTS</b>	<p><b>Supports except overhead sign supports shall be frangible or breakaway. When practicable, sign supports should be located behind barriers that are justified for other reasons.</b></p> <p><b>Overhead sign supports shall be located outside the clear zone unless shielded.</b></p>
In control zones, horizontal clearance widths shall be based on new construction criteria provided in <b>Chapter 2, Section 2.11.8.</b>	

**Table 25.4.14.3 Horizontal Clearance for Light Poles**

<b>CONVENTIONAL LIGHTING</b>	<p>Not in the median except in conjunction with barriers that are justified for other reasons</p> <p>Rural (Flush Shoulders)                  20' from the travel lane, 14' from auxiliary lane                  (may be clear zone width when clear zone is less than 20')</p> <p>Urban (Curb and Gutter)                  From right of way line to 4' back of face of curb (may be 1 5' back of face of curb when all other alternatives are deemed impractical) Placement within sidewalks shall be such that an unobstructed sidewalk width of 4' or more (not including the width of curb) is provided</p>
<b>HIGH MAST LIGHTING</b>	<p>Outside of the clear zone unless shielded</p>
<p>In control zones, horizontal clearance widths shall be based on new construction criteria provided in <b>Chapter 2, Section 2.11.8.</b></p>	

**Table 25.4.14.4 Horizontal Clearance for Utility Installations**

<p>Shall not be located within the limited access right of way, except as permitted by the <b>Telecommunications Policy, (Topic No. 000-625-025)</b></p> <p>Shall not be located in the median</p> <p>Flush Shoulders                  Not within the clear zone Install as close as practical to the right of way without aerial encroachments onto private property</p> <p>Curb or Curb and Gutter                  At the R/W line or as close to the R/W line as practical Must maintain 1 5' clear from face of curb Placement within sidewalks shall be such that an unobstructed sidewalk width of 4' or more (not including the width of the curb) is provided</p> <p>See the <b>Utility Accommodation Manual, (Topic No. 710-020-001)</b>, for additional information</p>
<p>In control zones, horizontal clearance widths shall be based on new construction criteria provided in <b>Chapter 2, Section 2.11.8.</b></p>

**Table 25.4.14.5 Horizontal Clearance to Signal Poles and Controller Cabinets for Signals**

<p>Shall not be located in medians</p> <p>Should be located as far from traffic lanes as practical Placement within sidewalks shall be such that an unobstructed sidewalk width of 4' or more (not including the width of curb) is provided</p>
<p>In control zones, horizontal clearance widths shall be based on new construction criteria provided in <b>Chapter 2, Section 2.11 8.</b></p>

**Table 25.4.14.6 Horizontal Clearance to Trees**

Minimum Horizontal Clearance to trees where the diameter is or is expected to be greater than 4" measured 6" above the ground shall be
Flush Shoulders Outside the clear zone
Curb or Curb and Gutter 1 5' from face of outside curbs 3 5' from edge of inside traffic lane where median curb is present
In control zones, horizontal clearance widths shall be based on new construction criteria provided in <b>Chapter 2, Section 2.11.8.</b>

**Table 25.4.14.7 Horizontal Clearance to Bridge Piers and Abutments**

Minimum Horizontal Clearance to Bridge Piers and Abutments
Flush Shoulders Outside the clear zone
Curb or Curb and Gutter 16' from the edge of the travel lane
In control zones, horizontal clearance widths shall be based on new construction criteria provided in <b>Chapter 2, Section 2.11.8.</b>

**Table 25.4.14.8 Horizontal Clearance to Railroad Grade Crossing  
Traffic Control Devices**

Placement shall be in accordance with the <i>Roadway and Traffic Design Standards</i>
In control zones, horizontal clearance widths shall be based on new construction criteria provided in <b>Chapter 2, Section 2.11.8.</b>



**Table 25.4.14.9 Horizontal Clearance to Other Roadside Obstacles**

Minimum Horizontal Clearance to other roadside obstacles	
Flush Shoulders	Outside the clear zone
Curb or Curb and Gutter	4' back of face of curb May be 1 5' back of face of curb when all other alternatives are deemed impractical
Note	Horizontal Clearance to mailboxes is specified in the construction details contained in Index No 532
In control zones, horizontal clearance widths shall be based on new construction criteria provided in <b>Chapter 2, Section 2.11 8.</b>	

### 25.4.15 Control Zones

Control zones are areas in which it can be statistically shown that crashes are more likely to involve departure from the roadway with greater frequency of contact with above ground fixed objects These are described as follows and shown in **Exhibit 25-A**

- (A) An above ground fixed object having been hit more than 2 times within 3 consecutive years in the last 5 years, unless it can be determined that the problem can be remedied through the project scope,
- (B) Within the return radii of an intersecting street and the new construction horizontal clearance distance,
- (C) For "T" intersections (on the non-intersection side) within the area defined by a line through the center of the return radii and return point of tangent extended across the street to the rights of way limits,
- (D) For a distance of 100 ft measured downstream from the point of intersection of a right turn deceleration lane and where full lane width is achieved within the new construction horizontal clearance distance (It is assumed the edge of pavement is not constructed on a reverse curve If it is, the measurement would be taken from the point of intersection of the trailing curve),
- (E) For a distance of 100 ft measured downstream from the point of intersection of a full lane termination with a skewed merge section within the new construction horizontal clearance distance (It is assumed the edge of pavement is not constructed on a reverse curve If it is, the measurement would be taken from the point of intersection of the leading curve),

- (F) For a distance of 3 ft from a driveway flare within the new construction horizontal clearance distance at the intersection of a dedicated intersecting service facility such as an alley way or easement,
- (G) For a distance of 3 ft from a driveway flare within the new construction horizontal clearance distance at the entrance turnout for use other than a private residence
- (H) The area on the outside of a curve when the operating speed exceeds 35 mph or downstream of a kink in the alignment for a distance of 100 feet. In each case the area falls within the new construction horizontal clearance distance unless protected by a barrier. For curves, if the radius exceeds 3000 feet, no control zone exists and control zone requirements do not apply. For kinks in the alignment, if the kink is less than 5 degrees, no control zone exists specifically for the kink and therefore control zone requirements for kinks do not apply.

#### **25.4.16 Border**

The minimum border width shall be the greatest of the following

- The border width used in the original project,
- The border width required to satisfy ADA accessibility standards,
- 8 ft

When right of way is being acquired for other reasons, the minimum border width shall be that used for new construction projects, however, the minimum length of wider border width shall be a segment of sufficient length to provide reasonable continuity

#### **25.4.17 Intersections**

Intersections shall be evaluated to determine those that need a traffic engineering study. The following items should be considered

- Addition of right and left turning lanes
- Realignment of intersection
- Adequate turning radii for left and right turning lanes
- Use of channelization to reduce excessive areas of conflict at large intersections
- Placement of crosswalks as related to sidewalks and stop bars
- Locations of pedestrian facilities
- Locations of utilities, signal poles, controller cabinets, lighting poles and drainage structures as related to sidewalks and curbcut ramps
- Warrants for traffic control systems

- Installation of buried conduit for future traffic control systems
- Lighting for intersection illumination
- Adequate sight distance
- ADA needs

#### **25.4.18 Drainage**

The designer or drainage specialist must evaluate the hydraulic and physical adequacy of the existing drainage system. This requires examination of the existing drainage in the field and by consulting with maintenance personnel and records. If there are apparent problems with the existing drainage system, additional evaluation is required to determine the extent and type of improvements necessary to upgrade the system. The *FDOT Drainage Manual (Topic No. 625-040-001)* contains design criteria and methods which provide guidance in formulating suitable drainage features, either through modification or replacement.

Prior to selecting any plan of highway improvement, the designer should consult with drainage and environmental permitting specialists since almost all roadway modifications reduce storage and infiltration and increase discharge rates and volumes. Stormwater retention and detention for quality, rate and volume may be required. Theoretical evaluation of proposed changes to existing and new drainage features necessary to correct operational deficiencies should be referred to a drainage specialist. The drainage specialist will provide the necessary drainage design, flood data information, drainage related information for the Storm Water Pollution Prevention Plan (SWPPP) and any stormwater permit computations.

#### **25.4.19 Pedestrian and Bicyclist Needs**

Many existing corridors do not provide for pedestrian or bicyclist needs. Whenever a RRR project is undertaken, pedestrian and bicyclist needs must be addressed. Recommendations by the District Bicycle/Pedestrian Coordinator shall be obtained. Local government contact in developing these recommendations is essential. This should be part of the project scoping and programming effort.

##### **Pedestrian Needs**

**Sidewalks** - Upgrading sidewalks to meet ADA accessibility standards shall be included.

**Medians** - Medians shall be evaluated to determine if modifications such as pedestrian refuge sections are necessary. 5-lane and 7-lane sections are restricted or eliminated under current policy, usually by the introduction of a raised or restrictive median, which enhances the opportunity to accommodate pedestrian needs. Traffic separators with a width sufficient to provide refuge should be used.

---

at intersections where possible. When adequate pedestrian refuge cannot be provided at the intersection, mid-block islands should be provided.

Design details for disability access features including sidewalk, curb cuts and ramps are found in the ***Roadway and Traffic Design Standards***. Additional standards for ADA are found in the regulations and design guidelines issued by the Secretary of the U S Department of Transportation.

**Bicyclist Needs** - Design criteria for bicycle lanes are found in other chapters of this manual. For existing curbed sections where no widening is planned, consideration should be given to reducing lane widths, e.g. 11 ft through and 10 ft turn lanes on sections with 14 or 15 ft wide lanes.

#### **25.4.20 Utilities (Underground and Overhead)**

Horizontal clearance criteria are given in **Table 25.4.14.4** in the ***Utility Accommodation Manual***.

#### **25.4.21 At-grade Railroad Crossings**

When highway improvements are undertaken that include at-grade railroad crossings, the physical and operational characteristics shall be reviewed and upgraded to meet minimum standards. Recommendations shall be made by the District Railroad Coordinator for incorporation into the project.

See **Chapter 6** of this manual and the ***Roadway and Traffic Design Standards*** for additional information.

#### **25.4.22 Aesthetics and Landscaping**

Landscaping, including median and intersection treatment, shall be consistent with the criteria in this manual and the ***Roadway and Traffic Design Standards, Index 546***.

#### **25.4.23 Highway Lighting**

Lighting may be installed at specific locations to improve safety. For example:

- Reducing the effects of ambient light conditions,
- Busy or high accident intersections,
- Bus stops,
- Channelized intersections,
- Car pool parking lots,
- Pedestrian and bicycle crossings,

- Ramp terminals

Any lighting, existing or proposed, shall be reviewed by the District Lighting Engineer to determine specific needs. Lighting shall meet new lighting criteria, found in **Chapter 7** of this manual.

#### **25.4.24 Highway Traffic Control Devices**

Traffic control devices such as signals, signing, and pavement markings shall be updated as required to comply with the *Manual on Uniform Traffic Control Devices*, the *Manual on Uniform Traffic Studies*, the Department's *Roadway and Traffic Design Standards*, and the ADA design guidelines issued by the Secretary of the U.S. Department of Transportation. The District Traffic Operations Engineer (or staff) shall determine any new or additional devices required.

#### **25.4.25 Bridges**

On each project, a determination must be made as to whether an existing bridge should remain as is, be rehabilitated or be replaced. The decision shall be made based on an assessment of the bridge's structural and functional adequacy for the type and volume of traffic over the structure's design life.

Any structure which has been identified and is scheduled for rehabilitation or replacement in the 5 year work program should be considered for an exception (or variation) from widening or rail retrofit. A detailed accident history must be included in the justification.

##### **25.4.25.1 Bridge Loading**

Bridges shall have an Inventory Load Rating equal to or greater than the load requirements shown in the following table.

**Table 25.4.25.1 Bridge Loading**

<b>TYPE</b>	<b>LOAD REQUIREMENT</b>
Collector Facilities	HS-15
Arterial Facilities	HS-20

##### **25.4.25.2 Bridge Width**

Bridges shall meet or exceed the following clear width criteria. If lane widening is planned as part of the RRR project, the minimum useable bridge width shall be determined using the width of approach lanes after widening.

**Table 25.4.25.2 Clear Width Criteria for Bridges**

Design Year ADT		Minimum Usable Bridge Width (ft.)
UNDIVIDED	0 - 750	Total width of approach lanes + 4'
	751 +	Total width of approach lanes + 8
DIVIDED	ALL	Total width of approach lanes + 5.5 (median separator) * Total width of approach lanes + 6.5 (median barrier wall)**
ONE WAY BRIDGES	ALL	Total width of approach lanes + 6.5 (2.5 Lt and 4.0 Rt)

\* 1.5 ft median and 4 ft outside shoulder

\*\* 2.5 ft median and 4 ft outside shoulder

If widening is required, it shall be in accordance with the **Structures Design Guidelines** and meet the geometric requirements for new construction

**25.4.25.3 Bridge Railing**

Bridge railing shall be both structurally and functionally adequate. Bridge railing which will not contain vehicles is considered structurally inadequate. Bridge railing which will not redirect vehicles without snagging or vaulting is considered functionally obsolete.

All safety shape rails, New Jersey or F-Shape, are structurally and functionally adequate. All other former FDOT standard bridge rail designs are inadequate.

Only when it is determined appropriate for an existing inadequate handrail to remain in place may the details provided by Scheme 1 in the **Roadway and Traffic Design Standards, Index 401** be considered. Refer to the General and Design notes on Sheet 1 of that Standard. Other retrofit concepts may be used when judged to meet performance expectations.

Rails to be replaced shall be designed using the criteria in the **Structures Design Guidelines**.

**25.4.25.4 Vertical Clearance**

The following clearances apply to existing bridges to remain or be modified only. Replacement structures shall be to new construction standards.

**Underpassing Clearance** - Vertical Clearance for roadways passing under existing bridges shall be at least 14 ft over the entire roadway. The existing vertical clearance shall not be reduced by the RRR project if the existing clearance is 16 ft or less.

**Low Member Clearance** - Existing bridges with sway bracing members over the bridge deck shall have at least 14 ft clearance over the entire roadway.

Signing and warning features shall be provided whenever vertical clearance is less than 14 ft 6 inches.

#### **25.4.25.5 Considerations**

When evaluating bridge replacement or widening, the following should be considered:

- a Cost of replacing the existing bridge with a wider bridge designed to new bridge criteria,
- b Cost of widening the existing bridge (if widening is practical), including life cycle costs of maintaining a widened bridge,
- c The number of crashes that would be eliminated by replacement or widening,
- d The hydraulic sufficiency and the risk of failure due to scour and/or ship impact as well as the consequences of failure.

#### **25.4.26 Roadside Safety Hardware**

Roadside conditions must be reviewed to determine the need for roadside safety hardware. This review must include a review of existing roadside safety hardware for need and adequacy and whether upgrading or replacement is necessary. See Chapter 4 for guidance on conducting reviews. All roadside safety hardware on RRR projects must comply with the following requirements:

##### **25.4.26.1 Longitudinal Barriers, Guardrails, Median Barriers**

Existing longitudinal guardrail sections must be upgraded or replaced unless they conform to the current **Roadway and Traffic Design Standards**, Index 400. As an exception, existing guardrail constructed with steel offset blocks, but otherwise conforming to current Design Standards, are not required to be upgraded or replaced.

Existing concrete barriers conforming to current **Roadway and Traffic Design Standards** Index 410, New Jersey shape barriers, and approved vertical faced concrete barriers may remain in place. Other concrete barrier shapes must be replaced.

All replacements and new installations shall conform to the current ***Roadway and Traffic Design Standards***

See **Section 25.4.25.3** for bridge rail requirements

#### **25.4.26.2 Guardrail to Bridge Rail Transitions**

Existing guardrail to bridge rail transitions must be upgraded or replaced unless they conform to one of the following systems

- The nested three beam type transition shown as Detail J in the current ***Roadway and Traffic Design Standards, Index 400***
- The w-beam type transition shown as Detail J in the 1998 edition of the ***Roadway and Traffic Design Standards, Index 400***. This detail is also shown in the current ***Roadway and Traffic Design Standards*** in ***Index 401***.

All replacements and new installations connecting to standard safety shape bridge rails shall conform to the current ***Roadway and Traffic Design Standards, Index 400***.

When an existing bridge rail does not meet current design criteria and an appropriate determination has been made that the bridge rail is to remain in place, replacement of the transition and anchorage shall conform to current ***Roadway and Traffic Design Standards, Index 401***.

See **Section 25.4.25.3** for bridge rail requirements

#### **25.4.26.3 Guardrail Terminals**

Existing guardrail terminals must be upgraded or replaced unless they conform to one of the systems identified in the current ***Roadway and Traffic Design Standards***. As an exception, existing Type MELT's on high speed facilities are not required to be replaced

All replacements and new installations shall conform to the current ***Roadway and Traffic Design Standards***

#### **25.4.26.4 Crash Cushions and Attenuators**

Existing crash cushions and attenuators must be upgraded or replaced unless they conform to either the current ***Roadway and Traffic Design Standards*** or one of the following systems



- G-R-E-A-T
- Hex-Foam Sandwich System
- Hi-DroCell
- Permanent Sand Barrel Arrays

All replacements and new installations shall conform to the current ***Roadway and Traffic Design Standards***

## **25.5 Design Exceptions and Variations**

Every effort should be made to adhere to the desirable criteria stated herein. However, under unusual conditions, it may be necessary and appropriate to use values that are less than the minimum values shown. If lesser values are proposed for use, these shall be identified and the necessary approval and concurrence obtained at the earliest possible time, but not later than Phase II, so that the denial of any such request will not alter the project letting date. Refer to **Chapter 23** of this manual for the necessary procedure.

### Control Zones

#### RESTRICTED LOCATIONS FOR ABOVE GROUND FIXED OBJECTS

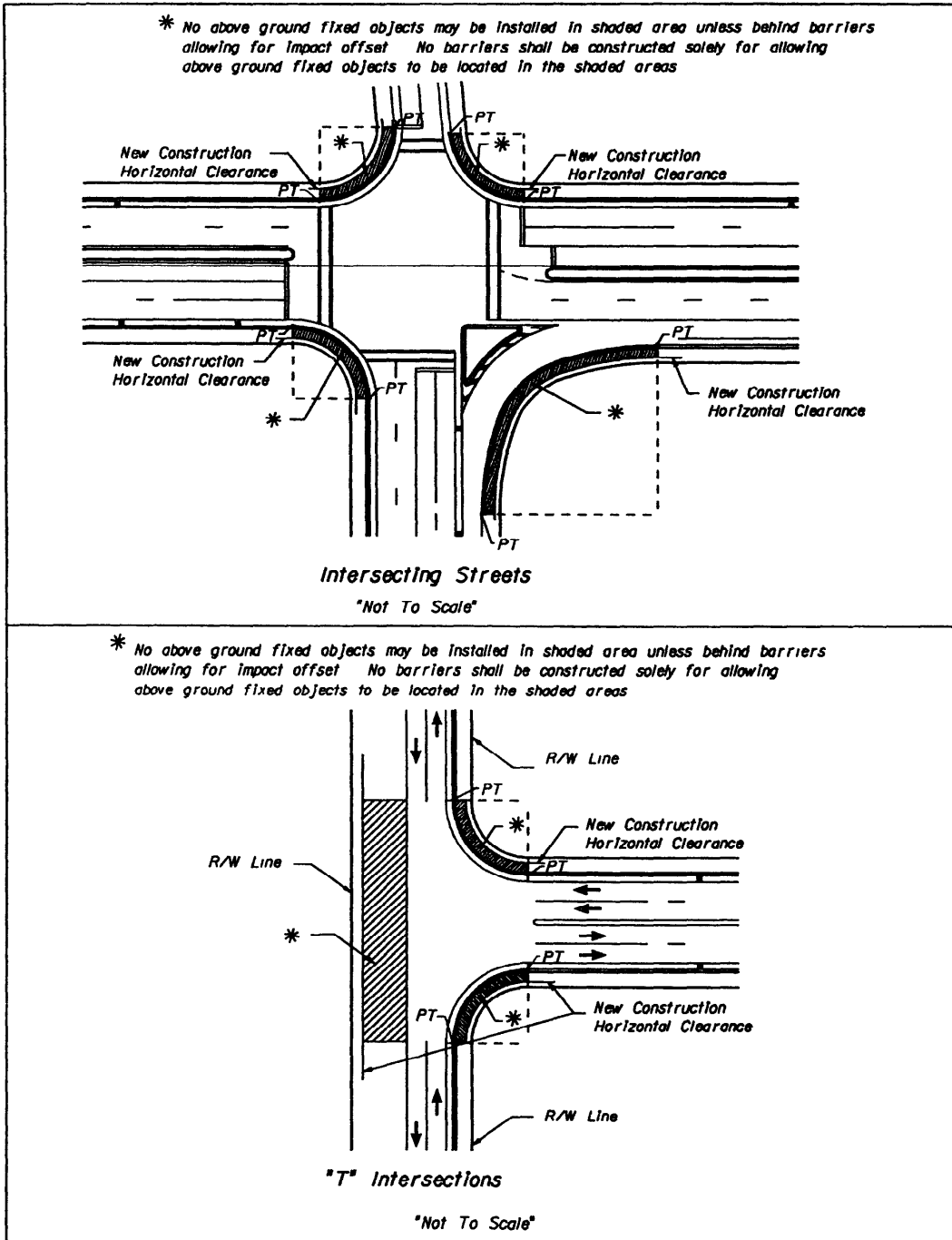

Exhibit 25-A, Page 1 of 5

### Control Zones

#### RESTRICTED LOCATIONS FOR ABOVE GROUND FIXED OBJECTS

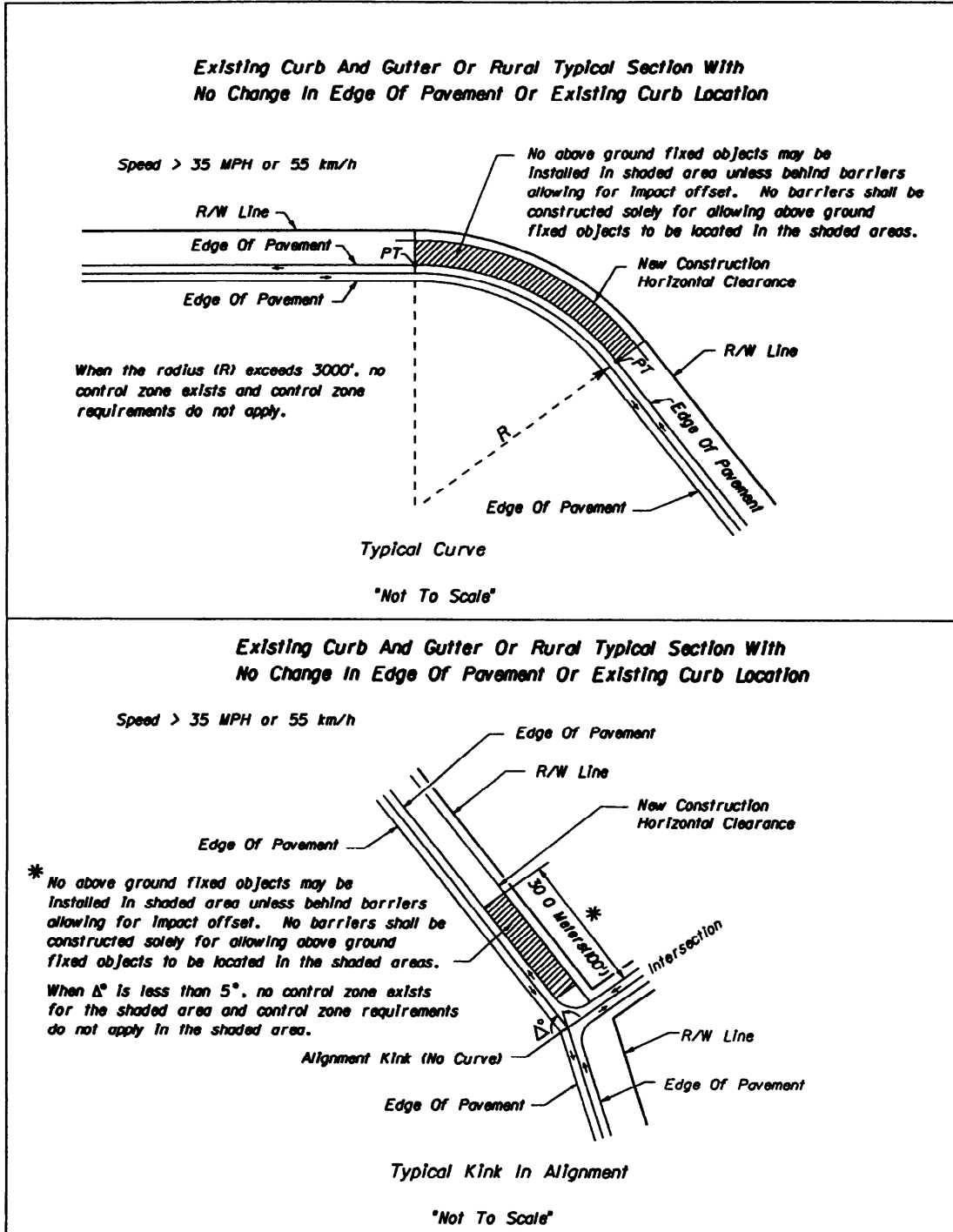
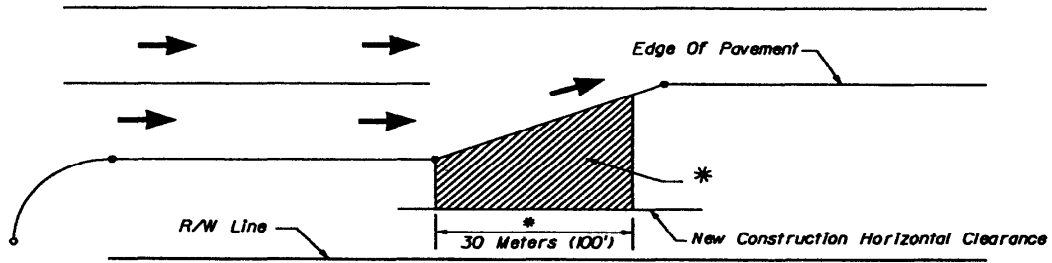

Exhibit 25-A, Page 2 of 5

### Control Zones

#### RESTRICTED LOCATIONS FOR ABOVE GROUND FIXED OBJECTS

\* No above ground fixed objects may be installed in shaded area unless behind barriers allowing for impact offset. No barriers shall be constructed solely for allowing above ground fixed objects to be located in the shaded areas.



Lane Termination Using A Skewed Merge Section

"Not To Scale"

\* No above ground fixed objects may be installed in shaded area unless behind barriers allowing for impact offset. No barriers shall be constructed solely for allowing above ground fixed objects to be located in the shaded areas.

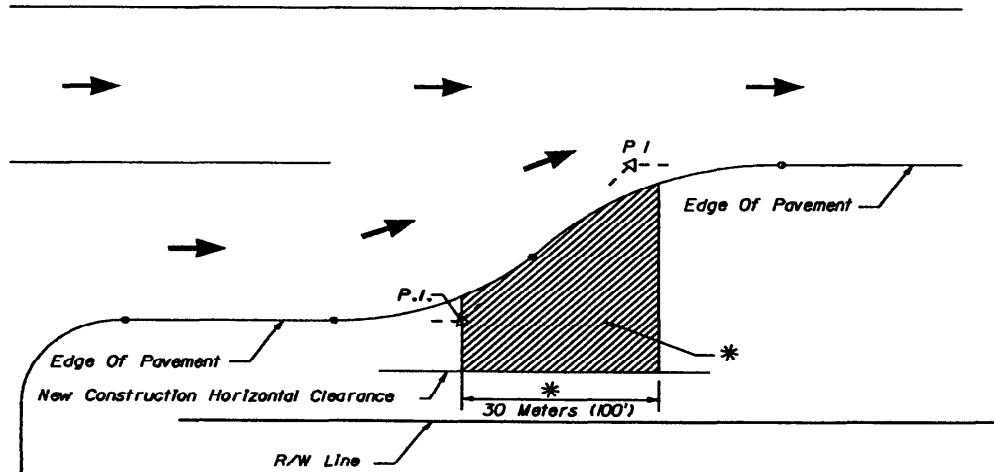

Lane Termination Using A Reverse Curve

"Not To Scale"

### Exhibit 25-A, Page 3 of 5

### Control Zones

#### RESTRICTED LOCATIONS FOR ABOVE GROUND FIXED OBJECTS

\* No above ground fixed objects may be installed in shaded area unless behind barriers allowing for impact offset. No barriers shall be constructed solely for allowing above ground fixed objects to be located in the shaded areas.

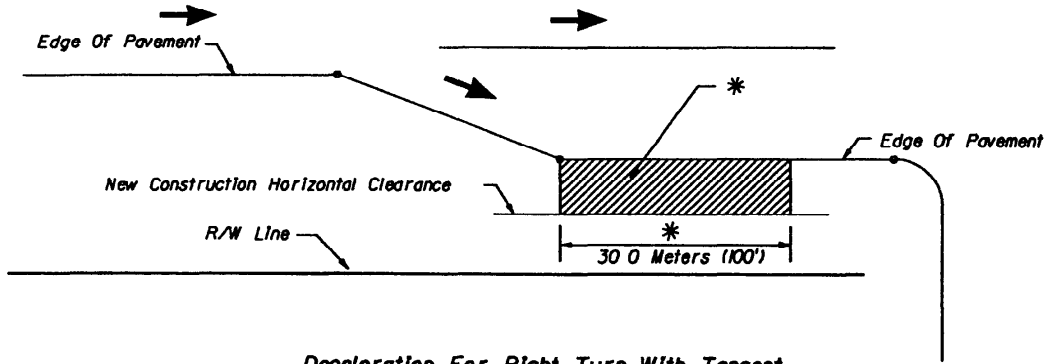

*Deceleration For Right Turn With Tangent*

"Not To Scale"

\* No above ground fixed objects may be installed in shaded area unless behind barriers allowing for impact offset. No barriers shall be constructed solely for allowing above ground fixed objects to be located in the shaded areas.

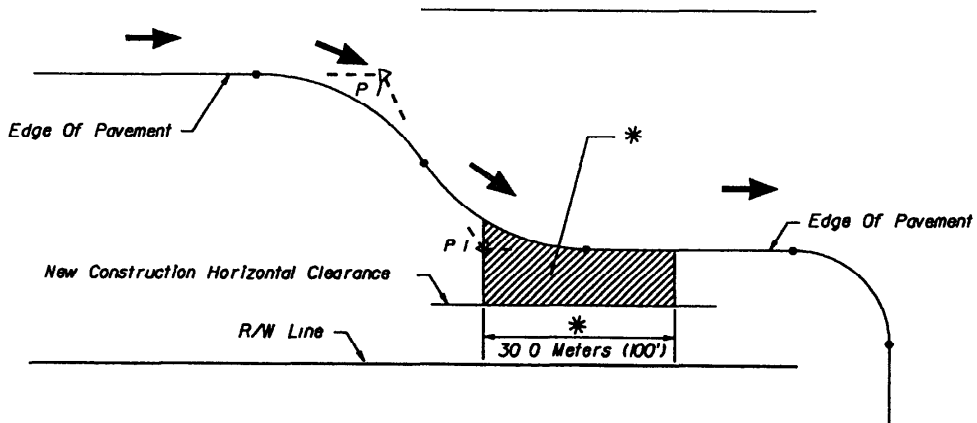

*Deceleration For Right Turn With Reverse Curves*

"Not To Scale"

#### Exhibit 25-A, Page 4 of 5

### Control Zones

#### RESTRICTED LOCATIONS FOR ABOVE GROUND FIXED OBJECTS

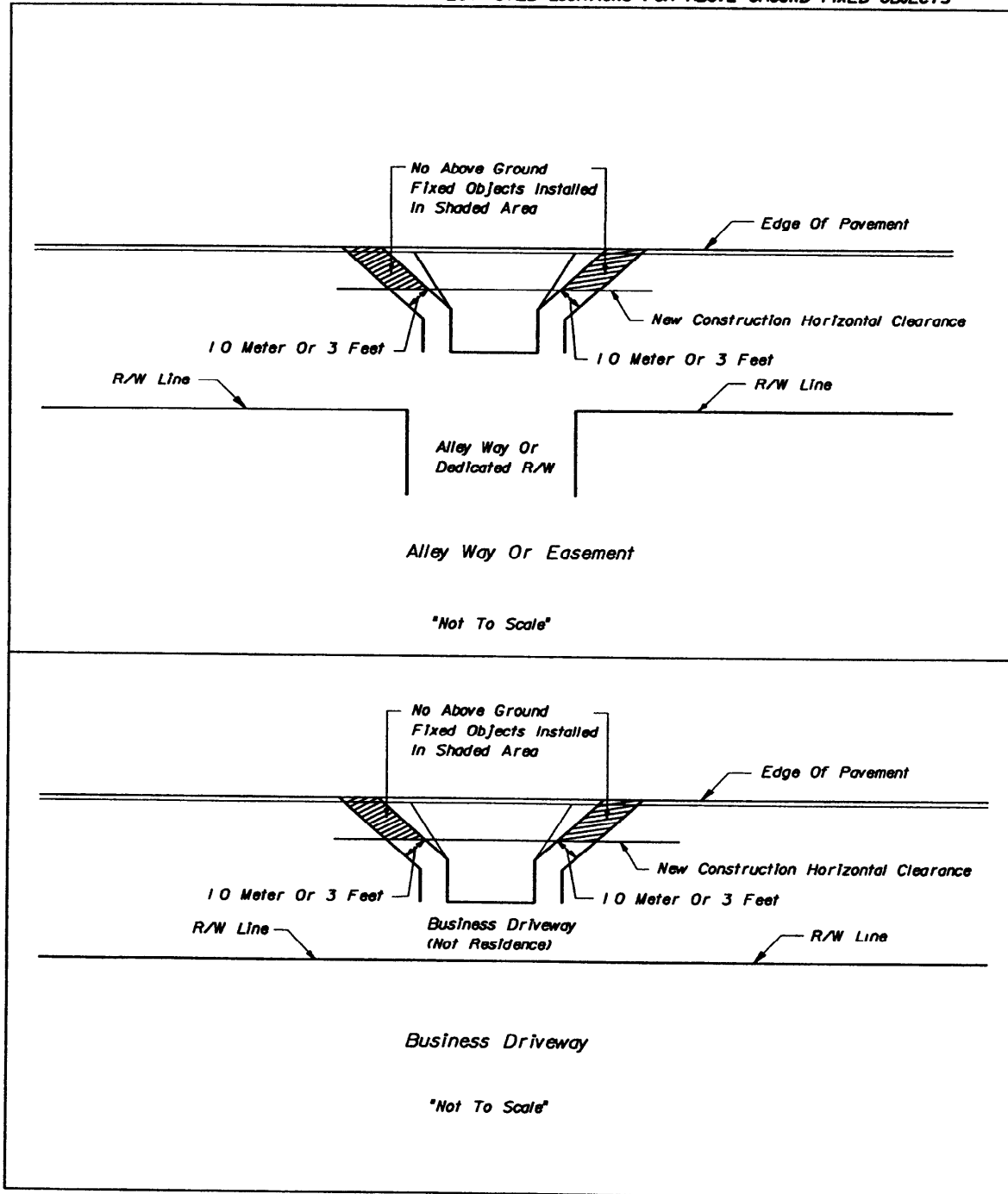

Exhibit 25-A, Page 5 of 5

## Chapter 26

### Bridge Project Development

26 1	General . . . . .	26-1
26.2	Organization . . . . .	26-1
26.3	Definitions . . . . .	26-1
26 3.1	Category 1 Structures . . . . .	26-2
26.3.2	Category 2 Structures . . . . .	26-2
26 4	Abbreviations Used in Structures Design . . . . .	26-2
26 5	Responsibility . . . . .	26-4
26.6	FHWA Oversight . . . . .	26-4
26.7	Bridge Project Development . . . . .	26-4
26.8	Bridge Analysis . . . . .	26-5
26 8 1	General . . . . .	26-5
26 8 2	Contents . . . . .	26-5
26.9	Bridge Development Report (BDR)/30% Structures Plans . . . . .	26-6
26.9.1	General . . . . .	26-6
26.9 2	Contents . . . . .	26-7
26.9 3	Format . . . . .	26-9
26.9.4	Aesthetics . . . . .	26-10
26.9.5	Construction and Maintenance Considerations . . . . .	26-12
26 9 6	Historical Significance Considerations . . . . .	26-12
26 9 7	Alternative Designs . . . . .	26-13
26 9 8	Conclusions and Recommendations . . . . .	26-13
26 9 9	30% Structures Plans . . . . .	26-13

26.10	Bridge Development Report (BDR) Submittal Checklist . . . . .	26-15
26.10.1	Typical Sections for Roadway and Bridge . . . . .	26-15
26.10.2	Roadway Plans . . . . .	26-15
26.10.3	Maintenance of Traffic Requirements . . . . .	26-15
26.10.4	Bridge Hydraulics Report . . . . .	26-15
26.10.5	Geotechnical Report . . . . .	26-16
26.10.6	Bridge Corrosion Environment Report . . . . .	26-16
26.10.7	Existing Bridge Plans . . . . .	26-16
26.10.8	Existing Bridge Inspection Report . . . . .	26-16
26.10.9	Utility Requirements . . . . .	26-17
26.10.10	Railroad Requirements . . . . .	26-17
26.10.11	Retaining Wall and Bulkhead Requirement . . . . .	26-17
26.10.12	Lighting Requirements . . . . .	26-17
26.10.13	Handicap Access Requirements . . . . .	26-17
26.11	Final Plans and Specifications Preparation . . . . .	26-18
26.11.1	General . . . . .	26-18
26.11.2	60% Substructure Submittal/60% Structures Plans . . . . .	26-18
26.11.3	90% Structures Plans . . . . .	26-19
26.11.4	100% Structures Plans and Specifications . . . . .	26-20
26.12	Plans Assembly . . . . .	26-20
26.13	Plans Submittal . . . . .	26-21
26.13.1	Schedule . . . . .	26-21
26.13.2	Submittal Schedule . . . . .	26-21
26.14	Review for Constructibility and Maintainability . . . . .	26-21
26.14.1	Purpose . . . . .	26-21
26.14.2	Responsibility . . . . .	26-22



26.15	Review for Bidding	26-22
26 15 1	Purpose	26-22
26 15.2	Responsibility	26-22
26.16	Bridge Load Rating	26-23
26.17	Review of Non-FDOT Funded Projects (New Construction)	26-23
Exhibit 26-A,	Submittal Check List	26-24

## Chapter 26

### BRIDGE PROJECT DEVELOPMENT

#### 26.1 General

All structural design for the Florida Department of Transportation (FDOT) is developed under the direction of the Structures Design Office (SDO) and/or the District Structures Design Offices (DSDO). All designs are to be developed in accordance with the ***Structures Design Guidelines (Topic No. 625-020-150)***, the ***Structures Detailing Manual (Topic No. 625-020-200)***, this Manual, the ***Standard Drawings (Topic No. 625-020-300)***, the latest edition of the ***AASHTO Standard Specifications for Highway Bridges*** or the latest edition of ***AASHTO-LRFD Bridge Design Specifications***, applicable FHWA Directives, and other criteria as specified by the Department.

Structures for other agencies or authorities such as the Jacksonville Transportation Authority, various Expressway Authorities, etc. may be designed to meet the Department's criteria or additional criteria as specified by the authority.

#### 26.2 Organization

The Structures Design Office (SDO) is a subdivision of the Office of Design under the direction of the State Highway Engineer and the Assistant Secretary for Transportation Policy. The SDO is under the direction of the State Structures Design Engineer (SSDE). Each District, including the Turnpike, has a staff of structural engineers that comprise the District Structures Design Office (DSDO), and which is under the direction of the District Structures Design Engineer (DSDE).

#### 26.3 Definitions

All structures have been grouped into the following two categories based upon design difficulty and complexity:

### **26.3.1 Category 1 Structures**

Category 1 Structures consist of box culverts, short span bridges (continuous reinforced slabs and prestressed slabs), simple span bridges (steel and concrete), continuous straight steel plate girder bridges with spans less than 150 feet, bridge widenings for the above structure types, retaining walls, roadway signing, signalization and lighting supports, sound barrier walls, and overhead sign structures

### **26.3.2 Category 2 Structures**

Category 2 Structures consist of steel box girders, curved steel plate girders, continuous straight steel plate girder bridges with span lengths equal to or greater than 150 feet, cast-in-place concrete box girder bridges, concrete segmental bridges, continuous post-tensioned concrete bridges with or without pretensioning, steel truss, cable stayed, movable bridges, vessel collision designs and any structure with design concepts, components, details or construction techniques with a history of less than five (5) years of use in Florida

## **26.4 Abbreviations Used in Structures Design**

Terminology used in the area of Structures Design for the Florida Department of Transportation often is written or spoken in the form of abbreviations and/or acronyms. Following is a list of those terms frequently encountered in this manual and in other references used in structures design and include those commonly used for offices, organizations, materials, systems, features, equipment, conditions, and expertise

<b>AASHTO</b>	<b><i>American Association of State Highway and Transportation Officials</i></b>
<b>ACI</b>	<b><i>American Concrete Institute</i></b>
<b>ACIA</b>	<b><i>Assigned Commercial Inspection Agency</i></b>
<b>ADA</b>	<b><i>Americans with Disabilities Act</i></b>
<b>AISC</b>	<b><i>American Institute of Steel Construction</i></b>
<b>ANSI</b>	<b><i>American National Standards Institute</i></b>
<b>AREA</b>	<b><i>American Railway Engineering Association</i></b>
<b>ASTM</b>	<b><i>American Society for Testing and Materials</i></b>
<b>AWS</b>	<b><i>American Welding Society</i></b>
<b>BBS</b>	<b><i>Bulletin Board System</i></b>
<b>BDR</b>	<b><i>Bridge Development Report</i></b>

<b>BHR</b>	<b>Bridge Hydraulics Report</b>
<b>BHRS</b>	<b>Bridge Hydraulics Recommendation Sheet</b>
<b>CADD</b>	<b>Computer Aided Design and Drafting</b>
<b>CEI</b>	<b>Construction Engineering and Inspection</b>
<b>CES</b>	<b>Contract Estimating System</b>
<b>CIP (C-I-P)</b>	<b>Cast-in-Place (Concrete)</b>
<b>CPAM</b>	<b>Construction Project Administration Manual</b>
<b>CVN</b>	<b>Charpy V-Notch (Impact Testing)</b>
<b>DSDE</b>	<b>District Structures Design Engineer</b>
<b>DSDO</b>	<b>District Structures Design Office</b>
<b>DSFE</b>	<b>District Structures and Facilities Engineer</b>
<b>EMO</b>	<b>Environmental Management Office</b>
<b>EOR</b>	<b>Engineer of Record</b>
<b>FDOT</b>	<b>Florida Department of Transportation</b>
<b>FHWA</b>	<b>Federal Highway Administration</b>
<b>LRS</b>	<b>Low-relaxation Strands</b>
<b>LRFD</b>	<b>Load and Resistance Factor Design</b>
<b>MHW</b>	<b>Mean High Water</b>
<b>MSE</b>	<b>Mechanically Stabilized Earth (Walls)</b>
<b>MUTCD</b>	<b>Manual on Uniform Traffic Control Devices</b>
<b>NHS</b>	<b>National Highway System</b>
<b>NHW</b>	<b>Normal High Water</b>
<b>NOAA</b>	<b>National Oceanic and Atmospheric Administration</b>
<b>OIS</b>	<b>Office of Information Systems</b>
<b>OSHA</b>	<b>Occupational Safety and Health Administration</b>
<b>PDA</b>	<b>Pile Driving Analyzer</b>
<b>PD&amp;E</b>	<b>Project Development and Environment</b>
<b>PPD</b>	<b>Plans Production Date</b>
<b>PPM</b>	<b>Plans Preparation Manual</b>
<b>QPL</b>	<b>Qualified Products List</b>
<b>RDR</b>	<b>Required Driving Resistance</b>
<b>SDO</b>	<b>Structures Design Office</b>
<b>SIP (S-I-P)</b>	<b>Stay-in-Place (Forms)</b>
<b>SRS</b>	<b>Stress-relieved Strands</b>
<b>SSDE</b>	<b>State Structures Design Engineer</b>
<b>TAG</b>	<b>Technical Advisory Group (SDO and DSDE's)</b>
<b>TFE (PTFE)</b>	<b>Polytetrafluorethylene (Teflon)</b>
<b>UBC</b>	<b>Ultimate Bearing Capacity</b>
<b>UV</b>	<b>Ultraviolet</b>
<b>VECP</b>	<b>Value Engineering Change Proposal</b>

## 26.5 Responsibility

The District Structures Design Office has total project development responsibility for projects involving Category 1 Structures, upon release by the Structures Design Office. The Structures Design Office has total project development responsibility for projects involving Category 2 Structures.

The District Project Manager shall coordinate with the District Structures Design Engineer who shall review and concur with the bridge aspect of all projects during the PD&E process in accordance with **Chapter 9** of the **PD&E Manual**.

The District Structures Design Engineer or the State Structures Design Engineer, as appropriate, shall concur/approve all bridge related work after location design approval is granted.

## 26.6 FHWA Oversight

See **Chapter 24** of this manual for FHWA requirements.

## 26.7 Bridge Project Development

The following sections will define, clarify and list the information necessary to produce an acceptable and reproducible set of contract documents (special provisions, bridge contract drawings, etc.) ready for advertisement and construction.

Bridge project development normally includes five phases of development. The first phase of development, bridge analysis, occurs during the Project Development and Environment (PD&E) process. After location design approval is granted, the second phase, Bridge Development Report/30% Structures Plans, is initiated. After approval of the BDR, the final phases of work will begin. The third phase is the 60% Structures Plans which consists of the substructure foundation submittal for all projects and 60% Structures Plans for most Category 2 Structures. The fourth phase includes the 90% Structures Plans and specifications. The fifth phase includes the 100% Structures Plans and specifications. For efficiency, one engineering firm (one design team) should be responsible for the BDR and the final plans and specifications.

For Category 2 bridges and some Category 1 bridges, step negotiations are suggested. Step negotiations are desirable because the final bridge type cannot be determined until the BDR is complete. Utilizing this scenario, the first step of the negotiations would include the BDR/30% Structures Plans. After submittal of the BDR/30% Structures Plans, negotiations for final three phases of work (60% Structures Plans, 90% Structures Plans and 100% Structures Plans) would begin. Negotiations should not be finalized until the BDR/30% Structures Plans are approved by the DSDO or the SDO as appropriate.

## **26.8 Bridge Analysis**

### **26.8.1 General**

The Bridge Analysis is performed during the PD&E phase of work by qualified bridge engineers. The District Structures Design Engineer must concur with the findings of the bridge analysis which is part of the preliminary engineering report. The function of the bridge analysis is to determine the general attributes for the recommended bridge. The specific attributes of the bridge will be defined in the BDR.

For bridges over water, a location Hydraulics Report will be prepared in conjunction with the bridge analysis. General site geotechnical knowledge is also required (usually from existing bridge plans) or, in some cases, it may be desirable to obtain borings.

### **26.8.2 Contents**

The bridge analysis shall provide conceptual guidance for the bridge design consultant. Conceptual guidance on how the bridge should fit into the uniqueness of the site should be provided. Bridge design and structure type should be left to the design team in the later phases of work. Bridge analysis shall include the following:

- A Environmental and site considerations,
- B Vertical and horizontal clearances (existing and proposed),
- C Disposition of existing structure,
- D Vertical and horizontal geometry,
- E Typical section,
- F Conceptual ship/barge impact data (sample of recreational and commercial traffic),
- G Identification of historical significance of bridge and surrounding structures,
- H Aesthetic level for bridge and bridge approaches,
- I Location Hydraulics Report,

- J Bridge deck drainage considerations,
- K Stream bottom profile,
- L Conceptual geotechnical data,
- M For sites with movable bridge options, a life cycle cost comparison will be prepared and compared to a fixed bridge,
- N Phase Construction Impacts,
- O Construction time

## 26.9 Bridge Development Report (BDR)/30% Structures Plans

### 26.9.1 General

The BDR is intended to establish all the basic parameters that will affect the work done in the Design and Plans Preparation phase. Initiation of the BDR shall occur after location design approval (For some sites only a programmatic categorical exclusion will be required before initiation of the BDR). Once approved, the BDR will define the continuing work by the Engineer of Record (EOR). It is mandatory that the EOR obtain and coordinate the information and requirements of the offices and engineering disciplines whose input is essential to the preparation of an effective BDR. Changes to the parameters after the BDR is approved could result in schedule delays and supplemental agreements, therefore, it is critical that District Offices, FHWA (if involved), the Structures Design Office and other involved agencies recognize the purpose and importance of the BDR. The BDR phase of work will contain sufficient detail for the justification of the proposed bridge type. For most projects, the 30% Structures Plans will be included as an appendix to the BDR. The BDR is developed from information outlined on the Bridge Development Report Submittal Checklist shown in **Exhibit 26-A**, located at the end of this chapter. This information is often provided by others, however, the EOR is responsible for insuring that all of the information is adequate and appropriate. If the data is not sufficient, the EOR must obtain the required information before the BDR can be completed and submitted.

When alternate designs are considered, consistency between the alternates is essential in ensuring equitable competition and optimum cost-effectiveness. This consistency includes uniformity of design criteria, material requirements and development of unit costs.

The BDR should contain only supportable and defensible statements. Subjective opinions or unsubstantiated statements are not acceptable. All arguments must be clearly and logically defensible with calculations, sketches or other technical data.

The quantity of work necessary to prepare the BDR depends upon the project's complexity, however, the usual work effort for bridge types normally encountered is

- A **Minor Bridge Widening** The BDR will be a minor work effort, however, viable structural possibilities and economical options should be thoroughly investigated to determine if replacement of the bridge would be more appropriate than its widening. This is particularly true at sites where the existing bridge condition is marginal, where there has been a record of serious flooding or scouring, when the widening is part of a route improvement with a high potential for attracting traffic, if the existing bridge has a history of structural problems (including ship impact), or the inventory rating is less than required by AASHTO and cannot be improved.
- B **Minor Grade Separations or Small Water Crossings** The BDR shall be a thorough document that adequately addresses all viable structure types, however, the BDR will not usually be an extensive document since the viable types of superstructure and substructure are generally limited. Scour and ship impact shall be considered.
- C **Major Bridges (including Movable) and Major Interchanges** The BDR shall be an extensive and comprehensive document that thoroughly considers all viable structure types and considers all design parameters (such as vessel collision and scour).

## 26.9.2 Contents

The major items to be considered in the BDR are

- A **General** The bridge length, height and pier locations are subject to vertical and horizontal design clearance requirements such as those for clear zone, navigation and hydrology. After these considerations are met, span lengths are governed by economics and aesthetic considerations. Superstructure depths (grade separation structures in particular) shall be kept to the minimum that is consistent with good engineering practice. Recommended span/depth ratios for steel superstructures are shown in AASHTO

The length of the bridge will be affected by

- o Opening required by the Bridge Hydraulic Report
- o Environmental Considerations
- o Railroad clearances and cross-sections
- o Width of waterway and/or width of cross-section of roadway being spanned including the use of retaining walls



- B     **Statical System** The economic and engineering advantages of both simple span and continuous spans shall be addressed
- C     **Superstructure** Some superstructure types that could be considered are prestressed concrete girders, double-tee sections, reinforced or prestressed concrete slabs, steel rolled sections or plate girders, steel or concrete box girders, and post tensioned slabs, bulb-tees or boxes
- D     **Substructures** Some substructure types that could be considered are pile bents and multi-column or hammerhead piers. Variations of column shapes may be appropriate for aesthetic or economical requirements. Precast substructures concepts shall be considered especially for large waterway crossings
- E     **Foundations** Some foundation types that could be considered are steel and concrete piles, drilled shafts and spread footings
- F     **Vessel Collision** Ship impact forces will often have a major effect on the structural configuration and overall economics. See vessel collision requirements in the ***Structures Design Guidelines***
- G     **Scour** The 100 year and 500 year predicted scour elevations will often have a major effect on the foundation design. See the foundations and geotechnical requirements in the ***Structures Design Guidelines***
- H     **Quantity estimates** For minor bridges rough quantities (such as reinforcing steel based on weight per volume of concrete) may be sufficient. For major and complex bridges the degree of accuracy may require more exact calculations keeping in mind that the intent is to establish relative and equitable costs between alternates and not necessarily to require the accuracy of the Final Estimate. Also, for major and complex structures it may be necessary to develop unit costs from an analysis of fabrication, storage, delivery and erection costs of the different components
- I     **Unit costs** Data available from the FDOT or contractors and suppliers should be used to arrive at unit costs. The sources of all price data shall be recorded for later reference
- J     **Develop cost curves** For each alternative establish the most economical span arrangement, i.e., minimum combined superstructure and substructure cost

- K **Retaining Wall Study** If retaining walls are present, a retaining wall study shall be included in the BDR. This study will conform with the work as specified in **Chapter 30** of this manual and **Chapter 4** of the ***Structures Design Guidelines***
  
- L **Movable Bridges** For movable bridges the BDR shall include information on the type of equipment for the machinery and electrical drive systems, together with a general description of the control system to be utilized. A written description and preliminary layouts of system components shall be included

For rehabilitation project plans, the BDR stage shall include plans and written descriptions of those system components to be modified from the existing configuration, along with plans of the existing configuration. Submittal of information described in the previous paragraph is not required unless the electrical and mechanical configuration is modified from the existing configuration.

### **26.9.3 Format**

The report shall use standard, letter-size pages with any larger sheets or drawings folded to fit the report size. The report shall be neatly written and the contents presented in a logical sequence with narrative, as required, to explain the section contents. An Executive Summary shall compare the relative features and costs of the alternates considered and recommend alternate(s) to be carried forward into the Final Structures Plans Preparation phase.

The BDR shall be as self-contained as possible by including all arguments that establish, justify, support, or prove the conclusions. It is acceptable to make reference to other documents that will be included in the final submittal package, however, any documentation that will help emphasize a point, support a statement, or clarify a conclusion shall be included. Such documentation may include drawings, clear and concise views, or other such illustrated information.

The BDR shall address construction time requirements and the effect that components, systems, site constraints and conditions, or other site characteristics or criteria have upon the construction time, whether additive or deductive.

For most projects, the 30% Plans shall be an appendix to the BDR.

## 26.9.4 Aesthetics

- A General Any bridge design must integrate three basic elements efficiency, economy and elegance Regardless of size and location, the quality of the structure, its aesthetic attributes and the resulting impact on its surroundings must be carefully considered Achieving the desired results involves
- 1 Full integration of the three basic elements listed above
  - 2 The EOR's willingness to accept the challenge and opportunity presented A successful bridge design will then be elegant or aesthetically pleasing in and of itself and will be compatible with the site by proper attention to form, shapes and proportions Attention to details is of primary importance in achieving a continuity of line and form In general, the rule of "form following function" shall be used

The designer must consider the totality of the structure as well as its individual components and the environment of its surroundings A disregard for continuity or lack of attention to detail can negate the best intent Formulas cannot be established, however, the ACI's *Aesthetic Considerations for Concrete Bridges* and the TRB's *Bridge Aesthetics Around the World* as well as authors such as David P. Billington can guide the designer A book developed by the Maryland Department of Transportation entitled *Aesthetic Bridges* provides excellent guidance In bridge aesthetics the designer is dealing with the basic structure itself, not with enhancement, additions or other superficial touches The EOR is expected to be well-read on the subject of bridge aesthetics and committed to fulfilling both the structural and aesthetic needs of the site

The challenge differs for major and minor structures Indeed, the challenge may be greater the smaller the project Major structures, because of their longer spans, taller piers, or curving geometry often offer inherent opportunities not available for minor bridges

Some basic guidelines where aesthetics may play a more important role are

- 1 Bridges highly visible to large numbers of users (maritime and/or motorists)
- 2 Bridges located in or adjacent to parks, recreational areas, or other major public gathering points
- 3 Pedestrian bridges
- 4 Bridges in urban areas in or adjacent to commercial and/or residential areas
- 5 Multi-bridge projects, such as interchanges, or corridors should attain a conformity of theme and unifying appearance Avoid abrupt changes in structural features

Considering the above, the District will determine the level of aesthetic effort warranted on a project early in its development. When significant aesthetic expense is proposed, such as is the case with Level Three below, Federally funded projects require legitimate written justification.

## B Levels of Aesthetics

Normally the District will establish one of the following three general levels of aesthetic consideration and effort at each structure's site:

- 1 **Level One:** Consists of cosmetic improvements to conventional Department bridge types, such as the use of color pigments in the concrete, texturing the surfaces, modifications to fascia walls, beams, and surfaces, or more pleasing shapes for columns and/or caps.
- 2 **Level Two:** The emphasis is on full integration of efficiency, economy and elegance in all bridge components and the structure as a whole. Consideration should be given to structural systems that are inherently more pleasing, such as hammerhead or "T" shaped piers, oval or polygonal shaped columns, integral caps, piers in lieu of bents, smooth transitions at superstructure depth change locations, box-type superstructures, etc.
- 3 **Level Three:** The emphasis in this level applies more to the overall aesthetics when passing through or under an interchange or at other sites such as historic or highly urbanized areas where landscaping or unique neighborhood features must be considered. The bridge itself shall comply with Level Two requirements. This level of work may require, at the District's option, a subconsultant (architect to consider adjacent building styles, and landscape themes) with the necessary expertise and credentials to perform the desired work.

The aesthetic levels described above are not exclusive. For example, where the EOR believes a specific landscape feature might significantly enhance bridge site elegance, even on a Level 1 design, the recommendation should be offered for the Department's consideration. For aesthetic Levels 2 and 3, public input into this issue may be appropriate. The EOR may recommend particular public involvement to the Department for consideration or the district might specify such efforts at specific times during the BDR and/or final plan development phase of the project.

The BDR shall include a summary of aesthetic considerations for the structure and the site. The summary shall consist of sketches, drawings, etc. of recommended treatment as well

as the options considered in the aesthetic study but not recommended as appropriate. It shall also include an estimate of cost to implement the recommended aesthetic treatment.

### **26.9.5 Construction and Maintenance Considerations**

All viable structure concepts shall be evaluated for constructibility. Items such as member sizes, handling, fabricating, and transporting members as well as maintenance of traffic, construction staging, equipment access, equipment requirements, etc. must be considered. Special evaluation shall be made to insure against potential problems that may occur in obtaining permits and equipment to transport long and/or heavy members from point of manufacture to the project site. The Department's Road Use Permits Office shall be contacted for questions concerning the feasibility of transporting long and/or heavy structural components. Also, considerations for future maintenance inspection shall be taken into account in the structure's design. Such considerations shall include those described in **Article 26.14** of this Chapter and the bearings and joint requirements of the **Structures Design Guidelines**, or the need for 6'-0" minimum headroom inside steel or concrete box girder superstructures. The intent here being that all special construction and maintenance requirements are identified and appropriately considered in any concepts recommended for design. A design is properly inspectable when it permits safe inspector access to all portions of the structure using equipment available to District Structures and Facilities personnel.

### **26.9.6 Historical Significance Considerations**

When an older bridge is considered for rehabilitation or replacement, the Environmental Management Office will evaluate the historical significance of the structure. A structure may be historically significant due to some of the following characteristics:

- A The structure may be an historic example in the development of engineering
  - B The crossing may be historically significant
  - C The bridge may be associated with an historical property or area
  - D The bridge might be associated with significant events or circumstances
  - E National Register of Historic Places or on a state or local historical register
- If it is determined that the structure is historically significant, then the project should be developed to preserve the historic character of the structure.

### **26.9.7 Alternative Designs**

The use of alternative designs for some larger or complex projects may result in more competitive bids and lower costs. Accordingly, the EOR shall evaluate benefits from alternatives for the particular structure being developed and provide a recommendation for or against preparing alternative designs. The alternative designs recommended shall be supported by the evaluations included in the BDR. As a guide, the following should be considered in evaluating justification for alternative designs:

- A Alternative designs shall be considered for all structures that cost more than \$20 Million
- B Consider alternative designs for structures that cost less than \$20 Million when project issues reflect possible advantages from competitive bids
- C Alternate designs shall be evaluated when a new design concept is used until a bid history can be established

### **26.9.8 Conclusions and Recommendations**

With due consideration for all applicable data, the engineer shall recommend the final bridge design system for the site. Thorough justification for the selection will be presented which examines each element of data, and the total estimated construction cost of the recommended design shall be indicated in the BDR. For most projects, the recommended design shall be supported by thirty percent plans (preliminary) as an appendix to the BDR.

The following sections will define, clarify and list the information necessary to produce an acceptable and reproducible set of contract documents (special provisions, bridge contract drawings, etc.) ready for advertisement and construction. The production of a bridge project commences with the Bridge Development Report (BDR) and ends with complete Contract Documents.

### **26.9.9 30% Structures Plans**

The 30% Structures Plans should be submitted with the Bridge Development Report for most structures. The consultant's scope of services should clearly state at what point are the 30% plans to be submitted. If the 30% Structures Plans are submitted separately, the BDR shall contain enough information and drawings to depict the information needed to properly determine the type, size and location of the bridge. The Phase 1 Geotechnical Report and the Hydraulic Report shall be included with the submittal containing the BDR.

The 30% Structures Plans should show, as a minimum, the following information:

- a General Notes Sheet As many general notes as possible should be included on this sheet at this stage. Subsequent additions shall be made, when necessary, as the design progresses (for example of General Notes, see **Chapter 3** of the **Structures Detailing Manual**)
- b Plan and Elevation Sheet provide contents as required by the **Structures Detailing Manual**
- c Substructures For piers or intermediate bents, show substructure elements and sizes including all deviations from the typical dimensions, foundation type including element spacing and the arrangement of piles or drilled shafts
- d Superstructure Include cross section showing lanes, shoulders, railings, slab thickness, beam type and spacing and web depth for steel girders. If applicable, show geometric changes in shapes of various components. Also show construction phases and maintenance of traffic data, outline of the existing structure and portions to be removed, and utilities (existing and proposed as available)
- e Retaining Walls Preliminary control drawings shall be submitted when proprietary or standard cast-in-place walls are proposed. Include control drawings for all critical temporary walls
- f Bridge Hydraulic sheet
- g Report of core borings
- h Preliminary bearing type(s)
- l Proposed construction sequence and methods, indicate construction easements and methods of construction access
- J Preliminary aesthetic details
- k Preliminary post-tensioning layouts
- l Preliminary foundation layouts and installation table
- m Any other special details required by the Engineer or details which are not normally used on Department projects

In addition to the above requirements, the following items will be included for moveable bridges preliminary electrical and mechanical equipment layouts in plan and elevation, submarine cable routing, and single line electrical diagrams including service voltage All equipment shall be rough sized and supporting calculations shall be submitted

Requests for design exceptions and/or variations for structural design criteria, shall be included in the 30% Structures Plans Submittal Design exceptions and design variations shall be approved in accordance with **Chapter 23** of this manual with concurrence of the DSDO or SDO as appropriate

## **26.10 Bridge Development Report (BDR) Submittal Checklist**

The Bridge Development Report (BDR) Submittal Checklist (**Exhibit 26-A**) contains a list of the key supporting elements that are required for the preparation, submittal and review of a BDR This Checklist must be included with the BDR when submitted for review and consists of the following items

### **26.10.1 Typical Sections for Roadway and Bridge**

The approved typical sections for both the bridge and roadway are required

### **26.10.2 Roadway Plans**

Preliminary roadway plans covering the bridge vicinity are required

### **26.10.3 Maintenance of Traffic Requirements**

The Maintenance of Traffic Plan must show the number of required lanes as well as lane widths of all affected roadways

### **26.10.4 Bridge Hydraulics Report and Bridge Hydraulics Recommendation Sheet**

The Bridge Hydraulics Report (BHR) shall be prepared in accordance with the **FDOT Drainage Manual** It shall include the Bridge Hydraulic Recommendations Sheet (BHRS)



and address the required hydraulic opening, clearances, scour and deck drainage requirements. In addition to design water elevations normally shown, The BHRS shall include the Mean Higher High Water (MHHW) elevation. Concurrence of the BHR by the District Drainage Engineer with the District Structures Design Engineer for Category 1 Structures and State Structures Design for Category 2 Structures is required. The BHRS is required in the Final Plans of all bridges over water.

#### **26.10.5 Geotechnical Report**

The Bridge Geotechnical Report (Phase I) shall be prepared in accordance with **Chapter 4** of the *Structures Design Guidelines* and the Department's *Soils and Foundations Manual (Topic No. 675-020-012)*. The report shall document a thorough investigation of all viable foundation types for the bridge and retaining walls. Concurrence of the District Geotechnical Engineer is required for Category 1 Structures and of both the State and District Geotechnical Engineers for Category 2 Structures.

#### **26.10.6 Bridge Corrosion Environment Report**

A Bridge Corrosion Report shall be prepared to determine the environmental classifications for the structure in accordance with the *Structures Design Guidelines* and must be approved by the District Materials Office.

#### **26.10.7 Existing Bridge Plans**

A set of prints of the existing (preferably as-built) bridge plans should be included for replacement structures and widenings. This is of particular importance for widenings and phase construction. These plans are not usually necessary for completely separate alignments or new interchanges unless the existing structures either will be used for new construction activities or will infringe upon the Contractor's allowed work zone.

#### **26.10.8 Existing Bridge Inspection Report**

A copy of the latest existing Bridge Inspection Report and Structures Inventory and Appraisal Form is required for all widenings and rehabilitations and may be required for new structures. The existing paint system(s) on all significant metal elements of existing structures shall be identified. The presence of lead-based paint and/or asbestos shall be clearly delineated.

### **26.10.9 Utility Requirements**

All proposed utility attachments to the structure as well as all existing and proposed utilities in the vicinity of the structure shall be identified. The requirements of the Department's *Utility Accommodation Manual (Topic No. 710-020-001-d)* shall be followed regarding attachments to the structure.

### **26.10.10 Railroad Requirements**

Existing as well as future railroad requirements must be identified. This will include all clearances as well as crash wall or other construction parameters. Copies of correspondence with the Railroad Agency shall be included.

### **26.10.11 Retaining Wall and Bulkhead Requirement**

All permanent and temporary retaining wall requirements shall be identified and the proposed type of wall shall be shown. The type, location and extent of temporary walls to accommodate phased construction and/or maintenance of traffic must be identified.

For water crossings where erosion and/or wave action is anticipated, the type, location and extent of bulkhead production shall be identified. The tie-back and anchor system proposed for use shall be included in the submittal.

### **26.10.12 Lighting Requirements**

All proposed lighting on or under the structure shall be identified.

### **26.10.13 Handicap Access Requirements**

Any handicap access requirements that affect the structure shall be identified.

## **26.11 Final Plans and Specifications Preparation**

### **26.11.1 General**

Within this phase of work, for both Category 1 and 2 Structures, there are three phases of work, viz, 60% Substructure submittal or 60% Structure Plans, 90% Structure Plans and 100% Structures Plans and Specifications. For projects requiring fully designed proprietary wall plans, approved control drawings shall be submitted to the appropriate proprietary wall companies as soon as possible and no later than the 60% substructure submittal. A copy of this submission shall be sent to the DSDO or SDO as appropriate. At any time during the project development, the reviewer may require submittal of design calculations.

After each of the phases, except the 100% Structures Plans Phase, review comments from the FDOT are sent to the EOR by letter and/or a marked-up set of prints. The EOR must address each of the comments in writing and resolve each comment prior to the next submittal. The FDOT 100% Structures Plans review comments are to be handled as described above, except that unresolved comments may be handled by telephone, in some instances, if confirmed in writing. Also, for any phase, items and drawings from a preceding phase must be included. These drawings shall reflect the comments resolved from the previous phase as well as the accumulated design and drafting effort required of the current phase.

### **26.11.2 60% Substructure Submittal/60% Structures Plans**

This submittal phase is divided into two distinct parts, viz, the 60% Substructure Submittal (required for all projects) and the 60% Structures Plans for Category 2 Structures and some Category 1 Structures.

#### **A 60% Substructure Submittal**

This submittal is required for every project and should be made a part of the 60% Structures Plans phase when that phase is part of the project. The submission is only a partial plans set the purpose for which is to communicate essential project information to the Geotechnical and Hydraulic Engineers so that all remaining calculations can be performed using actual structural shapes, loads, and dimensions. Plan sheets required for this submittal include Plan & Elevation, Bridge Hydraulic Sheet, Boring Logs, Foundation layout, Substructure Plans, and draft technical specifications.

#### **60% Substructure Submittal Contents**

Foundation Layouts  
Foundation Installation Notes  
Pile/Drilled Shaft Installation Table

Footing Concrete Outlines (All Variations)  
Pier Concrete Outline (All Variations)  
Wall Plans - Control Drawings  
Pile Details  
List of Pay Items  
Lateral Stability Analysis Completed  
Phase II Geotechnical Report  
Draft Technical Specifications  
Reinforcement of Footing and Column  
Post-Tensioning Details  
Plan and Elevation Sheet  
Hydraulic Data Sheet

**B 60% Structures Plans**

When a 60% Structures Plans submittal is required, all comments from earlier reviews shall have been resolved. At this phase, the design should be 90% complete and the plans, 60% complete. In addition to the documents required for the 60% Substructure Submittal described above, the 60% Structures Plans shall include a list of pay items to be used and plans containing the following details as applicable: final concrete outlines of all individual components, major reinforcing steel, final post-tensioning layouts, steel box/I-girder details, segmental concrete box details, bearing details, seismic details, details of congested areas, details of unique features, and other details as required. For moveable bridges the following additional information is required: electrical calculations (for generator size, service voltage drop, short circuit, service size, automatic transfer switch, etc.), single line diagram showing equipment sizes and utilities, conduit and wire sizes, panelboard schedules, and light fixture schedules.

**26.11.3 90% Structures Plans**

Upon approval of the BDR/30% Structures Plans or 60% Structures Plans, as applicable, (90% Structures Plans) shall begin. At this stage of plans development, the EOR shall have resolved the 30% and/or 60% Structures Plans review comments and developed the plans for completion. The design and plan production shall be 100% complete. This submittal shall include prints of the completed plans, CES (complete with quantities), design calculations, Final Phase II Geotechnical Report, Addendums to Hydraulic Report and, if appropriate, Technical Special Provisions. No sheet or detail should be missing at this stage.

#### **26.11.4 100% Structures Plans and Specifications**

After resolution of the 90% Structures Plan comments, the EOR shall make all authorized changes necessary to complete the plans and Technical Special Provisions. The EOR shall provide a list of all changes made to the Plans or Specifications that were not directly related to the 90% Structures Plans review comments. The intent is to help minimize the Department's review time and to help the Department's review office to focus on only those new items or details proposed by the EOR. This will, in turn, help to expedite the project's authorization.

The 100% Structures Plans submittal is divided into two distinct phases. First, prints of the original drawings and technical special provisions are submitted 30 days prior to the District's Plans Production Date (PPD). Secondly, once notified by the FDOT, the original drawings and all other documents are submitted to the District.

Within the 30 day period allotted, the EOR will receive notification either of additional changes/corrections to be made or to submit the Final Plans as they are. If at anytime during the 30-day period the EOR finds additional changes/corrections that should be made, the Structures Design Office responsible for plans approval (either the District Structures Design Engineer (DSDE) or the Structures Design Office (SDO) as appropriate) must be notified for discussion and resolution.

Once all changes/corrections are made, or if no changes/corrections are necessary, the EOR shall submit all his work to the District prior to or on the PPD. Submittal of this stage of the work shall include the original drawings, one record set of prints with each sheet sealed in accordance with **Chapter 19** of this manual, quantities book assembled as specified in the Department's **Basis of Estimate Handbook**, sealed Technical Special Provisions (if required), and sealed summary of estimated bridge quantities (CES). If included in the Scope of Services, original documents in electronic media such as CADD diskettes may also be required.

#### **26.12 Plans Assembly**

The **Structures Detailing Manual** shall be consulted for plans assembly, materials, content of plans, and other drafting information which includes the following listed items and their respective chapters:

- o Drafting Material Chapter 1
- o Standard Drawings Chapter 4

- o Drawing Numbers Chapter 4
- o Sheet Numbers Chapter 4
- o Approach Slab Sheets Chapter 4
- o Financial Project ID Chapter 2
- o Bridge Numbers Chapter 2
- o Summary of Bridge Pay Items Chapter 3
- o Engineer of Record and Consultant Name Chapter 2
- o Scales Chapter 2

## **26.13 Plans Submittal**

### **26.13.1 Schedule**

The District Project Manager is responsible for establishing the schedule of submittals with input from the EOR and either the District Structures Design Engineer for Category 1 or Structures Design Office for Category 2 projects

### **26.13.2 Submittal Schedule**

- o BDR/30% Structures Plans
- o 60% Substructure Submittal/60% Structures Plans
- o 90% Structures Plans
- o 100% Structures Plans

## **26.14 Review for Constructibility and Maintainability**

### **26.14.1 Purpose**

The purpose of this review is to provide reasonable and practical use of fabrication and construction techniques and equipment without overloading and/or overstressing components, provide for proper material handling and transportation, provide safe maintenance of traffic and provide an appropriate construction sequence. Additionally, provide features which will retard bridge deterioration, permit reasonable access to all parts of the bridge for inspection and performance evaluation and provide features to facilitate replacement of damaged and/or deteriorated bridge components

### **26.14.2 Responsibility**

For Category 1 and 2 Structures, it will be the responsibility of the project manager or his designee to coordinate a review of both the 30% and 90% Structures Plans submittals by the appropriate District Construction and Maintenance personnel for constructability and maintainability. For Category 1 structures, technical issues shall be resolved by the appropriate DSDE.

Additionally, for Category 2 Structures, it will be the responsibility of the Structures Design Office to coordinate a constructability and a maintainability review of the 30% Structures Plans submittal.

The Construction and Maintenance Offices should be given adequate time to perform these reviews. All comments from these reviews shall be addressed prior to the next submittal and its subsequent review.

## **26.15 Review for Biddability**

### **26.15.1 Purpose**

To prevent construction problems, the District Construction Office will review the plans to make certain the plans are clearly understandable, contain all pertinent notes and have sufficient and correct pay items. During the biddability review, the Construction Office will check for the interface with the roadway segment of the project, utility agreements and environmental permits.

### **26.15.2 Responsibility**

For Category 1 and 2 Structures, it will be the responsibility of the project manager to coordinate a review of the 90% Structures Plan submittal. This review should occur at the same time as the Phase III Plans submittal for the roadway segments of the project.

Additionally, for Category 2 Structures, it will be the responsibility of the Structures Design Office to coordinate a review of the 90% Structures Plans submittal.

The Construction Offices should be given adequate time to perform these reviews. All comments from these reviews shall be addressed prior to the 100% Structures Plans Stage submittal.

## **26.16 Bridge Load Rating**

Generally the Engineer of Record shall load rate each structure design in accordance with Department procedures as provided by the Maintenance Office and shall be completed when required by the scope of services for the project

## **26.17 Review of Non-FDOT Funded Projects (New Construction)**

FHWA review will be required whenever a privately funded structure crosses over an interstate route, or when such work otherwise affects such a route, i.e., land closures, access, R/W changes, etc. The extent of FDOT and FHWA review is that

- o Plans must meet all current clearance requirements (vertical and horizontal)
- o Maintenance of traffic scheme for construction must be reviewed and approved
- o All attachments to the structure over the highway must be securely fastened
- o Design must be sealed by a licensed professional engineer
- o Design must be in accordance with a nationally recognized code such as AASHTO, ACI, AISC, etc
- o Plans must meet all District permit requirements and procedures
- o Only projects over or affecting a NHS facility shall be submitted to FHWA for approval
- o FDOT review for these structures shall be performed by the District Structures Design Engineer for Category 1 and 2 structures



# Bridge Development Report (BDR)

## Submittal Checklist

Project Name \_\_\_\_\_

Financial Project ID \_\_\_\_\_

State Project No \_\_\_\_\_ W P I No. \_\_\_\_\_

FA No \_\_\_\_\_ FHWA Oversight ( yes no) NHS ( yes no)

Date \_\_\_\_\_ FDOT Project Manager \_\_\_\_\_

ITEMS	STATUS <sup>(b)</sup>
1 Typical Sections for Roadway and Bridge <sup>(a)</sup>	P NA C
2 Roadway Plans in Vicinity of Bridge <sup>(a)</sup>	P NA C
3 Maintenance of Traffic Requirements <sup>(a)</sup>	P NA C
4 Bridge Hydraulics Report <sup>(c)</sup>	P NA C
5 Geotechnical Report <sup>(c)</sup>	P NA C
6 Bridge Corrosion Environmental Report <sup>(c)</sup>	P NA C
7 Existing Bridge Plans	P NA C
8 Existing Bridge Inspection Report	P NA C
9 Utility Requirements.....	P NA C
10 Railroad Requirements	P NA C
11 Retaining Wall and Bulkhead Requirements	P NA C
12 Lighting Requirements	P NA C
13 Handicap Access Requirements	P NA C
14 Other.....	P NA C

- (a) Must be approved by District before BDR submittal
- (b) Circle appropriate status  
 P - Provided NA - Not Applicable C - Comments attached
- (c) See approval requirements for these documents elsewhere in this chapter

### Exhibit 26-A

## Chapter 27

### HYDRAULIC DATA AND U.S. COAST GUARD PERMITS

27.1	Bridge Hydraulic Report (BHR)	27-1
27.2	Bridge Hydraulic Recommendation Sheet (BHRS)	27-1
27.3	U.S. Coast Guard Permit	27-1
27.4	Scour Considerations	27-2
27.4.1	Development of Scour Design Criteria	27-2
27.4.2	Submittal Requirements for Scour Design	27-4
27.5	Debris Accumulation	27-4
27.6	Widenings	27-4
27.7	Scour Elevations	27-4
Figure 27.1		27-5
Figure 27.2		27-6

## Chapter 27

### HYDRAULIC DATA AND U.S. COAST GUARD PERMITS

#### 27.1 Bridge Hydraulic Report (BHR)

A Bridge Hydraulic Report (BHR) package consisting of the BHR and, as applicable, the Bridge Hydraulics Recommendation Sheet, bridge hydraulic calculations, and scour calculations shall be prepared as specified in **Chapter 4** of the FDOT *Drainage Manual, Topic No. 625-040-001*. The BHR package shall be processed as specified later in this chapter.

#### 27.2 Bridge Hydraulic Recommendation Sheet (BHRS)

A Bridge Hydraulic Recommendation Sheet (BHRS) for new structures and widenings shall be prepared as specified in **Chapter 4** of the FDOT *Drainage Manual*. The BHRS package shall be processed as specified later in this chapter.

#### 27.3 U.S. Coast Guard Permit

For Federal-Aid projects, a U.S. Coast Guard Permit may be required for the construction of a bridge or causeway over navigable waters. If a water body is tidally influenced, a permit will probably be required. The FDOT District Permit Coordinator will determine when a permit is required for a particular site. If a determination is made that a permit is not required, FHWA concurrence is necessary (see, *Project Development and Environment Manual, Topic Number 650-000-001*).

The permit shall be prepared in accordance with the "*U.S. Coast Guard Bridge Permit Application Guide*". The official instructions for preparing and handling the permit drawings will be issued by the District Permit Coordinator. Additional information is available in *Environmental Management Office Procedure No. 650-040-001*.

Prior to preparation of the permit, the U.S. Coast Guard office having jurisdiction over the waterway for the project shall be notified of the intent to file a permit, and preparation of

the permit shall be coordinated with that same office to minimize the chance for conflict, incorrect clearances, or other requirements not being shown

## 27.4 Scour Considerations

Scour estimates shall be developed using a multi-disciplinary approach involving the Hydraulics Engineer, the Geotechnical Engineer, and the Structures Design Engineer. Bridges and bridge culverts shall be designed to withstand the design flood without damage and should withstand the 500-year flood (super flood) without failure. Refer to the **Structures Design Guidelines, Topic No. 625-020-150**, for specific foundation design steps.

### 27.4.1 Development of Scour Design Criteria

The extent and the mitigating steps needed to resolve scour problems should be resolved early in the design process. The Bridge Development Report (BDR), or 30% structures plans submittal when a BDR is not required, is a means of addressing and resolving all major design issues early in the total design process and should also define the need for scour considerations, establish the scour parameters, and arrive at possible solutions. This can be achieved through the concerted and cooperative efforts of the Hydraulics, Geotechnical, and Structures Design Engineers. The necessary steps are as follows:

- A The Drainage Design Engineer evaluates stream stability and scour potential based on all available data, assumed soil conditions, structure positioning, and foundation designs. The Drainage Design Engineer's assumptions (hydraulic, geotechnical, and structural) and design parameters should be discussed with both the Geotechnical and Structures Design Engineers. When evaluating stream stability and scour potential, the recommendations developed from FHWA's **Hydraulic Engineering Circular (HEC) 18 and 20** should be followed as well as the design requirements provided in **Chapter 4** of the FDOT **Drainage Manual**. This work should take place early in the PD&E study where changes in the alignment could affect the severity of general scour.
- B Given the scour potential and based on known subsoil conditions and where knowledge of the local variability of the subsoil is available, the Geotechnical Engineer will then consider the possible alignments. It may be necessary to conduct exploratory work if variability of subsoil conditions are suspected but not sufficiently defined. The results of exploratory investigations should be discussed with both the Hydraulics and Structures Design Engineer, and any previous scour assumption verified and/or modified.

- C The Structures Design Engineer should provide approximate span ranges, pier configurations, and pier locations necessary for the different alternates. In addition, possible foundation types and approximate size should be developed such that the Drainage Design Engineer can estimate local scour potentials. Conditions to be considered are
  - 1 The extent and severity of scour along the alignment must be developed. For example, for bridges over a wide body of water, general scour could vary in extent and severity. It may be reasonable, therefore, to consider fewer foundations in the most severe areas (i.e., span the problem), or take appropriate steps to assure the structural integrity of the foundation in those locations.
  - 2 The pile driving resistance which must be overcome at the time of construction may be greater than the ultimate pile capacity at a later date due to subsequent scour activity.
  - 3 Likewise, design drilled shaft capacity must account for the possibility that ultimate capacity will be reduced as a result of future scour activity.
- D The Drainage, Geotechnical and Structures Design Engineers shall develop the scour potential and rate at each location and furnish the results to the District Environmental Management Office (DEMO) Engineer for consideration in establishing the recommended alignment(s).
- E The preferred alignment is established by others.
- F The Structures Design Engineer develops more detailed calculations showing possible span arrangements and types and sizes of foundations.
- G The three Engineers review the proposed configuration to assure that scour has been properly addressed. (The Drainage Design Engineer reviews both the general and local scour potential and recommends continuation or changes).
- H The Structures Design Engineer finalizes his configuration and proceeds with an even more detailed analysis of the foundation including the anticipated pile tip elevations. All three Engineers shall review and concur. The final results are then incorporated into the BDR or 30% Plans Stage as applicable.

The eight (8) steps described above are shown as a flow diagram in **Figures 27-1 and 27-2**

### **27.4.2 Submittal Requirements for Scour Design**

During the 30% and 90% structures plans stage reviews, the EOR shall coordinate the reviews of the design of both the Drainage and Geotechnical Engineers to assure compliance with the results of the scour calculations. This review activity is shown diagrammatically in **Figure 27-2**. The Scour Calculations shall be processed as specified hereinafter.

### **27.5 Debris Accumulation**

Debris accumulation on the upstream side of substructure units can significantly affect the flow of water and cause significant scour. The designer shall evaluate the type of vegetation upstream from the bridge and consider the probability of debris accumulation in establishing types and locations of substructure units. Special consideration shall be given to mitigating debris accumulation on substructure units.

Debris clearance criteria are specified in the FDOT *Drainage Manual*, Chapter 4.

### **27.6 Widening**

The design for scour described above must be included in the widening of an existing bridge structure classified as a major widening as defined in the FDOT *Structures Design Guidelines*.

The requirement to include scour potential in the design of the widening of an existing structure classified as a minor widening will be considered by the Department on an individual basis.

Hydraulic design procedures are specified in the FDOT *Drainage Manual*, Chapter 4.

### **27.7 Scour Elevations**

The 100-year and 500-year scour elevations are required for the design of all bridges over watercourses. In addition, the Long-Term Scour Elevation shall be established for bridge structures required to meet the extreme event vessel collision load. For more information on these scour elevations see the FDOT *Drainage Manual*.

STRUCTURAL PLANS DEVELOPMENT FLOW CHART 1 OF 2

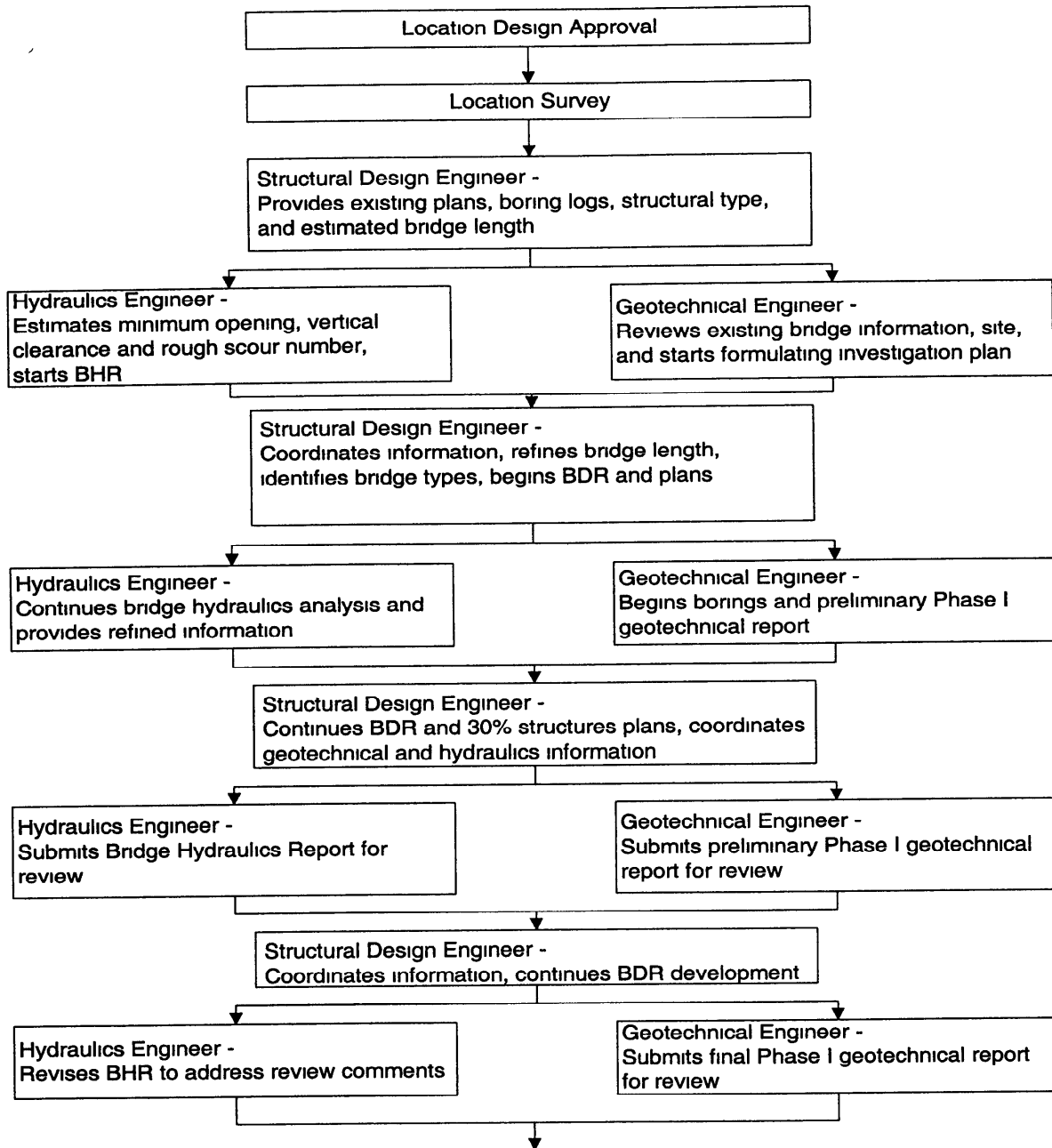

(Cont on Figure 27-2)

Figure 27.1

STRUCTURAL PLANS DEVELOPMENT FLOW CHART 2 OF 2

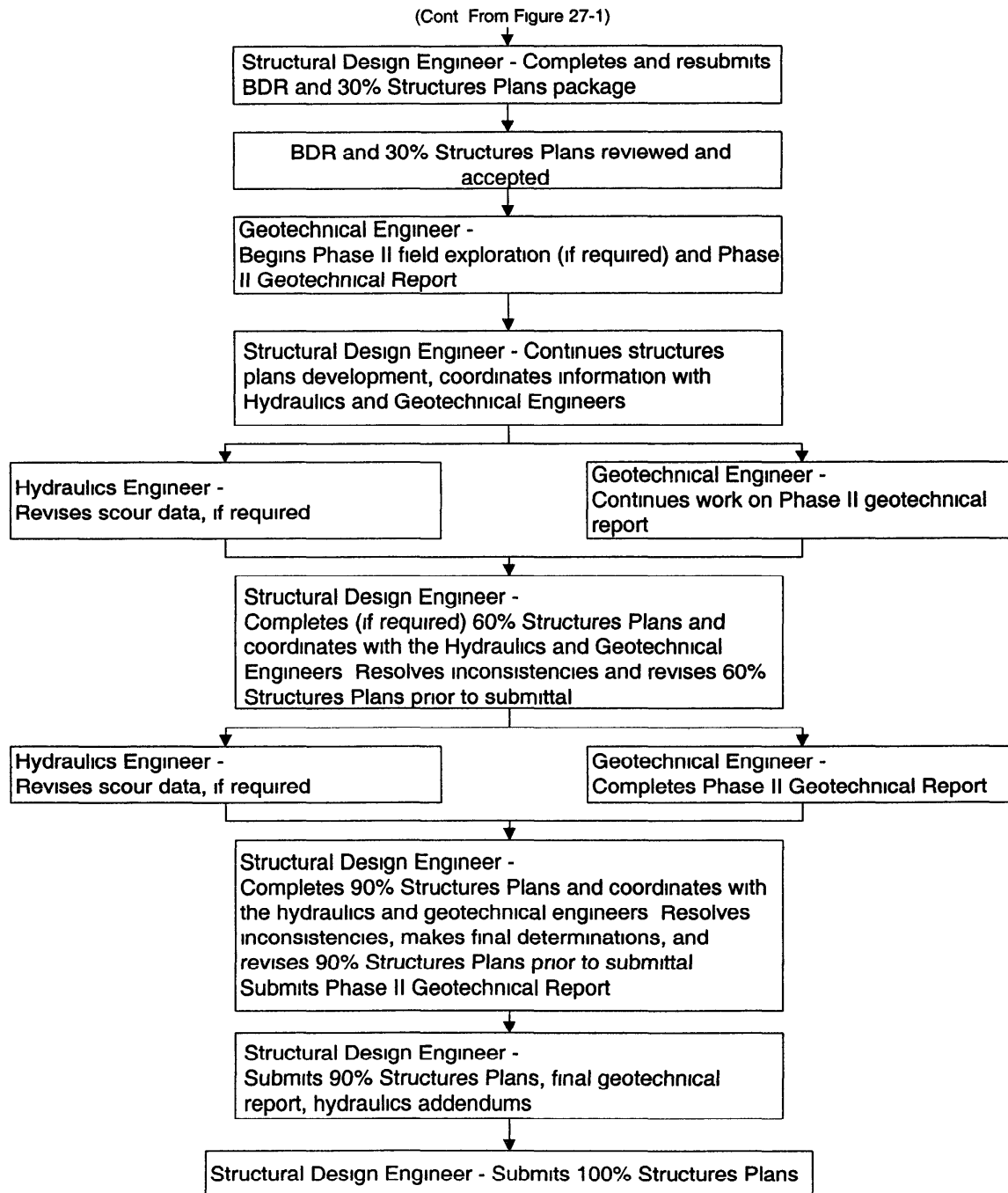

Figure 27.2



## Chapter 28

### SHOP AND ERECTION DRAWINGS

28.1	Introduction . . . . .	28-1
28.2	Drawing Submittals Required . . . . .	28-2
28.3	Contractor Information Required . . . . .	28-3
28.4	Submittals Requiring a Specialty Engineer . . . . .	28-4
28.5	Scheduling of Submittals . . . . .	28-5
28.6	Transmittal of Submittals . . . . .	28-6
28.6.1	General Submittal Requirements . . . . .	28-6
28.6.2	Requirements for Department EOR . . . . .	28-7
28.6.3	Requirements for Consultant EOR (Full Services) . . . . .	28-7
28.6.4	Requirements for Consultant EOR (Design Services Only) . . . . .	28-7
28.6.5	Requirements for Architectural or Building Structures . . . . .	28-7
28.6.6	Requirements for Roadway Submittal Items . . . . .	28-8
28.6.7	Requirements for Overhead Sign Structures . . . . .	28-8
28.6.8	Miscellaneous Requirements and Assistance . . . . .	28-8
28.7	Disposition of Submittals . . . . .	28-8
28.7.1	Minor Modifications . . . . .	28-10
28.7.2	Major Modifications . . . . .	28-10
28.8	Segmental Bridges - Shop Drawing Checklist . . . . .	28-12
28.8.1	Construction Methods and Sequence (Overall Scheme) . . . . .	28-12
28.8.2	Casting Curves and Geometry Control . . . . .	28-13
28.8.3	Post-Tensioning System and Computation . . . . .	28-13
28.8.4	Segment Shop Drawings . . . . .	28-15
28.8.5	Erection Equipment . . . . .	28-16

28.9	Distribution of Submittals . . . . .	28-16
28.10	Review of Prequalified Joint Welding Procedures . . . . .	28-17
28.11	Submittal Activity Record (Logbook) . . . . .	28-18
28.12	Archiving Record Shop Drawings . . . . .	28-18
Figure 28.1	Shop Drawing Flow Diagram . . . . .	28-20
Figure 28.2	Record Shop Drawing Transmittal . . . . .	28-21

## Chapter 28

# SHOP AND ERECTION DRAWINGS

### 28.1 Introduction

Shop Drawings include all drawings, diagrams, illustrations, schedules, catalog data, material certifications, fabrication procedures, storage and/or transportation procedures, test results, design calculations, etc , required by the Contract Plans and Specifications and submitted by the Contractor to define some portion of the project work While the Contract Plans and Specifications (including Supplemental and Special Provisions) define the overall nature of the project with many specific requirements, Shop Drawings provide a method for the Contractor to propose, under specification guides and for the Department to approve or reject, a particular material, product or system of accomplishing the work Each Contractor knows best what materials and equipment can be provided more expeditiously and economically and, if an item proposed meets the contract requirements, the submission of Shop Drawings is the accepted method of approving an element of the structure while allowing flexibility in the Contractor's choice of materials and construction techniques

It is mandatory, however, that Shop Drawings not be used to modify the construction contract time, the contract amount, the design intent nor in any way reduce the maintainability, structural integrity or load-carrying capacity of the structure or its components Such modifications can only be administered by revised plan sheets or specifications

Erection Drawings include all drawings, diagrams, design calculations, procedure manuals and other data required to depict in detail the proposed assembly and methods of installation of components into the project work The work of construction is the expertise of the Contractor, who should be allowed some latitude in the use of construction means, methods, techniques, sequences and procedures as are compatible with and will result in the project being completed in accordance with the requirements of the Contract Plans and Specifications Shop Drawings for items such as steel girders, precast/prestressed beams, miscellaneous steel, etc , usually include plan views and/or elevation views denoting the correct placement of a component in the structure Additional Erection Drawings are required for major structures for items such as special precasting, handling and erection equipment, or the erection of concrete segmental bridges The Engineer of Record must ensure that the Contract Plans and Special Provisions for the project clearly define all requirements for submittal of Erection Drawings

The following are definitions used herein

- **Engineer** As defined in *FDOT Standard Specifications for Road and Bridge Construction, Section 1*
- **Engineer of Record** As defined in the *FDOT Standard Specifications for Road and Bridge Construction, Section 1*
- **Specialty Engineer** As defined in the *FDOT Standard Specifications for Road and Bridge Construction, Section 1*
- **Consultant** As defined in the *FDOT Standard Specifications for Road and Bridge Construction, Section 1*
- **Resident Engineer** The Department's local area representative who reports directly to the District Construction Engineer and may be either a Departmental employee of the District or an employee of an engineering firm which is also serving as the Department's CEI (Construction Engineering and Inspection) Group. The Resident Engineer is the principal representative of the Department for a project at the District level. It shall be noted that neither the Resident Engineer nor the CEI Group is involved with the Shop/Erection Drawing review process but are recipients, only, of approved Shop/Erection Drawings
- **Architect of Record** As defined in the *FDOT Standard Specifications for Road and Bridge Construction, Section 1*
- **"Ballooning"** The contractor's use of minimum 1/16 inch wide lines to "balloon" or "cloud" (encircle) notes or details on drawings, design calculations, etc., in order to explicitly and prominently call out any deviations from the Contract Plans or Specifications. The Engineer of Record may also use "ballooning" to make note of any limitations to their submittal review and disposition of shop and erection drawings
- **Record Shop Drawings** The Department's official record copy of all Shop drawings, Erection Drawings, calculations, manuals, correspondence/ transmittal files and submittal activity record (logbook)
- **Review Office** The office or other Department entity responsible for performing the Department's review, record keeping, disposition and distribution of Shop and Erection Drawings

## 28.2 Drawing Submittals Required

Generally, Shop Drawings shall be required for items which require fabrication at a location other than the project job site

Unless otherwise noted in the Special Provisions for the project, Shop Drawings are not required for reinforcing steel for cast-in-place concrete which is completely detailed and listed on the Contract Plans or on the Department's Standard Index Drawings. A copy of reinforcing bar lists shall be forwarded by the Contractor to the Department's Resident Engineer for record purposes.

Components such as traffic signal equipment, steel or aluminum light poles, concrete strain poles and high mast lighting may not require submittal of Shop Drawings due to having prior certification by the Department. The Contractor may contact the Department's Resident Engineer or the appropriate Department Review Office for clarification of any item.

Material certifications are typically submitted by the Contractor directly to the State Materials Engineer in Gainesville.

Except as otherwise stipulated in the Specifications, precast and/or prestressed concrete items other than those constructed from standard drawings require the submission of Shop Drawings.

Shop Drawing submittals for structural steel shall include complete shop and field details including a bill of materials, all dimensions, bolt and hole sizes, camber diagrams, web cutting diagrams, weld symbols, surface preparation and shop paint. Welding procedures and welder qualifications shall be submitted in conjunction with the drawings.

In general, drawing submittals for any item shall follow industry standards in regard to the quantity and quality of information contained. As a minimum, the information shown on approved shop drawings should be complete enough to allow for fabrication of the item without referencing any other document. The Department shall expect submittals to meet or exceed the quality level of previously approved submittals of a similar nature.

During component fabrication and construction phases of the project, the Contractor may elect to submit to the Engineer, for consideration or approval, repair procedures or disposition requests due to errors or omissions in the work. The information required and the procedure to be followed by the Contractor in initiating such requests shall be in accordance with the FDOT Specifications or as determined by the Engineer.

### **28.3 Contractor Information Required**

All Shop Drawings and Erection Drawings shall contain the following minimum information: the complete Financial Project Identification, drawing number, drawing title, a title block showing the name of the fabricator or producer and the Contractor for which the work is being done, the initials of the person(s) responsible for the drawing, and the date on which the work was performed.

The drawing shall also contain, adjacent to the title block, information which describes the location of the item(s) within the project. This information may consist of the Contract Drawing number, the station at which the item is positioned (as may be the case for sign structures or handrails), or the Site at which it is to be installed.

Before submission of each drawing, the Contractor shall have determined and verified all quantities, dimensions, specified performance criteria, installation requirements, materials, catalog numbers and similar data with respect thereto, and shall have reviewed and coordinated each drawing with other Shop Drawings and with the requirements of the Contract Plans and Specifications. The Contractor shall have stamped and initialed each sheet giving specific written indication of compliance with the above described specific responsibilities with respect to review of the submission.

The Contractor's approval signifies that the submittal meets the requirements of the Contract Plans and Specifications and conforms to field dimensions or other potential deviations from the established project documents. Drawing submittals received without stamping by the Contractor shall be returned for resubmittal.

At the time of each submission, the Contractor shall have given specific written notice (as in the transmittal letter) of each variation the Shop/Erection Drawings may have from the requirements of the Contract Plans and Specifications. In addition, the drawings shall contain a specific notation which explicitly and prominently calls out any deviation. Approval of Shop/Erection Drawings will not constitute nor be considered grounds for approval of a variation in which the project requirements are affected unless specifically so noted in the Department's approval comments as returned with the drawing submittal.

## **28.4 Submittals Requiring a Specialty Engineer**

In general, and when so permitted in the Specifications, if a Shop/Erection Drawing submittal reflects any changes in the design and/or details of the Contract Plans, the Contractor shall have had a Specialty Engineer sign and seal one (1) print of each drawing affected as well as the cover sheet of one (1) copy of any design calculations required. The Contract Plans and Specifications (including Supplemental and Special Provisions) shall contain instructions regarding requirements of a Specialty Engineer for items such as concrete segmental bridge work, loads imposed on an existing structure, or certain construction procedures and/or equipment.

Submittals which introduce engineering input to the project, such as defining the configuration or structural capacity of prefabricated components or assemblies not contained in the Contract Plans, shall require the services of a Specialty Engineer. Drawings prepared solely as a guide for component fabrication/ installation and requiring no engineering input, such as reinforcing steel drawings and catalog information on standard products, do not require the use of a Specialty Engineer.

When required, the Specialty Engineer shall properly seal on one (1) record print of each drawing and the cover sheet of one (1) record copy of calculations or computer printouts. Computer printouts are an acceptable substitute for manual computations provided they are accompanied by sufficient documentation of design assumptions and identified input and output information to permit their proper evaluation. Such information shall bear the seal of the Specialty Engineer as verification that he has accepted responsibility for the results.

It is emphasized that a Specialty Engineer may not affix his seal to any item not prepared under his direct supervision and control.

When a submittal requires a Specialty Engineer, the sealed prints and calculations will be retained by the Department, as the official, record Shop Drawing. In this event only, when the Engineer of Record is a consultant to the Department, the consultant must print his own review copy and forward the reproducible prints and sealed prints and calculations to the Department upon completion of his review. See also Transmittal of Submittals hereinafter.

## **28.5 Scheduling of Submittals**

Review of the submittal requirements and procedures at the outset of the construction contract is of benefit both to the Contractor and the Department. Therefore, the Contractor may have been requested by the Department to provide a Working Schedule for Shop/Erection Drawing submittals.

The preparation of a Working Schedule will bring to the attention of the Contractor the number of submittals required and at times may denote items about which the Contractor may wish the Department's advice as to the manner in which the design is to be implemented. Adherence to the Working Schedule will make for a smoother working relationship between all parties involved in the project, and proper planning should reduce the possibility of a large number of submittals being forwarded for review concurrently.

The Contractor is generally required to schedule submissions such that a minimum of 45 calendar days is allowed for review by the Department for routine work of which the first 30 calendar days are allotted to prime review by the Engineer of Record. However, for most routine submittals, a time period of 14 to 21 calendar days should be adequate. For work of more complexity, the time for review by the Department may be adjusted proportionately to the complexity of the work. Allowance must also be made for potential resubmittals, and the Contractor normally is advised by the Department to consider a 75 to 90 calendar days total lead-time for submittals prior to the need for fabrication or construction work.

The Contractor must make submittals for approval with such promptness as to cause no

delay in his fabrication and construction schedules. Only in emergency cases should special consideration be requested. If a submittal requires resubmission, an approximate additional 30 calendar days should have been scheduled by the contractor for approval of the resubmittal of which the first 15 calendar days are allotted to prime review by the Engineer of Record.

## **28.6 Transmittal of Submittals**

Submittal of Shop/Erection Drawings shall be made to the Department or Consultant, as applicable, only by the Contractor for the project. In that the Department's legal contracts and documents are with the Contractor, submittals shall not be accepted directly from a subcontractor or fabricator. Situations may occur when a subcontractor or fabricator is allowed to make an advance submittal for review, however, the actual submittal to be stamped and approved must follow from the Contractor with the Contractor's stamp. Subcontractors and fabricators are encouraged to contact the appropriate Department Review Office for guidance or advice at any time. **Figure 28.1** shows the flow of submittals during the review process. All transmittals of submittals between parties shall be accomplished by OVERNIGHT DELIVERY.

The Special Provisions for the project may denote the amount of drawings, etc. to be submitted and the procedure to be followed. Furthermore, the office to which the Contractor shall transmit his submittal and the procedure to be followed may also be defined during the preconstruction conference for the project. In the absence of such instructions, the following shall apply.

### **28.6.1 General Submittal Requirements**

On projects where the Engineer of Record is a Consultant to the Department, and unless otherwise directed at the project's preconstruction conference, the Contractor shall have submitted one (1) set of mylar or xerographic reproductions and one (1) set of prints of all drawings directly to the consulting Engineer of Record. On projects where the Department is the Engineer of Record, the Contractor shall have submitted one (1) set of mylar or xerographic reproductions and one (1) set of prints directly to the appropriate Department Review Office. For design calculations, four (4) complete sets, including computer printouts, shall be submitted with the drawings. All drawings shall be on sheets not larger than 24 x 36. The Contractor's letter of transmittal should always accompany the drawings and a copy should always have been sent to the Department's Resident Engineer. On those projects where the Engineer of Record is a Consultant to the Department, a second copy of the Contractor's letter should also have been sent to the Department's Review Office.



### **28.6.2 Requirements for Department EOR**

On projects where the Engineer of Record is Department in-house staff, submittals shall have been transmitted to the appropriate FDOT Review Office as directed at the project's preconstruction conference. The Department's Review Office is the principal contact group and "clearing house" for all construction submittals and information desired by the Contractor regarding structural, mechanical or electrical items.

### **28.6.3 Requirements for Consultant EOR (Full Services)**

On projects where the Engineer of Record is a Consultant to the Department and has been retained by the Department to review construction items, submittals (unless otherwise noted below) shall have been transmitted by the Contractor directly to the Consultant. When one (1) set of mylar or xerographic reproductions and one (1) set of prints are received, the Consultant shall perform his review utilizing the prints, transfer his review comments to the reproduction sheets, indicate his disposition by stamping the reproduction sheets as described hereinafter, retain the prints for his files and, finally, transmit the reproduction sheets to the Department's Review Office for review and distribution. When submittals require a Specialty Engineer as described, the Consultant shall first make a copy of the reproduction prints for his review and files. The sealed prints and calculations, along with the reproduction prints, form the official, record Shop Drawing submittal and must be retained by the Department. Upon completion of his review, the Consultant shall transfer his comments to both the reproduction prints and the sealed prints, indicate his disposition on both and transmit both to the Department as described above.

### **28.6.4 Requirements for Consultant EOR (Design Services Only)**

On projects where the Engineer of Record is a Consultant to the Department but has not been retained by the Department to review construction items, submittals (unless otherwise noted below) shall have been transmitted by the Contractor directly to the Department's Review Office as directed at the project's preconstruction conference.

### **28.6.5 Requirements for Architectural or Building Structures**

Submittals related to Architectural or Building Structures, such as Rest Area Pavilions and Maintenance Warehouses, shall have been made according to the requirements of the Special Structures Group, Structures Design Office, Florida Department of Transportation, 605 Suwannee Street, MS 33, Tallahassee, FL 32399-0450, Phone (850) 414-4285.

### **28.6.6 Requirements for Roadway Submittal Items**

All submittals related to roadway plans such as lighting, attenuators, retained earth systems, etc (except bridge items such as poles and bracket arms, or as noted below) shall be distributed in accordance with the ***Construction Project Administration Manual (Topic No. 700-000-000)*** for the component involved or as otherwise directed at the project's preconstruction conference. Submittals related to bridge items shall have been transmitted to the Department as previously described in this section.

### **28.6.7 Requirements for Overhead Sign Structures**

Submittals concerning overhead sign structures shall have been transmitted in accordance with the General and Structures Requirements above.

### **28.6.8 Miscellaneous Requirements and Assistance**

For items not specified above or for which questions may arise as to submittal requirements, the Contractor should be advised to contact the appropriate Department Review Office. For submittals of any type, the Contractor shall always have transmitted a copy of the letter of transmittal to the Resident Engineer.

## **28.7 Disposition of Submittals**

The approval or disapproval of submittals by the Department shall be indicated by one of the following designations: "APPROVED" (no further action required), "APPROVED AS NOTED" (make corrections noted - no further submittal required), "RESUBMIT" (make corrections noted and resubmit for approval), or "NOT APPROVED" (rejected - do not resubmit the concept or component as submitted).

The disposition designation shall be indicated on each and every drawing sheet, or on the cover sheet of calculations, by the use of a red ink stamp. Stamps shall identify the approving groups, such as the Engineer of Record - Consultant, the Department's assigned commercial inspection agency and/or Department personnel, and the date, however, only the FDOT red ink stamp constitutes an authoritative response to a submittal. All notations or corrections made on the approval prints shall be consistently marked on all drawings.

All Consultants reviewing submittals shall stamp and initial each item as noted above with the firm's appropriate stamp. Consultants must declare any limitations to the extent of their review and approval by the terminology of their standard stamp and/or by additional written and "ballooned" notes on the submittal items. When the Engineer of Record is a Consultant and when he retains a Sub-Consultant to assist in the submittal review, the Engineer of Record shall signify disposition of the submittal as noted above with his firm's

appropriate stamp prior to transmitting it by overnight delivery to the Department. In this event it is the Engineer of Record's prerogative to also require a disposition stamp by his Sub-Consultant.

When a submittal contains deviations from the Contract Plans and Specifications, the Consultant and the Department shall determine as to whether or not a Supplemental Agreement or Value Engineering (VECP) proposal is required. If either procedure is required to be initiated, the submittal shall not be reviewed until a decision is finalized.

When the Engineer of Record receives a submittal that is not in accordance with the requirements of this chapter, the Contractor shall be advised to resubmit immediately with the corrections or additions necessary.

Review and approval by the Engineer of Record (Consultant and/or Department) shall be for conformance with the design concept of the project and for compliance with the information given in the Contract Plans and Specifications (including Supplemental and Special Provisions). The review and approval shall not extend to means, methods, techniques, sequences or procedures of construction (except where a specific means, method, technique, sequence or procedure of construction is indicated in or required by the Contract Plans and Specifications) or programs incident thereto. The review and approval of a separate item as such will not indicate approval of the assembly in which the item functions.

Disposition of Shop Drawing submittals by the Engineer of Record for construction and erection equipment including beams and winches, launch gantry, erection trusses, forms, falsework, midspan and/or longitudinal closures, lifting devices, temporary bearing fixity devices, cranes, form travelers, segment carrying equipment and stability devices shall be either "NOT APPROVED" if deemed to be unacceptable or, if acceptable, shall be "APPROVED AS NOTED" with the following note included on the submittal drawings:

"Drawings are acceptable for coordination with, relationship to, and effects upon the permanent bridge, but have not been reviewed for self-adequacy. Adequacy and intended function remain the sole responsibility of the Contractor."

Unless otherwise specifically designated in a Consultant's Scope of Services or required by the Department, the Engineer of Record is not responsible for accepting or reviewing calculations or drawings pertaining to construction formwork. These documents should normally have been submitted to the Resident Engineer or, in the event they are erroneously transmitted to the Engineer of Record, should be immediately re-routed to the Resident Engineer.

When the Engineer of Record is a Consultant to the Department and when the Department receives the Consultant's transmittal of a shop drawing submittal reviewed and stamped for disposition as noted above, the Department will perform a second, confirmation review.

of the submittal. The primary purposes of the Department's review include conformance with FDOT policy, standards, etc., uniformity of disposition with similar submittals, accuracy and completeness of the Consultant's review, and attention to specific details, areas of work, etc. that have experienced recurring problems during fabrication and/or construction.

When the Department concurs with the Consultant's review and disposition of the submittal, the Department will stamp and distribute the submittal including a record copy for the Consultant. Should the Department's review and/or disposition of the submittal differ from that of the Consultant, the final disposition of the submittal will be resolved in accordance with the following procedures:

### 28.7.1 Minor Modifications

The submittal will be processed when notations not involving design decisions are added, modified or deleted and when the disposition of the submittal remains unchanged or changed only in accordance with the following **Table 28.1**:

**Table 28.1 FDOT Changes to Minor Modifications**

From	To
Approved	Approved as Noted
Approved as Noted	Approved
Resubmit	Not Approved
Not Approved	Resubmit

In this event, the Department will notify the Consultant of the modifications, document the notification in the project's shop drawing file, process and distribute the submittal and furnish the Consultant with a record copy.

### 28.7.2 Major Modifications

The submittal will be returned to the Consultant for re-review when notations involving significant design decisions must be added, deleted or modified, when the submittal's review is deemed by the Department to be incomplete or require significantly more work or when the disposition of the submittal requires one of the following **Table 28.2**:

**Table 28.2 FDOT Changes to Major Modifications**

<b>From</b>	<b>To</b>
Approved or Approved as Noted	Not Approved or Resubmit
Not Approved or Resubmit	Approved or Approved as Noted

As above, the Department will notify the Consultant and document the notification. The submittal will be returned to the Consultant for re-review and return to the Department. When the Specialty Engineer is required by the Contract Plans and specifications to perform a portion of the design of the project, the Engineer of Record shall confirm that

- A The Specialty Engineer is qualified to design and prepare the submittal
- B The specified number of submittals have been furnished
- C A minimum of one (1) set of Shop Drawings and the cover sheet of one (1) set of calculations have been correctly sealed by the Specialty Engineer
- D The Specialty Engineer has understood the intent of the design and has used the correct specified criteria
- E The configuration set forth in the submittal is consistent with that of the Contract Documents
- F The Specialty Engineer's methods, assumptions and approach to the design are in keeping with accepted engineering practices
- G The Specialty Engineer's design does not contain any gross inadequacies that would jeopardize or threaten public safety

A detailed review of design calculations is not required, and a detailed review of dimensions (other than at interface areas with other work) is not required

When a submittal has been returned as "RESUBMIT", the Contractor shall have made corrections as required and shall have returned the required number of corrected copies for review. All revisions to a drawing, etc., shall have been noted with a symbol consisting of the revision number within a triangle located next to revised area. The Contractor must have directed specific attention in writing to revisions other than the corrections called for by the Department on previous submittals.

**Figure 28.1** shows the submittal and distributional flow of a shop drawing transmittal

## **28.8 Segmental Bridges - Shop Drawing Checklist**

The following list is for guidance only. There may be occasions when particular details and needs are more or less than this list.

### **28.8.1 Construction Methods and Sequence (Overall Scheme)**

This should be the first submittal as it lays out the Contractor's philosophy and overall approach to the project. It should cover:

- A Overall construction schedule (program) for the duration of the contract. Milestone dates should be clearly shown - for example, the need to open a structure by a certain time for traffic operations.
- B Overall construction sequence. The order in which each of the structures is to be built and the sequence in which individual spans or cantilevers are constructed.
- C The general location of any physical obstacles to construction that might impose restraints to the sequence and an outline of how the Contractor intends to avoid or handle such obstacles as he builds the structure. Obstacles might include road and rail clearances, temporary diversions, transmission lines, pipelines, local property rights, etc.
- D The general location of any temporary construction obstacles and how these are to be handled. Such might include excavation or cofferdams for an adjacent structure, piling rig or other plant clearances, temporary haul road clearances, etc.
- E The appropriate location of any temporary stability towers or other falsework.
- F The approximate location of any special lifting equipment in relation to the structure including clearances required for operation of that equipment, i.e., crane positions and operating radii.
- G The conceptual position of any special construction devices such as launching girders, support trusses, pier brackets, stability devices, beam, and winch type equipment, etc. (with outline details only at this time) of how the Contractor intends to attach such equipment to the structure. (The precise details of such attachments would be covered under later detailed submittals.)
- H Outline proposals for the lifting, handling and storage of segments. (Again, precise details and any extra reinforcement provisions, etc. would be covered under later detailed submittals.)
- I Any other information pertinent to the Contractor's scheme at this time.

The above information should be in as concise form as possible on one or two drawings.

The intent is to provide an overall integrated picture of the Contractor's intentions. As such, these drawings are for information only and it should be made quite clear that the delivery and receipt of such drawings does not constitute approval to the details implied therein. They are to be accepted for information only and not approved. However, the Contractor's subsequent detailed submittals should comply with the overall concepts.

### **28.8.2 Casting Curves and Geometry Control**

Casting curves contain the superstructure geometry and compensations for deflections arising as a result of the construction sequence, methods, temporary loads, temporary supports, creep and shrinkage, etc. Camber diagrams are only the deflection compensation portions of the casting curves. Casting curves and camber diagrams may be presented in numerically tabular or graphic forms. The format is not critical, but the information given should be clear and concise, leaving no room for doubt or misinterpretation. Examples and illustrations should be shown to help clarify the data presented. Casting curves and camber should be generated according to the Contractor's proposed methods, sequence, schedule and equipment of the overall scheme. Changes to his overall scheme might require recomputation and submittal of new casting curves and camber.

Geometry control is the process of making field observations and measurements in the casting cell and combining these with the theoretical casting curve data to produce the required structural shape, segment by segment. It involves accurate instrument work and geometry calculations using graphical or computerized methods.

It is normal practice for the geometry control system to be explained in a manual prepared by or on behalf of the Contractor.

### **28.8.3 Post-Tensioning System and Computation**

Contractors usually sublet this work to specialty suppliers. There are some differences of detail between suppliers but, by and large, these are not significant. Usually the differences are only in the shape and size of anchorage devices and jacks for a given tendon size and load.

The Post-Tensioning proposals should show and be checked for

- A Dimensions and details of anchorage devices
- B Jack sizes and required clearances
- C Special jack handling devices with all necessary inserts or fixtures
- D Proposals for threading of tendons (i.e., use of steel wire pulling socks, welded

- pulling eyes, etc )
- E Proposals for cutting off strand which has been affected by any heat from welding
  - F Proposals for cutting of surplus strand prior to and after stressing
  - G Information on the jacking equipment, pumps and dial gauges, etc
  - H The storage of materials and protection from corrosion
  - I Assumptions for the stressing operation, coefficient of friction, wobble factor, elastic modulus or stress - strain curve, anchorage draw-in (wedge set), etc
  - J. A summary of the jacking loads, tendon forces, and extensions, before and after seating the wedges
  - K A stressing sequence and schedule for groups of tendons
  - L Post-tensioning duct profiles and geometric layout used in the computations
  - M Proposed recording sheets
  - N Details, sequence, schedule, operations and stressing forces for any temporary post-tensioning
  - O Any special requirements for bursting rebar or extra rebar to restrain radial forces if the profiles are different from those shown in the contract plans
  - P Details for the means of securing the anchorage hardware in position until the concrete has been cast
  - Q Details for the splicing of ducts to ensure that a smooth profile is maintained and that any connections are grout-tight
  - R Details of any special bar or tendon couplers such as those to show adequate clearance for couplers when the tendon elongates with stressing, etc
  - S Details for post-tensioning duct supports with regard to strength and frequency to maintain a good profile during concreting
  - T Details of grout joints such as the locations at all high points and at sufficiently close spacing to ensure a good grouting operation
  - U Information on proposed grouting procedures such as grout mix including admixtures, grout pump and delivery system, sequence of grouting (work "uphill" in one direction along a tendon), back-up facilities, grouting pressures, etc

The post-tensioning supplier might not be responsible for all of the above information. Some of it, particularly that relating to rebar, hardware, ducts, vents, etc should be covered on the segment detail shop drawings. Also, the grouting operation (Item "U") might be by



a separate subcontractor. Nevertheless, the Contractor is responsible for coordinating all this activity and for making sure that all the information and details are integrated. It should be noted that Items "D" thru "H" are more for the benefit of field personnel than part of the shop drawing review.

#### **28.8.4 Segment Shop Drawings**

The main purpose of these drawings is to bring all the information together in a format from which the parts can be easily assembled. This involves the integration of diverse details from many areas. Typically the following should be checked:

- A Segment number and direction of erection
- B All dimensions including widths, lengths, thicknesses, tapers, fillets, radii, working points, post-tensioning duct locations and profiles, clearances, rebar spacings, blockouts, positions of embedded items, holes, grout, vents, anchorage positions and orientations
- C All reinforcement including bar sizes, shapes, locations, spacings, covers, clearances for the largest sized aggregate, clearances for cumulative tolerances on bending and fixing dimensions, avoidance of conflicts with post-tensioning ducts, anchorages and hardware including any special lifting or equipment connections. As a general rule, rebar should be adjusted to avoid post-tensioning and other important embeddings.
- D Clearances for post-tensioning jacks, including temporary post-tensioning bar jacks. Make sure there is enough room to thread a jack onto a post-tensioning tendon remembering that most center hole jacks require 3 to 5 feet of strand projecting out beyond the anchorage. Likewise with bar tendons, especially in blockouts, there has to be room for the jack to be placed over and threaded onto the extended section of bar beyond its anchorage.
- E Clearances for lifting devices. Check that there is room to place anchor plates and nuts on the bottom side of any bars connecting through the slabs to a lifting device, etc.
- F Anchorage and Buttress Detail - check that there is adequate rebar in these zones for any bursting and local radial forces. This should be covered on the design drawings but might have to be modified as a result of the Contractor's choice of post-tensioning system. The rebar should not cause congestion and there should be adequate spacing for concrete placement and compaction.
- G Casting of blockouts regarding material to be used, reinforcing to be extended from the segments, and time of casting in relation to erection stressing, etc.

### 28.8.5 Erection Equipment

These drawings should be reviewed for procedure and structural effect on the structure. The shop and erection drawings shall be prepared by the Contractor's Specialty Engineer and will be reviewed as described in **Sections 28.4** and **28.7** of this chapter.

### 28.9 Distribution of Submittals

If the initial review and approval of a submittal is performed by a Consultant to the Department, the Consultant shall retain one (1) set of materials for his files and transmit the reproducible set of prints (or other sets of calculations or multiple sets of prints) to the Department's Review Office.

Subsequent to the review and approval of a submittal by the Department, final distribution by overnight delivery is made in accordance with the following **Table 28.3**.

**Table 28.3 Shop Drawing Distribution Schedule**

DISTRIBUTION	FDOT - EOR	Consultant - EOR
FDOT Office File	1 Set Repros + 1 Set Calcs	1 Set Repros + 1 Set Calcs
Engineer of Record	N/A	1 Set Prints + 1 Set Calcs
FDOT Resident Engineer	2 Sets Prints	2 Sets Prints
Prime Contractor	3 Sets Prints + 1 Set Calcs	3 Sets Prints + 1 Set Calcs

When precast/prestressed concrete components are involved, the Department's District Prestress Engineer is furnished two (2) sets and the Department's Materials and Research Office (Gainesville) is furnished one (1) set of prints. When structural steel components are involved, the Department's Assigned Commercial Inspection Agency (ACIA) is furnished two (2) sets.

The Contractor shall be responsible for transmitting a copy of the returned submittal to the appropriate subcontractor or fabricator.

When approval of a submittal is denied ("RESUBMIT" or "NOT APPROVED"), distribution of the submittal shall be made to the Department Review Office's File and the Prime Contractor only, with a copy of the transmittal letter to the Department's Resident Engineer.

## 28.10 Review of Prequalified Joint Welding Procedures

The shop drawing review process of all prequalified joint welding procedures will be a dual role of responsibility between the Engineer of Record and the Department's Assigned Commercial Inspection Agency (ACIA). The FDOT has now consulted with an ACIA to perform the review of all welding procedures. It is the intent that all Engineers of Record understand their role in the review process, the role of the ACIA, and the correct transmittal process of the welding procedures.

Upon receiving a submittal consisting of prequalified joint welding procedures from the Contractor, the Engineer of Record shall immediately transmit a copy by overnight mail to the ACIA. The EOR shall then review the procedures in conjunction with the drawings to which they pertain. The review shall determine whether or not the Fabricator's welding procedures conform with the concept of the original design described within the contract plans. A comparison shall be made of the plate sizes, types of welds, weld designations, weld sizes, grades of materials, etc. as described and illustrated in the Fabricator's prequalified joint welding procedures to those described in the contract plans. Determining whether or not these elements parallel those of the design intentions are the interests and responsibility of the Engineer of Record during his review.

Upon the completion of his review, the Engineer of Record shall indicate his disposition of procedures in accordance with the procedures in this chapter and, if the procedures are acceptable, transmit them by overnight delivery directly to the appropriate FDOT Shop Drawing Review Office. If the stamp signifies the procedures as unacceptable, the Department will return them to the Contractor for resubmittal, and the same transmittal procedure will begin again.

When the Department is the Engineer of Record, approved procedures are transmitted to the ACIA for review and unacceptable procedures are returned to the Contractor for resubmittal.

Upon receiving a submittal of procedures from the Engineer of Record, the ACIA will perform a review of the proposed shop welding fabrication of the structural steel for general compliance with the **AASHTO/AWS Bridge Welding Code**. The ACIA's responsibility during their review will be to determine whether or not the Fabricator has provided the correct information needed to perform the weld called for on the procedures. Upon this determination, the ACIA will stamp the procedures accordingly and transmit them by overnight delivery to the appropriate FDOT Shop Drawing Review Office. If the ACIA determines the procedures to be unacceptable, the FDOT will transmit the submittal back to the Contractor by overnight delivery for resubmittal and the same transmittal procedures will begin again.

It is extremely important that the Engineer of Record complete his review of the procedures as quickly as possible and promptly transmit them by overnight delivery to the appropriate

FDOT Shop Drawing Review Office Similarly, the ACIA shall complete its review of the procedures as quickly as possible and promptly transmit them by overnight delivery to the FDOT

### **28.11 Submittal Activity Record (Logbook)**

The Department's Review Office is responsible for maintaining a Submittal Activity Record (Logbook) on each project reviewed by the office The logbook shall be updated each day that any Shop Drawing submittal activity occurs

The Logbook consists of a microcomputer database program developed and maintained by the Structures Design Office and furnished to each Departmental Review Office The following minimum data shall be entered in the Logbook for each submittal

- o Financial Project ID and State Project Number (if assigned)
- o Submittal Number
- o Description of Submittal
- o Number of Sheets in the Submittal
- o Number of Pages of Calculations, in Reports, in Manuals, etc
- o Date Transmitted by Contractor to the Engineer of Record
- o Date Transmitted by Engineer of Record (when EOR is not the Review Office) to the Review Office
- o Date Distributed by the Review Office to the Contractor
- o Date Transmitted by the Department's ACIA to the Review Office
- o Disposition as either "A" (Approved), "AN" (Approved as Noted), "R" (Resubmit) or "NA" (Not Approved)

The Logbook is an historical record of the activity devoted to an individual submittal as well as that for the project as a whole It can serve as a verification of review time, to respond to inquiries of a particular submittal's status and as a record of manpower effort to aid in estimating and allocating future workload

### **28.12 Archiving Record Shop Drawings**

Upon completion and acceptance of a construction project by the Department (usually by receipt of a written Notice of Acceptance), the Review Office, within thirty (30) days, shall transmit the Record Shop Drawings to the District Structures and Facilities Engineer (DSFE) in the District in which the project is located The Record Shop Drawings may

include some or all of the following documents

- o Shop Drawings
- o Erection Drawings
- o Calculations
- o Manuals
- o Project Files of Shop Drawing transmittal letters, etc
- o Submittal Activity Record (Logbook printout)

The Review Office shall complete the Record Shop Drawing Transmittal (see **Figure 28.2**), Form No 625-020-119-i, in triplicate, retaining one (1) copy and transmitting two (2) copies, along with the Record Shop Drawings described above, to the DSFE. The Record Shop Drawing Transmittal describes all the Record Shop Drawing documents transmitted to the DSFE.

The Submittal Activity Record (logbook) is intended to serve as the listing of all Shop and Erection Drawings transmitted. Other transmitted material such as project files, samples, etc. should be listed individually on the Transmittal (Form No 625-020-119-i) shown in **Figure 28.2**.

Upon receipt of the Record Shop Drawings, the DSFE shall verify the documents, material, etc. transmitted, sign and date both copies of the Record Shop Drawing Transmittal, retain one (1) copy for his files and return the second signed copy to the Review Office.

The Review Office shall maintain a file of Record Shop Drawing Transmittals (**Figure 28-2**) for future reference and use. Once the DSFE's signed copy is received, the Review Office's initially retained Record Shop Drawing Transmittal may be discarded.

It should be noted that for Shop Drawing submittals requiring a Specialty Engineer, the Record Shop Drawing submittal normally will consist of both reproducible prints and sealed prints.

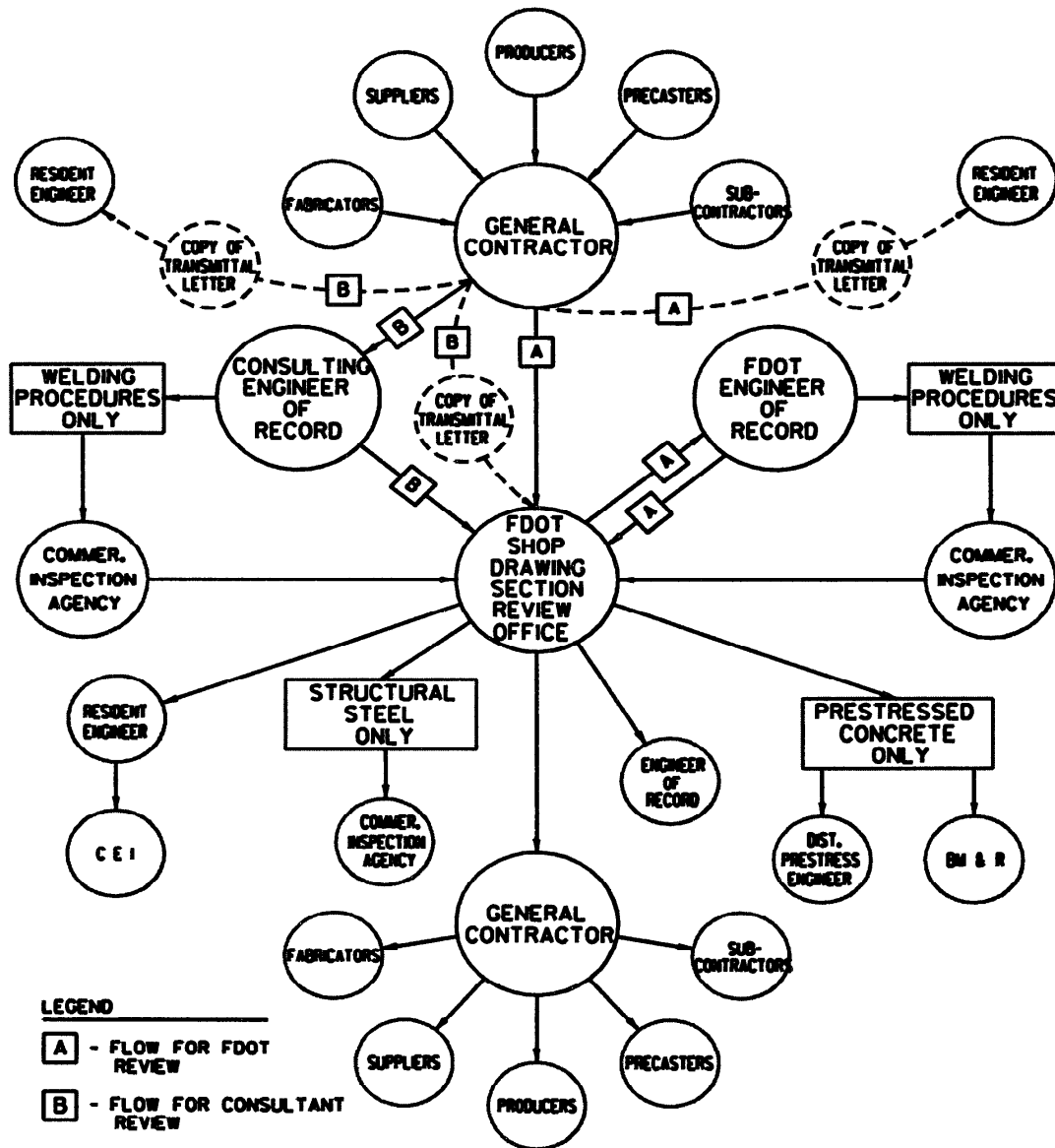

**SHOP DRAWING FLOW DIAGRAM  
 (STRUCTURAL ITEMS)**

Figure 28.1

Florida Department of Transportation  
**RECORD SHOP DRAWING TRANSMITTAL**

Date \_\_\_\_\_

TO District \_\_\_\_\_ Structures and Facilities Engineer

FROM \_\_\_\_\_  
(Review Office)

PROJECT NAME \_\_\_\_\_

FINANCIAL PROJECT ID \_\_\_\_\_

STATE PROJECT NO \_\_\_\_\_

WPI NUMBER \_\_\_\_\_

FAP NUMBER \_\_\_\_\_

BRIDGE NUMBER \_\_\_\_\_

CONTRACTOR \_\_\_\_\_

ENGINEER OF RECORD \_\_\_\_\_

We are transmitting herewith the following Record Shop Drawings for archiving

1 Shop and Erection Drawing Submittals per attached Logbook

2 Submittal Activities Record (Logbook)

3 \_\_\_\_\_

4 \_\_\_\_\_

5 \_\_\_\_\_

6 \_\_\_\_\_

For the Review Office \_\_\_\_\_

(Signature)

(Date)

For the District Structures and Facilities Engineer

\_\_\_\_\_

(Signature)

(Date)

**Figure 28.2**

## Chapter 29

### MISCELLANEOUS STRUCTURES

29.1	Design of Overhead Sign Structures and Foundations . . . . .	29-1
29.1.1	Overhead Signs in Urban Locations . . . . .	29-1
29.1.2	Overhead Signs in Rural Locations . . . . .	29-2
29.1.3	Overhead Signs on Bridge Structures . . . . .	29-2
29.2	Design of High Mast Light Poles and Foundations . . . . .	29-2
29.3	Design of Traffic Mast Arms and Foundations . . . . .	29-3
29.3.1	Mast Arms Designs . . . . .	29-3
29.3.2	Foundation Design Responsibility . . . . .	29-3
29.4	Structural Design of Roadway Light Poles . . . . .	29-3
29.5	Design of Strain Poles and Span Wire Assembly . . . . .	29-4
29.6	Design of Sound Barrier Walls . . . . .	29-4
29.6.1	Geotechnical Investigation . . . . .	29-5
29.6.2	Preparation of Control Drawings . . . . .	29-5
29.6.3	Detail Drawings . . . . .	29-5
Figure 29.1	. . . . .	29-7
Figure 29.2	. . . . .	29-7
Table 29.1	Design Wind Speeds (mph) . . . . .	29-8
Table 29.2	Design Wind Speeds for Mast Arms . . . . .	29-9



## Chapter 29

### MISCELLANEOUS STRUCTURES

#### 29.1 Design of Overhead Sign Structures and Foundations

Unless otherwise directed by the Department, the design of all overhead sign structures whether ground mounted or supported on a structure (including bridge structures), shall be the responsibility of the Structures Design Engineer of Record (EOR). This responsibility is for the entire sign structure, including the supports and foundations, as well as all details necessary to fabricate and erect the sign structures. The EOR is also responsible for the shop drawing review in accordance with **Chapter 28** when sign structure shop drawings are required by the Contract Documents.

In general, the design criteria for the structural design of overhead sign structures and foundations shall be based upon this manual and on the latest edition of **AASHTO's "Standard Specifications for Structural Supports for Highway Signs, Luminaires and Traffic Signals."** However, the wind loads shall be based on the wind speeds shown on **Table 29.1** (50 year recurrence).

The designer may refer to applicable drawings (**Indices 2001 thru 2004 and 2011 thru 2014**) of the **Structures Standard Drawings**.

##### 29.1.1 Overhead Signs in Urban Locations

Span type overhead sign structures in urban locations shall be designed either for the actual signs shown on the signing plans or for a minimum sign area of 120 sq ft (12 ft W x 10 ft H) per lane, whichever is the greater. If the signing plans require signs for only one traffic direction, the minimum sign area per lane requirement applies to the traffic lanes in this direction only.

Cantilever type overhead sign structures shall be designed either for the actual signs shown on the signing plans or for a minimum sign 8 ft wide by 10 ft high located at the end of the cantilever, whichever provides the more stringent load or stress at the location under consideration.

**Figures 29.1 and 29.2** show how to apply the above minimum sign areas for span type overhead sign structures in urban locations.

For additional design information, refer to **Chapter 7**.

### **29.1.2 Overhead Signs in Rural Locations**

Overhead signs in rural locations should be designed for the actual sign shown on the signing plans

### **29.1.3 Overhead Signs on Bridge Structures**

The design of the attachment system for signs mounted on bridge structures shall be the responsibility of the Structures Engineer of Record. The design shall be included in the structures plans if bridge work is included in the project. If bridge work is not included in the project, design details shall be included in the signing plans.

## **29.2 Design of High Mast Light Poles and Foundations**

In general, the design criteria for the structural design of high mast light poles and foundations shall be based upon this manual and on the latest edition of **AASHTO's "Standard Specifications for Structural Supports for Highway Signs, Luminaires and Traffic Signals"**, however, the wind loads shall be based on the wind speeds shown on **Table 29.1** (50 year recurrence)

The EOR is responsible for the design and drawings of the foundations for high mast light poles and shall include the pole reactions in the drawings for the contract documents.

The Contractor is responsible for the design of the high mast light poles and will submit the design and details as shop drawings.

The design of the foundations shall consider the following:

- Except for unusual circumstances, foundations shall be drilled shafts, 4 ft in diameter.
- The drilled shafts shall be designed in accordance with COM624 (see the **Structures Design Guidelines**) or by using Brom's procedure and hand calculations. Both of these methods consider lateral loading of the shafts which is the primary concern.
- A minimum safety factor of 1.5 against overturning shall be provided.
- Wind loading for the shafts shall be based on the wind speeds shown on **Table 29.1** (50 year recurrence).

For additional design information, refer to **Chapter 7**.

## 29.3 Design of Traffic Mast Arms and Foundations

In general, the design criteria for the structural design of traffic mast arm structures and foundations shall be in accordance with the latest edition of the ***AASHTO Standard Specifications for Structural Supports for Highway Signs, Luminaires, and Traffic Signals*** as modified by this manual. All mast arm structures shall be designed for the wind speeds shown in **Table 29.2** and the following criteria for foundations:

The torsional resistance of foundations for mast arm structures shall be designed for a service wind speed of 70 mph with a safety factor of 1.0.

For additional design information, see **Chapter 7** of this manual.

The design of, and details for, traffic mast arms shall be included in all plans prepared for the FDOT. The EOR should be aware of the following requirements:

### 29.3.1 Mast Arm Designs

The design for all mast arms shall be included in the plans. The designer may refer to applicable drawings (**Indices 2021 thru 2026 and 2031 thru 2035**) of the ***Structures Standard Drawings***.

### 29.3.2 Foundation Design Responsibility

Responsibility for the design of traffic mast arms described above also includes the design of the foundations.

## 29.4 Structural Design of Roadway Light Poles

Unless otherwise specifically designated in the contract documents, the contractor's specialty engineer is responsible for the structural design of roadway light poles and the EOR is responsible for the review of the shop drawings.

In general, the design criteria for the structural design of the light poles and foundations shall be based upon this manual and on the latest edition of ***AASHTO's "Standard Specifications for Structural Supports for Highway Signs, Luminaires and Traffic Signals"***, however, the wind loads shall be based on the wind speeds shown on **Table 29.1** (25 year recurrence for poles up to 50 ft. in height, and 50 year recurrence for poles exceeding 50 ft. in height). The height of the pole for wind zone determination is the distance between the top of pole elevation and either the ground elevation at the base of the pole or the original ground elevation prior to fill embankment construction, whichever is greater. For additional design information, refer to **Chapter 7**.

## 29.5 Design of Strain Poles and Span Wire Assembly

In general, the design criteria for the structural design of these structures and foundations, including attached traffic signals and signs, shall be based upon the this manual and on the latest edition of **"Standard Specifications for Structural Supports for Highway Signs, Luminaires and Traffic Signals"**, however, the wind loads shall be based on the wind velocities shown on **Table 29.1** (25 year recurrence)

For additional design information, refer to **Chapter 7**

## 29.6 Design of Sound Barrier Walls

Except as specified below, **AASHTO's "Guide Specifications for Structural Design of Sound Barriers"** and **FDOT's Structures Design Guidelines** shall be used for the structural design, however, the designer shall also refer to the Department Specifications, Section 534 and the Structures Design Office's **"Sound Barrier Criteria"** for specifications and general design requirements, the **Structures Standard Drawings** (Indices 830 thru 837 and other applicable Indices) for guidance in the preparation of the drawings and the **Structures Detailing Manual** for conformance in detailing

All sound barrier walls in the State of Florida shall be designed for a minimum wind velocity of 110 mph. If the sound barriers are not located on other structures, the wind pressures shown in **Table 1-2.1.2.C (Exposure B2)** of the referenced **AASHTO** guide specifications shall be used. If the sound barriers are located on bridge structures, retaining walls, or traffic barriers, the wind pressures shown in **Table 1-2.1.2.D (Exposure C)** of the referenced **AASHTO** guide specifications shall be used. If the sound barrier is located on an embankment, the height zone shall be determined by using the elevation of adjoining ground as being the approximate elevation of the original ground surface prior to embankment construction.

The design of the foundation and posts between panels shall take into consideration the different wind pressures of the applicable height zones. Therefore, a sound barrier wall with the centroid of the loaded area 29 ft above adjacent ground (in the 14 ft thru 29 ft height zone), shall have posts and foundations designed for wind pressures of 37 psf up to a vertical distance above the ground of 28 ft and 47 psf above this elevation.

Besides the structural integrity of the sound barrier wall, the structural engineer should also be concerned with aesthetics, maintainability, constructability, and of course, cost and durability.

Noise walls should not be located on bridge structures where feasible alternative locations exist. Noise walls on bridge structures cause an unproportionate increase in bridge cost because of strengthening of the deck overhang and exterior girder. In addition, noise walls on bridges interfere with normal maintenance inspection access and detract from the aesthetic quality of the structure. Where feasible alternative locations do not exist and sound barrier walls must be located on bridges, they shall not be taller than 8 ft nor located

on top of traffic barriers unless specifically approved in writing by the State Structures Design Engineer or District Structures Design Engineer as appropriate

Normally, the design should proceed as required hereinafter

### **29.6.1 Geotechnical Investigation**

Once the wall location, alignments, height and minimum thickness are determined, the soil exploration should be undertaken. The geotechnical engineer should follow the **FDOT's Soils and Foundations Manual (Topic No. 675-020-012-C)** for the exploration

### **29.6.2 Preparation of Control Drawings**

The initial set of drawings to be prepared by the EOR are referred to as Control Drawings. By preparation of these drawings, the EOR shall provide all control parameters, such as, alignments, limits, notes, etc., and shall provide all the information which is common to all wall types including but not necessarily limited to

- A Wall alignments (horizontal and vertical)
- B Wall limits (beginning and ending)
- C Location of all existing utilities (overhead and/or underground in the vicinity of the proposed wall)
- D Location of fire-access holes
- E Location of drainage holes
- F Sound barrier graphics details
- G General Notes
- H "Report of Core Borings" (Soil Information Data)
- I Quantities (wall area as described below for payment purposes only, the itemized quantities such as concrete volume, etc., shall be provided in the specific drawings)
- J All other information that may be construed to be of general nature

NOTE The wall area for bidding purposes shall be the area bounded by the wall limits (beginning and ending), the top of the wall, and the bottom of the lowest panel between posts. This is the vertical surface area that can be seen on an elevation view plus the portion of the lowest panel which is buried

### **29.6.3 Detail Drawings**

The EOR shall prepare Detail Drawings showing the specific details required for the implementation of the selected wall type. All wall components such as foundations, posts, panels, etc. shall be fully detailed for construction. If standard or conventional (non-

proprietary) designs are to be implemented, then these drawings shall provide the specific information as shown in the applicable drawings (***Indexes 830 thru 837 of the Structures Standard Drawings***)

Likewise, if proprietary designs are to be implemented, then the proprietary sound barrier wall drawings shall provide the specific information. Proprietary designs shall be submitted for approval after which they will be included on the FDOT's Qualified Products List (QPL)

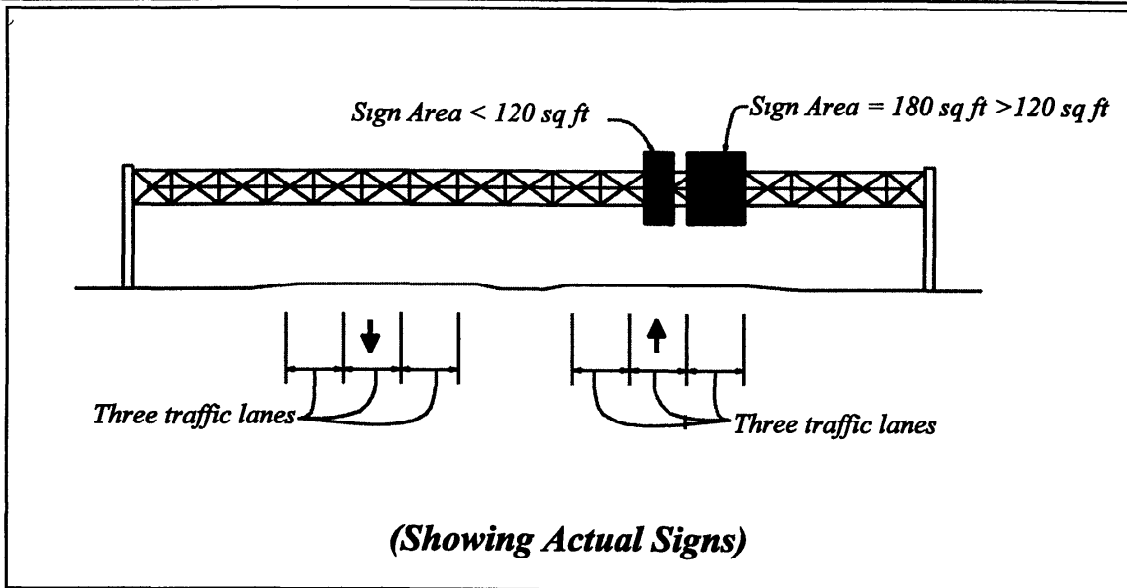

Figure 29.1

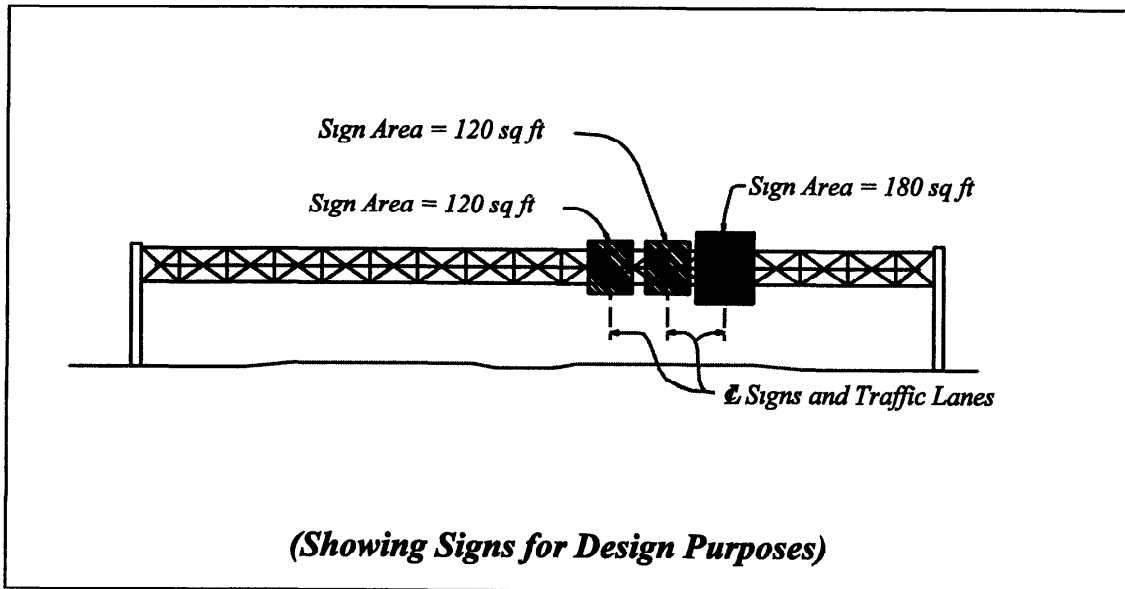

Figure 29.2

**Table 29.1 Design Wind Speeds (mph)**

County (Dist)	25-year Recurrence	50-year Recurrence	County (Dist)	25-year Recurrence	50-year Recurrence
Alachua (2)	80	90	Lake (5)	80	90
Baker (2)	80	90	Lee (1)	90	100
Bay (3)	80	90	Leon (3)	70	80
Bradford (2)	80	90	Levy (2)	80	90
Brevard (5)	90	100	Liberty (3)	80	90
Broward (4)	100	110	Madison (2)	70	80
Calhoun (3)	80	90	Manatee (1)	90	100
Charlotte (1)	90	100	Marion (5)	80	90
Citrus (7)	80	90	Martin (4)	90	100
Clay (2)	80	90	Monroe (6)	100	110
Collier (1)	90	100	Nassau (2)	80	90
Columbia (2)	70	80	Okaloosa (3)	90	100
Dade (6)	100	110	Okeechobee (1)	80	90
De Soto (1)	80	90	Orange (5)	80	90
Dixie (2)	80	90	Osceola (5)	80	90
Duval (2)	80	90	Palm Beach (4)	100	110
Escambia (3)	90	100	Pasco (7)	90	100
Flagler (5)	80	90	Pinellas (7)	90	100
Franklin (3)	90	100	Polk (1)	80	90
Gadsden (3)	70	80	Putnam (2)	80	90
Gilchrist (2)	80	90	St Johns (2)	80	90
Glades (1)	80	90	St Lucie (4)	90	100
Gulf (3)	90	100	Santa Rosa (3)	90	100
Hamilton (2)	70	80	Sarasota (1)	90	100
Hardee (1)	80	90	Seminole (5)	80	90
Hendry (1)	80	90	Sumter (5)	80	90
Hernando (7)	90	100	Suwannee (2)	70	80
Highlands (1)	80	90	Taylor (2)	80	90
Hillsborough (7)	80	90	Union (2)	80	90
Holmes (3)	70	80	Volusia (5)	90	100
Indian River (4)	90	100	Wakulla (3)	80	90
Jackson (3)	70	80	Walton (3)	80	90
Jefferson (3)	70	80	Washington (3)	80	90
Lafayette (2)	80	90			



**Table 29.2 Design Wind Speeds for Mast Arms**

110 mph Counties	90 mph Counties
Escambia	Holmes
Santa Rosa	Jackson
Okaloosa	Gadsden
Bay	Leon
Gulf	Jefferson
Franklin	Madison
Wakulla	Hamilton
Taylor	Columbia
Dixie	Suwannee
Citrus	Washington
Hernando	Calhoun
Pasco	Liberty
Pinellas	Lafayette
Manatee	Gilchrist
Hillsborough	Marion
Sarasota	Alachua
Charlotte	Union
Lee	Putnam
Collier	Clay
Monroe	Seminole
Dade	Orange
Broward	Lake
Palm Beach	Sumter
Martin	Polk
St. Lucie	Osceola
Indian River	DeSoto
Brevard	Highlands
Volusia	Okeechobee
Flagler	Glades
St. Johns	Hendry
Duval	Bradford
Nassau	Baker
Walton	Hardee

## Chapter 30

### RETAINING WALLS

30.1 Purpose . . . . .	30-1
30.2 Conventional (CIP) Retaining Walls and Proprietary Retaining Walls (Permanent Walls) . . . . .	30-2
30.2.1 Retaining Walls (Conventional Design) . . . . .	30-3
30.2.2 Retaining Walls (Proprietary Design) (Design Required in Contract Plans) . . . . .	30-4
30.2.3 Retaining Walls (Proprietary Design) (Design not Required in Contract Plans-Control Plans only) . . . . .	30-6
30.2.4 Wall System Selection . . . . .	30-7
30.3 Critical Temporary Walls . . . . .	30-7
30.4 Experimental Wall Projects . . . . .	30-8
30.5 Shop Drawing Review . . . . .	30-8
30.6 Bidding Procedure . . . . .	30-9
Exhibit 30-1 . . . . .	30-10
Exhibit 30-2 . . . . .	30-12
Figure 30.1 . . . . .	30-14
Exhibit 30-3 . . . . .	30-15

## Chapter 30

# RETAINING WALLS

### 30.1 Purpose

The purpose of this chapter is to give the designer an understanding of the procedure to develop retaining wall plans. A step-by-step method to develop and organize the retaining wall plans is presented. An example of retaining wall plans is included. This chapter should be used in conjunction with of the ***Structures Design Guidelines***

Prior to 1977 the types of retaining walls constructed for Florida Department of Transportation (FDOT) projects were somewhat limited. Reinforced cast-in-place concrete and steel sheet piles were the walls of choice and to a lesser extent concrete sheet piles were used primarily as bulkheads.

The advent of Mechanically Stabilized Earth (MSE) walls brought many changes to the way FDOT designed and let the retaining wall contracts. After 1977 FDOT began almost exclusively utilizing MSE proprietary retaining walls due to their economic advantage and their ability to articulate and thus withstand a degree of settlement.

If the difference in height between the ground levels to be supported is 5 ft or less, a gravity retaining wall is generally the most efficient structure to be used. For details of gravity retaining walls see the ***Roadway and Traffic Design Standards, Index No. 520***

When the difference in height between the ground levels to be supported exceeds 5 ft, then either a reinforced cast-in-place (CIP) concrete cantilever retaining wall or a proprietary retaining wall is required.

Roadside barriers are generally required to shield vertical dropoffs created by retaining walls in fill sections. See **Chapter 4** for guidance on roadside barrier requirements.

Handrails or fences for bicyclists and pedestrians are also generally required when retaining walls are located within the right of way. This requirement must be addressed for retaining walls in fill sections as well as at the top of retaining walls in cut sections. In cut sections, the character and use of the adjoining property shall be considered when selecting the type of protection required. See **Chapter 8** for pedestrian and bicycle rail requirements.

In general, proprietary retaining walls should be utilized for projects when the exposed surface area of the walls exceed 1000 square ft and sufficient room for the earth reinforcement system is available, however, site specific conditions must always be considered when determining the type(s) of wall to be designed. Proprietary precast walls other than MSE walls should be used as an alternate to CIP walls when sufficient room for soil reinforcement is not available.

The following sections refer to the structures submittal procedure. For projects where there are no bridges, the roadway designer shall adjust the procedure as required for the roadway project.

### **30.2 Conventional (CIP) Retaining Walls and Proprietary Retaining Walls (Permanent Walls)**

The Department's policy is to provide either a set of conventional retaining wall plans or the "preapproved standard details" for all the proprietary walls that are technically appropriate for the site for all projects where walls are not supported on piles. Projects where walls are supported on piles only require a conventional pile supported wall design or a pile supported proprietary wall design. Omission of conventional retaining walls is possible if adequate justification is provided.

Proprietary retaining wall design plans are not required in the contract plans for normal uncomplicated wall projects. If the proprietary walls are experimental, exceed 40 ft in height, are subject to unusual geometric or topographic features or, by the geotechnical report, will be subjected to excessive settlement, or environmental conditions, they may be required to have fully detailed design plans in the contract set.

The success of this method of producing and letting wall plans is highly dependent on complete, accurate and informative Control Plans. The importance of the Geotechnical Engineer's role in this scheme cannot be emphasized enough and shall include the following responsibilities:

- o Borings
- o Soils Report
- o Wall Type recommendation
- o For MSE Walls: external stability analysis, minimum soil reinforcement length-vs-wall height for external stability, maximum bearing pressure for each wall height and soil reinforcement length for each different wall height (1.5 ft increments)
- o Review of internal stability design as provided by the wall companies

- o Establishment of allowable bearing pressures

The normal failure modes to be investigated are shown in **Figure 30.1**

Step-by-step procedures for developing retaining wall plans follow

### **30.2.1 Retaining Walls (Conventional Design)**

#### **A Bridge Development Report (BDR)/30% Plans**

The BDR shall discuss and justify the use/non-use of conventional retaining walls. If the use of conventional retaining walls is applicable to the site and economically justified, it may be the only design required or it may be an alternate to a proprietary design. The 30% Plans submittal shall contain a location plan, plan and elevation of walls showing vertical and horizontal alignment, cross sections and details. The plans shall denote location of drainage inlets, utilities, sign structures, lights and barrier joints. Specifically the submittal package shall include

##### **1 Plan**

A plan view of the wall and footings which indicate pertinent dimensions, boring locations and horizontal alignment

##### **2 Elevation**

A front view of the wall which indicates pertinent dimensions and elevations, sign and lighting structures locations, drainage structure locations and flow line elevations, location of section views and vertical alignment

##### **3 Sections**

Sections taken through the wall to better indicate dimensions and elevations

##### **4 General Notes including**

- a Design Toe Pressure
- b Environmental Classification
- c Concrete - (Strength and Class)
- d Reinforcing Steel - (Grade)
- e Design Method
- f Soil Design Parameters for both the in-situ and backfill materials
- g Load and Resistance Factors

#### **B 30% Plans**

The 30% Plans shall be submitted for approval and development of the plans continued towards the 90% Plans submittal

C 90% Plans

The 90% Plans submittal shall be further developed to include, in addition to the information required for the 30% Plans , the following

1 Plan

A plan view of the wall and footings which indicates pertinent dimensions, reinforcing steel locations, cover and spacing in footings, and boring locations, back of wall drainage details and horizontal alignment

2 Elevation

A front view of the wall which indicates pertinent dimensions and elevations, location of section views, reinforcing steel location, cover and spacing, back of wall drainage and flow lines, vertical alignment, and locations of construction and expansion joints

3 Sections

Sections taken through the wall to better indicate dimensions, reinforcing steel locations, concrete cover for rebars and elevations

4 Estimated Quantities

Estimated quantities for items incorporated in the wall, reinforcing bar list and standard bar bending sheet

The Structures Design Office has prepared standard drawings of conventional cantilever retaining walls ranging from 2000 psf to 6000 psf design toe pressure and in height from 6 ft to 30 ft (See **Standard Drawings, Index 800 thru 822**) These Structures Standards may be obtained from the Florida Department of Transportation, **Maps and Publications Sales**, 605 Suwannee Street, MS 12, Tallahassee, Florida 32399-0450

### 30.2.2 Retaining Walls (Proprietary Design) (Design Required in Contract Plans)

The following procedure for plans preparation should be followed if the walls are required to be fully detailed in the contract plans

A BDR/30% Plans

The BDR shall discuss and justify the use of proprietary retaining walls The

30% Plans shall contain preliminary Control Plans. It will not be necessary for these Plans to contain pay items and standard drawings, however, they shall include, but not be limited to, the following information:

1 Key Sheet

2 General Notes Sheet

- a General notes
- b In-situ soil characteristics
- c Design parameters - safety factors
- d Applicable wall systems

3 Plan and Elevation Sheet

- a Horizontal and vertical alignment
- b Limits of wall
- c Utility locations
- d Plan view of wall
- e Elevation view of wall (showing existing and proposed ground lines, elevations at 30 ft intervals at top of wall, wall embedment (maximum elevation at top of leveling pad) and beginning and end of wall stations)
- f Boring locations
- g Quantity (pay area of walls)
- h Table showing soil reinforcement length vs wall height (for external stability)
- i Design parameters - Load and Resistance Factors
- j Sections thru wall showing offset control point, pay area, ditches, sidewalks, superelevation and other unusual features
- k Ranges of wall systems applicable to the portion of the project defined by the plan and elevation sheet

4 Soil Profile Sheet

5 General Details showing

- a Wall/end bent cap interface
- b Barrier and coping to wall interface
- c Pile, inlets and pipe conflicts with soil reinforcement and slip joint details

6 Preapproved Standard Drawings

Standard drawings of each of the alternate companies are included in the ***Roadway and Traffic Design Standards*** (Available as Interim Index)

Drawings)

**B Control Plans/Invitation Package**

The Control Plans shall be reviewed by the Department and, upon approval, sent to all the appropriate preapproved (on Qualified Products List, QPL) proprietary wall companies. The companies shall be provided with a set of control plans, roadway plans and foundation report. The Control Plans shall be sent to the wall companies as soon as they are approved. This action shall be accomplished as soon as possible but not later than the 60% Plans. A copy of the transmittals to the wall companies shall be sent to the DSDO or SDO as appropriate. The proprietary companies shall acknowledge receipt of the invitation package. If they choose to participate they shall provide design plans for the retaining walls and submit the plans for review as prescribed in the invitation letter (see **Exhibit 30-1**).

**C 90% Plans**

Upon receipt of the proprietary design plans, the designer shall review the design and incorporate the wall plans into the contract set. The plans from the wall companies, control plans and wall company standard drawings shall constitute the 100% Plans.

**30.2.3 Retaining Walls (Proprietary Design) (Design not Required in Contract Plans-Control Plans only)**

Use the following procedure in preparing plans for normal, uncomplicated wall projects

**A BDR/30% Plans**

The BDR shall discuss and justify the use of proprietary retaining walls. The 30% Plans shall contain Preliminary Control Plans which shall include, but not be limited to the information previously shown in this Section.

**B Control Plans**

The Control Plans shall be developed by the Engineer of Record and, upon approval, sent to all the appropriate preapproved (on QPL) proprietary wall companies. The Control Plans shall be sent to the wall companies as soon as they are approved. This action shall be accomplished as soon as



possible but not later than the 60% Plans. A copy of the transmittals to the wall companies shall be sent to the DSDO or SDO as appropriate. The proprietary wall companies shall acknowledge receipt of the control plans package as prescribed in the transmittal letter (See **Exhibit 30-2**)

C 90% Plans

The Control Plans shall be incorporated into the 90% Plans submittal  
NOTE The preapproved proprietary wall standard drawings are included in the **Roadway and Traffic Design Standards** (Available as Interim Index Drawings)

The design details shall be submitted in the shop drawings

### 30.2.4 Wall System Selection

The Engineer of Record (EOR) in cooperation with the geotechnical engineer shall determine all viable and appropriate wall systems on the QPL that may be used at the specific site. These systems will be denoted on the General Notes sheet of the Control Plans. These systems will be determined based on their technical applications. The EOR shall provide documentation of wall selection in the Retaining Wall Justification portion of the BDR.

When determining which proprietary wall systems are to be used, the EOR shall start with all the wall systems on the QPL. The EOR shall first eliminate systems based on the environment (see **Exhibit 30-3**). All systems that are appropriate shall then be considered based on their geotechnical applications. The geotechnical considerations may be complex and a geotechnical engineer familiar with all the wall systems should be a part of the team that determines wall systems. Some of the geotechnical considerations are short term and/or long term settlement, differential settlement both longitudinal and from front of wall to end of concrete stems or soil reinforcement (rotation) and global stability. Flow chart Exhibit 30-3 shows the procedure for final wall system selection.

## 30.3 Critical Temporary Walls

A critical temporary wall is one that is necessary to maintain the safety of the traveling public or structural integrity of nearby structures and utilities for the duration of the construction contract.

Critical temporary walls shall be designed in accordance with this chapter, AASHTO LRFD Specifications, and of the **Structures Design Guidelines** and shall include the soil

reinforcement lengths, sizes, and stress level requirements for permanent walls

The allowable reinforcement tension for temporary MSE walls using geogrid soil reinforcement shall be in accordance with of the ***Structures Design Guidelines***

The design details of critical proprietary temporary walls shall be submitted in the shop drawings. The generic design details of critical temporary walls shall be included in the contract set of plans. The plans format shall be in accordance with Section 30 2 2 and 30 2 3.

### **30.4 Experimental Wall Projects**

The Department maintains a Qualified Products List (QPL) of all wall systems that have been approved. The proprietary wall companies must comply with the Department's "Guidelines for Selection and Approval of Proprietary Retaining Wall Systems" to be placed on the QPL. One of the requirements is to build a wall that may be instrumented and shall be monitored. Special instructions for design and plans package preparation shall be obtained from the State Structures Design Office.

### **30.5 Shop Drawing Review**

Conventional CIP retaining walls do not require shop drawings, however, proprietary retaining walls require shop drawings in accordance with **Chapter 28**.

The shop drawing reviewer (EOR) shall be experienced in the requirements, design and detailing of proprietary wall plans. The EOR shall review but not be limited to the following items:

- o Verify vertical and horizontal geometry with contract plans
- o Verify details with MSE wall suppliers standard details in contract plans
- o Soil reinforcement placement in acute corners shall be detailed
- o Slip joints shall be at all bin wall and standard MSE wall interface locations
- o Soil reinforcement shall be detailed at all obstructions. Cutting or kinking of soil reinforcement shall not be allowed. Connection of soil reinforcement to piles or bearing against piles shall not be allowed.
- o Corner panels shall be used at all locations where walls are deflected horizontally 5 degrees or more
- o Compare proposed reinforced fill characteristics with design fill characteristics. In-place moist density of backfill may vary by  $\pm 5$  pcf, and the internal friction angle may be  $1^\circ$  less than the design values (as shown in control plans) before a check of the wall design is required. If the internal friction angle is greater than the design value then a redesign is not required.

- o Review proprietary wall internal stability design calculations
- o Verify soil reinforcement lengths for conformance to of the **Structures Design Guidelines**, the external stability table on the plans, and the internal stability design calculations
- o Confirm wall embedment
- o Verify panel types and thickness are consistent with contract plans
- o Soil reinforcement lengths shall be the same from top to bottom of wall at any section. The diameters of the longitudinal and transverse bars of any given mesh reinforcement shall be equal. The cross-section of any soil reinforcement shall not vary along its length (i.e., "2W11" reinforcement shall not be spliced to "4W11")
- o Check stress level in soil reinforcement and connections

### **30.6 Bidding Procedure**

The conventional CIP walls shall be bid as Concrete (Retaining Wall) and Reinforcing Steel (Retaining Wall). Conventional walls may be bid as an alternate to proprietary walls if the site conditions justify conventional walls.

Proprietary Walls shall be bid with Pay Item numbers,  
548-\_\_\_ Retaining Wall System (Permanent)  
548-\_\_\_ Retaining Wall System (Temporary)

### SAMPLE INVITATION LETTER

(When Proprietary Designs are Included in Contract Plans)

Financial Project ID \_\_\_\_\_  
State Project No \_\_\_\_\_  
FAP No \_\_\_\_\_  
W P I No \_\_\_\_\_

\_\_\_\_\_  
\_\_\_\_\_  
\_\_\_\_\_

Attn \_\_\_\_\_

Gentlemen

The Florida Department of Transportation invites your company to participate in alternate designs for the retaining walls to be included in the subject project.

Your participation will involve submitting us three (3) sets of prints of your final design for our review, and upon our notification of acceptance, the submittal of drawings on xerographic print material for inclusion in the final plan assembly. The drawings shall be made and submitted via 11" x 17" sheets and electronic medium in Microstation format conforming to FDOT CAD standards.

The subject project has been scheduled for letting in \_\_\_\_\_, therefore, the final plans and design calculations shall be submitted not later than \_\_\_\_\_, and the 100% Plans submitted not later than \_\_\_\_\_ in order to meet this schedule.

We are enclosing the following material for your use

- Roadway plans of the area
- Foundation information and report
- Wall alignment (vertical and horizontal), special details and the locations of sign structures, drainage structures and utilities

Your design must conform strictly with the above information

In addition, the AASHTO LRFD code and the following criteria shall be used (as applicable)

**Exhibit 30-1, Page 1 of 2**

SAND FILL (Statewide except Dade and Monroe Counties)

Overturning	= 2.0
Sliding	= 1.5
Internal pullout	= 1.5 (Allowable Deformation 3/4" )
Bearing capacity	= 2.5
Overall stability	= 1.5
Steel Soil Reinforcement (Bars and Straps)	= 0.55 Fy at end of design life, and 0.50 Fu at net section of bolted connection
Steel Soil Reinforcement (Grids and Bar Mats)	= 0.47 Fy at end of design life
Design Based $\phi$	= 30°
Backfill Unit Weight	= 105 pcf (Min) Moist wt in place
Maximum Pullout Factors	
Ribbed Strips, $f_{p,max}^*$	= 1.5
Grids and Bar Mats, $N_{p,max}$	= 30

LIMEROCK FILL (Dade and Monroe Counties only)

Overturning	= 2.0
Sliding	= 1.5
Internal pullout	= 1.5 (Allowable Deformation 3/4" )
Bearing capacity	= 2.5
Overall stability	= 1.5
Steel Soil Reinforcement (Bars and Straps)	= 0.55 Fy at end of design life, and 0.50 Fu at net section of bolted connection
Steel Soil Reinforcement (Grids and Bar Mats)	= 0.47 Fy at end of design life
Design Based $\phi$	= 30°
Backfill Unit Weight	= 105 pcf Moist wt in place
Maximum Pullout Factors	
Ribbed Strips, $f_{p,max}^*$	= 1.5
Grids and Bar Mats, $N_{p,max}$	= 30

Your acknowledgment of this invitation and acceptance/or rejection is required. In the event of non-acceptance, the enclosed material may be discarded. Also, your firm will not be considered for a Value Engineering Concept Proposal for this project at a later date.

If there are any questions, please advise.

Very truly yours,

Enclosures

**Exhibit 30-1, Page 2 of 2**

**SAMPLE LETTER**  
(For Control Plans Only)

Financial Project ID \_\_\_\_\_  
State Project No \_\_\_\_\_  
FAP No \_\_\_\_\_  
W P I No \_\_\_\_\_

\_\_\_\_\_  
\_\_\_\_\_  
\_\_\_\_\_

Attn \_\_\_\_\_

Gentlemen

The Florida Department of Transportation is anticipating letting the subject project in \_\_\_\_\_

The enclosed information is being transmitted for your information and bid preparation. If your company has any innovative methods or designs for this project, they should be submitted before \_\_\_\_\_ for our review.

We are enclosing the following material for your use:

- Roadway plans of the area
- Foundation information and report
- Wall alignment (vertical and horizontal), special details, and the locations of sign structures, drainage structures, and utilities

Your design must conform strictly with the above information.

In addition, the following criteria and minimum safety factors shall be used (as applicable):

**Exhibit 30-2, Page 1 of 2**

SAND FILL (Statewide except Dade and Monroe Counties)

Overturning	= 2.0
Sliding	= 1.5
Internal pullout	= 1.5 (Allowable deformation = 3/4" )
Bearing capacity	= 2.5
Overall stability	= 1.5
Steel Soil Reinforcement (Bars and Straps)	= 0.55 Fy at end of design life, and 0.50 Fu at net section of bolted connection
Steel Soil Reinforcement (Grids and Bar Mats)	= 0.47 Fy at end of design life
Design Based $\phi$	= 30°
Backfill Unit Weight	= 105 pcf moist weight in place

Maximum Pullout Factors

Ribbed Strips, $f^*_{max}$	= 1.5
Grids and Bar Mats, $N_{P,max}$	= 30

LIMEROCK FILL (Dade and Monroe Counties only)

Overturning	= 2.0
Sliding	= 1.5
Internal pullout	= 1.5 (Allowable deformation = 3/4" )
Bearing capacity	= 2.5
Overall stability	= 1.5
Steel Soil Reinforcement (Bars and Straps)	= 0.55 Fy at end of design life, and 0.50 Fu at net section of bolted connection
Steel Soil Reinforcement (Grids and Bar Mats)	= 0.47 Fy at end of design life
Design Based $\phi$	= 30°
Backfill Unit Weight	= 105 pcf moist weight in place

Maximum Pullout Factors

Ribbed Strips, $f^*_{max}$	= 1.5
Grids and Bar Mats, $N_{P,max}$	= 30

Your acknowledgement of receipt of this package and applicability of your wall for this/these site(s) is required. In the event that you do not wish to participate in this project, the enclosed material may be discarded. Also, your firm will not be considered for a Value Engineering Concept Proposal for this project at a later date.

If there are any questions, please advise

Very truly yours,

Enclosures

**Exhibit 30-2, Page 2 of 2**

**PROPRIETARY RETAINING WALLS**

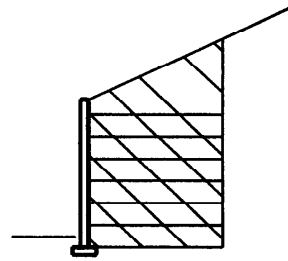
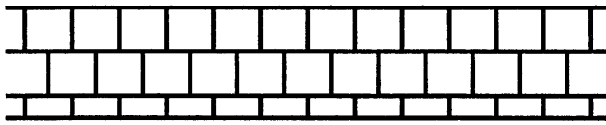

**INTERNAL STABILITY - Designed by Wall Company**  
 (Considers only wall panel connections & strap length)

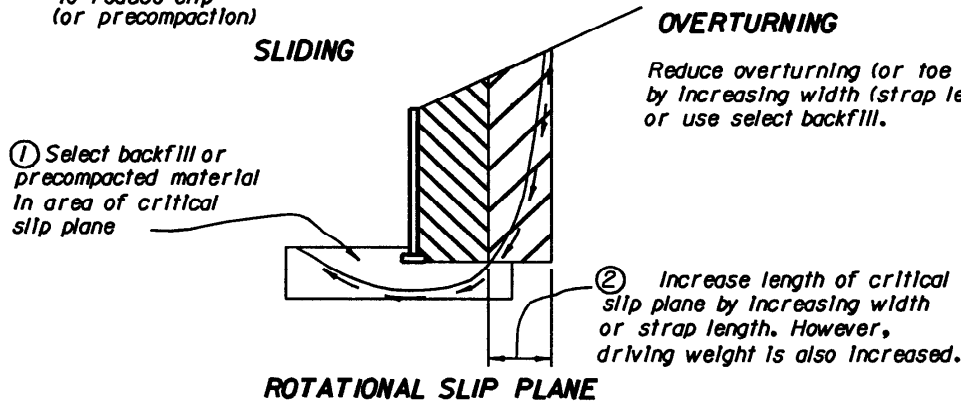
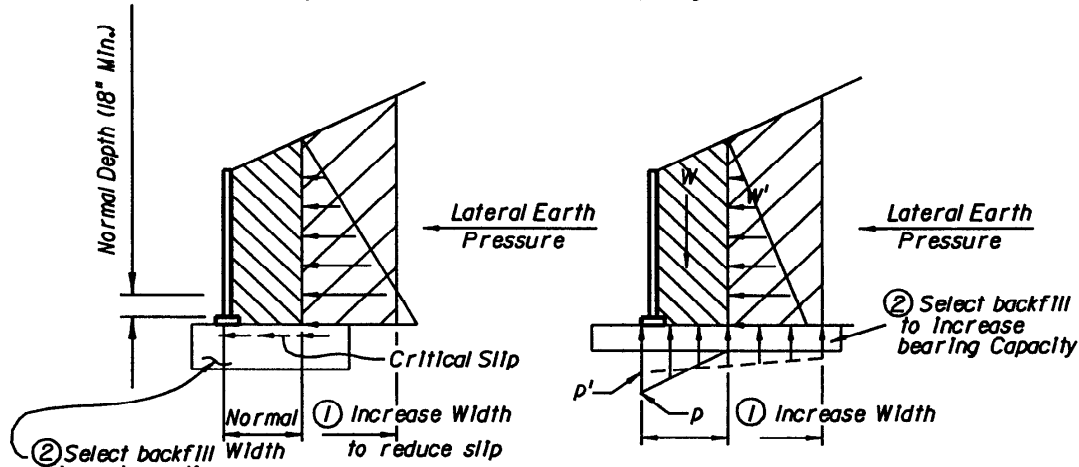

**EXTERNAL STABILITY - Designed by Roadway Consultant**

**Figure 30.1**



### Flow Chart to Determine Wall Companies for Specific Sites

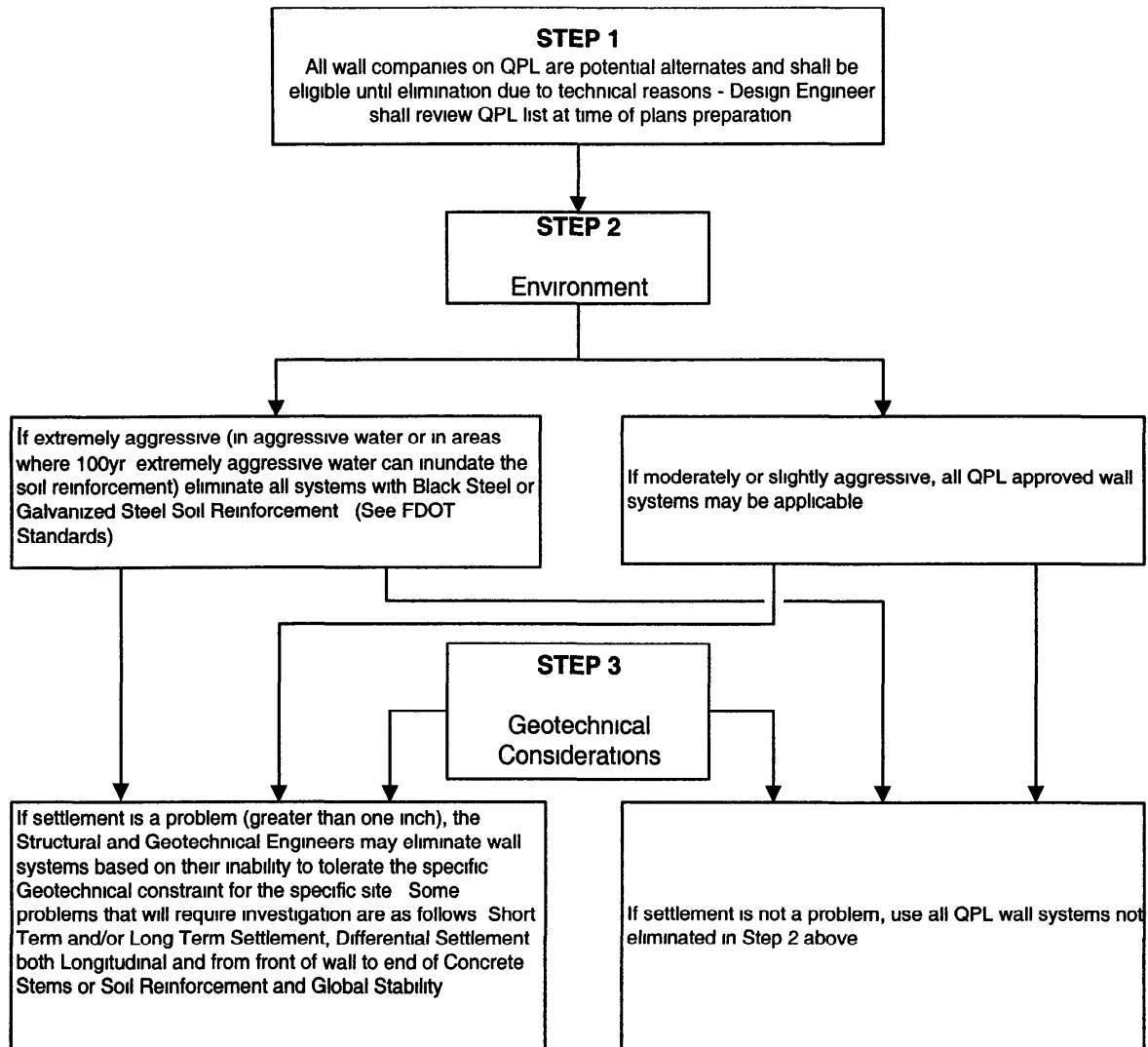

All wall systems not eliminated due to technical reasons shall be noted on the "Control Plans" as appropriate for the site.

The Engineer should use this flow chart as a guide. Specific site problems may fall outside the limits of this flow chart. Therefore, the engineers using this chart to determine the applicable wall systems must be knowledgeable of the approved wall systems capabilities and limitations.

### Exhibit 30-3

## **Chapter 31**

### **GEOSYNTHETIC DESIGN**

31.1 Purpose .....	31-1
31.2 Plan Content ... ..	31-1
31.3 Bidding Procedure .....	31-2
31.4 Shop Drawings .....	31-2
31.5 Geosynthetic Reinforcement Design Methodology .....	31-3
31.5.1 Design Considerations ... ..	31-3
31.5.2 Requirements .....	31-3
31.5.3 Design Guidelines .....	31-4
Exhibit 31-1 .....	31-7
Exhibit 31-2 .....	31-8

## Chapter 31

### GEOSYNTHETIC DESIGN

#### 31.1 Purpose

The purpose of this chapter is to give the designer an understanding of the procedure to develop designs for geosynthetic reinforced soil slopes and geosynthetic reinforced foundations over soft soils. A step-by-step method to develop and organize the plans is presented.

Reinforced soil slopes should be utilized when the right of way is insufficient to construct embankments. With normal slopes and retaining walls are not economical or are undesirable.

Reinforced foundations over soft soils should be utilized when the existing soils are too weak to support the anticipated loading without excessive settlement and excavation and backfilling is not an economical solution.

Approved products for these designs are included on **Index No. 501** of the ***Roadway and Traffic Design Standards***.

#### 31.2 Contract Plans Content

Control drawings are required which depict the geometrics (plan and elevation view) of the area being reinforced. These designs are generic and are not based upon any one specific product or supplier. For reinforced slopes the designer shall design the slopes using the maximum reinforcement spacings allowed. For soft soils the designer shall design the reinforcement and provide the minimum total strength required.

The plans shall depict the required reinforcement strength based on the maximum allowed spacing of these materials, the extent and the number of layers of geosynthetic reinforcement, vertical spacing of geosynthetic reinforcement, orientation of geosynthetic facing details, details at special structures or obstructions, typical construction sequence, and top and bottom elevations of the geosynthetic reinforcement. Product names are not to be shown in the plans. Surface treatments and any other required design parameters or limitations shall also be shown in the plans.

### 31.3 Bid Procedure

Geosynthetic Reinforced Soil Slopes shall be bid with Pay Item No 145-1

Geosynthetic Reinforced Foundations Over Soft Soils shall be bid with Pay Item No 145-2

### 31.4 Shop Drawings / Redesigns

The contractor can choose to construct the reinforced soil structures either by (1) using materials which meet or exceed the strength required in the plans and be placed at or less than the plan spacing(s) or (2) submitting an alternate design which optimizes the use of a specific material and revises the material spacing within the limits contained in the design methodology in **Section 31.5**. The properties of site specific backfill is seldom available at the design phase of a project. This being the case, subsequent alternate designs are encouraged after the backfill source is known. Using soil properties of site specific material allows for optimization of the materials resulting in a corresponding cost benefit to the Department. All designs shall meet the design methodology contained in **Section 31.5**.

The shop drawing reviewer shall be experienced in the requirements, design and detailing of these systems. The review shall consist of but not limited to the following items:

- Verify horizontal and vertical geometry with the contract plans
- Soil reinforcement is listed on **Index 501**
- Soil reinforcement material test results meet or exceed values on **Index 501**
- Verify the material strengths and number of layers of the product selected meets or exceeds the design shown in the contract plans
- Soil properties for the material chosen by the contractor meet or exceed those used in the design shown in the Contract Plans
- If a redesign is proposed, verify the design meets the requirements of **Section 31.5** and the Contract Plans

If a redesign is submitted, complete plans shall be provided which include plan view, elevation view, and details in accordance with the Plans and Specifications. These shall show the extent, number of layers of geosynthetic reinforcement, minimum properties of each geosynthetic reinforcement layer, vertical spacing of geosynthetic reinforcement, orientation of geosynthetic facing details, details at special structures or obstructions, typical construction sequence, and top and bottom elevations of the geosynthetic reinforcement. Calculations shall be submitted to substantiate the design meets the requirements in this document and in accordance with the Contract Plans. As a minimum these shall clearly show the derivation of reinforcement requirements (i.e., type, spacing, length, etc.) and determination of all design parameters and factors. All plans and calculations are to be sealed by a Professional Engineer registered in the State of Florida.

## 31.5 Geosynthetic Reinforcement Design Methodology

This design methodology applies only for geosynthetic reinforced soil slopes and geosynthetic reinforced foundations over soft soils. Geosynthetic is a generic term for all synthetic materials used in Geotechnical engineering applications and includes geotextiles and geogrids.

### 31.5.1 Design Considerations.

Only those geosynthetic products listed on the **Roadway and Traffic Design Standards Index 501** are eligible for use on FDOT projects. The geosynthetic reinforced systems shall be designed using comprehensive stability analyses methods that address both internal and external stability considerations by a professional engineer registered in Florida who specialized in Geotechnical engineering. The following design guidelines and requirements should be used for the analyses and design.

### 31.5.2 Requirements

**1. Performance:** The design factors of safety used shall be adequate to cover all uncertainties in the assumptions and design. Required minimum stability factors of safety are:

- 1.5 against pullout failure
- 1.5 against sliding of the reinforced mass
- 1.3 against external, deep-seated failure
- 1.3 against compound failure, i.e., failure behind and through the reinforcement
- 1.3 against internal failure
- 1.3 against local bearing failure (lateral squeeze)

**2. Allowable Tension:** The geosynthetic design shall be based on the following relationships:

$$T_a = \frac{T_{ult}}{F_c F_d F_j} CRF$$

- $T_a$  = The allowable long term reinforcement tension ( $T_a$  shall not exceed 19%  $T_{ult}$  for permanent applications or 29%  $T_{ult}$  for temporary applications)
- $T_{ult}$  = The ultimate strength of a geosynthetic
- $F_c$  = partial factor of safety for construction damage
- $F_d$  = partial factor of safety for durability
- $F_j$  = partial factor of safety for joint strength where geosynthetics are connected together or overlapped in the direction of primary force development. The values of  $F_j$  should be taken as the ratio of the unjointed specimen strength to the joined specimen strength. Use  $F_j = 1.0$

CRF = creep reduction factor  $CRF = T_{creep}/T_{ult}$   
 $T_{creep}$  = serviceability state reinforcement tensile load based on minimum 10,000-hour creep tests

These parameters can be found from the appropriate FDOT's **Roadway and Traffic Design Standards Index 501**

For applications involving reinforcing slopes with geosynthetic,  $T_{creep}$  shall be projected for a design life of 75 years

**3. Soil Reinforcement Interaction:** Unless existing approved values are used, pullout resistance for design purposes shall be determined from pullout testing performed by an approved testing laboratory. The coefficient of interaction ( $C_i$ ) shall be determined from controlled strain rate pullout testing done in accordance with GRI GG5.  $C_i$  is defined by the following relationship

$$C_i = \frac{T_p}{2 L \sigma_n \text{TAN}\Phi}$$

Where

- $T_p$  = pullout capacity of reinforcement (lbs/foot of width)
- $L$  = geosynthetic embedment length (ft)
- $\sigma_n$  = effective normal pressure (psf)
- $\Phi$  = effective friction angle of backfill

The coefficient of interaction should be approximately constant for a given soil and geosynthetic material over a range of effective normal pressures. If a plot of  $C_i$  vs  $\sigma_n$  indicates that  $C_i$  is approximately constant then that value shall be used for design. If the plot indicates a relatively wide variability of  $C_i$  over the anticipated range of normal stresses then either a single minimum value shall be used for  $C_i$  or a  $C_i$  corresponding to the effective stress at each expected grid elevation may be used.

The coefficient of interaction may be determined by any one of the following means

- Pullout testing may be performed on the proposed geosynthetics and actual soil backfill being proposed for the construction
- Pullout testing is required for geosynthetic products as part of the **Roadway and Traffic Design Standards Index 501** approval process. If, in the opinion of the Engineer, the existing approved pullout test data is representative of the proposed soil backfill and geosynthetic reinforcement, these corresponding  $C_i$  values may be used

### 31.5.3 Design Guidelines

The design guidelines are excerpted from the FHWA Publications (a) No. FHWA-SA-96-071 "Mechanically Stabilized Earth Walls and Reinforced Soil Slopes Design and

Construction Guidelines”, and (b) No FHWA HI-95-038, “Geosynthetic Design and Construction Guidelines” Designers should refer to these publications for details

**A. Reinforced Slope** - see reference (a) FHWA-AS-96-071

- Step 1 Establish the geometry and loading - see **Exhibit 31-1**
- Step 2 Determine the engineering properties of the insitu soils
- Step 3 Determine the properties of the reinforced fill and the retained fill  
The following values for the backfill soil within the reinforced volume shall be used
  - For sand backfill  $\phi = 30^\circ$ ,  $\gamma = 105$  pcf,  $c = 0$ ,
  - For crushed limerock backfill  $\phi = 34^\circ$ ,  $\gamma = 115$  pcf,  $c = 0$
- Step 4 Evaluate design parameters for the reinforcement
- Step 5 Check unreinforced slope stability
- Step 6 Design reinforcement to provide a stable slope
- Step 7 Check external stability
- Step 8 Evaluate requirements for subsurface and surface water runoff control

**B. Reinforced Foundation over Soft Soils** - see reference (b) FHWA HI-95-038

- Step 1 Define embankment dimensions and loading conditions- see **Exhibit 31-2**
- Step 2 Establish the soil profile and determine the engineering properties of the foundation soil
- Step 3 Obtain engineering properties of embankment fill materials
- Step 4 Establish minimum appropriate factors of safety and operational settlement criteria for the embankment  
The factor of safety for,
  - Bearing capacity 1.5
  - Global(rotational) shear stability at the end of construction 1.3
  - Internal shear stability, long-term 1.5
  - Lateral spreading (sliding) 1.5Settlement criteria depend upon project requirements
- Step 5 Check bearing capacity, global stability(both short and long term), and lateral spreading stability
- Step 6 Establish tolerable geosynthetic deformation requirements and calculate the required reinforcement modulus, J, based on wide width tensile strength,  $T_{1s}$ , tested in according to (ASTM D 4595) The geosynthetic reinforcement should be designed for strain compatibility with the weak insitu soil, with creep being a non-design factor

Based on type of filled materials, the strains are recommended as follows,

Cohesionless soils	$\epsilon_{\text{geosynthetic}} = 5 \text{ to } 10\%$
Cohesive soils	$\epsilon_{\text{geosynthetic}} = 2\%$
Peat	$\epsilon_{\text{geosynthetic}} = 2 \text{ to } 10\%$

- Step 7 Reinforcement modulus is calculated as  $J = T_{1s} / \epsilon_{\text{geosynthetic}}$   
Establish geosynthetic strength requirements in the geosynthetic's longitudinal direction
- Step 8 Establish geosynthetic properties
- Step 9 Estimate magnitude and rate of embankment settlement
- Step 10 Establish construction sequence and procedures  
This includes stage construction, if needed, and all the stability analyses for each stage of constructions. The analysis should be based on the estimated strength of the subsoils at the end of the previous construction stage
- Step 11 Establish construction observation requirements  
Instrumentations such as settlement plates, piezometers, and/or inclinometers should be designed to monitor the performance of the construction. The monitoring criteria, such as the maximum rate of piezometric and/or settlement change before the next stage of construction can proceed, etc., should also be established



### Geosynthetic Reinforced Soil Slopes

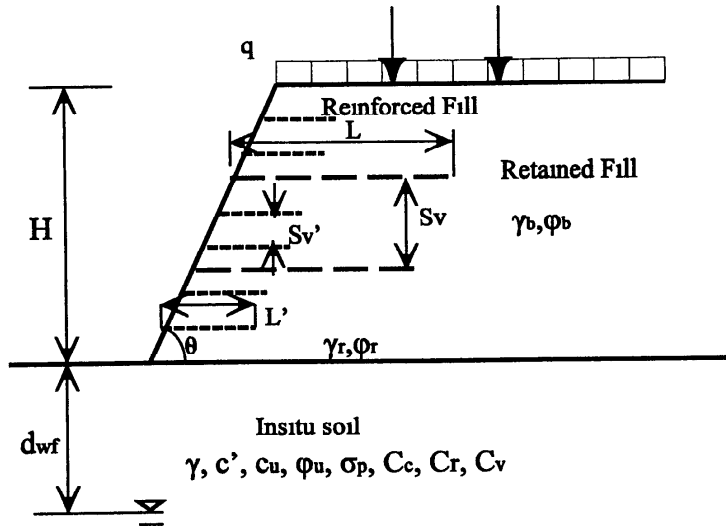

- Notations:**
- $H$  = slope height
  - $\theta$  = slope angle
  - $L$  = length of primary reinforcement
  - $L'$  = length of secondary reinforcement, 4' minimum
  - $S_v$  = vertical spacing between primary reinforcements, 4' maximum
  - $S_v'$  = vertical spacing between secondary reinforcements, 1' maximum
  - $q$  = surcharge load
  - $\Delta q$  = temporary live load
  - $d_{wf}$  = depth to groundwater table in foundation
  - $\gamma_r, \gamma_b$  &  $\gamma$  = unit weights of soils in reinforced, retained and foundation, respectively
  - $\phi_r, \phi_b$ , &  $\phi$  = friction angles of soils in reinforced, retained and foundation, respectively
  - $c', c_u$  = cohesion strength parameters of foundation soil

**Exhibit 31-1**

### Geosynthetic Reinforced Foundations Over Soft Soils

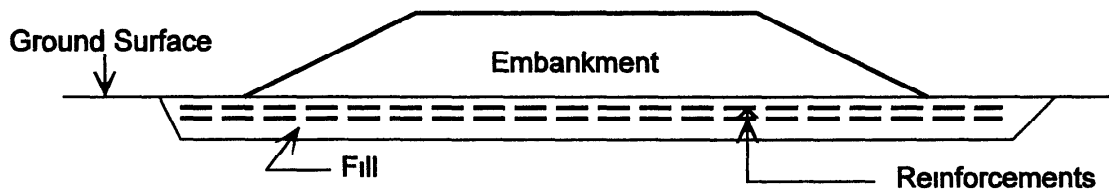

The minimum spacing between two reinforcements shall be 6 inches  
but not larger than 12 inches

### Exhibit 31-2