

## **MEMORANDUM**

**DATE:** January 4, 1994

**TO:** Plans Preparation Manual Owners

**FROM:** Linda Seigle, Roadway Design Documents and Training

**SUBJECT:** **REVISIONS TO THE 1989 PLANS PREPARATION MANUAL**

Attached is Chapter 25 to be added to the Plans Preparation Manual. This chapter incorporates Florida's Design Standards for Resurfacing, Restoration and Rehabilitation (RRR) of Streets and Highways into the PPM and replaces previous versions of the RRR standards.

A table of contents for the chapter is included. This TOC will be incorporated into the Volume I Table of Contents when it is republished with the revisions approved in December.

Attachments

**MEMORANDUM**

**DATE:** January 4, 1994  
**TO:** Plans Preparation Manual Owners  
**FROM:** Linda Seigle, Roadway Design Documents and Training  
**SUBJECT:** REVISIONS TO THE 1989 PLANS PREPARATION MANUAL

Attached are the Plans Preparation Manual changes that were made in association with the implementation of Chapter 25, Florida's Design Standards for Resurfacing, Restoration and Rehabilitation (RRR) of Streets and Highways.

Also included is a revision made at the request of District Utility Engineers. The revision is on page ~~28~~ 29.

First paragraph on page Relocation or adjustment is ~~usually~~ required

Second paragraph Deleted

Please replace this page in your chapter with the revised page. The Table of Contents for the chapter was revised to show this revision.

Attachments

# **ROADWAY PLANS PREPARATION MANUAL VOLUME I**

## **DESIGN CRITERIA AND PROCESS**

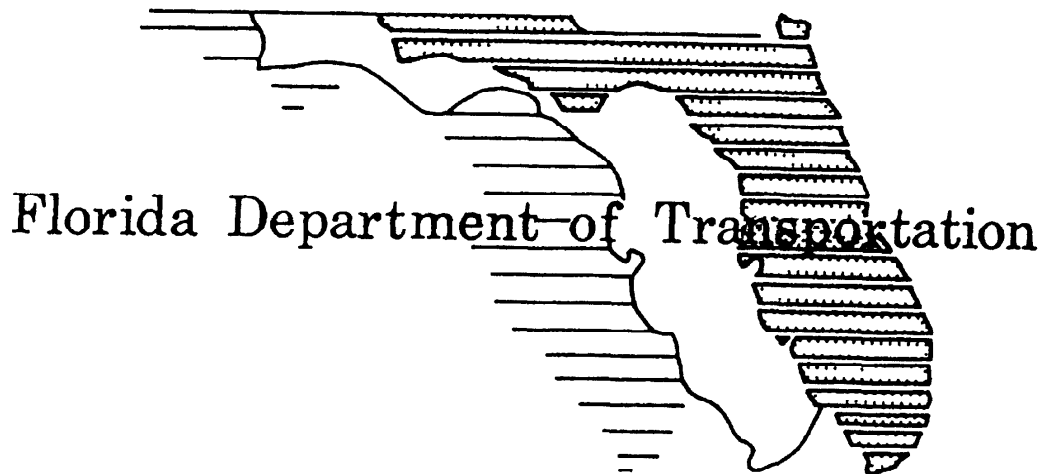

**DOCUMENT NO. 625-000-101-B  
ROADWAY DESIGN OFFICE  
TALLAHASSEE, FLORIDA  
1989**

**ROADWAY PLANS PREPARATION MANUAL**

NAME

---

NAME OF FIRM OR  
D.O.T. DISTRICT

---

---

MAILING ADDRESS

---

---

---

---

TELEPHONE

---

Please remove this sheet from your Manual and complete the requested information so that addenda and revisions may be forwarded as necessary.

Please return to:

Florida Department of Transportation  
Roadway Design Office  
Mail Station 32  
605 Suwannee Street  
Tallahassee, Florida 32399-0450

**SUGGESTIONS AND COMMENTS**

**ROADWAY DESIGN MANUALS**

DOCUMENT NAME & No \_\_\_\_\_

NAME OF FIRM/D O T DEPARTMENT \_\_\_\_\_

ADDRESS \_\_\_\_\_  
\_\_\_\_\_  
\_\_\_\_\_

NAME AND TELEPHONE No OF PERSON RESPONSIBLE FOR SUGGESTION OR COMMENT ( \_\_\_\_\_ ) \_\_\_\_\_

SUGGESTIONS OR COMMENTS \_\_\_\_\_  
\_\_\_\_\_  
\_\_\_\_\_  
\_\_\_\_\_  
\_\_\_\_\_  
\_\_\_\_\_  
\_\_\_\_\_  
\_\_\_\_\_

(Comments or Suggestions may be attached as marked up copies of pages from the manuals )

PLEASE COMPLETE THE REQUESTED INFORMATION AND RETURN THIS SHEET TO

FLORIDA DEPARTMENT OF TRANSPORTATION  
ROADWAY DESIGN OFFICE  
MAIL STATION 32  
605 SUWANNEE STREET  
TALLAHASSEE, FLORIDA 32399-0450  
ATTN LINDA SEIGLE  
PHONE (904)487-1949

**TABLE OF CONTENTS**  
**VOLUME I**

**Design Criteria and Process**

<b><u>Introduction</u></b>		XIX
<b><u>Chapter 1</u></b>	<b>Design Parameters</b>	
1 1	General .	I-1- 1 0
1 2	Traffic	I-1- 2 0
1 3	Capacity and Level of Service	I-1- 3 0
1 4	Roadway Functional Classification	I-1- 4 0
1 5	3R Design	I-1- 5 0
1 6	Design Consistency and Driver Expectancy	I-1- 6 0
1 7	Aesthetics	I-1- 9 0
1 8	Access Management	I-1-10 0
<b><u>Chapter 2</u></b>	<b>Geometrics</b>	
2 1	Standards .	I-2- 1 0
2.1 1	Fixed Standards . .	I-2- 1 0
2 1.2	Design Standard Ranges	I-2- 2 0
2 2	Lane Widths	I-2- 4 0
2 2 1	Through Lanes	I-2- 4 0
2 2 2	Transitions of Pavement Widths	I-2- 5 0
2 2 3	Wide Curb Lanes .	I-2- 6 0
2 2 4	Other Lane Widths	I-2- 8 0
2 2 5	Bicycle Lanes	I-2- 8 0
2 2.6	Shoulder Widths . . .	I-2- 9 0
2 2 7	Limits of Friction Course on Shoulders	I-2-12 0
2 3	Other Cross Section Elements	I-2-14 0

2 3 1	Cross Slopes	I-2-14 0
2 3 2	Roadway Structure	I-2-14 0
2 3 3	Side Slope and Side Ditches	I-2-16 0
2 3 4	Border Width	I-2-16 0
2 4	Horizontal Alignment	I-2-17 0
2 4 1	General	I-2-17 0
2.4.2	Supplemental Alignment Control	I-2-17 0
2 4 3	Two-Lane to Four-Lane Transitions	I-2-20 0
2 5	Vertical Alignment	I-2-21 0
2 6	Superelevation	I-2-22 0
2 7	Cross Sections	I-2-23 0
2 8	Intersections and Interchanges	I-2-24 0
2 9	Limited Access Limits at Interchanges	I-2-25 0
2 10	Design of Rural Projects	I-2-26 0
2 10 1	Profiles	I-2-26 0
2 10 2	Cross Sections	I-2-28 0
2 10.3	Preliminary Review	I-2-29 0
2 11	Design of Urban Projects	I-2-30 0
2.11.1	Preparation	I-2-30 0
2 11.2	Geometrics	I-2-31 0
2.11 3	Profiles	I-2-32 0
2 11 4	Cross Sections	I-2-35 0
2 11 5	Preliminary Review	I-2-35 0

**Chapter 3**

**Earthwork**

3 1	General	I-3- 1 0
3 2	Classification of Soils	I-3- 3 0
3 3	Removal and Utilization	I-3- 4 0
3 3 1	Criterna for Earthwork Details	I-3- 4 0
3 3 2	Cross Sections - A Design Tool	I-3- 5 0

3 4	Earthwork Quantities	I-3- 6 0
3 4 1	Method of Calculating	I-3- 6 0
3 4 2	Suitable and Unsuitable Materials	I-3- 6 0
3 4 3	Earthwork Accuracy	I-3- 9 0
3 4 4	Variation in Quantities	I-3-10 0
3 4 5	Sequence of Construction	I-3-11 0
3 4 6	Earthwork by Computer	I-3-12 0
3 5	Earthwork Items of Payment	I-3-13 0
3 5 1	Regular Excavation	I-3-13 0
3 5 2	Borrow Excavation	I-3-13 0
3 5 3	Lateral Ditch Excavation	I-3-16 0
3 5 4	Subsoil Excavation	I-3-17 0
3 5 5	Channel Excavation	I-3-18 0
3 5 6	Embankment	I-3-18 0
3 5 7	Regular Excavation - Lump Sum (3-R Projects Only)	I-3-20 0
3 6	Summary	I-3-23 0

**Chapter 4 Roadside Safety**

4.1	Clear Zone . . . . .	I-4- 1 0
4 1.1	Clear Zone Concept	I-4- 1 0
4 1 2	Clear Zone Criteria	I-4- 2 0
4 2	Canal Hazard Standards	I-4- 5 0
4 3	Roadside Barriers	I-4- 8 0
4 3 1	Warrants	I-4- 8 0
4 3 2	Barrier Selection	I-4- 9 0
4 3 3	End Treatments	I-4-10 0
4 3 4	Transitions	I-4-11 0
4 3 5	Placement . . . . .	I-4-11 0
4 3 6	Resetting Guardrail	I-4-13 0
4 4	Median Barriers	I-4-14 0



4 4 1	Warrants	I-4-14 0
4 4 2	Selection	I-4-14 0
4 4 3	End Treatments	I-4-14 0
4 5	Crash Cushions	I-4-15 0
4 5 1	Warrants	I-4-15 0
4 5 2	Selection	I-4-15 0
4 5 3	Design	I-4-16 0
4 6	Roadside Appurtenances	I-4-18 0
4 6 1	Sign Supports	I-4-18 0
4 6 2	Mailbox Supports	I-4-19 0
4 6 3	Other Appurtenances	I-4-19 0
4 6 4	Location Criteria	I-4-19 0
4.6 5	Bus Benches and Transit Shelters	I-4-19 0

**Chapter 5**

**Utilities**

5 1	General	I-5- 1 0
5 2	Relocation	I-5- 2 0
5 3	Utility - Accommodation Guide	I-5- 3 0
5 4	Verification of the Location of Major Existing Utilities	I-5- 4 0
5 4 1	Locating Underground Utilities	I-5- 5 0
5 5	Coordination Process	I-5- 8 0
5 5 1	Coordination of Traffic Monitoring Sites	I-5- 9 0

**Chapter 6**

**Railroad Grade Crossing**

6 1	General . . .	I-6- 1 0
6 2	Devices . . . .	I-6- 2 0
6 3	Surfaces .	I-6- 3 0
6 4	Clearance at Railroad/Highway Structures	I-6- 4 0

<b><u>Chapter 7</u></b>		<b>Signing, Marking, Lighting and Signals</b>	
7 1	General		I-7- 1 0
7 2	Signing and Marking		I-7- 2 0
7 2 1	Design Criteria		I-7- 3 0
7 2 2	Wind Loading Criteria - Signs		I-7- 3 0
7 2 3	Project Coordination		I-7- 5 0
7 3	Lighting		I-7- 6 0
7 3 1	Design Criteria		I-7- 6 0
7 3 2	Conventional Lighting Criteria		I-7- 7 0
7 3 3	High-Mast Lighting Criteria		I-7- 8 0
7 3 4	Pole Design Criteria		I-7- 8 0
7 3 5	Underdeck Lighting Criteria		I-7- 9 0
7 3 6	Foundations Criteria		I-7-10 0
7 3 7	Wind Loading Criteria - Lighting		I-7-10 0
7 3 8	Lighting Project Coordination		I-7-11 0
7 3 9	Voltage Drop Criteria		I-7-13 0
7 4	Traffic Signals		I-7-14 0
7 4 1	Design Criteria . . . . .		I-7-14 0
7 4 2	Certification and Specialty Items		I-7-15 0
7 4 3	Stop Line Location . . . . .		I-7-15 0
7 4 4	Controller Timing		I-7-16 0
7 4 5	Left Turn Treatments		I-7-16 0
7 4 6	Signal Preemption		I-7-19 0
7 4 7	Intersection Design - Lane Configuration		I-7-19 0
7 4 8	Signal Loops		I-7-22 0
7 4 9	Wind Loading Criteria - Traffic Signals		I-7-22 0

<b><u>Chapter 8</u></b>		<b>Bicycles and Pedestrian Facilities</b>	
8 1	General	.	I-8- 1 0
8 2	Sidewalks . . . . .	..	I-8- 2 0

8 3	Handicap Access	I-8- 4 0
8 4	Bicycle Facilities . . .	I-8- 5 0
<b>Chapter 9</b>	<b>Landscaping</b>	
9 1	General	I-9- 1 0
<b>Chapter 10</b>	<b>Work Zone Traffic Control</b>	
10 1	General . . .	I-10- 1 0
10 2	References . . . . .	I-10- 2 0
10 3	Comprehensive Work Zone Traffic Control Planning	I-10- 3 0
10 4	Traffic Control Plans	I-10- 5 0
10 5	TCP Development	I-10- 7 0
10 6	Coordination . . .	I-10-11 0
10 6 1	FHWA Review	I-10-12 0
10 6 2	Phase Submittals	I-10-12 0
10 7	Work Zone Traffic Control Training	I-10-13 0
10 7 1	Background	I-10-13 0
10 7.2	Training Requirements	I-10-13 0
10 8	Traffic Control Devices	I-10-14 0
10 9	Signs	I-10-15 0
10 9.1	Advance Warning Signs . . .	I-10-15 0
10.9.2	Length of Construction Sign	I-10-15 0
10.9.3	Sign Covering . . . . .	I-10-15 0
10 9 4	Existing Signs . . .	I-10-16 0
10 10	Lighting Units . . .	I-10-17 0
10 10 1	Warning Lights . . . . .	I-10-17 0
10 10 2	Advance Warning Arrow Panels	I-10-18 0
10.10.3	Variable Message Signs . . . . .	I-10-19 0
10.10 4	Traffic Signals . . . . .	I-10-22 0
10 11	Channelizing Devices . . .	I-10-23 0

10 11 1	Type III Devices	I-10-23 0
10 11 2	Separation Devices	I-10-23 0
10 11 3	Channelizing Device Alternates	I-10-24 0
10 12	Pavement Markings	I-10-25 0
10 12 1	Removing Pavement Markings	I-10-25 0
10 12 2	Reflectonzed Raised Pavement Marker	I-10-25 0
10 12 3	Work Zone Markings	I-10-25 0
10 13	Safety Appurtenances for Work Zones	I-10-27 0
10 13 1	Traffic Barners . . . .	I-10-27 0
10 13 2	Portable Concrete Safety Shapes	I-10-27 0
10 13 3	End Treatments	I-10-28 0
10 13 4	Modifications of Existing Barners	I-10-28 0
10 13 5	Crash Cushion	I-10-28 0
10 13 6	Truck Mounted Attenuator	I-10-29 0
10 14	Flaggers	I-10-31 0
10 14 1	General	I-10-31 0
10 14 2	Location of Flaggers .	I-10-31 0
10 14 3	Police Agencies	I-10-31 0
10 15	Layouts . . . .	I-10-32 0
10 15 1	Taper Lengths .	I-10-32 0
10 15 2	Intersecting Road Signing and Signals	I-10-33 0
10 15 3	Sight Distance to Delineation Devices	I-10-34 0
10 15 4	Pedestrians and Bicyclists	I-10-34 0
10 15 5	Superelevation	I-10-34 0
10 15 6	Lane Widths .	I-10-35 0
10 15 7	Lane Closure Analysis	I-10-35 0
10 15 8	Detours	I-10-48 0
10 15 9	Above Ground Hazards	I-10-49 0
10 15 10	Drop offs in Work Zones	I-10-50 0
10.15 11	Narrow Bndges	I-10-50 0

10 15 12	Existing Highway Lighting	I-10-50 0
10 15 13	Work Area Access	I-10-51 0
10 15 14	Pay Items and Quantities	I-10-51 0
10 16	Speed Zoning	I-10-52 0
10 16 1	Regulatory Speeds in Work Zones	I-10-52 0
10 16 2	Advisory Speeds in Work Zones	I-10-56 0
<b><u>Chapter 11</u></b>	<b>Pay Items, Quantities and Specifications</b>	
11 1	Pay Items and Quantities and Specifications	I-11- 1 0
11 2	New Pay Items	I-11- 4 0
11 3	Plan Notes	I-11- 4 0
<b><u>Chapter 12</u></b>	<b>Right-of-Way</b>	
12 1	General	I-12- 1 0
<b><u>Chapter 13</u></b>	<b>Project Development</b>	
13 1	General . . . .	I-13- 1 0
13 2	Process . . . .	I-13- 1 0
13.2.1	Five Year Work Program .	I-13- 1 0
13.2.2	PD & E Process . . . .	I-13- 2 0
13.2.3	Final Design .	I-13- 3 0
13 2 4	Project Letting	I-13- 3 0
13 3	3R Design .	I-13- 5 0
13 4	In-House (DOT) Design . .	I-13- 7 0
13 5	Consultant Design	I-13- 8 0
13 6	Project Scheduling	I-13- 9 0
<b><u>Chapter 14</u></b>	<b>Data Collection</b>	
14 1	General . . . . .	I-14- 1 0
14 2	Project Data . . . . .	I-14- 1 0

14 2 1	Project Description	I-14- 1 0
14 2 2	Project Number	I-14- 2 0
14 2 3	Project Cost	I-14- 2 0
14 2 4	Production Schedule	I-14- 2 0
14 3	Design Data	I-14- 3 0
14 3 1	Surveys	I-14- 3 0
14 3 2	Traffic Data	I-14- 5 0
14 3 3	Pavement Design	I-14- 5 0
14 3 4	Environmental Documents	I-14- 5 0
14 3 5	Original Plans	I-14- 6 0
14 3 6	Accident Data	I-14- 6 0
14 4	List of Requests and Contacts	I-14- 7 0

**Chapter 15      Scheduled Submittals**

15 1	General	I-15- 1 0
15 2	Design Plans Phase Review Submittal	I-15- 2 0
15 2 1	Plans Disposition	I-15- 3 0
15 3	Other Submittals and Requests	I-15- 4 0
15 3 1	Structures (Bridges, Walls and Buildings)	I-15- 4 0
15 3 2	Surveys	I-15- 7 0
15 3 3	Typical Sections	I-15- 8 0
15 3 4	Pavement Design	I-15-13 0
15 3 5	Permits . . . . .	I-15-13 0
15 3 6	Right-of-Way Surveying and Mapping	I-15-15 0
15 3 7	Value Engineering . . . . .	I-15-17 0

**Chapter 16      Quality Control**

16 1	General . . . . .	I-16- 1 0
------	-------------------	-----------

<b><u>Chapter 17</u></b>	<b>Quality Assurance</b>	
17 1	General	I-17- 1 0
17 2	Authority	I-17- 3 0
17 3	Areas of Responsibility	I-17- 4 0
17 4	Critical Areas to be Monitored	I-17- 5 0
17 5	Documentation . . .	I-17- 7 0
17 6	Consultants Role	I-17- 8 0
17 7	Training	I-17- 9 0

<b><u>Chapters 18</u></b>	<b>Pay Items</b>	
18 1	General	I-18- 1 0
18 2	Pay Items . . .	I-18- 1 0
18 3	CES	I-18- 2 0
18 4	Computation Book	I-18- 2 0
18 5	Contract Time	I-18- 2 0
18 6	Shop Drawings	I-18- 3 0

<b><u>Chapters 19</u></b>	<b>Signing and Sealing Design Drawings</b>	
19 1	General . . . . .	I-19- 1 0
19 2	Signing and Sealing of Plans . . . . .	I-19- 2 0
19.2.1	Original Plans . . . . .	I-19- 2 0
19 2 2	Record Set . . . . .	I-19- 2 0
19 3	Signing and Sealing other Engineering Documents	I-19- 3 0
19 4	Signing and Sealing of Revisions	I-19- 4 0
19 4 1	Revisions to Plans . . . . .	I-19- 4 0
19.4 2	Revisions to Engineering Documents	I-19- 4 0
19 5	Information Requiring Certification . . . . .	I-19- 5 0
19 5 1	18 Kip Equivalent Single Axle Loads	I-19- 5 0
19 5.2	Project Traffic (to be Used for Design)	I-19- 6 0

**Chapter 20      Plans Processing and Revisions**

20 1	Plans Processing	I-20- 1 0
20 1 1	District Processing	I-20- 1 0
20 1 2	Roadway Design Office	I-20- 2 0
20 1 3	Specifications	I-20- 3 0
20 1 4	Preliminary Estimates	I-20- 9 0
20 1 5	Reprographics	I-20- 9 0
20 1 6	Federal-Aid Office	I-20-10 0
20 1 7	Production Management	I-20-10 0
20 1 8	Contracts Administration Office	I-20-11 0
20 1 9	Construction Office	I-20-11 0
20 2	Plan and Specification Revisions	I-20-13 0
20 2 1	Signed and Sealed	I-20-14 0
20.2 2	Signed, Sealed and Shipped (not reproduced)	I-20-15 0
20 2 3	Signed, Sealed, Shipped and Reproduced	I-20-16 0
20 2 4	Let to Contract (LTC)	I-20-21 0
20 2 5	Complete Project Revisions	I-20-23 0
20 3	Automated Plans (CADD) . . . . .	I-20-23 0

**Chapter 21      Consultant Project Management**

21 1	General . . . . .	I-21- 1 0
21 2	Project Definition . . . . .	I-21- 2 0
21.2 1	Project Concept Report . . . . .	I-21- 2 0
21 2 2	Scope of Services . . . . .	I-21- 2 0
21 3	Consultant Acquisition . . . . .	I-21- 3 0
21 4	Technical Management . . . . .	I-21- 3 0
21 5	Contract Administration . . . . .	I-21- 4 0
21 6	Scheduling and Coordination . . . . .	I-21- 4 0
21 7	Consultant Use of Department Computer Programs . . . . .	I-21- 5 0



<b><u>Chapter 22</u></b>	<b>Architectural Plans</b>	
22 1	General	I-22- 1 0
22 2	Codes, Rules and Regulations	I-22- 3 0
22 3	Standard Document Requirements .	I-22- 8 0
22 4	Schematic Design Phase Requirements	I-22-10 0
22 5	Design Development Phase	I-22-13 0
22 5 1	General	I-22-13 0
22 5 2	Development Procedures	I-22-13 0
22 5 3	Reviews	I-22-13 0
22 5 4	Submission Requirements	I-22-14 0
22 6	Contract Document Phase	I-22-35 0
22 6 1	General	I-22-35 0
22 6 2	Development Procedures	I-22-35 0
22 6 3	Review and Approvals	I-22-35 0
22 6 4	Documents Required	I-22-37 0
22 6 5	Release for Printing	I-22-41 0
22 6 6	Pre-Bid Conference	I-22-41 0
22 7	Construction Phase Requirements .	I-22-42 0
22 7.1	General .	I-22-42 0
22 7 2	Preconstruction Conference	I-22-42 0
22 7.3	Periodic Construction Conference	I-22-42 0
22 7 4	Shop Drawings, Materials and Equipment Submittals	I-22-43 0
22 7 4	Clarification Drawings and Specifications	I-22-44 0
22 7.5	Substantial Completion . .	I-22-45 0
22 7 6	Final Acceptance and Contract Close-out	I-22-46 0

<b><u>Chapter 23</u></b>	<b>Design Exceptions</b>	
23 1	General .	I-23- 1 0
23 2	Department Design Standards and Criteria	I-23- 1 0

23 3	Design Exceptions	I-23- 2 0
23 4	Design Variations	I-23- 2 0

**Chapter 24      Certification Acceptance (CA)**

24 1	General	I-24- 1 0
24 2	CA Coverage	I-24- 2 0
24 2 1	Areas Not Included	I-24- 2 0
24 3	CA Responsibilities	I-24- 5 0
24.4	CA Documentation and Reviews .	I-24- 9 0



## LIST OF EXHIBITS

<u>EXHIBIT</u>	<u>NUMBER</u>	<u>PAGE</u>
<b>Geometrics</b>		
Interstate and Expressway Shoulder Widths	I- 2-A	I- 2-11 0
Added Paved Shoulders	I- 2-B	I- 2-13 0
Standard Pavement Cross Slope	I-2-C	I-2-15 0
<b>Earthwork</b>		
Basic Process	I-3-A	I-3- 2 0
Cut, Subsoil Excavation, Fill	I-3-B	I-3- 8 0
Regular Excavation - Lump Sum (3-R Projects only)	I-3-C	I-3-22 0
<b>Roadside Safety</b>		
Recovery Area and Clear Zone Distance	I- 4-A	I- 4- 4 0
Minimum Standards for Canal Hazards	I- 4-B	I- 4- 7 0
<b>Utilities</b>		
Reproduction Request (Utility Blueines)	I- 5-A	I- 5-10 0
<b>Work Zone Traffic Control</b>		
Lane Closures	I-10-A	I-10-37 0
<b>Pay Items, Quantities and Specifications</b>		
Pay Item Request Form	I-11-A	I-11- 5 0
<b>Project Development</b>		
Plans Process Flow Chart	I-13-A	I-13- 4 0
Design Project Activities Flow Chart	I-13-B	I-13-11 0

**Data Collection**

Transmittal Letter to Highway Statistic Engineers	I-14-A	I-14-11 0
Soils Engineer	I-14-B	I-14-12 0
Request for Survey	I-14-C	I-14-13 0
Transmittal Letter to Materials Engineer	I-14-D	I-14-15 0
Environmental Permit Coord	I-14-E	I-14-16 0
District Railroad Coord	I-14-F	I-14-17 0
Utilities Engineer	I-14-G	I-14-18 0
Computation Book Transmittal	I-14-H	I-14-19 0
Request for CADD and Cross- Sections	I-14-I	I-14-20 0

**Scheduled Submittals**

Typical Section Data Sheet (Consultant)	I-15-A	I-15- 9 0
Typical Section Data Sheet (In-House)	I-15-B	I-15-10 0
Proposed Typical Section (Consultant)	I-15-C	I-15-11 0
Proposed Typical Section (In-House)	I-15-D	I-15-12 0

**Plans Processing and Revisions**

Contract File List	I-20-A	I-20- 4 0
Environmental Re-evaluation/ CEI Recommendation	I-20-B	I-20- 5 0
Final Plans Transmittal Letter	I-20-C	I-20- 7 0
Plans Processing Procedure	I-20-D	I-20- 8 0
Revision Letter	I-20-E	I-20-18 0
Plans Key Sheet	I-20-F	I-20-20 0
Sample Revision Letter	I-20-G	I-20-24 0

**Architectural Plans**

Title Block Requirements	I-22-A	I-22-47 0
Title Block	I-22-B	I-22-48 0
Title Sheets, Pages and Covers	I-22-C	I-22-50 0
Key Sheet	I-22-D	I-22-51 0
Standard Method of Area Calculation and Space Measurement	I-22-E	I-22-53 0

Area Analysis - Summary	I-22-F	I-22-58 0
Facilities Computation Form	I-22-G	I-22-59 0
<b>Design Exceptions</b>		
Request for Exception - Non-CA Projects	I-23-A	I-23- 4 0
Request for Exception - CA Projects	I-23-B	I-23- 5 0
Request for Variation - Non-CA Projects	I-23-C	I-23- 6 0
<b>Certification Acceptance</b>		
Certification Acceptance Approval and Concurrence Process	I-24-A	I-24-10 0
Response to Phase Reviews - CA Projects	I-24-B	I-24-11 0
Request for Design Variation - CA Projects	I-24-C	I-24-12 0
Special Provisions Transmittal - CA Projects	I-24-D	I-24-13 0

Revised 12/08/92

# VOLUME I

## ROADWAY DESIGN CRITERIA AND PROCESS

### INTRODUCTION

The Roadway Design Criteria and Process Manual is part of a two volume set of guidelines, standards and techniques used to develop roadway plans for the Florida Department of Transportation

This volume contains the Florida DOT's roadway design criteria, which, along with other Florida DOT publications, establish highway design policy. This manual includes both design criteria and material describing the design process.

Volume II of this manual, Plans Preparation and Assembly, was prepared to aid the technician and drafter in the development of a set of roadway plans.

Revisions, additions, deletions and interpretations to this manual will be issued quarterly following discussions at the District Design Engineers' meeting, or on an as-needed basis. Changes will be issued with instructions for insertion into this manual.

Revisions to design publications which are to be implemented sooner than the next quarterly Design Engineers' meeting will be issued as Design Bulletins. These Design Bulletins will be numbered and given an expiration date. The expiration date for Design Bulletins revising the Roadway and Traffic Design Standards will be a maximum of two years from the issue date to allow incorporation of the change in the next edition of the standards. The expiration date for Bulletins revising the other design publications will be 180 days from the issue date.



## DESIGN CRITERIA AND REFERENCES

There are many excellent publications on design criteria available to the roadway designer. The following list includes criteria manuals or publications which are required or recommended by the Department for use in the development of highway plans.

1.1 Florida Department of Transportation Published References - Unless otherwise noted, all references are available from Maps and Publications, Mail Station 12, 605 Suwannee Street, Tallahassee, FL 32399-0450 or by calling 904-488-9220.

- o Manual of Uniform Minimum Standards for Design, Construction, and Maintenance for Streets and Highways (Green Book) Adopted by Rule Number 14-15 02
- o Florida's Geometric Design Guide for Resurfacing, Restoration and Rehabilitation of Streets and Highways (3R Manual - Orange Book) Doc No. 625-010-004-a
- o Roadway and Traffic Design Standards (Roadway Design Standards) Doc No. 625-010-003
- o Policy and Guidelines for Vehicular Connections to Roads on the State Highway System (Driveway Manual) Doc No. 850-010-001-a
- o Standard Specifications for Road and Bridge Construction and Supplements
- o Bicycle Facilities Planning and Design Manual
- o CADD Roadway Standards and Guidelines  
Doc. No. 625-010-007 - Available from Office of Design, Attn. CADD Development, Mail Station 32, 904-487-1700
- o Drainage Manual - Doc No. 625-040-XXX

- o Handbook for Drainage Connection Permit  
Doc No 625-040-400 (Rule 14-86)
- o Soils and Foundations Manual  
Doc No 675-020-012-a
- o Project Development and Environmental Guidelines  
Doc No 625-010-002-a
- o Flexible Pavement Design Manual for New Construction  
and for Rehabilitation  
Doc No 625-010-002
- o Rigid Pavement Rehabilitation Manual  
Doc No 625-010-005
- o Jointed Plain Concrete Pavement Design Manual  
Doc No 625-010-006
- o R/W Survey and Mapping Manual  
Doc No 575-010-000a
- o Location Survey Manual  
Doc No 550-030-000 through 550-030-012
- o Utility Accommodation Guide  
710-020-0019 Procedure
- o Value Engineering Design Review Procedure 625-030-0029 -  
Available through Value Engineering, Mail Station 40, 904-487-  
3982
- o Basis of Estimates Manual  
Doc No 001-600-210-a
- o Contract Estimating System  
Document No. 001-600-200-a - Available only to those who have  
completed training from Estimates Office, Mail Station 39, 904-  
487-4225
- o Project Management Guidelines

- o Landscaping Guidelines  
Doc No 650-050-001b - Available from Office of Environment,  
Mail Station 37, 904-488-2911
- o Railroad Procedures Manual  
Doc No.725-080-XXX - Available from Rail Bureau, Mail Station  
25, 904-488-5704
- o Structures Design Guidelines  
Doc No 625-020-XXX - Available from Structures Office, Mail  
Station 33, 904-488-4756
- o Sample Computation Manual  
Doc No 001-600-215-a
- o Guidelines for Contract Duration  
Proc No 700-010-044-a - Available from Office of Construction,  
Mail Station 31, 904-488-4756
- o Design Traffic  
Proc. No 525-030-120-a - Available from Highway Systems  
Planning, Mail Station 27, 904-488-9745

12 American Association of State Highway and Transportation Officials  
(AASHTO) Published References

- o A Policy on Geometric Design of Highways and Streets (Policy  
on Geometrics Design)
- o Geometric Design Guide for Resurfacing, Restoration, and  
Rehabilitation (R-R-R) of Highways and Streets (Purple Book)
- o A Guide on Safety Rest Areas for the National System of  
Interstate and Defense Highways
- o A Policy on the Accommodation of Utilities on Freeway Right-  
of-Way

- o A Guide for Bicycle Routes
- o A Guide for Accommodating Utilities on Highway Rights-of-Way
- o A Policy on Access Between Adjacent Railroads and Interstate Highways
- o Roadside Design Guide
- o Standard Specifications for Structural Supports for Highway Signs, Luminaires and Traffic Signals
- o An Information Guide for Roadway Lighting
- o A Guide on Erecting Mailboxes on Highways
- o Guidelines for Value Engineering
- o A Guide for Highway Landscape and Environmental Design
- o Highway Drainage Guidelines

### 1 3 Federal Highway Administration Published References

- o Manual on Uniform Traffic Control Devices (MUTCD)
- o Standard Highway Signs
- o Handbook of Highway Safety Design and Operational Practices
- o Accommodation of Utility Plant Within the Right-of-Way of Urban Streets and Highways - FHWA-RD-75-8 and 9

### 1 4 Transportation Research Board Publications

- o Highway Capacity Manual
- o Policies for Accommodation of Utilities on Highway Rights-of-Way

## Chapter 1

### DESIGN PARAMETERS

#### 1.1 General

Designs for highway and street projects are normally based on established design standards for the various elements of the project, such as width of roadway, side slopes, horizontal and vertical alignment, drainage considerations and intersecting roads. Selection of the appropriate standards is influenced by traffic volume and composition, desired levels of service, terrain features, roadside developments, environmental considerations and other individual characteristics.

The identification of applicable design controls is basic to providing the desired level of service, optimum safety, and cost effectiveness.

## 1.2 Traffic

The existing and design year traffic volumes, the traffic composition, directional distribution and design speed are all essential elements to the calculation of highway capacity, levels of service and pavement structural designs. This traffic information must be developed and approved during the programming and Project Development and Environmental (PD&E) studies stages of each project. PD&E studies may not be performed on all projects. When that is the case the necessary traffic studies must be part of the design process.

Preliminary capacity analyses and levels of service calculations will produce the numbers and configurations of traffic lanes required for the project.

Designs shall be based upon the projected traffic volume for the expected service life of the project. The pavement design manuals should be referenced for specific information on design periods. Design Hourly Volume (DHV) shall be the 30th highest hour.

### **1.3 Capacity and Level of Service**

The AASHTO A Policy on Geometric Design of Highways and Streets and the Transportation Research Board Highway Capacity Manual provide the detailed analysis and calculation guides necessary for the number and configurations of lanes required and the resulting levels of service provided. As illustrated in those texts, gradients, roadside developments, number, spacing and types of crossings and intersections, traffic volumes, and signalization patterns all greatly influence capacity and levels of services. Those factors, in addition to the roadway functional classification, have a direct influence on the design speed to be adopted at the preliminary design level.

When the design speed and roadway functional classification (and the resulting geometric controls) have been established, the capacity and level of service analyses will have to be checked and adjusted against the more advanced determination of those variable factors outlined above. For a detailed evaluation of a roadway's level of service, a traffic operations model should be used.

#### **1.4 Roadway Functional Classification**

The AASHTO Policy on Geometric Design presents an excellent discussion on highway functional classifications. Florida Statutes, Title XXVI, Chapters 334, 335 and 336 give similar definitions, and establish classifications for road design in the State of Florida.

Those classifications serve as the basis for the "Highway Function and Classification" portion of the section on Planning in the Manual of Uniform Minimum Standards for Design, Construction, and Maintenance of Streets and Highways, known as the Florida Green Book, issued by the Florida Department of Transportation. Much of the design criteria and controls adopted by the Florida Department of Transportation are categorized by those classifications and the design speeds adopted for each of those classifications.



## 1.5 RRR Design

Interstate Highways and Freeways - Design standards applicable for these facilities are new construction standards, with the following exception The standards used for horizontal alignment, vertical alignment, and widths of median, traveled way and shoulders may be the AASHTO interstate standards that were in effect at the time of original construction or inclusion into the interstate system

State Highway System - Design standards applicable for the State Highway System facilities, other than interstate and freeways, are contained in Chapter 25 of this volume Chapter 25 provides Florida's Design Standards for Resurfacing, Restoration, and Rehabilitation (R-R-R) of Streets and Highways and replaces the 1988 RRR Manual RRR standards are generally less restrictive than criteria for new construction

## **1.6 Design Consistency and Driver Expectancy**

Design consistency is achieved when the geometric features of the roadway are consistent with the operational characteristics expected by the driver. Inconsistencies normally relate to

- o changes in design speed
- o changes in cross section
- o incompatibility in geometry and operational requirements

Changes in design speed may occur on a given stretch of roadway because portions of the highway were built as separate projects over an extended period of time. Inconsistencies may be due to a number of factors: changes in standards or DOT policy, re-classification of the facility, and lack of necessary funding.

There are two major types of design inconsistencies relative to cross section. These are point inconsistencies and a general incompatibility between cross section and alignment. A point inconsistency may be, for example, the narrowing of lane widths, a narrow bridge, a lane drop, or a change from multi-lane section to two lanes.

A cross sectional inconsistency is usually the result of upgrading a highway cross section without upgrading the alignment. Sometimes pavements are widened and shoulders added on an older two lane highway. The wider cross section on an old alignment might convey a conflicting message to the driver and lead to an inappropriate expectancy based on the visual aspects of the cross section, because cross section features can be more apparent than the alignment.

Of course, this is not to say that widening creates unsafe conditions. Widening alone can measurably improve the safety characteristics of a road, particularly on very narrow, low-volume roads. Designers should, however, be aware of potential inconsistencies that frequently can be overcome with relatively low cost treatments. In the case of widened roads on old alignments, pavement markings, warning signs, and delineation devices can be very helpful to the driver.

Inconsistencies may also relate to incompatibility in geometric and operational requirements. Occasionally elements of the design appear to have been selected for the purpose of fitting together the geometric components conveniently and economically rather than for the purpose of satisfying operational requirements. An example of an inconsistency resulting from the incompatibility is a direct entry ramp which is intended to permit vehicles to enter the stream of traffic without coming to a complete stop but which, in reality, forces the vehicle to stop when a gap in the traffic stream is not immediately available.

Design inconsistencies can result in driver uncertainty, an increase in response time and an increase in the probability of inappropriate driver response.

Driver expectancy relates to the readiness of the driver to respond to events, situations, or the presentation of information. It can be defined as an inclination, based on previous experience, to respond in a set manner to a roadway or traffic situation. It should be stressed that the initial response is to the expected situation rather than the actual one.

Expectancy can affect the perception and use of information. In most circumstances, the expected and actual conditions are the same. However, when design inconsistencies occur and a driver's expectancy is incorrect, it takes longer to respond properly, there may be no response, or the response may be inappropriate to actual conditions.

There are certain elements in the design of various components of the roadway which particularly affect design consistency, driver expectancy, and vehicular operation. These components include horizontal and vertical alignment, embankments and slopes, shoulders, crown and cross slope, superelevation, bridge widths, signing and delineation and guardrail.

## 1.7 Aesthetics

Highways are built first and foremost for functional purposes, but the designer should be sensitive to how the highway will be perceived by the users. Designing-in aesthetics is more than just providing for landscape plantings. The roadway should blend into the landscape, avoiding large cuts and fills, and round side slopes into the existing terrain. Horizontal and vertical alignment should be coordinated so that a driver has an opportunity to gain a sense of the local environment. Combinations of horizontal and crest vertical curves, and broken-back curves should be avoided. Excessively long tangent sections become monotonous. Either curvature or other features should be added to maintain drivers interest.

Application of the clear zone concept discussed in Chapter 4 of this volume will result in a clean, uncluttered and pleasing roadside. Landscaping of the roadside should be considered early in the design process, so that plantings blend in with the geometric design. Chapter 9 of this volume discusses landscape design criteria. At times extra right-of-way may be obtained for treatments if the need is identified early. Retention/detention ponds and other wetlands can be attractive if well-designed and placed in a location where they can be viewed from the roadway.

Vistas of exceptional beauty should be accentuated by the roadway geometrics. Ideally, such vistas should be on the outside of horizontal curves, without excessive roadside appurtenances and signs to clutter the view.

"Streetscaping" techniques in urban areas include an emphasis on pedestrian accommodation, trees and other plantings, access control, careful signing, and zoning restrictions on commercial signs. Parkways, and other roads specifically intended for pleasing aesthetics should be designed by a multi-disciplined team including landscape architects and planners.

## **1.8 Access Management**

| Unregulated access to the State Highway System was determined to be one of the  
| contributing factors to congestion and functional deterioration of the system Regulation  
| of access was necessary to preserve the functional integrity of the State Highway System  
| and to promote the safe and efficient movement of people and goods within the state  
| Under F S 335 18, the Legislature authorized the Department to develop rules to  
| administer the "State Highway System Access Management Act " These are Rule 14-96  
| and 14-97 Each district has assigned various offices the responsibility to permit  
| connections and administer other parts of the program In order to adhere to the  
| program, the designer must be familiar with the statute, the rules and the district  
| program In addition to driveway connections, features such as median openings affect  
| safe and efficient operation It is critical that the designer know what access classification  
| has been assigned to the highway segment under design and to determine what roadway  
| features and access connection modifications are appropriate to adhere to the program

| During the development of construction plans, the designer should evaluate the access  
connections within the project limits Driveways and crossovers should be considered in  
the analysis of safety and operational problems Modifications or closures to access may  
be the solution in certain cases Rule 14-96 003 (3) & (4) and 14-96 015 gives the  
Department the authority to alter, relocate or replace connections in order to meet current  
Department standards Furthermore, Section 14-96 011 of the Rule allows the DOT to  
revoke a permit "if the connection causes a safety or operational problem on the State  
Highway System substantiated by an engineering study "

Rule 14-97 also provides guidance on the treatment of existing features in the highway  
improvement process

14-97 003(1)(b)

(b) For the purpose of the interim standards for the assignment of an access classification to a segment of highway by the Department pursuant to Rule 14-97 004, permitted connections and those unpermitted connections exempted pursuant to Section 335 187(1), Florida Statutes, and existing median openings, and signals are not required to meet the interim standards of the assigned classification Such features will generally remain in place. These features shall be brought into reasonable conformance with the standards of the assigned classification or the interim standards where new connection permits are granted for significant changes in property use, or as changes to the roadway design allow Applicants issued permits based on the interim standards as set forth in Rule 14-97 004 shall not have to reapply for a new permit after formal classification of the roadway segment unless significant change pursuant to Rule Chapter 14-96 and Rule 14-97 002 has occurred

Existing connections that are to remain are not required to be shown on the plans, but are to be reconstructed at their existing location in conformance to standards Those that are to be altered or closed must be detailed in the plans In some cases where revisions are necessary due to operational or safety problems, it may not be possible to totally upgrade the connection to the newest standards because of existing conditions or constraints In these cases, the designer should provide the best solution possible The designers' efforts should be coordinated with those responsible for access connection permitting in the District (i e , the District Permits Engineer) and those responsible for access management highway classification (i e , District Planning) Any changes or revocation of a connection must be made in accordance with Rule 14-96 011

| Every owner of property which abuts a road on the State Highway System has a right to  
| reasonable access to the abutting state highway but does not have a right to unregulated  
| access to such highway. A means of reasonable access cannot be denied except on the  
| basis of safety and operational concerns as provided in s. 335.184. Nothing in s. 335.184  
| limits the Department's authority to restrict the operational characteristics of a particular  
| means of access. Service roads provide reasonable access. Corner property can be given  
| direct access by a "right-in" and/or "right-out" connection to the highway. More  
| restricted access must be supported by a study that documents safety and operational  
| problems.

| It should be noted that if there are any conflicts between these guidelines and the statute  
| and rules, the statute and rules shall govern.



## Chapter 2

### ROADWAY DESIGN CRITERIA

#### Contents

#### Part I - Criteria

<b>2.0</b>	<b>Introduction</b>	I-2-1 0
	Table 2 0 1 - Standards for Low & High Volume Roadways	
<b>2.1</b>	<b>Lanes</b>	
	Table 2 1 1 - Lane Widths	Approved 12/08/93
	Table 2 1 2 - Lane Widths	Approved 12/08/93
	Table 2 1 3 - Ramp Pavement Widths	Approved 12/08/93
	Figure 2 1 1 - Standard Pavement Cross Slopes	Approved 12/08/93
<b>2.2</b>	<b>Medians</b>	
	Table 2 2 1 - Median Widths	Approved 12/08/93
<b>2.3</b>	<b>Shoulders</b>	
	Table 2 3 1 - Shoulder Widths and Slopes	Approved 12/08/93
	Table 2 3 2 - Shoulder Widths and Slopes	Approved 12/08/93
	Table 2 3 3 - Shoulder Widths and Slopes	Approved 12/08/93
	Table 2 3 4 - Shoulder Widths and Slopes	Approved 12/08/93
	Figure 2 3 1 - Shoulder Superelevation	Approved 12/08/93
	Figure 2 3 2 - Typical Paving Under Bridge Structures for Outside Shoulders	Approved 12/08/93
<b>2.4</b>	<b>Roadside Slopes</b>	
	Table 2 4 1 - Roadside Slopes	Approved 12/08/93
<b>2.5</b>	<b>Borders (Pending)</b>	
<b>2.6</b>	<b>Grades</b>	
	2 6 1 - Criteria for Grade Datum	Approved 12/08/93
	2 6 2 - Length of Grade on C&G Sections	Approved 12/08/93

	2 6 3 - Grades on C&G Sections	Approved 12/08/93
	Table 2 6 1 - Maximum Grades	Approved 12/08/93
	Table 2 6 2 - Maximum Change in Grade w/o VC	Approved 12/08/93
<b>2.7</b>	<b>Sight Distance</b>	
	Table 2 7 1 - Minimum Stopping Sight Distance	Approved 12/08/93
	Table 2 7 2 - Minimum Passing Sight Distance	Approved 12/08/93
<b>2.8</b>	<b>Curves</b>	
	Table 2 8 1 - Maximum Deflections without Horizontal Curves	Approved 12/08/93
	Table 2 8 2 - Length of Horizontal Curves	Approved 12/08/93
	Table 2 8 3 - Maximum Degree of Horizontal Curve	Approved 12/08/93
	Table 2 8 4 - Maximum Horizontal Curvature w/o Superelevation	Approved 12/08/93
	Table 2 8 5 - Minimum Lengths of Crest Vertical Curves Based on Stopping Sight Distance	Approved 12/08/93
	Table 2 8 6 - Minimum Lengths of Sag VC Based on Stopping Sight Distance & Headlight Sight Distance	Approved 12/08/93
<b>2.9</b>	<b>Superelevation</b>	
	Table 2 9 1 - Superelevation for Rural Highways, Urban Freeways, and High Speed Urban Highways	Approved 12/08/93
	Figure 2 9 1 - Superelevation Rates for Rural Highways, Urban Freeways, and High Speed Urban Highways	Approved 12/08/93
	Table 2 9 2 - Superelevation for Urban Highways and High Speed Urban Streets	Approved 12/08/93
	Figure 2 9 2 - Superelevation Rates (e) for Urban Highway and High Speed Urban Streets	Approved 12/08/93
	Table 2 9 3 - Superelevation Transition Slope Rates for Rural Highways, Urban Freeways and High Speed Urban Highways	Approved 12/08/93
	Table 2 9 4 - Superelevation Transition Slope Rates for Urban Freeways and High Speed Urban Streets	Approved 12/08/93

<b>2.10</b>	<b>Vertical Clearance</b>	
	Table 2 10 1 - Vertical Clearance for Bridges	Approved 12/08/93
	2 10 2 - Signs	Approved 12/08/93
	2 10 3 - Signals	Approved 12/08/93
<b>2.11</b>	<b>Horizontal Clearance</b>	
	Table 2 11 1 - Horizontal Clearance for Traffic	
	Control Signs	Approved 12/08/93
	Table 2 11 2 - Horizontal Clearance for Light Poles	Approved 12/08/93
	Table 2 11 3 - HC for Utility Poles, Fire Hydrants, etc	Approved 12/08/93
	Table 2 11 4 - HC to Mailboxes	Approved 12/08/93
	Table 2 11 5 - HC to Signal Poles and Controller Cabinets	
		Approved 12/08/93
	Table 2 11 6 - HC to Trees	Approved 12/08/93
	Figure 2 11 1 - Horizontal Clearance to Guardrail	Approved 12/08/93
<b>2.12</b>	<b>Clear Zones</b>	
	Table 2 12 1 - Clear Zone Widths	Approved 12/08/93
	Table 2 12 2 - Clear Zone Widths on Curved Alignments on	
	Highways with Flush Shoulders	Approved 12/08/93
<b>2.13</b>	<b>Lighting Criteria</b>	
	Table 2 13 1 - Conventional Lighting - Roadways	Approved 12/08/93
	Table 2 13 2 - Highmast Lighting - Roadways	Approved 12/08/93
	Table 2 13 3 - Underdeck Lighting - Roadways	Approved 12/08/93
	Table 2 13 4 - Rest Area Lighting	Approved 12/08/93
	Table 2 13 5 - Mounting Height Restrictions	Approved 12/08/93

## CHAPTER 2

### ROADWAY DESIGN CRITERIA

#### 2.0 Introduction

In the application of this criteria the following definitions are assigned for consistency of understanding and interpretation

1 Arterials Divided or undivided, relatively continuous routes that primarily serve through traffic, high traffic volumes, and long average trip lengths Traffic movement is of primary importance, with abutting land access of secondary importance Arterials include expressways without full control of access, US numbered routes and principal state routes May be classified as urban or rural

2 Auxiliary Lane The designated widths of roadway pavement marked to separate speed change, turning, passing and climbing maneuvers from through traffic They may also provide short capacity segments

3 C-D Roads Collector-Distributor Roads are limited access roadways provided within a single interchange, or continuously through two or more interchanges on a freeway segment They provide access to and from the freeway, reduce and control the number of ingress and egress points on the through freeway They are similar to continuous frontage roads except that access to abutting property is not permitted

4 Collectors Divided or undivided routes which serve to link arterial routes with local roads or major traffic generators They serve as transition link between mobility needs and land use needs Collectors include minor state routes, major county roads, and major urban and suburban streets

5 Freeways Divided arterial highways, with full control of access. Movement of traffic free of interference and conflicts is of primary importance. Essential elements include medians, grade separations, interchanges, and in some cases, frontage roads. Freeways include Interstate, toll road and expressway systems. May be classified as urban or rural.

6 HOV Lane Special designated widths of pavement marked to provide travel lanes for high occupancy vehicles (HOV). They may be directly adjacent to other travel lanes or separated.

7 Local Roads Routes which provide high access to abutting property, low average traffic volumes, short average trip lengths and on which through traffic movements are not of primary importance. Local roads include minor county roads, minor urban and suburban subdivision streets, and graded or unimproved roads.

8 Rural Areas Places outside the boundaries of concentrated populations that accommodate higher speeds, longer trip lengths and freedom of movement, and are relatively free of street and highway networks. Rural environments are surroundings of similar characteristics.

9 Streets The local system which provides direct access to residential neighborhoods and business districts, connect these areas to the higher order road systems and offers the highest access to abutting property, sometimes deliberately discouraging through-traffic movement and high speeds.

Note: Local roads and streets are not generally a part of the State Highway System and therefore, may not be governed by the FDOT roadway design criteria, but by the Manual of Uniform Minimum Standards for Design, Construction and Maintenance for Streets and Highways.

10 Traffic Lane The designated widths of roadway pavement marked to separate opposing traffic or vehicles traveling in the same direction. Traffic lanes include through travel lanes,

auxiliary lanes, turn lanes, weaving, passing, and climbing lanes. They provide space for passenger cars, trucks, buses, recreational vehicles and bicycles.

11 Travel Lane The designated widths of roadway pavement marked to carry through traffic and to separate it from opposing traffic or traffic occupying other traffic lanes. Generally, travel lanes equate to the basic number of lanes for a facility.

12 Urban Areas Places within boundaries of concentrated populations, where density of street and highway networks, travel speeds, nature and composition of vehicles and pedestrian traffic dictate street and highway characteristics that promote lower speeds, better circulation movements, more delineation and traffic guidance devices, shorter trip lengths and provisions for pedestrians and bicycles. Urban environments are surroundings of similar characteristics.

13. Urbanized Areas Transitional zones between rural and urban areas, with characteristics approaching or similar to urban areas.

14. High Speed Descriptive term used to summarize all conditions governing the selection of Design Speeds of 50 mph or greater.

15 Low Speed Descriptive term used to summarize all conditions governing the selection of Design Speed of 45 mph or less.

16 Low Volume and High Volume Descriptive term used to describe certain operating characteristics and driver expectancy on highways. Criteria for some elements are selected according to these qualifying controls. Standards for these controls are given in Table 2.0.1.

17 Truck Traffic When significant, heavy, substantial, high percent, etc. truck traffic is used as a qualifying control, it shall mean 10% of the AADT or 10% of the daily count (24 hr).

**STANDARDS FOR LOW AND HIGH VOLUME HIGHWAYS  
IN ANNUAL AVERAGE DAILY VOLUMES**

HIGHWAY TYPE	LOW VOLUME AADT	HIGH VOLUME AADT
<b>FREEWAY - URBAN</b>		
4-LANE FACILITY	57,000	69,000
6-LANE FACILITY	86,000	103,000
8-LANE FACILITY	114,000	138,000
<b>FREEWAY - RURAL</b>		
4-LANE FACILITY	46,000	56,000
6-LANE FACILITY	69,000	83,000
8-LANE FACILITY	92,000	111,000
<b>ARTERIALS - URBAN</b>		
2-LANE FACILITY	16,000	20,000
4-LANE FACILITY	37,000	43,000
6-LANE FACILITY	55,000	64,000
8-LANE FACILITY	69,000	80,000
<b>ARTERIALS - RURAL</b>		
2-LANE FACILITY	9,000	14,000
4-LANE FACILITY	38,000	47,000
6-LANE FACILITY	58,000	71,000
<b>COLLECTOR - URBAN</b>		
2-LANE FACILITY	11,000	16,000
4-LANE FACILITY	37,000	45,000
<b>COLLECTOR - RURAL</b>		
2-LANE FACILITY	8,000	13,000
4-LANE FACILITY	30,000	38,000
<b><u>LOW VOLUME</u></b>	FACILITIES ARE HIGHWAY TYPES WITH PROJECTED DESIGN YEAR <u>AADT</u> VOLUME EQUAL TO OR LESS THAN THE LOW VOLUME VALUES SHOWN	
<b><u>HIGH VOLUME</u></b>	FACILITIES ARE HIGHWAY TYPES WITH PROJECTED DESIGN YEAR <u>AADT</u> VOLUME EQUAL TO OR GREATER THAN THE HIGH VOLUME VALUES SHOWN	

TABLE 2 0 1

## 2.0 Introduction - Continued

The implementation of design criteria is outlined in the following text

1 Roadway Design Criteria The roadway design criteria presented in this manual are intended as the principle source of criteria for the design of new or major reconstruction projects on the Florida State Highway System

These criteria are presented by subject for major design elements in the form of fixed values or a range of acceptable values as defined by qualifiers

Where design criteria appear in the Roadway and Traffic Design Standards, it will be consistent with the criteria in this manual. Some criteria will remain in the other chapters of the Plans Preparation Manual until the Roadway Design Criteria section is completed. When conflicts are discovered they should be brought to the attention of the State Roadway Design Engineer for resolution.

Design criteria for resurfacing, restoration, and rehabilitation (RRR) is presented in a separate chapter of this manual and is applicable only on programmed RRR projects.

2 Design Controls Design controls are characteristics and conditions that influence or regulate the selection of the criteria for project standards. It is the designer's responsibility to recognize and apply those controls applicable to the project.

3 Design Standards The specific values selected from the roadway design criteria become the design standards for a design project. These standards will be identified and documented by the designer.



4 Project Parameters The properties or specific conditions with limits which require modification of design standards within these limits. The designer is responsible for establishing and documenting any project parameters and their limits, as part of the justification for variations to project standards.

## 2.1 Lanes

LANE WIDTHS ( FEET )						
FACILITY		THROUGH OR TRAVEL	AUXILIARY			
TYPE	AREA		SPEED CHANGE	TURNING (LT/RT/MED)	PASSING	CLIMBING
FREEWAY	Rural	12	12	—	—	12
	Urban	12	12	—	—	12
ARTERIAL	Rural	12	12	12 <sub>4</sub>	12	12
	Urban	12 <sub>1</sub>	12 <sub>1</sub>	12 <sub>1,4</sub>	12 <sub>1</sub>	12
COLLECTOR	Rural	11 <sub>2</sub>	11 <sub>2</sub>	11 <sub>2,4</sub>	11 <sub>2,5</sub>	12
	Urban	11 <sub>3</sub>	11 <sub>3</sub>	11 <sub>3,4</sub>	11 <sub>3</sub>	12

1 11' permitted if one of these conditions exist.

- R/W and existing conditions are stringent controls
- Facility operates on interrupted flow conditions
- Design speed 40 mph or less
- Intersection capacity not adversely affected
- Truck volume 10% or less

2 12' lanes for 2-lane rural where

Design ADT (2-Way)	Design Speed
400-749	≥ 65
750-1199	> 45
1200 or more	All

3 12' lanes in industrial areas when R/W is available

4 With severe R/W controls, 10' turning lanes may be used where speeds are 40 mph or less and the intersection is controlled by traffic signals. Median turn lanes shall not exceed 15'

5 12' when truck volume more than 10%.

LANE WIDTHS  
Table 2.1.1

## 2.1 Lanes

LANE WIDTHS (FEET)					
FACILITY		SPECIAL			
TYPE	AREA	HOV, <sup>1</sup>	BICYCLE	OFF SYSTEM DETOUR	URBAN MULTI-PURPOSE <sup>5</sup>
FREEWAY	Rural	12	—	11 <sub>4</sub>	—
	Urban	12	—	11 <sub>4</sub>	—
ARTERIAL	Rural	12	5 <sub>2</sub>	11	—
	Urban	12	4 <sub>3</sub>	11	8 <sub>6</sub>
COLLECTOR	Rural	—	5 <sub>2</sub>	11	—
	Urban	—	4 <sub>3</sub>	11	8 <sub>6</sub>

1. Separated or concurrent flow.
2. Designated shoulder pavement
3. Designated or undesignated.
4. For Interstate highway detours, at least one 12' lane must be provided in each direction
5. Urban multi-purpose lanes are usually used as refuge lanes but may be used for loading zones, bus stops, emergency access and other purposes. Parking that adversely impacts capacity or safety is to be eliminated whenever practical. Parking lane width is measured from face of curb. Portions of multi-purpose lanes that are reserved for parking and access isles for the physically handicapped shall have cross slopes not exceeding 1:50 (0.02) in all directions
6. 10' to 12' lanes for commercial and transit vehicles

LANE WIDTHS  
Table 2.1.2

## 2.1 Lanes

<b>RAMP WIDTH (FEET) RAMP PROPER (ONE WAY)</b>			
<b>RADIUS (Radius To Inside Of Curve)</b>	<b>1-LANE (All Design Vehicles)</b>	<b>2-LANES (P &amp; SU Vehicles)</b>	<b>2-LANES (Combination-Type Vehicle And Buses)</b>
50	23	29	—
75	19	27	—
100	18	26	—
150	17	25	31
200	16	25	29
300	16	24	28
400	16	24	28
500+	15	24	28

*These widths include adjustments for standard shoulder and/or curb edge of pavement treatments; no further adjustments are needed*

**RAMP PAVEMENT WIDTHS**  
*Table 2.1.3*

## 2.1 Lanes

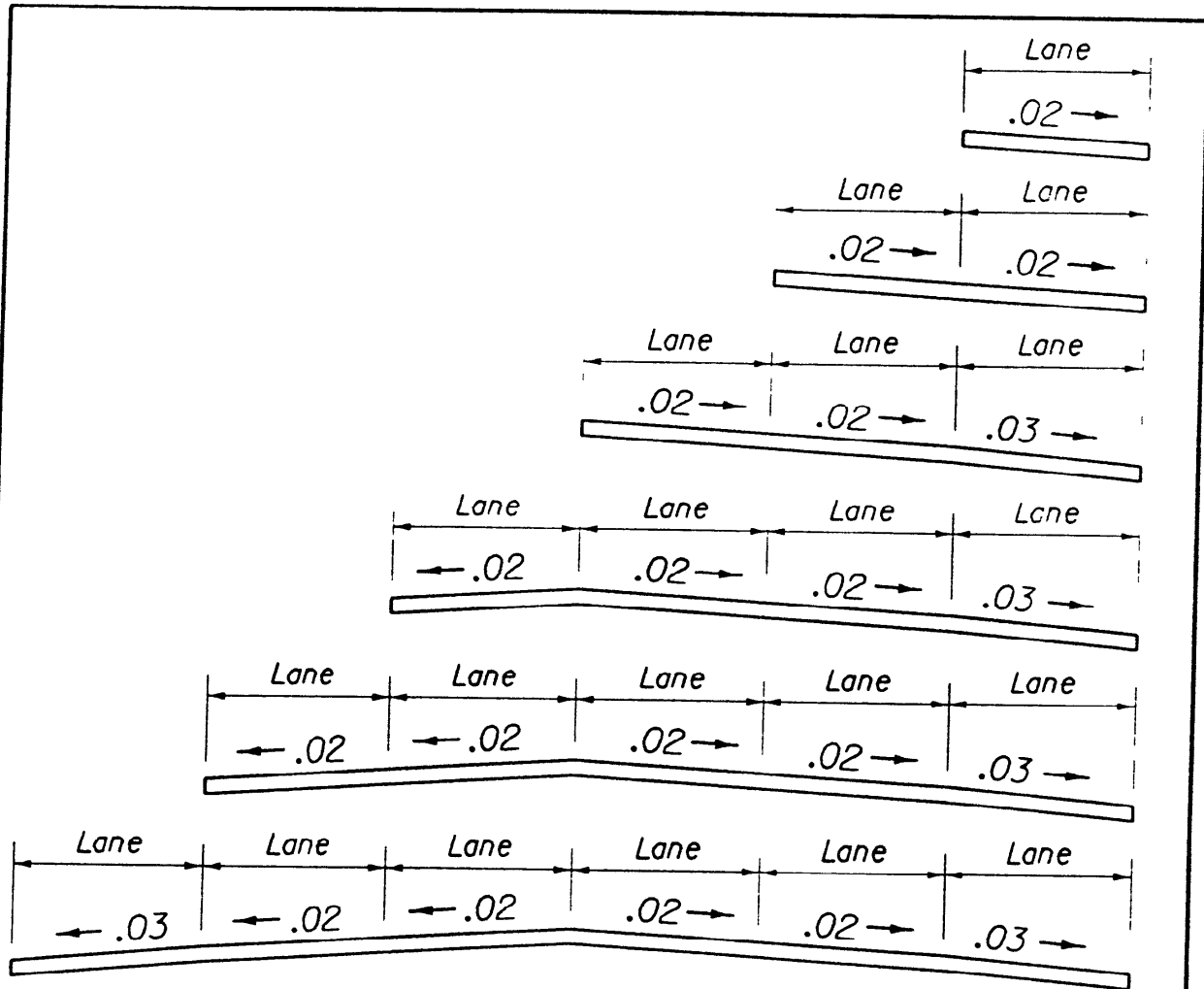

### ALL LANES ONE DIRECTION

*These sections show only the standard slopes for adjoining lanes; they do not prescribe needed lanes, lane usage, or typical section requirements other than lane slope. These slopes are not applicable to parabolic crowns.*

*Maximum pavement cross slopes on tangent sections are:*

*0.04 for design speeds of 45 mph or less.*

*0.03 for design speeds greater than 45 mph*

*The change in cross slope between adjacent through lanes shall not exceed 0.04.*

### STANDARD PAVEMENT CROSS SLOPES

Figure 2.1.1

## 2.2 Medians

MEDIAN WIDTHS ( FEET )	
TYPE FACILITY	WIDTH
<b>FREEWAYS</b>	
<i>Interstate, Without Barrier</i>	64 <sub>1</sub>
<i>Other Freeways, Without Barrier</i>	
<i>Design Speed ≥ 60 MPH</i>	60
<i>Design Speed &lt; 60 MPH</i>	40
<i>All, With Barrier, All Design Speeds</i>	26 <sub>2</sub>
<b>ARTERIALS AND COLLECTORS</b>	
<i>Design Speed ≥ 55 MPH</i>	40
<i>Design Speed &lt; 55 MPH</i>	22 <sub>3</sub>
<i>Paved and painted for left turns</i>	12 <sub>4</sub>
<ol style="list-style-type: none"> <li>1. 88' when future lanes planned.</li> <li>2. Based on 2' wide median barrier and 12' shoulders.</li> <li>3. On reconstruction projects where existing curb locations are fixed due to severe right of way constraints, the minimum width may be reduced to 19 5' for Design Speed = 45 mph, and to 15 5' for Design Speed ≤ 40 mph.</li> <li>4. Restricted to 5-lane sections with design speed ≤ 40 mph. On reconstruction projects where existing curb locations are fixed due to severe right of way constraints, the minimum width may be reduced to 10'.</li> </ol>	

**MEDIAN WIDTHS**  
Table 2.2.1

## 2.3 Shoulders

HIGHWAY TYPE		WIDTHS (FEET)								SLOPES			
		WITHOUT SHOULDER GUTTER				WITH SHOULDER GUTTER							
		FULL WIDTH		PAVED WIDTH		FULL WIDTH		PAVED WIDTH		NORMAL <input checked="" type="checkbox"/>			
		Outside	Median Or Left	Outside	Median Or Left	Outside	Median Or Left	Outside	Median Or Left	Outside	Median Or Left		
FREEWAYS (Lanes One Way)	4-Lane Or More	12	12	10	10	15.5	15.5	8	8	06	06		
	3-Lane	12	12	10	10	15.5	15.5	8	8		05		
	2-Lane	12	8	10	4	15.5	13.5	8	6				
	HOV Lane	NA	14	NA	10	NA	NA	NA	NA	NA	05 <sup>☆</sup>		
	1-Lane Ramp	6	6	4	2	11.5	11.5	4 <sup>Δ</sup>	4	06	05		
	2-Lane Ramp Non-Interstate	10	8	8	4	15.5	13.5	8	6				
	2-Lane Ramp Interstate	12	8	10	4	15.5	13.5	8	6				
	C-D Road 1-Lane	6	6	4	2	11.5	11.5	4	4				
	C-D Road 2-Lane	12	8	10	4	15.5	13.5	8	6				
	C-D Road 3-Lane	12	12	10	10	15.5	15.5	8	8				
	C-D Road > 3-Lane	12	12	10	10	15.5	15.5	8	8				06
	Auxiliary Lane Climbing & Weaving	12	NA	10	NA	15.5	NA	8	NA				NA
	Auxiliary Lane Mainline Terminal 1-Lane Ramp	8	NA	6	NA	11.5	NA	4	NA				NA
Auxiliary Lane Mainline Terminal 2-Lane Ramp	12	NA	10	NA	15.5	NA	8	NA				NA	
Frontage Road	See COLLECTORS Table 2.3.4 For Local Roads And Streets See The FDOT 'Manual Of Uniform Minimum Standards For Design, Construction And Maintenance For Streets And Highways'												

Shoulders shall extend 4' back of shoulder gutter and have a 0.06 slope back toward the gutter

☆ 0.06 when 4 lanes or more combined

Δ Shoulder pavement less than 6' in width and adjoining shoulder gutter shall be the same type, depth and slope as the ramp pavement

### SHOULDER WIDTHS AND SLOPES

Table 2.3.1

## 2.3 Shoulders

HIGHWAY TYPE		WIDTHS (FEET)								SLOPES		
		WITHOUT SHOULDER GUTTER				WITH SHOULDER GUTTER				NORMAL <sup>■</sup>		
		FULL WIDTH		PAVED WIDTH		FULL WIDTH		PAVED WIDTH		Outside	Median Or Left	
		Outside	Median Or Left	⊙ Outside	⊙ Median Or Left	Outside	Median Or Left	Outside	Median Or Left			
ARTERIALS Divided (Lanes One Way)	4-Lane	12 10 8	12 10 8	10 4 ⊙ 4 ⊙	4 4 4	15 5 15 5 13 5	15 5 15 5 13 5	8 8 6	8 8 6	06	05	
	3-Lane	12 10 8	12 10 8	10 4 ⊙ 4 ⊙	0 ⊙ 0 ⊙ 0 ⊙	15 5 15 5 13 5	15 5 15 5 13 5	8 8 6	8 8 6			
	2-Lane	12 10 8	8 8 6	10 4 ⊙ 4 ⊙	0 ⊙ 0 ⊙ 0 ⊙	15 5 15 5 13 5	13 5 13 5 11 5	8 8 6	6 6 4			
	1-Lane Ramp	6	6	4 ⊙	2	11 5	11 5	4 <sup>△</sup>	4			
	2-Lane Ramp	10	8	4 ⊙	2	15 5	13 5	8	6			
	C-D Road 1-Lane	6	6	4 ⊙	2	11 5	11 5	4 ⊙	4			
	C-D Road 2-Lane	8	6	4 ⊙	0	13 5	11 5	6	4			
	Auxiliary Lane Climbing And Weaving	Same As Travel Lanes	NA	Same As Travel Lanes	NA	Same As Travel Lanes	NA	Same As Travel Lanes	NA	NA	NA	NA
	Auxiliary Lane Mainline Terminals 1-Lane Ramp 2-Lane Ramp	8 12	NA NA	6 10	NA NA	11 5 15 5	NA NA	4 8	NA NA	NA NA	NA NA	NA NA
	Auxiliary Lane At-Grade Intersection	Same As Travel Lanes	Same As Travel Lanes	6 <sup>△</sup>	0	11 5	NA	4	NA	05-06	05-06	
Frontage Road	See COLLECTORS Table 2 3 4 For Local Roads And Streets See The FDOT 'Manual Of Uniform Minimum Standards For Design Construction And Maintenance For Streets And Highways'											

■ Shoulders shall extend 4' back of shoulder gutter and have a 0 06 slope back toward the gutter  
 △ Shoulder pavement less than 6' in width and adjoining shoulder gutter shall be the same type, depth and slope as the ramp pavement  
 ▲ Can be reduced to match travel lane shoulder pavement  
 ⊙ Shoulder shall be paved full width through rail-highway at grade crossings, extending a minimum distance of 25' on each side of the crossing measured from the outside rail For additional information see Standard Index No 17882  
 ● Paved 2 feet wide where turf is difficult to establish Paved 4' wide (a) in sag vertical curves, 100' minimum either of the low point, and (b) on the low side of superelevated traffic lanes extending through the curves and approximately 300' beyond the PC and PT  
 ☆ 5' for designated bike lane

x — High Volume High Speed And/Or High Percent Trucks  
 x — Normal  
 x — Low Volume Roads

LEGEND FOR VALUES

SHOULDER WIDTHS AND SLOPES  
Table 2.3.2



## 2.3 Shoulders

HIGHWAY TYPE		WIDTHS (FEET)				SLOPES
		WITHOUT SHOULDER GUTTER		WITH SHOULDER GUTTER		
		FULL WIDTH	PAVED WIDTH <sup>⊙</sup>	FULL WIDTH	PAVED WIDTH	NORMAL <sup>■</sup>
ARTERIALS Undivided (Lanes Two-Way)	Multi-Lane <sup>⊕</sup>	12	10	15.5	8	0.06
		10	4 ⚙	15.5	8	
		8	4 ⚙	13.5	6	
	2-Lane	12	10	15.5	8	
		10	4 ⚙	15.5	8	
		8	4 ⚙	13.5	6	
	Auxiliary Lane At-Grade Intersection	Same As Travel Lanes	6 <sup>△</sup>	11.5	4	
	Frontage Road	See COLLECTORS Table 2.3.4 For Local Roads And Streets See The FDOT 'Manual Of Uniform Minimum Standards For Design Construction And Maintenance For Streets And Highways'				

■ Shoulders shall extend 4' back of shoulder gutter and have a 0.06 slope back toward the gutter  
 ⊙ Shoulder shall be paved full width through rail-highway at grade crossings, extending a minimum distance of 25' on each side of the crossing measured from the outside rail. For additional information see Standard Index No. 17882.  
 △ Can be reduced to match travel lane shoulder pavement.  
 ⊕ All multi-lane facilities shall conform to the Department "Multilane Facilities Median Policy", Topic No. 000-625-015.  
 ⚙ 5' for designated bike lane.

High Volume High Speed  
 And/Or High Percent Trucks  
 Normal  
 Low Volume Roads

LEGEND FOR VALUES

**SHOULDER WIDTHS AND SLOPES**  
Table 2.3.3

## 2.3 Shoulders

HIGHWAY TYPE		WIDTHS ( FEET )								SLOPES	
		WITHOUT SHOULDER GUTTER				WITH SHOULDER GUTTER					
		FULL WIDTH		PAVED WIDTH		FULL WIDTH		PAVED WIDTH		NORMAL <input checked="" type="checkbox"/>	
		Outside	Median Or Left	Outside <sup>⊙</sup>	Median Or Left	Outside	Median Or Left	Outside	Median Or Left	Outside	Median Or Left
COLLECTORS <i>Divided ( Lanes One-Way )</i>	3-Lane	12 10 8	12 10 8	10 4 ⚙ 4 ⚙	0 ⊕ 0 ⊕ 0 ⊕	15 5 15 5 13 5	15 5 15 5 13 5	8 8 6	8 8 6	06	05
	2-Lane	12 10 8	8 8 6	10 4 ⚙ 4 ⚙	0 ⊕ 0 ⊕ 0 ⊕	15 5 15 5 13 5	13 5 15 5 11 5	8 8 6	6 6 4		
	Auxiliary Lane At-Grade Intersection	Same As Travel Lanes	Same As Travel Lanes	6 <sup>△</sup>	4	11 5	NA	4	NA		
COLLECTORS <i>Undivided ( Lanes Two-Way )</i>	Multi-Lane <sup>⊕</sup>	12 10 8		4 ⚙ 4 ⚙ 4 ⚙		15 5 15 5 11 5		8 8 6		06	
	2-Lane	12 10 8		4 ⚙ 4 ⚙ 4 ⚙		15 5 15 5 11 5		8 8 6			
	Auxiliary Lane At-Grade Intersection	Same As Travel Lanes	Same As Travel Lanes			11 5		4			

Shoulders shall extend 4' back of shoulder gutter and have a 0 06 slope back toward the gutter  
<sup>△</sup> Can be reduced to match travel lane shoulder pavement  
<sup>⊙</sup> Shoulder shall be paved full width through rail-highway at grade crossings, extending a minimum distance of 25' on each side of the crossing measured from the outside rail For additional information see Standard Index No 17882  
<sup>⊕</sup> The median shoulder may be paved 2' wide in areas of the State where establishing and maintaining turf is difficult, however, shoulders shall be paved 4' wide (a) in sag vertical curves, 100' minimum either side of the low point, and (b) on the low side of superelevated traffic lanes, extending through the curve and approximately 300' beyond the PC and PT.  
<sup>⊕</sup> All multi-lane facilities shall conform to the Department "Multilane Facilities Median Policy", Topic No 000-625-015  
<sup>⚙</sup> 5' for designated bike lane

High Volume, High Speed  
And/Or High Percent Trucks

Normal

Low Volume Roads

LEGEND FOR VALUES

### SHOULDER WIDTHS AND SLOPES

Table 2.3.4

## 2.3 Shoulders

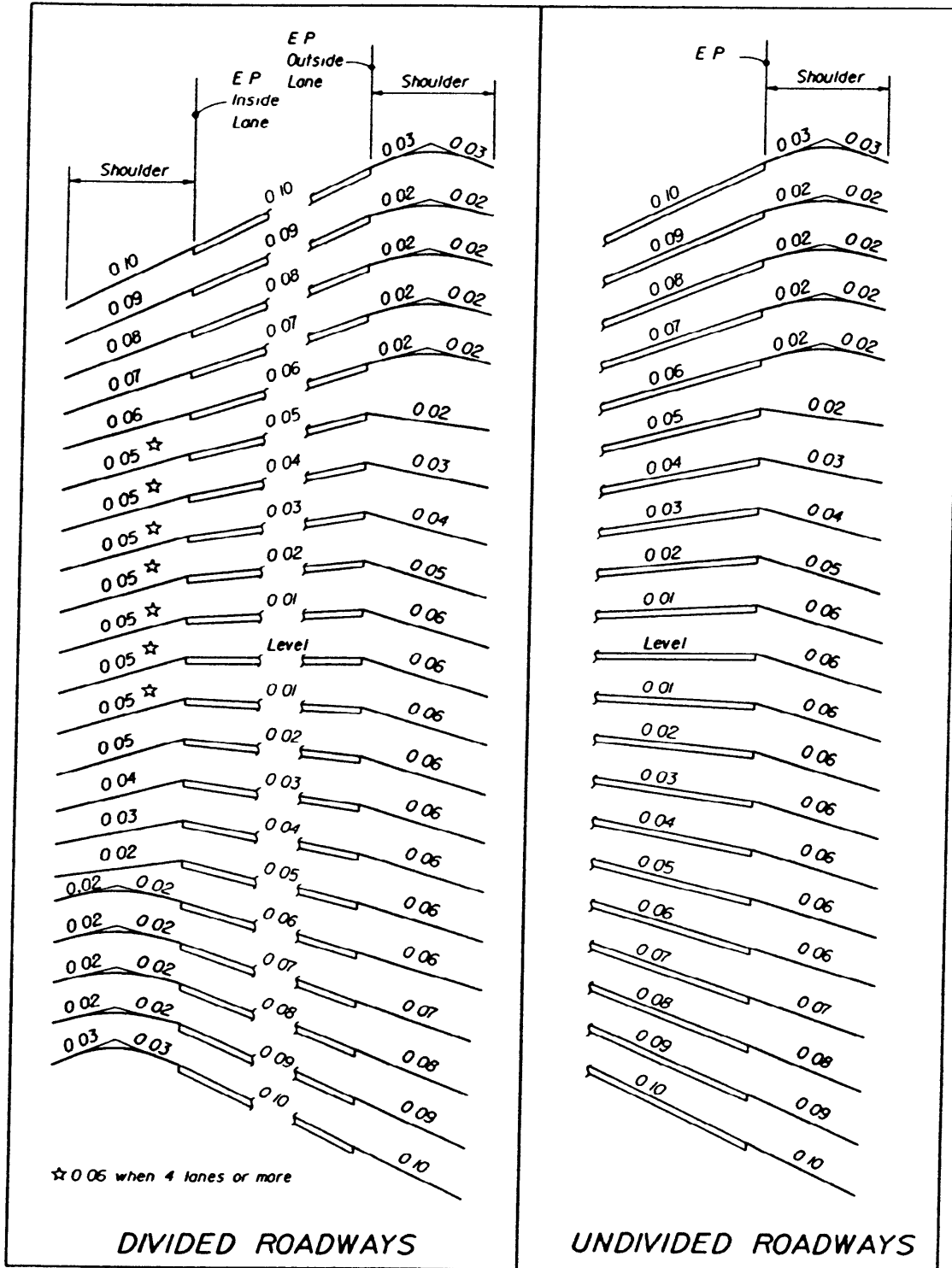

### SHOULDER SUPERELEVATION

Figure 2.3.1

## 2.3 Shoulders

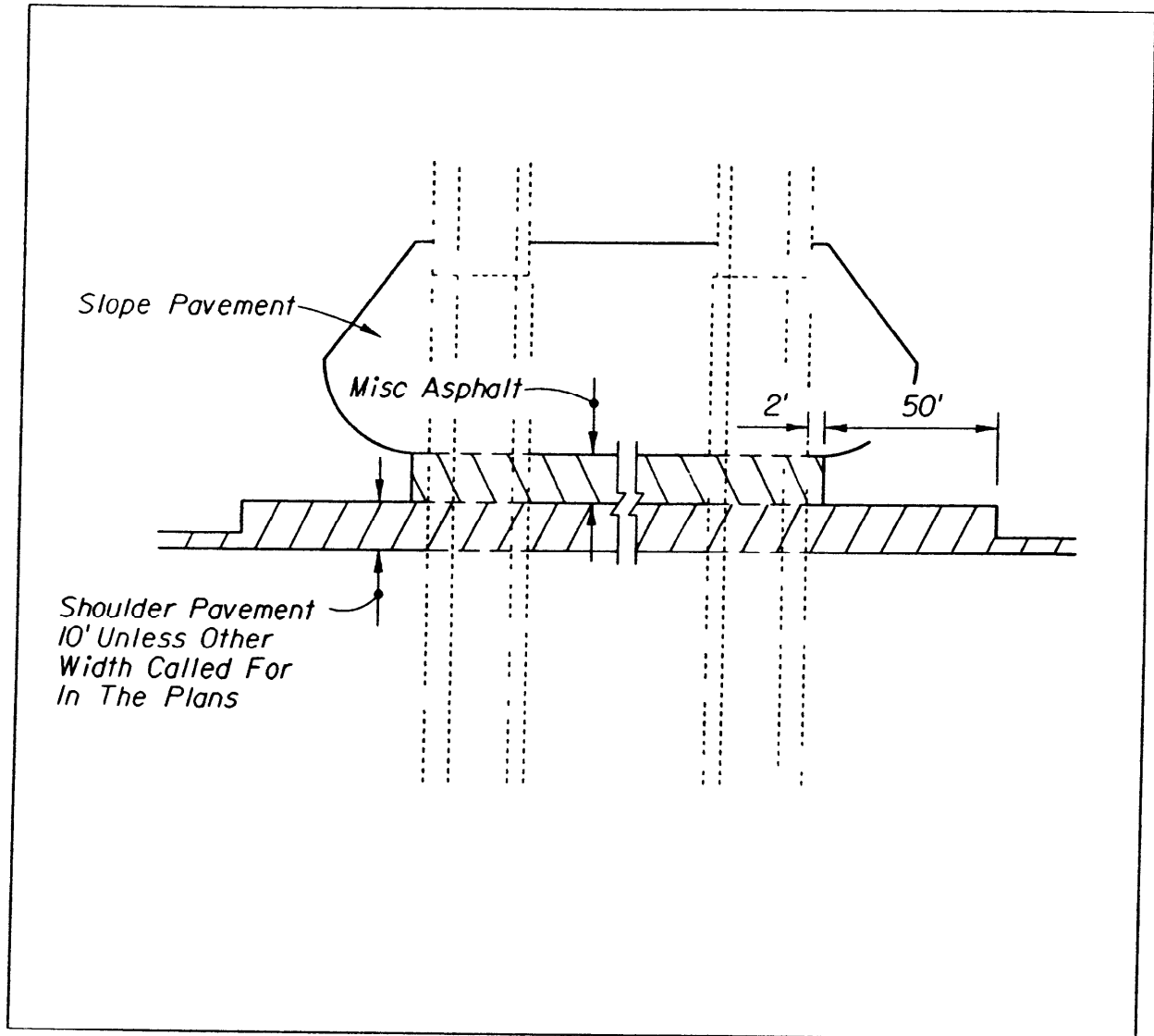

**TYPICAL PAVING UNDER BRIDGE STRUCTURES  
FOR OUTSIDE SHOULDERS**

**Figure 2.3.2**

## 2.4 Roadside Slopes

TYPE OF FACILITY	RURAL & URBAN FREEWAYS, RURAL ARTERIALS AND COLLECTORS, WITH PROJECTED 20 YR. ADT OF 1500 OR GREATER  DESIGN SPEED 45 MPH OR GREATER		RURAL ARTERIALS AND COLLECTORS WITH PROJECTED 20 YR. ADT LESS THAN 1500 AND RURAL LOCALS, URBAN ARTERIALS AND COLLECTORS WITHOUT CURB & GUTTER  ALL SPEEDS		URBAN ARTERIALS AND COLLECTORS WITH CURB & GUTTER  DESIGN SPEED 45 MPH OR LESS	
	Height	Rate	Height	Rate	Height	Rate
Front Slope	0' - 5' 5' - 10' 10' - 20' > 20'	6:1 6:1 to edge of CZ and 4:1 6:1 to edge of CZ and 3:1 2:1 (with guardrail)	0' - 5' 5' - 20'	6:1 except where R/W is insufficient, then 6:1 to edge of CZ and 3:1 will be permitted 6:1 to edge of CZ and 3:1 except where R/W is insufficient then 2:1 will be permitted	All	2:1 or to suit property owner, not flatter than 6:1. R/W cost must be considered for high fill sections in urban areas
Back Slope	All	4:1 or 3:1 with a standard width trapezoidal ditch and 6:1 front slope	All	4:1 when R/W permits or 3:1	All	2:1 or to suit property owner. Not flatter than 6:1.
Transverse Slopes	All	10:1 or flatter (freeways) 4:1 (others)	All	4:1	All	4:1

**Roadside Slopes**  
**Table 2.4.1**

## 2.6 Grades

### 2.6.1 Criteria For Grade Datum

1. *Roadway Base Clearance Above Design High Water Elevation:*

<i>Freeways and rural multi-lane mainline...</i>	<i>3 Feet</i>
<i>Ramps (proper).....</i>	<i>2 Feet</i>
<i>Low point on ramps at cross roads.....</i>	<i>1 Foot</i>
<i>Rural two-lane with design year ADT greater than 1500 VPD..</i>	<i>2 Feet</i>
<i>All other facilities including urban.....</i>	<i>1 Foot</i>

2. *Bridge Vertical Clearances:*

*See Vertical Clearances For Bridges, Table 2.10.1.*

### 2.6.2 Length Of Grade On Curb And Gutter Sections

*A minimum of 250' between VPI's.*

### 2.6.3 Grades On Curb And Gutter Sections

*A minimum grade of 0.3%.*

*See Table 2.6.1 for maximum grades.*

## 2.6 Grades

MAXIMUM GRADES IN PERCENT											
TYPE OF HIGHWAY	AREA	DESIGN SPEED (MPH)									
		FLAT TERRAIN					ROLLING TERRAIN				
		30	40	50	60	70	30	40	50	60	70
FREEWAYS (1)	Rural	—	—	4	3	3	—	—	5	4	4
	Urban	—	—	4	3	3	—	—	5	4	4
ARTERIALS (3)	Rural	—	5	4	3	3	—	6	5	4	4
	Urban	8	7	6	5	—	9	8	7	6	—
COLLECTORS (3)	Rural	7	7	6	5	4	9	8	7	6	5
	Urban	9	9	7	6	5	11	10	8	7	6
	Industrial (2)	4	4	3	3	—	5	5	4	4	—
FRONTAGE ROADS	Require Same Criteria As Collectors.										
RAMPS	DESIGN SPEED (MPH)	15 To 20		25 to 30		35 To 40		45 To 50			
	GRADES (%)	6 To 8		5 To 7		4 To 6		3 To 5			
One-Way Descending Grades On Ramps May Be 2% Greater, In Special Cases											
<p>(1) Interstate designed to 70 MPH will be restricted to 3% maximum grade.</p> <p>(2) Areas with significant (10% or more) heavy truck traffic.</p> <p>(3) On 2-lane highways critical length of upgrades shall not be exceeded. Critical lengths are those which reduce the speeds of 300*/HP trucks by more than 10 MPH.</p>											

### MAXIMUM GRADES

Table 2.6.1

DESIGN SPEED MPH	20	30	40	50	60	65	70
MAXIMUM CHANGE IN GRADE IN PERCENT	1.20	1.00	.80	.60	.40	.30	.20

### MAXIMUM CHANGE IN GRADE WITHOUT VERTICAL CURVES

Table 2.6.2

## 2.7 Sight Distance

<b>MINIMUM STOPPING SIGHT DISTANCE ( FEET )</b> ( Based on height of eye of 3.5 feet and height of object 6 inches above road surface )														
<b>GRADES OF 2% OR LESS</b>														
<i>Design Speed</i>	<b>FREEWAYS</b>							<b>ARTERIALS</b>	<b>COLLECTORS</b>					
	<i>Interstate</i>			<i>Other</i>										
30	---	---	---	---	---	---	---	---	200					
35	---	---	---	---	---	---	---	250	225					
40	---	---	---	---	---	---	---	300	275					
45	---	---	---	---	---	375	---	350	325					
50	---	---	---	---	---	450	---	400	400					
55	550	---	---	---	---	500	---	475	450					
60	625	---	---	---	---	575	---	550	500					
65	700	---	---	---	---	650	---	600	---					
70	800	---	---	---	---	725	---	700	---					
<b>ADJUSTMENT IN DISTANCE FOR GRADES GREATER THAN 2%</b>														
<i>Design Speed</i>	<b>INCREASE IN LENGTH FOR DOWNGRADE ( FEET )</b>							<b>DECREASE IN LENGTH FOR UPGRADE ( FEET )</b>						
	<i>Grades</i>													
	3%	4%	5%	6%	7%	8%	9%	3%	4%	5%	6%	7%	8%	9%
30	10	10	10	20	20	30	30	10	10	10	10	10	10	20
35	10	20	20	30	30	40	40	10	10	10	20	20	20	20
40	20	20	30	40	50	60	70	10	20	20	20	20	30	30
45	20	30	40	50	60	80	90	20	20	20	30	30	40	40
50	30	40	60	70	80	100	---	20	30	30	40	40	50	---
55	40	50	70	80	100	120	---	20	30	40	40	50	50	---
60	50	70	90	110	130	---	---	30	40	50	50	60	---	---
65	60	80	100	130	150	---	---	30	40	50	60	70	---	---
70	70	100	130	160	---	---	---	40	50	60	70	---	---	---

**MINIMUM STOPPING SIGHT DISTANCE**  
*Table 2.7.1*

<b>MINIMUM PASSING SIGHT DISTANCE ( FEET )</b> ( Based on height of eye of 3.5 feet and height of object 4.25 feet above road surface )							
<i>Design Speed</i>	30	35	40	45	50	55	60
<i>2-Lane, 2-Way Facilities</i>	1100	1300	1500	1650	1800	1950	2100

**MINIMUM PASSING SIGHT DISTANCE**  
*Table 2.7.2*



## 2.8 Curves

### 2.8.1 Horizontal Curves

MAXIMUM DEFLECTION WITHOUT CURVE ( DEGREES )			
TYPE FACILITY		$V \geq 45$ mph	$V \leq 40$ mph
Freeways		0° 45'	N/A
Arterials And Collectors	Without Curb & Gutter	0° 45'	2° 00'
	With Curb & Gutter	1° 00'	2° 00'
Where $V$ = Design Speed			
For maximum deflections through intersections, see Section 2.13			

MAXIMUM DEFLECTIONS WITHOUT HORIZONTAL CURVES  
Table 2.8.1

LENGTH OF CURVE ( FEET )	
Freeways	$30V_1$
Arterials	$15V_2$
Collectors	$15V_2$
Where $V$ = Design Speed	
<p>1. When <math>30V</math> cannot be attained, the greatest attainable length shall be used, but not less than <math>15V</math>.</p> <p>2. When <math>15V</math> cannot be attained, the greatest attainable length shall be used, but not less than <math>400'</math>.</p>	
Curve length shall provide full superelevation within the curve of not less than $200'$ ( Rural ) or $100'$ ( Urban ).	
For lengths of curves through intersections, see Section 2.13.	

LENGTH OF HORIZONTAL CURVES  
Table 2.8.2

## 2.8 Curves

### 2.8.1 Horizontal Curves

MAXIMUM CURVATURE, DEGREE			
Design Speed	RURAL ENVIRONMENT ( $e_{max} = 0.10$ )	URBAN ENVIRONMENT ( $e_{max} = 0.05$ )	
		Without Curb And Gutter	With Curb And Gutter
30	24° 45'	20° 00'	20° 00'
35	17° 45'	14° 15'	14° 15'
40	13° 15'	10° 45'	10° 45'
45	10° 15'	8° 15'	8° 15'
50	8° 15'	6° 30'	—
55	6° 30'	5° 00'	—
60	5° 15'	—	—
65	4° 15'	—	—
70	3° 30'	—	—
Interstate 3 Degrees Maximum ( $e_{max} = 0.10$ )			

MAXIMUM DEGREE OF HORIZONTAL CURVE  
Table 2.8.3

MAXIMUM CURVATURE, DEGREE	
Design Speed	Degree Of Curve
RURAL ( $e_{max} = 0.10$ )	
30	1° 30'
40	1° 00'
45, 50, 55	0° 30'
60, 65, 70	0° 15'
URBAN ( $e_{max} = 0.05$ )	
30	7° 00'
35	5° 00'
40	3° 45'
45	2° 45'
50	2° 15'

MAXIMUM HORIZONTAL CURVATURE WITHOUT SUPERELEVATION  
Table 2.8.4

## 2.8 Curves

### 2.8.2 Vertical Curves

K VALUES FOR CREST CURVES				
Design Speed	FREEWAYS		ARTERIALS	COLLECTORS
	Interstate	Other		
30	—	—	30	30
35	—	—	50	40
40	—	—	70	60
45	—	110	90	80
50	—	150	130	120
55	220	190	170	150
60	300	250	230	190
65	380	320	280	—
70	500	400	370	—

$Length, L = KA$

Where:  $L$  = Minimum Length (Feet)  
 $K$  = Constant  
 $A$  = Algebraic Difference In Grades, Percent

*Interstates.* Lengths of crest vertical curves on Interstate mainlines are not to be less than 1000' for open highways and 1800' within interchanges.

*Service Interchanges.*  $K$  values for ramp crest vertical curves at freeway terminals are not to be less than the freeway  $K$  values.  $K$  values for other ramp crest vertical curves are not to be less than arterial  $K$  values.

*System Interchanges:*  $K$  values for all crest vertical curves on systems interchanges are not to be less than the  $K$  values of the higher system.

*Arterials and Collectors:* The minimum lengths of crest vertical curves for highways with design speeds of 50 mph or greater are as follows:

Design Speed (mph)	50	55	60	65	70
Minimum Length (Ft.)	300	350	400	450	500

*All Facilities:* The lengths of crest vertical curves are not to be less than three times the design speed expressed in feet.

*Intersections:* See Section 2.13

### MINIMUM LENGTHS OF CREST VERTICAL CURVES BASED ON STOPPING SIGHT DISTANCE

Table 2.8.5

## 2.8 Curves

### 2.8.2 Vertical Curves

K VALUES FOR SAG CURVES				
Design Speed	FREEWAYS		ARTERIALS	COLLECTORS
	Interstate	Other		
30	—	—	40	40
35	—	—	50	50
40	—	—	60	60
45	—	80	80	70
50	—	100	90	90
55	130	120	110	100
60	150	140	130	120
65	170	160	150	—
70	200	180	170	—

$Length, L = KA$

Where:  $L$  = Minimum Length (Feet)  
 $K$  = Constant  
 $A$  = Algebraic Difference In Grades, Percent

*Interstates:* Lengths of sag vertical curves on Interstate mainlines are not to be less than 800'.

*Service Interchanges:*  $K$  values for ramp sag vertical curves at freeway terminals are not to be less than the freeway  $K$  values.  $K$  values for other ramp sag vertical curves are not to be less than arterial  $K$  values.

*System Interchanges*  $K$  values for all sag vertical curves on systems interchanges are not to be less than the  $K$  values of the higher system

*Arterials and Collectors* The minimum lengths of sag vertical curves for highways with design speeds of 50 mph or greater are as follows:

Design Speed (mph)	50	55	60	65	70
Minimum Length (Ft.)	200	250	300	350	400

*All Facilities:* The lengths of sag vertical curves are not to be less than three times the design speed expressed in feet.

*Intersections:* See Section 2.13

### MINIMUM LENGTHS OF SAG VERTICAL CURVES BASED ON STOPPING SIGHT DISTANCE AND HEADLIGHT SIGHT DISTANCE

Table 2.8.6

## 2.9 Superelevation

SUPERELEVATION RATES (e) FOR RURAL HIGHWAYS $e_{max} = 0.10$							
Degree Of Curve D	Radius R (Ft)	Design Speed (mph)					
		30	40	50	60	65	70
0° 15'	22,918	NC	NC	NC	NC	NC	NC
0° 30'	11,459	NC	NC	NC	RC	RC	RC
0° 45'	7,639	NC	NC	RC	023	025	028
1° 00'	5,730	NC	NC	021	030	033	037
1° 30'	3,820	NC	021	031	.043	048	054
2° 00'	2,865	RC	.028	040	055	062	070
2° 30'	2,292	021	.034	049	.067	.075	085
3° 00'	1,910	025	040	057	077	087	096
3° 30'	1,637	029	.046	065	086	095	100
4° 00'	1,432	033	051	072	093	099	$D_{max} =$
5° 00'	1,146	040	.061	083	.098	$D_{max} =$	$3° 30'$
6° 00'	955	046	.070	092	$D_{max} =$	$4° 15'$	
7° 00'	819	053	078	098	$5° 15'$		
8° 00'	716	058	.084	100			
9° 00'	637	063	.089	$D_{max} =$			
10° 00'	573	068	.094	$8° 15'$			
11° 00'	521	072	.097				
12° 00'	477	076	099				
13° 00'	441	080	100				
14° 00'	409	083	$D_{max} =$				
15° 00'	382	089	$13° 15'$				
16° 00'	358	093					
18° 00'	318	097					
20° 00'	286	099					
22° 00'	260	100					
		$D_{max} =$	$24° 45'$				

NC = Normal Crown  
RC = Adverse Crown  
Rates For Intermediate D's Are To Be Interpolated

**SUPERELEVATION FOR RURAL HIGHWAYS  
URBAN FREEWAYS AND HIGH SPEED URBAN HIGHWAYS**  
Table 2.9.1

## 2.9 Superelevation

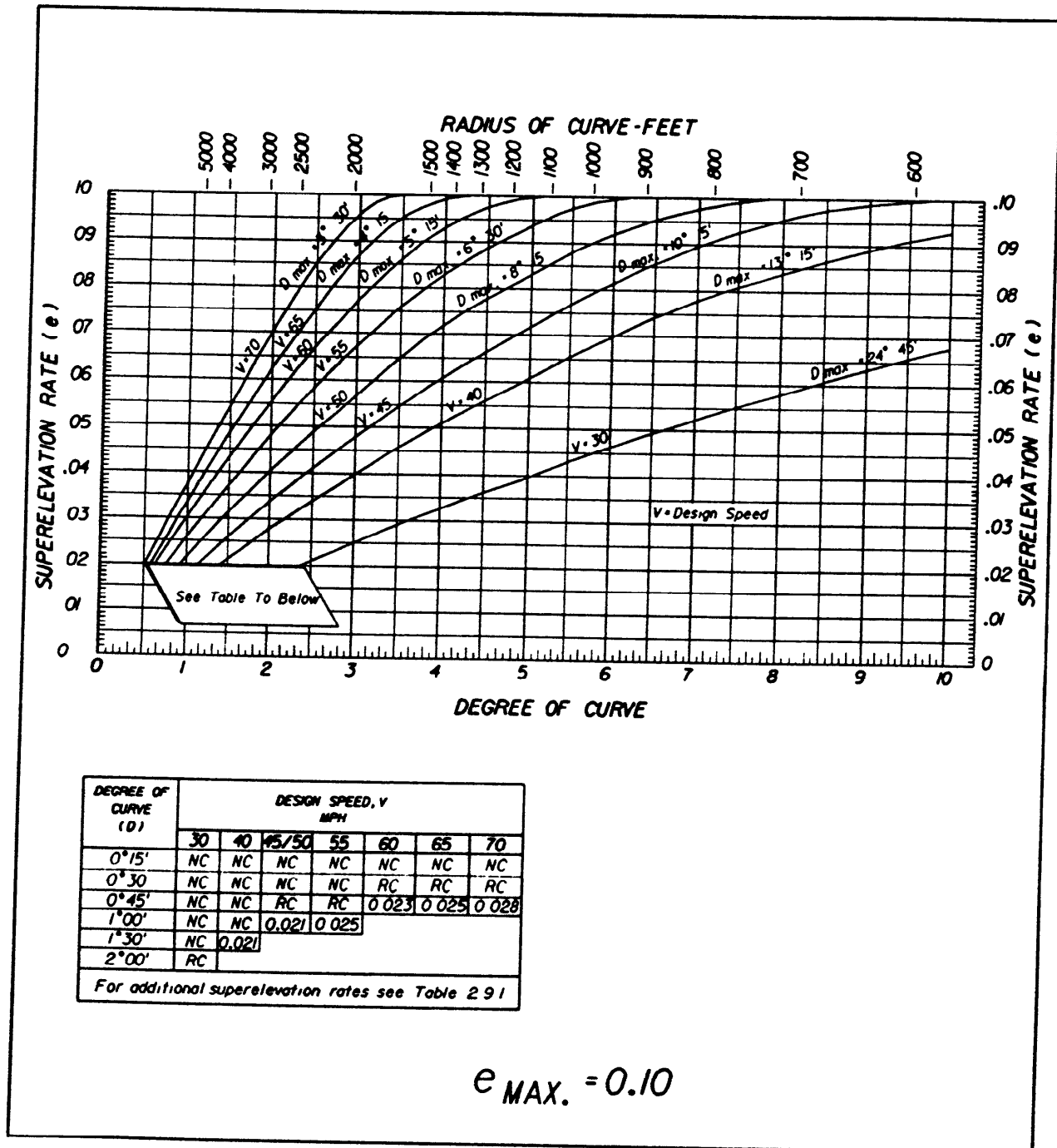

**SUPERELEVATION RATES FOR RURAL HIGHWAYS,  
URBAN FREEWAYS AND HIGH SPEED URBAN HIGHWAYS**  
Figure 2.9.1

## 2.9 Superelevation

SUPERELEVATION RATES (e) FOR URBAN HIGHWAYS AND HIGH SPEED URBAN STREETS $e_{max} = 0.05$						
Degree Of Curve D	Radius R (Ft)	Design Speed (mph)				
		30	35	40	45	50
2° 00'	2,865	NC	NC	NC	NC	NC
2° 15'	2,546					RC
2° 45'	2,083				NC	
3° 00'	1,910				RC	
3° 45'	1,528			NC		
4° 00'	1,432			RC		
4° 45'	1,206					RC
5° 00'	1,146		NC			0.023
5° 15'	1,091		RC			0.027
5° 30'	1,042					0.030
5° 45'	996					0.035
6° 00'	955				RC	0.040
6° 15'	917				0.022	0.045
6° 30'	881				0.024	0.050
6° 45'	849				0.027	$D_{max} = 6° 30'$
7° 00'	819	NC			0.030	
7° 15'	790	RC			0.033	
7° 30'	764				0.037	
7° 45'	739				0.041	
8° 00'	716			RC	0.045	
8° 15'	694			0.022	0.050	
8° 30'	674			0.025	$D_{max} = 8° 15'$	
8° 45'	655			0.027		
9° 00'	637				0.030	
9° 30'	603				0.034	
10° 00'	573				0.040	
10° 30'	546		RC		0.047	
11° 00'	521		0.023	$D_{max} = 10° 45'$		
11° 30'	498		0.026			
12° 00'	477		0.030			
13° 00'	441		0.036			
14° 00'	409	RC	0.045			
15° 00'	382	0.023	$D_{max} = 14° 15'$			
16° 00'	358	0.027				
17° 00'	337	0.032				
18° 00'	318	0.038				
19° 00'	302	0.043				
20° 00'	286	0.050				
		$D_{max} = 20° 00'$				

Normal Crown

Reverse Crown

For superelevation of lower speed Urban streets see the FDOT 'Manual Of Uniform Minimum Standards For Design Construction And Maintenance For Streets And Highways'

**SUPERELEVATION FOR URBAN HIGHWAYS  
AND HIGH SPEED URBAN STREETS**

Table 2.9.2

## 2.9 Superelevation

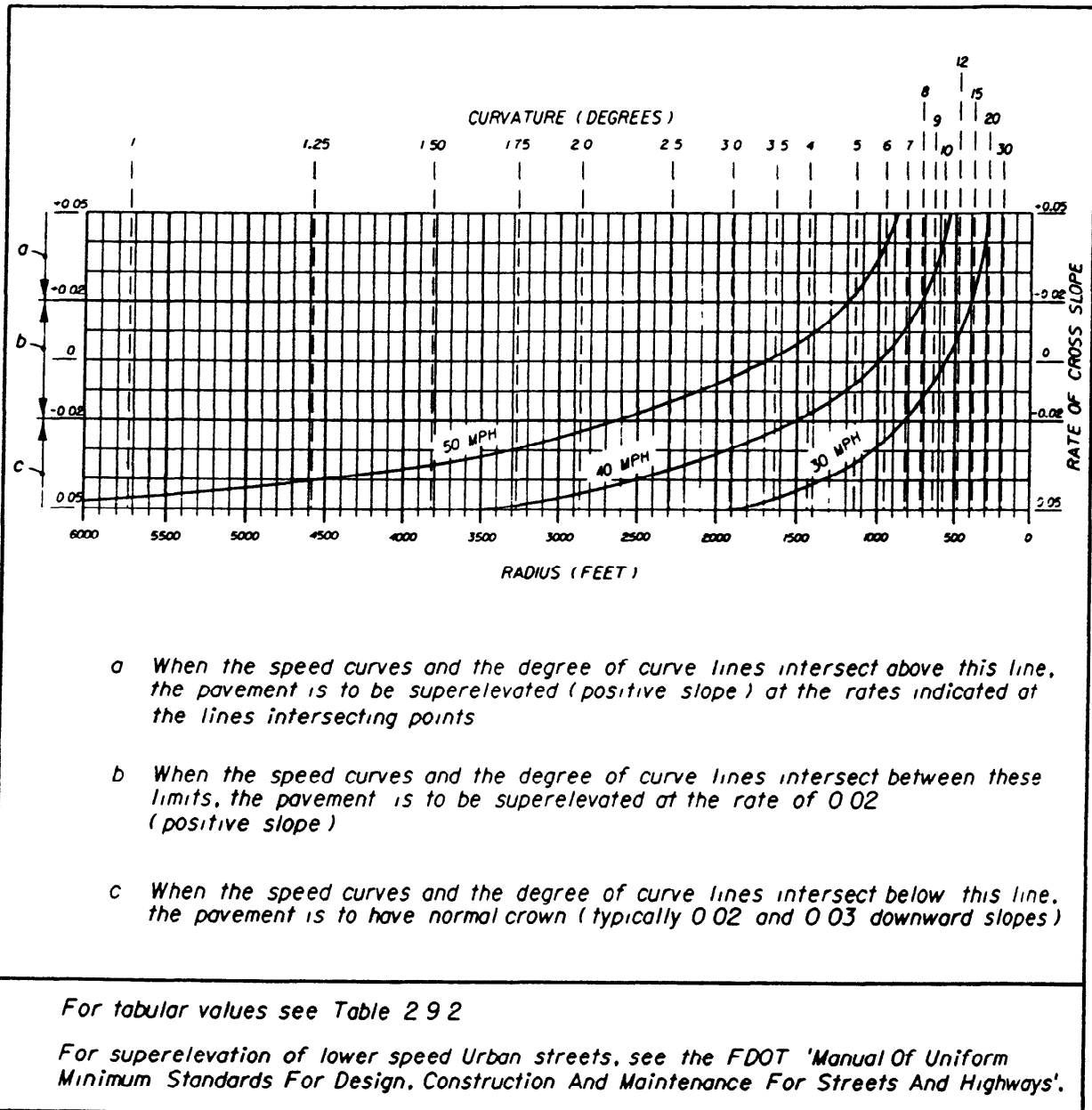

### SUPERELEVATION RATES ( $e$ ) FOR URBAN HIGHWAY AND HIGH SPEED URBAN STREETS

$$e_{\max} = 0.05$$

Figure 2.9.2



## 2.9 Superelevation

<b>SLOPE RATES FOR STRAIGHT LINE SUPERELEVATION TRANSITIONS</b>			
<b>SECTION</b>	<b>DESIGN SPEED, MPH</b>		
	45-50	55-60	65-70
	<b>SLOPE RATES</b>		
2 Lane & 4 Lane	1: 200	. 225	1: 250
6 Lane	1: 160	: 180	1: 200
8 Lane	1: 150	1: 170	1: 190
<p>The length of superelevation transition is to be determined by the relative slope between the travel way edge of pavement and the profile grade, except that the minimum length of transition shall be 100 ft</p> <p>For additional information on transitions see Index No 510</p>			

**SUPERELEVATION TRANSITION SLOPE RATES FOR RURAL HIGHWAYS, URBAN FREEWAYS AND HIGH SPEED URBAN HIGHWAYS**  
Table 2.9.3

<b>SLOPE RATES FOR STRAIGHT LINE SUPERELEVATION TRANSITIONS</b>	
30 MPH	1: 100
40 MPH	1: 125
45-50 MPH $\Delta$	1: 150
<p><math>\Delta</math> 1: 125 may be used for 45 MPH under restricted conditions</p> <p>The length of superelevation transition is to be determined by the relative slope between the travel way edge of pavement and the profile grade, except that the minimum length of transition shall be 50' for design speeds under 40 mph and 75' for design speeds of 40 mph or greater</p> <p>For additional information on transitions see Index No 511</p>	

**SUPERELEVATION TRANSITION SLOPE RATES FOR URBAN HIGHWAYS AND HIGH SPEED URBAN STREETS**  
Table 2.9.4

## 2.10 Vertical Clearances

### 2.10.1 Bridges

FACILITY TYPE	CLEARANCE <sup>1, 4 5</sup>		
	Roadway Or Railroad Over Roadway <sup>2</sup>	Roadway Over Railroad <sup>3, 4</sup>	Pedestrian Over Roadway <sup>2</sup>
Freeways And Arterials	16'	23'	17'
Collectors And Others	14'-6"	23'	17'

**1 Clearance Measurement**  
The least vertical distance between the bridge structure and the surface of the roadway (traffic lanes and shoulders) or the top of rail

**2 Allowance To Be Added For Future Underpass Resurfacing On Rural Sections:**  
4" over flexible pavements  
6" over rigid pavements

**3 Allowance To Be Added For Rail Resurfacing (Track Raise):**  
9" for conventional railroads  
Others - see footnote No 4

**4 Over High Speed Rail Systems.**  
See Department guidelines and specifications for Intermediate Class Rail Operations entitled "Standard Specifications For The Design And Construction Of Railways" dated September 4, 1993.

**5. Clearance Over Waterways**  
See Department 'Drainage Manual', Topic No. 625-040-001, Vol. 1, Ch. 4.

**VERTICAL CLEARANCE FOR BRIDGES**  
**Table 2.10.1**

## 2.10 Vertical Clearances

### 2.10.2 Signs

#### *Overhead Sign Structures*

*17' over the entire width of the pavement and shoulder to the lowest sign component*

*Allowance to be added for future resurfacing on rural sections:*

*4" over flexible pavements*

*6" over rigid pavements*

### 2.10.3 Signals

#### *1. Span Wire Mounted:*

*17' between the pavement and the bottom of any signal assembly*

#### *2. Mast Arm Mounted:*

*17' over the entire width of the pavement and shoulder to the lowest signal or low point on the arm*

*Allowance to be added for future resurfacing on rural sections:*

*4" over flexible pavements*

*6" over rigid pavements*

#### *3. Truss Mounted*

*17' over the entire width of the pavement and shoulders to the lowest signal or lowest member of the horizontal truss.*

*Allowance to be added for future resurfacing on rural sections:*

*4" over flexible pavements*

*6" over rigid pavements*

## 2.11 Horizontal Clearance

<b>PLACEMENT</b>	<i>Placement shall be in accordance with the Roadway and Traffic Design Standards Placement within sidewalks shall be such that an unobstructed width of 4' or more (not including the width of curb) is provided</i>
<b>SUPPORTS</b>	<i>Supports except overhead sign supports shall be frangible or breakaway When practicable, sign supports should be located behind barriers that are justified for other reasons  Overhead sign supports shall be shielded</i>

**HORIZONTAL CLEARANCE FOR TRAFFIC CONTROL SIGNS**  
**Table 2.11.1**

<b>CONVENTIONAL LIGHTING</b>	<i>Rural (Flush Shoulders) 20' from the travel lane, 14' from auxiliary lane (may be clear zone width when clear zone is less than 20')  Urban (Curb and Gutter): From right of way line to 4' back of the face of curb (may be 2.5' back of the face of curb when all other alternatives are deemed impractical) Placement within sidewalks shall be such that an unobstructed width of 4' or more (not including the width of curb) is provided</i>
<b>HIGH MAST LIGHTING</b>	<i>Outside of the clear zone unless shielded.</i>

**HORIZONTAL CLEARANCE FOR LIGHT POLES**  
**Table 2.11.2**

## 2.11 Horizontal Clearance

<p><i>Shall not be located within the limited access right of way</i></p> <p><i>Shall not be located in the median</i></p> <p><b>Rural.</b>  <i>Not within the clear zone and as close as practical to the right of way without aerial encroachments</i></p> <p><b>Urban.</b>  <i>From right of way line to 4' back of the face of the curb ( may be 2.5' back of the face of the curb when all other alternates are deemed impractical ) Placement within sidewalks shall be such that an unobstructed width of 4' or more ( not including the width of the curb ) is provided</i></p>
---

**HORIZONTAL CLEARANCE FOR UTILITY POLES,  
 FIRE HYDRANTS, ETC**  
*Table 2.11.3*

<b>FREEWAYS</b>	<i>Not permitted</i>
<b>RURAL HIGHWAYS</b>	<i>Post shall be placed at shoulder point but the face of the box shall be no closer than 8' from the edge of the traffic lane</i>
<b>CURB AND GUTTER SECTIONS</b>	<p><i>With Utility Strip</i>  <i>Face of box shall be 6" to 12" back of the face of the curb</i></p> <p><i>Without Utility Strip</i>  <i>Locate at back of sidewalk</i></p>
<i>For additional information see Index No. 532.</i>	

**HORIZONTAL CLEARANCE TO MAILBOXES**  
*Table 2.11.4*

## 2.11 Horizontal Clearances

*Shall not be located in medians*

*Should be located as far from traffic lanes as practicable  
Placement within sidewalks shall be such that an unobstructed  
width of 4' or more (not including the width of curb) is provided*

### **HORIZONTAL CLEARANCE TO SIGNAL POLES AND CONTROLLER CABINETS Table 2.11.5**

*Trees shall be outside the clear zone if diameter is or is  
expected to be greater than 4" (measured 6" above the ground).*

### **HORIZONTAL CLEARANCE TO TREES Table 2.11.6**

## 2.11 Horizontal Clearances

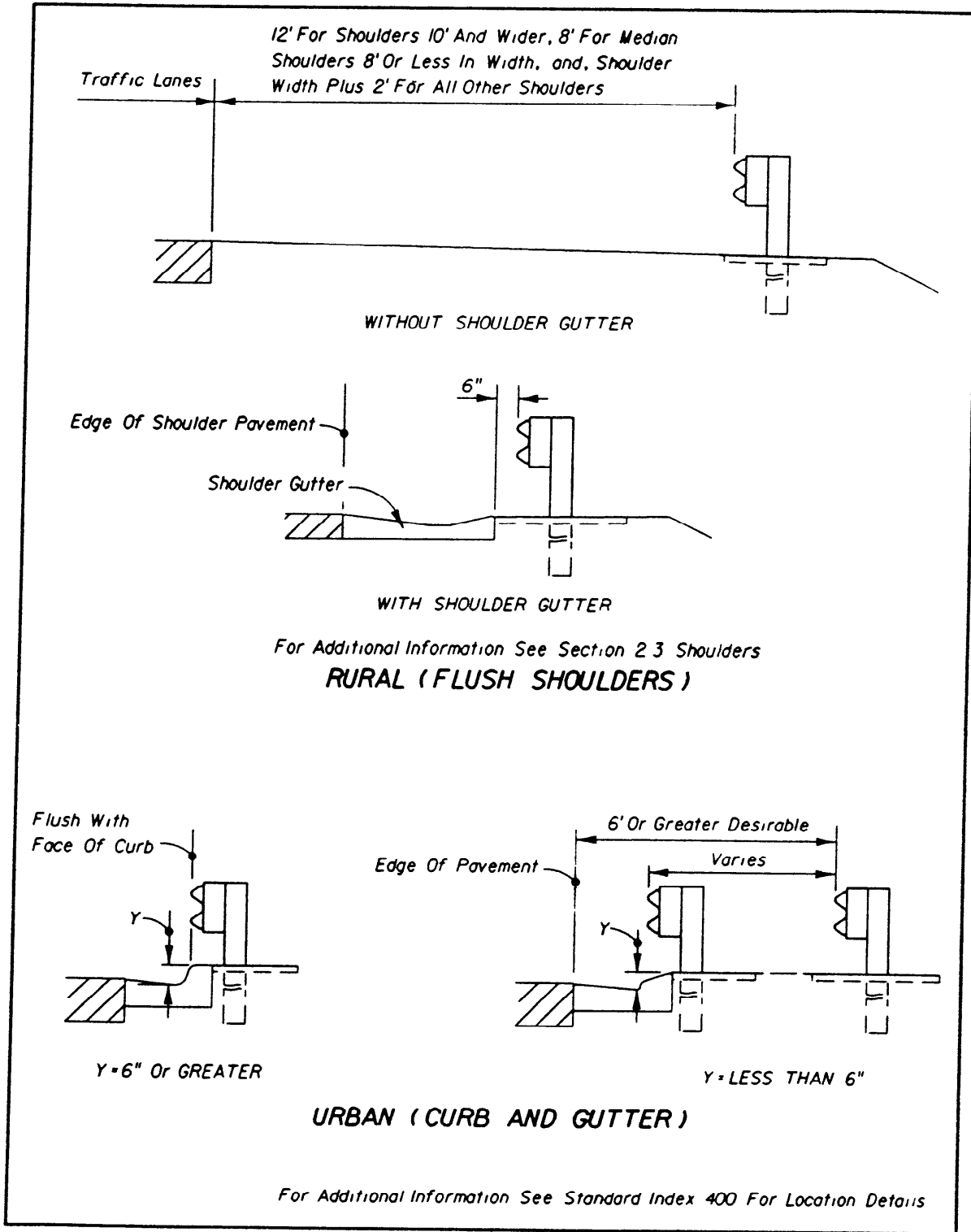

**HORIZONTAL CLEARANCE TO GUARDRAIL**  
**Figure 2.11.1**

## 2.12 Clear Zone

CLEAR ZONE WIDTH ( FEET )						
Design Speed	Rural				Urban ( With Curb And Gutter )	
	≥ 1500 AADT		< 1500 AADT		All Outside Lanes	All Median Lanes
	Travel Lanes & Multi-Lane Ramps	Auxiliary Lanes & Single Lane Ramps	Travel Lanes & Multi-Lane Ramps	Auxiliary Lanes & Single Lane Ramps		
< 45	18	10	16	10	4	6
45	24	14	20	14		
50	24	14	20	14	NA	NA
55	30	18	24	14		
> 55	36	24	30	18		

Above clear zone widths are for side slopes of 4:1 or flatter.

AADT = Mainline 20 year projected annual average daily traffic.

Clear zone widths shall be adjusted on the outside of horizontal curves with flush shoulders in accordance with Table 2.12.2.

Clear zone widths for facilities without curbs are measured from the edge of the traffic lane.

Clear zone widths for outside curbs are measured from the face of the curb. Clear zone width for median curbs are measured from the edge of the inside lane.

**CLEAR ZONE WIDTHS**  
Table 2.12.1



# 2.12 Clear Zone

**CLEAR ZONE OF CURVED ALIGNMENT (CZ<sub>c</sub>) FEET**

D	Design Speed (Vmph) And Clear Zone (CZ Feet)																	
	30		35		40		45		50		55		60		65		70	
10'00"	10	15	10	15	10	15	10	15	10	15	10	15	10	15	10	15	10	15
11'00"	10	16	10	16	10	16	10	16	10	16	10	16	10	16	10	16	10	16
12'00"	10	17	10	17	10	17	10	17	10	17	10	17	10	17	10	17	10	17
13'00"	10	18	10	18	10	18	10	18	10	18	10	18	10	18	10	18	10	18
14'00"	10	19	10	19	10	19	10	19	10	19	10	19	10	19	10	19	10	19
15'00"	10	20	10	20	10	20	10	20	10	20	10	20	10	20	10	20	10	20
16'00"	10	21	10	21	10	21	10	21	10	21	10	21	10	21	10	21	10	21
17'00"	10	22	10	22	10	22	10	22	10	22	10	22	10	22	10	22	10	22
18'00"	10	23	10	23	10	23	10	23	10	23	10	23	10	23	10	23	10	23
19'00"	10	24	10	24	10	24	10	24	10	24	10	24	10	24	10	24	10	24
20'00"	10	25	10	25	10	25	10	25	10	25	10	25	10	25	10	25	10	25
21'00"	10	26	10	26	10	26	10	26	10	26	10	26	10	26	10	26	10	26
22'00"	10	27	10	27	10	27	10	27	10	27	10	27	10	27	10	27	10	27
23'00"	10	28	10	28	10	28	10	28	10	28	10	28	10	28	10	28	10	28
24'00"	10	29	10	29	10	29	10	29	10	29	10	29	10	29	10	29	10	29
25'00"	10	30	10	30	10	30	10	30	10	30	10	30	10	30	10	30	10	30
26'00"	10	31	10	31	10	31	10	31	10	31	10	31	10	31	10	31	10	31
27'00"	10	32	10	32	10	32	10	32	10	32	10	32	10	32	10	32	10	32
28'00"	10	33	10	33	10	33	10	33	10	33	10	33	10	33	10	33	10	33
29'00"	10	34	10	34	10	34	10	34	10	34	10	34	10	34	10	34	10	34
30'00"	10	35	10	35	10	35	10	35	10	35	10	35	10	35	10	35	10	35
31'00"	10	36	10	36	10	36	10	36	10	36	10	36	10	36	10	36	10	36
32'00"	10	37	10	37	10	37	10	37	10	37	10	37	10	37	10	37	10	37
33'00"	10	38	10	38	10	38	10	38	10	38	10	38	10	38	10	38	10	38
34'00"	10	39	10	39	10	39	10	39	10	39	10	39	10	39	10	39	10	39
35'00"	10	40	10	40	10	40	10	40	10	40	10	40	10	40	10	40	10	40
36'00"	10	41	10	41	10	41	10	41	10	41	10	41	10	41	10	41	10	41
37'00"	10	42	10	42	10	42	10	42	10	42	10	42	10	42	10	42	10	42
38'00"	10	43	10	43	10	43	10	43	10	43	10	43	10	43	10	43	10	43
39'00"	10	44	10	44	10	44	10	44	10	44	10	44	10	44	10	44	10	44
40'00"	10	45	10	45	10	45	10	45	10	45	10	45	10	45	10	45	10	45
41'00"	10	46	10	46	10	46	10	46	10	46	10	46	10	46	10	46	10	46
42'00"	10	47	10	47	10	47	10	47	10	47	10	47	10	47	10	47	10	47
43'00"	10	48	10	48	10	48	10	48	10	48	10	48	10	48	10	48	10	48
44'00"	10	49	10	49	10	49	10	49	10	49	10	49	10	49	10	49	10	49
45'00"	10	50	10	50	10	50	10	50	10	50	10	50	10	50	10	50	10	50
46'00"	10	51	10	51	10	51	10	51	10	51	10	51	10	51	10	51	10	51
47'00"	10	52	10	52	10	52	10	52	10	52	10	52	10	52	10	52	10	52
48'00"	10	53	10	53	10	53	10	53	10	53	10	53	10	53	10	53	10	53
49'00"	10	54	10	54	10	54	10	54	10	54	10	54	10	54	10	54	10	54
50'00"	10	55	10	55	10	55	10	55	10	55	10	55	10	55	10	55	10	55
51'00"	10	56	10	56	10	56	10	56	10	56	10	56	10	56	10	56	10	56
52'00"	10	57	10	57	10	57	10	57	10	57	10	57	10	57	10	57	10	57
53'00"	10	58	10	58	10	58	10	58	10	58	10	58	10	58	10	58	10	58
54'00"	10	59	10	59	10	59	10	59	10	59	10	59	10	59	10	59	10	59
55'00"	10	60	10	60	10	60	10	60	10	60	10	60	10	60	10	60	10	60
56'00"	10	61	10	61	10	61	10	61	10	61	10	61	10	61	10	61	10	61
57'00"	10	62	10	62	10	62	10	62	10	62	10	62	10	62	10	62	10	62
58'00"	10	63	10	63	10	63	10	63	10	63	10	63	10	63	10	63	10	63
59'00"	10	64	10	64	10	64	10	64	10	64	10	64	10	64	10	64	10	64
60'00"	10	65	10	65	10	65	10	65	10	65	10	65	10	65	10	65	10	65
61'00"	10	66	10	66	10	66	10	66	10	66	10	66	10	66	10	66	10	66
62'00"	10	67	10	67	10	67	10	67	10	67	10	67	10	67	10	67	10	67
63'00"	10	68	10	68	10	68	10	68	10	68	10	68	10	68	10	68	10	68
64'00"	10	69	10	69	10	69	10	69	10	69	10	69	10	69	10	69	10	69
65'00"	10	70	10	70	10	70	10	70	10	70	10	70	10	70	10	70	10	70

Step 1 Select CZ value from Table 2.12.1  
 Step 2 In Table above locate the "Design Speed" and "Tangent" CZ values that match the speed and CZ value from Step 1  
 Step 3 Move down the "D" column to the degree of curve under consideration then across the table to the column found under Step 2 to find the CZ<sub>c</sub> value

**CLEAR ZONE WIDTHS ON CURVED ALIGNMENTS ON HIGHWAYS WITH FLUSH SHOULDERS**

Table 2.12.2

2 13 Lighting Criteria

CONVENTIONAL LIGHTING - ROADWAYS			
ROADWAY CLASSIFICATIONS	ILLUMINATION LEVEL AVERAGE INITIAL (H F C )	UNIFORMITY RATIOS	
		AVG /MIN	MAX /MIN
INTERSTATE, EXPRESSWAY, FREEWAY & MAJOR ARTERIALS	1 5	4 1 OR LESS	10 1 OR LESS
ALL OTHER ROADWAYS	1 0	4 1 OR LESS	10 1 OR LESS

NOTE These values should be considered standard, but should be increased if necessary to maintain an acceptable uniformity ratio The maximum value should be one and one-half these values

Table 2 13 1

HIGHMAST LIGHTING - ROADWAYS			
ROADWAY CLASSIFICATIONS	ILLUMINATION LEVEL AVERAGE INITIAL (H F C )	UNIFORMITY RATIOS	
		AVG /MIN	MAX /MIN
INTERSTATE, EXPRESSWAY, FREEWAY & MAJOR ARTERIALS	0 8 TO 1 0	3 1 OR LESS	10 1 OR LESS
ALL OTHER ROADWAYS	0 8 TO 1 0	3 1 OR LESS	10 1 OR LESS

Table 2 13 2

UNDERDECK LIGHTING - ROADWAYS		
LUMINAIRE TYPE	LIGHT SOURCE	MOUNTING LOCATION
PIER CAP	150 WATT TO 250 WATT HPS	PIER OR PIER CAP
PENDANT HUNG	150 WATT TO 250 WATT HPS	BRIDGE DECK

NOTE The light levels for underdeck lighting shall be equal to the adjacent roadway lighting

Underdeck lighting is accomplished by mounting either pier cap or pendant hung fixtures under the bridge structure

Pier cap luminaires should be installed when bridge piers are located less than fifteen feet from edge of travel lane

Pendant hung luminaires shall be mounted to the bottom of the bridge deck and should suspend where 50% of the lamp is below bridge beam

Table 2 13 3

REST AREA LIGHTING			
AREA ILLUMINATED	ILLUMINATION LEVEL AVERAGE INITIAL (H F C )	UNIFORMITY RATIOS	
		AVG / MIN	MAX / MIN
ENTRANCE & EXIT	1 5	4 1 OR LESS	10 1 OR LESS
INTERIOR ROADWAYS	1 5	4 1 OR LESS	10 1 OR LESS
PARKING AREAS	1 5	4 1 OR LESS	10 1 OR LESS

Table 2 13 4

MOUNTING HEIGHT RESTRICTIONS		
LUMINAIRE WATTAGE	LIGHT SOURCE	MOUNTING HEIGHT (MIN )
150	HIGH PRESSURE SODIUM (HPS)	25 FEET
200	HIGH PRESSURE SODIUM (HPS)	30 FEET
250	HIGH PRESSURE SODIUM (HPS)	30 FEET
400	HIGH PRESSURE SODIUM (HPS)	40 FEET
750	HIGH PRESSURE SODIUM (HPS)	50 FEET
1000	HIGH PRESSURE SODIUM (HPS)	80 FEET

Table 2 13 5

## **CHAPTER 3**

### **EARTHWORK**

#### **3.1 General**

Earthwork is a generic term for all items of work, materials and operations required to construct the excavated areas and the embankments of a highway project. Sections 120 and 125 of the Standard Specifications define the terms, method of measure, basis of payment and pay items associated with earthwork.

In general, earthwork on a highway project consists of

- (1) **Classified Excavation** - Earthwork designated as Regular (Roadway and Borrow), Subsoil, Lateral Ditch and Channel Excavation
- (2) **Unclassified Excavation** - Excavation, removal and disposal of material, for pipe culverts, bridge foundations, box culverts, storm sewers, inlets, manholes and similar structures where the materials are unclassified and considered as excavation regardless of the material encountered
- (3) **Embankment** - Compacted fill material needed to construct the roadway, excluding the base and pavement portions of the roadway and shoulders. Embankment includes compacted backfill to replace unsuitable material excavated within the lines and grades shown in the plans.

# EARTHWORK

## BASIC PROCESS

The most important operation involving earthwork is constructing the roadbed. The roadbed is constructed by excavating soil from CUT sections -- and placing soil as embankments in FILL sections. In cut sections, the roadbed is built below the natural ground -- the natural ground is excavated to the elevation of the proposed roadbed. In fill sections, the roadbed is built above the natural ground -- the earth fills an embankment.

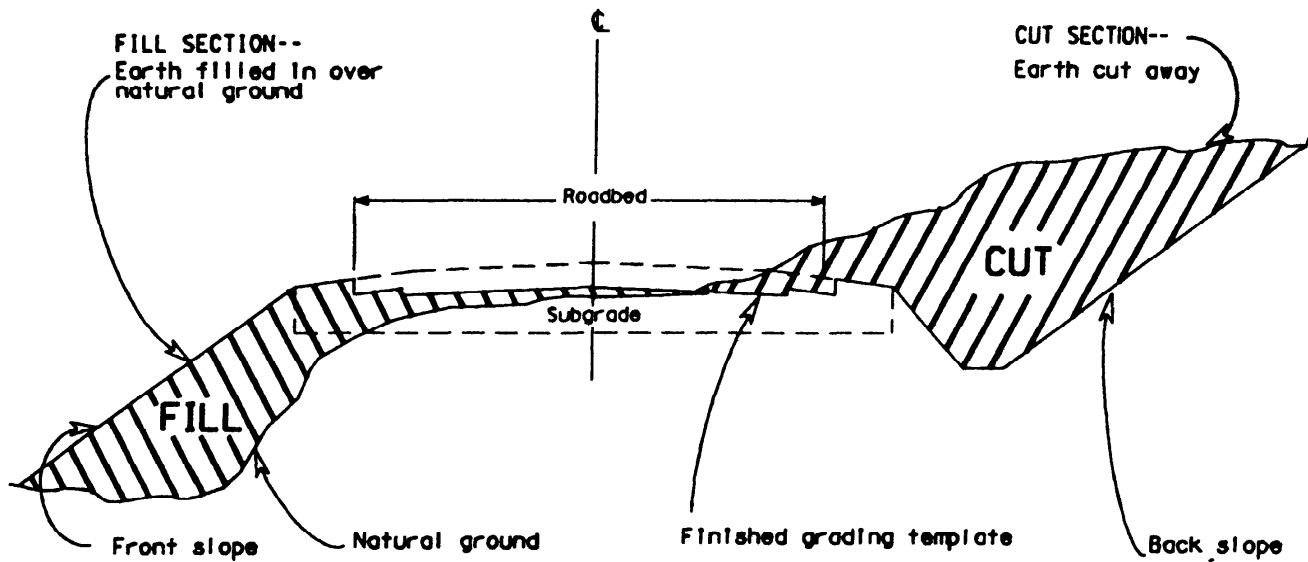

EX-I-3-A

I-3-2.0

### 3.2 Classification of Soils

The Department uses a system of soil classification which places materials into groups and subgroups based on soil fracture, liquid limit and plasticity index. This classification determines if and where the materials may be placed or left in their original position on a highway project. The designer cannot determine the proper removal and utilization of earthwork materials until the soils survey, testing and classification of materials has been performed by a qualified geotechnical laboratory. For more details, see Chapter 17, Volume II of the Plans Preparation Manual and Index 305, Roadway and Traffic Design Standards.

### 3.3 Removal and Utilization

Earthwork is a major cost component of highway construction. The accurate detailing, utilization and calculation of earthwork is a very important part of the design effort. Earthwork is not a simple task, but with proper care and attention, very accurate quantities can be determined.

#### 3.3.1 Criteria for Earthwork Details

The details of removal and utilization of earthwork are shown on the roadway cross sections. The cross sections of the existing surface are usually obtained by location field survey or photogrammetry. The finished profile grades, typical section details, pavement design details, superelevation and horizontal alignments are used in combination to develop the finished roadway template at each location where an existing cross section was obtained. Sometimes it is advisable to develop and plot intermediate cross sections or half-sections to accurately determine quantities.

| For resurfacing and minor widening and resurfacing projects, refer to  
| Section 3.5.7 of this Chapter

Additional criteria used for plotting the earthwork details are found in the Standard Specifications, Section 120, the Roadway and Traffic Design Standards, Indexes 500 and 505, and Chapters 13, 15, 17 and 18, Volume II of the Plans Preparation Manual.



### 3 3 2 Cross Sections - A Design Tool

Roadway cross-sections cannot be finalized until late in the design process. However, preliminary cross section templates, developed early in the design process, can assist the designer in establishing many of the other design elements such as guardrail, shoulder gutter, inlets and special ditch grades. Preliminary cross sections are also used in performing the Soils Survey. Cross section templates should be plotted as soon as the alignment, grades and typical section details are established.

### **3.4 Earthwork Quantities**

#### **3.4.1 Method of Calculating**

Earthwork quantities can be accurately determined by computer or by plan calculation, if proper care is taken. Therefore, the specifications allow it to be designated for payment as the original plan quantity unless determined to be substantially in error. Earthwork quantities are calculated by the method of average end areas.

$$\text{CUBIC YARDS} = \frac{(\text{EA1} + \text{EA2})}{2} \times \text{LENGTH (FT)} \div 27$$

Each set of end areas for the different types of earthwork (cut, fill, subsoil, etc.) are calculated separately and shown in the appropriate column on the cross section sheets, as indicated in Volume II, Chapter 18, PPM.

#### **3.4.2 Suitable and Unsuitable Materials**

Select material or suitable material and plastic, muck or unsuitable materials are calculated and tabulated separately. Material is also summarized in pay item categories as Roadway Excavation, Subsoil Excavation and Embankment or Fill. The designer must be familiar with the material classes, basis of payment and the specifications for earthwork operations in order to properly delineate and calculate earthwork quantities.

**TABULATION OF UNSUITABLE  
MATERIAL ON LEFT SIDE OF  
CROSS SECTION SHEETS**

(1) A-7 MATERIAL A-8 MATERIAL A-2-5, A-2-7, A-5 MATERIAL					
(2) SUBSOIL EXC		(3) RDWY EXC		(4) FILL	
A	V	A	V	A	V

**TABULATION OF SUITABLE  
MATERIAL ON RIGHT SIDE OF  
CROSS SECTION SHEETS**



(5) A-2, A-3 MATERIAL					
(6) SUBSOIL EXC		(7) RDWY EXC		(8) FILL	
A	V	A	V	A	V

- (1) UNSUITABLE MATERIAL on a project may consist of one or more of the classifications shown. The tabulation should be "titled" with the actual classification for the given project as documented by the soil survey.
- (2) SUBSOIL EXCAVATION (UNSUITABLE) is material that does not meet the specification requirements in its original position so it must be excavated and backfilled with suitable material. It must also be below the finished grading template to be subsoil excavation.
- (3) ROADWAY EXCAVATION (UNSUITABLE) is material that may be used in the earthwork only as stipulated in the standards and specifications, if allowed at all. It will be removed by excavating to the lines and grades of the finished grading template. It must be above the bottom of the finished grading template to be roadway excavation.
- (4) FILL (UNSUITABLE) is material that does not meet the requirements for suitable material but may be utilized in certain areas of the embankment as indicated in Standard Index 505.
- (5) SUITABLE MATERIAL consists of those classifications that have been determined to be acceptable for construction of the roadbed, shoulders and other embankments of the highway.
- (6) SUBSOIL EXCAVATION (SUITABLE) is material that would be acceptable in its original position, but it must be excavated below the finished grading template in order to remove material below it that is unsuitable in its original position.
- (7) ROADWAY EXCAVATION (SUITABLE) is the good or acceptable material removed by excavating to the bottom of the finished grading template.
- (8) FILL (SUITABLE) is the material utilized in the embankment in those areas calling for select material by the Standards and Specifications. Fill material is placed above the natural ground surface up to the bottom of the finished grading template. Fill material includes the backfill required to replace all subsoil excavation.

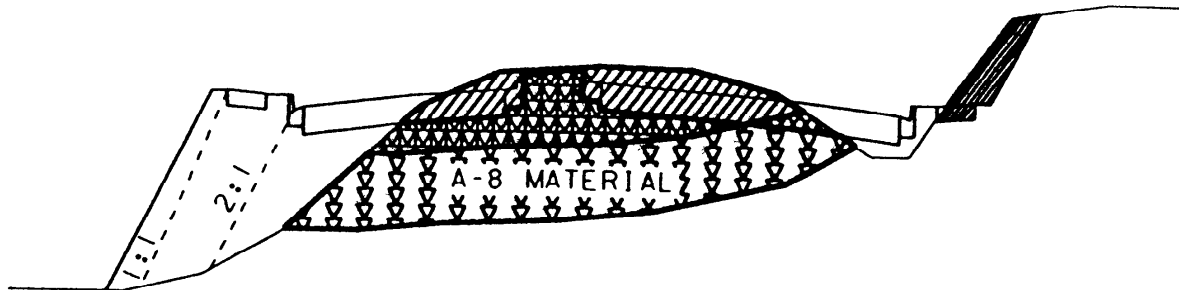

SEE STANDARD INDEXES 500 AND 505



**CUT**  
 AREA BELOW NATURAL GROUND LINE AND ABOVE THE  
 BOTTOM OF THE PROPOSED ROADWAY TEMPLATE



-  REGULAR EXCAVATION -- SUITABLE MATERIAL
-  REGULAR EXCAVATION -- UNSUITABLE MATERIAL

**SUBSOIL EXCAVATION**  
 ALL SUITABLE AND UNSUITABLE MATERIAL BELOW THE  
 BOTTOM OF THE PROPOSED ROADWAY TEMPLATE AND  
 ABOVE THE BOTTOM OF THE LAYER OF UNSUITABLE MATERIAL

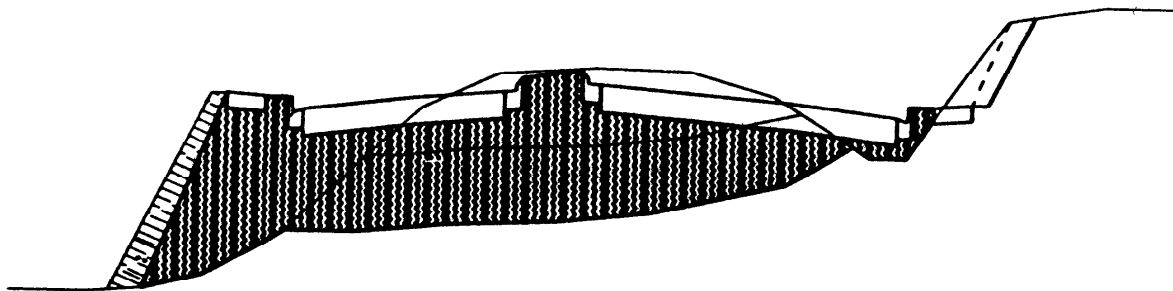
-  SUBSOIL EXCAVATION -- SUITABLE MATERIAL
-  SUBSOIL EXCAVATION -- UNSUITABLE MATERIAL



**FILL**  
 AREA BELOW THE BOTTOM OF THE PROPOSED ROADWAY TEMPLATE  
 AND ABOVE THE BOTTOM LAYER OF UNSUITABLE MATERIAL

-  FILL - SUITABLE MATERIAL
-  FILL - UNSUITABLE MATERIAL

### 3 4 3 Earthwork Accuracy

There are two methods of documenting the earthwork quantities for projects. The most accurate and preferred method involves the preparation of cross-sections to define the quantities of earthwork involved. This method is mandatory on all new construction and major reconstruction projects. The other method, using working typical sections, is only to be used on RRR type projects where it has been determined that the project is a candidate for payment by Regular Excavation, Lump Sum. It is critical that the designer choose which method is best suited for their project with input from construction.

The calculation of earthwork volumes is not simple but, when performed with care and properly checked, will prevent many of the inaccuracies common in earthwork quantity calculations. The primary causes for inaccurate earthwork quantities are found to be errors in calculating end areas and choosing inappropriate intervals between the cross sections. Correct methods and techniques for computing earthwork quantities will eliminate the gross errors.

#### 3 4 3 1 Projects with horizontal and vertical controlled cross sections

- 1 Calculate end areas and volumes by computer, when possible, and print the calculations for verification and future use by others.
- 2 Plot cross section details at the largest scale the sheets will permit (1" = 5'-0" Horizontal and Vertical). This is especially critical if plotting is done manually and the end areas are to be calculated from the plotted sections. Care should also be taken when plotting slopes that extend over long distances.
- 3 If end areas are calculated from cross sections manually, show the breakdown of areas, etc. on work sheets and include these as backup in the computation book.

4 When computing volumes, determine lengths between sets of end areas to compensate for volumes that do not run the entire lengths between the normal station lengths

5 Properly use match lines and turning lines to divide end areas when separate lengths should be used to calculate volumes

6 Reduce the interval between cross sections on ramps or sharp turning roadways (50 feet or less), or determine and use the centroid of the section as the length for computing volumes

7 Proper use of cross section pattern sheets (Volume II, Chapter 13) to determine where cross sections should be taken, will help yield more accurate volumes

8 Exclude bridge spans, large culverts or other exceptions where earthwork is not required

9 Include quantities for fill slopes under bridges, at guardrail installations and at culvert extensions Show extended shoulder slope on cross sections at guardrail locations (not steeper than 10 to 1 per Standard Index 400, Sheet 8 of 14)

10 Make sure that backfill for all subsoil excavation is added to the roadway fill quantities

11 Separate all Suitable and Unsuitable Subsoil Excavation Calculate Roadway Excavation as Suitable and Unsuitable quantities Show these end areas and tabulations on the work sheets so they can be verified and used by others Make sure these quantities are tabulated in the proper columns on the cross section sheets

3 4 3 1 Projects without horizontal and vertical controlled cross sections |

1 Include working typical cross sections in the computation book at all locations |  
where there is a change in either the existing or proposed templates |

2 Working typicals should include the station limits of the typical, and the end |  
areas of all cut and fill sections Working typicals may be placed in the plans, but |  
are not required |

3 The thickness of the base box shall be calculated on the most probable base |  
option A plan note should also be shown in the plans stating which option was |  
used for calculating the earthwork quantities |

4 Extra fill material needed for the extended shoulder for guardrail placement |  
should be documented in the computation book with the final quantity being |  
tabulated on the summary of earthwork The quantity should be based n working |  
typical sections showing the extended shoulder slope on cross sections at guardrail |  
locations (not steeper than 10 to 1 per Standard Index 400, Sheet 8 of 14) |

3 4 4 Variation in Quantities

When detailing and determining earthwork quantities, the designer should use the most  
probable base option within the optional base group, as identified in the pavement design  
and indicated on the typical section A plan note should also be shown in the plans  
stating which option was used for plotting the cross sections and calculating the  
earthwork quantities The Specifications do not allow adjustment of the earthwork  
quantities that were designated to be paid as plan quantity because a base of different  
depth was chosen during construction

### 3 4 5 Sequence of Construction

The designer must be aware of the Traffic Control Plan and, to some extent, the most likely sequence of construction for the project when figuring earthwork utilization. If the contractor cannot excavate material because of a detour or other TCP requirements, different provisions may need to be made in the earthwork items for the project.

**EXAMPLE** A project has balanced earthwork quantities, i.e., embankment is balanced by sufficient excavation to offset it. The embankment is required in Phase I of the construction. During this Phase, the area where the excavation is to be obtained is still under traffic and can NOT be excavated. Unless this is realized and taken care of by design, a Supplemental Agreement will most likely be required to establish a pay item for the materials and work. It could even result in the contractor filing a claim for delay of the work.

**SOLUTION** The designer should change the TCP and construction sequence to ensure that the material in the excavation area is available when it is needed, if possible. Or, if the project is not a balanced job and already has Borrow set up as a pay item, make sure the quantity includes a sufficient amount to cover the embankment in Phase I. The Excavation could then be used to reduce Borrow later in the project, when it is free of traffic and could be excavated. Or, it may be necessary to set up an item for Borrow and then pay for the excavation as Regular Excavation and waste it.



### 3 4 6 Earthwork by Computer

The Department has several options for computing earthwork quantities by computer, In detailing the cross sections on the CADD or other automated system, the requirements and techniques noted above are just as applicable and necessary for accuracy

### 3.5 Earthwork Items of Payment

#### 3 5 1 Regular Excavation

This is the most general classification of earthwork excavation. When Lateral Ditch or other excavation pay items are not called for in the plans, the total quantity of all excavation shall be paid for as regular excavation. Roadway Excavation consists of the net volume of material excavated between the original ground surface and the bottom of the proposed roadway template.

Retention or detention areas that require considerable excavation should be summarized separately and added into the Regular Excavation. This is especially important if there is a large quantity and the area is removed from the project by some distance.

Projects where the predominate earthwork item is roadway excavation should designate Regular Excavation as the pay item, then the embankment would not be paid for as a separate item, as a general rule.

#### 3 5 5 Borrow Excavation

Borrow Excavation is the pay item used to indicate that the contractor is to furnish earthwork material from areas provided by him and generally outside the project limits, including material with a specific minimum bearing value for building up existing shoulders, when appropriate for the project.

Borrow material, if available, may be obtained from within the right of way of the project, including those projects where the material is to be paid for under the embankment pay item. Each project must be analyzed to determine if this option is

feasible FHWA concurrence is required on federal-aid projects prior to utilization of the right of way as a source of borrow

Obtaining material from the project right of way shall not create an unsafe condition or unprotected hazard Proper design criteria shall be applied to proposed excavated areas which will fill with water

The proposed borrow areas shall be reviewed and coordinated with the District Environmental Coordinator to minimize environmental disturbance and promote a future natural appearance

The designer has two options for designating the method of payment for borrow material on highway projects With either option, a fill adjustment must be made to the net total fill material calculated from the plans, to allow for handling Recommendations on fill adjustment percentages should always be obtained from the District Materials and Construction Offices during the design process Because the final measurement procedures are very labor intense, the designer should always check with construction before setting up a project for Borrow Excavation (Pit Measure)

1 Borrow Excavation (Pit Measure) - When the designer, with input and recommendations from construction, determines that the borrow material shall be measured by pit measure, the Earthwork Summary should show the adjusted quantity of borrow material estimated to be required

<u>EXAMPLE</u>	Fill (From Cross Section Totals)	253 CY
	Fill Adjustment (+35%) (253 x 0.35)	<u>89 CY</u>
	Total fill	342 CY
	Roadway Excavation (Select) Deducted	<u>115 CY</u>
	Borrow Excavation (Pay Item Total)	227 CY

I-3-15 0

Revised 12/08/93

2 Borrow Excavation (Truck Measure) - The designer's second option for designating how borrow material shall be bid and paid on projects is truck measure. Truck measure should be specified only for projects which require small amounts of borrow material. Typical types of projects are small resurfacing projects, widening and safety projects. When this option is designated, an additional adjustment (truck) is added to obtain a representative volume of material required. This is not a plan quantity item, but it is very important that the most realistic determination of quantities possible be calculated by the designer.

<u>EXAMPLE</u> Borrow Excavation (As Above)	227 CY
Truck Adjustment (+25%) (227 x 0.25)	<u>57 CY</u>
Borrow Excavation (Pay Item)	284 CY

On some projects it is desirable that construction have the flexibility to pay for the item of borrow by pit measure, but determine the volume by loose truck measure. When this method of measurement is requested by construction, it will be necessary for the designer to calculate a percentage by which the truck measured quantity will be adjusted to determine the pit measured volume. This percentage compensates for the truck adjustment and converts the quantity back to its in-place volume. A pay item note similar to the following should be shown in the plans:

At the contractor's option, and with the approval of the engineer, measurement of borrow material may be based on loose truck volumes. In this case, payment will be made on \_\_\_\_\_% of the truck measured quantity.

The percentage for the above note is calculated as follows

<u>EXAMPLE</u> Borrow Excavation	227 CY
Truck Adjustment (+25%)	<u>57 CY</u>
Total Borrow	284 CY

Percentage (%) is obtained from  $227 \text{ CY} - 284 \text{ CY} = 80\%$

### 3 5 3 Lateral Ditch Excavation

Excavation required to construct inlet and outlet ditches at structures, changes in channels of streams and ditches parallel to the right of way, but separated from the roadway template, may be designated by the designer as Lateral Ditch Excavation

On projects with very little of this type of excavation, this earthwork is usually included in the Regular or roadway Excavation. If there is a significant amount of Lateral Ditch Excavation, it should be detailed, calculated and summarized on separate cross section sheets and shown separately in the Earthwork Summary. For more details on lateral ditch cross sections, see Volume II, Chapter 15

Excavation included for payment or that will be bid as work under Section 125 (Excavation for Structures) must not be included again in Lateral Ditch or other Excavation pay items

### 3 5 4 Subsoil Excavation

The payment for Subsoil Excavation should NEVER be included in other pay items, and subsoil quantities should NOT be included in other quantities, no matter how small the quantities are

The pay item, Subsoil Excavation, consists of the excavation and disposal of muck, clay, rock or any other material that is unsuitable in its original position and that is excavated below the bottom of the finished grading template. Subsoil Excavation also includes all suitable material (usually above the unsuitable material, i.e., overburden) excavated within the above limits in order to excavate the unsuitable material.

The soils investigation survey must document the limits of any unsuitable material found on the project. Likewise, the cross sections and the earthwork calculations must use these limits in determining the quantities for Subsoil Excavation.

Unsuitable subsoil areas and volumes shall be tabulated on the left side of the cross section sheets, and areas and volumes for the suitable subsoil excavation shall be tabulated on the right side of the cross section sheets (Volume II, Chapter 18). The fill quantities (areas and volumes) on the right shall also include areas and volumes required to backfill the excavated areas created by all subsoil removal. See example given in Section 3.4.2 of this procedure.

### 3.5.5 Channel Excavation

The pay item for Channel Excavation consists of the excavation and satisfactory disposal of all material from the limits of the channel as shown in the plans. This work is generally called for by the plans and has lines, grades, typical sections and other details shown for excavating a channel change or a major modification to an existing channel or stream. This work may be significantly different from regular excavation or lateral ditch excavation, requiring draglines, barges or other special equipment. It should be detailed, calculated and summarized separately, in most cases.

SUMMARY OF EARTHWORK		
ROADWAY EXCAVATION, A-2, A-3 MATERIAL	=	10,000 C Y
ROADWAY EXCAVATION A-7 MATERIAL	=	800 C Y
ROADWAY EXCAVATION, A-8 MATERIAL	=	1,005 C Y
EXCAVATION FROM LATERAL DITCHES	=	<u>5,000 C Y</u>
<b>TOTAL REGULAR EXCAVATION (ROADWAY AND DITCH)</b>	<b>=</b>	<b>16,805 C Y</b>
<b>BORROW EXCAVATION</b>	<b>=</b>	<b>6,000 C Y</b>
SUBSOIL EXCAVATION A 2, A 3 MATERIAL	=	980 C Y
SUBSOIL EXCAVATION, A-7 MATERIAL	=	1,400 C Y
SUBSOIL EXCAVATION, A-8 MATERIAL	=	<u>800 C Y</u>
<b>TOTAL SUBSOIL EXCAVATION</b>	<b>=</b>	<b>3,180 C Y</b>

### 3 5 6 Embankment

This item includes placing material above the original ground line and within the lines and grades indicated by the plans. When subsoil excavation is involved, the embankment must include the material necessary to backfill all of the material excavated.

When the work of constructing the embankment is shown to be paid for as Embankment, such price and payment shall be full pay for all the earthwork specified in Section 120, including all excavating, dredging, pumping, placing, compacting, dressing, and protection of the completed earthwork. So, when Embankment (pay item) is used, no other earthwork items are generally required. Subsoil, however, will always be paid for as a separate item. Also, if there are large amounts of lateral ditch or channel excavation, these should be specified to be paid for as separate items of work.

The decision to use Embankment or Borrow Excavation as items of payment should be made with recommendation from the responsible District Construction Office. This decision will have an impact on the manpower required to control the work and document the final estimate records.

Generally, Embankment should be used as the pay item when the project is predominately a fill earthwork project. Most new construction and major reconstruction projects should be considered for payment under this earthwork item. The Summary of Earthwork quantities will show the net fill quantity, with no shrinkage applied.

Only when the project has very little embankment or when construction specifically requests it, should the borrow excavation pay item be used. (See borrow excavation, Section 3 5 2 )

SUMMARY OF EARTHWORK		
ROADWAY EXCAVATION A-2 A-3 MATERIAL	=	10,000 C Y
ROADWAY EXCAVATION A-7 MATERIAL	=	800 C Y
ROADWAY EXCAVATION, A-8 MATERIAL	=	1,005 C Y
EXCAVATION FROM LATERAL DITCHES	=	<u>5,000 C Y</u>
<b>TOTAL ROADWAY EXCAVATION (ROADWAY AND DITCH)</b>	=	<b>16,805 C Y</b>
<b>EMBANKMENT</b>	=	<b>70,000 C Y</b>
SUBSOIL EXCAVATION, A-2, A-3 MATERIAL	=	980 C Y
SUBSOIL EXCAVATION, A-7 MATERIAL	=	1,400 C Y
SUBSOIL EXCAVATION, A-8 MATERIAL	=	<u>800 C Y</u>
<b>TOTAL SUBSOIL EXCAVATION</b>	=	<b>3,180 C Y</b>



3 5 7 Regular Excavation - Lump Sum (3-R Projects only)

The Pay Item for Regular Excavation - Lump Sum (3-R Projects only) is to be used only on resurfacing or minor widening and resurfacing projects which conform to the same guidelines given in Volume 2, Chapter 1, Section 1 7

Earthwork will be paid for as Borrow Excavation (Truck Measure) and Regular Excavation - Lump Sum (3-R Projects only) The designer will calculate these quantities based on information obtained from the field and the proposed typical section The designer will have to allow for additional time in the field to gather data on the existing field conditions using a hand level (See Exhibit EX-I-3-C )

The designer will continue to show the Summary of Earthwork in the plans The summary should show all quantities and adjustments

SUMMARY OF EARTHWORK		
FILL	=	253 CY
GUARDRAIL LOCATIONS	=	70 CY
CROSS DRAINS	=	<u>100 CY</u>
		423 CY
FILL ADJUSTMENT (35%)	=	<u>148 CY</u>
TOTAL FILL	=	571 CY
REGULAR EXCAVATION	=	- <u>215CY</u>
BORROW EXCAVATION	=	356 CY
TRUCK ADJUSTMENT (25%)	=	<u>89 CY</u>
TOTAL BORROW EXCAVATION	=	445 CY

The pay items used will be Regular Excavation - Lump Sum  
Borrow Excavation (Truck Measure) 445 CY

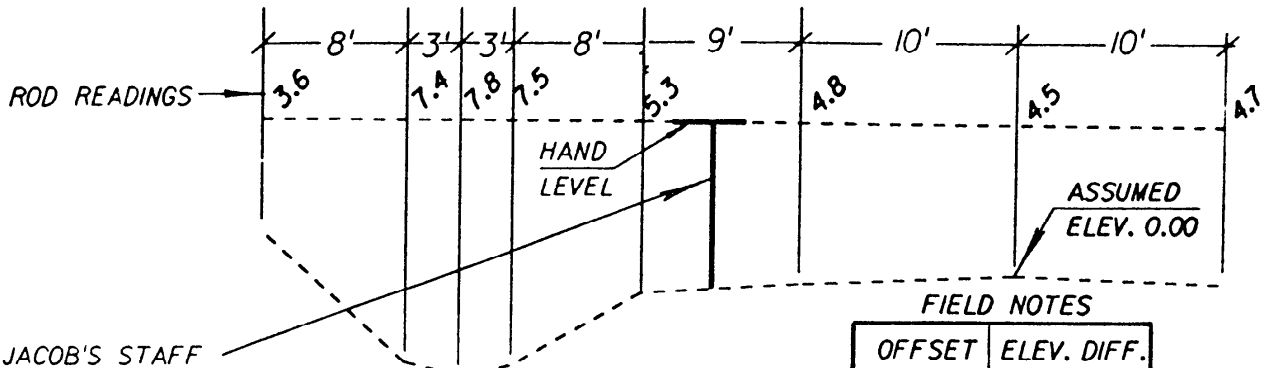

JACOB'S STAFF  
(5' LENGTH OR KNOWN LENGTH)  
(1 BY 2 OR DOWEL OR ETC.)

**EQUIPMENT NEEDED**

- HAND LEVEL AND STAFF
- LEVEL ROD
- TAPE
- NOTEPAD AND PENCIL
- STRAIGHT LINE DIAGRAMS/ OLD PLANS

**FIELD NOTES**

OFFSET	ELEV. DIFF.
10	-0.2
CL	0.0
-10'	-0.3
-19'	-0.8
-27'	-3.0
-30'	-3.3
-33'	-2.9
-41	+0.9

**FIELD SURVEY**

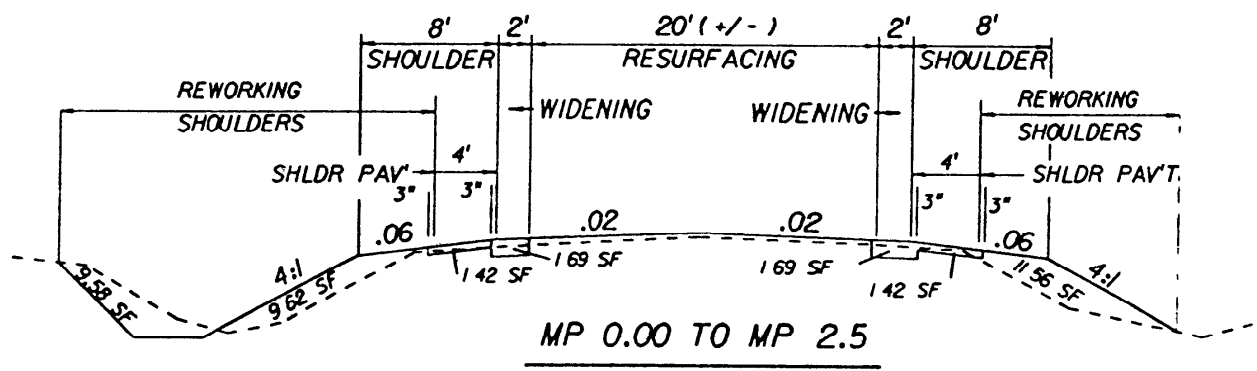

**WORKING CROSS SECTION (TYP. FOR LIMITS)**

1. WORKING CROSS SECTIONS SHALL BE PLACED IN THE COMPUTATION BOOK.  
(PLOTTED FROM FIELD SURVEY NOTES & PROPOSED TYPICAL)
2. THE THICKNESS OF THE BASE BOX SHALL BE CALCULATED ON THE MOST PROBABLE BASE OPTION.
3. SQUARE FOOT END AREAS SHALL BE SHOWN ON EACH WORKING CROSS SECTION.
4. LIMITS WILL BE SHOWN FOR EACH WORKING CROSS SECTION.  
(VERIFY ENTIRE PROJECT IS INCLUDED)
5. EARTHWORK CALCULATIONS WILL BE AS SHOWN IN THE PLANS PREPARATION MANUAL VOLUME 1 CHAPTER 3.  
PAY ITEMS ARE: REGULAR EXCAVATION, (LUMP SUM)  
BORROW EXCAVATION (TRUCK MEASURE)  
REWORKING SHOULDERS (SQUARE YARD)

EX-I-3-C

### 3 6 Summary

Regardless of the decisions made about establishing the items of pay for the earthwork on a project, it is imperative that the designer

- 1 Obtain good soil survey data, especially the limits of unsuitable material within the project limits
- 2 Accurately detail the earthwork on cross sections
- 3 Determine the areas and volumes of the different earthwork items (Roadway, Subsoil, Lateral Ditch, & Channel Excavation) and embankment very accurately
- 4 Show on the Summary of Earthwork all the different types of earthwork operations the contractor must consider
- 5 Use plan notes and pay item notes to explain any unusual conditions or treatments which are not apparent, not to repeat or modify Specifications
- 6 Make a decision on how to pay for earthwork items with the input and recommendations of the district construction office

## Chapter 4

### ROADSIDE SAFETY

#### 4.1 Clear Zone

##### 4.1.1 Clear Zone Concept

A significant number of accidents involve a single vehicle leaving the roadway and either overturning or colliding with a fixed object. A roadside that is traversable and unobstructed by fixed objects will allow vehicles that leave the roadway to recover safely. The designer should provide as much traversable and unobstructed area (clear zone) as practical |

Roadsides are considered traversable if a vehicle can traverse them without seriously endangering the occupants. Roadside are considered recoverable if there is a reasonable probability of regaining control of a vehicle or bringing it to a safe stop. |

If natural or man-made hazards, including slopes steeper than 3:1, occur within the clear zone, the designer should attempt the following treatments, in order of priority |

- 1 Eliminate the hazard |
  - A Remove the hazard |
  - B Relocate the hazard outside the clear zone |
  - C Make the hazard traversable or crashworthy |

- |           2   Shield the hazard with a longitudinal barrier or crash cushion
- |           This treatment should only be taken if the barrier or crash cushion
- |           presents a lesser hazard
- |           3   Leave the hazard unshielded   This treatment should be taken only
- |           if a barrier or crash cushion is more hazardous than the obstacle
- |           hazard, if the likelihood of striking the hazard is very small or if
- |           the expense of treatment outweighs the benefits in terms of
- |           accident reduction

|   If accident data or safety reports indicate that early treatment of the hazards  
|   will result in fewer or less severe accidents, designers should consider  
|   directing that those treatments be accomplished as the first order of work, if  
|   feasible and practical

#### 4 1 2 Clear Zone Criteria

Criteria have been developed with the objective of providing the necessary  
recovery area for the vehicles that might leave the roadway   The criteria are  
based on limited empirical data which was then extrapolated for a wide range  
of conditions   The criteria represent a reasonable degree of roadside safety,  
but they are neither absolute nor precise   These criteria must be applied with  
judgement   In some cases, the clear zone can be adjusted higher or lower  
than shown   In all cases, the most clear zone that can be practically provided  
is desirable

|   The Roadway and Traffic Design Standards include criteria for determining  
|   clear zones, as well as other design criteria related to highway safety for new  
|   construction or reconstruction projects   The designer should keep safety in  
|   mind as the objective when applying clear zone criteria

If a non-recoverable slope encroaches the clear zone, then a clear runout area should be provided beyond the toe of slope equal to the width of the encroachment. A minimum of 10 feet of clear runout area beyond the toe of slope should be provided.

Chapter 25 provides RRR clear zone criteria for other projects.

111

2

# RECOVERY AREA AND CLEAR ZONE DISTANCE

..81

## RECOVERY AREA AND CLEAR ZONE DISTANCE

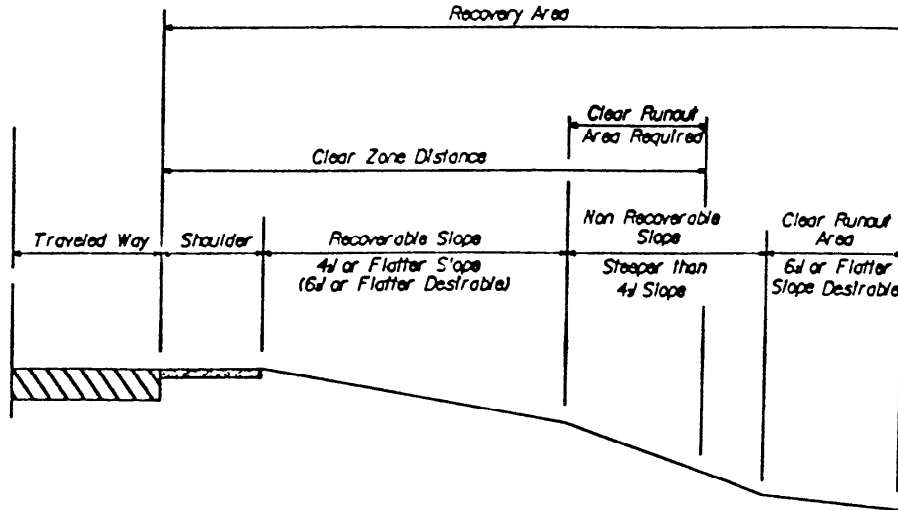

Example of a Parallel Embankment Slope Design This figure illustrates a recoverable slope followed by a non-recoverable slope. Since the clear zone distance extends onto a non-recoverable slope, the portion of the clear zone distance on such a slope may be provided beyond the non-recoverable slope if practical. This clear runout area would then be included in the total recovery area. The clear runout may be reduced in width based on existing conditions or site investigations. Such a variable sloped typical section is often used as a compromise between roadside safety and economics. By providing a relatively flat recovery area immediately adjacent to the roadway, most errant motorists can recover before reaching the steeper slope beyond

## ROADSIDE DESIGN GUIDELINES

Exhibit I-4-A

Revised 12/04/91

I-4-40

#### **4.2 Canal Hazard Standards**

Canals are defined as an open ditch parallel to the roadway for a minimum distance of 1000 feet and with a seasonal water depth in excess of three feet for extended periods of time (24 hours or more)

The distance from the outside edge of the through travel lane to the top of the canal side slope nearest the road will be no less than 60 feet for highways with design speeds of 50 MPH or greater. For highways with design speeds less than 50 MPH this minimum distance may be reduced to 50 feet for rural highways or 40 feet for urban (curb and gutter) highways. When new canal or roadway alignment is required, distances greater than these above should be provided, if possible, to accommodate possible future improvements to the roadway (widening, etc.)

On fill sections, a flat berm (maximum 10:1 slope) of width no less than 20 feet will be provided between the toe of the roadway front slope and the top of the canal side slope nearest the roadway. This minimum berm width applies to all types of highways, both rural and urban (curb and gutter) construction. (See Exhibit EX-I-4-B)

When the slope between the roadway and the "extended period of time" water surface is 6:1 or flatter, the minimum distance can be measured from the edge of the through lane to the "extended period of time" water surface and a berm is not required.

In sections with ditch cuts 20 feet will be provided between the toe of the front slope and the top of the canal.



Guardrail, or other protective devices shall be installed 5' from the canal front slope where it is not possible to meet the above minimum criteria. The design is complicated when clear zone and slope criteria are combined with canal hazard criteria. Extreme caution must be taken to ensure that all criteria are met.

- | If the minimum standards for canal hazards cannot be met, then the standard
- | guardrail treatments as provided in the Roadway and Traffic Design Standards
- | should be used.

# MINIMUM STANDARDS FOR CANAL HAZARDS

---

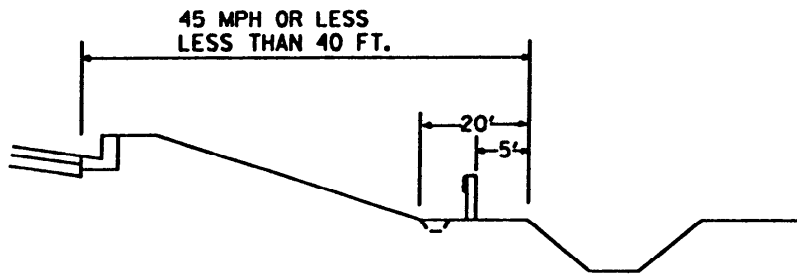
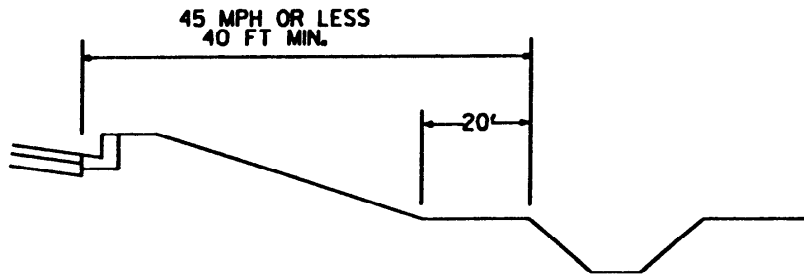
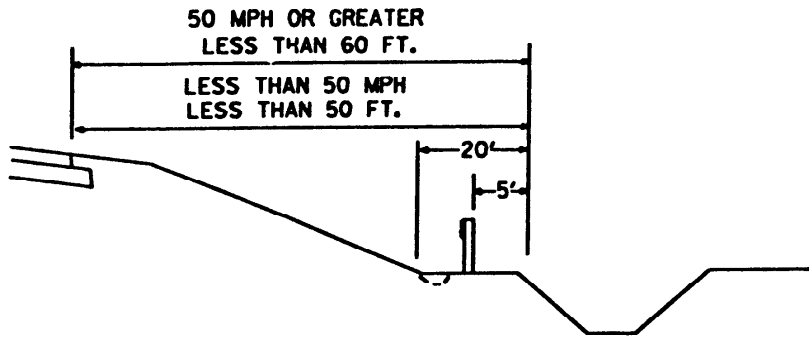
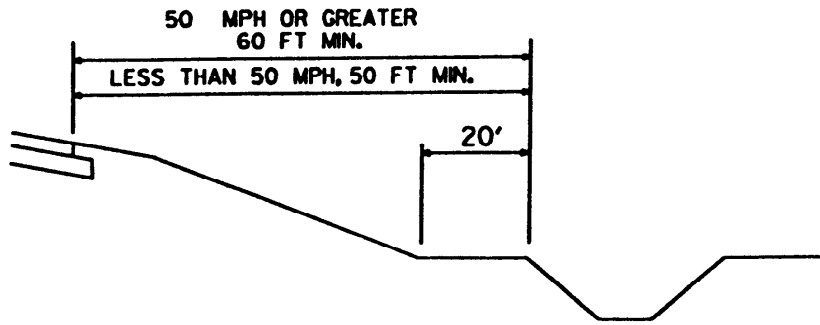

I-4-7.0

EX-I-4-B

### **4.3 Roadside Barriers**

#### **4.3.1 Warrants**

- |     Roadside barriers are warranted when hazards exist within the clear zone, cannot be cost effectively eliminated or corrected and collisions with the hazards will be more serious than collisions with the barriers
  
- |     The length of advancement and length of need necessary to properly shield the hazard must be determined on an installation by installation basis as indicated in the Roadway and Traffic Design Standards
  
- |     The following conditions within the clear zone are normally considered more hazardous than a roadside barrier
  - o     Fill slopes steeper than 3:1
  - o     Bridge piers, abutments and railing ends
  - o     Large, non-traversable culverts, pipes and headwalls
  - |     o     Non-traversable parallel or perpendicular ditches and canals
  - o     Bodies of water other than parallel ditches and canals that the engineer determines to be hazardous
  - o     Parallel retaining walls with protrusions or other potential snagging features
  - o     Retaining walls at an approach angle with the edge of pavement larger than 7 degrees (8:1)
  - o     Non-breakaway sign or luminaire supports
  - |     o     Trees greater than four inches in diameter measured 6" above the ground at maturity

- o Utility poles
- o Rigid protrusions above the ground in excess of four inches in height |

In addition to the above hazards, there may be other situations that warrant |  
barrier consideration, such as nearby pedestrian or bicycle facilities, schools, |  
residents or businesses

#### 4.3.2 Barrier Selection

Acceptable standard roadside barriers are detailed in the Roadway and Traffic |  
Design Standards. They include |

- o Standard blocked-out W-beam on 6" X 8" wood post (strong post)
- o Standard blocked-out W-beam on 6" "C" steel post (strong post)
- o Standard blocked-out W-beam on W6 X 8.5 or W6 X 9 steel post (strong post)
- o Blocked-out Thrie-Beam on any of the above post systems
- o Standard concrete barrier wall |

Most guardrail installations will be blocked-out W-beam on wood or steel posts. The Thrie-Beam guardrail should be considered when additional rail depth is needed because of a potential to under-ride the rail or because additional height may be needed. A special design detail shall be approved |  
by the State Roadway Design Engineer prior to inclusion of Thrie-Beam in the |  
plans. Concrete barrier wall may be used in locations where no barrier |  
deflection can be tolerated. Other barrier designs may be required by specific |  
site conditions. These must be called for and detailed on a project by project |  
basis |

### 4 3.3 End Treatments

Non-crashworthy longitudinal barrier ends can present serious hazards if they terminate within the clear zone. The FDOT end anchorage Type IV is the only crashworthy end treatment standardized by the Department. Other proprietary end treatments may be required under special circumstances. Special details would be required in the plans.

- o End Anchorage Type IV. It is very important that the standard 37'-6" parabolic flare with 4' offset be provided exactly as shown in the Roadway and Traffic Design Standards. The 4 foot end offset should be measured off a projection of the face of guardrail alignment immediately downstream. If the guardrail alignment is on a flare off the roadway or curve, the standard parabolic flare is an additional flare. The maximum allowable cross slope in front of the rail is 10:1, including the area in front of the Type IV and the upstream approach to the Type IV.
- o Non-crashworthy end treatments will be used outside the clear zone and at downstream terminations, which are not within the clear zone of the opposing traffic flow. The Type II end anchorage is non-crashworthy and, therefore, may not be used as an approach terminal end treatment.
- o Three-beam and concrete barrier wall will be terminated as shown in the Roadway and Traffic Design Standards. Appropriate transitions to W-beam guardrail will be necessary to use the End Anchorage Type IV. Crash cushions may also be used to terminate three-beam or concrete barrier wall. The sloped Concrete Barrier Wall Terminal will only be used on roadways with a design speed of 45 MPH or less or where the terminal can be located the clear zone width or greater from the traffic lane approaching the sloped terminal.

### 4 3.4 Transitions

Revised 12/04/91

I-4-10 0

Whenever standard W-beam or Thrie-beam guardrail transitions into bridge rail or concrete barrier wall, a transition section is necessary. Transitions for W-beam guardrail must include sound structural connections, nested beams and additional posts for increased stiffness, as shown in the Roadway and Traffic Design Standards. Transitions for Thrie beams must be included in the plans. Standard flares should be introduced upstream of the transition section. Care must be taken in the details of the junction of the two barrier types to avoid snag points.

#### 4.3.5 Placement

The primary design factors associated with guardrail placement are:

- o Lateral offset from the edge of pavement
- o Terrain effects
- o Flare rate
- o Length of advancement
- o Length of need

The standard offset is the shoulder width plus two feet, not to exceed 12 feet. Alternate guardrail offset locations are shown in the Roadway and Traffic Design Standards.

A two foot distance from the back of the barrier posts to the shoulder line or slope break is desirable for post support.

The length of advancement is dependent on the design speed, the offset distance to the face of guardrail and the lesser distance (a) to the back of the hazard or (b) to the clear zone needed. The designer must establish this

| advancement need for all installations on the project On all facilities the  
| guardrail needs must consider traffic from both directions

| A barrier should not be located so close to the hazard that it is shielding that  
| it is within the dynamic deflection distance of the barrier. The dynamic  
| deflection of standard barriers are shown in Table 4.3.2

**Table 4.3.2**  
**Dynamic Deflection of Barriers**  
**(Measured from the back of the barrier post)**

<u>Barrier Type</u>	<u>Dynamic Deflection (ft)</u>
W-Beam, Strong Post	4
Thrie-Beam, Strong Post	2
Barrier Wall	0
Double W-Beams (Nested)	
w/Strong Post @ 1'-6 75" cc	0.5

| Curbs shall not be placed in the front of barriers When guardrail is  
| necessary, the guardrail shall be located at the face of the curb or in front of  
| it

Barriers should not be placed on slopes steeper than 10:1 This is particularly  
important on the approach to the standard flare of the End Anchorage Type  
IV.

#### 4.3 6 Resetting Guardrail

For those projects that include the resetting of guardrail, refer to the Standard |  
Specifications, the Basis of Estimate and the Roadway and Traffic Design |  
Standards for pay items, notes and quantity calculations |



#### **4.4 Median Barriers**

##### **4.4.1 Warrants**

| A median barrier shall be provided on Interstate and expressway facilities  
| where reconstruction reduces the median width to less than the standard for  
| the facility. No variances or exceptions to this criteria will be approved.

##### **4.4.2 Selection**

The same barrier types as discussed in Section 4.3.2 are available as median barriers. In general, the concrete barrier wall is preferable in narrow medians.

##### **4.4.3 End Treatments**

Median barriers can be terminated with any of the treatments discussed in 4.3.3.

## 4.5 Crash Cushions

Crash cushions are attenuating devices that may be non-directive or re-directive |

### 4.5.1 Warrants

Hazards within the clear zone which present a more serious collision |  
potential than a crash cushion, are warrants for the installation of a crash  
cushion

### 4.5.2 Selection

The following types of crash cushions are currently standardized for use |

- o Hex-Foam Sandwich System
- o Guardrail Energy Absorbing Terminal (G-R-E-A-T)
- o Crash Attenuating Terminal (CAT)
- o Brakemaster
- o Sand-filled Plastic Barrels
- o Work Zone Attenuator (G-R-E-A-T-cz)
- o Vehicle Arresting Barrier (DRAGNET)

The Roadway and Traffic Design Standards and manufacturer's publications |  
provide detailed information about these systems. Each system has its own  
unique physical and functional characteristics. The designer shall indicate in |  
the plans which system is to be used at each location. The design engineer |  
shall consider the following factors when selecting a system for a particular |  
location |

- o Site characteristics
- o Structural and safety characteristics of candidate systems
- o Initial and replacement/repair costs
- o Expected frequency of collisions
- o Maintenance characteristics

| Site characteristics and economics dictate the crash cushion selection. Sand barrels are relatively low in initial cost, but usually must be completely replaced when struck, so are more appropriate in locations with a low likelihood of collision. The other systems have higher initial costs but can be repaired after collisions relatively cheaply, so are more appropriate where frequent collisions are expected. The ability of maintenance forces to perform routine maintenance and to place a crashed system back into service quickly should be a major consideration. Crash cushions that require stocking unusual and expensive parts or that are complex to replace should not be selected.

#### 4.5.3 Design

Crash cushion suppliers normally provide design assistance for their system.  
 | These systems must decelerate both large and small automobiles from the  
 | established design speed of the facility to a gradual stop. If the AASHTO  
 | Roadside Design Guide charts are used, the maximum average deceleration  
 level should not exceed approximately 7 g's.

All terrain within the likely approach of a vehicle should be relatively flat.  
 | An impacting vehicle should strike the unit at normal height, with the  
 | vehicle's suspension system neither collapsed nor extended. Curbs exceeding  
 | 4" in height shall not be used in the approach area of a crash cushion.

**Sand barrels do not have redirection capability, so they should be oriented toward the expected angle of impact** |

**Care must be taken with all systems shielding a rigid object to ensure that there is not a potential to impact the hazard by opposing traffic** |

**The nose of all crash cushions shall be delineated with reflective material or standard object markers, as indicated in the Roadway and Traffic Design Standards** |

## **4.6 Roadside Appurtenances**

### **4.6.1 Sign Supports**

| All sign supports, except overhead cantilever, truss type or bridge or barrier  
| wall mounted, shall be either breakaway or frangible as defined in the  
| AASHTO Standard Specifications for Structural Supports for Highway Signs,  
| Luminaires and Traffic Signals and the AASHTO Roadside Design Guide  
| Supports not meeting the frangibility or breakaway criteria should not be  
| installed within the clear zone. Sign supports not meeting these requirements  
| which must be installed within the clear zone shall be protected by a barrier  
| or crash cushion. Sign supports shall be of an acceptable and crashworthy  
| design as described in the Roadway and Traffic Design Standards.

#### 4 6 2 Mailbox Supports

Mailbox supports shall be of an acceptable crashworthy design, as described in Roadway and Traffic Design Standards |

#### 4 6 3 Other Appurtenances

The Roadway and Traffic Design Standards contain design criteria for numerous other roadside appurtenances |

#### 4 6 4 Location Criteria

Most breakaway mechanisms are designed to be impacted at bumper height, typically about 20 inches above the ground. If impacted at a significantly higher point, the bending moment in the breakaway base may be sufficient to bind the mechanism, resulting in non-activation of the breakaway device. For this reason, it is important that breakaway supports not be located in ditches or on steep slopes where a vehicle is likely to be partially airborne at the time of impact.

#### 4 6 5 Bus Benches and Transit Shelters

Design criteria for these features are discussed in Section III of the Florida Green Book.

## Chapter 5

### UTILITIES

#### 5.1 General

Highways serve the public by carrying people and goods from place to place. Public and privately owned utilities have a public-serving function similar to that of highways. The needs of utilities (power lines, communication lines, gas and other pipelines, water mains and sewers) to go from place to place (often to or from the same points as the highway system), are recognized by the Department. Utility facilities, both above and under ground level, are permitted by the Department to be accommodated within the road rights-of-way on the state maintained highway system (non-interstate).

For interstate facilities parallel utilities within the right-of-way are not allowed. Lateral crossings are allowed by permit only (see Utilities Policy # 71000-020-001-a). The designer should make every effort to design a project that will avoid conflicts with major utilities. The selection of typical section features, horizontal alignment and location of storm sewer lines are two areas that can sometimes be adjusted without violating safety standards and design criteria. A dual storm sewer system to avoid lateral crossings may be practical on some projects to avoid utility conflicts. The increased cost of some features may be offset by reduced construction time and the associated costs.

## 5.2 Relocation

Relocation is the adjustment of utility facilities required by a roadway project. Examples are removing and reinstalling a utility at a new location, moving or rearranging existing utilities, changing the type of facility, improving safety and protective measures. Relocation includes constructing a replacement facility functionally equal to the existing facility, where necessary for continuous operation of the utility services, the project economy, or sequence of roadway construction.



### 5.3 Utility-Accommodation Guide

The Department has established certain guidelines to regulate the location and manner for installation and adjustment of utility facilities in order to ensure safe and efficient operation and maintenance of the roadway facility.

The Department's Utility Accommodation Guide governs on matters concerning future location, manner and methods for the installation or adjustment and maintenance of utilities on highway right-of-way.

A permit must be approved by the Department before any utility is installed on the right-of-way, whether it is for aerial or underground installations. Exceptions and requirements for permits are enumerated in the guide.

Design considerations for accommodating utilities within the highway rights-of-way are given in the AASHIO publications A Guide for Accommodating Utilities within Highway Right-of-Way and A policy on Geometric Design of Highways and Streets. Additional information can be found in the TRB's publication Policies for Accommodation of Utilities on Highway Rights-of-Way.

#### 5.4 Verification of the Location of Major Existing Utilities

Utility delays account for 17 to 18% of the construction contract time extensions. Inaccurate location of existing utility facilities has been identified as a significant contributor to these extensions. As a result, positive horizontal and vertical verification of the location of major existing utilities is required on those urban reconstruction and add lane projects where timely completion is essential because of disruptions to traffic flow.

Major utilities are defined as those underground utilities that potentially conflict with construction activities to the extent that the existing location may interfere with pavement construction, stabilizing, curb and gutter construction, bridge foundations, sign and signal foundation, light poles, drainage structures, and/or storm sewer installation, manholes or inlet construction or those utilities that lie within the normal excavation limits for these structures. Construction personnel should be consulted for assistance in determining the excavation limits. Major utilities are also defined as water mains (6 inches or larger), all gas lines except service lines, telephone-coaxial toll lines and multi-duct lines, telephone cables and ducts (50 pair or larger), sanitary lines (all gravity flow mains), sanitary force mains (6 inches or larger) and electric power cable (all buried electric transmission cables - not service lines). Service connections are not to be considered as major utilities.

Positive verification of utility locations can be either by DOT or consultant survey or utility company verification based on previous surveys or certified as built plans. To avoid obtaining detailed verification at locations that may not be necessary, it is desirable that designs be advanced to the stage that the location of the storm sewer is known. It will be the responsibility of the District

Utility Engineer, or his designee, with assistance from the Designer and construction personnel to determine the appropriate locations of positive verification.

#### 5.4.1 Locating Underground Utilities

To further identify the responsibilities of the Department and utility companies regarding the location of underground utilities, the following will be used along with, and in accordance with, the Location Survey Manual:

1. Contact the utility owner, give details as to the location, length, and/or extent of job. Advise if the underground utilities are to be located horizontally only, or that they will have to be uncovered and located both horizontally and vertically. Request that personnel necessary to locate the utilities meet DOT or consultant forces at a specific time and place.
2. All underground utilities must be marked by the company representative with a DOT employee or consultant present, giving size, type and use. The utility company will furnish the DOT with as built plans, if available. The DOT or consultant survey forces will tie all major utilities and others deemed necessary to the centerline or baseline of survey and record all field data usually horizontally only, giving the approximate depth estimated by the utility company representative. If field verified vertical data are also available, these data will also be shown by positive tie in the field book.

3. During the design of the project, those major utilities requiring vertical location of the underground utilities will be identified. The utility company will be contacted to uncover (dig, excavate, and so forth) their utilities as deemed necessary by the DOT. The DOT location or consultant survey personnel will locate and record all findings, both horizontally and vertically, showing the positive horizontal and vertical ties in the field book for future reference. All storm sewer systems and sanitary sewer gravity flow lines will be shown as presently outlined in the Location Survey Manual.
  
4. All as built plans obtained from the utility companies are to be marked as follows:

Date  
DOT Job No.  
Party Chief  
Utility Company  
Utility Company Representative

All field books in addition to the standard heading, index, etc., will denote the following:

Date  
Personnel  
Utility Company  
Utility Company Personnel  
Utility Company Work Order No., if applicable.

Those locations where positive horizontal and vertical location is known will be designated on the plans. It is important to the contractors bidding on projects to know at which locations the information is exact and not interpolated. Volume II gives specific instructions on how to show this information on the plans.

## 5.5 Coordination Process

Copies of plans, with all utilities shown, should be given to the utility owner for verification at approximately 30% design completion stage. Right-of-way map or R/W key map with existing utilities shown may be used for utility contact. The District Utility Engineer normally coordinates this activity through a utility predesign conference. The utility owners are required to verify or indicate the correct location of their respective utilities within the project limits on the plans provided to them. These marked up plans should be used by the design team to show the correct locations, horizontal and vertical, of the various utilities.

The designer should make every effort to design a project that will avoid conflicts with major utilities. At 60% completion of the project, when the drainage design is well underway, the potential utility conflicts should be identified. Only major utilities potentially in conflict shall be field verified horizontally and vertically.

At approximately 80% completion of plans, the utility companies should be provided with two sets of plans showing all utilities. One marked up set is transmitted back to the designer and the other is retained by the utility company for their use.

To reduce potential problems and delays during the construction phase due to utilities, full size plan sets should be supplied to each utility company after plans are printed in Tallahassee. During the utility design meeting, each district utility office should determine which companies want and need a full size plan set to fulfill their responsibilities. The form shown in Exhibit I-5-A is to be completed and sent to Tallahassee with the plans transmittal package. The form will be detached and sent to the reproduction office with the plans and the required number of full size sets of blueprints will be sent to the District Utility Engineer for disbursement to the appropriate utility.

companies. If no form is attached to the plans transmittal package, it will be assumed that no full size prints are being requested for that project. When or if subsequent plan revisions are made, the District Utility Engineer will automatically receive one set of sepia of the revised sheet(s) so copies can be made and forwarded to the utility companies for inclusion in their full size sets.

5.5.1 Coordination of Traffic Monitoring Sites

The Transportation Statistics Office in Tallahassee should be notified of any work within 0.5 mile of a traffic monitoring site. If relocation or reconstruction of the site is required, the action should be made part of the project. The Transportation Statistics Office can provide plans and specifications and other information, if needed.

REPRODUCTION REQUEST  
(Utility Blueprints)

PROJECT NO.(S)	COST CENTER	NO. OF FULLSIZE SETS OF BLUELINES
SEND TO	PHONE NO.	DATE
District ____ Utility Engineer		

ATTACH TO TRANSMITTAL MEMO



## Chapter 6

### RAILROAD CROSSING

#### 6.1 General

A railroad-highway crossing, like any highway-highway intersection, involves either a separation of grades or a crossing at grade. The geometrics of a highway and structure that entails the overcrossing or undercrossing of a railroad are substantially the same as those for a highway grade separation without ramps.

Selection of the warning devices to be used is a function of the geometrics of railroad-highway grade crossing, including the alignment, profile, sight distance and cross section of both the roadway and the railroad. Railroad grade crossing angles should be as near 90 degrees as practical.

Design Criteria and Standards are given in the Florida Green Book and the Department's Railroad Procedures Manual Volume III. Design considerations are discussed in Chapter IX of the AASHTO policy on Geometric Design.

## 6.2 Devices

Traffic control devices for railroad-highway grade crossings consist primarily of signs, pavement markings, flashing light signals and automatic gates. A large number of significant variables must be considered in determining the types of warning device to be installed at a railroad grade crossing. The type of highway, volume of vehicular traffic, volume of railroad traffic, speed of vehicular traffic, volume of pedestrian traffic, accident record, and geometrics of the crossing are some of the factors influencing the choice of warning devices to be provided at the railroad crossing. Standards and criteria for design placement, installment and operation of these devices are covered in the MUTCD and the Department's Railroad Procedure Manual Volume III. The Department's Roadway and Traffic Design Standards should also be consulted in the design of railroad crossings.

### 6.3 Surfaces

The highway traveled way at a railroad crossing should be constructed for a suitable length with all-weather surfacing. A roadway section equal to the current or proposed cross section of the approach roadway should be carried across the crossing. The crossing surface itself should have a riding quality equivalent to that of the approach roadway. When selecting the type of crossing and the material to be used in its construction, consideration should be given to the character and volume of traffic using the highway. The Department's Highway-Railroad Grade Crossing Material Selection Handbook should be consulted in selecting the material.

Roadway Design Standard Index #560 contains specifications for the construction of crossings of the following types:

- Bituminous
- Wood Plank Crossing
- Prefabricated Sectional Treated Timber Crossings
- Concrete Slab Crossings (Precast)
- Concrete Slab Crossings (Prestressed)
- Steel Grid Crossing
- Rubber (Elastomeric) Panel Crossings
- Epoxy-Rubber Mix Cast-In-Place Crossings
- Linear High Density Polyethylene Modules Crossings

#### **6.4 Clearances at Railroad/Highway Structures**

An offset horizontal dimension to the abutment slope of up to 20 feet from the centerline of tracks requires no special justification. Horizontal offsets in excess of 20 feet should be justified based on individual site conditions. Vertical clearances up to 23' 6" require no special justification. Greater vertical clearances can be justified based on special site conditions or the need to meet documented railroad electrification plans. The horizontal clearance to an obstruction is a minimum of 9 feet. Greater clearances may be necessary to preclude the placement of piers in drainage ditches. Roadway Design Standard Index 280 contains additional criteria for culvert clearances below railroads.

## Chapter 7

### SIGNING, MARKING, LIGHTING AND SIGNALS

#### 7.1 General

Traffic control devices are necessary to help ensure highway safety by providing the orderly and predictable movement of all traffic, motorized and non-motorized, throughout the highway transportation system, and to provide such guidance and warnings as are needed to ensure the safe and informed operation of individual elements of the traffic stream. The design and layout of signs, signals, pavement marking and lighting should complement the basic highway design.

#### 7.2 Signing and Marking

The designer responsible for a signing and marking project should be aware that the design must comply with various standards. In addition to Department Standard Specifications, the following standards should be consulted:

Manual on Uniform Traffic Control Devices (MUTCD) - The MUTCD was adopted by the Department as the uniform system of traffic control for use on the streets and highways of the State. This action was in compliance with Chapter 316.0745 of the Florida Statutes. The MUTCD is therefore the basic guide for signing and marking. The requirements of the MUTCD must be met, as a minimum, on all roads in the State.

Standard Highway Signs, FHWA - This manual contains detailed drawings of all standard highway signs. Each sign is identified by a unique designation. Signs not included in this manual or in the Roadway and Traffic Design Standards must be detailed in the plans.

| Standard Specifications for Structural Supports for Highway Signs, Luminaires and  
| Traffic Signals, AASHTO and Structures Design Guidelines, FDOT - These documents  
| provide structural design criteria

Roadway and Traffic Design Standards - These standards are composed of a number of standard drawings or indexes which address specific situations which occur on a large majority of construction projects

#### 7 2 1 Design Criteria

The MUTCD and the Roadway and Traffic Design Standards should be consulted for sign location. All signs not bridge or barrier wall mounted and installed within the clear recovery zone, must be frangible or protected by an approved barrier. Chapter 4 of this volume contains detailed instructions on safety design.

Post sizes for single column signs are covered in the Roadway and Traffic Design Standards. The supports for multi-post signs are not in that reference and must be included in the plans. The designer must provide post sizes and length for each multi-post sign. The Structures Design Office has written a program for personal computers that calculates post sizes and length for multi-post signs. This program may be used for these calculations.

| When specified, signs will be illuminated with 175 watt mercury vapor Deluxe White Lamps. The following table gives the number of luminaires for various sign widths. See Roadway and Traffic Design Standard Index 17505 for spacing details and mounting location.

<u>Sign Width</u>	<u>To 10'</u>	<u>To 21'</u>	<u>To 32'</u>	<u>To 43'</u>
Luminaires	1	2	3	4

7 2 2 Wind Loading Criteria - Signs

The wind loadings given below were taken from the AASHTO Standard Specification For Structural Supports For Highway Signs, Luminaires and Traffic Signals. The Counties are listed by wind loading for the appropriate sign type

GROUND SIGNS

- 60 MPH Alachua, Baker, Bay, Bradford, Calhoun, Clay, Columbia, Escambia, Gadsden, Gilchrist, Hamilton, Holmes, Lafayette, Lake, Leon, Liberty, Jackson, Jefferson, Madison, Marion, Okaloosa, Putnam, Santa Rosa, Sumter, Suwannee, Union, Walton, Washington
- 70 MPH Citrus, DeSoto, Dixie, Duval, Flagler, Franklin, Glades, Gulf, Hardee, Hendry, Hernando, Highlands, Hillsborough, Levy, Nassau, Okeechobee, Orange, Osceola, Pasco, Pinellas, Polk, Seminole, St Johns, Taylor, Wakulla
- 80 MPH Brevard, Charlotte, Collier, Indian River, Lee, Manatee, Martin, Palm Beach, Sarasota, St Lucie, Volusia
- 90 MPH Broward, Dade, Monroe

OVERHEAD SIGNS

See Structures Design Guidelines

### 7 2 3 Project Coordination

Coordination with other offices and other agencies is a very important aspect of project design. The offices discussed in this section are not intended to be an all inclusive list with which the designer should coordinate, but are those that are typically involved in a signing and marking project.

Roadway Design - The designer of a signing and marking project receives the base sheets for design from the roadway designer, who can also provide any required cross sections. If the signing project is not an active roadway design project, base sheets may be obtained from existing plans or aerial photographs.

Utilities - The District Utilities Engineer provides the coordination between the designer and the various utilities involved in the project. The Utilities Section can also identify potential conflicts with overhead and underground utilities or verify those which have previously been identified. The District Utilities Engineer should be contacted as early in the design phase as possible.

## 7.3 Lighting

The designer responsible for a highway lighting project should be aware that the design must comply with various standards. In addition to the Department's Standard Specifications, the following standards should be consulted:

An Information Guide for Roadway Lighting, AASHTO -- This is the basic guide for highway lighting. It includes information on warranting conditions and design criteria.

Standard Specifications for Structural Supports for Highway Signs, Luminaires and Traffic Signals, AASHTO -- This specification contains the strength requirements of the



poles and bracket arms for the various wind loadings in Florida as well as the frangibility requirements. All Luminaire supports, poles and bracket arms must be in compliance with these specifications.

Roadway and Traffic Design Standards -- These indexes are composed of a number of standard drawings or indexes which address specific situations which occur on a large majority of construction projects.

### 7.3.1 Design Criteria

The AASHTO Guide for Roadway Lighting permits either the illuminance technique or the luminance technique to be used in the design of highway lighting. The luminance technique requires a more complex design process and a knowledge of the reflective characteristics of the pavement surface used. These reflective characteristics change as the pavement ages and with variations in weather conditions. The Department has elected to use the illuminance technique for lighting design. The design values for light levels given by the AASHTO Guide for Roadway Lighting are maintained values. The light levels given in this criteria have been adjusted and are listed as average initial horizontal footcandles (HFC). This, in effect, sets the maintenance factor to be used in the calculation process to a value of 1.

Mounting height (MH) for conventional lighting is the vertical distance from the roadway to the light source, regardless of lateral placement of the pole. Pole setback is the horizontal distance from the edge of the travel lane to the pole.

### 7 3 2 Pole Design Criteria

Roadway and Traffic Design Standards Index 700 specify minimum setbacks for conventional lighting. A 20 foot minimum should be used where possible. Poles should be located at least 4 feet behind the face of guard rail and from the face of curbs. High mast lighting poles should be located as far from the travelled way as possible and in no case shall they be within the clear zone unless the pole is protected by barrier wall or guardrail. High mast lighting poles should not be located in gore areas within the runout length as defined in the AASHTO Roadside Design Guide. Engineering judgement should be used when locating high mast poles adjacent to bridges and high fills. All conventional height poles shall be frangible unless bridge or barrier wall mounted.

Frangible pole installations shall not be used in areas of heavy pedestrian traffic where the hazard of a falling pole is a greater hazard to others than it is to the motorist. See Roadway and Traffic Design Standards for frangibility requirements.

The installation of lighting in certain locations (e.g. adjacent to residential areas) may require the luminaires to be shielded. This is especially true for high mast poles.

Poles on bridges over open bodies of water or on causeway sections should be considered for dampers. These poles are subject to sustained winds of a critical velocity which may induce vibrations in the pole.

### 7 3 3 Foundations Criteria

Foundations for high mast poles are not standard and designs must be provided for each project. Boring data should be requested to provide a basis for the design. For additional design information, see the Structures Design Guidelines.

#### 7 3 4 Wind Loading Criteria - Lighting

See the Structures Design Guidelines

#### 7 3 5 Lighting Project Coordination

Coordination with other offices and other agencies is a very important aspect of project design. The offices discussed in this section are not intended to be an all inclusive list with which the designer should coordinate, instead it includes offices that are normally involved in projects.

- o Roadway Design - Normally the designer of a lighting project receives the base sheets for lighting design from the roadway designer. The roadway designer can also provide any required cross sections. If the lighting project is not an active roadway design project, base sheets may be obtained from existing plans or aerial photographs. If copies of existing plans are used for base sheets, the drainage maps are usually a good choice.

- o Utilities - The District Utilities Engineer provides the coordination between the designer and the various utilities involved in the project. This usually is limited to agreements with the power company for electrical service. The Utilities Section can also identify potential conflicts with overhead and underground utilities or verify those which have previously been identified.

The Utilities Engineer should be contacted as soon as pole locations are set and the electrical load has been determined. The designer should indicate a preferred location for the electrical service location.

o Soils - Conventional height poles require the standard base shown in the Roadway and Traffic Design Standards, and only require foundation designs in special cases. High mast poles, on the other hand, require foundation designs for each location. Soil Borings are required for the design of the foundations. The District Soils Engineer should be requested to provide soils data as soon as high mast pole locations are determined.

o Drainage - When the locations of high mast poles are established, they should be checked with the Drainage Section to determine if high water level is a problem. High mast poles are often located in the center of interchange loops. These same areas may be used as drainage retention areas. Coordination with the Drainage Section will alleviate this type problem.

Chapter 14-64 of the Department Rules established the maintenance responsibility of lighting systems not on limited access or toll facilities as a local government function.

Normally the District Traffic Operations Engineer in conjunction with the District Utilities Engineer obtain the required maintenance agreements. The designer should coordinate with these offices to ensure that this activity is either underway or scheduled.

Any lighting project, especially high mast, adjacent to or in the vicinity of an airport, may be a potential problem. Any lighting project within 3 miles of an airport should be discussed with the Office of Public Transportation, Aviation Office to determine if a problem exists.

### 7.3.6 Voltage Drop Criteria

When determining conductor sizes for lighting circuits, the maximum allowable voltage drop from the service point on any one circuit is 7%.

## 7.4 Traffic Signals

The designer responsible for a traffic signal project should be aware that the design must comply with various standards. In addition to the Department's Standard Specifications, the following standards should be consulted:

Manual on Uniform Traffic Control Devices (MUTCD), FHWA - The MUTCD was adopted by the Department as the Uniform System of traffic control for use on the streets and highways of the State. The action was in compliance with Chapter 316.0745 of the Florida Statutes. The MUTCD is therefore the basic guide for traffic signals. The requirements of the MUTCD must be met, as a minimum, on all roads in the State.

Standard Specifications for Structural Supports for Highway Signs, Luminaires and Traffic Signals, AASHTO and Structures Design Guidelines, FDOT - These documents provide structural design criteria.

Roadway and Traffic Design Standards - These standards are composed of a number of standard drawings or indexes which address specific situations which occur on a large majority of constructions.

### 7.4.1 Design Criteria

The MUTCD, as noted above, has been adopted as the uniform system of traffic control for use on the streets and highways of the state. The MUTCD is the basic guide for traffic signal design, therefore, the traffic signal designer should be familiar with this document. The criteria below supplements the MUTCD.

#### 7 4 2 Certification and Specialty Items

Traffic signal equipment installed in Florida is required to be certified by the Department. The Office of Traffic Engineering in the Central Office is charged with the responsibility of certifying traffic control equipment. The designer of a traffic signal project, if requiring new equipment types or types not normally used, should contact Traffic Engineering in Tallahassee to determine the certification status of the equipment. Non-certified equipment cannot be used.

Standard specifications have not been developed for all signal equipment. Some items are project dependent and the development of standard specifications is difficult. Specifications for these items must be developed on a project by project basis and included in the contract as a special provision. Some of these specialty items are included on the Department's approved products list. For these items, detailed specifications are not required. The Office of Traffic Engineering should be consulted on these items.

#### 7 4 3 Stop Line Location

A stop line which is not properly located invites violation by the motorist. The MUTCD specifies the minimum and maximum distances from the signal head to the stop line for adequate visibility. The traffic signal designer must insure that this requirement is met.

Instead of relocating the signal heads, the stop lines at many intersections have been moved from their proper location to comply with these requirements. The tendency for the motorist is not to stop at the new stop line location, but rather to creep beyond the stop line. This could in some cases result in valid calls being dropped, thereby increasing delay and decreasing the overall efficiency of the intersection.

The first step in the design process should be to locate crosswalks and stop lines properly. Then the signal head location should be determined to meet the MUTCD requirements. This may require changing the mounting configuration. A box span, for example, may be required where a diagonal span would normally be installed.

#### 7.4.4 Controller Timings

The development of controller timings is a basic part of traffic signal design. A recent ruling from the Board of Professional Engineers stated that the development of timings is considered engineering and therefore requires the signature and seal of a professional engineer.

All traffic signal designs prepared for or by the Department shall include initial timings of all controllers. This is also true for signals to be included in local systems. If the timings in the plans are not implemented, it will be the responsibility of the agency providing the timings to insure they were prepared under the supervision of a professional engineer.

#### 7.4.5 Left Turn Treatments

The guidelines given below should be followed when determining signal treatments for left turns.

##### o Single Turn Lane

Restrictive/Permissive Phasing - A five-section cluster should be used for this location. The head should be installed over the lane line between the left turn lane and through lane. The five-section cluster can serve as one of the two indications required for the through traffic.

Restrictive Phasing - A separate signal head for the left turn lane with red, yellow and green arrow indications should be positioned over the center of the left turn lane

o Dual Turn Lanes

Only restrictive phasing should be used. Permissive movements should not be allowed for dual turn lanes. A single three-section head with red, yellow, and green arrow indications should be centered over each turn lane. These heads are in addition to the dual indications required for the thru movement.

o Separated Turn and Thru Lanes

Turn lanes that are separated from the thru lanes more than 10 feet by a raised or painted island shall not be operated in the permissive mode.

o Single Lane Approach on Stem of "T"

Two three-section heads are required as minimum. All indications must be circular in this situation.

o Two Approach Lanes on Stem of "T"

Option #1 The approach may display two three-section heads with circular indications on all sections.

Option #2 The approach may display a five-section cluster in conjunction with a three-section head. If the lanes are exclusive left and right turn lanes, then the five-section cluster should be placed over the center of the lane line and the three-section head over the major movement lane. If one of the lanes is a shared left and right lane, then the five-section cluster should be placed over the center of this lane and the three-section head over the center of the other lane.



Option #3 The approach may display two three-section heads for the major movement and a single three-section head for the secondary movement

o Three Approach lanes on Stem of "T"

Option #1 The approach may display two three section heads for the major movement and one for the secondary movement (Exclusive left and right turn lanes)

Option #2 The approach may display a five-section cluster in conjunction with three-section head (exclusive left and right turn lanes) The five-section cluster should be placed over the center of the lane line separating the left turn lane(s) from the right turn lane(s) The three-section head should be placed over the other lane line to provide dual indication for the major movement

Option #3 When the middle lane is a shared left and right turn lane, then a five-section cluster should be placed over the center of this lane and a three section head placed over each of the other two lanes Each head must contain green and yellow arrow indications in this situation

NOTE

- 1 For all cases, the approach shall display "dual indications" This means that there must be at least two heads with identical indications on the major approach For example, if a green arrow is displayed on one head of the major movement or approach then a green arrow must be displayed on the second head
- 2 The same signal display option should be used throughout an urban area to provide consistency in display to the motorist

- 3 The use of advance and/or overhead lane use signs should be used as a supplement to pavement arrows on stems of signalized "T" intersections

#### 7 4 6 Signal Preemption

The engineer responsible for the design of a traffic signal project should, as a matter of routine, check each intersection to determine if the need for signal preemption is present

Intersections located within 200 feet of moveable span bridges or railroad crossings should be considered Those located at distances greater than 200 feet should be considered if the queues frequently extend to the moveable span or crossing

Intersections near fire stations require individual study This is necessary to determine the interaction between the fire station vehicles and the intersection operation This information must be known before the preemption sequence can be developed

#### 7 4 7 Intersection Design - Lane Configuration

The engineer responsible for the traffic signal design may be asked to verify the number and configuration of traffic lanes required for an intersection to function properly when signalized

The results are dependent upon the traffic volumes used in the analysis The traffic used for this calculation shall be the design hourly volume based on the 30th highest hour (k factor) and not a peak to daily (P/D) ration based on a 24 hour count The k factor volumes account for traffic variations through the year, and, in most case, are higher than P/D volumes

The K, D, and T factors convert the two-way AADT volumes to a one-way Design Hour Volume (DHV). This is appropriate for the total approach movements. The AM and PM peak turning movement counts on each approach should be addressed individually. Current turning movement counts should be taken to determine the percentage of turns for each approach. These percentages should then be applied to the DHV for each approach volume to determine the turning volumes which should be used for the turn lane design calculations. These values should be compared to the movement counts supplied by Planning and the greater of the two values used for the design of turn lanes. The District Planning Office should be contacted to determine if recent counts are available and also if any use changes are planned which would require adjustments to the turn percentages found in the current counts.

Storage lanes for left turns can affect the capacity and safety of intersections. The storage length of a left turn lane is a critical design element. The queue of left turn vehicles in a storage lane of inadequate length may extend into the through lanes. The result is loss of capacity for the through lanes. The queue of through vehicles may also extend beyond the entrance of a short left turn storage lane blocking access to the storage lane. Either case results in a less efficient operation of the intersection and may cause last minute lane changes, thereby increasing the possibility of conflicts.

The important factors which determine the length needed for a left turn storage lane are

- o The design year volume for the peak hour (see discussion above)
- o An estimate for the number of cycles per hour  
NOTE: If the cycle length doubles, the length of the storage for the same traffic also doubles
- o The type of signal phasing and timing which will control the left turn lanes

There are several techniques used to determine necessary storage length. The following are suggested guidelines for left turn lanes:

- o Where protected left turn phasing is provided, an exclusive turn lane should be provided.
- o Left turn lanes should be provided when turn volumes exceed 100 vph and may be considered for lesser volumes if space permits.
- o For signalized intersections, the following formula may be used, assuming an average vehicle length of 25 feet:

$$L = \frac{(2.0)(DHV)(25)}{N}$$

Where

L = design length for left turn storage in feet

DHV = left turn volume during design peak hour, in vph

N = number of cycles per hour for peak hour, use N = 30 as default

- o Where left turn volumes exceed 300 vph, a double left turn should be considered.
- o When right of way has already been purchased, and the designer has to choose between a long wide grass median or a long left turn lane, the storage length for the left turn should be as long as practical without hindering other access.

Right turn lanes are provided for many of the same reasons as left turn lanes. Right turns, are, however, generally made more efficiently than left turns. Right turn storage lanes should be considered when right turn volume exceeds 300 vph and the adjacent through volume also exceeds 300 vph.

#### 7 4 8 Signal Loops

Traffic signal loops are detailed in Roadway and Traffic Design Standard 17781. These loops are standard and will be appropriate for most locations.

The traffic signals for each intersection should be individually designed. The requirement for type and placement of loops is a part of this design. The above standard allows for some variation in size and placement of the standard loops. These modifications are intended to be used only when required by the design of a particular location.

#### 7 4 9 Wind Loading - Traffic Signals

See the Structures Design Guidelines

## Chapter 8

### Bicycles and Pedestrian Facilities

#### 8.1 General

Pedestrians and bicycle riders may often wish to travel between the same locations as other vehicular traffic. When this occurs, the designer should consider the effects on the safety and operation of the roadway system. A special effort should be made to provide the greatest degree of safety within the economic constraints that must always be considered.

Additional special bicycle and pedestrian facilities should be provided where the use of travel lanes or wide paved shoulders is deemed unacceptable or unsafe for the pedestrian or bicycle rider.

Pedestrian facilities include sidewalks, crosswalks, traffic control features, special walkways, curb cut ramps for the handicapped and bus facilities.

## 8.2 Sidewalks

The design of sidewalks is affected by pedestrian volume, traffic volume, average pedestrian age, walking rate, required level of service, location, etc. The Florida Green Book and the AASHTO Policy on Geometric Design present the various factors that influence the design of sidewalks and other pedestrian facilities.

All urban projects that have sufficient right-of-way to provide adequate lane, median, sidewalk and border widths should be thoroughly evaluated to provide a reasonably safe and cost effective design. A distance of as little as 2' between the back of sidewalk and right-of-way can be effective in minimizing construction easements by using a 1' berm and 2:1 slope or a 4:1 slope between the sidewalk and right-of-way. Differences in elevation up to 6" can be accommodated in this manner. Caution must be exercised in using this treatment at connections to driveways since this distance and slope will not assure adequate vehicular connections (see Index 515).

Sidewalks should be constructed in conjunction with all new construction, major reconstruction and lane addition curb and gutter projects. As a general practice, sidewalks should be constructed along both sides of arterial streets that are not provided with shoulders, even though pedestrian traffic may be light. Exceptions may be made to the construction of sidewalks on both sides of the street when the roadway parallels a railroad or drainage canal and pedestrians would not be expected and in some cases on bridges. If sidewalks are constructed on the approaches to bridges, they should be continued across the structure.

The standard width for sidewalks is 5 feet when separated from the curb by a buffer strip. When sidewalks are constructed adjacent to the curb, the minimum width should be 6 feet. Additional width of sidewalk should be provided for high pedestrian volumes, i.e. sidewalks in close proximity to schools. Separation between the curb and sidewalk should be provided when traffic volumes, truck volumes or vehicular speeds are high. The Department's Bicycle Facilities Planning and Design Manual states that it is important to recognize that the development of wide sidewalks does not necessarily add to the safety of sidewalk bicycle travel. Wide sidewalks encourage higher-speed bicycle use and can increase the potential for conflicts with motor vehicles at intersections, as well as with pedestrians and fixed objects. Both the AASHTO Guide for Bicycle Facilities and the Florida Green Book state that bicycle riding on sidewalks can be expected in residential areas with young children who are too inexperienced to ride in the street. This type of bicycle use is generally accepted, but it is not appropriate to sign a sidewalk as a bicycle path. Separate bike lanes should be provided when warranted to accommodate bicycle traffic. Five foot sidewalks are to be provided unless greater widths are justified for pedestrian use. A method for determining pedestrian facility needs is given in the Highway Capacity Manual.



### | **8.3 Disabled Access**

| Pedestrian facilities such as walkways and sidewalks must be designed to accommodate the  
| physically disabled persons whose mobility is dependent on wheelchairs and other devices Street  
| intersections with steep-faced curbs are one form of obstacle that can be alleviated while still  
| providing reasonable mobility for the disabled without sacrificing the mobility of others

In areas with sidewalks, curb cut ramps must be incorporated at locations where a marked  
crosswalk adjoins the sidewalk The basic ramp type and design application depends on the  
geometrical characteristics of the intersection Standard Index No 304 sets forth the  
requirements and standards of curb cut ramps for use in Florida Placement of inlets should not  
conflict with curb cut ramps

All Department facilities (roadway, parking lots, rest areas, buildings, pedestrian bridges, etc )  
| must be designed in compliance with Florida statutes, rules and regulations and Florida  
| Americans with Disabilities Accessibility Implementation Act. Design must also meet minimum  
| requirements of the American National Standards Institute (ANSI 117.1 - 1986 ) for  
| accommodation of the disabled

## 8.4 Bicycle Facilities

The bicycle has become an important element for consideration in the highway design process. In recent years the emphasis in bicycle system planning has changed from attempts to provide completely separate facilities for bicyclists to the growing recognition that bicyclists are legitimate users of the roadway. Recent studies have shown that in many cases shared roadway facilities afford greater safety for the bicyclists than sidewalk facilities because of the increased visibility and maneuverability. Certain measures such as

- o Paved shoulders, either designated or undesignated as bike lanes
- o Full bike lanes adjacent to curb and gutter, either designated or undesignated
- o Bicycle-safe drainage grates
- o Adjusting manhole covers to grade
- o Maintaining a smooth, clean riding surface
- o Bicycle corridors on off system routes

can considerably enhance a route's safety and capacity for bicycle traffic without impacting the service for motor vehicles on the roadway.

Planning and design consideration for bicycle facilities are given in the AASHTO Policy on Geometric Design and the AASHTO Guide for Development of New Bicycle Facilities.

The Department's current policy is to consider the needs of bicyclists on all projects, except limited access facilities. This policy will generally provide for the construction of bicycle lanes or paved shoulders for the needs of bicyclists in conjunction with other planned roadway improvements. The lack of adequate right of way and the cost associated with its acquisition in built up areas may not allow provision of the additional width for bicyclists on all projects. The inclusion of bicycle facilities on roadway improvements should be reviewed on a case-by-case basis analyzing anticipated bicycle travel and the need for wider pavement or paved shoulders. Anticipated bicycle travel should be considered of sufficient volume when the

roadway section is identified for bicycle improvements in the Transportation Improvement Program, the State Transportation Plan (Bicycle Elements) or other approved Community Comprehensive Bicycle Transportation Plans Planning for bicycle routes through local government contact is essential

The Department's Bicycle Facilities Planning and Design Manual should be referenced for the design of bicycle facilities Chapter 2 of this volume discusses shoulder width criteria when bicycle use is anticipated

## Chapter 9

### Landscaping

#### 9.1 General

The complete highway is one wherein the elements of design, construction and maintenance have been integrated to provide a facility that possesses utility, safety, beauty and economy. The highway should be considered as an element of the total environment, not apart from it or in conflict with it. All highway-oriented disciplines should collaborate at each stage of highway corridor selection, location, and design to obtain the maximum beneficial potential of the highway, its roadsides, and its environment.

The highway roadside is an integral unit of a total highway facility. The term "roadside" generally refers to the area between the outer edge of the roadway and the right-of-way boundary. It could include extensive areas in a wide median of a divided highway. Roadside development is the treatment given to the roadside to conserve, enhance, and effectively display the natural beauty of the landscape through which the highway passes. It should provide safety, utility, economy, and highway-related recreation facilities by means of proper location, design, construction, and maintenance.

Because the potential for conflict between the highway and environmental values is greatest in urban areas, it is essential that special attention be given to the multiple use-joint development possibilities in areas over, under, and adjacent to the highway to ensure that land and space above the highway provides the greatest benefit to the greatest number.

Landscape development should be in keeping with the character of the highway and its environment. Programs include the following general areas of improvement:

- o Preservation of existing vegetation.
- o Transplanting of existing vegetation where feasible.
- o Planting of new vegetation.
- o Selective clearing and thinning
- o Regeneration of natural plant species and material.

The objectives in planting or the retention and preservation of natural growth on roadsides are closely related. In essence, they are to provide vegetation that will be an aid to esthetics and safety, aid in lowering construction and maintenance costs, and create interest, usefulness, and beauty for the pleasure and satisfaction of the traveling public.

Landscaping of urban highways and streets assumes additional importance by mitigating many of the nuisances associated with urban traffic. Landscaping should be arranged to permit sufficiently wide, clear, and safe pedestrian walkways. Combinations of turf, shrubs, and trees are desirable in border areas along the roadway. However, care should be exercised to ensure that requirements for sight distances and clearance to obstructions are observed, especially at intersections.

Further information concerning landscape development and erosion control is presented in AASHTO's A Guide for Highway Landscape and Environmental Design. The Department's Roadway and Traffic Design Standards Booklet sets forth specific criteria and standards for erosion control and roadside landscaping. The Department's Landscaping Guidelines (document No. 650-050-001b) provides the general criteria for use in the development of landscaping plans for roadway projects.

## Chapter 10

### WORK ZONE TRAFFIC CONTROL

#### 10.1 General

The need to improve the capacity of, and to rehabilitate Florida's highways, has greatly increased the frequency of highway construction taking place immediately adjacent to or under traffic. The travelling public, as well as construction and inspection personnel, are exposed to conflicts that may become hazardous. In addition to the safety issue, the potential delays to the public, as traffic is interrupted by construction, can be significant. As a result, the Department places a great deal of emphasis upon ensuring that traffic can be accommodated through construction zones with minimum delay and exposure to unsafe conditions.

## 10.2 References

The following references contain the basic criteria for work zone traffic control in Florida

The Manual on Uniform Traffic Control Devices for Streets and Highways, (MUTCD), Federal Highway Administration Part VI of the MUTCD deals specifically with work zone traffic control Other parts of the MUTCD may also be useful in designing a traffic control plan

Traffic Control Devices Handbook, (TCDH) Part VI, Federal Highway Administration

Policy on Geometric Design of Highways and Streets, AASHTO

Roadside Design Guide, AASHTO, Chapter 9

Roadway and Traffic Design Standard Index Series 600, 415 and 700

Federal-aid Highway Program Manual (FHPM) 6-4-2-12

### **10.3 Comprehensive Work Zone Traffic Control Planning**

Consideration of traffic control must begin at the Project Development and Environmental (PD&E) study stage. Impacts on traffic, traffic handling options, constructability, and design features and constraints, as they affect traffic, are to be evaluated for each alternate alignment studied. The preliminary and final engineering reports must specifically address work zone traffic control.

Traffic control considerations must begin in the early stages of design, using the work zone traffic control material from the PD&E study as the basis. As the design progresses, the following should be considered

Design features and constraints Length of the project, lane configuration, and grade differentials between existing and proposed, interchanges and intersections, pavement materials, storm sewers, roadway lighting, utilities and bridge features are some of the design element decisions that might be influenced by work zone traffic control considerations

Contract specifications Provisions such as time restrictions on construction activities, incentive-disincentive clauses, daily, weekly and seasonal restrictions and special materials may be necessary. Public relations activities such as media releases, television and radio spots, hand bills, and highway advisory radio may be specified

Other actions Actions may need to be taken by the Department prior to or during construction that may not be a contract requirement. Examples are dealing with the media and local businesses, provisions for mass transit options to commuters, service patrols, improvements to alternate routes, coordination with other projects and maintenance activities, and special inspection requirements



Public input. On very large and complicated projects, it may be necessary to involve the public through informal public meetings to be held early in the design of a project. Close coordination with city and county officials may be necessary. Citizen and business advisory committees may be established as sources of input.

Utility work. If contract utility work is anticipated in conjunction with or during the highway construction, the Traffic Control Plan (TCP) must account for and adequately protect all work activities. The phasing of construction activities must be compatible with the utility work. Utilities, whose work affects traffic, are required to have a TCP by FHWA's FHPM 6-6-3-2. This requires early and effective coordination with utilities.

#### 10.4 Traffic Control Plans (TCP)

A TCP is a set of specific plan sheets, references to standard (typical) layouts, and/or notes on roadway plans describing how traffic will be controlled through a work zone. All projects and work on highways, roads and streets shall have a traffic control plan, as required by Florida Statute and Federal regulations. All work shall be executed under the established plan and Department approved procedures. The TCP is the result of considerations and investigations made in the development of a comprehensive plan for accommodating traffic through the construction zone. These considerations include the design itself, contract specifications, and plan sheets.

TCP sheets detail the proper delineation of traffic through the work zone during all construction phases. The complexity of the TCP varies with the complexity of the traffic problems associated with a project. Many situations can be covered adequately with references to specific sections from the Manual on Uniform Traffic Control Devices (MUTCD), the Traffic Control Devices Handbook (TCDH), or Roadway and Traffic Design Standard Series 600. Specific TCP sheets shall be required in the plans set whenever project conditions are not specifically addressed in a typical layout from the manuals noted above. This is usually the case for complex projects, and therefore references to Standard Indexes, as well as specific TCP sheets, will both likely be necessary.

A quality traffic control plan should include the following information for the mainline and any affected cross roads, side streets, and ramps:

- (1) the location of all advance warning signs and lighting units
- (2) temporary pavement markings, (including RPM's) for detours, transitions or other special situations
- (3) location of temporary barriers and attenuators
- (4) temporary drainage devices
- (5) channelizing devices at special locations
- (6) locations for special devices such as variable message signs (VMS), arrow boards, and temporary signals

- (7) VMS messages for each phase
- (8) signal timing for each phase, including method of temporary actuation if needed (Check with Traffic Operations Engineer)
- (9) location and geometry for transitions and detours
- (10) typical sections for each phase of work on all projects, except simple resurfacing projects, in order to show lane widths, offsets, barrier locations and other features influencing traffic control
- (11) the proposed regulatory speed(s) for each phase
- (12) reference to appropriate Standard Indexes or MUTCD drawings whenever applicable
- (13) appropriate quantities, pay items and pay item notes
- (14) resolve any conflicts between permanent signing and markings and work zone signing and markings
- | (15) key strategies such as service patrol, police, public service  
| announcements, Highway Advisory Radio, night work
- | (16) good plan notes
- | (17) address the need for maintaining existing roadway lighting
- | (18) work area access plan

Chapter 19, Volume II, Plans Preparation and Assembly, explains the required information for specific TCP sheets

Consideration must also be given to adjoining, intersecting or sequential work zones. This can be a particular problem with maintenance operations, bridge or roadway projects under different contracts, operations of other jurisdictions or utilities. When such work must take place, the operations must be coordinated and taken into account in the TCP so that the motorist encounters one, consistently designed, work zone.

TCP's for project designs "on the shelf" must be updated prior to contract letting.

## **10.5 TCP Development**

The following step-by-step process should be followed by designers when preparing traffic control plans

### **STEP #1 Understand the Project**

- o Field reviews by designers should be required
- o Review the scope
- o Examine the plans (30% - 60%)
- o Look at plan-profiles and cross-sections for general understanding
- o Review PD&E study for any constraints
- o Consider bicycle/pedestrian needs during construction
- o For complex projects consider developing a TCP study and possible TSM strategies such as public awareness campaigns, alternate route improvements, service patrols, etc

### **STEP #2 Develop Project Specific Objectives**

What are your objectives? Examples might be

- o use barrier wall to separate workers from traffic
- o close road if adequate detour exists
- o maintaining 2-way traffic at all times
- o maintaining existing roadway capacity during peaks
- o maintaining business/resident access
- o provide bike/pedestrian access
- o minimize wetland impacts
- o expedite construction

| STEP #3 Brainstorm TCP Alternatives

Develop some rough alternatives, considering what could be used to accomplish the work, such as constructing temporary pavement and/or temporary detours, using auxiliary lanes, placing 2-way traffic on one side of divided facility, using detour routes, etc. Also, southside as opposed to northside on an east-west roadway. Don't worry that an alternate doesn't meet all objectives.

Designers should check condition of any proposed detour routes. If off state system, may need agreement with locals.

| STEP #4 Develop a Construction Phasing Concept

- o Examine existing facility versus what is to be built  
This is a major task on jobs other than resurfacing
- o Coordinate with bridge designers
- o Color or mark the plan and profile sheets to show existing roadway versus new construction. Then, check station by station, the plan sheet against cross-section sheets. Make notes on plan sheets as to dropoffs or other problems. Use profile grade lines or centerlines for reference points.

- o List out major tasks to be completed, such as

construct new WB Roadway  
construct new EB Roadway  
construct frontage roads  
construct bridge/flyover

NOTE The designer may need input from construction personnel or even contractors representatives in determining construction phases

- o Make notes on plan sheets or notepad as to "decisions" that you make along the way

STEP #5 Examine/Analyze Alternatives Which Meet Objectives (for each phase).

Next, consider how you could achieve the proposed alternatives and meet the stated objectives

Examine pros and cons of various alternatives

Consider how much work and expense is involved for each alternative

Consider detour/transition locations, signal operations during construction, how to handle alternate modes of transportation-buses, bikes, pedestrians, service vehicles, etc

STEP #6 Develop Detailed TCP

Select the most feasible alternative for each phase Add details such as

- o detour/transition geometrics and locations
- o if lane closures are needed, use the lane closure technique discussed in 10 15 7 to determine time frame for closures,
- o advanced signing scheme and locations, revisions needed to existing signs - including guide signs, and proposed signs for all work activities - lane closures, detours, etc , on mainline, sideroads, x-roads and ramps
- o need for portable traffic signals, variable message signs, and barriers,
- o how existing operations will be maintained - side streets, businesses, residents, bikes, pedestrians, buses - bus stops, etc ,
- o revisions to signal phasing and/or timing during each TCP phase,
- o regulatory speed desired for each phase,
- o all pay items and quantities needed for TCP

- o how existing Auxiliary lanes will be used and any restriction necessary during construction.
- o typical sections for each phase
- o outline key strategies to be used
  - (a) service patrol
  - (b) police
  - (c) public service announcements
  - (d) Highway Advisory Radio
  - (e) night work
  
- o need for Alternate route improvements

## 10.6 Coordination

Work zone traffic control can be a complex undertaking that requires the coordination of a number of agencies and other interested parties. Planning and coordination must begin early in a project design.

Traffic control is a joint responsibility of design (both roadway and bridge), construction and traffic operations personnel. Coordination is necessary by all three parties in the development of TCPs. Both traffic operations and construction personnel must routinely review TCPs in the early stages of development (30 - 60% plans) to ensure that the plan is sound and constructible and bid items are complete and quantities reasonable. Designers are also encouraged to contact contractors for ideas on Traffic Control Plans.

Traffic control plans should also be reviewed with other appropriate offices such as maintenance, FHWA, community awareness teams, public, businesses, freeway coordinator management teams and local agencies. Initial reviews should be made by construction and traffic operations no later than the 60% plans stage with subsequent reviews of 90% plans. Input from local engineering and law enforcement agencies should be obtained early in the process, such as during the PD&E study and the 30% plans stage.

Adjoining work zones may not have sufficient spacing for standard placement of signs and other traffic control devices within their traffic control zones. These situations can occur when separate contracts adjoin each other (separate bridge and roadway contracts are a typical example), utility work performed separately from roadway work or when maintenance activities are performed adjacent to a construction project. Where such restraints or conflicts occur, or are likely to occur, the designer should try to resolve the conflicts in order to prevent misunderstanding on the part of the travelling public.



### 10.6 1 FHWA Review

The type and format of TCPs on Federal-aid projects must be coordinated with FHWA early during design. TCPs for federal aid projects are to be submitted to FHWA for review not later than at the 60% plan stage.

### | 10.6 2 Phase Submittals

| TCP phase submittals should include the following:

| Phase I (30%) - a typical section for each phase as well as a description of the phasing sequence and work involved.

| Phase II (60%) - a majority of the TCP completed (~75-90%) including the information outlined in section 4 of this chapter (Section 10.4) and a list of the pay items needed.

| Phase III (90%) - a final TCP, including all notes, pay items and quantities.

## 10.7 Work Zone Traffic Control Training

### 10.7.1 Background

Work zone traffic control is an important function affecting the safety of the traveling public, contractor personnel and equipment, and department employees. Every reasonable effort should be made to eliminate or reduce involvement in accidents within work zones. Proper traffic control training is vital to achieving this objective.

The Department's Maintenance of Traffic Committee consists of representatives from Roadway Design, Construction, Safety, Maintenance, Traffic Engineering, Value Engineering and FHWA. Its purpose is to develop, review or revise procedures, standards and specifications regarding work zone traffic control to maximize efficiency and enhance safety of motorists, pedestrians, and workers in these zones.

### 10.7.2 Training Requirements

The Department's Maintenance of Traffic Committee has prescribed work zone traffic control training requirements for Department employees and shall furnish training course information and requirements to each District's Human Resource Development Manager.

Every employee, including consultants, whose activities affect maintenance and construction work zone safety, from upper-level management through construction and maintenance field personnel, shall complete appropriate training as prescribed above and as required by Department procedure number 750-030-006-a.

District Design, Construction, and Maintenance Engineers shall ensure that employees, including consultant personnel, who are responsible for traffic control plan design, implementation, inspection or supervision of the design, selection, placement, or maintenance of traffic control schemes and devices in work zones have been certified under the provisions of this procedure.

## 10.8 Traffic Control Devices

Traffic control devices/methods that are available for use include

- Signs (warning, regulatory and guide)
- Lighting units (arrow panels, barricade and sign lights, illumination devices, temporary signals and variable message signs)
- Channelizing devices (cones, tubular markers, plastic drums, vertical panels, Types I, II and III barricades)
- Markings (pavement markings, raised pavement markings, delineators, and removal of conflicting markings)
- Safety appurtenances (portable concrete barriers, guardrail and crash cushions) - See AASHTO Roadside Design Guide (Chapter 9).
- Flaggers
- Police
- Guardrail attached to barrels for work zones  $\leq$  45 mph - See AASHTO Roadside Design Guide

The MUTCD contains detailed instructions on the use of traffic control devices. Special design considerations applicable to Florida are discussed in the following sections

## 10.9 Signs

### 10.9.1 Advance Warning Signs

The TCP should identify the advance construction warning signs, including legends and location. These include signs such as "Road Construction Ahead", and "Road Construction One Mile". The TCP should provide the advanced warning signs, legends and locations for all proposed operations which require signing. These include detours, lane closures, and flagging operations on the mainline as well as crossroads. The sequence for advance signing should be from general to more specific. As an example: Road Construction Ahead (general), Left Lane Closed Ahead (more specific), Merge Right (specific).

### 10.9.2 Length of Construction Sign

The length of construction sign (G20-1) bearing the legend "ROAD CONSTRUCTION NEXT \_\_\_ MILES" is required for all projects of more than 2 miles in length. The sign shall be located at begin construction points. Mileages should be to nearest 0.1 mile.

### 10.9.3 Sign Covering

Signs (temporary and permanent) that warn of conditions shall be covered or removed when the condition is not present, such as might occur in work zones with daytime only operations. Traffic control signs that require covering shall be fully covered with a durable opaque sheet material. Plastic film and woven fabrics including burlap will not be permitted. Covering of only the legend or symbol will not be permitted. Reflective coverings will not be permitted. Hinged signs designed to cover when folded and sign blanks are permitted. Signs to be covered or removed will be identified in the TCP, along with acceptable procedures.

#### 10 9.4 Existing Signs

| Existing (regulatory, warning, etc ) signs that conflict with the TCP shall be removed. Existing guide signs should be modified as necessary. It is good practice to revise existing guide signs by using black on orange panels to show changes made necessary by the construction operations.

If permanent guide signs are to be removed during construction, provisions should be made for temporary guide signing. The temporary sign should be black on orange with the legend designed in accordance with MUTCD requirements for permanent guide signing whenever possible.

## 10 10 Lighting Units

### 10 10 1 Warning Lights

Warning lights shall be in accordance with Section 6E-5 of the MUTCD except for the limitations below

#### Flashing

Type A low intensity flashing warning lights should be mounted on barricades, drums, or vertical panels and are intended to continually warn drivers that they are approaching or proceeding in a hazardous area. Flashing lights shall not be used to delineate the intended path of travel, and shall not be placed with spacings that will form a continuous line to the driver's eye. The Type A light will be used to warn of isolated obstructions that are located adjacent to or in the intended travelway, and to mark the approach to closed or detoured travel lanes. Type A lights shall not be used in conjunction with the first and second advance warning signs.

Type B high intensity flashing warning lights shall be mounted on the first advanced warning sign and on the first and second advanced warning sign where two or more signs are used. This applies to all approaches to any work zone. The first and second advance warning signs shall be supplemented with an 18 inch by 18 inch warning flag.

### Steady-Burn

Type C steady-burn lights are to be mounted on barricades, drums, concrete barrier walls or vertical panels and used in combination with those devices to delineate the travel way on lane closures, lane changes, detour curves and other similar conditions. Steady-burn lights are intended to be placed in a line to delineate the traveled way through the work zone and around obstructions in the transition area, buffer space, work space and termination area of the traffic control zone. Steady burn lights often serve the dual purpose of delineation and hazard warning.

### 10 10 2 Advance Warning Arrow Panels

Arrow panels shall be used to supplement other devices for all lane closures on high-speed and high-traffic density multi-lane roadways. The use of arrow panels should be considered for all other multi-lane closures. These devices are also useful for short-term operations, such as during work zone installation and removal. Arrow panels should not be used in lane shift situations. Research has shown that motorists tend to change lanes (on multi-lane facilities) whenever an arrow panel is used to indicate a lane shift. Since this "response" is not desired, the arrow panel should not be used for lane shift situations on multi-lane roadways. Refer to MUTCD 6E-7 for further information.

Arrow panel locations shall be shown on the TCP, along with any necessary notes concerning the use of this device.

### 10 10 3 Variable Message Signs

Variable message signs may be used to supplement a traffic control zone. As a supplemental device, it cannot be used to replace any required sign or other device. These devices can be useful in providing information to the motorist about construction schedules, alternate routes, expected delays, and detours. Variable message signs should be considered for use in complex, high-density work zones. Messages must be simple, with a minimum number of words and lines and should require no more than three displays of no more than three lines each. The TCP shall include the location and messages to be displayed.

The message displayed should be visible and legible to the motorist at a minimum distance of 900 feet on approach to the signs. All messages should be cycled so that two message cycles are displayed to a driver while approaching the sign from 900 feet at 55 mph.

The VMS units may be used

- To supplement conventional traffic control devices in construction work areas and should be placed approximately 500' to 800' in advance of potential traffic problems, or
- 1-2 miles in advance of complex traffic control schemes which require new and/or unusual traffic patterns for the motorists



## Message Selection

Programmed messages should provide appropriate messages for the conditions likely to be encountered. The following items must be carefully considered in the development of a message.

- (1) Message elements - not necessarily in order
  - (a) problem statement (where?)
  - (b) effect statement (what?)
  - (c) attention statement (who?)
  - (d) action statement (do?)
  
- (2) Message format
  - (a) will vary depending on content
  - (b) "where" or "what" will generally lead
  - (c) "who" and "do" follow in that order
  - (d) "who" often understood from "where"
  
- (3) Message length
  - (a) limited by reading time (e.g., 900' at 55 mph provides 11 seconds of reading time)
  - (b) limited by driver's processing capability
  - (c) 4 word maximum, one part message
  - (d) 8 word desirable max if two or three sequence message is used
  - (e) shorter messages desirable to permit multiple readings
  - (f) if two or three sequence messages is programmed, allow for off-time between messages

(4) Display format

- (a) discrete with entire message displayed at once is most desirable
- (b) sequential is OK, 2 part preferred, 3 part maximum
- (c) run-on moving displays prohibited
- (d) one abbreviation per panel display desirable, two abbreviations are maximum. Route designation is considered as one abbreviation and one word

EXAMPLE

	Display 1	Display 2	Display 3
(a)	R A M P TO SR 26 E C L O S E D	U S E A L T R O U T E	
(b)	I-95 R O A D C L O S E D	F O L L O W D E T O U R R O U T E	
(c)	I-495 A T E X I T 30	2 R I G H T L A N E S C L O S E D	E X P E C T D E L A Y S

### Typical Conditions

Consistent with the factors described above, VMS messages should be considered under the following conditions

- (1) Road closures
- (2) Ramp closures
- (3) Delays one hour or longer created by
  - (a) congestion
  - (b) accidents
  - (c) lane closures
  - (d) two-way traffic on divided highway
  - (e) multiple lane closures
  - (f) unexpected shifts in alignment

#### 10.10.4 Traffic Signals

Frequently portable or temporary traffic signals will be a preferred alternative to a flagger. Also, existing signal operations may need to be revised to accommodate the construction operations. The TCP should identify the specific alterations (physical location and timing) necessary for existing signals and the location and timing of portable signals. Signal displays and location must meet MUTCD requirements.

## 10.11 Channelizing Devices

### 10 11.1 Type III Barricades

12 foot Type III barricades have proven too cumbersome for work site applications. Two 6 foot Type III barricades should be used to block off or close a roadway. Whenever two 6 foot barricades are used together, only one warning light is required on the 12 foot of barricade.

### 10 11 2 Separation Devices

Placing two lane two-way operations (traffic) on one roadway of a normally divided highway (TLTWO) should be a last resort and should be done with special care. An analysis similar to that presented on pp 6-57 thru 6-61 of the TCDH, should be performed and documented when contemplating the need for TLTWO.

"Separation" is defined in FHPM 6-4-2-12 and requires the use of devices such as those presented on pp 6-57 and 58 of the TCDH. These include temporary barrier, drums, cones, tubular markers, or vertical panels. Separation devices are required for TLTWO unless (1) it is used on an urban street where speeds are low, or (2) drivers entering the TLTWO can see the transition back to normal one-way operation on each roadway. Striping, RPM's and signing alone, are not allowed when separation devices are required.

Experience has also shown that stand alone tubular markers for long term operations are difficult to maintain and therefore their effectiveness is questionable. The use of a temporary asphalt separator in conjunction with the tubular markers has been very effective (see Index 614)

| 10.11.3 Channelizing Device Alternates

| It is intended that cones, Type 1 and 2 barricades, vertical panels, drums  
| and tubular markers be considered as alternative channelizing devices to  
| be used at the contractor's option. The only exception to this is that  
| cones and tubular markers are not allowed at night. If the designer wants  
| to further restrict the options (i.e. require drums, etc.) it must be so  
| noted on the plans or in the supplemental specifications.

## 10.12 Pavement Markings

### 10 12 1 Removing Pavement Markings

Existing pavement markings that conflict with temporary work zone traffic patterns must be obliterated where operations will exceed one work period. Painting over existing pavement markings is not permitted.

### 10 12 2 Reflectorized Raised Pavement Marker (RPM)

Temporary RPMs are required on the lane lines of all transitions, crossovers and detours and to delineate temporary gore areas within the work zone. The spacing shall be 40 feet on tangent sections and 20 feet on transitions, curves and crossovers.

The designer should also consider using temporary RPMs on temporary lane lines, particularly on high-volume, high-speed facilities. An example would be on urban freeways where lane line removal and restriping is required due to lane shifts.

### 10 12 3 Work Zone Markings

Section 102-3.3 of the Standard Specifications, provides a pay item for "Non-Removable Pavement Markings" (Item #102-92-3 for skip and 102-92-4 for solid) which includes Non-Removable or Removable Pavement Markings depending upon the traffic pattern changes as noted in the Specifications. There is also a separate pay item for Removable Pavement Markings (Item #102-91-1 for skip and 102-91-2 for solid) that can be used in addition to the Non-Removable Pavement Marking Pay Item at the designer's option. If both non-removable and removable pavement markings are anticipated, then both pay items should be included in the plans. This will make contract administration and enforcement much easier for construction personnel.

The designer should also consider using a miscellaneous asphalt pavement pay item for covering unneeded markings, especially in areas such as detours or crossovers.

## 10.13 Safety Appurtenances for Work Zones

### 10 13 1 Traffic Barriers

Work zone traffic barriers are designed either as permanent barriers or as temporary barriers that can be easily relocated. They have four specific functions: to protect traffic from entering work areas, such as excavations or material storage sites, to provide positive protection for workers, to separate two-way traffic, and to protect construction such as false work for bridges and other exposed objects. The designer should anticipate when and where barriers will be needed and include this information and the quantities on the plans.

### 10 13 2 Portable Concrete Safety Shape (Temporary Barrier Walls)

Portable concrete safety shape barriers, also known as portable concrete barriers (PCB's), are widely used in work zones to protect motorists as well as workers. However, improper use of these barriers can provide a "false sense of security" for both the motorist and the worker. Therefore, care must be taken in their design, installation and maintenance. Installation instructions and flare rates are given in Standard Index 415.

To perform properly and redirect vehicles, the PCB system must be capable of withstanding severe impacts. The PCB's weakest point is its connector which includes the physical connection and mating faces of adjoining barriers or guardrail.

Acceptable connections are noted on Standard Index 415.

The designer should show or note the location of all temporary barrier wall in the plans. The plans should also include a work area access plan for those projects with median work which is shielded with barrier wall.



### 10 13 3 End Treatments

The desirable treatments for exposed ends of barriers are

- connecting to an existing barrier (smooth, structural connections are required - Refer to Index 410 and 415) or
- attaching a crashworthy terminal such as a crash cushion or
- flaring away to the edge of the clear zone (See Chap 6)

### 10 13 4 Modifications of Existing Barriers

When 2-way traffic is placed on a facility that is normally one-way, the existing permanent or temporary barriers will be modified as necessary to ensure their proper crashworthiness during the temporary situation. This will include eliminating non-crashworthy end-treatments, snag points or other protrusions normally angled away or hidden from approaching vehicles.

### 10 13 5 Crash Cushions

Crash cushions in work zones may be used in the same manner as at permanent highway installations. Crash cushions are used to protect the motorists from the exposed ends of barriers, fixed objects and other hazards within the clear zone. Two types of stationary crash cushions are commonly used, the sand filled plastic barrel (Index 415) system, and the GREAT CZ system. Selection of a system should be the result of an analysis of site condition (clear space and need), first cost and replacement cost after hits. The GREAT system is designed to shield a hazard and redirect vehicles, whereas sand barrels only provide hazard shielding. Therefore, the designer must determine what is needed in order to provide the appropriate device. The designer should anticipate the need for these devices and provide appropriate quantities on the plans. The AASHTO Roadside Design Guide can be consulted for more information.

10 13 6 Truck-Mounted Attenuator (TMA)

In many short-term, mobile, and moving work zones, trucks can be used as blocking vehicles to protect workers. Large trucks are effective in preventing vehicle encroachment into the work site, however, serious injury to occupants of the impacting vehicle and truck can result.

Crash cushions called truck-mounted attenuator (TMA) can be attached to the rear of these protective vehicles to reduce the severity of rear-end crashes. TMA may either be trailer or truck-mounted. If the designer sees the need for TMAs for a particular work zone activity, it should be noted on the plans and included in the pay items.

TMAs are used for three classes of protective vehicles in work zones:

- 1 Shadow Vehicle a moving truck spaced a short distance from a moving operation, giving physical protection to workers from traffic approaching from the rear.
- 2 Barrier Vehicle a truck parked upstream from a stationary operation and usually unoccupied.
- 3 Advance Warning Truck a truck parked a considerable distance upstream of a moving or stationary operation displaying an arrow panel and other signs as appropriate.

Shadow trucks and barrier vehicles may be equipped with a TMA. Advance sign trucks should use TMAs if they encroach on the traveled way. Protective vehicles usually are equipped with arrow panels, variable message signs or flashing amber lights.

A truck with a TMA must be positioned properly with respect to the work. If the TMA is too close to the work when hit, it may strike the worker, if too far back, traffic may go around it and hit the workers. The manufacturer's recommendations should be followed for deployment and use. A "rule of thumb" for spacing is less than 2 times the speed limit in feet (e g , 2 X 55 mph = 110 ft ) and at least 30 feet.

## 10.14 Flaggers

### 10 14 1 General

Flaggers shall be used only when other traffic control devices cannot adequately ensure safe and smooth traffic operations. Alternate devices such as temporary signals should be considered. Appropriate advanced warning signs shall be used in conformance with the MUTCD, and shall be removed when flaggers are not in use.

### 10 14 2 Location of Flaggers

Location of flaggers for known flagging operations shall be shown on the TCP, along with all notes necessary to fully explain conditions and requirements for their use. Refer to the MUTCD for further information on flagging.

### 10 14 3 Police Agencies

Police agencies (FHP, Sheriffs, or City Police) should be contacted for assistance in speed enforcement in work zones. Police escorts can also be used to assist dump trucks and other construction equipment in re-entering the traffic stream on high speed congested facilities. The designer should use plan notes or specifications to state which operations/ phases are anticipated as needing police assistance.

## 10.15 Layouts

Roadway Standard Index 601 through 650 are layouts of work zone traffic control for typical conditions. These indexes should be referenced only if project conditions are nearly the same as the typical layout. Otherwise, specific plan sheets or details must be prepared. Some conditions that will require specific plan sheets include

- Work not covered by a typical layout
- Nighttime work requiring special lighting, oversized or additional devices
- Ramps and intersections that interrupt the standard layout
- Sight distance restrictions such as horizontal or vertical curves.
- Lane or shoulder configurations that do not match the standards.
- Special considerations during installation, intermediate traffic shifts and removal
- Complex projects, including add-lane projects, that involve many phases, traffic shifts, entrances and exits

When designing layouts, the following shall be considered

### 10.15.1 Taper Lengths

Minimum taper lengths shall be calculated by the following formulas

- o  $L = S \times W$  for speeds of 45 MPH or more
- o  $L = W \times S^2/60$  for speeds of 40 MPH or less

Where "L" is the length of the taper, "W" is the width of the closed lane and "S" is the posted regulatory speed for the work zone, in MPH. Both L and W are measured in feet

The following table (taken from MUTCD 6C-2) gives the formulas for the lengths of the various taper types

Table 10 15 1  
Taper Length Criteria for Work Zones

<u>Type of Taper</u>	<u>Taper Length</u>
UPSTREAM TAPERS	
Merging Taper	L Minimum
Shifting Taper	1/2 L Minimum
Shoulder Taper	1/3 L Minimum
Two-way Traffic Taper	100 feet Maximum
DOWNSTREAM TAPERS	
(use is optional)	100 feet per lane

10 15.2 Intersecting Road Signing and Signals

Signing for the control of traffic entering and leaving work zones by way of intersecting highways, roads and streets shall be adequate to make drivers aware of work zone conditions. Under no condition will intersecting leg signing be less than a "ROAD CONSTRUCTION AHEAD" sign for approaching vehicles and a "END CONSTRUCTION" sign for departure vehicles unless the intersecting street consists of a shell, sand, or dirt surface, in which case it shall be left to the discretion of the engineer as to the need for this type signing. The designer should remember to include these signs in the estimated quantity for Construction warning signs.

Existing traffic signal operations that require modification in order to carry out work zone traffic control shall be as approved by the District Traffic Operations Engineer. If lane shifts occur, signal heads may have to be adjusted to maintain proper position. The DTOE should also determine the need for temporary loops for traffic actuated signals. The TCP should include all necessary signal adjustments.

### 10 15 3 Sight Distance To Delineation Devices

Merging (lane closure) tapers should be obvious to drivers. If restricted sight distance is a problem (e.g., a sharp vertical or horizontal curve approaching the closed lane), the taper should begin well in advance of the view obstruction. The beginning of tapers should not be hidden behind curves.

### 10 15 4 Pedestrians and Bicyclists

When pedestrians and/or bicyclists are accommodated on the existing facility (mainline or sidewalk), provisions must be included in the TCP to accommodate them during construction. Pedestrian accommodations through the work zone must include provisions for the handicapped.

### 10 15 5 Superelevation

Horizontal curves constructed in conjunction with temporary work zone detours, transitions, and crossovers should have the required superelevation. Under conditions where superelevation is not used, the minimum radii that can be applied are listed in the Table 10.15.2. Superelevation must be included with the design whenever the minimum radii cannot be achieved.

TABLE 10.15.2  
MINIMUM RADII FOR  
NORMAL CROSS SLOPES

<u>SPEED (MPH)</u>	<u>MINIMUM RADIUS (FEET)</u>
65	3130
60	2400
55	1840
50	1390
45	1080
40	820
35	610
30	430

10 15 6 Lane Widths

Existing lane widths of through roadways should be maintained through work zone travel ways wherever practical. The minimum widths for work zone travel lanes shall be 10' for all roadways other than Interstate. On Interstate highways the minimum width for work zone travel lanes shall be 11' except at least one 12' lane in each direction shall be provided.

10 15 7 Lane Closure Analysis

The lane closure analysis is a process used by designers to calculate the peak hour traffic volume and the restricted capacity for open road and signalized intersections. The analysis will determine if a lane closure should or should not be allowed and the time of day or night a lane closure could occur without excessive travel delay.

Exhibit I-10-A includes the Lane Closure Analysis Worksheets and two sample analyses. The Sample Lane Closure Worksheet (EX-I-10-A, sheet 3 of 11) has been cross-referenced to the Lane Closure Symbols and Definitions Sheet (EX-I-10-A, sheets 1 & 2 of 11) with circled numbers. The circled numbers correspond to the numbers of the symbols and definitions. The symbols and definition sheet shows the designer where to find the necessary information to fill out the Lane Closure Worksheet.

Fill out the top part of the Lane Closure Worksheet and complete the formulas to calculate the hourly percentage of traffic at which a lane closure will be permitted. Transfer these percentages to the graph on the Lane Closure 24 Hour Counts Sheet (EX-I-10-A, sheet 5 of 11). Draw a line across the graph representing the percentage for both open road and signalized intersections (see example EX-I-10-A, sheet 7 of 11). Plot the hourly percentages (hourly volume divided by total volume) on the graph. Any hourly percentage extending above the restricted capacity percentage lines for open road or signalized intersections indicated lane closure problems. The bottom of the graph gives times for AM and PM. By coordinating the lane closure problem areas to the time of day, a designer knows when to restrict lane closure.



| Many of Florida's roadways have directional peak hour traffic volumes,  
| with inbound morning traffic and outbound afternoon traffic. Doing a  
| composite lane closure analysis would in many cases require night work.  
| However, if a separate lane closure analysis is calculated for inbound and  
| outbound separately, a lane closure may be allowed and the contractor  
| could work in daylight hours. (See example EX-I-10-A, sheet 10 of 11  
| and EX-I-10-A, sheet 11 of 11.)

## LANE CLOSURES

### Symbols and Definitions

- 1 ATC = Actual Traffic Counts Use current traffic counts Traffic counts can be obtained from the Office of Planning, or you may need to get traffic counts done The designer needs hourly traffic volumes with a total traffic volume for a 24 hour period (see example EX-I-10-A, sheet 7 of 11)
- 2 P/D = Peak Traffic to Daily Traffic Ratio Highest hourly volume divided by the total twenty four hour volume Convert the percentage to a decimal on the Lane Closure Worksheet (see example EX-I-10-A, sheet 7 of 11)
- 3 D = Directional Distribution of peak hour traffic on multi-laned roads This factor does not apply to a two lane roadway converted to two way, one lane The directional distribution can be obtained from the Office of Planning
- 4 PMF = Peak Month Factor Many counties in Florida have a significant variance in monthly traffic volumes and since the actual date of a lane closure would be difficult to estimate, the designer should use the highest monthly factor divided by the factor for the month the counts were actually taken in calculating the volume on the Lane Closure Worksheet The Office of Planning has tables showing monthly traffic factors for every county in Florida (see sample table on EX-I-10-A, sheet 4 of 11)
- 5 RTF = Remaining Traffic Factor is the percentage of traffic that will not be diverted onto other facilities during a lane closure Convert the percentage to a decimal on the Lane Closure Worksheet This is an estimate that the designer must make on his own, or with help from the Office of Planning Range 0% for all traffic diverted to 100% for none diverted
- 6 G/C = Ratio of Green to Cycle Time This factor is to be applied when lane closure is through or within six hundred feet of a signalized intersection The Office of Traffic Engineering has timing cycles for all traffic signals
- 7 V = Peak Hour Traffic Volume The designer calculates the peak hour traffic volume by multiplying the actual traffic count, times peak to daily traffic ratio, times directional factor, times peak month factor, times remaining traffic factor This calculation will give the designer the expected traffic volume of a roadway at the anticipated time of a lane closure

EX-I-10-A  
Sheet 1 of 11

## LANE CLOSURES

### Symbols and Definitions

8. C = Capacity of a 2L, 4L or 6L roadway with one lane closed, and the remaining lane(s) unrestricted by lateral obstructions. The capacity of a 4L or 6L roadway is based on lane closure in only one direction (see Lane Closure Capacity Table on EX-I-10-A, sheet 3 of 11).
9. RC = Restricting Capacity of the above facilities by site specific limitations detailed in the MOT plans which apply to travel lane width, lateral clearance and the work zone factor. The work zone factor only applies to two lane roadways (see the tables on EX-I-10-A, sheet 4 of 11 to obtain the Obstruction Factor and Work Zone Factor).
10. OF = Obstruction Factor which reduces the capacity of the remaining travel lane(s) by restricting one or both of the following components: Travel lane width less than 12 feet and lateral clearance less than six feet (see MOT plans and Obstruction Factor Table in EX-I-10-A, sheet 4 of 11).
11. WZF = Work Zone Factor is directly proportional to the work zone length. The capacity is reduced by restricting traffic movement to a single lane while opposing traffic queues. The WZF and WZL only apply to a two lane roadway converted to two way, one lane (see the Work Zone Factor Table on EX-I-10-A, sheet 4 of 11).
12. TLW = Travel Lane Width is used to determine the obstruction factor (see MOT plans and the Obstruction Factor Table on EX-I-10-A, sheet 4 of 11).
13. LC = Lateral Clearance is the distance, in feet, from the edge of the travel lane to the obstruction. The lateral clearance is used to determine the obstruction factor (see MOT plans and Obstruction Factor Table on EX-I-10-A, sheet 4 of 11).

EX-I-10-A  
Sheet 2 of 11

LANE CLOSURE WORKSHEET

STATE PROJECT NO. \_\_\_\_\_ FAP NO. \_\_\_\_\_

WPI NO. \_\_\_\_\_ COUNTY. \_\_\_\_\_ DESIGNER \_\_\_\_\_

NO. EXISTING LANES: \_\_\_\_\_ SCOPE OF WORK: \_\_\_\_\_

Calculate the peak hour traffic volume (V)

$$V = ATC \text{ (1) } \times P/D \text{ (2) } \times D \text{ (3) } \times PMF \text{ (4) } \times RTF \text{ (5) } = \text{ (7) }$$

**LANE CLOSURE CAPACITY TABLE**

Capacity(C) of an Existing 2 Lane-Converted to 2 Way, 1 Lane = 1400VPH  
 Capacity(C) of an Existing 4 Lane-Converted to 1 Way, 1 Lane = 1800VPH  
 Capacity(C) of an Existing 6 Lane-Converted to 1 Way, 2 Lane = 3600VPH

Factors restricting Capacity

TLW (12) LC (13) WZL (11) G/C (6)

Calculate the Restricted Capacity (RC) at the Lane Closure Site by multiplying the appropriate 2L, 4L, or 6L Capacity (C) from the Table above by the Obstruction Factor (OF) and the Work Zone Factor (WZF). If the Lane Closure is through or within 600' of a signalized intersection, multiply the RC by the G/C Ratio

$$RC \text{ (Open Road)} = C \text{ (8) } \times OF \text{ (10) } \times WZF \text{ (11) } = \text{ (9) }$$

$$RC \text{ (Signalized)} = RC \text{ (Open Road) (9) } \times G/C \text{ (6) } = \text{ (9) }$$

If  $V \leq RC$ , there is no restriction on Lane Closure

If  $V > RC$ , calculate the hourly percentage of ADT at which Lane Closure will be permitted

$$\% = \frac{RC \text{ (Open Road) (9)}}{ATC \text{ (1) } \times D \text{ (3) } \times PMF \text{ (4) } \times RTF \text{ (5) }} = \text{ \_\_\_\_\_\_ } \%$$

$$\text{Signalized \%} = \text{Open Road \%} \times G/C \text{ (6) } = \text{ \_\_\_\_\_\_ } \%$$

Plot 24 hour traffic to determine when Lane Closure permitted. (See EX-I-10-A, Sheet 5 of 11)

NOTE: For Existing 2 Lane Roadways, D = 1.00.

Work Zone Factor (WZF) applies only to 2 Lane Roadways.

For RTF < 1.00, briefly describe alternate route: \_\_\_\_\_

LANE CLOSURES

CAPACITY ADJUSTMENT FACTORS

PMF SAMPLE

Tropic County Monthly Factors			
January	1 12	July	0 88
February	1 20	August	0 85
March	1 18	September	0 88
April	1 12	October	0 94
May	1 05	November	1 00
June	0 95	December	1 06

NOTE

February is the peak month in Tropic County-therefore the PMF in the 2L and 4L samples is  $1.20 \div 1.00$ . The counts were taken in November

OBSTRUCTION FACTORS (OF)

Lateral Clearance (LC)	Travel Lane Width (TLW)			
	12'	11'	10'	9'
≥6'	1 00	0 96	0 90	0 80
4'	0 98	0 94	0 87	0 77
2'	0 94	0 90	0 83	0 72
0'	0 86	0 82	0 75	0 65

WORK ZONE FACTORS (WZF)

WZL	WZF	WZL	WZF	WZL	WZF
200'	0 98	2200'	0 81	4200'	0 64
400'	0 97	2400'	0 80	4400'	0 63
600'	0 95	2600'	0 78	4600'	0 61
800'	0 93	2800'	0 76	4800'	0 59
1000'	0 92	3000'	0 74	5000'	0 57
1200'	0 90	3200'	0 73	5200'	0 56
1400'	0 88	3400'	0 71	5400'	0 54
1600'	0 86	3600'	0 69	5600'	0 52
1800'	0 85	3800'	0 68	5800'	0 51
2000'	0 83	4000'	0 66	6000'	0 50

Work Zone Length (WZL) for 2 Lane Roadways = Distance between opposing traffic queues

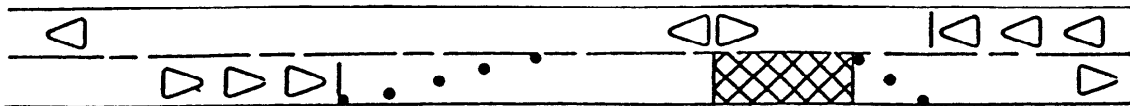

ADVANCE WARNING AREA - tells traffic what to expect ahead

TRANSITION AREA - moves traffic out of its normal path

BUFFER SPACE - provides protection for traffic and workers

WORK AREA

TERMINATION AREA - lets traffic resume normal driving

EX-I-10-A  
4 of 11

### LANE CLOSURES

24 HR COUNTS

TIME	AM HOURLY VOLUME	ATC %	PM HOURLY VOLUME	ATC %	
12 - 1	_____	_____	_____	_____	
1 - 2	_____	_____	_____	_____	
2 - 3	_____	_____	_____	_____	DATE _____
3 - 4	_____	_____	_____	_____	
4 - 5	_____	_____	_____	_____	DESIGNER _____
5 - 6	_____	_____	_____	_____	
6 - 7	_____	_____	_____	_____	
7 - 8	_____	_____	_____	_____	PROJECT NO _____
8 - 9	_____	_____	_____	_____	
9 - 10	_____	_____	_____	_____	
10 - 11	_____	_____	_____	_____	LOCATION _____
11 - 12	_____	_____	_____	_____	
	TOTAL		_____	_____	

HOURLY VARIATION OF DAILY TRAFFIC

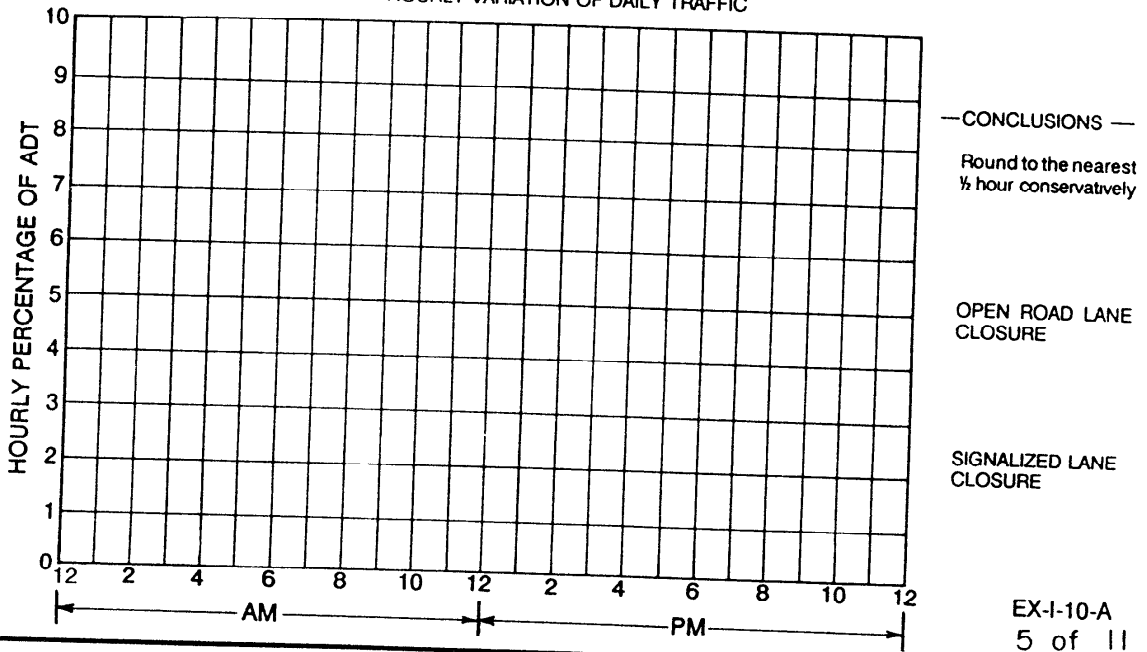

EX-I-10-A  
5 of 11

LANE CLOSURE WORKSHEET

STATE PROJECT NO 12345-6789 FAP NO NA

WPI NO. 1234567 COUNTY TROPIC DESIGNER YATES

NO EXISTING LANES 2 SCOPE OF WORK WIDEN & RESURFACE

Calculate the peak hour traffic volume (V)

$$V = ATC \underline{15,000} \times P/D \underline{0.083} \times D \underline{1/4} \times PMF \underline{1.20} \times RTF \underline{0.75} = \underline{1120}$$

LANE CLOSURE CAPACITY TABLE

Capacity(C) of an Existing 2 Lane-Converted to 2 Way, 1 Lane = 1400VPH  
 Capacity(C) of an Existing 4 Lane-Converted to 1 Way, 1 Lane = 1800VPH  
 Capacity(C) of an Existing 6 Lane-Converted to 1 Way, 2 Lane = 3600VPH

Factors restricting Capacity

TLW 10' LC 4' WZL 2100' G/C 0.64

Calculate the Restricted Capacity (RC) at the Lane Closure Site by multiplying the appropriate 2L, 4L, or 6L Capacity (C) from the Table above by the Obstruction Factor (OF) and the Work Zone Factor (WZF). If the Lane Closure is through or within 600' of a signalized intersection, multiply the RC by the G/C Ratio

$$RC \text{ (Open Road)} = C \underline{1400} \times OF \underline{0.87} \times WZF \underline{0.82} = \underline{999}$$

$$RC \text{ (Signalized)} = RC \text{ (Open Road)} \underline{999} \times G/C \underline{0.64} = \underline{639}$$

If  $V \leq RC$ , there is no restriction on Lane Closure

If  $V > RC$ , calculate the hourly percentage of ADT at which Lane Closure will be permitted

$$\% = \frac{RC \text{ (Open Road)} \underline{999}}{ATC \underline{15,000} \times D \underline{1.00} \times PMF \underline{1.20} \times RTF \underline{0.75}} = \underline{7.40\%}$$

$$\text{Signalized \%} = \text{Open Road \%} \underline{7.40} \times G/C \underline{0.64} = \underline{4.74\%}$$

Plot 24 hour traffic to determine when Lane Closure permitted (See EX-I-10-A, Sheet 5 of 11)

NOTE For Existing 2 Lane Roadways,  $D = 1.00$

Work Zone Factor (WZF) applies only to 2 Lane Roadways

For  $RTF < 1.00$ , briefly describe alternate route 25% of

existing traffic diverted on Ballard Blvd. North on Newhall here, then East on Xanders X-way

### LANE CLOSURES

24 HR COUNTS  
Taken in Nov

TIME	AM		PM		P/D
	HOURLY VOLUME	ATC %	HOURLY VOLUME	ATC %	
12 - 1	<u>160</u>	<u>1.1</u>	<u>960</u>	<u>6.4</u>	
1 - 2	<u>90</u>	<u>0.6</u>	<u>830</u>	<u>5.5</u>	
2 - 3	<u>30</u>	<u>0.2</u>	<u>810</u>	<u>5.4</u>	
3 - 4	<u>25</u>	<u>0.2</u>	<u>1080</u>	<u>7.2</u>	
4 - 5	<u>30</u>	<u>0.2</u>	<u>1190</u>	<u>7.9</u>	P/D
5 - 6	<u>130</u>	<u>0.9</u>	<u>1240</u>	<u>8.3</u>	= .083
6 - 7	<u>525</u>	<u>3.5</u>	<u>930</u>	<u>6.2</u>	
7 - 8	<u>1135</u>	<u>7.6</u>	<u>680</u>	<u>4.5</u>	
8 - 9	<u>910</u>	<u>6.1</u>	<u>530</u>	<u>3.5</u>	
9 - 10	<u>870</u>	<u>5.8</u>	<u>425</u>	<u>2.8</u>	
10 - 11	<u>825</u>	<u>5.5</u>	<u>365</u>	<u>2.4</u>	
11 - 12	<u>960</u>	<u>6.4</u>	<u>270</u>	<u>1.8</u>	
		TOTAL	<u>15,000</u>	<u>100</u>	

DATE  
Dec. 1988

DESIGNER:  
YATES

PROJECT NO  
12345-6789

LOCATION  
Buck Lake Rd.

HOURLY VARIATION OF DAILY TRAFFIC

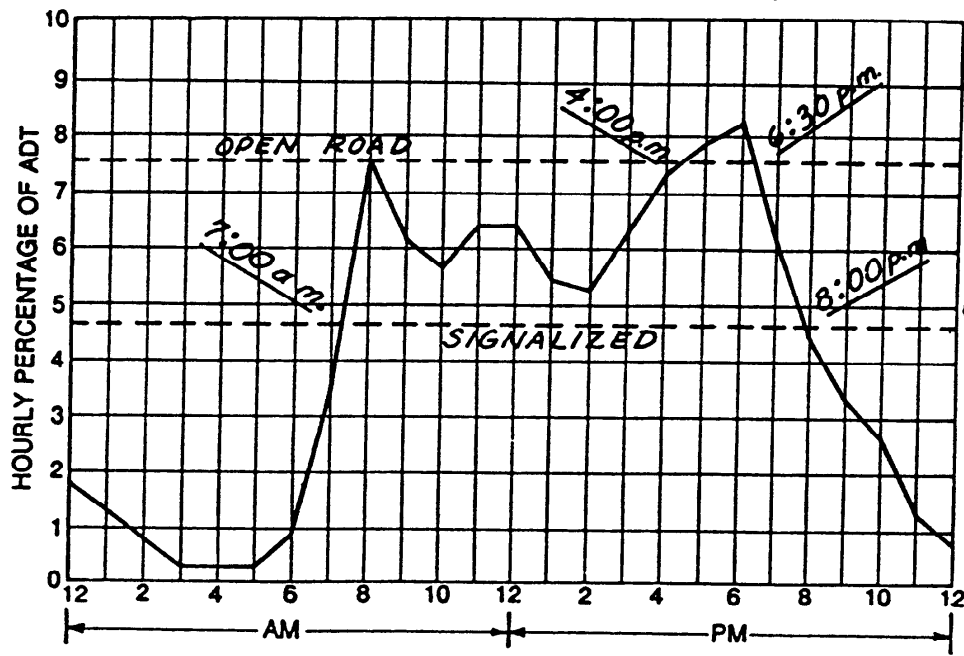

— CONCLUSIONS —  
Round to the nearest 1/4 hour conservatively

7.40  
OPEN ROAD LANE CLOSURE RESTRICTION  
4 00 PM - 6 30 PM.

4.74  
SIGNALIZED LANE CLOSURE RESTRICTION  
7 00 A M - 8 00 P M

EX-1-10-A  
7 of 11



LANE CLOSURE WORKSHEET

STATE PROJECT NO.. 12345-6789 FAP NO.: NA  
WPI NO.: 1234567 COUNTY: TROPIC DESIGNER: GIDDENS  
NO. EXISTING LANES: 4 SCOPE OF WORK: RESURFACE

Calculate the peak hour traffic volume (V)

$V = ATC \underline{30,000} \times P/D \underline{0.083} \times D \underline{0.55} \times PMF \underline{1.20} \times RTF \underline{1.00} = \underline{1643}$

LANE CLOSURE CAPACITY TABLE

Capacity(C) of an Existing 2 Lane-Converted to 2 Way,1 Lane = 1400VPH  
Capacity(C) of an Existing 4 Lane-Converted to 1 Way,1 Lane = 1800VPH  
Capacity(C) of an Existing 6 Lane-Converted to 1 Way,2 Lane = 3600VPH

Factors restricting Capacity:

TLW 11' LC 6' WZL NA for 4L G/C 0.74

Calculate the Restricted Capacity (RC) at the Lane Closure Site by multiplying the appropriate 2L, 4L, or 6L Capacity (C) from the Table above by the Obstruction Factor (OF) and the Work Zone Factor(WZF) If the Lane Closure is through or within 600' of a signalized intersection, multiply the RC by the G/C Ratio

RC (Open Road) = C 1800 X OF 0.96 X WZF 1.00 = 1728

RC (Signalized) = RC (Open Road) 1728 X G/C 0.74 = 1279

If  $V \leq RC$ , there is no restriction on Lane Closure  
If  $V > RC$ , calculate the hourly percentage of ADT at which Lane Closure will be permitted

$\% = \frac{RC \text{ (Open Road)} \underline{1728}}{ATC \underline{30,000} \times D \underline{0.55} \times PMF \underline{1.20} \times RTF \underline{1.00}} = \underline{8.73\%}$

Signalized % = Open Road % 8.73 X G/C 0.74 = 6.46%

Plot 24 hour traffic to determine when Lane Closure permitted (See EX-I-10-A, Sheet 5 of 11)

NOTE: For Existing 2 Lane Roadways, D = 1.00.  
Work Zone Factor (WZF) applies only to 2 Lane Roadways.  
For RTF < 1.00, briefly describe alternate route: NA

**LANE CLOSURES**

24 HR COUNTS  
Taken in Nov

TIME	AM HOURLY VOLUME	ATC %	PM HOURLY VOLUME	ATC %
12 - 1	320	1.1	1920	6.4
1 - 2	180	0.6	1660	5.5
2 - 3	60	0.2	1620	5.4
3 - 4	50	0.2	2160	7.2
4 - 5	60	0.2	2380	7.9
5 - 6	260	0.9	2480	8.3
6 - 7	1050	3.5	1860	6.2
7 - 8	2270	7.6	1360	4.5
8 - 9	1820	6.1	1060	3.5
9 - 10	1740	5.8	850	2.8
10 - 11	1650	5.5	730	2.4
11 - 12	1920	6.4	540	1.8
TOTAL			30,000	100.0

DATE  
Dec. 1988

DESIGNER  
GIDDENS

PROJECT NO  
12345-6789

LOCATION  
BUCK LAKE RD.  
STA 100 - STA 200

HOURLY VARIATION OF DAILY TRAFFIC

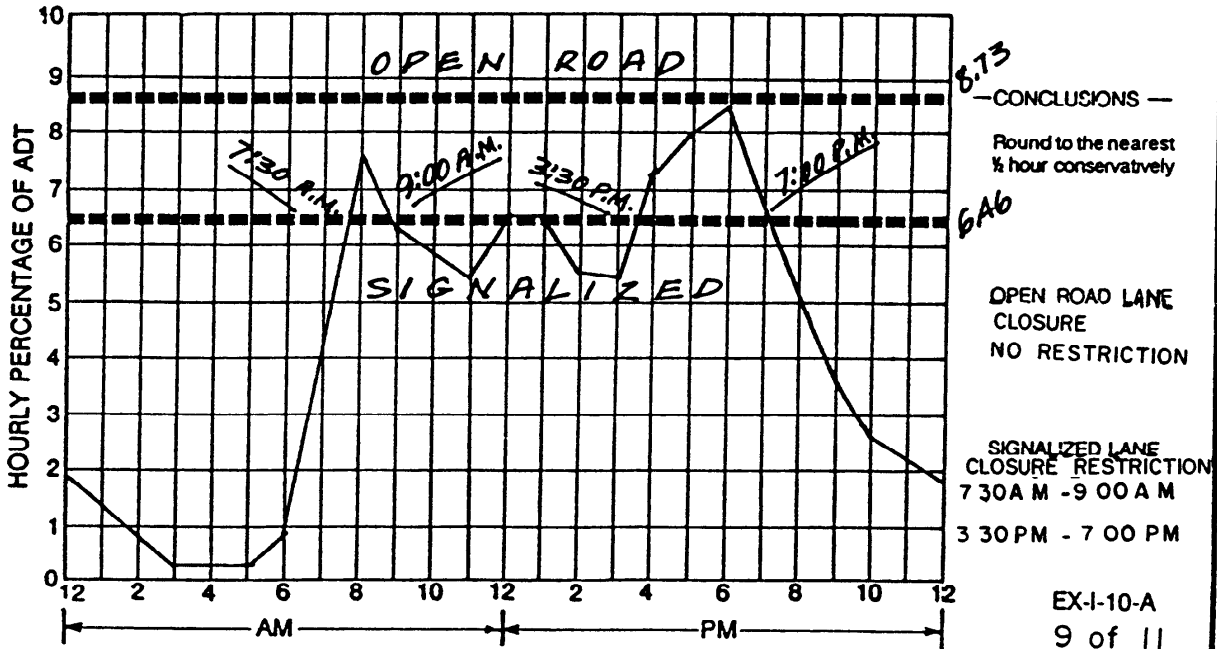

SAMPLE 4-LANE SITE = SR 60 @ US 301 EAST OF TAMPA - HILLSBOROUGH CO

INBOUND LANE CLOSURES

24 HR COUNTS

TIME	AM HOURLY VOLUME	ATC %	PM HOURLY VOLUME	ATC %
12 1	146	0.7	1437	6.6
1 2	88	0.4	1387	6.4
2 3	99	0.5	1357	6.2
3 4	94	0.4	1358	6.2
4 5	158	0.7	1261	5.8
5 6	392	1.8	1188	5.5
6 7	1377	6.3	998	4.6
7 8	2235	10.3	901	4.1
8 9	1602	7.4	594	2.7
9 10	1339	6.2	518	2.4
10 11	1276	5.9	380	1.7
11 12	1316	6.0	259	1.2
TOTAL			21,760	100.0

COMPOSITE LANE CLOSURES

24 HR COUNTS

TIME	AM HOURLY VOLUME	ATC %	PM HOURLY VOLUME	ATC %
12 1	444	1.1	2836	6.7
1 2	232	0.5	2594	6.1
2 3	195	0.5	2644	6.3
3 4	245	0.6	2823	6.7
4 5	294	0.7	3066	7.3
5 6	599	1.4	3080	7.3
6 7	1895	4.5	2362	5.6
7 8	3070	7.3	1775	4.2
8 9	2559	6.1	1291	3.0
9 10	2403	5.7	1212	2.8
10 11	2367	5.6	890	2.1
11 12	2694	6.4	662	1.5
TOTAL			42,232	100.0

OUTBOUND LANE CLOSURES

24 HR COUNTS

TIME	AM HOURLY VOLUME	ATC %	PM HOURLY VOLUME	ATC %
12 1	298	1.5	1399	6.8
1 2	144	0.7	1207	5.9
2 3	96	0.5	1287	6.3
3 4	151	0.7	1465	7.2
4 5	136	0.7	1805	8.8
5 6	207	1.0	1892	9.2
6 7	518	2.5	1364	6.7
7 8	835	4.1	874	4.3
8 9	957	4.7	697	3.4
9 10	1064	5.2	694	3.4
10 11	1091	5.3	510	2.5
11 12	1578	6.7	403	2.0
TOTAL			20,472	100.0

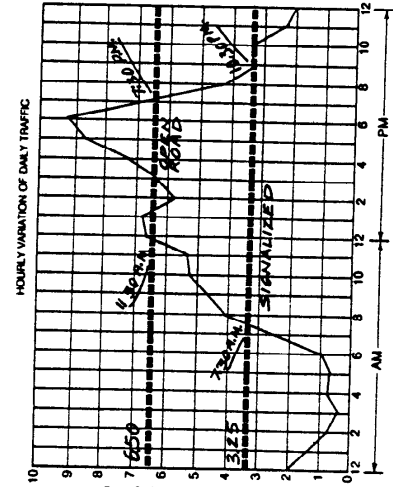
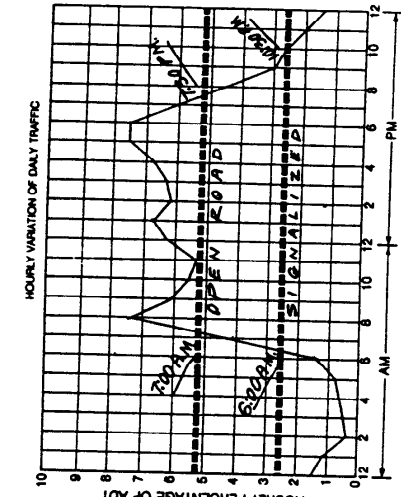
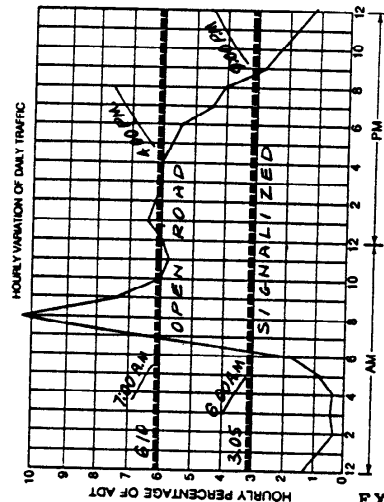

LANE CLOSURE WORKSHEET SUMMARY

LANE SAMPLE WITH SIGNIFICANT AM-PM PEAKS

SAMPLES = INBOUND (WB), COMPOSITE (EB & WB), OUTBOUND (EB)

SITE = SR 60 @ US 301 EAST OF TAMPA, HILLSBOROUGH CO

COMPONENT	INBOUND	COMPOSITE	OUTBOUND
ADT	21,760	42,232	20,472
P/D	0.103	0.073	0.092
D	1.00	0.60	1.00
PMF	1.17	1.17	1.17
RTF	1.00	1.00	1.00
V	2622	2164	2203
TLW	12'	12'	12'
LC	0'	0'	0'
C	1800	1800	1800
OF	0.86	0.86	0.86
RC(OPEN ROAD)	1548	1548	1548
G/C	0.50	0.50	0.50
RC(SIGNAL)	774	774	774
% OPEN ROAD	6.10	5.20	6.50
% SIGNAL	3.05	2.60	3.25
LANE CLOSURE (OPEN ROAD)	7:00 A.M. - 4:00 P.M.	7:00 A.M. - 7:30 P.M.	11:30 A.M. - 7:30 P.M.
LANE CLOSURE (SIGNAL)	6:00 A.M. - 9:00 P.M.	6:00 A.M. - 10:30 P.M.	7:30 A.M. - 10:30 P.M.

CONCLUSIONS

EX-1 10-A  
|| of ||

10 15 8 Detours

A detour is a deviation from the normal roadway and is initiated when traffic is directed to leave the roadway. Activities such as traffic shifting and/or splitting accomplished within the confines of the roadway do not involve detours, but a crossover involves a detour because traffic is directed to depart the directional roadway.

There are two types of detours: on-site and off-site. An on-site detour is generally defined as a shift in the traffic of one lane or more. At an on-site detour, traffic is diverted onto a temporary roadway generally constructed within or adjacent to the right-of-way or onto a frontage road. At an off-site detour, traffic is diverted onto another highway in order to bypass the work zone.

For off-site detours, the detour signing is usually done under the direction of the traffic engineer who has authority over the roadway. The detour should be signed clearly so drivers can traverse the entire detour and return to the original roadway. Detour signing is not required for minor shifts from the direct or regular route. There will be situations that are between minor shifts and re-routing. In these cases, engineering judgment must be applied to ensure that traffic is given clear and adequate direction. When shifts and detours are required, the designer should analyze the effects of the action on the capacity of the roadway and take the necessary steps to minimize adverse impacts. The structural capacity of the shoulder or detour pavement should also be considered and additional structure provided if necessary.

The designer has two methods of paying for detours: by (1) using the "special detour" lump sum pay item or (2) using the lump sum Mot pay item. When the special detour pay item is used, the work and quantities included for pay under the item are to be tabulated and noted in the plans. The special detour pay item is intended to be used in all situations where traffic is shifted one lane width or more onto temporary pavement.

All work and materials necessary to construct temporary pavement widening for shifts less than one lane width shall be included under lump sum MOT

Even though shifts may meet the definition of a detour and a "special detour" may be called for contract pay purposes, it may not be appropriate to sign the shift as a detour. Signing should match the perceptions and desired responses of the driving public as per the MUTCD rather than administrative definitions.

TCPs should include sufficient detail for detour geometry. Detours should be designed with shoulders (2' min) whenever practical. The radius of curvature and taper lengths should be shown. Detours should be designed and operated as close to the normal speed as possible. When speed reductions are necessary, the reduction should be in 10 mph increments. The recommended minimum radius of curvature (without superelevation) for detours is shown in Table 10.15.2.

#### 10.15.9 Above Ground Hazards

An above ground hazard is any object, material, or equipment, which does not meet the Department's safety criteria for clear zones - i.e., anything that is greater than 4 inches in height and is firm and unyielding or doesn't meet breakaway requirements.

Construction hazards located within the travel way or from the outside edge of pavement through the clear zone for the highway are to be considered work areas and treated as required by the appropriate warning devices during the contractor's work hours or eliminate the hazard. During non-working hours, all objects, materials, or equipment that constitutes a hazard, must be stored/placed outside the clear zone or be shielded by a barrier wall.

For above ground hazards within a work zone, the clear zone used should be based on the regulatory speed posted during construction. (See Index 700)

#### 10 15 10 Drop-offs in Work Zones

Acceptable warning and barrier devices for traffic control at drop-offs in work areas are detailed in Standard Index 600

The designer should anticipate dropoffs which are likely to occur during construction and provide the appropriate devices thru pay items and quantities For those projects where barrier wall would be needed and yet it is not practical - such as highly developed urban areas where numerous driveways exist - the designer should consider adding plan notes which restrict the length of the contractors operations in order to reduce the dropoff at acceptable level, prior to the end of the days operations

#### 10 15 11 Narrow Bridges

Simultaneously working on both sides of a bridge (bridge widening, etc.) may be hazardous due to the narrow width of some bridges Consideration should be given to specifying that work be done only on one side at a time, particularly on high speed roadways In some situations, the installation of barrier wall on both shoulders can totally eliminate any shoulder or refuge area The designer should consider whether or not this restriction of the effective bridge width is acceptable and consistent with the desired operational ability of the facility

#### 10 15 12 Existing Highway Lighting

If the project has existing roadway lighting, the designer shall prepare a specification that completely describes what is to be done with the existing lighting during all phases of construction Give detailed information on any poles that have to be relocated or any new conduit or conductors that would have to be installed A field survey should be conducted to establish the condition of the existing system and what responsibility the contractor will have in bringing the existing lighting system back to an acceptable condition

The designer shall determine what work is to be done and, using the pay items established for roadway lighting shown on Index 17506 of the Roadway and Traffic Design Standards, develop pay items and quantities for all work to be done for maintaining existing lighting throughout construction

#### 10 15 13 Work Area Access

The TCP must also include a work area access plan, if necessary. This is a constructability issue in which the designer addresses the question of how the contractor is to get materials and equipment into the work area safely. This is a particularly critical issue on high speed facilities (such as the Interstate) where barrier wall is used to protect median work areas.

#### 10 15 14 Pay Items and Quantities

The Basis of Estimates Manual has been updated to provide better instructions on calculating many of the MOT quantities.



## 10 16 Speed Zoning

### 10 16 1 Regulatory Speeds in Work Zones

The goal of traffic control plans for construction, maintenance, and utility operations is to route traffic through such areas in a manner comparable to normal highway conditions. Changes to the existing posted speed limits should only be made after consideration of actual or anticipated field conditions including vehicular volumes, congestion, TCP phasing, lane restrictions, type of construction, closeness of traffic to workers, equipment, flagger usage, pedestrians, geometrics, and physical conditions. By virtue of F.S. 316.187, all regulatory speeds must be established on the basis of a traffic and engineering investigation. The justification for establishing work zone regulatory speeds different from normal speed limits must be included in the project file.

When developing a TCP, the considerations noted above must be addressed in determining the appropriate regulatory speeds. The TCP and the project file will suffice as the traffic and engineering investigations. TCPs for all projects must show specific regulatory speeds for each phase of work. This can either be the existing posted speed or a reduced speed. The speed shall be noted in the TCP. Guidelines for determining the appropriate speed reduction are given in Table 10.16.1.

If field conditions warrant speed reductions greater than those shown in the Traffic Control Plan (TCP), then the contractor may submit to the project engineer for approval by the Department, a signed and sealed study to justify the need for further reducing the posted speed. or the engineer may request the District Traffic Operations Engineer (DTOE) to investigate the need. It will not be necessary for the DTOE to issue regulations for regulatory speeds in work zones due to the revised provisions of F.S. 316.0745(2)(b). However, all other regulatory signs, work zone or permanent, require issuance of a regulation by the DTOE.

Table 10.16.1

REGULATORY SPEED REDUCTIONS  
FOR USE IN CONSTRUCTION AND MAINTENANCE OPERATIONS

CONDITIONS	TYPICAL APPLICATIONS	DURATION OF WORK	REDUCTIONS TO EXISTING REGULATORY SPEEDS	SUGGESTED AMOUNT OF SPEED REDUCTION
Activities are more than 15' from the edge of pavement.	Landscaping Work Utility Work Fencing Work Cleaning Drainage Structures Reworking Ditches	Any Time Period	SHOULD NOT BE USED*	N/A
Activities which encroach the area closer than 15' but not closer than 2' to the edge of pavement.	Utility Work Culvert Extensions Side Slope Work Guardrail Maintenance Landscaping Work Cleaning Drainage Structures Reworking Ditches Sign Installation and Maintenance Shoulder Work	One daylight period or less	SHOULD NOT BE USED*	N/A
Activities which encroach the area from the edge of the pavement to 2' from the edge of pavement.	Utility Work Guardrail Maintenance Shoulder Work	Greater than one daylight period or less	MAY BE USED	10 MPH
		Greater than one daylight period	MAY BE USED	10 MPH

NOTE: Regulatory Speed signs shall meet all requirements of the Manual on Uniform Traffic Control Devices (MUTCD).  
\*Unless drop-offs or other situations create hazardous conditions for motorists, pedestrians or workers.

Table 10.16.1  
(Continued)

REGULATORY SPEED REDUCTIONS  
FOR USE IN CONSTRUCTION AND MAINTENANCE OPERATIONS

CONDITIONS	TYPICAL APPLICATIONS	DURATION OF WORK	REDUCTIONS TO EXISTING REGULATORY SPEEDS	SUGGESTED AMOUNT OF SPEED REDUCTION
Activities which encroach the area between the centerline and the edge of pavement. (lane closures)	Pavement marking Pavement Resurfacing Pavement Repair Utility Work Bridge Repair Widening	One hour or less  Greater than one hour	SHOULD NOT BE USED*  MAY BE USED	N/A  10-20 MPH
Activities which require intermittent or moving operation on the shoulder.	Shoulder and Slope Utility Work Guardrail Maintenance Landscape Work Delineator Installation Widening	One hour or less  Greater than one hour	SHOULD NOT BE USED*  SHOULD NOT BE USED*	N/A  N/A
Activities requiring a temporary detour to be constructed**	Bridge Construction Subgrade Restoration Culvert Repair Roadway Construction	Any time period	MAY BE USED	10-20 MPH
Activities which encroach the area beyond either the centerline of a roadway or lane line of a multi-lane highway	Pav't Marking Pav't Resurfacing Use of Temporary Barrier Wall Installation of Drainage Laterals	Any time period	MAY BE USED	10-20 MPH

NOTE: Regulatory Speed signs shall meet all requirements of the Manual on Uniform Traffic Control Devices (MUTCD).

\*Unless drop-off or other situations create hazardous conditions for motorists, pedestrians or workers  
\*\*Detour and transition geometrics which meet the existing regulatory speed should be provided whenever possible.

Regulatory speed signs in rural areas (Interstate and Non-Interstate) are to be preceded by a "REDUCE SPEED AHEAD" sign positioned as follows

Interstate (Rural) - 1000 feet in advance

Non-Interstate (Rural) - 500 feet in advance

All urban areas do not require an advance sign, however, it may be included at the designer's option

The "Regulatory Speed" and "Reduce Speed Ahead" signs are to be paid for under a pay Item, 102-96 Temporary Regulatory Signs per each per day

If the existing regulatory speed is to be used, consideration should be given to supplementing the existing signs when the construction work zone is between existing regulatory speed signs. For projects greater than one mile in length for rural areas (Non-Interstate) and on Rural or Urban Interstate, regulatory signs are to be placed at no more than one mile intervals. For urban situations (Non-Interstate) regulatory speed signs are to be placed at a maximum of 1000 feet apart.

The 85 percentile speed used to establish normal regulatory speeds does not apply for construction zones. Changes to the existing speed should be made on actual or anticipated field conditions such as vehicular volumes, congestion, TCP phasing, lane restrictions, type of construction, closeness of traffic to workers, equipment, flagger usage, pedestrians, geometrics and physical conditions. This is interpreted to mean, using engineering judgement, the responsible designer is to establish the regulatory speed and so note in the plans and project file, after considering the above conditions and the degree to which warning devices are required. In general, the regulatory speed should be established to route vehicles safely through the work zone as close to normal conditions as possible. The regulatory speed should not be reduced more than 20 MPH below the posted speed without the approval of the

District Traffic Operations Engineer and the appropriate District Director (See Index 600 ) This reduction is to be done in 10 MPH per 500 feet increments

| Work zones in limited access facilities are to be designed at a minimum of 55 m p h  
| Work zone speeds in excess of this should be considered if the safety of workers and  
| equipment are not jeopardized

To ensure credibility with motorists and enforcement agencies, reductions in the existing posted speed shall be removed as soon as the conditions requiring the reduced speed no longer exist On longer projects, such as interstate resurfacing, the speed reductions should be located in proximity to the activities which merit a reduced speed and not "blanketed" for the entire project

When the regulatory speed is changed in a work zone, the permanent speed limit signs are to be removed during the period when the work zone regulatory speed zones are in effect

Once the work zone regulatory speeds are removed, the regulatory speed existing prior to construction will automatically go back into effect unless a new regulation is issued by the DTOE to revise the previous speed

#### 10 16 2 Advisory Speeds in Work Zones

Advisory Speed plates should not normally be specified in the plans, unless they are being used merely to reinforce the regulatory speed signs Advisory Speed plates will be used at the option of the field engineer for temporary use while processing a request to change the regulatory speed specified in the plans when deemed necessary Advisory speed plates cannot be used alone, but must be placed below the construction warning sign for which the advisory speed is required

## Chapter 11

### STORM WATER POLLUTION PREVENTION PLAN

#### 11.1 General

A Storm Water Pollution Prevention Plan (SWPPP) shall be developed as part of the contract plans for each FDOT construction project site that discharges to waters of the United States

The site specific SWPPP is a requirement of the Florida General Permit issued and made effective by the Environmental Protection Agency (EPA) on September 25, 1992. In order to use the General Permit the FDOT must

- 1 Prepare a plan that assures compliance with the terms and conditions of the General Permit, including the State of Florida Department of Environmental Regulation (DER) requirements which are a part of the General Permit. This includes obtaining a storm water quality permit, if appropriate.
- 2 File a Notice of Intent (NOI) which documents our intent to be authorized as a permittee under the terms and conditions of the General Permit.

The SWPPP will be prepared by the responsible design engineer in consultation with Drainage, Construction and Environmental personnel, as required.

The District Permits Coordinator will make the distribution of the NOI, SWPPP and signed certification statements in accordance with Environmental Management procedures.

The objectives of the SWPPP are to

- Prevent erosion where construction activities are occurring
- Prevent pollutants from mixing with storm water
- Prevent pollutants from being discharged by trapping them on-site, before they can affect the receiving waters

The SWPPP consists of three major phases. The first two (2) are performed by Design and the third is the responsibility of Construction and the contractor.

- 1 Site evaluation and characterization
- 2 Assessment, selection/description of control measures and design details to address the objectives
- 3 Implementation of actions, schedules and design details

The SWPPP will include a narrative description, outlined in section 11.2, and a site map, described in section 11.3. Additional information will be found in the FDOT Erosion and Sediment Control Handbook and in workshop training material.

## 11.2 Narrative Description

The SWPPP shall identify potential sources of pollution which may reasonably be expected to affect the quality of storm water discharges from the construction site. In addition, the SWPPP shall describe and ensure the implementation of practices which will be used to reduce the pollutants in storm water discharges and assure compliance with the terms and conditions of the General Permit.

Prepare the SWPPP narrative on 8 5" X 11" paper to be included in the specifications package. Use the following outline to prepare the narrative.

### Storm Water Pollution Prevention Plan

- 1 Site Description
  - a Nature of Construction Activity
  - b Sequence of Major Soil Disturbing Activities
  - c Area Estimates
  - d Runoff Data
  - e Site Map
  - f Receiving Waters
- 2 Controls
  - a Erosion and Sediment Controls
    - (1) Stabilization Practices
    - (2) Structural Practices
  - b Storm Water Management
  - c Other Controls
    - (1) Waste Disposal
    - (2) Off-Site Vehicle Tracking
    - (3) State or Local Regulations
    - (4) Application of Fertilizers and Pesticides



- d State and Local Plans
- 3 Maintenance
- 4 Inspection
- 5 Non-Storm Water Discharges

#### 11 2 1 Site Description

The SWPPP shall provide a description of the site, construction activities, and potential pollutant sources. The area estimates shall include the total project area and the area expected to be disturbed. The runoff data shall include the rational runoff coefficient before, during, and after construction, the drainage area for each outfall, and existing data describing the soil or the quality of discharge from the site. The narrative discussion of the site map is discussed in section 11 3. The name of the receiving waters shall be given, as well as the wetland acreages on the site.

#### 11 2 2 Controls

The SWPPP shall include a description of the controls that will be implemented at the construction site. Describe the timing of the control measures to be used during each of the major activities identified in part 1 b of the site description narrative. Also describe the storm water management measures that will be installed during construction to control pollutants in the storm water discharges that will occur after construction.

Most of the narrative for other controls will be supplied by the contractor at the pre-construction conference. A plan for off-site vehicle tracking is the exception and must be included in the SWPPP prepared during design.

Any Water Management District or Local Water Management permits obtained in connection with the project should be noted.

11 2 3 Maintenance, Inspection and Non-Storm Water Discharges

A description of the maintenance and inspection of the controls identified in the plan will be provided by the contractor at the pre-construction conference. Non-storm water discharges shall also be identified by the contractor.

### 11.3 Site Map

The following information shall be shown on a site map

- Drainage patterns
- Approximate slopes
- Areas of soil disturbance
- Areas that may not be disturbed
- Locations of major controls identified in the plan
- Areas that are to be stabilized against erosion
- Surface waters (including wetlands)
- Locations where storm water is discharged to a surface water

There are three methods that may be used to develop the required site map

- 1 Use the construction plans as the site map.
- 2 Use the construction plans with some additional special sheets
- 3 Prepare a site map separately from the construction plans

All the information required above is shown in a typical set of construction plans except the drainage patterns and the locations of major temporary controls. If an optional Drainage Map is included in the construction plans, then the drainage patterns will also be shown. Use method two or three if the Drainage Map is not included.

Method one can be used if the Drainage Maps are included and the major temporary controls are shown somewhere in the construction plans. The preferred location to show the controls is on the Maintenance of Traffic (MOT) sheets. If the MOT sheets are not adequate, then the controls may be shown on the Plan and Profile sheets. If they are not adequate or are too cluttered, then use method two or three.

Method two uses special sheets to show information required by the General Permit that is not shown any other place in the construction plans. This will usually be the locations of the controls and the drainage patterns. Use a plan view with baseline information and sufficient topo to locate the controls.

Method three will be used when Plan and Profile sheets are not prepared for the project. A topographic map or aerial photo must be prepared as a base for the site map. Maps of the vicinity of the site may be available from the local government or the Water Management District. As a last resort, a USGS quadrangle map may be used as the base map.

The narrative description of the site map (part 1 e of the outline) shall describe the option chosen for the site map. If options 1 or 2 are chosen, the narrative shall list the construction plan sheet numbers where the site map information required by the General Permit can be found.

Regardless of the method used to prepare the site map, details should be prepared for all controls that are not detailed in the Roadway and Traffic Design Standards. The details should show the work intended, where and how the control is to be placed, and any other special design details required. Any Technical Special Provisions required by the erosion control items of work should be prepared as part of the specifications package.

#### **11.4 Summary of Quantities**

The Summary of Quantities - Erosion Control items shall be prepared to document what, where and how much material and work is required for the contractor to implement all phases of the Plan. These items shall be input to the CES with the regular roadway quantities.

## Chapter 12

### RIGHT OF WAY

#### 12.1 General:

To assist the roadway designer's understanding of right of way (R/W) requirements which must be addressed during the project development and design phases of projects, the following terms are briefly defined as an introduction

Right of Way is the real property estate rights, donated or acquired by purchase or condemnation, to accommodate permanent transportation improvements. Fee simple right of way is the strongest estate available to the Department and is sought for most permanent highway facilities. When improvements are designed which will fall outside of the existing R/W boundaries, additional lands must be identified and purchased as fee simple right of way for the improved facility. Purchased, condemned or donated R/W transfers ownership and estate rights to the Department. Right of Way donations are always to be considered.

Limited Access R/W is purchased for facilities such as Interstate and Expressways. This limits public access to interchange connection-points designed with entrance and exit ramps and limits access to motorized vehicular traffic. Pedestrians and bicycles are restricted in the interest of traffic capacity and safety.

Controlled Access R/W is acquired for the remaining State Highway System. This permits the general public and land owners along the corridors reasonable access, but in a controlled pattern that will facilitate the movement of through traffic. A mainline roadway with fully controlled access and parallel service roads to serve local traffic is

| the type of facility that best meets both objectives. This type of acquisition is encouraged  
| for high volume corridors at major intersections, especially if adjacent property is vacant  
| at the time of the proposed improvement. This allows sufficient right-of-way for urban  
| interchange design.

Perpetual Easements (perpetual right of use over, under or through the property of another) are used when permanent structures or improvements are to be constructed and maintained on parcels where acquisition of fee title would be impractical, i.e., when acquisition of the fee would cause excessive severance damages due to green area or setback requirements or where underground structures are to be constructed which will not impair the surface utility of the land. A sight triangle or drainage facility are examples of features that may require a perpetual easement. Condemnation powers may be utilized to acquire necessary perpetual easements.

Temporary Easements (a temporary right of use over, under or through the property of another) are used when it is necessary to temporarily occupy a parcel for a specific purpose such as construction of temporary detours, stock piling materials or parking equipment. No improvement which requires maintenance by the Department beyond the term of the easement can be constructed on a temporary easement.

License Agreements (permission to do a particular thing which without the license would not be allowable) are used to gain access to adjoining properties for sloping, grading, tying in, harmonizing and reconnecting existing features of the licensor's property with the highway improvements to be constructed. This work is solely for the benefit of the property owner. The Department does not compensate for license agreements. If the owner refuses to execute the agreement, the Department will not perform the work.

Licenses are included here as real property interests for convenience, but they are not real property interests. A license, with respect to real property, is a privilege to go on the premises for a certain purpose but does not vest any title in the licensee.

Examples of license agreements are right of entry agreements and restoration agreements |  
Right of entry agreements are for a specific purpose such as to demolish the remainder  
of a severed building that has no value or to enter a property before the formal  
permanent documents can be executed Restoration agreements are permissions to enter  
the property and perform minor grading, grassing, planting, etc , to harmonize and  
restore conditions

## **12.2 Procedures for Establishing R/W Requirements:**

The procedures for addressing R/W requirements in design are an integral part of the engineering analyses, economic comparisons and professional judgements the designer must make. Consultation with R/W appraisers and acquisition personnel will be necessary, if the best decisions are to be expected. One excellent method of providing the consultation is the "R/W partnering" concept with all parties that have a vested interest participating in the decision making process.

### **12.2.1 Open Cut and Fill Roadway Sections**

R/W requirements along the project boundaries are dictated by the actual construction limits plus a reasonable maintenance buffer. The roadway cut and fill slopes, drainage ditch slopes and other construction elements are used to define the construction limits, which are generally shown on the roadway cross sections. R/W requirements are determined by reviewing the plotted cross sections after the roadway and drainage design elements have been permanently established and major revisions are highly unlikely.

The procedures should, at this point, include a joint review of the proposed R/W, including a field review if necessary. The design details and the property information must be reviewed by the designer, personnel from the R/W Office and the R/W Mapping Office. This review should be scheduled during the Phase II design process as defined in Volume II, Chapter 2, of the Plans Preparation Manual and should address such issues as

- 1 Will additional R/W be required for project access or maintenance of the facility? Check pond sites, high embankment slopes, bridges, outfalls, canals and similar sites.



- 2 Can fee takings be avoided on certain key parcels where the fill would cause substantial damages to the parcel or to an existing business by designing a retaining wall?
- 3 Can the grade of the roadway be revised or slopes adjusted on specific parcels to minimize damages or to reduce the difference in elevation between the remainder and the project grade at the R/W line? Review potential claims relating to driveway modifications or severe elevation differences
- 4 Can the roadway grades be revised or connections relocated so access to the remainders can be constructed without impairing the use of the remainder, thereby avoiding huge severance and business damages caused by impairment of access?
- 5 Can drainage facilities (outfalls, ponds, ditches, etc ) be maintained without additional R/W space? Can uneconomical remainders be used for stormwater treatment?
- 6 Check the suitability and cost effectiveness of stormwater treatment facilities and the status of permit approval
- 7 What type of legal instruments are likely to be required to secure the appropriate property rights for the project?
- 8 Review the status of R/W activities by others in the project area Avoid "double takes" at ramp terminals, intersections and by future FDOT projects
- 9 Check for potentials of hazardous materials, "4F" parcels, utility easements, landlocked remainders and parcels which could be eliminated from takings

- 10 Check for acquisitions involving existing treatment systems which could be mitigated within the FDOT system
- 11 Discuss any means available to protect R/W requirements against development prior to acquisition
- 12 Check for unrecognized work which will fall outside of R/W such as trenching, wall forms, or equipment maneuvering space
- 13 Check for availability of offsite property owned by FDOT which could be used for mitigation sites
- 14 Discuss status of "maintained R/W" maps
- 15 Discuss alternatives and cost effectiveness of excessive damages or parcel acquisitions

12 2 2      Curb and Gutter Roadway Section

Establishing R/W requirements in urban sections will generally follow very similar procedures as the open roadway section projects. The analysis and decision making is complicated by more property owners, generally higher property values and more complex access management problems.

The roadway and drainage design must be developed to a point where all major elements of the project (including signalization poles, lighting poles and overhead sign foundations) are firmly fixed. On projects with sidewalks and driveway connections, the design elements can be accurately established ONLY if proper survey data has been obtained for the designer's use. Profile elevations along the proposed R/W line and back of

sidewalk and half-sections or profiles at each driveway location should be obtained as a minimum standard practice

The design engineer must perform the design work required to establish the project profile grades and the back of sidewalk grades to minimize the grade differences at the R/W line. Areas of superelevation must be analyzed very carefully. Split profile grades or other design strategies may be required to accommodate the proposed construction of the facility within the minimum R/W limits.

The developed drainage and roadway design elements should be plotted on the plan sheets and the cross sections, which will establish the preliminary R/W requirements along the project boundaries as indicated by the construction limits. A good quality control review and a joint review with R/W appraisers and R/W Mapping personnel at this time will assist in determining the final R/W requirements. The same issues listed earlier in these procedures should be addressed.

The design engineer cannot assume the property owner's intentions or disposition with respect to his property. The designer must design the highway facility within the existing R/W or request acquisition of R/W to accommodate the project elements. The most economical means of constructing the project should always be the objective. Alternate design studies will be required in many locations to determine if additional R/W should be purchased, a retaining wall constructed or modified slopes and barrier system should be considered. A reasonable estimate of R/W costs or damages expected must be obtained from the R/W Office in order to make such a design study. Alternate construction methods may be shown on the plans as preferred and alternate methods.

### 12.2.3 Driveway Connections

Access to the Department's facilities is an important element of the design and R/W determination procedures. The designer must understand and follow the Access

Management Rules (14-96 and 14-97) and the standards adopted to implement the objectives of those rules

- 1 The access classification of the roadway segment and the connection category of the driveways must be determined. The designer must be aware of the nature, type, frequency of trips and number of vehicles utilizing the driveway.
- 2 The designer must make a determination as to which driveways are in conformance, which are to be maintained, which are to be closed and which are to be modified to bring them into compliance.
- 3 The designer must obtain sufficient field survey data to establish the highway grades, horizontal alignment and the existing ground elevations in the vicinity of the driveway location. The data necessary to accurately design the driveway connection and determine an acceptable tie-in with the existing surface should be obtained as a minimum.
- 4 The designer should develop the most economical driveway design which will conform to the standards and the requirements of the access management objectives. Alternate designs and locations may be required to meet the property owners needs and to reduce the costs of business damages. Generally, the best option can be reached by negotiating with the property owner in a give and take atmosphere.

Driveway connections must be addressed in consultation with R/W personnel, generally appraisers or review appraisers. This fact should not be overlooked on projects such as resurfacing, etc. on which there may not be any other R/W requirements. R/W related decisions to be made about driveway connections, probably on a case by case basis, include

- 1 If the driveway can be harmonized without impacting the value or the utility of the property, the Department should make a good faith offer to provide a suitable connection, at FDOT expense, in exchange for the permission to enter the land during construction for the purpose of doing the construction. If this offer is refused by the owner, the Department should provide a reasonable temporary commercial base material connection and place the burden for constructing the connection on the owner. The designer must make sure he can provide a traversable connection.
- 2 If providing the driveway connection reduces the remainder value or utility of the property and no other acquisition of that property is contemplated for the project, a temporary easement will be requested and shown on the plans. The Office of R/W will see that the proper instruments are executed to enter onto the property for purposes of construction and to compensate the owner for damages, if any are due. If other acquisition of that property is proposed, these instruments should include the entry and compensation, if any, for the driveway.
- 3 If it can not be determined during design that the harmonization work will reduce the remainder value or utility of the property, the owner can negotiate or claim damages through inverse condemnation during construction. This is not a desirable position for the Department, therefore the decision to employ this approach should be carefully considered.
- 4 Design should always, in their consultation with R/W personnel, make a determination if a fee taking or permanent easement is in the public interest to protect the facility. If a permanent easement will protect the facility and still give the owner some utility in the easement area, this may reduce the severance and business damages incurred.

12 2 4      Procedures for Decision Making

To assist in the decision process related to R/W requirements and instruments to be used the following guidelines from the Office of Right of Way may be used during the joint review process

1      License agreements (Restoration and Right of Entry) should be used only if the following conditions can be met

◦ The improvements or changes contemplated are minor in nature and are for the benefit of the property owner,

◦ No compensation will be offered to the property owner, except the benefits derived from the improvements or changes

◦ None of the improvements are required for the construction of the transportation facility and removal of, or change to the improvements will not be detrimental to the facility,

◦ The property owner is or will be fully informed of the nature and extent of the proposed improvements and has no objections, and,

◦ The transportation facility can be constructed without adverse impact on safety or operation

2      Temporary Easements should be used under the following conditions

◦ The improvements or harmonization work are primarily for the benefit of the property owner, but to properly construct the improvements the remainder value

or some utility of the property is reduced, and there is no other acquisition of that property involved in the construction of the project

- The contemplated improvements or uses of the property owner's land are required only during the period of construction of the transportation facility,

- The changes or improvements to the property owner's land are temporary and removal or alteration of the property subsequent to construction would not be detrimental to the facility, and,

- After construction is complete, there will be no need for periodic re-entry onto the property for maintenance or other purposes

3 Fee Simple R/W purchase should be used when the following conditions exist

- The planned improvements to the property owner's land are required as a part of construction of the transportation facility,

- The improvement on that land must remain in place as a part of the facility, and,

- Periodic re-entry to the property is required for maintenance or repair

4 Perpetual Easements may be considered as an alternative to fee simple purchase in the R/W process

- If the property estate rights are not required to be as complete as a fee simple taking and the owner may continue to enjoy some benefits of the property without impairing the Department's interest The costs associated with the easements must be much less than a fee simple purchase before it becomes a viable alternate

12 2 5      Transmittal of R/W Requirements

| Final R/W requirements should be established before transmitting them to the R/W Mapping Office for preparation of R/W maps. All R/W requirement transmittals should be in writing and clearly indicate in the memo and on the plans which parcels have been finalized and which parcels are still pending. An effort should be made to transmit final R/W requirements in usable segments recognizing that it is not practical to contract for appraisals, etc., on small project segments. Priority should be given to the major, expensive or complex acquisitions that are going to require more time to acquire and complete the relocation of the occupants. Advanced design effort and final R/W requirement determination may expedite meeting production ready dates. It is desirable to transmit requirements as early as possible in the plans development.

| R/W requirement submittals must be coordinated with the production management staff and scheduled in advance.

| All R/W requirements that are firm (primarily mainline construction limits) should be transmitted by Phase II. All other requirements that generally involve more detailed design completion (i.e., outfalls, pond locations, corner clips, access needs, etc.) must be submitted by the Phase III stage completion of the roadway design plans.

All R/W requirements must be transmitted by the completion of the Phase III roadway design plans.



### **12.3 Process for Establishing Right of Way Requirements:**

Establishing right of way requirements is a design process, but requires close coordination with other functions that have input to the project development and design of the project

The Engineer of Record is responsible and must ensure that representatives from the appropriate functional areas are involved in the determination process. They must also ensure that a review of the final R/W requirements is performed. The "R/W Partnering" concept is an excellent method of ensuring that the proper consultation and input is received.

Generally, the R/W needs-determination will involve Roadway, Bridge and Drainage Design, Permits, Utilities, R/W appraisers, R/W Mapping and Legal functions. On consultant designed projects, the project manager's role as lead coordinator is especially critical.

#### **12.3.1 New or Major Reconstruction Projects**

These projects generally have Project Development and Environmental (P D & E) activities and Right of Way activities identified in the Work Program.

The project development process must address R/W requirements and perform sufficient preliminary engineering design to obtain preliminary cost estimates from the R/W Office. This may require that the P D & E consultant or in-house scope of services include work such as:

- 1 Preliminary roadway grades & geometric design
- 2 Conceptual Drainage design and layout
- 3 Analysis of major access management issues
- 4 R/W Survey, property lines and limited Topo
- 5 R/W Mapping and property research activities
- 6 Preliminary R/W cost estimates work

These activities should also be performed by in-house staff doing preliminary engineering on projects. This early identification of potential R/W requirements, approximate costs and work effort to complete R/W Administration activities will greatly improve both cost estimates and schedules of projects. Also, involving R/W mapping and appraisers for value judgements will assist in developing better project alternatives.

R/W requirements identified during the project development phase should not be considered firmly set. The R/W Office cannot be requested to begin R/W mapping or appraisal activities based on these requirements, without extraordinary efforts by the designer to support the acquisition process as in advance acquisition. Normally, the final design process will establish final R/W requirements well before the completion of the Phase III design activities.

#### 12.3.2 Reconstruction Projects With Anticipated R/W Requirements

These projects may not have a formal P D & E study, but they were determined during Work Program development to require some R/W acquisition. Most projects will require some environmental re-evaluation effort and all projects should have some preliminary engineering to better define objectives, scope and R/W requirements. The following general process, as it relates to R/W requirements should be established by design.

PHASE I (See Volume II, Chapter 2, of the Plans Preparation Manual)

- 1 R/W Mapping will provide preliminary maps showing properties and all existing R/W lines for the project. These should be requested by the designer or by the project manager, on consultant projects.
- 2 Roadway Design will define project horizontal and vertical alignment and relate the existing R/W lines to the project as necessary to set R/W limits.

## PHASE II

- 1 Roadway Design will identify proposed R/W requirements as indicated by the completed design details such as the following
  - Limits of construction slopes for roadway and bridges
  - Cross section elements, ditches, curb returns and sidewalks
  - Driveway and street connections
  
- 2 Drainage will identify proposed R/W requirements as indicated by the completed drainage features
  - Retention or Detention Ponds
  - Mitigation of environmental issues
  - Drainage outfalls, sediment basins, etc

The designer will review all proposed R/W requirements with the R/W Mapping Office. This should be performed during the Phase II design activities in order to make decisions on how each parcel of proposed R/W will be acquired. These decisions will impact which design approach is taken. The issues to be discussed and decisions to be considered are detailed in Section 12.2 of these procedures.

- 3 As R/W requirements are determined, the information is furnished to the R/W Mapping Office by memo documenting clearly which R/W is final and which is pending. The R/W Mapping Office will use only the final requirements transmitted to prepare R/W maps. See Section 12.2.5.

## PHASE III

- 1 By the completion of Phase III design, all R/W requirements will be identified and transmitted to the R/W Mapping Office.

- 2 After transmittal of final R/W requirements to the R/W Mapping Office, design changes that affect R/W must be coordinated with the R/W Mapping Office, in a timely manner

The R/W shown on the roadway plans must be in exact agreement with the R/W Maps

It is essential that close coordination be maintained with R/W personnel in order to ensure that design changes affecting R/W are transmitted promptly

### 12 2 3 Projects Without an Identified R/W Phase

Many improvements to highway projects are intended to be accomplished within the existing R/W. The widening or widening and resurfacing projects are examples. Such projects must be evaluated very carefully and very early in the roadway design process. The addition of R/W requirements can have a tremendous impact on the schedule and on the anticipated costs of a highway improvement project.

R/W Mapping should be consulted on all resurfacing projects to ensure that a maintenance survey is not required.

| If unanticipated R/W requirements are identified during design, the production  
| management staff and the R/W Mapping Office should be notified as soon as the  
| requirements are determined. The production management staff will then give direction  
| as to continuing with the design and acquisition. If acquisition continues, it will follow  
| the previously discussed procedures.

**R/W REQUIREMENTS  
GENERALIZED PROCESS FLOW DIAGRAM**  
(Each function must have well defined written procedures for the development, quality control, coordination and regular exchange of product evaluation )

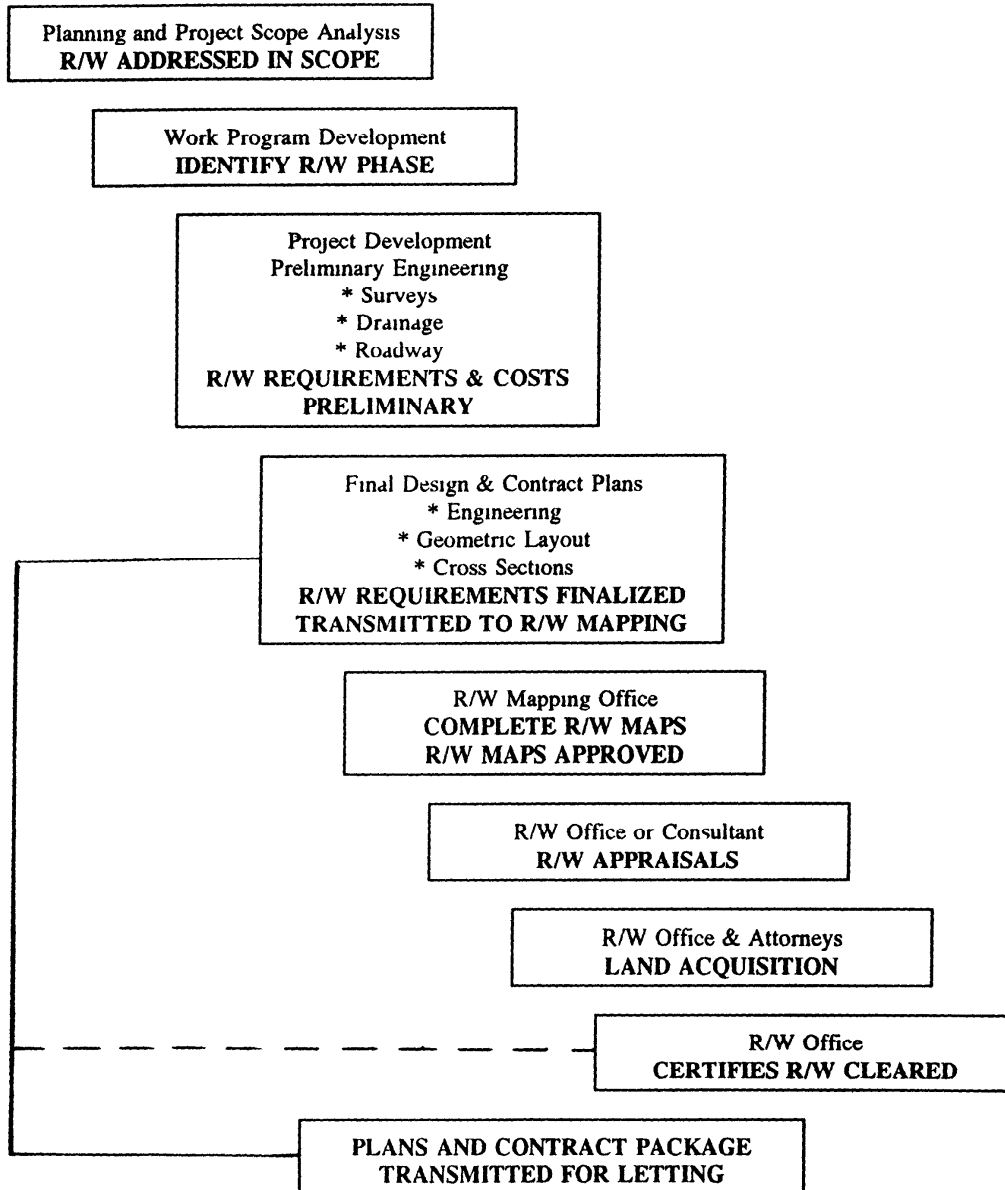

## Chapter 13

### PROJECT DEVELOPMENT

#### 13.1 General

This chapter explains the overall process of highway project development, from the Five Year Work Program to the project letting stage. A brief outline of the scope requirements at the various significant phases of the process will also be discussed.

#### 13.2 Process

##### 13.2.1 Five Year Work Program

The development of a Five Year Work Program begins with the identification of short and long range statewide transportation needs. Planning documents are developed with inputs from Florida DOT, regional planning groups and local governments. Data concerning the condition of existing highways are also used to establish priorities among the proposed projects. Once the basic needs are established, a financial plan identifying the sources and amounts of available funding is developed. Funding allocations are made based on each district's transportation needs, population, lane-miles, gasoline sales and other appropriate factors. Each district then refines their list of proposed projects to be consistent with the amount of funding available.

## Process

### 13.2.2 PD&E ~~Integrates~~

The project development phase for projects included in the Five Year Work Program and requiring PD&E includes environmental studies, the determination of project alignment and completion of preliminary design. Coordination with the Federal Highway Administration (FHWA), the State Departments of Environmental Regulation and Natural Resources, and public input are important elements of this phase. The PD&E process is described in detail in the PD&E Manual.

A detailed engineering report is normally produced in the PD&E stage which documents some of the key criteria to be used in the design of the particular facility. Typical sections, interchange and intersection locations and configurations, drainage features, conceptual bridge design, highway lighting justification, and right-of-way requirements are some of the elements that are sometimes finalized during the PD&E phase of the project. For some projects, value engineering reviews are conducted during the PD&E ~~stage~~ <sup>phase</sup>. Traffic control through work zones should also be considered.

Environmental investigations made during the course of a PD&E study are documented in the Environmental Impact document. Environmental documents frequently commit the State to certain restrictions, features and mitigation measures that must be included in the final design. The designer should carefully review the environmental documents before beginning the design. Sometimes restrictions, features and/or mitigation measures stipulated in the environmental document are such that the final design becomes unworkable. This will require a change in the environmental document. This document also lists the permits required to be obtained prior to construction of the project.

Although the district offices take the lead role in project development, the central office performs a quality assessment review of selected projects to ensure compliance with department standards and procedures. The project development phase usually takes from 12 to 36 months to complete.

#### 13.2.3 Final Design

The next major phase in the project life cycle includes engineering design and right-of-way acquisition. During this phase of the project, the final and detailed engineering design is completed and plans, specification and contract documents prepared for construction. For most projects, right-of-way acquisition is planned and carried out during this phase of the project. All required permits are also obtained. The various elements of the final design phase are explained in detail in subsequent chapters of this manual.

Engineering and right-of-way activities normally require from 12 to 36 months to complete, depending upon the size and scope of the project.

#### 13.2.4 Project Letting

Project letting is the next phase after final design. Once the design is complete and approved, the contract is let. To prepare a project for letting the DOT prepares specifications, plans packages, project cost estimate, and administers various procurement activities leading up to and including contract execution. These activities are performed primarily in the DOT's central office and require approximately 3 months to complete. Exhibit I-13-A illustrates the process leading up to the letting.



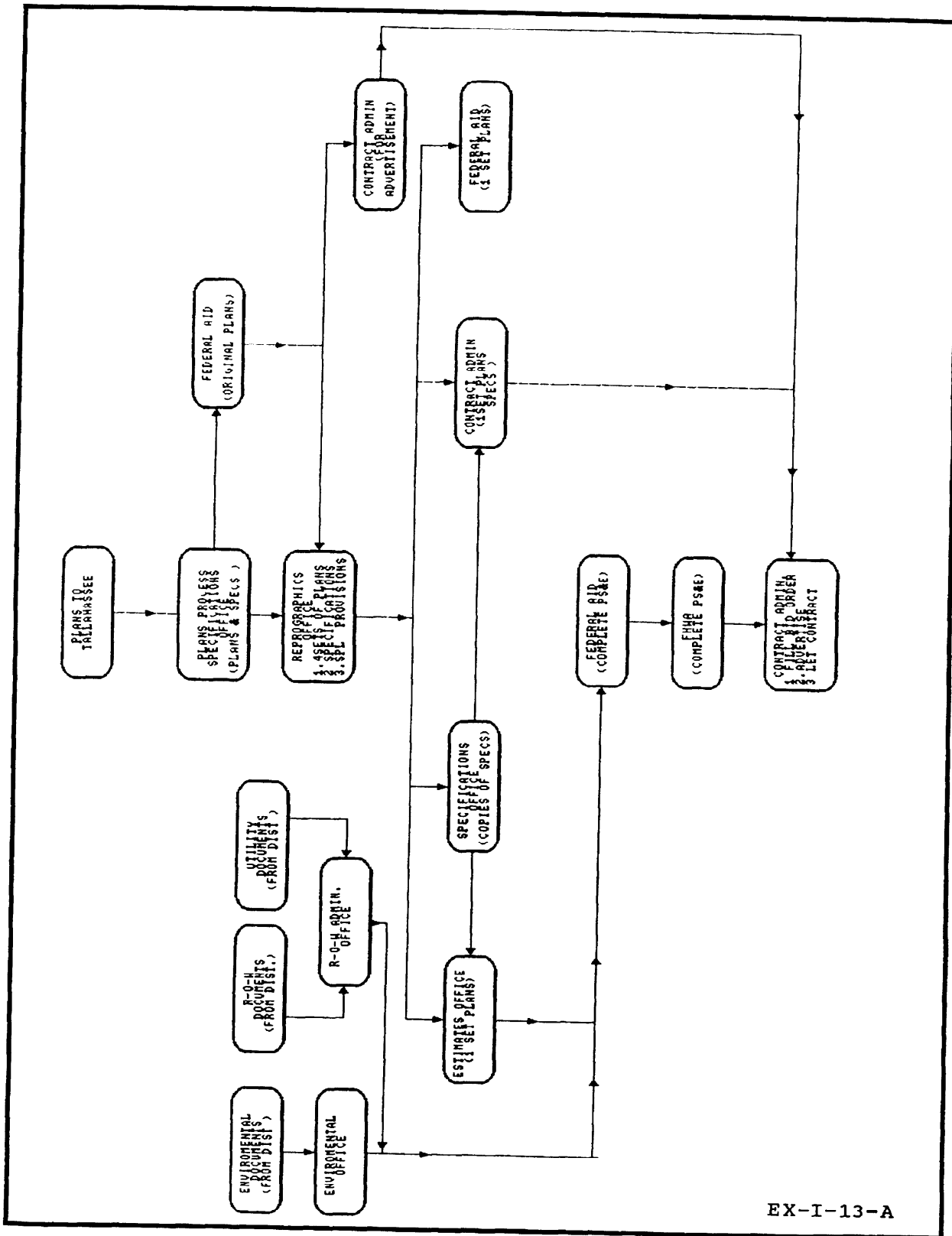

EX-I-13-A

### **13.3 RRR Design**

Resurfacing, Restoration and Rehabilitation (RRR) work is defined as work undertaken to extend the service life of an existing highway and enhance highway safety. This includes the placement of additional surface materials and other work necessary to return an existing roadway to a condition of structural and functional adequacy. It may include resurfacing, pavement structural and joint repair, minor lane and shoulder widening, the removal of parking and restriping as through lanes, removal of median curb to provide a turning lane or 2-way left turn lane, shoulder pavement, alterations to vertical and horizontal curvature, superelevation upgrading, bridge widening, modifications to bridge rails, intersection improvements, the addition of sidewalks and bikeways, utility relocation, removal or shielding of roadside obstacles, modification of side slopes and ditches, drainage modifications, upgrading of at-grade railroad crossings, aesthetic improvements, landscaping, lighting, and signing, signals and pavement markings. Pavement repairs on short segments, and patching and repair of minor pavement failures are considered by FHWA to be routine maintenance and are ineligible for RRR projects. To qualify for Federal funding, a resurfacing structural overlay must be a minimum thickness of 3/4 inch based on a structural analysis and the RRR project is required to adequately meet existing and probable future traffic needs in a manner conducive to safety, durability and economy of maintenance, within acceptable levels of community and environmental impact. The RRR project must be designed and constructed in a manner that will enhance highway safety and accomplish the foregoing objectives according to the particular needs.

| The design process and standards to be used for RRR projects on the State Highway System  
| facilities other than interstate and freeways are given in Chapter 25 of this volume. The Key  
| Sheet shall have a note stating that the project was designed to either the 1988 or the 1994 RRR  
| standards.

#### 13.4 In-House (DOT) Design

For in-house (DOT) design projects, all activities related to the project are performed by the various sections of the department. The complete design and preparation of the contract documents is accomplished by a team of roadway design personnel lead by the DOT Project Manager/Coordinator. Guidelines for in-house project flow are available in FDOT's Project Management Guidelines.

### 13.5 Consultant Design

Some design projects are contracted to consultants for design. A DOT project manager/coordinator is assigned to coordinate the project with the consultant and the various sections of the department. At specified stages in the project, the consultant is required to submit his plans to the Department for review. The DOT Project Coordinator/Manager distributes the plans as needed to the various sections for their review and comments. However, it is the consultant's responsibility to thoroughly check the plans for quality, accuracy and completeness before submitting to the Department. The DOT reviews the plans for compliance with scope, project requirements and progress.

Coordination with utility companies, permitting agencies, railroad companies, and adjacent projects is an important aspect of the design project. Responsibility for this coordination is usually specified in the consultant's scope of services.

At the completion of the design the complete plans package - consisting of the design plans, computations book, engineer's cost estimate, special provisions and other related data - is submitted to the department by the consultant. At this stage, the project is production ready. The consultant's scope of services will define the required number of plan sets and distribution.

### **13.6 Project Scheduling**

As mentioned earlier in this chapter, engineering and right-of-way activities of final design phase normally takes 12 to 36 months. Usually the project letting date is decided well in advance and, hence, other project activities are scheduled accordingly.

A design project undergoes four phase reviews. Some small projects (less than \$2,000,000) may undergo only two or three reviews depending upon the scope of work or the district's discretion. District's may also require reviews in addition to these phase reviews.

The Phase I review is the first milestone in the design of the project. The plans developed at this stage, with all existing utilities, topography, drainage, and other relevant data shown are used for preliminary utility and railroad coordination and review of preliminary proposed roadway geometrics. For complex projects, the preliminary or conceptual traffic control plan is also reviewed at this stage. If bridge structures are included in the project, then this phase also marks the review of the preliminary structural drawings including bridge data sheets and soil borings. Phase I completion of the project triggers other activities such as final drainage design, soil survey, utility contact conference, permit activities, requirements for final right-of-way maps, and foundation investigation activities for structures.

The next milestone, in a design project is the Phase II review. At the completion of this phase, the geometrics should be final and the mainline and sidestreet drainage design and soil survey are complete. New activities which start at this point are signalization, signing and marking, and roadway lighting design. Other ongoing activities are permits, bridge design, utility contact conference and adjustments, engineer's cost estimate, and right-of-way acquisition. At this stage of completion, the plans should be submitted to Construction for a constructability review.

The WPA data should be reviewed and updated, if needed at this stage of plans completion. The Phase II plans should be used to compare the "net" project length as shown on the key sheet with the gross project length obtained by subtracting the mileposts in the WPA system. If the

project length shown on the plans is more than 1/2 mile less than that in the WPA system, the project manager/designer should check with Production Management to correct the length

At Phase III plans, most activities including quantities, computation books and technical special provisions are complete, except, in some cases, the permit process and R/W acquisition. At this stage of completion, the plans and comp book should be submitted to Construction for a biddability review.

Once the Phase IV plans are reviewed and approved, and all utility agreements, R/W certifications and required permits are completed, the project is at the PID (Plans in District) stage. At this stage, the transmittal letter can be completed and the plans package transmitted to the central office in Tallahassee. Plans package requirements are listed in Chapter 20 of this volume. Exhibit EX-I-20-C is an example of the transmittal letter utilized to transmit final plans to Tallahassee.

For a detailed description of plans requirements for each phase, please refer to Chapter 2, Volume II of this manual.

Exhibit I-13-B shows the various activities of the design project.

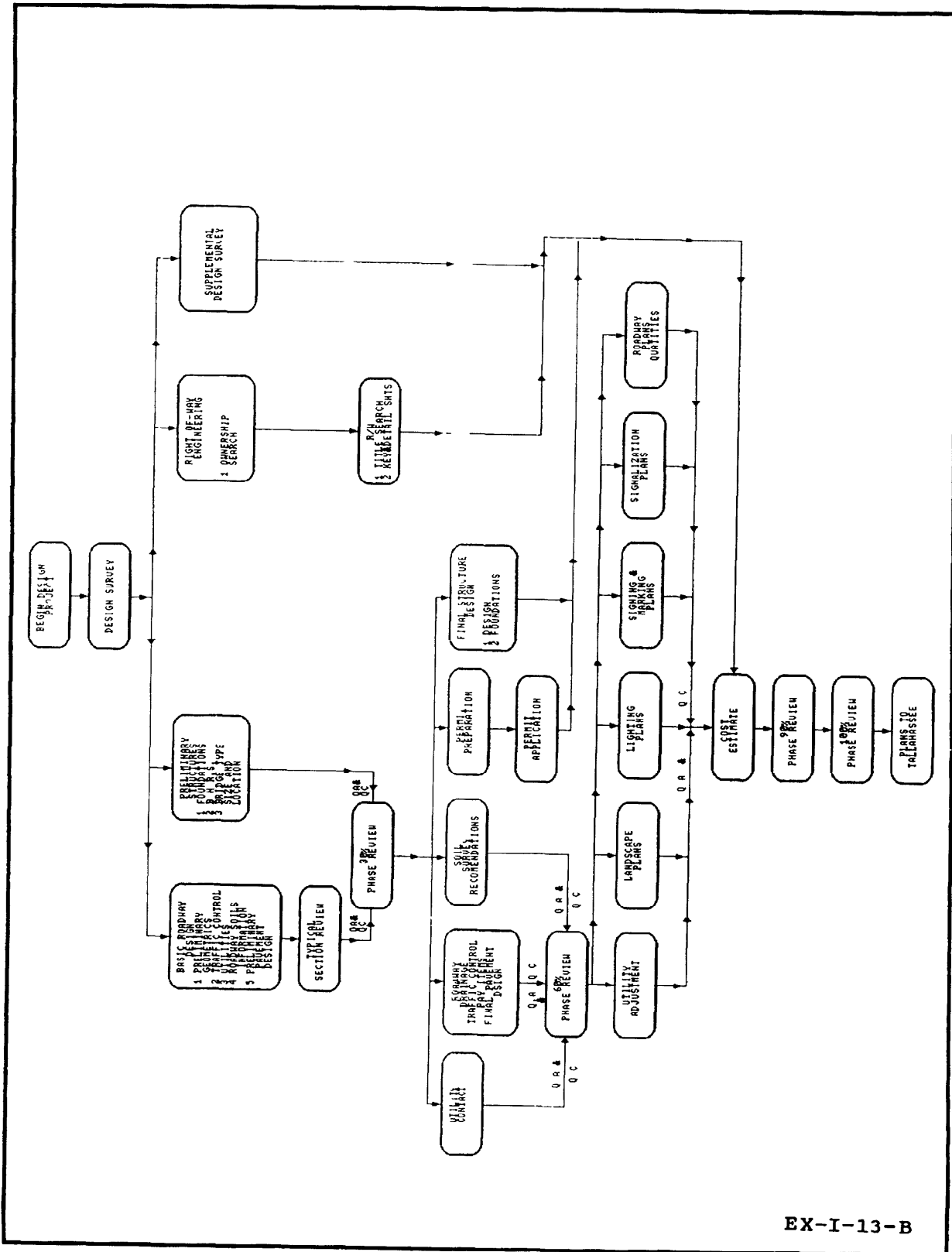



## CHAPTER 14

### DATA COLLECTION

#### 14.1 General

Data required for the design of a project are available from various sources in different forms. Prior to the start of design of the project, all available relevant data should be collected. The remainder of this chapter explains the various types of data required for the design process and their sources.

All correspondence concerning a project, including requests for or transmittal of data, shall contain the following information.

W P.I. Number	
State Project Number	
Federal Project Number (if applicable)	
Description	
County	

#### 14.2 Project Data

Project data are the data specific to the project and identify the project.

##### 14.2.1 Project Description

A complete description of the type of project, or facility, to be designed is available in the scope of services. The project length, location, county and milepost, type of facility and proposed modification or construction and total time to completion of the design are key items pertaining to the project description.

#### 14.2.2 Project Number

Each DOT project is assigned a project number and a work program identification (WPI) number. The project number indicates the county of the location of the project, the type of facility and the type of project - i.e., PD&E, or R/W, or construction.

For federal-aid projects, the project has a DOT project number and federal-aid project number.

The project and WPI numbers are shown on the keysheet of the project plans. (See exhibit II-3-A).

#### 14.2.3 Project Cost

The construction cost is estimated during the five-year program phase of the project, and this information is included in the program data documents. As costs are refined the Contract Estimating System (CES) should be updated to reflect the most current estimate. As a minimum, this should be done at each design phase.

#### 14.2.4 Production Schedule

As mentioned in Chapter 13, the project goes through various phases during the design process. Each of these phases marks a production milestone which is of particular importance to the overall schedule of the project. Certain activities in the production schedule are critical and cannot be delayed without jeopardizing the production schedule. Usually, the production schedule is set using two main constraints - the letting date and the total design project time.

### 14.3 Design Data

Technical data required for the design of a roadway project can be available from various sources in different forms. Some of those major sources and forms are discussed below:

#### 14.3.1 Surveys

a) Design Survey: A design survey documents the horizontal and vertical alignment, along a baseline or centerline of a project. This alignment is established with reference to fixed horizontal and vertical control points. Locations of other features - both natural and man-made - are also documented and tied to the baseline or centerline. Horizontal and vertical locations of existing aboveground and underground utilities are also given in the design survey, as described in Chapter 5. Requirements and details of conducting a design survey are given in the DOT Location Survey Manual.

b) Topographical Survey. This is one of the most important of field surveys. This survey documents all the existing features of the project site such as buildings by type, size and location with respect to baseline of survey, locations of streets and sidewalks, locations and limits of grassed or paved areas, wood lines, fence locations, lakes or ponds, changes in type of cultivation, drainage structures, and breaks in terrain. The Location Survey Manual describes procedures to be used in detail. All information from the topographical survey is input into the CADD file to provide the base data for the project.

c) Aerial Survey: Another method of obtaining project site existing features information is by aerial photographic survey. The information obtained by aerial photography survey is digitized and used as base data for the project. Good aerial

photo control is very important in order to get accurate aerial mapping. Procedures for establishing horizontal and vertical control points for aerial photo mapping are given in the Department's Location Survey Manual.

Digitized aerial mapping proves to be of great value in the preparation of drainage maps as it effectively records the development of the project vicinity at the time of design as well as the existing ground features.

d) Drainage Survey: All information pertaining to existing drainage conditions at the project site can be obtained from the drainage survey documents. A good drainage survey records pertinent historical facts related to the drainage of the area, reflects land use trends and any other data that may help in solving drainage problems of the project. Details of survey information required for drainage design are given in Chapter 4 of Volume 2A of the DOT Drainage Manual.

*Location*

e) Right-of-Way Survey: Project right-of-way is one of the important factors of the project and should be documented precisely. The R/W survey documents the existing R/W of the project facility. It also documents all public land corners, monuments, property lines, property owners, and complete dimensions of the properties.

f) Soil Survey: Soils information is required for the design of foundations for structures, pavement design and drainage design. A soils report for the project documents the type and extent of different types of soils encountered within the limits of the project. Physical properties and classifications of the soils together with the soils engineer's recommendations are documented in the soils and foundation report.

#### 14.3.2 Traffic Data

Traffic volumes and/or counts to be used for the design of a new facility or for the improvement of an existing one are obtained from the District Planning and/or Traffic Operations office.

Traffic data are obtained by actual traffic counts on existing roads, roadside interviews and polls of potential users. The ADT (Average Daily Traffic) volume is projected over the expected life of the facility. The total volume and the percent trucks are factors used in determining geometric design criteria, projected truck volume and truck weight data. Traffic counts, classification data, weight-in-motion data and W-4 Tables are used to produce 18 kip equivalent single axle loadings (ESAL), used for pavement design.

#### 14.3.3 Pavement Design

The pavement design should be completed as early as possible. For some projects, it is completed during the PD&E phase and for other projects it is one of the tasks to be completed during the design phase. The pavement type, composition and thickness, are determined using traffic data, projected ESALS, expected life-span of the facility, serviceability, and existing soils information. Details on pavement design can be found in DOT's pavement design manuals.

#### 14.3.4 Environmental Documents

During the PD&E phase of <sup>a</sup> ~~the~~ projects, studies are made to ~~estimate~~ <sup>evaluate</sup> the impact of the project on the environment. Factors such as noise generation and its abatement, business and residential relocations, wildlife habitat impact, and wetlands mitigation are documented in the Environmental document.

Information relating to the expected permits required for the construction of the project, and other related data are also contained in the environmental document. For small projects, a formal EIS may not be available, but all environmental data is usually available in the form of environmental reports. The environmental document may commit the State to certain design features. The designer should carefully review these documents to determine what design commitments have been made. Significant changes to the scope of the project may require reevaluation of the environmental factors.

#### 14.3.5 Original Plans

Original plans of existing facilities requiring reconstruction prove to be a very good source of information. Information pertaining to existing alignment - both horizontal and vertical - and R/W can be helpful in the design of the new facility.

#### 14.3.6 Accident Data

Accident data are provided by the District Safety Engineer. These data should be requested for all projects, but are especially useful for the design of 3R, safety and intersection projects and justification of signalized intersections.

#### **14.4 List of Requests and Contacts**

During the design process, the design engineer will require various items of information from different sections or departments. The following is a list of some of those items and their source.

##### **A) Planning and Programs**

- 1 ) Request pavement design (18 KIPS)
- 2 ) Request traffic data (motorized)
- 3 ) Request projected traffic data for intersections
- 5 ) Request updates of traffic data (as needed)
- 6 ) Railroad contact (Phase I)
- 7 ) Railroad contact (Phase III)
- 8 ) Plans transmittal letter data (railroad)
- 9 ) Notification that project is in vicinity of a traffic monitoring site

##### **B) Location**

- 1 ) Request survey

##### **C) Traffic Plans**

- 1 ) Request turns and counts for intersection design
- 3 ) Notification that project includes milling
- 4 ) Signing and pavement marking plans (Phase I)
- 5 ) Signing and pavement marking plans (Phase II)
- 6 ) Signing and pavement marking plans (Phase III)
- 7 ) Traffic signal plans (Phase I)
- 8 ) Traffic signal plans (Phase II)
- 9 ) Traffic signal plans (Phase III)
- 10 ) Lighting plans (Phase I)
- 11 ) Lighting plans (Phase II)
- 12 ) Significant review of accident data
- 13 ) Safety review of design plans
- 14 ) Response to safety review of design plans
- 15 ) Operational and capacity review of design plans

D) Soils and Foundations

- 1 ) Request pavement design LBR
- 2 ) Request roadway soil survey
- 3 ) Submit cross-sections for plotting of soils data
- 4 ) Request foundation investigations
- 5 ) Request pavement composition and milling recommendations
- 6 ) Request dynaflect testing
- 7 ) PH and soils resistivity for culvert material selection
- | 8 ) Phase III review, if unsuitable soils exist
- | 9 ) Review if any changes are made in alignment, grade or typical section

E) Drainage

- 1 ) Pavement design comments
- 2 ) Request grade and high water review
- 3 ) Request drainage design
- 4 ) Request final drainage review
- 5 ) Permit review

F) Maintenance

- 1 ) Pavement design comments
- 2 ) Phase I Plans review
- 3 ) Phase II Plans review
- 4 ) Phase III Plans review
- 5 ) Response to Phase I plans review
- 6 ) Response to Phase II plans review
- 7 ) Response to Phase III plans review



**G) Construction**

- 1 ) Pavement design comments
- 2.) Phase I Plans review
- 3 ) Phase II Plans review (Constructability Review)
- 4 ) Phase III Plans review (Biddability Review)
- 5 ) Response to Phase I plans review
- 6 ) Response to Phase II plans review
- 7.) Response to Phase III plans review
- 8.) Submit traffic control plan request
- 9.) Transmit marked-up utility adjustment plans

**H) R/W Surveying and Mapping**

- 1 ) Submit title search request
- 2 ) Request existing right-of-way maps
- 3 ) Transmit right-of-way requirements
- 4.) Final right-of-way check
- 5 ) Plans transmittal letter data

**I) Utilities**

- 1 ) Preliminary (First) contact (Phase I)
- 2.) Horizontal and vertical verification of utilities
- 3 ) Pre-Design conference and contact (Phase II)
- 4 ) Final contact (Phase III)
- 5 ) Plans transmittal letter data (utilities)
- 6.) Number of sets of final prints for utility companies

**J) Estimates and Specifications**

- 1 ) Preliminary estimate and time (LRE)
- 2 ) Preliminary estimate and time (Phase I)
- 3 ) Preliminary estimate and time (Phase II)
- 4 ) Preliminary estimate and time (Phase III)
- 5 ) Complete estimate and contract time (Phase IV)

**K) Right-Of-Way Department**

- 1.) Project schedule updates as needed
- 2.) R/W estimates as needed
- 3.) Pre-Proposal appraisal conference
- 4 ) Field questions from R/W agents as needed
- 5 ) Plans transmittal letter data
- 6 ) Hazardous waste determination
- | 7.) Phase I Plans Review (by Appraiser)
- | 8.) Phase II Plans Review (by Appraiser)
- | 9.) Phase III Plans Review (by Appraiser)
- | 10.) Phase IV Plans Review (by Appraiser)

**N) FHWA (if not CA or exempt)**

- 1 ) Phase I Plans review
- 2 ) Phase II Plans review
- 3 ) Phase III Plans review
- 4 ) Phase IV Plans Review
- 5.) Submit for typical section approval
- 6 ) Submit for pavement design approval
- 7 ) Response to Phase I plans review
- 8 ) Response to Phase II plans review
- 9.) Response to Phase III plans review
- 10.) Submit exception request letters

**O) Value Engineering (\$2,000,000+)**

- 1 ) Phase I review
- 2 ) Phase II review

Exhibits EX-I-14-A thru I are examples of some request forms utilized in obtaining the various information items required for design

DATE:

TO: Highway Statistics Engineer

FROM:

COPIES TO:

SUBJECT: State Road No.....

W.P.I. No.....

State Project No..

F.A.P. No.....

County.....

Description.....

\*Description

Limits of Job .....

Budget Construction Year .....

Year Open to Traffic.....

No. of Lanes, Existing.....

No. of Lanes, Proposed.....

Type of Facility.....

(e.g. major, intermediate, or minor arterial,  
freeway, expressway, city street, rural road, ramp)

System Name.....

(Interstate, FAU, FAS, etc.)

Pavement Type.....

Type of Work.....

Please forward this Design Section, the following information  
for the subject project:

A. Traffic Parameters requested are:

1. ADT's
2. K, D & T Factors
  - a. T Factor Breakdown
    1. % of ADT

B. Equivalent 18 KIP Loadings

C. Years

1. \_\_\_\_\_ Current Year
2. \_\_\_\_\_ Construction Year
3. \_\_\_\_\_ Mid-year (10 years from opening)
4. \_\_\_\_\_ Design year (20 years from opening)

EX-I-14-A

DATE:  
TO: Soils Engineer  
FROM:  
COPIES TO:  
  
SUBJECT: State Road No....  
W.P.I. No.....  
State Project ...  
F.A.P. No.....  
County .....  
Description.....

Transmitted herewith are prints of Plan and Profile Sheets and Cross Section Sheets on the subject project, indicating proposed alignment, gradient and flow line of proposed structures.

(For Widening and/or Resurfacing, Key Map and Typical Section Sheets only).

This is for your use in obtaining the following:

- Soils Survey
- Percolation Test
- Water Samples
- Thickness and Type of Asphalt
- Thickness and Type of Base
- Thickness and L.B.R. Value of Existing Subgrade
- Design L.B.R.
- Amount and Type of Leveling Recommended
- Milling Recommendation
- Soil Boring (For Structure)
- Pavement Composition

Please furnish this information by \_\_\_\_\_.

If additional information is required, please feel free to contact this office.

Enclosure

EX-I-14-B

SURVEY REQUEST

PROJECT NO. \_\_\_\_\_

B.I. NO. \_\_\_\_\_

PROJECT  
DESCRIPTION

\_\_\_\_\_  
\_\_\_\_\_  
\_\_\_\_\_  
\_\_\_\_\_

LIMITS  
SURVEY

\_\_\_\_\_  
\_\_\_\_\_  
\_\_\_\_\_  
\_\_\_\_\_

REQUEST:

1. ALIGNMENT

\_\_\_\_\_  
\_\_\_\_\_

2. TOPO

\_\_\_\_\_  
\_\_\_\_\_

3. R/W

\_\_\_\_\_  
\_\_\_\_\_

4. CROSS SECTION

\_\_\_\_\_  
\_\_\_\_\_

5. OUTFALLS

\_\_\_\_\_  
\_\_\_\_\_

6. SIDE STREETS

\_\_\_\_\_  
\_\_\_\_\_

7. UTILITIES

\_\_\_\_\_  
\_\_\_\_\_

8. OTHER

\_\_\_\_\_  
\_\_\_\_\_

EX-I-14-C  
1 of 2

Charges can be made to Project No. \_\_\_\_\_

Comments: \_\_\_\_\_

Requested by \_\_\_\_\_ Date \_\_\_\_\_

EX-I-14-C  
2 of 2

DATE:

TO: Materials Engineer

FROM:

COPIES TO:

SUBJECT: State Road No.....

W.P.I. No.....

State Project No..

F.A.P. No.....

County.....

Description.....

Enclosed for your use are Key Map Cross Sections and marked prints of Plan and Profile Sheets for boring locations on the subject project.

If additional information is required, please feel free to contact this office.

Enclosures

EX-I-14-D

DATE:

TO: Environmental Permit Coordinator

FROM:

COPIES TO:

SUBJECT PERMIT SKETCH

State Road No.....

W.P.I. No.....

State Project No..

F.A.P. No.....

County.....

Description.....

Transmitted herewith are the original permit sketches for the above referenced project.

The following information is included to enable you to apply for the necessary permits:

1. Production date \_\_\_\_\_.
2. Letting date \_\_\_\_\_.
3. Approximate construction days \_\_\_\_\_.
4. Natural \_\_\_\_\_ or man-made \_\_\_\_\_ body of water.
5. Name of waterway \_\_\_\_\_.
6. Brief description of project:

If additional information is required, please feel free to contact this office.

Enclosures

EX-I-14-E



DATE:  
TO: District Railroad Coordinator  
FROM:  
COPIES TO:

SUBJECT: State Road No.....  
W.P.I. No.....  
State Project No..  
F.A.P. No.....  
County.....  
Description.....

Submitted this date is Sheet \_\_\_\_\_ of the signalization plans for your handling with the railroad.

The following work is proposed within railroad right-of-way.

If additional information is required, please feel free to contact this office.

Enclosure

EX-I-14-F

DATE:  
TO: Utilities Engineer  
FROM:  
COPIES TO:

SUBJECT UTILITIES TRANSMITTAL

State Road No.....  
W.P.I. No.....  
State Project No..  
F.A.P. No.....  
County.....  
Description.....

Transmitted herewith are \_\_\_\_ sets for your use in the coordination of utilities for the subject project.

If additional information is required, please feel free to contact this office.

Enclosures

EX-I-14-G

DATE:

TO: Construction Engineer

FROM:

COPIES TO:

SUBJECT: State Road No.....  
W.P.I. No.....  
State Project No..  
F.A.P. No.....  
County.....  
Description.....

Transmitted herewith is the Record Computation Booklet  
for the above referenced project.

Please note the following comments:

1. This project is scheduled for a \_\_\_\_\_  
production.
2. The district Construction Engineer recommends a contract  
time of \_\_\_\_\_ calendar days for this project.
3. The record prints are on file in the District Office.

If additional information is required, please feel free to  
contact this office.

Enclosure

EX-I-14-H

I-14-19.0

BUREAU OF TOPOGRAPHY  
 FLORIDA DEPARTMENT OF TRANSPORTATION

SUPPLEMENTAL WORK REQUEST FORM  
 FOR  
 CADD AND CROSS SECTION PROJECTS

(ATTACH TO WORK REQUEST  
 FORM PD 100) #87-1417

PROJECT NAME \_\_\_\_\_ STATE JOB NO \_\_\_\_\_

REQUESTED BY \_\_\_\_\_ DATE \_\_\_\_\_

DELIVER TO \_\_\_\_\_

DIGITIZED TOPOGRAPHY  
 SCALE OR SCALES  
 DESIRED

1" = 20'	1" = 40'	1" = 50'	OTHER

LIMITS OF  
 COMPILATION

LEFT LIMITS	RIGHT LIMITS

HAS HORIZ ALIGNMENT BEEN CODED IN ROADS DESIGN FILE?

YES	NO

NAME OF PERSON IN CHARGE OF ROADS FILE \_\_\_\_\_

ARE PHOTOGRAMMETRIC CROSS SECTIONS DESIRED

YES	NO

WHAT CENTERLINE INTERVALS \_\_\_\_\_

COVERAGE RIGHT  
 AND LEFT

LEFT LIMITS	RIGHT LIMITS

SPECIAL REQUEST REQUIREMENTS OR COMMENTS \_\_\_\_\_

FIELD CHECK BY

DELIVERY MEDIA

PLOTTED ON MYLAR \_\_\_\_\_  
 PLOTTED ON PAPER \_\_\_\_\_  
 WRITTEN ON TAPE \_\_\_\_\_  
 WRITTEN TO DISC \_\_\_\_\_

DISTRICT	TOPO	OTHER

EX-1-14-I

## Chapter 15

### Phase Reviews and Scheduled Submittals

#### 15.1 General

All major projects will have four phase reviews prior to transmittal of plans to the Central office for letting. Phase I, II, III, and IV reviews will be performed and documented. Minor projects, such as resurfacing, will have a minimum of two phase reviews. The two reviews should consist of a final phase and one prior phase review.

Phase reviews are performed to allow other District Office units (Safety, Maintenance, Construction, etc.) to provide input regarding the development of the project and to review the adequacy and completeness of the plans. Phase reviews are not intended to be the only Quality Control. Quality Control shall be performed prior to each submittal of the plans for a phase review as discussed in Chapter 16 of this volume.

Each District shall develop a procedure for accomplishing all phase reviews. The procedure will identify the persons responsible for coordinating the phase reviews and distributing the plans for the reviews. The individuals and offices that will review and provide comments on each phase review should be identified in the procedure. The procedure must also outline the method of documenting all phase reviews, including the resolution of any comments made during the reviews.

The District shall ensure that the requirements of each phase review as shown in this manual are met. Phase reviews are complete when the comments from all the various offices have been resolved and documented.

## **15.2 Design Plans Phase Review**

| On minor projects reviews will be held at a final phase and at one prior phase. One of these reviews must be an on-site review. All reviews will include personnel from Design, Construction, Maintenance, Safety, FHWA (for Federal Aid Projects which are not CA or exempt) and any other department representatives who can provide review input. A formal on-site review shall be made to ensure the design is appropriate and that no physical features have been altered or added.

| On complex projects reviews must be held at the Phase I, II and III stages as well as the final check at Phase IV. Two on-site reviews will be required. Generally these are held at Phases I and III with personnel from the offices noted under minor project reviews. Also, an on-site visit before design by the senior designer is desirable.

| For phase reviews which are not held on-site, construction, maintenance, Safety and FWHA (for federal aid projects which are not Certification Acceptance or exempt) offices must be sent copies of the plans and requested to furnish comments.

An additional update review, including an on-site review, will be required on all projects that have been delayed and shelved for more than nine months since the final review.

| The District Safety Engineer shall be given an opportunity to be included in these reviews. The use of accident history is required on all reconstruction, intersection improvements and 3R type projects to ensure that all accident problems have been addressed.

The District Project Manager/Coordinator is responsible for ensuring that prints are distributed to the appropriate personnel and that the above reviews are held on each project. Size "B" (11" x 17") prints may be used for reviews, at the District's option.

For consultant projects, the Districts are to specify the number of prints required and the size prints, if there is a preference. This should be stated on the consultant's scope of services.

For detailed requirements of each phase review submittal, please refer to Chapter 2 of Volume II of this manual.

### 15.2.1 Plans Disposition

As discussed in Chapter 13 of this Volume, each phase of the plans preparation triggers other activities in the process of the project's design life cycle.

The Phase I plans are used for the initial contact with the utility companies. The alignment, horizontal and vertical, and typical sections are checked for compliance with design criteria, project and site requirements, compatibility with adjacent projects and drainage requirements.

The Phase II plans are used for the signing and marking design, roadway lighting design, signalization design, traffic control sheets, other component plans preparation, permit package preparation, constructability review and updating of the WPA system. Usually at this stage of the project a utility predesign conference also occurs. CES data input is recommended at the completion of Phase II plans.

At Phase III all plans are usually complete including the Quantity Computation Book(s) and the cost estimate and Construction has performed a biddability

review After Phase IV a record set of plans are signed, sealed and dated, and the originals placed in PID Status to be transmitted to the Central Office in Tallahassee

The disposition of the plans after they are transmitted to the Central Office is shown in Exhibit EX-I-13-A in Chapter 13

### 15.3 Other Submittals and Requests

Other design plans, besides the roadway plans, of a project also go through reviews at various stages of the design as listed below

#### 15 3 1 Structures (Bridges, Walls and Buildings)

##### 1 Bridges

Bridge design begins when the foundation investigation is complete and on a schedule which permits preliminary bridge plans and the Phase II roadway plans to be reviewed simultaneously In the case of a stream or river crossing, the drainage design, including preliminary scour considerations, must also be complete prior to beginning structures design All structures design work is coordinated through District Structures Engineer or the State Structures Design Office in the Central Office, depending on the category or complexity of the structure A typical section of the facility crossing, horizontal and vertical clearances required and the profile grades should be determined prior to beginning structures design For complete details and requirements for structural designs and plans preparation, the reader is referred to the Structures Design Guidelines (Topic 625-020-101) and the Structures Detailing Manual (625-020-201) issued by the Structures Design Office



Generally, the completion and review of bridge plans are completed in three phases as listed below. These reviews do not necessarily coincide with the phase reviews of the roadway plans.

Preliminary - (30%)

Final (90%)

Tracings (100%)

In order to prevent problems and to "Do it right the first time," the following procedures should be used:

Typical Section Package - The typical section approval package should include a section showing width of bridge that is to be provided for all bridges. The structural design should not proceed until the typical section has been approved by the District Design Office.

Request for Structural Design - (Bridges and Retaining Walls) All requests for structural design should include roadway plan and profile sheets showing horizontal and vertical alignment and cross sections within 500 feet on each end of the bridge or ends of retaining walls. Horizontal curvature that is on or near the end of the bridge or retaining wall must be shown. Superelevation transition (runoff) details must be included with the transmittal if any part or all of the transition is on the bridge or wall. The approved typical section should be included with the transmittal.

Provisions for access to property near the end of bridges and adjustments to avoid costly right-of-way takings should be resolved prior to submittal. An attempt should be made to avoid horizontal and vertical curvature on the bridge, if possible, without sacrificing safety. Superelevation transition lengths may be appropriately adjusted, to avoid transitions on the bridge.

Coordination of Final Plans - The District will request prints of bridge plans prior to submittal of the final roadway plans to Tallahassee to ensure that roadway and bridge plans are consistent, i.e., widths, superelevation transitions, vertical and horizontal alignment, and work zone traffic control agree

## 2 Other Structural Submittals and Reviews

In addition to bridge plans, structures plans may include retaining walls, noise barrier walls, box culverts, pedestrian overpasses, and special structural appurtenances

For projects where bridges and other structure plans are involved, preliminary and final plan submittals (usually along with bridge plans) should be handled according to the instructions for current and future handling of structures tracings (reproducibles) for both Category 1 and 2 structures, dated August 23, 1991, from the Structures Design Office

For projects where retaining walls are required along with roadway plans only (no bridge in the project), DOT District Offices shall be responsible for development of wall plans, proper reviews and submittal of preliminary and final plans and submittals to the FDOT prequalified wall companies, if applicable

## 3 Mechanically Stabilized Earth Walls

Where proprietary walls are involved, the detailed control plans shall be submitted to DOT approved wall companies. This will be the responsibility of the consultant or the DOT Office responsible for development of wall plans. The preliminary control plans should be submitted early in the project development. This will give the wall companies time to prepare a good bid by the time the contract is let.

After appropriate structural and geotechnical review, the wall plans are submitted directly to all appropriate prequalified wall companies for their bidding information. The Florida DOT District Office is responsible for the structural and geotechnical review prior to submitting these plans for review. The submittal of detailed control plans should occur as early in the design process as possible to give companies plenty of time to prepare a good construction bid proposal.

Where the District Office cannot carry out the structural review or verify the review as proper by a consultant, such review may be requested from the Structures Design Office

The wall companies only claim responsibility for their system, the wall and soil mass engaged - thus the geotechnical review must include analysis of the boundary soil conditions. Chapter 18 of the Structures Design Guidelines (Topic 625-020-101) contains the procedures and requirements for the engineering and geotechnical design of retaining walls

### 15.3.2 Surveys

Most field surveys will be completed before the start of the design since the survey information is needed for the design. The Roadway soils survey is normally completed between the Phase I and Phase II Roadway plans review |

Survey for bridge data sheets and channel alignment should be completed during |  
this same period |

### 15 3 3 Typical Sections

All projects except intersection improvements and state funded resurfacing projects require approval of the typical section. For most projects, the typical section is approved during the PD & E phase. For Final design projects that require approval of typical sections, the typical section package should be submitted before the Phase I review to allow ample time for approval. Typical sections shall be submitted on 8 1/2" x 14" sheets, approved, signed and sealed by the responsible engineer. Space must be provided for concurrence by the DOT and, for projects with FHWA oversight, by FHWA. Exhibits EX-I-15-A thru EX-I-15-D are samples of Typical Section Data Sheets utilized for Typical Section approval. Exhibits EX-I-15-A and C are to be used when prepared by a consultant for the Department. Exhibits EX-I-15-B and D are to be used when prepared in-house.

When preparing typical section packages, only typical sections for the main roadway and/or bridge are necessary. Minor variations to these do not need typical sections. All side street tie-ins, etc., can be handled as part of the routine plan review process or as partial sections which show typical details.

# TYPICAL SECTION DATA SHEET

PROJECT IDENTIFICATION	WORK PROJ. ITEM	COUNTY	SECTION	JOB	STATE RD	F.A. PROJ. NO.
PROJECT LENGTH		PROJECT LIMITS				
		BEGINS:		ENDS:		
FUNCTIONAL CLASSIFICATION	( ) RURAL ( ) URBAN	TRAFFIC (ADT)		DISTRIBUTION	DESIGN SPEED	
( ) FREEWAY/EXP	( ) MAJOR COLL.	_____ CURRENT		X _____ X	_____	
( ) PRINCIPAL ART	( ) MINOR COLL.	_____ POST CONST		D _____ X	POSTED SPEED	
( ) MINOR ART	( ) LOCAL	_____ FUTURE ( ) YEAR		T _____ X	_____	
DESIGN STANDARDS WILL CONFORM WITH REQUIRED STANDARDS			FEDERAL AID PROGRAM			
( ) NEW CONST YES NO			YES NO			
( ) MAJOR RECONST ( ) ( ) VERTICAL ALIGNMENT			( ) ( ) FEDERAL AID SYSTEM			
( ) RRR ( ) ( ) HORIZONTAL ALIGNMENT			( ) ( ) F.A. INTENDED			
IF NO (ABOVE) LIST DEVIATIONS			( ) ( ) ADD TO SYSTEM			
			RECOMMENDED MAINTENANCE			
			( ) FDOT			
			( ) COUNTY			
			( ) OTHER _____			
RR CROSSINGS			NO. OF TRACKS			
RAILROAD _____ LOCATION _____			_____ MAIN _____ PASSING _____ IND			
EXISTING PROTECTION _____						
PROPOSED PROTECTION _____						
LAND USE (GIVE NO. PER MILE)			NONMOTORIZED TRAFFIC *			
_____ RESIDENTIAL DRIVEWAYS			PEDESTRIAN BIKE LIST TYPE OF PED./BIKE TRAFFIC			
_____ COMMERCIAL DRIVEWAYS			( ) NONE ( ) NONE // / GRADE SCHOOL // / ADULT			
_____ WITH ACCEL./DECEL. LANES			( ) MODERATE ( ) MODERATE // / MIDDLE SCHOOL // / PROFICIENT			
_____ 2-LANE NON-SIGNALIZED INT			( ) HEAVY (SCHOOL) ( ) HEAVY // / HIGH SCHOOL // / SENIOR ADULT			
_____ 2-LANE SIGNALIZED INT			_____ // / ESTIMATED ANNUAL GROWTH			
_____ 4-LANE NON-SIGNALIZED INT			NO. OF EACH WITHIN 2 MILES *			
_____ 4-LANE SIGNALIZED INT			_____ GRADE SCHOOLS _____ VO-TECH/COLLEGES _____ MAJOR EMPLOYERS _____ % OF UNDEV. LAND IN CORRIDOR			
_____ MEDIAM OPENINGS			_____ MIDDLE SCHOOLS _____ SHOPPING/SERVICES _____ PARKS/RECREATION			
_____ OTHER (SPECIFY) _____			_____ HIGH SCHOOLS _____ OTHER SIGNIFICANT ATTRACTORS			
MAJOR INTERSECTIONS (LOCATION/DESCRIPTION - REQUIRING SPECIAL DESIGN)						
MAJOR STRUCTURES (LOCATION/DESCRIPTION - REQUIRING INDEPENDENT STRUCTURE DESIGN)						
UTILITY CONFLICTS (POSSIBLY AFFECTING PROJECT CONCEPT)						
TRAFFIC SIGNALIZATION (LIST INTERSECTIONS)						
HIGHWAY LIGHTING (DESCRIBE LIMITS)						
REMARKS (REGARDING MOTORIZED AND NONMOTORIZED USAGE)						
CONCURRENCE:		CONCURRENCE:		APPROVED BY:		
FHWA DISTRICT ENGINEER _____		DISTRICT DESIGN ENGINEER _____		CONSULTANT _____		
DATE: _____		DATE: _____		DATE: _____		

\* SECTIONS MARKED BY AN "\*" ARE TO BE COMPLETED BY THE DISTRICT BICYCLE COORDINATOR

# TYPICAL SECTION DATA SHEET

PROJECT IDENTIFICATION	WORK PROJ. ITEM	COUNTY	SECTION	JOB	STATE RD	F.A. PROJ. NO
PROJECT LENGTH		PROJECT LIMITS				
		BEGIN:		ENDS:		
FUNCTIONAL CLASSIFICATION	( ) RURAL ( ) URBAN	TRAFFIC (ADT)		DISTRIBUTION		DESIGN SPEED
( ) FREEWAY/EXP	( ) MAJOR COLL.	_____ CURRENT		K _____ %		_____
( ) PRINCIPAL ART	( ) MINOR COLL.	_____ POST CONST		D _____ %		POSTED SPEED
( ) MINOR ART	( ) LOCAL	_____ FUTURE ( ) YEAR		T _____ %		_____
DESIGN STANDARDS			WILL CONFORM WITH REQUIRED STANDARDS		FEDERAL AID PROGRAM	
( ) NEW CONST			YES NO		YES NO	
( ) MAJOR RECONST			( ) ( ) VERTICAL ALIGNMENT		( ) ( ) FEDERAL AID SYSTEM	
( ) RRR			( ) ( ) HORIZONTAL ALIGNMENT		( ) ( ) F.A. INTENDED	
IF NO (ABOVE) LIST DEVIATIONS			( ) ( ) OTHER DESIGN STANDARDS		( ) ( ) ADD TO SYSTEM	
					RECOMMENDED MAINTENANCE	
					( ) FDOT	
					( ) COUNTY	
					( ) OTHER _____	
RR CROSSINGS			NO OF TRACKS			
RAILROAD _____ LOCATION _____			_____ MAIN _____ PASSING _____ IND			
EXISTING PROTECTION _____						
PROPOSED PROTECTION _____						
LAND USE (GIVE NO. PER MILE)		NONMOTORIZED TRAFFIC *				
_____ RESIDENTIAL DRIVEWAYS		PEDESTRIAN		LIST TYPE OF PED./BIKE TRAFFIC		
_____ COMMERCIAL DRIVEWAYS		( ) NONE		_____ % X GRADE SCHOOL _____ % X ADULT		
_____ WITH ACCEL./DECEL. LANES		( ) MODERATE		_____ % X MIDDLE SCHOOL _____ % X PROFICIENT		
_____ 2-LANE NON-SIGNALIZED INT		( ) HEAVY (SCHOOL)		_____ % X HIGH SCHOOL _____ % X SENIOR ADULT		
_____ 2-LANE SIGNALIZED INT		( ) HEAVY		_____ % X ESTIMATED ANNUAL GROWTH		
_____ 4-LANE NON-SIGNALIZED INT		NO. OF EACH WITHIN 2 MILES *				
_____ 4-LANE SIGNALIZED INT		_____ GRADE SCHOOLS		_____ VO-TECH/COLLEGES		_____ % OF UNDEV. LAND IN CORRIDOR
_____ MEDIAN OPENINGS		_____ MIDDLE SCHOOLS		_____ MAJOR EMPLOYERS		_____ PARKS/RECREATION
_____ OTHER (SPECIFY) _____		_____ HIGH SCHOOLS		_____ SHOPPING/SERVICES		_____ OTHER SIGNIFICANT ATTRACTORS
MAJOR INTERSECTIONS (LOCATION/DESCRIPTION - REQUIRING SPECIAL DESIGN)						
MAJOR STRUCTURES (LOCATION/DESCRIPTION - REQUIRING INDEPENDENT STRUCTURE DESIGN)						
UTILITY CONFLICTS (POSSIBLY AFFECTING PROJECT CONCEPT)						
TRAFFIC SIGNALIZATION (LIST INTERSECTIONS)						
HIGHWAY LIGHTING (DESCRIBE LIMITS)						
REMARKS (REGARDING MOTORIZED AND NONMOTORIZED USAGE)						
CONCURRENCE:				APPROVAL:		
FHWA DISTRICT ENGINEER: _____				DISTRICT DESIGN ENGINEER: _____		
DATE: _____				DATE: _____		

\* SECTIONS MARKED BY AN \*\* ARE TO BE COMPLETED BY THE DISTRICT BICYCLE COORDINATOR

STATE OF FLORIDA DEPARTMENT OF TRANSPORTATION  
PROPOSED TYPICAL SECTION

COUNTY	ROAD NO.	LENGTH	TERMIN	SECTION	JOB	EST. COST	FEDERAL AID PROJECT NO.	
							WPI NO.	APPROVED BY: CONSULTANT _____ DATE: _____

STATE OF FLORIDA DEPARTMENT OF TRANSPORTATION  
PROPOSED TYPICAL SECTION

COUNTY	ROAD NO.	LENGTH	TERMINI APPROVED DESIGN ENGINEER _____ DATE _____	SECTION	JOB	EST. COST
	FEDERAL AID PROJECT NO.	WPI NO.		FMVA CONCURRENCE FMVA DISTRICT ENGINEER _____ DATE _____	(CONSTRUCTION)	



#### 15 3 4 Pavement Design

For projects that require pavement design in the design phase, the pavement design package should be submitted as early as possible. For some projects, a preliminary pavement design is approved at or before the Phase I review with the final pavement design being approved at the Phase II completion stage.

Pavement design packages sent to the FHWA for approval should only be for the major items of the main roadway. Minor variations can be handled as part of the normal plans review process.

#### 15 3 5 Permits

The required permits will be determined during Project development and Environmental Study phase. The District permitting office is responsible for coordinating and processing the permits and must be contacted early in the project to determine the level of detail needed in the permit packages. The DOT Project Manager/Coordinator must communicate this information to the appropriate office preparing the permit packages. In general, permit approval is a lengthy process and permit applications must be submitted early enough so that the construction schedule will not be delayed due to permits being processed.

The permitting agencies and the estimated processing time frame should be listed in the overall project schedule developed by the Project Manager/Coordinator.

Agencies with permitting authority are listed below

Florida Department of Environmental Regulation

U S Coast Guard

Local Environmental Agencies

U S Army Corps of Engineers

Florida Department of Natural Resources - Bureau of Beaches  
and Shores

Agencies with an interest but no permitting authority are listed below

Florida Department of Natural Resources - Bureau of Beaches  
and Shores

Florida Game and Freshwater Fish Commission - Office of  
Environmental Services

Florida Department of Veterans and Community Affairs -  
Bureau of Land and Water Management

U.S Fish and Wildlife Services

National Marine Fisheries Service - Environmental  
Assessment Branch

Regional Planning Councils

Local Governments and Transportation Authorities

U S. Environmental Protection Agency

15 3 6 Right of Way Surveying and Mapping

During right-of-way map preparation there are typically four phases as described below All map preparation procedures shall be in accordance with the DOT Right-of-Way Surveying and Mapping Manual

- Preliminary - involves project alignment, curve data, section corners, cross road alignments
- Intermediate - revisions from preliminary submittal, existing right-of-way, subdivisions, interchanges, proposed right-of-way with takings dimensioned
- Near Final - revisions from intermediate submittal, easements, tabulation of ownerships, right-of-way requirements for drainage easements
- Final - revisions from near final submittal, complete right-of-way maps in accordance with the DOT Procedure 575-010-000

Right-of-way maps are prepared in accordance with the procedures as described in the Department's Right-of-Way Surveying and Mapping Manual Information is added to the right-of-way maps as it becomes available and close coordination is required between the design and right-of-way sections R/W requirements should be well identified on roadway plans as early as possible Final requirements on project alignment must be identified by Phase II roadway plans and transmitted to R/W office

Title search will be ordered as soon as feasible alternatives are determined It is necessary, particularly on urban projects, to obtain ownership search to assist in the establishment of the right-of-way limits The ownership search may be

conducted by the District Right-of-Way Surveying and Mapping office or the design consultant

Access road and drainage (outfalls) requirements are generally the last requirements to be established in the R/W phase and must not be overlooked. They should be established in the PD&E phase when possible and adjustments made as necessary. Access road studies (justification) are required on limited access and federal aid projects and will necessitate appraisals. The appraisals and justification are developed by Department personnel or by fee appraisers. This activity takes time and therefore should be requested as soon as possible. Appraisals have an age limit, therefore, they must be compatible with the acquisition schedule.

The instruments are prepared by the Department, although the legal descriptions may be prepared by the design consultant's surveyor.

It is important to note that, on federal-aid projects, the formal appraisal activity cannot begin until the final right-of-way map is approved and the function is programmed with the FHWA. The right-of-way requirements must be made available for R/W map preparation at the earliest possible time to facilitate the timely acquisition of title searches.

Occupancy permit requirements must be defined by the 100% plans completion stage so they can be obtained by the right-of-way office.

## 15 3 7 Value Engineering

Any FDOT project with a construction cost in excess of \$2,000,000 are candidates for a value engineering review. The Value Engineering Coordinator will screen and select projects based on cost saving potential. The Project Manager and/or Designer should expect recommendations from the value engineering team that will need to be incorporated into the design. However basic concepts established during the PD&E phase will not be altered except in extraordinary circumstances.

If a project has been selected for a value engineering review, it is the Project Manager's/Designer's responsibility to ensure the review is conducted in a time frame that allows maximum opportunity for value improvement considerations and still maintain proper project progress. Value engineering reviews shall be conducted in accordance with the Value Engineering Design Review Procedure No 625-030-002a. As such, value engineering reviews should occur no later than Phase I plans completion. Accepted design changes can be accomplished with minimal impact of project schedule if value engineering recommendations are provided early in the design phase.

### VALUE ENGINEERING TEAM

The Project Manager, as the leader of the design effort, should be available to the value engineering team to provide input concerning project decisions and data. When the project is being developed by a consultant, a representative of the consultant should be available to present to the team, assumptions and data for project decisions. The Project Manager should maintain close communications with the value engineering team leader as the study progresses, continually providing input for consideration by the team.

## VALUE ENGINEERING FINDINGS

After completion of the value engineering team study, a draft summary report will be prepared. The Project Manager should make a thorough review of the findings with the team's input. Questions that should be asked are

- o Do the recommendations achieve the objectives of the project?
- o Have all design and existing conditions been considered?
- o Are all changes suggested economically feasible?
- o Will the project schedule be affected by the changes? Are the delays justified by the savings resulting from the changes?
- o Are the changes consistent with agreements with the local community or citizen groups?
- o Will additional public meetings be required?
- o Are any design controls altered? Are they acceptable?
- o Do the recommendations provide a long term advantage or short term solutions?
- o Will the recommended changes improve the project?

The purpose of this session is to afford the Project Manager with a "first" review of the team's recommendations, and to evaluate with the team, their potential implementation. The Project Manager, being the most knowledgeable person of the project specifics and objectives, should use this opportunity to ensure that recommended changes are consistent with project intent.

If the Project Manager and the value engineering team are in agreement, the value engineering summary study should be finalized and distributed to all persons concerned with the project, along with written concurrence of implementation by the Project Manager. In the event that the Project Manager and value engineering team cannot reach an agreement, a presentation to management will be

scheduled At this meeting, the value engineering team will present their recommendations The Project Manager will present his evaluation of the value engineering recommendations

At the conclusion of the management presentation, a decision should be made to accept all, or a portion of, the value engineering recommendations Having this decision, the Project Manager should inform, in writing, all persons involved in the project of the recommendations accepted for the continuation of the work

15 3 8 Aviation Office

Federal law requires that notice of construction must go to the Federal Aviation Administration under the following circumstances

- 1) Any construction or alteration of more than 200 feet in height above the ground level at its site, or
- 2) Any construction or alteration of greater height than an imaginary surface extending outward and upward at 100 to 1 for a horizontal distance of 20,000 feet from the nearest point of the nearest runway of any public or military airport

For assistance, contact

F D O T Aviation Office  
605 Suwannee Street, M S 46  
Tallahassee, FL 32399-0450  
(904) 488-8444 SC 278-8444

## Chapter 16

### QUALITY CONTROL

#### 16.1 General

The design and preparation of plans for all projects shall include the necessary assurances for accuracy, proper engineering criteria application, completion, and quality. This is the responsibility of the designer, and shall be accomplished by adhering to a Quality Control Plan. A Quality Control Plan is a comprehensive, well defined, written set of procedures and activities aimed at developing designs that meet or exceed Department criteria, and producing plans in accordance with this manual. The plan will identify the organization or individuals responsible for quality control and the specific procedures used to insure the control of quality. The plan will also detail the method of accountability and documentation.

Each District will adopt its own Quality Control Plan. Consultant firms working for the Department will also have a QC Plan in place. The Project Manager/Coordinator is responsible for ensuring that the appropriate District or Consultant Quality Control Plan is adhered to.



### 16.3 3R Projects Checklist

3R (Restoration, Rehabilitation and Resurfacing) projects have different requirements than design projects, hence the checklist for phase review of 3R projects is different. For a complete discussion of 3R project requirements, please refer to the current 3R manual.

### 16.4 Field Reviews

As mentioned in Chapter 15 of this volume, all projects will have at least two field reviews. For major projects, a minimum of three field reviews, including the pre-design field review, are desirable. An additional update field review shall be required for all projects delayed and shelved for more than nine months since the final 100% review.

## Chapter 17

### QUALITY ASSURANCE

#### 17.1 General

Quality Assurance is the planned, coordinated and continuing activities performed to compare process, work products and services with written predetermined critical requirements. The objective of all Quality Assurance activities is the continual improvement of the total delivery process to ensure quality, productivity and user satisfaction.

The offices under the State Transportation Engineer have developed a Quality Assurance monitoring plans. The Roadway Design monitoring plan is designed to compare work product processes with the predetermined critical requirements necessary to ensure quality designs and control.

Critical areas to be monitored are based on well established roadway design policy and practice. These policies, guidelines and accepted practices formulate the criteria used to measure compliance in the areas critical to quality. The plan designates methods to be used to monitor design functions on a two year frequency or as necessary. Latitude is granted to the reviewer for the depth and frequency of reviews, based on the individual district's observed performance, review findings or the needs of the unit being reviewed.

Results of the monitoring activities are reported to management in exit interviews and reports to point out areas that need improvement, to obtain feedback on the effectiveness and appropriateness of established policies, procedures and standards and to recognize outstanding areas of quality success. The reports are

| also used to share improvement ideas between districts, to maintain consistency  
| in process and practice and to transfer technology

|  
| While the Q A plan covers only the main functional areas of roadway design, the  
| designers and reviewers must recognize that quality is the result of doing many  
| individual activities and details correctly All activities must conform with the  
| valid requirements no matter how large or small their overall contribution Good  
| drafting techniques, attention to details, making the plans legible and  
| reproducible are just as essential to quality as good engineering practice

**17.2**            **Authority**

The Florida Statutes (20 23(3)) specifically states that the Central Office shall |  
establish departmental policies, rules, procedures and standards and shall monitor |  
the implementation in order to ensure uniform compliance and quality |  
performance by the districts and central office units that implement transportation |  
programs |

17.3

Areas of Responsibility

- I A) Central Office Role--Quality Assurance Provide all the planned and systematic actions necessary to provide adequate direction to the districts so that all resulting design products can meet predetermined requirements This involves the establishment of design policies, procedures, standards and guidelines, training, and the monitoring and review of district compliance with these items
  
- B) District Role--Quality Control Following established design policies, procedures, standards and guidelines in the preparation of all design products, and the checking and review of individual designs for compliance and good engineering practice
  
- C) Area Design Engineer (ADE) Manage the Quality Assurance plan, document findings and maintain continuity with the department on design policy, procedures, standards and guidelines

## 17.4 Critical Areas to be Monitored

The current Roadway Design monitoring plan for Quality Assurance lists the following critical areas to be monitored

- 1 Geometric Design - Design functions include typical sections, horizontal and vertical alignment, decision and conflict points and pedestrian and other non-motor vehicle elements.
- 2 Traffic Design - Design functions include traffic signals, signing and pavement markings and highway lighting
- 3 Drainage Design - Design functions include stormwater management, conveyance, permitting, erosion and scour
- 4 Estimates and Specifications - Design functions include pay item list, documentation of quantity take-off, summary of quantities and preparation of special provisions to cover items of work, measurement and payment
- 5 Contract Plans - Design functions include plans assembly, proper signing and sealing and proper handling of revisions. This area is also monitored for results such as completeness, reproductivity, legibility, biddability and constructability
- 6 CADD Design - Design functions include file naming convention, working units, cell library, symbolism, proper software and geometry programs

| 7 Certification Acceptance - Critical requirements of the certification  
| acceptance agreements cover all areas of engineering design functions  
| Functions and responsibilities are covered in detail in the procedures  
|

| 8 Utilities - Critical functions include advance coordination, detailed  
| adjustment documentation and quality standards and criteria for clearing  
| utilities prior to construction  
|

| 9 Special Facilities - Critical functions include architectural design services,  
| asbestos management and fixed capital outlay management  
|

| The foregoing critical areas and design functions can be revised from time to time  
| with input and feedback from the districts. Compliance with the criteria and  
| critical requirements defined in the procedures and standards referenced is  
| essential to ensure quality, productivity and user satisfaction in the roadway  
| design delivery process

17.5

Documentation

- A. Documentation The Quality Assurance process will be documented in a quarterly report that will be distributed to the District Secretaries and other affected offices. A brief summary of the data will also be entered in the Quality Assurance Reporting (QAR) data base.
- B. Area Design Engineer (ADE) An ADE is assigned to each district and will be responsible for conducting and/or coordinating all roadway design QA activities with that district.
- C. Review A review will be conducted in each design function and its associated components a minimum of once every two years. This review will be for assurance that the districts have adequate control measures in place and are complying with policy, procedures, standards, guidelines and processes and for identification of any areas of excellence, noncompliance and need.



## 17.6 Consultant's Role

The consultant's role is much the same as the districts' (Quality Control) since their primary responsibility is the preparation of contract plans as agents for the districts. Consultants must ensure quality and adherence to policies just as must any office with the Department. The consultant firms are held responsible for the quality, accuracy and completeness of the work supplied to the Department.

**17.7            Training**

Training and assistance are also a mandated role of the Central Office units and the Quality Assurance program

A   Development Roadway Design will formulate a training plan based upon the districts' requests and needs as determined by the Q A reviews

B   Delivery Training courses will be conducted for district personnel as requested, with schedules and locations sensitive to budgets and production schedules

## Chapter 18

### PLANS, SPECIFICATIONS AND ESTIMATES

#### 18.1 General

Project cost estimating and the establishment of contract time are important phases of the design project and occur after the roadway design plans are complete. This chapter briefly describes these requirements for the completion of the Bid Package.

#### 18.2 Pay Items

A pay item has been established for each item of work used in highway construction. A method of measurement and basis of payment has been established for each of the pay items. The Basis of Estimate Manual contains the item number, description and unit of measurement for each construction element. The establishment of new pay items is covered in Section 18.11 of this chapter.

Pay items are identified during Phase II and quantities added during Phase III. At the completion of Phase IV, all pay items are finalized and the final Summary of Pay Items is obtained. Volume II of this manual contains information on the requirement of Phase Review submittals.

All projects (including resurfacing, widening, traffic operations, safety, etc.) shall utilize the individual pay items as listed in the Master Pay Item List.

### **18.3 CES**

The purpose of the Contract Estimating System (CES) is to compile and produce an accurate contract cost estimate in the same manner as that of a contractor preparing his bid. For detailed procedures on the use of the CES program, please refer to "Contract Estimating System, District Manual "

### **18.4 Computation Book**

The computation book contains all computations and tabulations required to substantiate the quantities required for each pay item used on the project. The computation book supports the pay item quantities and is required to be submitted with Phase III and Phase IV review. The original Comp book, including the Structures Comp book, shall be sent to Tallahassee as part of the transmittal package. After the project is let, the Comp book will be sent to the District Construction Office with the original plans.

All computations should be done on standard computation forms as described in the Department's Basis of Estimates Manual. The Computation Manual presents the standard method of calculating design quantities for construction pay items. All nonstandard methods used in computing quantities should be clearly and completely documented in the comp book by showing calculations and the basis of estimates used. Items calculated using the standard basis of estimate may sometimes require clarification if several intermediate computations are necessary to arrive at the total quantity. These computations should also be documented in the comp book.

### **18.5 Plan Quantity Payment Concept**

The Department's current practice is to provide for final payment under the plan quantity concept for a large number of commonly used items. Items under this concept require that the

estimated quantities be calculated and documented as accurately as possible. Asphalt and base items for resurfacing, widening and intersection improvement projects may be evaluated for payment under final measurement on a project by project basis. Projects for which the Districts desire to have these items paid under final measurement shall include in the plans transmittal package to Tallahassee, a letter to the Engineer of Specifications, listing the specific items desired to be paid by final measurement. The items for which payment may be allowed under final measurement are the pavement and base square yard items. Tonnage items are not included in the plan quantity concept.

Allowing final measurement on these items does not release the designer from calculating the quantities as accurately as possible. Field reviews and design surveys are still required, when necessary, to define or establish scope and/or essential topography. Planimetry of areas from plans for resurfacing and widening is allowed, as long as the scale is such that the area can be calculated as accurately as possible.

#### **18.6 Partial Federal Funding**

For projects that have partial federal funds, adequate distinction should be clearly made between participating (included in federal aid) and nonparticipating (not included in federal-aid) items. All nonparticipating items or partial quantities should be identified on the plans, on the Summary of Quantities sheet and in the Computation Book, as has been done in the past. The method of presenting this information must be of sufficient detail for project personnel to readily distinguish between participating and nonparticipating work, including its physical location in the project. Project personnel must be able to properly account for the necessary separation of quantities. These separated quantities should be properly identified as to participating and nonparticipating work when entered into CES. In a few cases certain lump sum items such as mobilization, maintenance of traffic, etc. may be at least partially Federal Aid nonparticipating depending upon the nature of other nonparticipating items which must be separated. Where it is determined that certain lump sum items should be partially nonparticipating, the percentage assignment of

nonparticipating should be negotiated with the FHWA. Upon mutual agreement, the summary of quantities should so note the appropriate percentage by footnote to the summary, and describe the area of the project to which this note applies. This percentage should also be reflected when entering data into CES. Where joint project agreements are involved between the Department and the City or County, appropriate participation information regarding this particular phase of the work should be so noted. These items should be determined during early stages of project development. Appropriate final adjustments should be included in the plans package and CES entries appropriately modified, if such items arise during the PS & E phase.

### **18.7 Utility Contract Plans**

Utility contract plans which have a 6000 job number, and are let in the contract as roadway work, need to have special attention given to the establishment of pay items and loading CES. All items of work related to the utility work shall be included in the CES under 6000 project numbers. Lump sum items such as Mobilization and Maintenance of traffic should be loaded for both the roadway work (3000 series project number) and utility work (6000 series project number). Traffic Control Plan (TCP) items that are paid by per each or per each per day (barricades, signs, etc.) are to be included under the 6000 project when the work is clearly done separately from the roadway construction work. If the utility work is done concurrently with the roadway work, individual TCP items are not required under the 6000. However, the TCP Lump Sum item must be included in all cases under both the 3000 and 6000 projects when TCP work is anticipated.

### **18.8 Contract Time**

After the Phase III completion of the design project including the completion of the cost estimate, the plans package is submitted to the district construction office scheduling engineer for establishing the contract duration. Contract duration is the time required for the complete

construction of the contract. A copy of the contract time is submitted to the Central Office in Tallahassee with the Plans Transmittal Package. Certain large complex projects should have the desired contract duration established earlier in the design process.

Once the contract time has been established for federal-aid projects, trainee manhours should be computed. The Basis of Estimates Manual has instructions for computing the number of trainees and the number of manhours required. Contract time is also used in calculating quantities for maintenance of traffic items.

### **18.9 Plan Notes**

Plan notes are intended to be used to clarify design detail, construction practices or method for payment. In general, plan notes should be kept to a minimum. Only those notes which are job specific should be used. The standard notes provided in other sections of this manual are considered job specific type notes. Only those that apply should be included in the plans. As the design process changes, these standard notes may also change. Many of the "old" standard notes have been eliminated recently and incorporated into the specifications. Notes which restate the standard specifications or standard indexes should not be used. This will help to place proper emphasis on those notes that are job specific.

### **18.10 Shop Drawings**

For non-structural shop drawings, the Engineer of Record that will be responsible for the review must be listed on the key sheet of the specific plans, along with his/her mailing address

#### **Example**

Engineer of Record  
Lighting Shop Drawings  
John Doe, P E  
111 S Avery Street  
Tallahassee, Florida 32301

### **18.11 New Pay Items**

New construction material and new uses of existing construction materials require new pay item definitions. The Department has established the following procedure to establish new pay items:

The originator of a new pay item should submit a draft of the pay items specification, any manufacturer's brochures, estimated material and labor cost, a completed Pay Item Request form (Exhibit I-18-A, Form 600-000-02, available through the CICS Forms Menu) and any other relevant data to the pay item coordinator in the central roadway design office. This package will be thoroughly reviewed. Any inquiries arising during the review will be addressed to the originator through the Central office design coordinator. Upon successful completion of review, the package will be forwarded to the specifications office for further review, approval and pay item number assignment, after which it is transmitted to the estimates office for review, approval and entry into the data base system. After the pay item number is entered into the estimates office's database system, the design coordinator will be notified of the approval and copies of the new pay item will be distributed.



FLORIDA DEPARTMENT OF TRANSPORTATION  
**PAY ITEM REQUEST**

FORM 600-000-02  
ESTIMATES - 07/93  
Page 1 of 2

JOB NO [ ][ ][ ][ ][ ][ ][ ] - [ ][ ][ ][ ][ ][ ][ ] PAY ITEM NO [ ][ ][ ][ ][ ][ ][ ] - [ ][ ][ ][ ][ ][ ][ ] UNIT OF MEASURE [ ][ ][ ]

FULL ITEM NAME \_\_\_\_\_

DETAIL PAY ITEM INFORMATION (ATTACH ADDITIONAL SHEET IF NECESSARY)

SPEC YR [ ][ ] COST DATA \_\_\_\_\_

ORIGINATOR \_\_\_\_\_ DISTRICT \_\_\_\_\_ DATE \_\_\_\_/\_\_\_\_/\_\_\_\_ PHONE \_\_\_\_\_

DESIGN COORDINATOR \_\_\_\_\_  APPROVED  DISAPPROVED\*

COORDINATOR \_\_\_\_\_ DESIGN GROUP [ ][ ] DATE \_\_\_\_/\_\_\_\_/\_\_\_\_ PHONE \_\_\_\_\_

SIGNATURE \_\_\_\_\_ DATE \_\_\_\_/\_\_\_\_/\_\_\_\_ PHONE \_\_\_\_\_

SPECIFICATIONS OFFICE  APPROVED  DISAPPROVED\*

SPECIFICATION BOOK  SPECIAL PROVISIONS  SUPPLEMENTAL SPECIFICATIONS

DEVELOPMENT  ATTACHMENT  TECHNICAL SPECIAL PROVISIONS

SIGNATURE \_\_\_\_\_ DATE \_\_\_\_/\_\_\_\_/\_\_\_\_ PHONE \_\_\_\_\_

ESTIMATES (ENGINEERING SUPPORT)  APPROVED  DISAPPROVED\*

SIGNATURE \_\_\_\_\_ DATE \_\_\_\_/\_\_\_\_/\_\_\_\_ PHONE \_\_\_\_\_

\*DISAPPROVAL REASON \_\_\_\_\_

NOTE ORIGINAL TO BE PROCESSED THROUGH ESTIMATES  
COPY TO BE RETAINED BY COORDINATOR AND SPECIFICATIONS

**JOB NUMBER**

USE STATE PROJECT NUMBER FOR WHICH THE NEW ITEM NUMBER WILL FIRST BE USED

**PAY ITEM NUMBER**

THIS NUMBER WILL BE ASSIGNED BY THE STATE SPECIFICATIONS ENGINEER IN THE CENTRAL OFFICE

**UNIT OF MEASURE**

A MAXIMUM OF TWO SPACES USED TO ABBREVIATE THE METHOD OF MEASURE FOR THIS ITEM (SEE STANDARD INDEXES FOR STANDARD ABBREVIATIONS)

**FULL ITEM NAME**

DESCRIBE THE NEW PAY ITEM SO THAT THIS "NAME" BEST RELATES TO FUTURE USERS WHAT THIS ITEM IS USED FOR

**DETAILED PAY ITEM INFORMATION**

PROVIDE DRAFT SPECIFICATIONS WHICH FULLY DESCRIBE THE NEW PAY ITEM FORMATTED TO THE CURRENT SPECIFICATION BOOK THE SPECIFICATIONS OFFICE WILL PUT THE DRAFT INTO FINAL FORM BUT THEY MUST HAVE THE USER'S IDEAS ON THE DESCRIPTION, METHOD OF MEASUREMENT, HOW THIS ITEM WILL BE USED AND SUGGESTED METHOD OF PAYMENT

**COST DATA**

PROVIDE A BREAKDOWN OF THE COST PER UNIT OF MEASUREMENT WITH NUMBER OF SKILLS REQUIRED AND EQUIPMENT SHOULD SUPPLIER OR MANUFACTURER BE KNOWN, PLEASE INCLUDE NAME & PHONE

**ORIGINATOR SIGNATURE**

WHEN THE ORIGINATOR HAS PREPARED THE DRAFT SPECIFICATIONS, COST DATA AND ANY OTHER AVAILABLE DATA HE/SHE WILL SIGN THIS FORM SIGNIFYING HIS/HER APPROVAL OF THE ATTACHED MATERIAL

**DISTRICT**

ORIGINATOR'S DISTRICT NUMBER

DATE AND PHONE NUMBER SEE NOTE BELOW

---

**DESIGN COORDINATOR**

THE CENTRAL OFFICE DESIGN COORDINATOR WILL RECEIVE THE PAY ITEM PACKAGE, REVIEW FOR COMPLETENESS, EVALUATE THE REQUEST FOR STATEWIDE UNIFORMITY AND AFTER FINAL APPROVAL DISTRIBUTE PAY ITEM PACKAGE TO DISTRICT DESIGN ENGINEERS, ORIGINATOR AND DISTRICT ESTIMATOR FOR THEIR FUTURE REFERENCE

**DESIGN GROUP**

THE NUMERIC CODE THAT REFERS TO THE DESIGN SECTION APPROVING THE USE OF ABOVE PAY ITEM [EXAMPLE STRUCTURES (10), ROADWAY (20), SIGNING (30), LIGHTING (40), SIGNALIZATION (50), LANDSCAPING//PERIPHERALS (60), UTILITIES (70), ARCHITECTURE (80)]  
DATE AND PHONE NUMBER SEE NOTE BELOW

**DESIGN COORDINATOR SIGNATURE**

WHEN THE DESIGN COORDINATOR HAS REVIEWED/EVALUATED THE REQUEST HE/SHE WILL SIGN THIS FORM SIGNIFYING HIS/HER APPROVAL OF THE ATTACHED MATERIAL

---

**SPECIFICATIONS**

SPECIFICATIONS OFFICE WILL REVIEW AND EVALUATE REQUEST AND DESIGNATE SECTION LOCATION SECTION LOCATION IS INDICATED BY THE 2<sup>ND</sup>, 3<sup>RD</sup> & 4<sup>TH</sup> DIGIT IN THE FIRST GROUP OF THE PAY ITEM NUMBER

**TYPE OF SPECIFICATION**

THIS OFFICE WILL ALSO DESIGNATE SPECIFIC LOCATION OF THE REQUEST IN SPECIFICATIONS PACKAGE (SPECIAL PROVISIONS, SUPPLEMENTAL SPECIFICATIONS ETC )

**SIGNATURE**

SIGNATURE OF THE AUTHORIZED PERSON IN SPECIFICATIONS OFFICE

DATE AND PHONE NUMBER SEE NOTE BELOW

---

**ENGINEERING SUPPORT**

**SIGNATURE**

SIGNATURE OF AUTHORIZED PERSON FOR ESTIMATES ENGINEERING SUPPORT OFFICE

DATE AND PHONE NUMBER SEE NOTE BELOW

---

**NOTE**

DATE IS THE MONTH, DAY AND YEAR REQUEST IS LEAVING THAT OFFICE PHONE NUMBER - THE PHONE NUMBER OF THE AUTHORIZED PERSON TO CONTACT IF ADDITIONAL INFORMATION SHOULD BE REQUIRED

## Chapter 19

### SIGNING AND SEALING DESIGN DRAWINGS

#### 19 1 General

The Florida State Board of Professional Engineers has reviewed this Chapter and is in concurrence with its requirements. To assure continued concurrence, the Board will have the opportunity to review future changes.

Section 334.175 of the Florida Statutes, requires that all design drawings prepared by or for the Department be signed, sealed and dated by the professional engineer in responsible charge of the project work, in accordance with Chapter 471, Rules 21H-19, 21H-23 and 21H-26. Such professional engineer must be duly registered in this state. Responsible charge means direct control and personal supervision of engineering work done by oneself or by others over whom the engineer exercises supervisory authority.

This chapter will outline the proper procedures of signing and sealing the Department's drawings and engineering documents. It shall be the District's responsibility to ensure that all record sets and documents are properly signed, sealed and dated and are retrievable on reasonable notice.

## 19 2 Signing and Sealing of Plans

### 19 2 1 Original Plans

- | No signatures or seals are to be placed on the original sheets of a plan set
- | Filling out the title block with initials and dates is optional. If the "Approved
- | by" box is used, the name shall be printed.

The key sheet for each component set (i.e., roadway, signing, etc.) shall have the responsible professional engineer's name (printed or lettered). The professional engineer's registration number shall be placed under the completion date. The following format shall be used:

Roadway Plans Approved By \_\_\_\_\_  
Date \_\_\_\_\_  
P E No \_\_\_\_\_

For the other components, "Roadway" should be substituted with the title of the component set, such as "Signing and Marking".

### 19 2 2 Record Set

- | The Record Set shall be a xerographic copy. For CADD developed plans, 11"
- | X 17" ("B" size) plotted to scale, i.e. 1" = 40', may be used. All plans with
- | hand drawn sheets shall be 24" X 35" or 36" ("D" size), plotted to scale, i.e. 1"
- | = 20'. Each sheet of the Record Set must be signed and sealed by the
- | responsible professional engineer in charge. The date shall be placed
- | immediately under the signature and the embossed seal placed over the
- | signature and date. For convenience of storage, it is recommended that the
- | location of this seal be varied across the bottom area of the sheet.

### 19.3 Signing and Sealing Other Engineering Documents

Engineering Documents are defined as any reports, computations, or recommendations that influence or limit the design engineer's decisions in the development of design plans. Bound Engineering Documents must be signed and sealed on a signature page or cover letter by each professional engineer who is in responsible charge of any portion of the document. The date shall be placed immediately under the signature and the embossed seal placed over the signature and date. Any document, report or computations not bound shall require all sheets to be signed and sealed.

A signed and sealed record copy of the following Engineering Documents shall be placed in the District Project Records File

- Specifications & Special Provisions
- Pavement Design Package
- Typical Section Package
- Drainage Computations
- Hydraulics Reports
- Traffic Engineering Reports and Recommendations
- Environmental Reports and Recommendations
- Soil Survey Reports and Geotechnical Analysis
- Value Engineering Record
- Roadway and Traffic Design Standards
- All other Engineering Reports
- *Permit documentation*

#### 19.4 Supplemental Specifications and Special Provisions

When more than one engineering discipline (Civil, Electrical, etc.), is involved, more than one signature may be required on the specifications. This can be accommodated on an index sheet indicating the pages of specifications which were the responsibility of each engineer in his discipline. This does not mean, for example, that a civil engineer who has expertise in traffic signals or highway lighting, cannot seal the signal plans or specifications, as it is entirely possible that a civil engineer could have that expertise. If, however, a professional electrical engineer was used, he must sign and seal the portions for which he was responsible.

19.5 Information Requiring Certification

Engineering decisions are often made on the basis of support data furnished by non-engineering staff or offices. These data are to be certified as being obtained in accordance with official Department procedures. The following data are to have the noted certification attached when submitted for use in engineering related work.

19 5 1 18 KIP Equivalent Single Axle Loads

"I have reviewed the Traffic Forecasting Procedure, adopted by the Florida Department of Transportation, and have arrived at the projected 18 Kip loading volumes. I have found these to be consistent with the historical traffic data and other available information."

---

Name

---

Signature

---

Title

---

Organizational Unit

---

Date

19 5.2 Project Traffic (Traffic to be used for Design)

"I have reviewed the Traffic Forecasting Procedure, adopted by the Florida Department of Transportation, and arrived at the project traffic volumes I have found these to be consistent with the historical traffic data and other available information "

---

Name

---

Signature

---

Title

---

Organizational Unit

---

Date



## Chapter 20

### PLANS PROCESSING AND REVISIONS

#### 20.1 General

The central office plans processing activities required to get funds authorized, advertisements prepared and to receive bids on construction contracts are on a critical schedule. Many of the activities in the process are concurrent and there may be any number of project plans going through the process at the same time. The time-frame for processing plans through all Central Office activities is approximately two (2) months. The advertisement period for contract bids is one (1) month. From the time the plans for a contract are received in the central office on the Plans to Tallahassee date until the letting is fourteen (14) weeks and three (3) days.

This chapter describes in general terms the critical activities required to process the contract plans, specifications and estimate (P S & E). It also identifies the various offices that have responsibilities in the process. Also, revisions to plans, specifications or other contract documents during this critical period must be performed and documented in a consistent and timely manner. The requirements and responsibilities for performing and documenting such revisions are outlined in Section 20.3 of this chapter.

## 20.2 Plans Processing Responsibilities

### 20.2.1 District Activities

Plans development is a district responsibility. The engineering and plans preparation is accomplished with in-house staff or by professional services contracts with qualified design consultant firms.

The designer or project manager shall prepare a contract file either during design or before plans transmittal to Tallahassee. The Contract File Index (EX-I-20-A) lists all documents which must be in the contract file that is transmitted with the plans package for letting.

The district is responsible for ensuring the completeness, legibility and contents of all final plans packages. The plans package transmitted to the Roadway Design Office in Tallahassee shall include

- > The Transmittal Letter (EX-I-20-D)
- > The Contract File (EX-I-20-A) with listed documents
- > The Contract Plans Set (Original, reproducible plan details, 11" x 17", if CADD)
- > The Record Set (Xerographic copy signed & sealed by Engineer of Record)
- > The Computation Book (Backup for Engineering Estimate)
- > Reproducible plate or bond copy of any aerial photo sheets

Aerial photo sheets are no longer permitted in the plans. On projects begun before the no photo sheet policy, the District shall provide reproducible plates or copies of these sheets along with the transmittal package. Plates can be made through the Topographics Office in Tallahassee.

When the plans package is received by the Plans Processing Section in Tallahassee, they are logged in. The contract file is checked to be sure that all required documents are included in the file. If the file is incomplete, the District Director of Production AND the Tallahassee Production Management Office are notified.

As the project is processed through Specifications, Estimates and Federal Aid, all documents are removed from the contract file and incorporated into the Plans, Specifications and Estimates (PS&E) package. Therefore, processing cannot be completed until all items listed on the Contract File Index are received in Tallahassee. Documents not included with the original submittal shall be sent to the Plans Processing Section, Mail Station 32. The District should keep a copy of all contract file documents in their project file for future needs.

**No plans checking is done in the Central Office.** The checklist used for processing the plans package is shown in EX-I-20-F. Some examples of incomplete packages that are caught as a result of normal processing include:

- 1      Plans components listed on the Key Sheet are not included in package
- 2      CES sheets are not numbered. If more than one project is let under one contract, all CES sheets are not in the lead job or the CES's are not properly strung
- 3      Trainee manhours are not included on Federal-Aid projects when required
- 4      Box culvert data sheets are not included, if applicable, and/or are not numbered
- 5      Number of sheets is incorrect or sheets are missing

If all components are present, two half size copies are made if they are not supplied by the District. One half size set and the contract file are taken to Specifications, the other half size copy and the Comp Book go to Preliminary Estimates, the Record Set is filed and the contract plan set is put in a temporary file.

| After the project has been let, the Plans Processing section sends the Contract plans and  
| the Computation Book(s) to the appropriate District Construction office, concluding the  
| plans processing cycle

### 20 2 3      Construction Specifications Activities

| The Specifications Office reviews the half-size plans and contract file provided by Plans  
| Processing for the purpose of assembling the specifications package for the project The  
| Specifications engineer will review the typical section and plan notes relating to specs and  
| check the summary of pay items for flagged items that require inclusion of Supplemental  
| Specifications and/or special provisions Permits, utility schedules and other necessary  
| information are pulled from the contract file Job specific and technical special provisions  
| that were prepared and signed and sealed by the designer are reviewed During this time  
| the Specifications engineer has been building a "notebook" of supplemental specs and  
| special provision paragraphs necessary to cover the work required by the plans The  
| specs package is assembled by word processors from the "notebook", proof read, signed  
| and sealed It is then sent to Legal for review before going to Reprographics for printing  
| A copy is then provided to Estimates and the Federal-Aid Office

| The remaining contents of the contract file are sent to the Federal-Aid Office on  
| Federally funded projects

### 20 2 4      Preliminary Estimates Activities

| When the one half size plan set from Plans Processing is received in Estimates the CES  
| is locked Estimates then reviews the plans from a contractor's perspective to see if there  
| is enough information to bid the job The Estimates engineer runs searches to check  
| prices, calls suppliers, etc to be sure he has the most current price information

available. He checks the District's price overrides and contacts the District as necessary to resolve differences of opinion.

The specifications are reviewed. Geographic location, maintenance of traffic, special permit conditions, etc. may weigh heavily in the overall estimate. After all issues are resolved, the job is transferred into the official estimate system. A copy of the estimate is sent to the FA office for use in the PS&E package. The Comp book is returned to Plans Processing for temporary filing before being sent to the District Construction office upon award of the project.

20 2 5        Reprographics Activities

Upon approval of the Specification package reprographics prints and assembles sufficient plan sets and specification packages for distribution and sale to interested bidders, material suppliers, etc. as requested. Distribution of plan sets and spec packages is made to the offices of design, federal-aid, specifications, estimates, minority programs, and the appropriate District and to the Gainesville Testing offices.

20 2 6        Federal-Aid Office Activities

If Federal Funds are involved, the Federal Aid Office receives a half size set of plans, the contract file, the Specification and the Estimate to prepare the PS&E package, which is submitted to FHWA for Authorization and obligation of Federal funds.

The components of the PS&E package that are submitted to FHWA vary with Federal-Aid Certification Acceptance, oversight and exempt projects.

20 2 7      Production Management Activities

The Contract Letting Coordinator, in the Production Management Office, tracks the progress of plans, etc through the various processing stages. Progress is tracked via the "Plans Processing Report", which shows the nine week critical schedule a project must meet when being processed for a particular monthly letting. Outstanding issues that must be resolved to meet the processing schedule are highlighted in this report.

The Production Management Office and the Plans Processing Section of Roadway Design verify plans packages in Tallahassee. Projects with complete plans and contract file on time and no outstanding issues are immediately accepted for processing. During the nine week schedule, any problem which impedes processing is reported to the Contract Letting Coordinator. Projects having deficiencies which are not resolved by the Authorization Date/Advertisement Date are rescheduled for a later month. The Production Management Office produces and distributes a report which shows project deficiencies and production slippage.

Approximately three weeks before scheduled advertisement, a list of prospective projects for advertisement is circulated to the Comptroller and Contracts Administration. On the scheduled date of advertisement, Production Management is advised of Authorization by the FA Office and of funding by the Comptroller and advises Contracts Administration as to which projects to advertise. Immediately upon advertisement, the Production Management Office produces and distributes a list of all projects currently and successfully advertised for the next letting.

20 2 8      Contracts Administration Office Activities

Upon receipt of Production Management's list of prospective projects, the Contracts Administration Office begins preparing the project advertisement and Contract Proposal.

Once projects over \$250,000 are authorized, a "Notice to Contractors" is sent to all pre-qualified bidders. For projects under \$250,000 legal advertisements are sent to local newspapers once authorization occurs.

Orders for bid package including plans, specifications and contract proposal are received by the Contracts Administration Office. On the scheduled day of letting, bids are received, opened, recorded and read aloud.

### 20.3 Revisions to Contract Documents

Revisions are occasionally necessary to change plans or other documents. Any changes to the plans or specifications, between the time the submittal package is received in Tallahassee and the letting date is considered a revision.

Making revisions to the plans and Technical Specifications is the responsibility of the District, however, Central Office staff are available to assist with minor revisions. **All revisions shall be processed through the Plans Processing Section, Mail Station 32, in the State Roadway Design Office.** For major revisions the Plans Processing Section will coordinate the change or send plans back to the District and/or provide space in Tallahassee for the District to come and make the changes.

The engineer making the revisions to plans, specifications or other documents that affect the engineer's estimate, pay items or quantities will be responsible for up-dating the Computation Book, Pay Item Listing and Contract Estimating System (CES).

#### 20.3.1 Changes - Plans in District

Changes to plans that have been signed and sealed but have not been submitted to Tallahassee no longer require a revision letter. However, these changes are to be noted in the sheet's revision block. A copy should then be made, signed and sealed, and placed in the record set along with the original signed and sealed sheet.

#### 20.3.2 Revision Process - Plans in Central Office

When changes to the plans or other contract documents are necessary after they have been submitted to Tallahassee, a revision letter is required. The revision process is as follows:



- 1 Unless revisions are being made in Tallahassee, plans must be requested to be returned to the District for both in-house and consultant plans. When consultant-prepared plans are returned for revision, the District will be responsible for sending plans to the Consultant.
- 2 If the project involves federal funds and is not exempt from FHWA oversight under CA or the ISTEA (1991) exemptions, concurrence must be obtained by the District Office from the responsible FHWA Engineer prior to making major revisions.
- 3 The District Designing Engineer or Project Manager/ Designer will generally be the contact person for revisions on in-house or consultant plans respectively.
- 4 A revision letter is required (see Exhibit I-20-E) and the date shown shall match the date on the revised sheet and the revision listing on the lead key sheet. This is the official revision date. For revision involving CES changes the date should be the day you fax the revision letter to Tallahassee to unlock the CES. On revisions not involving pay items or quantity changes the date should be the approximate date you anticipate mailing the revision to Tallahassee.
- 5 Whenever a revision involves pay items and/or quantities, the CES will be unlocked for 24 hours once the revision letter is received. All quantities, pay items, computation books, etc., shall be updated as part of the revision. To open the CES, fax the completed revision letter to Plans Processing at SC number 292-9293.
- 6 The lead key sheet shall have all the revisions noted in the revision listing in the lower left hand corner of the sheet. (Revisions to the Key Sheet are noted on the right side of the sheet in the revision block.)

- 7 When the project contains other components such as signing and pavement markings or signalization plans, the revisions shall be made on the plan sheets, and all the revisions, along with the other component revisions, noted on the lead key sheet only
- 8 The responsible professional engineer making the revision shall complete the revision block on all revised sheets and sign and seal record prints, as noted in Chapter 19 Where no revision block exists (CES sheets, pay item sheets etc ), the revision date shall be noted on the sheet ( along the top of computer generated pay item sheets )
- 9 Before submitting a revision, the Project Manager/Designer should check with Specifications and Estimates to see if there are any other questions which need to be addressed
- 10 The revision package submitted to Tallahassee shall include the following
  - Revised contract plans sheets including the Key Sheet
  - Revised CES (if applicable)
  - Revised computation booklet sheets (if applicable)
  - Signed and sealed xerographic bond copies of all revised sheets including the CES
  - Two 11" x 17" copies of the revised sheets
  - Revised signed and sealed Specifications (if applicable)
  - Revision letter.
- 11 If time remaining until letting date is fifteen working days or less by the time the revision will reach the Central Office, processing of the revision must be approved by the State Roadway Design Engineer or his designee.

- 12 No revisions are allowed within five working days of letting. After this date, the project must be let as is or withdrawn from the letting, unless otherwise approved by the State Highway Engineer and the District Secretary. Withdrawal of the plans package after advertisement requires the approval of the State Highway Engineer and the District Secretary.

Specifications When Specifications or Technical Special Provisions have been submitted as part of the plans package and revisions are necessary, a revision letter is now required.

All revisions, including those that deal with Specifications only, shall be sent to the Plans Processing Section, Mail Station 32.

### 20 3 3 Complete Project Revisions

If an entire project is requested to be returned to the District for revisions before the letting, the following steps will be required for resubmittal.

- 1 The plans and computation books shall be resubmitted with a new contract file containing those items which need to be updated.
- 2 The lead Key Sheet shall be noted "Plans Completely Revised" in the lower left corner and dated. This note implies that a project has been pulled from letting, rejected, or that a sufficient number of sheets have been revised to warrant a total reprinting. The revision block on each sheet that is revised shall be completed by the revisor and dated.
- 3 The revision letter should state that the project has been completely revised.

- 4 A copy of each plans sheet that is revised shall be signed and sealed in accordance with Chapter 19. The signed and sealed sheets will be included with the Record Set in the Central Office.

20 3 4 Automated Plans (CADD) Revisions

- i If the plans are automated, the revisions must be made by the District or Consultant in the CADD design files so that the automated files will be compatible with the printed contract plans and Record Set.

Project # \_\_\_\_\_ **CONTRACT FILE INDEX**

WPI # \_\_\_\_\_

Number  
Reqd                      Included  
                                 in File

Special Provisions/Supplemental Spec prepared by District \_\_\_\_\_

District Prepared Specification Package \_\_\_\_\_

**CONTRACT TIME RECOMMENDATION**

    Calendar Days Recommendation \_\_\_\_\_

    Special Acquisition Period \_\_\_\_\_

    Incentive/Disincentive Justification Report \_\_\_\_\_

    Incentive/Disincentive SP Recommendations \_\_\_\_\_

    Special Work Conditions/Times, etc (Including night work) \_\_\_\_\_

Preliminary Engineering Certification \_\_\_\_\_

Utility Adjustment Schedules \_\_\_\_\_

Utility Certification \_\_\_\_\_

Railroad Adjustment Schedules/wage rates, etc \_\_\_\_\_

Environmental Re-evaluation (EX-I-20-B, Page 1 of 2) \_\_\_\_\_

Original Permit(s) & Copy of Env Permits Transmittal Letter \_\_\_\_\_

NPDES / SWPPP \_\_\_\_\_

Maintenance Agreement where appropriate \_\_\_\_\_

Joint Project Agreements (J P A ) \_\_\_\_\_

    Reimbursable \_\_\_\_\_

    Non-reimbursable \_\_\_\_\_

Pavement Composition Reports (Milling Projects > 500 TONS) \_\_\_\_\_

FA Project Certification to Standards \_\_\_\_\_

Form - 37 (on-line form for Form FHWA-37) has been electronically transmitted                      Yes\_\_ No\_\_

This project was developed under Certification Acceptance procedure                      Yes\_\_ No\_\_

Project exempt from FHWA oversight per request under ISTEA, 1991                      Yes\_\_ No\_\_

If CA, there are special features that require FHWA review and concurrence (Vol I, Ch 24)                      Yes\_\_ No\_\_

R/W Certification has been forwarded to Tallahassee R/W Office                      Yes\_\_ No\_\_

Name \_\_\_\_\_ Sig \_\_\_\_\_  
Project Manager/Designer

**Note All Contract File Documents are due on Plans to Tallahassee date.**

REMINDER

CONTRACT FILE

Put in order of file list

Show number of schedules, permits, agreements etc

Show anticipated date of arrival on any item not included in file

R/W Certification is required on all projects

R/W Certifications shall be forwarded directly to the Tallahassee R/W Office

Attn State Administrator, R/W Work Program & Production Reporting, Mail Sta 22

Send late documents to Plans Processing (M S 32)

## ENVIRONMENTAL RE-EVALUATION

### ENVIRONMENTAL DOCUMENT

1 The project is a Categorical Exclusion under (check one)

23 CFR 771 117(c) (Type 1) or

"Programmatic" list approved by FHWA on 2/25/88 & amended 8/10/89

which was reevaluated in accordance with 23 CFR 771 129 on \_\_\_\_\_,

and the determination remains valid

2 The environmental document for this project was a (check one)

Categorical Exclusion under 23 CFR 771 117(d) (Type 2) approved on \_\_\_\_\_,

FONSI under 23 CFR 771 121 approved on \_\_\_\_\_,

Final Negative Declaration approved on \_\_\_\_\_), or

Final Environmental Impact Statement under 23 CFR 771 125 approved on \_\_\_\_\_

A reevaluation in accordance with 23 CFR 771 129 was approved on \_\_\_\_\_

Name \_\_\_\_\_

Sig \_\_\_\_\_  
Project Manager/Designer

EX-I-20-B

I-20-15 0

Revised 12/08/93

W.P.I. NO: \_\_\_\_\_

STATE PROJECT NO. \_\_\_\_\_

F.A. PROJECT NO. \_\_\_\_\_

County \_\_\_\_\_ S.R. No. \_\_\_\_\_

\_\_\_\_\_ The District Director of Production certifies that all work will meet or exceed the standards approved by the Secretary of The U.S. Department of Transportation under 23 U.S.C.109(c).

I do, hereby, certify to the above statement:

\_\_\_\_\_  
District Director of Production

\_\_\_\_\_  
Date

\_\_\_\_\_ The District Director of Production certifies that all work will meet or exceed, except as noted below, the standards approved by the Secretary of The U.S. Department of Transportation under 23 U.S.C.109(c).

I do, hereby, certify to the above statement and listed below are the exceptions/variances to the standards:

\_\_\_\_\_  
District Director of Production

\_\_\_\_\_  
Date

LIST OF EXCEPTIONS/VARIANCES	DATE OF APPROVAL
------------------------------	------------------

EX I-20-C



DATE

TO Director, Office of Design  
Attn State Roadway Design Engineer

FROM District Director of Production

COPIES TO

SUBJECT TRANSMITTAL OF PLANS - Scheduled Letting Date      Mo, '      Yr

WPI NO \_\_\_\_\_ (GOES WITH \_\_\_\_\_)

LEAD STATE JOB NO \_\_\_\_\_

P E Job Number \_\_\_\_\_

\* F A NO \_\_\_\_\_

DESCRIPTION \_\_\_\_\_

WORK TYPE/MIX \_\_\_\_\_

Other work to be performed by Contractor via J P A

Job # \_\_\_\_\_ Description \_\_\_\_\_

Information contained herein has been checked and verified as needed. A plans package, suitable for processing, which consists of the following is forwarded under separate cover

- Contract Plans
- Record plans set
- Contract File
- Computation Book

The affixed signatures below indicate and attest that

- 1 The plans package is complete, free of known errors and has been reviewed for constructibility and bidability and is ready for processing to an advertisement status
- 2 The contract file is complete as noted on the Contract File Index, is accurate and contains all documentation required for the PS&E package
- 3 The Record plans set represents a true copy of the contract plans set as produced by the Engineer of Record
- 4 WPA and CES project descriptive information is correct for advertisement purposes
- 5 Where appropriate, I certify that the project was designed in compliance with the Certification Acceptance Agreement dated July 30, 1990 or with the request for exemption under ISTEPA, 1991

Name \_\_\_\_\_ Sig \_\_\_\_\_  
Project Manager/Designer

Name \_\_\_\_\_ Sig \_\_\_\_\_  
District Director Production

\*Place a block letter "F" (1" X 1") in the upper right corner for (1) I Funds completion, new or reconstruction projects > \$1M or (2) NHS (Off Interstate) new or reconstruction > \$5M

EX-I-20-D, Page 1 of 2

**REMINDER**

**TRANSMITTAL PACKAGE**

**S&S Xerox copies or bond (no bluelines)**

**Punch and pin all plans (no staples)**

**All plans and plans components must be the same size**

**Check for missing sheets**

**Check reproducibility of all sheets, especially aerials**

**On strung jobs, all CES sheets go in lead job**

**Provide Reproducible plates or bond copies of any aerial photos**

**Make sure bridge CES is the CESPJ15 Option 4 which shows bridge numbers and the quantity breakdowns**

DATE \_\_\_\_\_ 1 of \_\_\_\_

TO State Roadway Design Engineer, Attn Plans Processing

APPROVAL \_\_\_\_\_, Responsible Engineer

CONCURRENCE \_\_\_\_\_, District Design Engineer

COPIES TO: Specifications Office, Contracts Office, FA Office, Estimates Office, Reprographics

SUBJECT. Revision Package

W P I No (s) \_\_\_\_\_

Letting (mo /yr) \_\_\_\_\_

State Project No (s) \_\_\_\_\_

F A Project No (s) \_\_\_\_\_

County \_\_\_\_\_ S R No \_\_\_\_\_

This is to advise you that a revision was made to the plans and/or special provisions and the sheets listed below will require reprinting and the Record Set will need to be updated The revision package includes

\_\_\_ SP(s) \_\_\_\_\_ Contract Plan Sheet(s)  
\_\_\_ Updated Comp Sheet(s) \_\_\_\_\_ Signed and Sealed Print(s)

PREPARED BY \_\_\_\_\_ REQUESTED BY \_\_\_\_\_

PROCESSED BY Central Office \_\_\_\_\_ DATE \_\_\_\_\_

AUTHORIZED BY FHWA \_\_\_\_\_ DATE \_\_\_\_\_

APPROVAL IF WITHIN 15 WORKING DAYS OF LETTING

SIG \_\_\_\_\_ DATE \_\_\_\_\_

State Roadway Design Engineer

<u>Sheets No (s)</u>	<u>Description of Revision</u>
_____	_____
_____	_____
_____	_____
_____	_____
_____	_____

EX-I-20-E

Page 1 of 3

## REMINDER

**REVISION DEFINITION-** Changes to plans or other contract documents after Plans have been submitted to Tallahassee

### PROCESS

- Notify Tallahassee of pending revisions and determine if sufficient time exists to complete and process revision
- Determine who is to do revision? Tally or D O
- Request necessary sheets to be returned (Revisions to CADD sheets shall be done in district )
- Make changes to plans sheets
- Calculate quantities, if applicable
- If quantities are involved FAX completed revision letter to S C 292-9293 to have CES unlocked
- Make changes to CES
- Submit revision to plans processing in Tallahassee, M S 32

### REVISION PACKAGE

- Letter
- Revised sheets including CES
- S&S copies of revised sheets
- Two 11x17 copies
- Revised comp book sheets
- Revised S&S specifications if applicable

### REVISION LETTER REMINDERS

- On quantity changes, letter shall show,
  - New pay item numbers with quantity
  - Deleted pay item numbers only
  - Changes to quantities shall show pay items number with old and new quantities
- FHWA approval on oversight projects is the District's responsibility
- Key Sheet is only listed on the letter and shown on the revision listing when it is actually revised, but is included in the package for all revisions to the plans
- Date on the letter must match the date on plans

### REVISED SHEET REMINDERS

- Include CES Sheets in revision listing on Key Sheet and furnish new CES and S&S CES
- Show Revision Date on all revised sheets including CES, Box Culvert Shts etc
- Revision date must match date on letter
- If adding or deleting a pay item, revise the complete CES for that Design Group because of rollover
- Change CES in System and then pass to CADD if CADD CES is used (Do not change CADD CES sheets manually)

### SIGNED AND SEALED COPIES

- Signed and sealed copies must be bond or Xerox
- On Consultant projects, S&S revised sheets may be sent to Tallahassee a few days after the rest of the revision

### COMP BOOK

- Show Project number on Revised comp book sheets

EX-I-20-E

Page 2 of 3

Revised 12/08/93

I-20-20 0



CENTRAL OFFICE  
PLANS PROCESSING PROCEDURE

W P I No \_\_\_\_\_

State Project No \_\_\_\_\_

F A Funds \_\_\_\_\_

Processed by \_\_\_\_\_ Date \_\_\_\_\_

- \_\_\_\_\_ 1 Log plans in
- \_\_\_\_\_ 2 Check Plans Transmittal Memo for signature of District Director of Production or the District Secretary
- \_\_\_\_\_ 3 Check Contract File for list of contents
- ! \_\_\_\_\_ 4 Check to make sure all component plans are included
- \_\_\_\_\_ 5 Order 3 (4 if Turnpike) half-size copies
- ! \_\_\_\_\_ 6 Check number of sheets in contract plans
- ! \_\_\_\_\_ 7 Distribute contract plan set and record set to file room
- \_\_\_\_\_ 8 Deliver contract file and one half-size plan set to Specifications Office
- ! \_\_\_\_\_ 9 Deliver one half-size plan set and comp book to Preliminary Estimates Office

EX-I-20-F

## Chapter 21

### CONSULTANT PROJECT MANAGEMENT

#### 21.1 General

The Florida DOT may elect to use a consultant to provide all or a portion of the engineering services required for a transportation project. Guidelines for use in acquiring and managing such a consultant are contained in the Florida DOT Project Management Guidelines. ~~Updated under revision~~ The revised manual is now available

## 21.2 Project Definition

Once the project is included in the Florida DOT's Adopted Five Year Work Program and a decision has been made to acquire professional services, the work to be performed by the consultant must be carefully defined and stated in Project Concept Reports and Scopes of Work.

### 21.2.1 Project Concept Report

The Project Concept Report serves the function of identifying project goals and constraints. This document would precede and be supplemental to the normal scope of services and would identify and define existing conditions, issues, concepts and criteria. It then could provide the basis for the detailed scope of consultant services.

### 21.2.2 Scope of Services

The Scope of Services document is the cornerstone of the consultant procurement process. This document specifically outlines the features of the project in sufficient detail to form the basis of the technical and price proposals to be submitted by the consultants. It also forms the basis for the Florida DOT's evaluation of these proposals and for the preparation of the Florida DOT's man-hour estimates for each work component. Subsequently, it becomes the primary component of all contract agreements. This document should itemize all aspects for which the consultant is responsible and all aspects for which the department is responsible.



### 21.3 Consultant Acquisition

Consultant acquisition is accomplished according to established rules and procedures and includes; requests for proposals, proposal evaluation, negotiation and contract execution. Each of these are further explained in the Project Management Guidelines and in the procedures of the Contractual Services Office ~~the procedures~~.

### 21.4 Technical Management

Technical Management consists of the application of proper planning, monitoring and control techniques applied throughout the life of the project. This process is used to guide the project through the many technical disciplines and their interfaces in order to ensure timely interaction and successful completion. Proper documentation of all deliverables as required by the scope of services as well as every decision reached as a result of inquiry or coordination meetings is required. For further explanation, consult the Project Management Guidelines.

### 21.5 Contract Administration

Contract administration is required to ensure that the terms of the consultant contract are met and to verify that any modifications to the contract, such as time extensions and supplemental agreements, are necessary and conform to the original agreement. Periodically, throughout the life of the contract, consultant progress will be measured and documented for the purpose of providing progress payments. Ultimately, all of the above is used as a basis to grade the consultant upon completion of the contract. Each of these areas is covered in the Project Management Guidelines and by existing Contractual Services Office's procedures.

### 21.6 Scheduling and Coordination

A major objective of project management is to determine the relationship of different tasks to each other, and to schedule and control these tasks so that the project is carried out logically and efficiently. In accomplishing this, the project manager should include status meetings as a routine part of the project schedule. The meetings should be held on a periodic basis, usually monthly. The purpose of these meetings will be to discuss the progress of the project and to make decisions for the remainder of the services. Functional area managers as well as <sup>representatives of</sup> other agencies should attend as required to share information and to develop an understanding of how their activities blend into the overall project objectives. Further discussion of these areas can be found in the Project Management Guidelines.

21 7 Consultant Use of Department Computer Programs

The Department has various computer programs which are of great value to the designer. A listing of available programs should be included in the scope of services. Consultants may request the use of appropriate programs through the FDOT Project Manager/Coordinator.

Various CADD files are also available for use by the consultant on projects for the Department. Information and authorization for use of these files may be obtained from the District CADD Coordinator.

## Chapter 22

### ARCHITECTURAL PLANS

#### 22.1 General

Designs for building construction projects are normally based on square footage requirements as established by the Florida DOT's owner/user unit and the District Fixed Capital Outlay coordinator. Square footage requirements shall be in compliance with the Department of General Services space criteria (Form BPM 4056 R2-86) and based on anticipated staffing and use. The size of rest area buildings is determined by the number of toilet fixtures required. The number of toilet fixtures and parking places required at the rest area are computed based on the 20 year design traffic of the highway. These computations are done on a Facilities Computation form (Ex-I-22-G) and become a part of the project file.

The construction of all new Florida DOT buildings and renovations or additions to existing buildings require plans and specifications signed and sealed by a Licensed Florida Architect (F.S. 481).

Consultant contracts for architectural design of buildings in the Districts shall be administered and managed in the District office. A very detailed project definition and scope of services is essential to a successful architectural design contract.

Architectural plans often include other engineering plans. Typically, this requires the acquisition of engineering subconsultant(s) to perform those services for which the architect is not qualified under F.S. 481.

The architectural services required for the design of a building are generally done in four phases as listed below:

1. Schematic Design Phase
2. Design Development Phase
3. Contract Documents Phase
  - a. Construction Plans
  - b. Specifications & Special Provisions
  - c. Construction Cost Estimate
4. Construction Phase
  - a. Shop Drawing Review
  - b. Scheduled Periodic Construction Site Visits
  - c. Review of Contractor Pay Requests
  - d. Substantial and Final Inspections

Requirements and criteria for the four phases are addressed in this chapter.

## 22.2 Codes, Rules and Regulations

### A. Codes, Rules and Regulations

1. Certification: The Design Professional shall provide with each of his formal design review submissions a listing of all codes and regulations which are applicable to the project. He shall further certify over his signature, that his design documents fully comply with those codes and regulations.

### B. Applicable Codes, Rules and Regulations

1. Building Codes: The design professional should use the following codes as applicable. Refer to Chapter 13D-17, Florida Administrative Code and Sections 553.43 and 553.73, Florida Statutes.

The Standard Building Code applies, current edition. Dade County does not use the Standard Building Code.

2. Fire and Life Safety: All requirements of the National Fire Protective Association, including the Life Safety Code (NFPA 101), current edition, shall apply.
3. Electrical and Plumbing Codes: Florida Electrical Code Part II, Chapter 533.19, Florida Statutes (National Electrical Code, current edition). NFPA 90A, 1978, air conditioning and ventilation.
4. Handicap Code: All requirements of the "Uniform Federal Accessibility Standards", and ANSI A117.1, "Standards for Making Buildings and Facilities Accessible to, and Usable by, Physically Handicapped People", current editions, shall apply.

5. State Requirements: The following agencies have been charged by law with the responsibility of protecting the public health, safety and welfare in the following areas:
- a. Fire Protection Rules and Regulations, State Fire Marshal's Office.
  - b. Rules of Florida Industrial Commission, Department of Commerce, Division of Labor, Bureau of Workman's Compensation enforce OSHA Building Standards CFR-291926.
  - c. Florida Hotel and Restaurant Division, Statutes and Rules, Department of Business Regulation.
  - d. Rules and Regulation of the Division of Health, Department of Health and Rehabilitative Services.
  - e. Rules for the Physically Disabled, Chapter 13D-1, Department of General Services.
  - f. Florida Electrical Code, Part II, Chapter 533.19, Florida Statutes, Department of General Services.
  - g. FLEET, Florida Lifecycle Energy Evaluation Technique, Chapter 255.251, Florida Statutes and Chapter 13D-10, Florida Administrative Code, Department of General Services.
  - h. Energy Efficiency Code for Building Construction, Chapter 553, Florida Statutes.

In every case where the regulations and rules of the above agencies apply, they shall be complied with in the development of the project.

### C. Approval

It is the responsibility of the Design Professional to determine which other authorities have jurisdiction and assure that the development of the project is fully coordinated with these agencies and that their requirements are accommodated in the documents so that all approvals can be readily obtained. This coordination starts with the schematic design and must be completed prior to taking of bids, so that delays in start of construction do not occur.

#### 1. Sewage

Connections or facilities for discharge of 2,000 gallons or less in 24 hours requires submission of DER-14-4 to the Florida Department of Environmental Regulation or other designated permitting agency. See DER 17-3, Water Quality Standards and DER 17-16, Waste and Domestic Wastewater Plants.

#### 2. Zoning and Comprehensive Planning

All local governments, as required by Chapters 163.315(5), 163.3165(8), 163.3194(1) and 163.3211 Florida Statutes, have or will adopt comprehensive plans and zoning. The State, as is any Owner, is obligated to develop their property in accordance with the adopted plans or codes and obtain reviews and approvals including variances as required. The Architect should begin this coordination early in the design process and carry it through to the end to ensure that the project meets all local requirements and to resolve conflicts as they arise.



3. Use and Development Permits

Certain use and development permits are required by local, State and/or federal agencies prior to commencement of construction. These permits, covering such items as sewage, water, air quality, etc., must be obtained prior to release of documents for bidding. It is the responsibility of the Architect/Engineer to identify each such permit and to apply for these on behalf of the Owner.

4. Fire Department

The Design Professional is expected to work closely with the Fire Department serving the project area, and to accommodate their fire fighting methods, equipment, hose threads, etc.

5. Flood Prone Areas

Every site plan shall be evaluated for flood hazard and meet the minimum building requirements mandated by the National Flood Insurance program. If the local permitting office can not provide the necessary information, a flood hazard evaluation may be requested from: Mr. Howard Glassman, State Assistance Office, Federal Flood Insurance Program, 256 Howard Building, 2571 Executive Center Circle East, Tallahassee, Florida 32301.

6. FLEET

Every building over 5,000 square feet in area and leased space of over 20,000 square feet is subject to the provisions of Chapter 255.251, Florida Statutes and Chapter 13D-10 Florida Administrative Code. This program is administered by the Technical Evaluation Section, Bureau of Construction, Department of General Services.

### 22.3 Standard Document Requirements

#### A. Drawing Size

All drawings shall be <sup>24" X 35" or 36"</sup> ~~24" X 36" (B size)~~. For border size and other sheet format information see paragraph 1.4 (II-1-3.0) of this manual.

#### B. Specification Size

All specifications and special provisions shall be printed in an 8 1/2" by 11" format, bound on the left hand side in a permanent type binder.

#### C. Lettering

All lettering shall be vertical uppercase and must be plain, free of adornment, and legible; minimum size shall be 1/8" when reduction is proposed. All symbols shall be clearly separated from one another and from adjacent lettering or lines.

#### D. Scales

Scales should be located directly under the title of each plan, elevation, section, detail, etc. The scale should be given as an example of the object drawings, i.e., Scale: 1/8" = 1'-0".

#### E. Title Blocks

The title block on each drawing shall appear in the lower right hand corner along the right margin. It shall contain information as delineated in Ex-I-22-A & I-22-B.

F. Title Sheet, Pages and Bindings

Title sheets, title pages, and binding of documents shall comply with the provisions of Ex-I-22-C (text) & I-22-D (layout of drawing, key sheet).

G. Signature and Seal

All final reproducible contract documents submitted by the Design Professional shall bear the appropriate professional signature. The Architect shall submit three originally signed and sealed sets of prints of the plans and specifications to serve as record sets of contract documents.

H. Drawing Arrangement

The drawing shall be arranged by subject category.

1. Key Sheet
2. Civil
3. Architectural (including site plan)
4. Structural
5. Mechanical
6. Plumbing
7. Electrical

I. Specification Organization

Specifications shall be organized in accordance with the format of the Uniform Construction Index as adopted and established by the Construction Specifications Institute (CSI) or The American Institute of Architects (AIA).

#### 22.4 Schematic Design Phase Requirements

- A. A Schematic Design Phase shall be required as a part of all architectural design services.
- B. The Schematic Design Phase shall include, as appropriate, but not be limited to:
  - 1. A narrative description of the design and construction concepts and how they are responsive to the project requirements.
  - 2. A plan showing how the project fits into the master plan for total facility development.
  - 3. Site plans showing existing and proposed roads, circulation elements, utility systems, plantings and special site features.
  - 4. Studies and reports relative to the site and its topographical, ecological, botanical and other features contributing to the solution or requiring significant alteration of the existing site.
  - 5. A description of existing zoning and other site conditioning factors restricting development and their solutions or recommendations for resolving them.
  - 6. Floor plans, elevations, building sections, and sketches as necessary to adequately present the concept.

7. If the project is an addition, or is otherwise related to existing buildings on the site, the plans shall show such facilities and their general arrangements and relationships.
8. The general description analysis, and sketches, where applicable, of the design and construction concepts shall be provided for architectural, structural, plumbing, fire protection, mechanical (HVAC), communications, electronics and electrical systems.
9. Mechanical and electrical descriptions, including computerized building management systems, shall indicate proposed systems and equipment in suitable detail, and be accompanied by a complete schematic format to enable an energy design submission of FLEET in compliance with Florida Energy Conservation in Building Act. See Volume III of the Energy Conservation Guide.
10. Specific layouts of complex areas such as mechanical rooms, computer rooms, operation areas and conference rooms.
11. Description of the features and provisions provided in the facility for use by the handicapped.
12. Details as required.
13. A statement of the provisions that will be taken to satisfy acoustic requirements.

14. Outline specifications, using CSI/AIA format.
15. An identification and presentation of code requirements. Provide a review of codes having a bearing on the project and report specific problems encountered in conforming to these codes as well as solutions, waivers or variances, if any, being pursued or required.

## 22.5 Design Development Phase

### 22.5.1 General

Upon approval of the Schematic Design Phase and receipt of the Notice to Proceed into the Design Development Phase, the Design Professional should proceed with the amplification and refinement of his advanced schematic design study to comprehensive Design Development documents.

### 22.5.2 Development Procedures

The Architect should, with the concurrence of the Florida DOT, schedule necessary conferences and meetings with the Florida DOT and other affected parties, to ensure that the project is developed in a coordinated and optimum manner.

### 22.5.3 Reviews

#### A. General

The Design Professional shall submit the Design Development documents to the Florida DOT and other agencies (those agencies having jurisdiction or approval requirements) as designated by the Florida DOT's Project Manager and with his concurrence, schedule a Design Development review conference. At that conference, the Design Development shall be presented by the Architect/Engineer and be explained in depth and detail as appropriate. The Architect shall provide minutes of this review conference to all attending parties.



The Design Professional shall confer with the Florida DOT and other persons attending this conference, responding to all questions and comments. If the comments are critical and require response prior to proceeding with the next phase of the project, it shall be the responsibility of the Design Professional to submit such response as soon as possible.

B. Conceptual Approval

If the development is found to be acceptable by those present, the Florida DOT may issue conceptual approval of the Design Development Phase in order that the Architect may proceed with the development of the next phase.

22.5.4 Submission Requirements

A. General

The Architect shall present sufficient documentation in the form of drawings, specifications, design criteria, and cost factors. This shall include working sketches and models as necessary to fully explain and establish the scope of the project and all of its particulars so as to be readily understood by lay and technical reviewer. The design criteria shall supplement the Design Development drawings, specifications and cost estimates. It shall be a presentation of facts sufficiently complete to demonstrate that the concept of the project is fully understood and that the subsequent design details in their presentation in the final plans and specifications will be on a sound professional basis.

The criteria, the basis for design, may be in any form or any combination of forms. It should be for all intents and purposes a copy of the working data upon which the design is based. Sketches, calculations, notes, economic analysis and any other pertinent data shall be presented as the design criteria. The information to be presented consisting of drawings, specifications, cost estimates and design criteria, should be complementary and should include, but not be limited to, the categories described.

#### B. Site

The information pertaining to the site and its development should be presented as an entity passing across professional disciplines. It should include, but not be limited to:

1. Information Data

Location plots, property and topographical surveys, subsurface boring, lots and plans, ecological and botanical surveys, and other appropriate information.

2. Master Plan

A copy of the Master Plan indicating the location of the project and total scheme, if applicable.

3. Environmental Considerations

Necessary design data, specifications, and cost estimates for preservation, dust, erosion,

sedimentation and runoff control, where applicable, as an integral part of the design and construction project. Such controls will be limited to the areas involved in the construction operation and those required by applicable ordinances, rules, laws, etc. Environmental control will not be confused with landscaping. The information provided will include statements regarding the type of treatments selected, the affected areas, and the reasons for the selection of the type of controls chosen.

4. Grading and Site Development.

a. Site Construction

All permanent features to be constructed on the site.

b. Roads, Walks, Paths and Parking

The data provided, in addition to the proposed development, should include a statement of the general soil conditions with a brief outline of the soil exploration and testing performed as related to the development of roads, etc. The type and volume of traffic, controlling wheel loads, classes of surfacing under consideration with justification for same, and any deviation from criteria fitness for those classes should also be included.

## 5. Utility Services

All existing and proposed utility services including runs, locations capacities, sources, characteristics, materials and installation methods should be fully described.

### a. Electrical

- (1) A statement relative to the adequacy of the primary supply at the point of takeoff. If the primary source is inadequate, state measures proposed to correct the deficiency.
- (2) The electrical characteristics of the power supply to the site or area, including circuit interrupting requirements, and voltage regulations.
- (3) An estimate of the total connected load and resulting kilowatt demand load by applying proper demand and diversity factors if a group of loads is involved.
- (4) The basis for selecting a primary and/or secondary distribution voltage.
- (5) The type, size and location of conductors.

- (6) Statements describing the pertinent standards of design, such as voltage drop, physical characteristics of overhead or underground circuit, types of lighting units and lighting intensities.
  - (7) The type and adequacy of telephone, signal, fire alarm and other communication systems, including a statement as to the number of spare telephone conductors available and spare capacity on fire alarm circuits.
  - (8) Emergency power systems.
- b. Fuel Distribution and Storage Information provided shall include for the following types:
- (1) Gas
    - (a) Statement of type, location of take-off from supply, and available pressure.
    - (b) Statement of type and material for pipes and valves.
  - (2) Liquid Petroleum Products
    - (a) Statement of unloading facilities, such as dock, tank car, or truck.

- (b) Description of the type of system and proposed features.
- (c) Statement of the basis for storage capacity, rate of pumping and number of dispensing outlets.
- (d) Description of power supply and power requirements.
- (e) Selection of type of materials for pipes, tanks and valves.

c. Steam Distribution

Data provided should include points of connection, pressure, size, material and method of installation of proposed piping.

d. Central Chilled Water and Refrigeration

The information provided should include sizes, material and method of installation of proposed piping.

e. Domestic Water and Fire Protection

- (1) Source, minimum and maximum pressure at each building and in the system, and an explanation of the existing system covering particularly the type, capacity, condition, present water use, and unsatisfactory elements of the

component parts.

- (2) A statement of the type of construction proposed, materials for water mains, or wells, etc.
- (3) The distribution system, a statement of design, domestic and fire flow usage of well pressure, elevation differential, and the designer's basic estimate of tentative pipe sizes.
- (4) A statement of tentative sizes, elevations, capacities, etc. as can be readily determined without long computations or design considerations for reservoirs, treatment units, pumping plans, well pumps and such units.

f. Sewers and Sewage Disposal Systems

Information provided shall include:

- (1) An explanation of existing systems covering particularly the type, capacity, conditions, present flow and unsatisfactory elements or components.
- (2) The interpretation of the degree of treatment necessary by field requirement and units necessary for treatment.

- (3) A statement of the design factors with present design population per various units for the sewage treatment plant.
- (4) Statements of materials to be used for the sewage system, sewage collection system and the sewage treatment plants.
- (5) Means of effluent disposal.

g. Storm Drainage

- (1) An explanation of the existing system covering particularly the type, capacity, condition, and unsatisfactory elements or components.
- (2) A statement of the type of construction proposed, material, etc.
- (3) A statement of the design requirements and tentative pipe sizes.

h. Electronics and Instrumentation

As related to the site, the following information shall be provided:

- (1) System engineering concepts.
- (2) Site and location considerations.



- (3) Antenna requirements such as types, separation, height, aircraft clearance, and area requirements.
  - (4) Site communications and control linkages.
  - (5) Electronic security considerations.
1. Cathodic Protection (in addition to the proposed development provided):
- (1) Results of soil resistivity measurements.
  - (2) Variations in soil makeup.
  - (3) Soil moisture content and normal seasonal variations.
  - (4) Results of temporary cathodic protection tests, if any.
  - (5) Results of structure to soil potential measurements where protection is to be provided.
- J. Lawn Sprinkling Systems: Provided tentative layouts, material, sizes, etc.

6. Fencing

Type, height and justification for fencing.

7. Landscaping

Plant species, size and layout.

8. Lateral and transverse sections through the site shall indicate development of the site, when necessary, due to substantial elevation changes or circulation at more than one level.

9. Any special consideration pertinent to the site and its development.

C. Buildings

Each building should be fully described. The information should include, but not be limited to:

1. Architectural

a. The plan of each floor showing furniture, equipment and any other use-determining factors.

b. Area recap and square footage should be indicated for each floor area and for the projects in total in comparison to that required by the program.

- c. Exterior elevations, delineated and shadowed, giving floor elevations at each level and showing finish materials.
- d. Transverse and lateral sections through the building, indicating heights, vertical circulation, and relationship. The finished floor elevations of each level should be given.
- e. Wall sections and wall details necessary to indicate the methods of construction and to determine the overall values achieved as required by the Florida Energy Code.
- f. Schedules indicating finishes and equipment in specific areas.
- g. Provide color schemes and schedules for all areas interior and exterior. Material and sample pallets shall be provided.
- h. The class of construction, occupancy, openings, and fire ratings for hall doors and other such openings shall be provided or indicated.
- i. Provide large scale plans describing complex, intensely equipped or furnished areas, and areas needing clarification.

- j. Provide a list of all safety equipment, including costs that have been included in the project.
- k. Sketches as necessary to portray the design concept. The formal architectural renderings, if required by the Contract for Professional Services, should be submitted after approval of the Design Development documents.
- l. A description of the materials used for all major items of construction.
- m. Other information considered necessary for the development of the program or explanation of the design.

2. Structural

- a. A description of foundation conditions, types of foundations to be used, the method by which the allowable bearing value is to be determined, and the maximum allowable bearing capacity for the foundation.
- b. Statement as to the type of construction adopted and reasons therefore, with capacities, dimension, or other size criteria.

- c. Preliminary floor plans showing framing members and column sizes indicating special design features and noting floor elevations. The description of structural floor system proposed with length and spacing of principal members, dimensions etc.
  - d. The description of structural roof system proposed with principal members, dimensions etc.
  - e. Provide structural building sections, transverse and longitudinal, indicating vertical relationships and headroom.
  - f. Note limited load carrying capacities and statements of live loading to be used including floor loads, winds, earthquake etc., with justifying data.
  - g. Provide calculations and design criteria when requested.
  - h. A statement of any special considerations that affect the design.
3. Heating, Ventilation, Air Conditioning (HVAC)
- a. Provide floor plan showing equipment layouts and single line layouts of duct work.
  - b. Provide sections showing equipment and locations of duct work.

- c. Energy Conservation: Provide calculations and criteria in the form and detail required to fully comply with the requirements of the Energy Conservation Manual and the requirements as set forth by the Energy Conservation Project Director.
  
- d. Provide full description of automated management systems proposed for use, including current and future capabilities.

#### Heating System

- (1) Statement of indoor and outdoor design temperatures and "U" factors for walls, ceilings, floors, etc., to be used in design.
  
- (2) Heating medium, such as steam, hot water, gas or electric.
  
- (3) Type of heating system such as convactor baseboard, forced warm air, unit heaters, etc.
  
- (4) Types of building temperature control; such as electric, electronic or pneumatic, and indicate outdoor anticipator or indoor thermostat.
  
- (5) Location and type of heating plant.

- (6) Brief explanation of the basis for selection of type of fuel, including an economic comparison with other fuels.

f. Ventilation

- (1) Statement of whether gravity or mechanical system.
- (2) Number of air changes per hour in various areas.
- (3) Ventilation air quantity during heating season and how acquired.

g. Air Conditioning

- (1) Provide a brief description of the air conditioning system proposed, such as factory assembled or built-up system; number of zones, if applicable; or unit type, chilled water system, or direct expansion, type of refrigerant, etc.
- (2) A statement of areas to be air conditioned.

- (3) Statement of inside temperatures and relative humidities, if applicable, outside wet and dry bulb design temperatures, "U" factors for the type of construction proposed and a statement of the economics of applying insulation and/or sun shades.
- (4) Description of equipment to be used such as reciprocating or centrifugal compressor, condensers, air handling equipment, duct system, piping, etc.
- (5) Type of building temperature control system such as electric, electronic or pneumatic and sequence of operation.

h. Evaporative Cooling

- (1) Statement of areas that are to be evaporatively cooled.
- (2) Description of equipment to be used.
- (3) Provide any other data as deemed necessary.

4. Electrical

- a. Indicate electrical service entrance characteristics, transformer requirements, etc.



- b. Indicate electrical characteristics such as phase, voltage, number of wires, etc., of each circuit. Provide a breakdown of the estimated connection load to show:
- (1) Lighting and convenience outlet load.
  - (2) Power load for building equipment such as heating, air conditioning, etc.
  - (3) Loads for special operating equipment such as compressors, welders, pumps, motors, etc., and for power receptacles being provided to energize special equipment. Apply an appropriate demand factor to each to compute a total demand load.
- c. Indicate the location of the main switchboard or power panels, light panels and all equipment panels.
- d. Indicate type of wiring system, such as rigid conduit, electrical metallic tubing, non-metallic sheathed cable, and where proposed for use.
- e. The type of conductors such as rubber insulated, varnished cambric, lead covered, etc., and their proposed location.
- f. Show the location of all lights, power outlets, switches, etc.

- g. Describe the proposed pertinent standards of design such as voltage drop, lighting intensities, and types of lighting fixtures.
  - h. Describe the short-circuit duty required for all protective devices and switch gear.
  - i. Indicate the requirements for emergency electrical systems.
  - j. Ensure that the electrical information for the facility is fully coordinated with the site electrical requirements and with the low voltage communications systems requirements.
  - k. Provide any other information necessary.
5. Communications, Electronic and Instrumentation Provisions
- a. Provide sufficient information including engineering concepts for review purposes of the systems proposed; i.e., intercom system, telephone system,, public address system, radio and antenna systems, television antenna systems, protective alarm system, response tie-ins and any other data or systems deemed necessary.
  - b. Indicate equipment selection, including special equipment requiring development, research, or breadboard methods to meet the requirements.
  - c. Site or location consideration.

- d. Required radio paths and propagations.
- e. Antenna requirements such as types, separation, tower heights, aircraft clearance and area requirements.
- f. Antenna transmission lines, terminations and switching.
- g. Bonding and grounding requirements.
- h. Communication, control cables and radio links.
- 1. Test equipment, repair shop and spare parts storage requirements.
- j. Equipment and instrumentation arrangement and space requirements indicating requirement for racks, consoles, and for individual mounting.
- k. Wiring and cable requirement plus terminations.
- l. Power and lighting requirements, including emergency or standby requirements.
- m. Air conditioning requirements including humidity and dust control requirements.
- n. Interference and clearance requirements

6. Plumbing

- a. Provide preliminary layout of utility lines and building construction services lines and elevations and sizes fundamental to design.
- b. Preliminary floor plans showing major horizontal and vertical services, the location and size of fixtures, equipment and the number of persons served.
- c. Preliminary building sections showing riser and branch lines, fixtures and equipment.
- d. Provide the estimated number of fixtures units in order, demand and GPM for all plumbing fixtures.
- e. Provide the estimated minimum and maximum water pressure at each building.
- f. Indicate the type of heater and capacity for hot water supply.
- g. Additional details as necessary to describe or clarify any other conditions.

7. Fire Protection

- a. Indicate service hydrants, stand pipes and test values.
- b. Indicate risers and hose cabinets.

- c. For sprinkler systems, indicate the authority for the installation, the hazard rate of occupancy, the type of sprinkler system (wet or dry), and the water volume and pressure required. Delineate any special system such as carbon dioxide, foam, etc., that will be required.
- d. Provide insurance rating groups governing the design.
- e. Provide any other data deemed necessary.

8. Special Equipment

Indicate all special equipment such as:

- a. Kitchen equipment
- b. Window coverings
- c. Lawn sprinkler equipment systems
- d. Any other systems deemed necessary for inclusion

D. Area Analysis

The Design Professional should submit an area analysis of the project. Use the criteria shown in EX-I-22-E and the summary form shown in Ex-I-22-F.

E. Other Data

Provide such data as deemed necessary to explain the design concept and Design Development documents.

## 22.6 Contract Document Phase

### 22.6.1 General

Subsequent to the receipt of approval of the Design Development documents, and upon authorization by the Florida DOT, the Architect, shall, in accordance with his Contract prepare complete contract documents of adequate and sufficient scope for construction purposes.

### 22.6.2 Development Procedures

The Architect shall hold conferences and meetings with the Florida DOT, applicable permitting agencies, and others as required to fully amplify the project and prepare his contract documents.

### 22.6.3 Review and Approvals

- A. Initial Reviews and Conferences: The Architect shall review in detail with the Florida DOT all codes and permits required for the project prior to proceeding with the development of his construction documents.
- B. 50% Contract Document Review Submittal: In accordance with the Contract, the Architect shall submit "in progress" review documents to the Florida DOT at 50% completion of Contract Documents.
- C. Final Reviews and Approvals
  - 1. Upon completion of his contract documents, the Architect shall submit complete document review

sets to the Florida DOT in a quantity sufficient to cover simultaneous review. He shall also submit review sets to any other agency having jurisdiction over the project and from which approvals will be required.

2. The complete contract documents will be reviewed by and commented on by all agencies having jurisdiction. Their comments should be transmitted by the Florida DOT to the Architect for response prior to scheduling, if necessary, a review conference at which the Architect should respond to all comments.
3. The Architect shall respond in writing to the comments received and shall correct or modify his documents as required. If necessary, he will resubmit the Construction Documents for additional review and comment.
4. Upon satisfactory response to all comments, and modification and correction of the contract documents, the Florida DOT will formally review and comment on the acceptability of the contract documents.

#### 22.6.4 Documents Required

##### A. General

The completed contract documents shall be in accordance with the requirements of the Contract.

##### B. Area Analysis

The Architect shall submit an area analysis of the project, shown as Exhibit I-22-E.

##### C. Color Schedules

The Architect shall include in his specifications and on his drawings, where applicable, the actual colors or color ranges chosen to be used on the project. The Design Professional shall also submit with his contract documents a complete listing of colors to be used, providing pallets and material samples as necessary.

##### D. Drawing Requirements

###### 1. General

The Architect shall ensure that his drawings are final and complete with all elements thoroughly checked and coordinated to ensure that there are no conflicts between architectural, structural, mechanical, electrical and other portions of the work. Particular emphasis shall be placed on this coordination when certain elements of the design are performed under



subcontract to the Design Professional. The drawings should be prepared so that change orders to construction will not be necessary due to errors, omissions, inadequacies or conflict between various component parts or with the specifications. When applicable, the design data should be shown on the drawings, i.e.:

a. Loads

- (1) Roof and Floor Live Loads
- (2) Wind Loads
- (3) Total Loads

b. Basic Working Stresses For

- (1) Concrete
- (2) Structural Steel
- (3) Wood
- (4) Concrete Block, Masonry

c. Foundations

- (1) Allowable Soil Pressure for Spread Footings
- (2) Bearing Value for Piles

2. Material

Unless otherwise instructed, the working documents shall be prepared in ink on plastic film (mylar).

## E Specification and Special Provision Requirements

### 1 General

The specifications shall be complete and final with all elements thoroughly checked and coordinated. Particular emphasis should be placed on the coordination of various elements of the specifications or portions of the specifications prepared under subcontract to the Design Professional.

### 2 Standard Specifications

Maximum use shall be made of standard materials and methods of construction and standard specifications.

Specifications for classifications of work and material issued by an approved association, such as ASTM, ASA, ASME, etc., may be included. Each referenced specification must be examined before its use to ensure that it is suitable for its intended purpose and that proper choice is made of the options given in it.

When a small quantity of materials is needed and a standard commercial product would be suitable, reference to a standard specification should not be made. Federal and military specifications may be used with the expressed approval of the Florida DOT.

When specifying by product, model number, etc., three acceptable manufacturer's products or equal will be specified.

In referencing standard specifications the following rules should be followed

- a Avoid reference to specific paragraphs in the standard specifications, since it limits the requirements to the paragraph referenced
- b Avoid repeated references to a standard specification within the same section
- c Specify types, classes, weights and similar applicable characteristics required to ensure an accurate description

The Architect shall submit to the Florida DOT with his construction documents submittal a copy of each referenced specification

| F Construction Cost Estimate

| Architectural contract documents shall include a statement of  
| probable construction costs This "estimate" shall be organized  
| according to the 16-division Construction Specifications Institute  
| (CSI) "Master Format"

| The statement of probable costs shall consist of a lump sum total  
| estimate, with specific pay items listed, and background cost data  
| The background cost data shall describe quantities, unit costs and  
| their products for the applicable subdivisions within the CSI  
| format

22 6 5 Release for Printing

Upon receipt of formal review and comment from the Florida DOT, and upon authorization, the Architect shall print and properly sign and seal three sets of documents for record purposes only

22 6 6 Pre-Bid Conference

The Architect will attend a pre-bid conference administered by the Department and he will be prepared to answer questions from prospective bidders who have reviewed the contract documents

## **22.7 Construction Phase Requirements**

### **22.7.1 Notice to Proceed**

The Notice to Proceed, authorizing the Contractor to proceed with the construction phase work, will be issued by the Florida DOT

### **22.7.2 Preconstruction Conference**

The Florida DOT, prior to commencement of construction, will arrange and chair a meeting with the Contractor, Design Professional, major subcontractors, and other interested parties. The purpose of this conference shall be

- A To discuss requirements and responsibilities of the various parties involved to achieve expeditious handling of the construction contract
- B The instruction of all parties concerning required and standard procedures, required submissions and federal or other regulations that are applicable to the project
- C Resolution of all problems as to the scope of the project and the signing of plans and specifications by all parties to the contract

### **22.7.3 Periodic Construction Conferences**

The Florida DOT shall schedule construction conferences monthly and/or at a frequency at the discretion of the Florida DOT in order to resolve current problems or to ensure that the project is progressing in a satisfactory manner. It shall be essential that the Contractor and the Architect attend

These meetings should cover the project as a whole, and certain essential information shall be sought and reported in every conference. The items are

- A Progress, as related to the schedule, to be reviewed by the Department and the Contractor prior to the meeting
- B Payment Request
- C Change Orders
- D The Florida DOT and Architect evaluations of the progress of the work
- E Special problems and remedial actions, and results of previous remedial actions

22 7 4 Shop Drawings, Material, and Equipment Submittals

A General

It shall be the responsibility of the Architect to expeditiously review all equipment brochures, shop drawings, catalog data, finished hardware schedules, etc, which are required to be submitted by the construction documents. The Architect should review all equipment and material submittals in such a manner as to determine whether or not the materials submitted are being offered as a substitute to those specified, and that the requirements of the contract documents are fully met.

## 22 7 5 Clarification Drawings and Specifications

### A General

The Architect will be required to issue supplementary drawings and/or specifications clarifying his contract documents as required. Whenever such drawings and specifications are issued by the Architect, he should ensure that said drawings and specifications do not obligate the Florida DOT for a change in scope of the project, either positively or negatively. Such changes in scope must be handled by Supplemental Agreement.

### B Issuance and Transmittal

Whenever the Architect finds it necessary to issue to the Contractor drawings and specifications to modify or clarify the work, a copy shall be supplied to the Florida DOT.

### C Final Inspection

Upon completion of construction and completion of all punchlist items, the Contractor shall arrange and schedule, with the concurrence of the Department, a final inspection of the project. He should coordinate the schedule with representatives of the Department and any other interested party. The Architect shall administer the inspection.

Following the inspection, the Architect shall provide the Contractor with a list of any additional requirements for corrective action and make another inspection, if necessary, to satisfy himself that the work has been completed.

#### 22.7.6 Substantial Completion

##### A. General

The Architect shall conduct a substantial completion inspection upon notification by the contractor that the project is ready for such. The Architect shall coordinate with all parties in determining the time of the substantial completion inspection (FDOT, A/E, Subconsultants, contractor, etc.).

##### B. Requirements

Upon completion of the substantial completion inspection, the Architect shall prepare the Certificate of Substantial Completion and punchlist.

Punchlist items shall include all items not satisfactory or not completed at the time of inspection.

##### C. Approvals and Declaration

Official occupancy of the project will not occur until substantial completion has been declared by the Architect and accepted by the Florida DOT.



22.7.7 Final Acceptance and Contract Close-Out

A. General

The Contractor shall notify the Florida DOT when the project has been fully completed and schedule the final inspection. The Architect shall provide the Contractor with a list of any items requiring correction and ascertain that the items have been corrected. The Architect shall then coordinate and conduct the final inspection and prepare the Certificate of Contract Completion and shall then distribute the certificates to the Contractor, who shall complete all copies and return them to the Florida DOT. The total contract amount must include all Supplemental Agreements.

Drawings and Title Block Requirements

Project Title  
Project Location  
State Project Number

Phase of Development  
(i.e., Conceptual Schematics, Advanced Schematics,  
Design Development, Contract Documents)

State of Florida  
Department of Transportation

Name of Architect  
Address of Architect  
Telephone Number of Architect

Sheet Number  
Date of Preparation  
Initials of Preparer  
Signature of Reviewer  
Date of Review

Date of Revisions  
Initials of Revisers  
Signature of Reviewer  
Date of Review

On Each Sheet as Applicable  
Name of Consultant  
Address of Consultant

EX-I-22-A

STATE OF FLORIDA DEPARTMENT OF TRANSPORTATION  
OFFICE OF SPECIAL FACILITIES

ROAD NO		COUNTY		PROJECT NO	
DESIGNED BY		NAMES		APPROVED BY	
CHECKED BY		DATES		DRAWING NO	
QUANTITIES BY		INDEX NO			
CHECKED BY					
SUPERVISED BY					

I-22-48.0

EX-I-22-B

Note:

The basic organization of the title block (Ex-I-22-B) shall be the same for each drawing, changing the information on each sheet as appropriate.

The sheet number shall always appear either on the lower right hand corner or along the right margin of the drawing.

Three prints of each drawing shall be sealed and signed by the responsible professional so as to produce three record sets of plans.

Title Sheets, Pages and Covers

Note:

The title sheet for drawings and the title page for specifications and/or special provisions should be made as simple as possible without undue embellishment and shall contain the following information:

Drawings, Specifications, Special Provisions

Project Title  
Project Location  
State Project Number  
Work Program Item Number  
For State of Florida  
Department of Transportation

Name of Architect  
Address of Architect

Date of Publication

Drawings Only

Map of Florida showing project location  
Range Scale vicinity map showing location of project

EX I-22-C

I-22-50.0

THIS CONTRACT PLAN SET INCLUDES

SUMMARY OF PAY ITEMS ( 1 SHEET )  
K-1 KEY SHEET

- ARCHITECTURAL DRAWINGS
- 1 SITE PLAN
- 2 FOUNDATION & ROOF FRAMING PLANS AND DETAILS
- 3 FLOOR PLAN AND ROOM FINISH SCHEDULE
- 4 ELEVATIONS DOOR SCHEDULE AND DETAILS
- 5 WALL SECTIONS AND DETAILS
- 6 1/4 TOILET PLAN AND ELEVATIONS BUILDING SECTIONS
- 7 ROOF PLAN REFLECTED CEILING PLAN DETAILS
- 8 WINDOW DETAILS
- 9 RECEPTION DESK
- 10 STRUCTURAL DETAILS
- 11 STRUCTURAL DETAILS

C-1 CIVIL DRAWINGS  
UTILITY SITE PLAN

- MECHANICAL DRAWINGS
- P-1 SCHEDULE NOTES
- P-2 PLUMBING FLOOR PLANS RISER DIAGRAMS
- N-1 SCHEDULES NOTES
- N-2 DUCTWORK LEGEND
- N-3 H V A C FLOOR PLAN
- N-4 CONTROL DIAGRAMS

ELECTRICAL DRAWINGS  
E-1 SYMBOLS AND ABBREVIATIONS  
E-2 LIGHTING PLAN  
E-3 POWER PLAN  
E-4 SCHEDULES

STATE OF FLORIDA  
DEPARTMENT OF TRANSPORTATION

PLANS OF  
ST AUGUSTINE  
MAINTENANCE OFFICE BUILDING  
ST JOHNS COUNTY, FLORIDA

STATE PROJECT NO 78000--3516

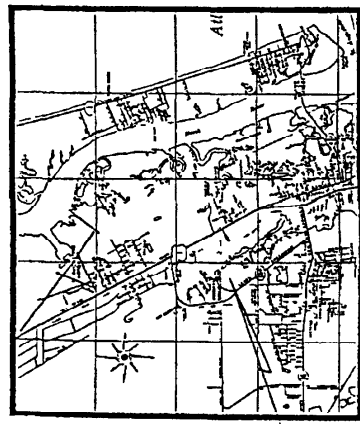
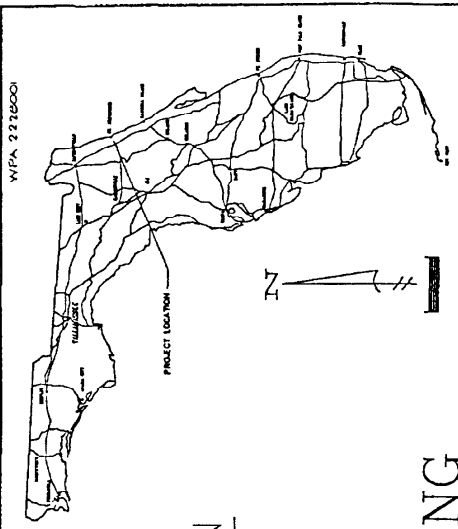

ATTENTION IS DIRECTED TO THE FACT THAT THESE PLANS MAY HAVE BEEN REDUCED IN SIZE BY REPRODUCTION THIS MUST BE CONSIDERED WHEN OBTAINING SCALED DATA

GOVERNING SPECIFICATIONS STATE OF FLORIDA DEPARTMENT OF TRANSPORTATION STANDARD SPECIFICATIONS DATED 1988 AND SUPPLEMENTS THERETO IF NOTED IN THE SPECIAL PROVISIONS FOR THIS PROJECT

DATE: \_\_\_\_\_

BY: \_\_\_\_\_

The covers for the specifications should indicate only the project title, location, state project number and work program item number.

The title sheet for the drawings may serve as the drawings cover or a plain manila sheet may be used for protection.

Specifications (Special Provisions) and drawings shall be bound in such a manner as to discourage separation or removal of pages.

## Standard Method of Area Calculation and Space Measurement

### Purpose

The purpose of the standard is: (1) to permit communication and computation of building areas and space measurement on a standard clear and understandable basis. (2) to allow comparison of values on the basis of generally agreed upon units of measurement (re: net square footage and gross square footage).

### Applicability

This standard shall be used in measuring space in old as well as new buildings, leased space as well as State-owned space. It is applicable to any architectural design or type of construction, being based on the premise that the net area being measured is that which the agency may occupy and use for its furnishings and its people.

### Type and Measurement of Space

The following types of space shall be applicable for measurements:

1. Net Usable Area

Net usable area shall be the sum of all occupiable space in a building, that is the measurable area of a building actually having usable value. The area shall be measured from the inside finish of permanent outer building walls to the office side of permanent corridors and/or other permanent partitions, and to

EX-I-22-E

1 of 5



the center of partitions that separate the premises from adjoining usable areas. This usable area shall include; bathrooms, stairs, elevator shafts, flues, pipe shafts, vertical ducts, air-conditioning rooms, fan rooms, janitor closets, electrical closets, and such other rooms not actually available to the tenant for his use.

No deductions shall be made for columns and projections to the building. For glass walls measure from the inside glass face.

2. Public Convenience Area

The public convenience area shall be the sum of all areas devoted to the welfare of the general public such as toilets, vending machine areas, telephone booths, etc.

3. Mechanical Area

The mechanical area shall be the sum of all areas devoted to the mechanical operation of the facility. Spaces shall include mechanical rooms, electrical closets, telephone closets, machinery rooms, pipe and mechanical chases, etc.

EX-I-22-E

2 of 5

4. Building Service and Storage Area

The building service and storage area shall be the sum of all areas within a building devoted to building service, such as janitor's closets, general building storage, maintenance areas and room, receiving areas, loading docks, etc.

5. General Circulation

The general circulation area shall be the sum of all areas within the building devoted to horizontal and vertical circulation, which are for general use and not assignable as net usable area.

6. Exterior Sheltered Area

Exterior sheltered area shall be the sum of all covered walkways, open roofed-over areas that are paved, porches, and similar space. In calculating total footage this area shall be multiplied by a factor of 0.50.

7. Structural Area

The structural area shall be the sum of all areas structurally devoted to the building. Generally it shall be the gross building area less the space designated as areas above including the exterior sheltered area multiplied by a factor of 0.50.

EX-I-22-E

3 of 5

8. Gross Building Area (Architectural Area)

The gross building areas of a building shall be the sum of:

- a. The several floors of the building including basements, mezzanine, and intermediate floored tiers and penthouse of headroom height, measured from the exterior faces of exterior walls or from the centerline of walls separating buildings.
- b. Gross building area shall not include such features as pipe trenches, exterior terraces or steps, chimneys, roof overhangs, etc.
- c. Void areas such as elevator shafts, mechanical shafts, etc., on each floor shall be included in the gross building area.

9. Exterior Developed Area

The exterior developed area shall be the sum of all hard surfaced specific purpose areas, such as decorative walls, plazas, fountains, etc.

10. Gross Project Area

Gross project area shall be the sum of the gross building area and the exterior developed area multiplied by a factor of 0.25.

EX-I-22-E

4 of 5

11. Net Maintainable Area

The net maintainable area shall be the gross project area less the structural area.

NOTE: Generally all area measurements should be taken at a plane 4'5" above finished floor and shall include all partitions in non-usable areas.

EX-I-22-E

5 of 5

AREA ANALYSIS - SUMMARY

Project Title: \_\_\_\_\_

Project Number: \_\_\_\_\_

- 1. Net Usable Area + \_\_\_\_\_
- 2. Public Convenience Area + \_\_\_\_\_
- 3. Mechanical Area + \_\_\_\_\_
- 4. Building Service & Storage Area + \_\_\_\_\_
- 5. General Circulation Area + \_\_\_\_\_
- 6. Exterior Sheltered ( x 0.50) + \_\_\_\_\_
- 7. Structural Area + \_\_\_\_\_
- 8. Gross Building (AIA) + \_\_\_\_\_
- 9. Gross Project + \_\_\_\_\_
- 10. Gross Project + \_\_\_\_\_
- 11. Less Structural Area - \_\_\_\_\_
- 12. Net Maintainable - \_\_\_\_\_

Efficient = Net Area (1) \_\_\_\_\_ = \_\_\_\_\_ =  
Gross Area (8) \_\_\_\_\_

EX-I-22-F

FACILITIES COMPUTATION FORM

A = \_\_\_\_\_ = 20 Year ADT (Allow for local commuter traffic ) T = \_\_\_\_\_ = Percent of overall traffic represented by trucks

K = \_\_\_\_\_ = Ratio of Design Hourly Volume to ADT (Generally 0.135)

D = \_\_\_\_\_ = Directional distribution of Design Hourly Volume (Generally 0.6+)

	Insert Factor A x K x D =	Total
<b>B = Peak hourly directional traffic</b>		
<b>C = Traffic composition</b>		
C1 - Cars (80% to 85%)	% x B =	
C2 - Cars with trailers (3% to 8%)	% x B =	
C3 - Trucks (5% to 13%) (T = )	% x B =	
C = B =	100% x B =	
<b>D = Vehicles per hour stopping at Rest Area</b>		
D1 - Cars	% x C1	
(a) Near commercial or recreational facilities (5%)		
(b) Typical rural route (9%)		
(c) Information and welcome centers (15%)		
D2 - Cars with trailers (10% to 15%)	% x C2	
D3 - Trucks (10% to 15%)	% x C3	
D = Total of D1, D2 and D3		
<b>E = Total parking spaces</b>		
E1 - Cars	x D1	
(a) Avg stop - 15 to 20 min (0.25 to 0.33 hr.)		
(b) At information and welcome centers - 20 to 30 min (0.33 to 0.5 hr.)		
E2 - Cars with trailers - 30 min avg (0.5 hr.)	0.50 x D2	
E3 - Trucks, 30 min avg (0.5 hr.)	0.50 x D3	
<b>F = Persons per hour using comfort facilities</b>	D x 2.25 =	
<b>G = Toilet and urinal fixtures 2.5 min avg use</b>	0.04 x F =	
(a) Men	0.50 x G =	
(b) Women	0.50 x G =	
(If the resultant number is uneven, the extra fixture shall be on the men's side)		

## Chapter 23

### Design Exceptions and Variations

#### 23.1 General

The Department's roadway design criteria and standards are contained in Chapters 2 and 25 of this volume. The values given in those chapters have been accepted by FHWA and are usually within the desirable ranges established by AASHTO.

Occasionally, it becomes necessary to deviate from the standard criteria used in the design process. When this is the case, early documentation and approval is required. Two specific deviations may occur: (1) design exception, (2) design variation.

It is very important that the correct term is used when it becomes necessary to deviate from standard criteria. This chapter includes specific requirements for the proper treatment of both design exceptions and design variations. In both cases, the design project file should clearly document the action taken and approval given.

#### 23.2 Design Exceptions

Design Exceptions are required when design criteria are applied which fall below the minimums established by AASHTO for the following controlling design elements:

- Design speed
- Lane widths
- Shoulder widths
- Bridge widths

- Structural capacity
- Vertical clearance
- Vertical alignment
- Horizontal alignment
- Stopping sight distance
- Cross slope
- Superelevation
- Grade
- Horizontal Clearance

Any request for exception must address the following items as a minimum:

- 1) the effect of the deviation from the design criteria on the safety (including clear recovery area) and operation of the facility, and safety mitigating measures considered and provided,
- 2) the compatibility of the design and operation with adjacent sections,
- 3) amount and character of traffic using the facility,
- 4) accident history (type, location, severity, etc ),
- 5) comparative cost of AASHTO criteria vs the proposed criteria,
- 6) the long term effect of the proposed criteria vs AASHTO criteria (effect of capacity reduction),
- 7) difficulty in obtaining AASHTO criteria (cost, R/W involvement, delay, environmental impacts, etc ),
- 8) level of service for AASHTO criteria vs proposed criteria, and
- 9) any other design criteria that is not being met, i e , cumulative effect of more than one criterion that is being proposed

In addition to the items listed above, requests for design exceptions shall include any background information which documents and/or justifies the request



In order to allow time to research alternatives and begin the required documentation process, it is critical that design exceptions be identified as early in the plans process as possible. This is preferably done during the PD&E phase.

When the need for a design exception has been determined, it is required that approval be requested no later than Phase II for major projects, and the initial phase for minor projects.

As an aid to the designer, Appendix "A", Pages A-1 through A-13 are given in the back of this chapter. The information displayed in these exhibits may be used as a reference for determining when a design exception is required (based on AASHTO criteria), but is in no way intended to replace FDOT design criteria.

### 23.3 Routing for Exceptions

The chart below gives the required routing and distribution schedule for design exception requests

PROJECT TYPE	DISTRICT	STATE ROADWAY DESIGN ENGINEER	DIRECTOR FDOT OFFICE OF DESIGN	FHWA	APPROVAL	SEE EXHIBIT
					CONCURRENCE	
District Let ≤ \$250,000	XXXX				*LOCAL	I-23-E
District Let \$250,000 - \$1 Million	XXXX	XXXX			DDE	I-23-B
					SRDE	
State Projects (non-FA)	XXXX	XXXX			DDE	I-23-B
					SRDE	
Exempt Projects**	XXXX	XXXX	XXXX		DDE	I-23-C
					SRDE, DOD	
CA Projects New/Reconst \$1-5 Million	XXXX	XXXX		XXXX	FHWA	I-23-A
					SRDE	
New/Reconst Interstate > \$1 Million	XXXX	XXXX		XXXX	FHWA	I-23-A
					SRDE	
All Projects which reduce Interstate Vert Clear to < 16 ft	XXXX	XXXX		XXXX	FHWA	I-23-A
					SRDE	
All Non-RRR FA Projects > \$5 Million	XXXX	XXXX		XXXX	FHWA	I-23-A
					SRDE	

\* For District let projects, the approval of the District Design (or Project Management) Engineer, with concurrence by the District Director of Production, is required. This approval shall be documented in the project file.

\*\* Projects exempt from FHWA oversight are defined as follows

- All RRR projects, including interstate (project-by-project),
- All Non-National Highway System projects, and
- All FA < \$1 Million, including new and reconstruction interstate projects
- For further information, see Chapter 24 of this volume

DDE = District Design Engineer

SRDE = State Roadway Design Engineer

DOD = Director, Office of Design

#### **23.4 Design Variation**

A Design Variation is required when design criteria are applied which fall below Department established criteria and the deviation is not covered by the Design Exception definition

A Design Variation request must address

- Design criteria vs proposed criteria,
- Reason the design criteria is not appropriate, and
- Justification for the proposed criteria

In addition to the items listed above, requests for design variations should include any background information which documents and/or justifies the request

Approval begins with the District Design Engineer Requests are routed through the State Roadway Design Engineer for concurrence

For approvals of design variations on projects to be let by the District equal to or less than \$250,000 construction costs, the approval of the District Design (or Project Management) Engineer, with concurrence by the District Director of Production, is required This approval shall be documented in the project file

As with design exceptions, it is critical that design variations be identified as early in the plans process as possible, preferably during the PD&E phase

When the need for a design variation has been determined, it is required that approval be requested no later than Phase II for major projects, and the initial phase for minor projects

**23.5 Routing for Variations**

The chart below gives the required routing, distribution and approval schedule for design variation requests

PROJECT TYPE	DISTRICT	STATE ROADWAY DESIGN ENGINEER	APPROVAL	SEE EXHIBIT
			CONCURRENCE	
District Let Projects < \$250,000	XXXX		* Local	I-23-E
District Let Projects \$250,000 - \$1M	XXXX	XXXX	DDE	I-23-D
			SRDE	
All Others	XXXX	XXXX	DDE	I-23-D
			SRDE	

\* For District let projects, the project file must contain the justification for the variation as developed by the Responsible Professional Engineer

DDE = District Design Engineer

SRDE = State Roadway Design Engineer

Date

Mr J R Skinner  
Division Administrator  
Federal Highway Administration  
227 North Bronough Street, Room 2015  
Tallahassee, Florida 32302

SUBJECT    Design Exception

REF        W P I Number  
            State Project Number  
            Federal Project Number  
            County

Include a brief background statement concerning project and item(s) of concern

Indicate design element(s) requiring exception and specific exception requested

Address each of the nine items listed under Section 23 2

Also, include justification, supporting documentation, etc

REQUESTED BY

---

District Secretary or Production Director

CONCURRENCE

APPROVAL

---

State Roadway Design Engineer

---

Division Administrator  
Federal Highway Administration

EX I-23-A

I-23-7 0

Revised 12/08/93

DATE

TO District Design Engineer

FROM

COPIES

SUBJECT Design Exception

REF W P I Number  
State Project Number  
County

Include a brief background statement concerning project and item(s) of concern

Indicate design element(s) requiring exception and specific exception requested

Address each of the nine items listed under Section 23 2

Also, include justification, supporting documentation, etc

RECOMMENDED BY

---

Responsible Professional Engineer  
(Name of Consultant Firm)

APPROVAL

CONCURRENCE

---

District Design Engineer

---

State Roadway Design Engineer

EX I-23-B

Revised 12/08/93

I-23-8 0

DATE

TO District Design Engineer

FROM

COPIES

SUBJECT Design Exception

REF W P I Number  
State Project Number  
F A Project Number  
County

Include a brief background statement concerning project and item(s) of concern

Indicate design element(s) requiring exception and specific exception requested

Address each of the nine items listed under Section 23 2

Also, include justification, supporting documentation, etc

RECOMMENDED BY

APPROVAL

---

Responsible Professional Engineer  
(Name of Consultant Firm)

---

District Design Engineer

CONCURRENCE

CONCURRENCE

---

State Roadway Design Engineer

---

Director of Design

EX I-23-C

I-23-9 0

Revised 12/08/93

DATE

TO District Design Engineer

FROM

COPIES

SUBJECT Design Variation

REF W P I Number  
State Project Number  
F A Project Number  
County

Include a brief background statement concerning project and item(s) of concern

Indicate design element(s) for which variation is requested, along with specific variation description

Address each of the items listed under Section 23 4

Also, include other supporting documentation, etc

RECOMMENDED BY

---

Responsible Professional Engineer  
(Name of Consultant Firm)

APPROVAL

CONCURRENCE

---

District Design Engineer

---

State Roadway Design Engineer

EX I-23-D

Revised 12/08/93

I-23-10 0



DATE

TO District Design Engineer (*or Project Management Engineer*)

FROM

COPIES

SUBJECT Design Exception (*Variation*)

REF W P I Number  
State Project Number  
County

Include a brief background statement concerning project and item(s) of concern

Indicate design element(s) requiring exception/variation and specific deviation requested

Address each of the nine items listed under Section 23 2

Also, include justification, supporting documentation, etc

RECOMMENDED BY

---

Responsible Professional Engineer  
(Name of Consultant Firm)

APPROVAL

CONCURRENCE

---

District Design Engineer  
or Project Management Engineer

---

District Director of Production

EX I-23-E

I-23-11 0

Revised 12/08/93

## CHAPTER 24

### FEDERAL AID PROJECT CERTIFICATION

#### 24 1 General

Certification Acceptance (C A ) is an agreement between the Department and the Federal Highway Administration (FHWA) Under this agreement FHWA accepts the Department's certification that the design and construction phases of specific Federal-Aid highway projects have been carried out in accordance with all appropriate Federal and State laws, regulations and standards Under C A the Department assumes the oversight responsibilities and duties previously performed by FHWA during the final design, award and construction of federal funded projects

Exemptions from the Federal Highway Administration (FHWA) oversight were also granted in accordance with the Secretary's request, dated March 20, 1992 per Title 23 USC 106(b) as amended by Section 1016(6) of the Intermodal Surface Transportation Efficiency Act (ISTEA) of 1991

## 24.2 Certification Acceptance Coverage

C A applies to the design phases for Roadway, Signing, Marking, Lighting, Signalization, Structural, Landscaping and Architectural plans on National Highway System (NHS) off-Interstate system projects. C A also applies to the award and construction activities on these NHS projects where the official cost estimate for construction is less than five million dollars. Final design and plans preparation for projects will be developed under C A after FHWA's acceptance of the project's location and design concepts (see chapters 3, 5 and 7 of the PD&E Manual). FHWA reviews and approvals are not required during the final design phases for any projects developed under C A, up to and including the authorization to advertise for bids. The agreement is documented in Topic No. 625-010-000.

### 24.2.1 Areas not Included

The final design phases of some Federal-Aid projects are not included under C A and will be developed with routine FHWA involvement. These types of projects are projects on the Interstate system with an estimated construction cost greater than \$1.0 million as well as projects that affect the Interstate system. Projects affecting the Interstate might involve a crossing of the Interstate or work associated on a cross road at the ramp terminals, regardless of the source of funding. If there are questions as to whether a project affects the Interstate system, the appropriate Area Design Engineer should be consulted.

In addition to the above projects that are not included in C A, there are special project features that require FHWA reviews and concurrences. These special features are

- A Individual structures with an estimated total deck area greater than 125,000 square feet, unusual or moveable bridges, tunnels and unusual hydraulic or geotechnical structures.

- B Major storm drainage systems designed to carry more than 200 cfs, or regardless of quantity of discharge, systems which have a surface detention storage system with an accumulated volume greater than five acre feet
- C Storm water pumping facilities designed to discharge more than 20 cfs
- D Major channel changes which may significantly change the stream regimen or ecology
- E Experimental features in the project design, including materials or construction methods
- F Traffic surveillance and control systems with an estimated construction cost greater than \$1 million
- G The use of proprietary or sole source items or materials
- H Operational plans for motorist-aid systems

Projects including these features may be developed under C A , however, the design of these features must be coordinated with FHWA to obtain the necessary reviews and approvals Current and accurate areas, discharges and cost estimates must be used to determine if FHWA involvement is required FHWA should be involved in a project as soon as it is evident that any of the above features will be included

C A also does not apply to the processing of the environmental document for a project (including reevaluations), any right-of-way phases, construction activities on projects where the official cost estimate is greater than five million dollars, or the acquisition of professional services, including authorizations for in-house design FHWA should be kept fully involved in these phases of Federal-Aid projects in accordance with current

procedures Hazard elimination projects (HES funded) and railroad grade crossing improvement projects (RRP/RRS funded) are covered under alternate C A procedures approved by FHWA on 9-12-88 (HES) and 11-17-88 (RRP/RRS)

Revised 06/09/93

I-24-4 0

24 3 Exemptions under ISTEA

Exemptions granted under the ISTEA of 1991 apply to the design, award and construction activities and require that the FDOT certify that all work will meet or exceed the design and construction standards approved by FHWA

24 3 1 Interstate

New or reconstruction projects, with any funding source except Interstate Completion, and which are less than \$1 0 M in construction cost are exempt from FHWA oversight per 106(b)(2) of Title 23 and the Secretary's request of March 20, 1992

24 3 2 Interstate, RRR

On all projects, regardless of cost, FDOT will elect on the PR1240/PR2 to exempt itself from FHWA oversight per 106(b)(1) of Title 23 and the Secretary's request of March 20, 1992

24 3 3 NHS off "I" System (Non-RRR)

New or reconstruction projects, any funding source, \$0 to \$1 0 M in construction cost are exempt from FHWA oversight per 106(b)(2) of Title 23 and the Secretary's request of March 20, 1992 All other projects are covered under Certification Acceptance per section 24 2

24 3 4 NHS off "I" System, RRR

All projects regardless of cost or funding, FDOT will elect on the PR1240/PR2 to exempt itself from FHWA oversight per 106(b)(1) of Title 23, and the Secretary's request of March 20, 1992

| 24 3 5      Non-NHS Projects

| All projects of any funding source are exempt from FHWA oversight per 106(b)(2) of  
| Title 23 and the Secretary's request of March 20, 1992

#### 24.4 Certification Responsibilities

The final design documents, reports and plans for C A projects and others exempt from FHWA oversight will be developed in accordance with all applicable Department manuals, guidelines and procedures, and in compliance with all applicable Federal Statutes, Regulations, Executive Orders, and FHWA Directives and Standards. The Department is responsible for assuring that all appropriate criteria has been adhered to, and for documenting its findings in lieu of FHWA reviews. Several of the major areas and the method to be used by the Department to document the acceptability of various final design activities in place of an FHWA review are

A Typical Section Package

The typical section package should be prepared as described in Chapter 15.3.3 of this volume. Concurrence by the District Design Engineer documents the acceptability of the package. Concurrence from the District Structures Engineer may also be required on unusual bridge typical sections.

B Pavement Design Package

The pavement design is developed and approved by the responsible professional engineer in accordance with Department pavement design procedures. Concurrence from the District Design Engineer is required to document the acceptability of the package in lieu of FHWA review and concurrence.

C Bridge Hydraulics Report

The hydraulics report is developed and approved by the responsible professional engineer in accordance with appropriate design standards. Concurrence from the District Drainage Engineer is required to document the acceptability of the package in lieu of FHWA review and concurrence.



- D     **Bridge Development Report**  
The bridge development report is developed and approved by the responsible professional engineer in accordance with appropriate design standards. Concurrence from the District Design, Structures, or Project Management Engineer is required to document the acceptability of the report in lieu of FHWA review and concurrence.
- E     **Design Plans Phase Reviews**  
Plan reviews should be conducted as described in Chapters 15.2, 15.3.1, and 16 of this volume. Concurrence in the resolution of phase review comments from the District Design, Structures, or Project Management Engineer is required to document the acceptability of the reviews in lieu of FHWA review and concurrence. (See Exhibit I-24-C.)
- F     **Roadside Safety**  
Roadside safety should be a consideration in the design process, as is discussed in Chapter 4 of this volume. The District Safety Engineer is required to review all project designs to ensure and document that all accident and safety problems have been addressed in lieu of FHWA compliance reviews.
- G     **Design Variations**  
Design variations procedures are described in Chapter 23 of this volume.
- H     **Design Exceptions**  
For projects subject to FHWA oversight or prepared under C.A. procedures, design exceptions, as described in Chapter 23 of this volume, still require approval by FHWA.

I Special Provisions

Special provisions, which include project specific and technical special provisions, will be developed and approved by the responsible professional engineer. Concurrence from the District Design, Structures (or, for Category II structures, the State Structures Engineer), or Project Management Engineer is required to document the acceptability of the special provisions in lieu of FHWA review and concurrence (See Exhibit I-24-D )

J Plans, Specifications and Estimate

The plans package and contract file will be transmitted to Tallahassee as described in Chapter 20 of this volume. The District Production Director will sign the transmittal letter certifying that the design and plans have been prepared according to the appropriate certification procedures. The specifications package will be approved by the State Specifications Engineer. The Department's official estimate will be approved by the State Estimates Engineer.

K Authorization to Advertise

The letter requesting FHWA authorization to advertise for bids and the PS&E package, including reimbursable utility agreements, will be submitted to FHWA by the Federal Aid Office. The Federal Aid Manager will certify in the letter to FHWA that the package was prepared under the appropriate certification procedures. An FHWA PS&E checklist (the Contract File Index, filled out by the District and submitted with the plans package) will be submitted to FHWA.

L Revisions

Revisions to the PS&E will be processed as described in Chapter 20 of this volume. Concurrence from the District Design, Structures, or Project Management Engineer is required to document the acceptability of the revision in lieu of FHWA review and concurrence.

In special cases where programs or projects are developed in the Central Office, an appropriate Central Office Manager will provide any necessary concurrences in lieu of a District Manager. Exhibit I-24-A outlines the approval and concurrence procedures used in the C A process.

## 24.5 Certification Documentation and Reviews

FHWA will perform periodic reviews of projects developed under C A and other exemption agreements and may have access to review project phases and records at any time. To support the exemption program, adequate documentation throughout the design phase is critical. All approvals and concurrences outlined in the previous section must be sufficiently documented. A complete, well-organized design project file should be able to support a compliance review. All correspondence and documents must include the federal aid project number. The Quality Assurance procedures described in Chapter 17 of this volume will be used by the Central Office to monitor district compliance with the certification requirements.

24 6 Certification Statement

The following statement will be furnished by the District (in Contract File) when plans are transmitted for letting. The same statement will be included in the letter requesting authorization (PR1240/PR2)

"The Florida Department of Transportation certifies that all work will meet or exceed, except as noted below, the standards approved by the Secretary of the U S Department of Transportation under 23 USC (109)(c) "

A list of all design exceptions, the dates requested and the dates approved must be immediately below the statement. If there were no exceptions on the project, a statement to that effect must be shown immediately below the statement. Copies of the approved design exceptions may be requested, if the Central Office files do not contain copies.

# CERTIFICATION ACCEPTANCE APPROVAL AND CONCURRENCE PROCESS

<p><b>TYPICAL SECTION PACKAGE</b></p> <p>Approved 6 Concurrence 3 or 4</p> <p>( PPM Vol 1 Chap 15 3 3 )</p>	<p><b>PAVEMENT DESIGN PACKAGE</b></p> <p>Approved 6 Concurrence 3</p> <p>( Pav t Design Manual )</p>	<p><b>DESIGN CRITERIA DESIGN EXCEPTIONS</b> Requested 1 or 2 Concurrence 8 Approved FHWA or 11</p> <p><b>DESIGN VARIATION</b> Recommended 6 Approved 3 Concurrence 8</p> <p>( PPM Vol 1 Chap 23 )</p>	<p><b>BRIDGE HYDRAULICS REPORT</b></p> <p>Approved 6 Concurrence Dist Drainage Engr</p> <p>(Drainage Manual Vol 2 Chap 9)</p>
<p><b>BRIDGE DEVELOPMENT REPORT</b></p> <p>Approved 6 Concurrence 3 4 5 or 7</p> <p>(Struct Design Guidelines Chap 3 3)</p>	<p><b>APPROVAL OF PHASE REVIEW BEARINGS (Roadways, and Structures)</b></p> <p>Approved 6 Concurrence 3 4 5 or 7</p> <p>( PPM Vol 1 Chap 15 )</p>	<p><b>PLANS SPECIFICATIONS AND ESTIMATE</b></p> <p><b>PLANS PACKAGE</b> Approved 2</p> <p><b>SPECIFICATIONS PACKAGE</b> Approved 3</p>	<p><b>REVISIONS TO PS &amp; E</b></p> <p>Approved 6 Concurrence 3 4 or 5</p> <p>( PPM Vol 1 Chap 20 2 )</p>
<p><b>ACCIDENT/SAFETY REVIEW</b></p> <p>Approved Dist Safety Engr</p>	<p><b>SPECIAL PROVISIONS</b></p> <p>Approved 6 Concurrence 3 4 or 5</p>	<p><b>OFFICIAL ENGINEERS ESTIMATE</b> Approved 10</p> <p>( PPM Vol 1, Chap 20 1 )</p>	<p><b>ASSEMBLY OF PS &amp; E &amp; CERTIFICATION OF OTHER REPORTS AS REQUIRED</b></p> <p>Responsibility FA Manager</p>

**NOTE**

In special cases where programs or projects are developed in the Central Office, an appropriate Central Office Manager will provide concurrence in lieu of the District Manager

- 1 DISTRICT SECRETARY
- 2 DISTRICT PRODUCTION DIRECTOR
- 3 DISTRICT DESIGN ENGINEER
- 4 DISTRICT STRUCTURAL ENGINEER
- 5 DISTRICT PROJECT MANAGEMENT ENGINEER
- 6 RESPONSIBLE PROFESSIONAL ENGINEER
- 7 STATE STRUCTURES DESIGN ENGINEER
- 8 STATE ROADWAY DESIGN ENGINEER
- 9 STATE SPECIFICATIONS ENGINEER
- 10 STATE ESTIMATES ENGINEER
- 11 STATE DIRECTOR OF DESIGN

**DESIGN OVERSIGHT**

DUTIES AND RESPONSIBILITIES

FEDERAL-AID PROJECTS

PROJECT TYPE	FHWA OVERSIGHT	FDOT DESIGN RESPONSIBILITIES
<b>INTERSTATE SYSTEM</b>		
COMPLETION PROJECTS	REQUIRED	COORDINATE FHWA REVIEWS/APPROVALS OBTAIN APPROVALS FOR EXCEPTIONS
NEW/RECONSTR > \$ 1M	REQUIRED	
NEW/RECONSTR < \$ 1M	EXEMPT ISTEA	PERFORM ALL OVERSIGHT REVIEWS DOCUMENT EXCEPTIONS/VARIANCES CERTIFY TO DESIGN STANDARDS
R-R-R PROJECTS ALL ON I-SYSTEM	EXEMPT PROJ BY PROJ ISTEA	REQUEST EXEMPTION PR1240/PR2 PERFORM ALL OVERSIGHT REVIEWS DOCUMENT EXCEPTIONS/VARIANCES CERTIFY TO DESIGN STANDARDS
<b>NATIONAL HWY SYSTEM</b>	C A AGREEMENT	
<b>OFF-INTERSTATE</b>		
NEW/RECONSTR > \$ 1M	REQUIRED FOR SPECIAL FEATURES ONLY	PERFORM ALL OVERSIGHT REVIEWS COORDINATE SPECIAL FEATURES W/FHWA DOCUMENT EXCEPTIONS/VARIANCES AGREED APPROVALS/CONCURRENCES
SEE "NOTE"		
NEW/RECONSTR < \$ 1M	EXEMPT ISTEA	PERFORM ALL OVERSIGHT REVIEWS DOCUMENT EXCEPTIONS/VARIATIONS CERTIFY TO DESIGN STANDARDS
R-R-R PROJECTS ALL ON NHS	EXEMPT PROJ BY PROJ ISTEA	REQUEST EXEMPTION PR1240/PR2 PERFORM ALL OVERSIGHT REVIEWS DOCUMENT EXCEPTIONS/VARIANCES CERTIFY TO DESIGN STANDARDS
<b>NON-NHS ALL PROJECTS</b>	No FHWA OVERSIGHT	PERFORM ALL OVERSIGHT DUTIES DOCUMENT EXCEPTIONS/VARIANCES
"NOTE" C A DOES NOT APPLY TO CONSTRUCTION ACTIVITIES ON PROJECTS WITH CONSTRUCTION COSTS OF \$ 5M OR GREATER		

EX I-24-B

DATE:

TO: (See Below)\*

FROM:

COPIES:

SUBJECT: Response to \_\_\_\_\_ Phase Review

REF: W.P.I. Number  
State Project Number  
F.A. Project Number  
County

In content of letter include a statement confirming that all review comments have been responded to or satisfactorily resolved.

Include appropriate copies of review comments, responses and other pertinent data.

APPROVED:

CONCURRENCE:

\_\_\_\_\_  
Responsible Professional Eng.  
(Name of Consultant Firm)

\_\_\_\_\_  
\* District Design Engineer  
\* District Structures Engineer  
\* District Project Mgmt. Eng

\* As appropriate

EX I-24-C

I-24-15 0

Revised 12/08/93



DATE:

TO: District Design, Structures or  
Project Management Engineer

FROM:

COPIES: State Specifications Engineer

SUBJECT: Special Provisions

REF: W.P.I. Number  
State Project Number  
F.A. Project Number  
County

Include detailed information concerning special provisions required.

Appropriate section(s) of F.D.O.T. Standard Specifications should be referenced.

Questions concerning format and content should be directed to the Specifications Office of F.D.O.T.

APPROVED:

CONCURRENCE:

\_\_\_\_\_  
Responsible Professional Eng.  
(Name of Consultant Firm)

\_\_\_\_\_  
\* District Design Engineer  
\* District Structures Engineer  
\* District Project Mgmt. Eng

\* As appropriate

EX I-24-D

Revised 12/07/93

I-24-16 0

DATE:  
TO: District Design, Structures or  
Project Management Engineer  
FROM:  
COPIES: State Specifications Engineer  
SUBJECT: Special Provisions  
REF: W.P.I. Number  
State Project Number  
F.A. Project Number  
County

Include detailed information concerning special provisions required.

Appropriate section(s) of F.D.O.T. Standard Specifications should be referenced.

Questions concerning format and content should be directed to the Specifications Office of F.D.O.T.

APPROVED:

CONCURRENCE:

\_\_\_\_\_  
Responsible Professional Eng.  
(Name of Consultant Firm)

\_\_\_\_\_  
\* District Design Engineer  
\* District Structures Engineer  
\* District Project Mgmt. Eng

\* As appropriate

EX I-24-E

I-24-17 0

Revised 06/09/93

**Chapter 25 Florida's Design Standards for Resurfacing, Restoration  
and Rehabilitation (RRR) of Streets and Highways**

25 1	Introduction	I-25- 1 0
25 1 1	General	I-25- 1 0
25 1 2	Application	I-25- 2 0
25 2	Planning and Programming RRR Projects	I-25- 3 0
25 2 1	Projects Requiring R/W	I-25- 3 0
25 2 2	Projects with Bridges	I-25- 3 0
25 2 3	Project Features Requiring Exceptions and Variances	I-25- 3 0
25 3	RRR Project Design Process	I-25- 4 0
25 3 1	Review of Project Purpose	I-25- 4 0
25 3 1 1	Principal Reason for the RRR Project	I-25- 4 0
25 3 1 2	General Nature of Proposed Improvements (Type of Work)	I-25- 5 0
25 3 1 3	Review Project Budget and Priority	I-25- 6 0
25 3 2	Assessment of Conditions	I-25- 6 0
25 3 2 1	Office Reviews	I-25- 6 0
25 3 2 2	Field Reviews	I-25- 7 0
25 3 3	Project Scopes	I-25- 8 0
25 3 4	Review Project Plans	I-25- 9 0
25 3 5	Document the Design Process	I-25-10 0
25 4	RRR Design Criteria	I-25-11 0
25 4 1	Design Period	I-25-11 0
25 4 2	Design Traffic Volume	I-25-12 0
25 4 3	Pavement Design	I-25-12 0
25 4 4	Design Speed	I-25-12 0
25 4 5	Lane and Shoulder Widths	I-25-13 0
25 4 6	Cross-Slopes	I-25-14 0
25 4 7	Superelevation	I-25-15 0

25 4 8	Shoulder Treatment	I-25-16 0
25 4 9	Side Slopes	I-25-16 0
25 4 10	Vertical Alignment	I-25-17 0
25 4 10 1	Vertical Curvature	I-25-18 0
25 4 10 2	Grades	I-25-18 0
25 4 11	Horizontal Alignment	I-25-20 0
25 4 11 1	Horizontal Curves	I-25-20 0
25 4 11 2	Stopping Sight Distance	I-25-22 0
25 4 12	Stopping Sight Distance	I-25-23 0
25 4 13	Vertical Clearance	I-25-23 0
25 4 14	Horizontal Clearance	I-25-24 0
25 4 15	Clear Zone	I-25-24 0
25 4 16	Border Width	I-25-26 0
25 4 17	Intersections	I-25-26 0
25 4 18	Drainage	I-25-27 0
25 4 19	Pedestrian and Bicyclist Needs	I-25-27 0
25 4 20	Utilities (Underground and Overhead)	I-25-28 0
		Revised 01/24/94
25 4 21	At-grade Railroad Crossings	I-25-29 0
25 4 22	Aesthetics and Landscaping	I-25-29 0
25 4 23	Highway Lighting	I-25-29 0
25 4 24	Highway Traffic Control Devices	I-25-30 0
25 4 25	Bridges	I-25-30 0
25 4 25 1	Bridge Loading	I-25-31 0
25 4 25 2	Bridge Width	I-25-31 0
25 4 25 3	Bridge Railing	I-25-32 0
25 4 25 4	Vertical Clearance	I-25-32 0
25 4 25 5	Considerations	I-25-33 0
25 5	Design Exceptions and Variances	I-25-34 0

<b>Tables</b>	<b>Table #</b>	<b>Page</b>
<b>Minimum Lane and Shoulder Widths for</b>		
Rural Multilane	25 4 5 1	I-25-13 0
Two Lane Rural & Urban w/o Curb & Gutter	25 4 5 2	I-25-14 0
Urban Multilane or 2-Lane w/ Curb & Gutter	25 4 5 3	I-25-14 0
<b>Normal Roadway Cross Slopes</b>	25 4 6	I-25-15 0
<b>Stopping Sight Distance</b>	25 4 10	I-25-19 0
<b>Allowable Horizontal Curvature</b>		
with Maximum Superelevation	25 4 11 1	I-25-22 0
Required Stopping Sight Distance	25 4 11 2	I-25-23 0
<b>Clear Zones</b>	25 4 15	I-25-25 0

## Chapter 25

### Florida's Design Criteria for Resurfacing, Restoration and Rehabilitation (RRR) of Streets and Highways

#### 25.1 Introduction

##### 25 1 1 General

Resurfacing, restoration and rehabilitation (RRR) work is defined as work undertaken to extend the service life of an existing highway and/or enhance highway safety. This includes the placement of additional surface materials and/or other work necessary to return an existing roadway to a condition of structural and functional adequacy. Many of the RRR Standards used by the Department are derived from the National Academy of Sciences "Special Report 214". This publication contains many of the methods necessary to make the safety and cost effective evaluations required by this chapter.

RRR projects must be designed and constructed in a manner that will comply with the accessibility standards and requirements set forth in the Americans with Disabilities Act of 1990 (ADA).

25 1 2      Application

The criteria included herein are for all RRR projects except Interstate and freeways, and are not intended to apply to new construction or major modifications of existing facilities. Interstate and freeway RRR projects are designed using new construction criteria except that the standards used for horizontal alignment, vertical alignment, and widths of median, traveled way and shoulders may be the AASHTO interstate standards that were in effect at the time of original construction or inclusion into the interstate system.

The RRR criteria may be used for establishing the minimum requirements for intersection improvement projects with the understanding that when right-of-way is adequate, new construction criteria will be used to the maximum extent feasible.

Approved October 7, 1993

I-25-2 0

## **25.2 Planning and Programming RRR Projects**

RRR projects must balance a number of competing objectives, the principal ones being the preservation of highways, improved service levels and enhancement of safety. The success in meeting these objectives depends on the quality of individual project designs and project programming decisions.

### **25.2.1 Projects Requiring Right-of-Way**

Facilities programmed for RRR projects should be given a review of the existing right-of-way, roadway, access management, drainage design elements and other improvements to identify locations which require additional right-of-way. For such locations, the design should be expedited to determine actual right-of-way requirements. The designer must coordinate the requirements with the Right-of-Way Office so that necessary areas will be cleared before the project is ready for letting.

### **25.2.2 Projects with Bridges within Project Limits**

Bridges must be reviewed in sufficient detail to clearly establish the cost effective and appropriate changes to be included in the project design effort.

### **25.2.3 Project Features Requiring Exceptions and Variations**

Projects may have features below criteria values which have not been programmed and/or which are determined not to be appropriate to accomplish under this design project. These usually require design exception or variation approval, as appropriate. See Section 25.3.5 and 25.5.



### 25.3 RRR Project Design Process

Significant improvements in overall safety can be brought about by a systematic safety conscious design process. The design process is a team effort which requires the expertise of persons familiar with design, safety, maintenance, traffic operations and others. To assure that safety issues are fully addressed on RRR projects, in addition to the usual design process, the following is also required:

- A review of the purpose for which the RRR project was programmed
- An assessment of current safety conditions
- A final scope of work with recommendations for specific safety improvements
- Documentation of the safety design decisions
- Reviews of the design for safety issues

#### 25.3.1 Review of Project Purpose

A RRR project is generated by specific needs or conditions. The designer must become familiar with these needs or conditions at the very beginning of involvement with the project in order to assure that the final scope of work and final design actually accomplish the original purpose of the project. This may involve research of background data or other information that provide the reason, the proposed improvements, estimated project cost and project priority.

#### 25.3.1.1 Principal Reason(s) for the RRR Project

The following list indicates some, but not all, of the principal reasons that can generate a RRR project:

- a To preserve or extend the life of the existing pavement
- b Improve capacity (without adding continuous through lanes)
- c Improve operating characteristics

- d Site specific accident reduction
- e Section wide accident reduction
- f General safety modifications

25 3 1 2      General Nature of Proposed Improvements (Type of Work)

In addition to resurfacing, restoration and rehabilitation a project may include one or more of the following types of work as a general improvement. The list is not all inclusive.

- a Widen roadway and bridge lanes
- b Widen or add roadway and bridge shoulders
- c Provide disability access
- d Provide clear zone
- e Upgrade pavement markings
- f Add, update or remove traffic signals
- g Correct skid hazards
- h Replace bridges rated "insufficient"
- i Upgrade bridge rail
- j Upgrade to current Access Management requirements
- k Provide non-vehicular transportation needs
- l Add or extend auxiliary lanes to a roadway
- m Add turn lanes at an intersection or on a roadway
- n Realign an intersection or roadway
- o Replacement of bridges which cannot be widened economically
- p Upgrade at-grade railroad crossings
- q Intersection improvements
- r Removal of parking lanes
- s Other safety improvements

25 3 1 3      Review Project Budget and Priority

The design and construction of a RRR project must be accomplished with expediency and at reasonable cost. Nevertheless, the project design must address all issues of safety, plus preservation of investment, and service to the user. Conditions which are discovered but cannot be resolved within the programmed budget and schedule must be addressed and the decisions documented.

25 3 2      Assessment of Conditions

Before beginning actual design of the project, the designer shall assess current conditions on the project. This assessment shall include both physical conditions and operating conditions plus a safety assessment. Office reviews and field reviews shall be performed as part of the assessment.

25 3 2 1      Office Reviews

Office reviews shall be conducted to assimilate and analyze data that may be pertinent to the improvements that can be made on the project.

a )      Assess Physical Conditions

This assessment should include

- geometrics,
- degree, length, and superelevation of curves,
- typical shoulder treatments,
- cross drain and structure locations,
- location and design of intersections, etc

A review of old plans, as built drawings, Straight Line Diagrams, and other historical records will determine many of the existing conditions.

b ) Assess Operating Conditions

This assessment should include

- A summary of legal posted speeds on the project
- Drainage and Maintenance section's verbal or written concerns of past, present and/or anticipated future problems
- Conditions attributable to current control of access

c ) Assess Safety

A review of historical accident and travel statistics shall be performed by a qualified safety specialist. This assessment, with written recommendations, should include

- Identification of significant accident locations, with
  - (a) possible causes
  - (b) suggested corrective measures
- Review of correspondence files for letters of public concern

25 3 2 2 Field Reviews

A field review shall be performed by a multi-discipline team. This review should assess physical, operational and safety conditions

a ) Assess Geometric and Physical Conditions

- Verify office review findings
- Check roadway features such as
  - alignment
  - cross slope
  - superelevation
  - lane width

existing traffic control markings and signs  
side slopes  
clear zones  
shoulder type and width  
intersection elements  
sight distances  
drainage (including erosion problems)  
pavement condition  
highway appurtenances  
other features

b ) Assess Operating Conditions

- verification of posted regulatory speeds
- verification of posted advisory speeds
- verification of reported problems
- observation of operating conditions
- evaluation of access features

c ) Assess Safety Conditions

- observation of known accident locations
- indications of unsafe operations, such as run-off-the-road indications or previous repairs

25 3 3 Project Scopes

Utilizing the office and field review findings, prepare a final scope of work by incorporating, where appropriate, other work including engineering and surveying services not identified in the original scope. Improvements other than resurfacing, restoration or rehabilitation to be considered are listed below. The list is not all inclusive.

Approved October 7, 1993

I-25-8 0

- Remove, relocate or make crashworthy roadside obstacles
- Remove unwarranted guardrail
- Upgrade or replace non-standard guardrail
- Replace or retrofit obsolete bridge rails
- Improve side slopes, slope flattening/stabilizing
- Correct shoulder drop off
- Pave shoulders
- Improve pavement cross slope
- Provide side drain safety modifications
- Increase sight distance at intersections
- Improve pavement markings
- Improve pavement drainage
- Provide or upgrade sidewalks and bikeways
- Upgrade railroad crossings
- Provide or upgrade signalization
- Provide or upgrade lighting
- Upgrade signing and other traffic control devices
- Provide or upgrade curb cuts, ramps and other disability access features
- Reconstruct or close driveways to comply with Access Management standards

25 3 4      Review Project Plans

RRR design plans are reviewed by other disciplines including a safety specialist. These reviews are detailed in Chapter 15 of this volume.

25 3 5      Document the Design Process

The designer shall include in the design file all documentation that substantiates the design process and decisions made, including the following information

- 1      A short paragraph which states the overall project purpose. Factors such as principal reason for the project, anticipated project cost, principal work type, general right-of-way needs or provisions, and any special project priorities are appropriately addressed here.
  
- 2      Documents that detail the existing conditions on the project. Findings of office reviews, field reviews and surveys are assembled here, to document existing geometric and roadside features, operating conditions, traffic volumes, posted speeds, existing pavement markings, signing, safety, etc. A brief overall summary of findings is recommended.
  
- 3      Document the selected standards based on project intent and conditions. When RRR criteria cannot be met, a design exception/variation is required.
  
- 4      A summary of safety issues that have been identified for the project and the recommended solution of those issues.
  
- 5      Reviews of the project design for safety improvements, documenting what was finally accomplished or ruled out of the project subsequent to the scope of work having been completed.
  
- 6      Those items in the original scope of work for the project which cannot be reasonably accomplished and must be deleted or delayed.

## 25.4 RRR Design Criteria

Design values and decisions for roadway features should reflect the anticipated service life of the project. The designer has the responsibility to choose the specific design value to be used, taking into consideration its cost-effectiveness, which can range from the minimum RRR Criteria presented herein, to new construction criteria. Design values in the following sub-sections apply to RRR projects only. When specific values are not provided, the standards used in the original construction or subsequent enhancements may be retained except when an upgrade is identified in the project scope. Designers are encouraged to make a deliberate selection of design values by explicitly addressing issues of safety cost-effectiveness, overall highway consistency in geometric design, design of adjoining segments and expected trends in traffic growth and truck use before specifying design values. The design values indicated in this chapter usually reflect a cost-effective basis for evaluating existing roadway characteristics to determine which features require upgrading.

The design values presented herein are the minimum to be used for a RRR project on the State Highway System without obtaining an exception or variation. See Section 25.5

### 25.4.1 Design Period

Improvements should be evaluated using a design period which is consistent with the design period selected for the pavement rehabilitation. The design period (service life) for RRR projects should be from 8 - 12 years for projects without milling and 10 - 20 years for projects with milling. See the Flexible Pavement Manual for additional details. For skid hazard projects, where other improvements are not made, the design year is the expected year of construction.



## 25 4 2 Design Traffic Volume

The design year for traffic volume is the same design year as the year established for service life Traffic data to be used for design

- 1 ADT and DHV for mainline (current, post construction and design year),
- 2 K, D and T factors,
- 3 Peak turning movements at signalized and problem intersections and major traffic generators,
- 4 Movements for future traffic generators that are scheduled during the service life should be considered

## 25 4 3 Pavement Design

The pavement design procedures are found in

Flexible Pavement

Document 625-010-002, Flexible Pavement Design Manual For  
New Construction And Pavement Rehabilitation

Rigid Pavement

Document 625-010-005, Rigid Pavement Rehabilitation  
Document 625-010-006, Jointed Plain Concrete Pavement Design  
Manual

## 25 4 4 Design Speed

Most highway features are based on design speed Design speed is the maximum safe speed that can be maintained when conditions are so favorable that the design features of the highway govern Selection of the design speed must be logical for the type and

location of the highway Design speed must not be less than the legal posted speed  
 Design speed must not be dictated by an isolated geometric feature

The design speed used in the original design of the highway should be used for RRR projects If that is not practical, the design speed used should be consistent with comparable projects

Minimum design speeds are

Rural Facilities 55 MPH

Urban Facilities 30 MPH

Note Values for design speeds less than these minimums have been provided in the following tables in the event that lower design speeds can be justified

25 4 5 Lane and Shoulder Widths

The minimum lane and shoulder widths to be used are provided in Tables 25 4 5 1 - 25 4 5 3 Paved shoulders shall be provided when required under new construction criteria For new construction paved shoulder criteria, refer to Chapter 2 of this volume

<b><u>Rural Multilane</u></b>			
Design Year ADT	Design Speed (MPH)	Minimum Lane Width (ft )	Minimum Shoulder Width (ft )
ALL	ALL	12	6

**Table 25.4.5.1**

<b>Two Lane Rural and Urban, Without Curb and Gutter</b>			
Design Year ADT	Design Speed (MPH)	Minimum Lane Width (ft )	Minimum Shoulder Width (ft.)
1 - 750	ALL	10 <sup>(1)</sup>	4 <sup>(1)(2)</sup>
751 - 2000	< 50	11 <sup>(3)</sup>	4 <sup>(1)(2)</sup>
	≥ 50	12 <sup>(3)</sup>	6
> 2000	ALL	12 <sup>(3)</sup>	6

(<sup>1</sup>) For rural and urban projects without curb and gutter (regardless of traffic volume), when widening is required, 11 ft lane widths and 6 ft shoulder widths are the minimum values allowed

(<sup>2</sup>) When a 4 or 5 foot paved shoulder is required, a 6 foot minimum shoulder width is required

(<sup>3</sup>) May be reduced by 1 ft if trucks < 10% of design year traffic

**Table 25.4.5.2**

<b>Urban Multilane or 2 Lane with Curb and Gutter</b>				
Design Year ADT	Design Speed (MPH)	Minimum Thru Lane (ft )	Minimum Turn Lane (ft )	Minimum Parking Lane (ft )
ALL	ALL	10 <sup>(1)</sup>	9 <sup>(2)</sup>	7

(<sup>1</sup>) 11 feet if Trucks are > 10% of Design Year Traffic

(<sup>2</sup>) 10 feet for 2 Way Left Turn Lanes

**Table 25.4.5.3**

25 4 6 Cross-Slopes

Whenever practical, pavement cross-slope shall be constructed to new construction criteria. When new construction cross slope criteria cannot be met, documentation in the design file is required and the normal non-superelevated cross-slope used shall be

consistent with the values in Table 25.4.6. Superelevation requirements are covered in Section 25.4.7.

Roadway Cross-Slopes		
Feature	Standard	Range
Travel Lanes	0.02	0.02 - 0.04 <sup>(1)</sup>
Shoulders	0.06	0.03 - 0.08 <sup>(2)</sup>
Parking Lanes	0.05	0.03 - 0.05
<p><sup>(1)</sup> Existing multi-lane curb and gutter sections originally constructed with a parabolic crown section may be resurfaced using a series of tangents with a cross-slope range from 0.015 to 0.05.</p> <p><sup>(2)</sup> When existing shoulders are to remain, the algebraic difference between the shoulder slope and adjoining roadway pavement slope shall be <math>\leq 0.07</math>.</p>		

**Table 25.4.6**

25.4.7 Superelevation

Roadway and shoulder superelevation shall be provided in accordance with Standard Drawing 510 for rural curves and Standard Drawing 511 for urban curves, consistent with Section 25.4.11(b).

25 4 8      Shoulder Treatment

On projects with rural type (without curb) construction, shoulders, erosion control, sodding and reworking shoulders shall be provided consistent with the criteria for new construction contained in Chapter 2 2 6 of this volume Paved shoulder criteria is provided in Section 25 4 5

25 4 9      Side Slopes

The values selected shall be the flattest that are practical On RRR projects where existing ditches can be modified for stormwater management purposes, the use of steeper than standard side slopes and additional depth may be cost-effective but would require a variation Justification must fully address safety, water depth, as well as cost-effectiveness

Front Slopes

- 6 1 are desirable
- 4 1 may be constructed within the clear zone
- 3 1 may be constructed outside the clear zone
- Existing front slopes 3 1 or flatter may remain within the clear zone Shielding may be required
- Steeper than 3 1 shall be shielded as per Standard Index 400, General Notes
- Consideration should be given to flattening slopes of 3 1 or steeper at locations where run-off-road type accidents are likely to occur (e g , on the outsides of horizontal curves)
- The proposed construction should not result in slopes steeper than the existing slopes in violation of the above values

## Back Slopes

- 4:1 are desirable
- 3:1 may be constructed in the clear zone
- 2:1 may be constructed outside the clear zone without shielding
- Existing back slopes 2:1 and flatter may remain

## 25.4.10 Vertical Alignment

Vertical and horizontal alignment must be reviewed together to assure that the necessary balance of standards is realized and that the combination is both safe and pleasing.

The alignment should be reviewed to see if the following principles are generally satisfied by the existing vertical alignment:

- the sight distance provided meets or exceeds the values in Table 25.4.10, column B
- grades do not significantly affect truck operations
- there are no hidden dips which could obscure traffic or hazards
- steep grades and sharp vertical curves do not exist at or near an intersection
- sufficient grades and, when necessary, special gutter grades exist to adequately drain urban projects
- adequate sight distance exists for traffic signals, e.g. beyond overpasses, etc.

When any of the above conditions do not exist, the designer should evaluate for hazardous conditions and determine if corrective measures are warranted.

25 4 10 1 Vertical Curvature

The designer shall use the method given in Table 25 4 10 to check the sufficiency of vertical curves and provide any indicated corrective measures, When an evaluation is required, it shall consider

- the nature of potential hazards hidden by a hill crest,
- the location of the hazard in relation to the portion of the highway where sight distance falls below new construction criteria
- effectiveness of other options such as relocating or correcting the hazard
- providing warning signs

25 4 10 2 Grades

Grades which satisfied the standards in effect at the time of construction may be used provided the result is consistent with the above design principles Grades which are not consistent with the above design principles must be evaluated

<u>DESIGN SPEED</u> (MPH)	<u>STOPPING SIGHT DISTANCE (FEET) (1)</u>		
	A	B	C
30	200	200	165
35	240	220	200
40	300	270	240
45	350	325	280
50	410	400	325
55	470	450	370
60	530	525	420
65	610	550	455

For the design speed, compare the length of the available sight distance to the tabulated values

- a If the length is equal to or greater than the "A" value, the curve is satisfactory
  - b If the curve is equal to or greater than the "B" value but less than the "A" value, a study **should** be made to evaluate possible mitigation of hazards requiring driver reaction and/or appropriate treatment such as relocation of the hazard, hazard warning signs, reduced safe speed signs, etc
  - c If the length is equal to or greater than the "C" value but less than the "B" value, a study **shall** be made and appropriate treatment such as relocation of the hazard, hazard warning signs, reduced safe speed signs, etc provided Possible reconstruction of the curve should be considered
  - d If the value is less than the "C" value, **reconstruction** of the curve is required
- (1) Based on height of eye of 3.5 feet and height of object of 6 inches above road surface

Table 25.4.10



25 4 11      Horizontal Alignment

Vertical and horizontal alignment must be reviewed together to assure that the necessary balance of standards is realized and the combination is both safe and pleasing

The designer should review the alignment to identify that the existing alignment generally adheres to the following guidelines

- consistent with no sudden changes from easy to sharp curvature
- sufficient tangent length between reverse curves
- superelevation transitions provided
- maximum curvature is not used  
on high fills or elevated structures,  
at or near crest in grade,  
at or near low points in grade,  
at the end of long tangents,  
at or near intersections or points of access or egress,  
at or near decision points

When any of the above conditions do not exist, the designer should evaluate for hazardous conditions and determine if corrective measures are warranted

25 4 11 1      Horizontal Curves

Horizontal curves shall be reviewed for horizontal curvature and superelevation. Every practical attempt shall be made to upgrade curves which are below State Highway System (SHS) minimum values. Review horizontal curves against the values in Table 25 4 11. Curves which do not meet the SHS values must be evaluated further as follows

- a) Horizontal Curvature - Horizontal curves that do not meet the RRR minimum curvature values must be reconstructed. Sufficient time and budget must be programmed into the RRR project to obtain any right-of-way necessary for reconstruction of the curve.
- b) Superelevation - Horizontal curves which equal or exceed RRR minimum curvature values but are below SHS minimum curvature values shall be reviewed for specific safety problems at the curve. This should include an on-site review for evidence of near accidents or operational problems. Accident history at the curve shall be evaluated. When warranted by the findings of the safety review, the curve must be reconstructed. When reconstruction of the curve is not warranted, as a minimum the following corrective measures shall be included in the plans:

Rural Curves - Any rural curve which does not meet the superelevation rate on Standard Index 510 shall be corrected to that rate. The curve should be re-evaluated and if appropriate, speed reduction signs included in the plans. Other measures which improve safety shall also be provided as appropriate. These may include wider lanes, wider shoulders, flattening steep front and/or back slopes, removing or relocating roadside obstacles, providing additional reflective markers and signing.

Urban Curves - Any urban curve which does not meet the superelevation rate on Standard Index 511 shall be corrected to that rate by reconstruction of the curve, or curb adjustment to accommodate overbuild, if practical. Other measures which improve safety at the curve shall be provided as appropriate. These may include removing or relocating roadside obstacles, providing additional reflective pavement markers and signing. The curve shall be evaluated considering any correction to the superelevation rate to determine when speed reduction signs are required.

**SAFE CRITERIA FOR STATE HIGHWAY SYSTEM  
WITH MAXIMUM SUPERELEVATION**

DESIGN SPEED	$e_{max} = 0.10$				$e_{max} = 0.05$			
	SHS		RRR		SHS		RRR	
	$D_{max}$	$R_{min}$	$D_{max}$	$R_{min}$	$D_{max}$	$R_{min}$	$D_{max}$	$R_{min}$
30	24°15'	231	30°30'	188	20°00'	286	25°45'	223
35	17°45'	323	20°45'	276	14°15'	402	17°15'	332
40	13°15'	432	14°45'	388	10°45'	533	12°15'	468
45	10°15'	559	11°00'	521	8°15'	694	9°00'	637
50	8°15'	694	8°30'	674	6°30'	881	6°45'	849
55	6°30'	881	6°45'	849	N/A	N/A	N/A	N/A
60	5°15'	1,091	5°30'	1,042	N/A	N/A	N/A	N/A
65	4°15'	1,348	4°30'	1,273	N/A	N/A	N/A	N/A

NOTE      Speed in Miles per Hour  
              Curves in Degrees and Minutes  
              Radius in Feet

**Table 25.4.11.1**

25 4 11 2      Stopping Sight Distance

Stopping sight distance shall be provided for all horizontal curvature in accordance with Table 25 4 11 2

<u>DESIGN SPEED (MPH)</u>	<u>STOPPING SIGHT DISTANCE (FEET)</u>
30	165
35	200
40	240
45	280
50	325
55	370
60	420
65	455

**Table 25.4.11.2**

25 4 12 Stopping Sight Distance

Stopping sight distance requirements are provided in Sections 25 4 10, Vertical Alignment and 25 4 11, Horizontal Alignment

25 4 13 Vertical Clearance

The following clearances apply to highway bridges and other roadway features over the entire roadway Entire roadway includes lanes and shoulders

Underpass Clearance - For roadways passing under existing bridges, vertical clearance shall be at least 14 feet over the entire roadway Signing and warning features shall be provided whenever vertical clearance is less than 14 feet, 6 inches

Signs and Traffic Control Devices - Clearances shall be provided consistent with new construction standards

Bridges - Vertical clearance requirements are provided in Section 25 4 25 4

25 4 14      Horizontal Clearance

Horizontal clearance shall provide sufficient lateral distance from the roadway (travel lanes and shoulders) for vehicles to utilize these features without the possibility of contact damage. While closely related, clear zone and border width requirements are separate issues which are addressed in Sections 25 4 15 and 25 4 16.

New construction horizontal clearance criteria shall be used for RRR projects.

25 4 15      Clear Zone

Clear Zone requirements are outlined in Table 25 4 15. Any obstruction located within the clear zone should be removed, shielded or made crashworthy. See Chapter 4 of this volume.

CLEAR ZONE WIDTH (FEET)					
R U R A L			U R B A N C & G		
DESIGN SPEED (MPH)	TRAVEL LANES & MULTI-LANE RAMPS	AUXILIARY LANES & SINGLE LANE RAMPS	DESIGN SPEED (MPH)	ALL OUTSIDE LANES	ALL MEDIAN LANES
< 45	6	6	< 50	4	6
45 (6)	14	8			
>45	18	8			

Table 25 4 15

GENERAL NOTES

- 1 When relocation is required to meet minimum clear zone requirements, consideration should be given to providing new construction clear zone widths
- 2 Rural clear zone widths are for side slopes 4 1 and flatter For steeper slopes, provide a clear runout area at toe of fill according to Section 4 1 2 and EX I-4-A, of this volume
- 3 Clear zone widths shall be adjusted on the outside of horizontal curves with flush shoulders in accordance with Standard Index 700, Sheet 2 of 2
- 4 Clear zone width is measured as follows
  - (a) on facilities without curbs - from the edge of the traffic lane
  - (b) on facilities with outside curbs - from the face of the outside curb
  - (c) on facilities with median curbs - from the edge of the inside traffic lane
- 5 On projects where the 4' width can not be reasonably obtained and other alternatives are deemed impractical, the width may be reduced to 2 5 feet Documentation is required in the project design file
- 6 May be reduced to <45 MPH widths if conditions more nearly approach those for low speed (40 mph or less)

25 4 16      Border Width

The minimum border width shall be the greatest of the following

- The border width used in the original project,
- The border width required to satisfy ADA accessibility standards,
- 8 feet

When right of way is being acquired for other reasons, the minimum border width shall be that used for new construction projects, however, the minimum length of wider border width shall be a segment of sufficient length to provide reasonable continuity

25 4 17      Intersections

Intersections shall be evaluated to determine those that need a traffic engineering study  
The following items should be considered

- Addition of right and left turning lanes
- Realignment of intersection
- Adequate turning radii for left and right turning lanes
- Use of channelization to reduce excessive areas of conflict at large intersections
- Placement of crosswalks as related to sidewalks and stop bars
- Locations of pedestrian facilities
- Locations of utilities, signal poles, controller cabinets, lighting poles and drainage structures as related to sidewalks and curbcut ramps
- Warrants for traffic control systems
- Installation of buried conduit for future traffic control systems
- Lighting for intersection illumination
- Adequate sight distance
- ADA needs

25 4 18      Drainage

The designer or drainage specialist must evaluate the hydraulic and physical adequacy of the existing drainage system. This requires examination of the existing drainage in the field and by consulting with maintenance personnel and records. If there are apparent problems with the existing drainage system, additional evaluation is required to determine the extent and type of improvements necessary to upgrade the system. The Drainage Manual contains design criteria and methods which provide guidance in formulating suitable drainage features, either through modification or replacement.

Prior to selecting any plan of highway improvement, the designer should consult with drainage and environmental permitting specialists since almost all roadway modifications reduce storage and infiltration and increase discharge rates and volumes. Stormwater retention and detention for quality, rate and volume may be required. Theoretical evaluation of proposed changes to existing and new drainage features necessary to correct operational deficiencies should be referred to a drainage specialist. The drainage specialist will provide the necessary drainage design, flood data information, Storm Water Pollution Prevention Plan (SWPPP) and any stormwater permit computations.

25 4 19      Pedestrian and Bicyclist Needs

Many existing corridors do not provide for pedestrian or bicyclist needs. Whenever a RRR project is undertaken, pedestrian and bicyclist needs must be addressed. Recommendations by the District Bicycle/Pedestrian Coordinator shall be obtained. Local government contact in developing these recommendations is essential. This should be part of the project scoping and programming effort.

Pedestrian Needs

I-25-27 0

Approved October 7, 1993



Sidewalks - Upgrading sidewalks to meet ADA accessibility standards shall be included

Medians - Medians shall be evaluated to determine if modifications such as pedestrian refuge sections are necessary. 5-lane and 7-lane sections are restricted or eliminated under current policy, usually by the introduction of a raised or restrictive median, which enhances the opportunity to accommodate pedestrian needs. Traffic separators with a width sufficient to provide refuge should be used at intersections where possible. When adequate pedestrian refuge cannot be provided at the intersection, mid-block islands should be provided.

Design details for disability access features including sidewalk, curb cuts and ramps are found in the Roadway and Traffic Design Standards. Additional standards for ADA are found in the regulations and design guidelines issued by the Secretary of the U.S. Department of Transportation.

Bicyclist Needs - Features to provide for identified bicycle traffic needs must be incorporated into the project or as a planned off-system route. Design criteria for bicycle lanes are found in Chapters 2 and 8 of this volume. For existing curbed sections where no widening is planned, consideration should be given to reducing lane widths, e.g. 11 foot through and 10 foot turn lanes on sections with 14 or 15 foot wide lanes.

#### 25.4.20 Utilities (Underground and Overhead)

Where utilities are involved on RRR projects, the clear zone criteria in this chapter, the Utility Accommodation Guide, and Chapter 5 of this volume shall be followed.

Relocation or adjustment is required if (a) the minimum clear zone requirements are not met or (b) the utility system conflicts with proposed RRR improvements and sufficient right-of-way is available

25 4 21 At-grade Railroad Crossings

When highway improvements are undertaken that include at-grade railroad crossings, the physical and operational characteristics shall be reviewed and upgraded to meet minimum standards. Recommendations shall be made by the District Railroad Coordinator for incorporation into the project.

25 4 22 Aesthetics and Landscaping

Landscaping, including median and intersection treatment, shall be consistent with Standard Indexes 546 and 700.

25 4 23 Highway Lighting

Lighting may be installed at specific locations to improve safety. For example:

- Reducing the effects of ambient light conditions,
- Busy or high accident intersections,

- Bus stops,
- Channelized intersections,
- Car pool parking lots,
- Pedestrian and bicycle crossings,
- Ramp terminals

Any lighting, existing or proposed, shall be reviewed by the District Lighting Engineer to determine specific needs. Lighting shall meet new lighting criteria, found in Chapter 7 of this volume.

25.4.24 Highway Traffic Control Devices

The need for updating traffic control devices such as signals, signing, and pavement markings must be reviewed by the District Traffic Operations Engineer (or staff). This review shall identify those features which require updating to be in accordance with the Manual on Uniform Traffic Control Devices, the Manual on Uniform Traffic Studies, the Department's Roadway and Traffic Design Standards, and the ADA design guidelines issued by the Secretary of the U.S. Department of Transportation.

25.4.25 Bridges

On each project, a determination must be made as to whether an existing bridge should remain as is, be rehabilitated or be replaced. The decision shall be made based on an assessment of the bridge's structural and functional adequacy for the type and volume of traffic over the structure's design life.

Any structure which has been identified and is scheduled for replacement in the 5 year work program should be considered for an exception (or variance) from widening or rail retrofit. A detailed accident history must be included in the justification.

25 4 25 1 Bridge Loading

Bridges shall have an Inventory Load Rating equal to or greater than the following load requirements

TYPE	LOAD REQUIREMENT
Collector Facilities	HS-15
Arterial Facilities	HS-20

25 4 25 2 Bridge Width

Bridges shall meet or exceed the following clear width criteria. If lane widening is planned as part of the RRR project, the minimum useable bridge width shall be determined using the width of approach lanes after widening

<u>Design Year ADT</u>	<u>Minimum Usable Bridge Width (feet)</u>
UNDIVIDED	
0 - 750	Total width of approach lanes + 4
751 +	Total width of approach lanes + 8
DIVIDED	
ALL	Total width of approach lanes + 5.5 (median separator) *
	Total width of approach lanes + 6.5 (median barrier wall)**
	* 1.5 feet median and 4 foot outside shoulder
	** 2.5 feet median and 4 foot outside shoulder

If widening is required, it shall be in accordance with the Structures Design Guidelines and meet the geometric requirements for new construction

### 25 4 25.3 Bridge Railing

Bridge railing shall be both structurally and functionally adequate Bridge railing which will not contain vehicles is considered structurally inadequate Bridge railing which will not redirect vehicles without snagging or vaulting is considered functionally obsolete

All safety shape rails, New Jersey or F-Shape, are structurally and functionally adequate All other former FDOT standard bridge rail designs are inadequate

Only when it is determined appropriate for an existing inadequate handrail to remain in place may the details provided by Schemes 1 and 19 in Standard 401 be considered Refer to the General and Design notes on Sheet 1 of that Standard Other retrofit concepts may be used when judged to meet performance expectations

Rails to be replaced shall be designed using the criteria in the Structures Design Guidelines

### 25 4 25 4 Vertical Clearance

The following clearances apply to existing bridges to remain or be modified only Replacement structures shall be to new construction standards

Underpassing Clearance - Vertical Clearance for roadways passing under existing bridges shall be at least 14 feet over the entire roadway The existing vertical clearance shall not be reduced by the RRR project if the existing clearance is 16 feet or less

Low Member Clearance - Existing bridges with sway bracing members over the bridge deck shall have at least 14 feet clearance over the entire roadway

Signing and warning features shall be provided whenever vertical clearance is less than 14 feet, 6 inches

25 4 25 5 Considerations

When evaluating bridge replacement or widening, the following should be considered

- a Cost of replacing the existing bridge with a wider bridge designed to new bridge criteria,
- b Cost of widening the existing bridge (if widening is practical), including life cycle costs of maintaining a widened bridge,
- c The number of accidents that would be eliminated by replacement or widening,
- d The hydraulic sufficiency and the risk of failure due to scour and/or ship impact as well as the consequences of failure

## **25.5 Design Exceptions and Variances**

Every effort should be made to adhere to the desirable criteria stated herein. However, under unusual conditions, it may be necessary and appropriate to use values that are less than the minimum values shown. If lesser values are proposed for use, these shall be identified and the necessary approval and concurrence obtained at the earliest possible time and but not later than Phase II, so that the denial of any such request will not alter the project letting date. Refer to Chapter 23 of this volume for the necessary procedure.

Approved October 7, 1993

I-25-34 0

---

## APPENDIX A

### GLOSSARY OF TERMS

AADT	Average Annual Daily Traffic.
ADE	Area Design Engineer
ADT (two way)	Average Daily Traffic.
Approach Slab	A section of a roadway adjacent to, and at the end of a bridge, requiring special design and construction considerations.
Arterial	A general term denoting a highway primarily for through traffic, usually on a continuous route.
A-2 or A-3 Material	Materials consisting of sands deficient in coarse materials and soil binder.
A-8 Material	A national classification of a type of unsuitable material.
Base course	The layer or layers of specified or selected material of design thickness placed on a subbase or subgrade to support a structural course.
Baseline	An accurately measured line from which the position of other points may be determined, or on which a survey may be based.



Benchmark	A relatively permanent object, natural or artificial, bearing a marked point whose elevation above or below an adopted datum is known.
BHRS	Bridge Hydraulic Recommendation Sheet.
Bifurcated Section	A section of a divided roadway separated by a very wide area of natural ground.
Border Width	A term usually used in conjunction with urban roadway cross section denoting the width of cross section from the face of curb to the right-of-way.
Borrow or Borrow Material	Material excavated from designated areas for use as 'fill'.
Borrow Pit	An excavation site outside the limits of a roadway for producing material necessary for roadway construction.
Bridge Culvert	Culverts whose dimensions exceed a 20' distance measured along project centerline between the inside faces of exterior walls..
Bulkage	Increase in soil volume due to manipulation.
CADD	Computer Aided Design and Drafting.

Catagorical Exclusion:	Projects that may be excluded from the Environmental Impact Process due to the type of work involved - example resurfacing projects.
Centerline	The axis along the middle of a road or other facility from which features can be conveniently measured.
CES	Cost Estimating System - The Department's program for estimating construction costs for projects.
Channelization	Usage of traffic islands and other devices to direct traffic into definite paths.
Clear zone	A traversable and unobstructed roadside area available for errant vehicles to safely regain control.
Clearing and Grubbing	Process of clearing the roadway construction site of unwanted features.
Collector	A general term denoting a roadway that links neighborhoods or areas of homogeneous land use with arterial streets.
Compound Curve	A curve consisting of two or more arcs of different radii curving in the same direction and having a common point.

Contract	A legal document stating the terms and conditions of an agreement between the Department and a private company to provide a service.
Contract Time	Number of calendar days allowed for completion of the contract, including authorized time extensions.
Contractor	An individual or company that undertakes to provide service specified in contract documents.
Control Radius	Radius by which a turning vehicle can maneuver with the least amount of difficulty.
Crest Vertical Curve	A convex parabolic curve providing a smooth transition between two grades.
Cross Slopes	Lateral slope given to the pavement to provide adequate drainage.
Cross Drain	A drainage structure utilized to convey water from one side of the roadway to the other, including median drains and culverts under intersecting streets.
Crown Line	The inside top of a culvert.
Culverts	A round or special shaped pipe or box used to convey water, especially under roadways or other facilities.

Curb Returns	The curved portion of the curb at which driveways and cross roads intersect with a roadway.
Cut	That portion of a road site where the formation has been excavated below ground level.
Datum	A known or measured point, line or plane to which others may be referred for vertical or horizontal control.
Delineator	Reflector units capable of clearly reflecting light under normal atmospheric conditions from a distance of 1000 feet when illuminated by the upper beam of standard automobile lights.
Design Speed	A speed determined for design and correlation of the physical features of a highway that influence vehicle operation.
Design Exception	Approved deviation from AASHTO or Department criteria.
Detention Area, Basins, and Pond	Drainage basins specially constructed and used to retard stormwater, discharging at a controlled rate for a specific period of time.
DHV	Design Hourly Volume - the traffic volume on which the functional design of a highway is based.

DPI	Ditch Point of Intersection of ditch grades.
Drainage Areas	The portion of the land surface which drains to a specific point, including paved areas, roofs and unpaved land.
Drainage Divides	The area of higher ground separating drainage areas or basins.
Driver Expectancy	A condition whereby drivers are conditioned, by encounters with repetitive features, to expect a certain driving environment. When that environment is provided, driver reaction is very predictable. When expectancy is violated, drivers may react slowly or improperly.
DHW	Design High Water elevation.
Earthwork	The excavation and filling required to construct embankment.
EIS	Environmental Impact Statement
Embankment	The constructed earth fill and excavation built to carry a road.
ESAL	Equivalent single axle load.
Esthetics	Visual impact of the roadway environment on drivers and other vehicle occupants.

Excavation	Removal of all materials of whatever nature to complete earthen cuts, ditching, sub-excavation and borrow pits.
Exceptions	Those portions of the roadway within the project limits that are excluded.
Fill	A portion of the proposed cross section which falls above the existing groundline and indicating volume of fill.
Flow Line	The inside low point or lowest line of water flow in an open gutter, swale, ditch or other drainage element.
Freeway	An expressway with fully controlled access - the highest type of arterial highway.
Friction Course	The top layer of an asphalt pavement to provide resistance to skidding, traffic abrasions and the disintegrating effects of climate.
Functional Classification	Classification of highways by design types based on the major geometric features.
F.A.	Federal Aid - used in conjunction with projects having Federal Aid funds.
Geometrics	Visible elements of a roadway, such as alignment, grades, sight distances, widths, slopes, etc.

Grade	A rate of rise or fall on any length, with respect to horizontal.
G.M.	Gross Mile.
High mast	Free standing poles or towers of height 80' or more utilized for highway lighting to provide uniform, and glare free, light distribution over large areas of highway.
30th Highest Hourly Volume	The hourly volume that is exceeded by 29 hourly volumes during a designated year.
Imagery	Visible representation of characters, line drawings and symbols.
K, D and T Values	K: Ratio of DHV to ADT. D: Directional distribution of DHV expressed as a percentage. T: Percentage of trucks, inclusive of light delivery, expressed as percentage of DHV.
Lane Taper	Divergence of lane edge for the purpose of adding or dropping lanes.
Lane Transition	Lateral shift of a travel lane.
Lateral Ditch	A ditch which runs more or less perpendicular to the centerline of roadway.

LBR	Limerock Bearing Ratio - specifies load bearing capacity of the material, as related to that of limerock.
Level of Service:	A qualitative rating of the effectiveness of a highway in serving traffic, measured in terms of operating conditions.
Leveling Course	One or more layers of asphalt mix used to restore a distorted existing pavement to a uniform cross section and an acceptable level of rideability.
Limited Access R/W	The Right-of-Way wherein the right of owners or occupants of abutting land, or other persons to access a highway facility is limited to designated points, such as interchanges.
May	Permissive condition.
MUTCD	Manual of Uniform Traffic Control Devices.
MUTS	Manual on Uniform Traffic Studies.
Mylar	Polyester film used as reproducible drafting media.
National Sign Code	Code numbers assigned to standard road signs.
N.M.	Net mile.



Overbuild	Multiple layers of asphalt mix used to build up one side of an existing crown to provide a uniform cross-slope.
Overland Flow	Diffused surface flow of water.
Overlay	The construction of a structural course and, if necessary, leveling course and overbuild course, to increase the source life and improve the rideability of an existing pavement.
Overtopping Elevation	Elevation at or above which water will flow over a structure, the highway grade or a drainage divide.
Pavement Design	Description of the types and thicknesses of various layers constituting a pavement structure.
Pay Item Number	Number assigned by the Department to construction components for pay purposes.
PC Station	Point of Curvature Station - station at the beginning of a horizontal curve.
PD & E Study	Project Development and Environmental Study.

Photogrammetry	Photographic process of topographic mapping using stereographic plotters.
PID	Plans In District.
PI Station	Station of the Point of Intersection of two tangents.
Plans	The approved plans, including reproductions thereof, showing the location, character, dimensions and details of the work to be done.
Posted Speed	Regulatory speed limit established in accordance with department policy and posted on the roadway.
Profile Grade Line	A longitudinal line which controls the vertical geometry of the project, usually the inside edge of a divided highway or the centerline of an undivided highway.
Profile Grade Point	A specific point along the Profile Grade Line.
PS & E	Plans, Specifications and Estimate.
PT Station	Point of Tangent Station - station at the termination of a horizontal curve and at the beginning of the tangent.

Quality Assurance	Is all planned and systematic actions necessary to provide adequate direction so that all resulting design products can meet predetermined requirements. This includes the establishment of design policies, procedures, standards, guidelines, training and monitoring for compliance.
Quality Control	Following established design policies, procedures, standards and guidelines in the preparation of all design products. This includes the checking and review of individual designs for compliance and good engineering practice.
Ramp	That portion of the traveled way connecting two roadways at a grade separated intersection.
Range	An area of 36 square miles enclosed between nationally established survey lines running north-south, six miles apart, and township lines.
Recovery Area	See "Clear Zone".
Reference Points	One of several fixed objects for which measurements are made to enable a point to be accurately located.

Resurfacing	A supplemental or replacement surface placed on an existing pavement to improve its surface or increase its strength.
Retention Area, Basin or Pond	A drainage facility designed to retain runoff without a direct outlet discharge structure.
Returns	That extension of the roadway which allows entrance and exit to sidestreets, parking lots, etc.
Reverse Curve	A combination of two horizontal curves in opposite directions with a common tangent.
3R	Resurfacing, Restoration, Rehabilitation of a roadway.
R/W	The areas, existing or acquired by permanent easement, for highway purposes.
Sag Vertical Curve	A concave parabolic curve providing a smooth transition between two grades.
Section Lines	Established survey grid lines enclosing approximately a one mile square area of land.
Shall	Mandatory condition.
Shop Drawings	Detailed drawings of elements requiring special fabrication.

Should	Advisory condition.
Shoulder	The portion of the roadway contiguous with the traveled way and used for lateral support of base and surface courses, emergencies and safe recovery of errant vehicles.
Shrinkage	Reduction in volume of soil mass.
Sidedrain	A drainage structure placed more or less parallel to the centerline of a roadway for conveyance of water under driveways, and other such obstructions.
Soil Survey	The exploring and recording of soil types and conditions.
Special Ditch	Roadside ditch whose dimensions do not conform to those shown on the typical section.
Special Provisions	Special directions, provisions or requirements peculiar to the project under consideration and not otherwise thoroughly or satisfactorily detailed or set forth in the specifications.
Specifications	Document containing the directions, provisions, requirements and stipulations relating to the method and manner of performing the work.

Speed Change Lanes	Special lanes provided for the use of accelerating or decelerating vehicles.
Station Equations	Station along an alignment where the numerical continuity is broken.
Storm Sewer or Storm Drain	Pipe system or portion thereof used to collect or convey storm water runoff.
Stabilizing	Process by which the subbase is brought up to a bearing value sufficient to support the base.
Structural Course	One or more layers of asphalt mix placed to provide the major structural component of the pavement or to increase the service life of an existing pavement.
Subbase	The layer or layers of specified or selected material of designated thickness placed on a subgrade to support the basecourse.
Subgrade	The top surface of a roadbed upon which the pavement structure and shoulders are constructed.

Superelevation	A tilt given to a road at a horizontal curve to counteract the effect of centrifugal force.
Superelevation Transition	Transition of a cross section from normal cross slope to full superelevated cross slope, or vice versa.
Surface Course	One or more layers of a pavement structure designed to accommodate traffic load.
Survey Reference Points	Same as reference point.
Template	The sum of elements of widths, depths and cross slopes which define the roadway cross section.
Topography	Representation, on a plan, of the existing physical features in an area.
Township	An area of 36 square miles enclosed between nationally established survey lines running east-west, six miles apart, and range lines.
Travelway	The portion of the roadway for the movement of vehicles, exclusive of shoulders and auxiliary lanes.

Traversable	Crashworthy roadside conditions that would allow an errant vehicle to regain control without serious damage.
Turning Radius	Outside wheel path of a turning vehicle.
Typical Section	Shows the design elements for the cross section of a proposed roadway.
Underdrains	A subsurface drainage system.
Unsuitable Material	Types of dirt that are classified unsuitable for roadway construction.
Value Engineering	An analysis of materials, processes and products in which functions are related to costs and from which a selection may be made for the purpose of achieving the required function at the lowest overall cost consistent with the requirements for performance reliability and maintainability.
Vellum	Translucent paper used as reproducible drafting media.
Vertical Curve	A parabolic curve used to give smooth transition between tangent grade-change.



Weaving Movement

The crossing of traffic streams moving in the same general direction, accomplished by merging and diverging.

W.P.I. Number

Work Program Item number (assigned by the Department).

## INDEX

### VOLUME I

#### PLANS PREPARATION AND ASSEMBLY

3R Design	1-5, 13-5
3R Projects	16-2
Accident Data	14-6
Advance Warning Arrow Panels	10-20
Advisory Speeds	10-55
Aesthetics	1-9
Architectural Plans	22-1
Area Design Engineer	17-2
Auxiliary Lanes	2-8
Bicycle Facilities	8-1, 8-5
Bicycle Lanes	2-8
Bicycles	8-1
Border Width	2-14
Borrow	3-1, 3-2
CADD	20-9
Canals	4-5
Capacity	1-3
CES	18-1
Channelizing Devices	10-25
Clear Zone	4-1
Clearing and Grubbing	3-6
Codes	22-3
Comprehensive Planning	22-5
Consultant Design	13-8
Consultants	17-3, 21-1
Contract Administration	21-4
Contract Documents	22-35
Contract Time	18-2
Controller Timing	7-16
Crash Cushions	4-16, 10-28
Cross Sections	2-23, 2-28, 2-35
Cross Slopes	2-14
Crossing Surfaces	6-3
Data Collection	14-1
Design Consistency	1-6
Design Plans	15-2, 16-1
Design Parameters	1-1
Design Speed	2-2
Design Standard Ranges	2-2
Detours	10-47

Ditches	2-14
Driver Expectancy	1-6
Drop-offs	10-49
Earthwork	3-1
Embankment	3-1
End Treatments	4-9, 10-28
Environmental Documents	14-5
Final Design	13-3
Final Dressing	3-6
Five Year Work Program	13-1
Fixed Standards	2-1
Flaggers	10-31
Friction Course	2-12
Functional Classification	1-4
Geometrics	2-31
Handicap Access	8-4
Horizontal Alignment	2-17
Horizontal Curves	2-17
HVAC	22-26
In-house Design	13-7
Interchanges	2-24
Intersections	2-24, 7-19
Landscaping	9-1
Lane Closure Analysis	10-35
Lane Widths	2-4, 10-35
Layouts	10-32
Left Turns	7-16
Level-of-Service	1-3
Lighting	7-6
Limited Access	2-25
Mailbox Supports	4-20
Marking	7-2
Median Barriers	4-15
Original Plans	14-6
Passing Sight Distance	2-3
Pavement Design	14-5, 15-13
Pavement Marking	10-26
Pay Items	11-1, 18-1
PD & E Studies	1-2, 10-3, 13-2
Pedestrians	8-1
Permits	15-13, 22-6
Plans Processing	17-4
Plans Review	16-1
Plan Revisions	20-1
Pole Design	7-8
Profiles	2-26, 2-32
Project Concept Report	21-2
Project Cost	14-2
Project Description	14-1
Project Development	13-1
Project Letting	13-3

Project Number	14-2
Project Scheduling	13-9, 14-2, 21-4
Quality Assurance	17-1
Quantities	11-1
Railroad Crossings	6-1
Ramp Widths	2-8
Regulatory Speeds	10-51
Right-of-Way	12-1, 15-15
Roadside Barrier	4-8
Rural Projects	2-26
Scope of Services	21-2
Sewage	22-5
Shoulder Widths	2-9
Side Slopes	2-14
Sidewalks	8-2
Sight Distance	10-34
Sign Supports	4-19
Signal Preemption	7-19
Signing	7-2
Signing and Sealing	19-1
Signs	10-17
Specifications	11-1
Speed Zoneing	10-51
Stop Line	7-15
Stopping Site Distance	2-3
Structural Clearances	6-4
Structural Plans	15-5
Submittals	15-1
Subsoil Excavation	3-6
Superelevation	2-22, 10-34
Surveys	14-3, 15-8
Taper Lengths	10-32
Temporary Barrier Walls	10-27
Through Lanes	2-4
Traffic Barriers	10-27
Traffic Control Devices	7-1, 10-16
Traffic Control Plan	10-5, 10-8
Traffic Data	1-2, 14-5
Traffic Signals	10-24, 7-14
Training	10-14
Transitions	2-5, 2-20, 4-11
Truck-Mounted Attenuator	10-29
Typical Sections	15-8
Underdeck Lighting	7-9
Urban Projects	2-30
Utilities	5-1
Utility Coordination	5-8
Utility Relocation	5-2
Value Engineering	15-17
Variable Message Signs	10-21

Verification of Utilities	5-4
Vertical Alignment	2-21
Warning Lights	10-19
Wide Curb Lanes	2-6
Work Zone Traffic Control	10-1
Zoning	22-5