

**MEMORANDUM**

DATE: December 8, 1992

TO: Plans Preparation Manual Owners

FROM: Linda Seigle, Roadway Design Documents and Training

COPIES:

SUBJECT: REVISIONS TO THE 1989 PLANS PREPARATION MANUAL

Enclosed are the revisions to the Plans Preparation Manual that were reviewed by the District Design Engineers in their December 1992 meeting. The revisions were approved with recommended editorial changes. These changes were incorporated into the revisions. The major changes made are as follows:

- Volume I, was revised to reflect the elimination of the design checklists (previously contained in the Roadway and Construction Training Aids Manual) and the change of terminology from 30%-60%-etc to Phase I, Phase II, etc
- Volume I, Chapter 2 was revised as a result of publication of the new Drainage Manual
- Volume I, Chapter 3 was revised to add a new pay item and to revise terminology
- The above changes are also reflected in Volume II
- Volume II, Chapters 7 & 10 were revised to add new pay item and plan notes

Included with the revisions is a list of the pages revised, with a brief description of the section revised. All revised sheets except indexes have been reprinted.

Plans Preparation Manual Revisions
December 8, 1992
Page 2 of 2

Also included with these Plans Preparation Manual revisions
are copies of Special Provisions modifying the Roadway and Traffic
Design Standards

Attachments

VOLUME I

Table of Contents and List of Exhibits
Updated and reprinted

Page xvi

Revised to delete 2 FDOT publications that are no longer available
Design & Construction Training Aids Manual
Transportation Engineering Quality Assurance Plan

Pages I-2-27 0 - 29 0

Revised to add design high water clearances that are not in the new Drainage Manual on page 27, the other pages are reprinted due to re-pagination

Page I-2-33 0

Revised to show minimum gutter grade of 0.3% in accordance with Drainage Manual

Chapter 3

The pages revised are due to the addition of the pay item for Regular Excavation (3-R Projects) and removal of "shrinkage" and "bulkage" terminology

Chapter 10

Revised lane closure analysis to use highest PMF due to lack of knowledge of actual month of lane closure (This revision was approved at the June Design Engineers Meeting and was distributed with the meeting minutes, but has not been transmitted to all PPM holders)

Pages I-14-7 0 - 10 0

Revised to change terminology from 30%, 60%, etc to Phase I, Phase II, etc

Chapter 15

Changes due to elimination of design checklists and change to Phase I, etc terminology

Chapter 16

Revised due to elimination of design checklists

Page I-18-2 0

Revised due to change to Phase I, etc

Page I-20-4 0

Revised to add components to Contract File

Page I-20-7 0

Revised to indicate non-CA, non-exempt projects (those with continued FHWA review)

Page I-20-22 0

Changed to require S&S copies of revisions made during construction to be sent to the responsible professional engineer rather than the District Design Engineer

VOLUME II

Page II-1-2 0

Revised to show grades on plans to 3 decimal places rather than 4

Page II-1-10 0

Added information on use of Regular Excavation - Lump Sum

Chapter 2

Revised due to change in terminology to Phase I, etc , and due to elimination of design checklists

Page II-5-1 0

Revised to allow rural non-interstate drainage maps to be at same scale as rural interstate

Page II-7-4 0

Added pay item note to be used when minor sections of a project are restricted to black base and pay item note for geogrid

Page II-10-1 0

Added paragraph on true scale for CADD produced plans

Page II-10-12 0

Revised to show percent of grade to 3 decimal places

Page II-10-18.0

Added plan note regarding treatment of driveways under Access Management (Voids Design Bulletin 92-5)

B0050036.D01

REVISIONS TO ROADWAY AND TRAFFIC DESIGN STANDARDS. () (REV 2-11-93)

INDEX NO. 199 (Sheet 1 of 1) - Geotextile Criteria is deleted and INDEX NO. 199 (Sheet 1 of 1) - Geotextile Criteria, attached hereto, is substituted.

INDEX NO. 200 (Sheet 1 of 2) - GENERAL NOTES: The text of General Note No. 9 is deleted and the following substituted:

Except for precast circular units manufactured under ASTM C76 or ASTM C78, all steel bars shall have 1 1/2" minimum cover unless otherwise shown. Horizontal steel splices in rectangular structures shall be lapped a minimum of 24 bar diameters.

INDEX NO. 200 (Sheet 2 of 2) - The tabular chart for WALL DESIGNS-RECTANGULAR STRUCTURES is expanded as follows:

(a) An asterisk is added to the subheading SIZE 3'-6", (b) The following asterisk notation is added "Precast structures 3'-6" x 3'-6" may be cast with 6" thick walls for structures with depths of 15 feet or less", and (c) The following footnote is added, "SIZE is the inside length of a structure wall".

INDEX NO. 201 (Sheet 2 of 6) - The TYPE 7-T (TRAFFIC) (H-20) Manhole Top is deleted and the TYPE 7 Manhole Top as detailed on the modification to Index No. 201, attached hereto, is substituted.

INDEX NO. 201 (Sheet 3 of 6) - OPTIONAL CONSTRUCTION JOINTS. The text of Note No. 5 is deleted and the following substituted: Minimum cover on reinforcing bars is 1 1/2".

INDEX NO. 205 (Sheet 4 of 4) is deleted and the INDEX NO. 205 (Sheet 4 of 4), attached hereto, is substituted.

INDEX NO. 249 (Sheet 1 of 1) - All reference to Index No. 274 and data (bottom line of chart) is deleted.

INDEX NO. 272 (Sheet 6 of 6) - General Note No. 11. The last line is deleted and "for Mitered End Section (BO), Each" is substituted.

INDEX NO. 273 (Sheet 6 of 6) - General Note No. 7. The text is deleted and the following substituted: "In addition to the requirements of 430-4, side drain culverts shall comply with the cover requirements of Index No. 205."

INDEX NO. 280 (Sheet 4 of 4) - EXTRA BASE FOR CROSS BOX CULVERTS UNDER FLEXIBLE PAVEMENT, ASPHALTIC CONCRETE BASE. The following sentence is added: "The cost of furnishing and installing the coarse aggregate and filter fabric shall be included in the cost of

the box culvert."

INDEX NO. 282 (Sheet 1 of 1) - INLET TYPE C (MODIFIED). Note No. 3 is expanded by the following: "Handrail to be paid for at the contract unit price for Pipe Handrail, LF."

INDEX NO. 301 (Sheet 1 of 1) - Expanded to include double left turn lanes per DOUBLE LEFT TURN LANES (FULL SHADOW) details, attached hereto.

INDEX NO. 304 (Sheet 2 of 2) - GENERAL NOTES. General Notes Numbers 1, 2, 4, and 5 are deleted and the following notes are substituted:

1. Curbed facilities with sidewalks and those without sidewalks are to have curb cut ramps constructed at all street intersections and at turnouts that have curbed returns. Partial curb returns shall extend to the limit prescribed by Index No. 515 to accommodate curb cut ramps.

2. The location and orientation of curb cut ramps shall be as shown in the plans.

4. The ramps shall have a detectable warning surface. The detectable surface shall be an integral part of the ramp and can be either built in or applied. The detectable surface shall not be constructed on the transition slopes (side slopes) unless called for in the plans.

Detectable warnings shall consist of raised truncated domes with a diameter of nominal 0.9 inch (23mm), a height of nominal 0.2 inch (5mm) and a center-to-center spacing of nominal 2.35 inches (60mm) and shall contrast visually with adjoining surfaces, either light-on-dark, or dark-on-light.

5. When crosswalk markings are required, curb ramp locations and orientations are to be coordinated with markings shown in the plans.

INDEX NO. 305 (Sheet 1 of 5) - LONGITUDINAL JOINTS, TIE BAR SPACING. The following notation is added below the table: "Tie bars are deformed NO. 4 or NO. 5 reinforcing steel bars meeting the requirements of Section 931."

INDEX NO. 439 (Sheet 1 of 4) - General Note No. 13. The last line is deleted and "price for Impact Attenuator, Vehicular (GREAT) (TEMP), Each" is substituted.

INDEX NO. 500 (Sheet 1 of 2) - The following Design Note is added:

DESIGN NOTE:

At locations where muck or other soft soil deposits persist to such depth that removal is impractical, the construction of a geogrid foundation over those soils should be considered. The Engineer of Record should request guidance from the District Geotechnical Engineer and solicit geogrid foundation designs from geogrid manufacturers when pursuing geogrid alternates.

INDEX NO. 510 (Sheet 1 of 2)- Chart at the bottom center of the sheet. The two values "0.21" are deleted and "0.021" are substituted.

INDEX NO. 514 (Sheet 1 of 2)- OPTIONAL BASE GROUP AND STRUCTURAL NUMBERS. The column headed " ABC-1" and 4" Bank Run Coquina Subbase LBR 100 " is changed to " ABC-1" and 4" Bank Run Shell Subbase LBR 100 ".

INDEX NO. 514 (Sheet 2 of 2)- OPTIONAL BASE GROUP AND STRUCTURAL NUMBERS. These base types are for limited use and will be designated in the plans when allowed.

INDEX NOS. 600-651 SYMBOLS. The sentence, "Cones or Tubular markers may be used during daylight only" is changed to read, "Tubular Markers May be Used During Daylight Only."

INDEX NO. 600 (Sheet 3 of 10)- CHANNELIZING AND LIGHTING DEVICES and DROPOFFS IN WORK ZONES. Reference to "Sheet 5 of 9" is changed to "Sheet 5 of 10".

INDEX NO. 600 (Sheet 5 of 10)- OPTIONAL SHOULDER TREATMENT. Reference to "Slope 6:1 Or Flatter" is changed to "Slope 4:1 Or Flatter".

INDEX NO. 600 (Sheet 6 of 10)- TEMPORARY CURB, Note 3, first sentence: Delete "(asphalt curb only)".

INDEX NO. 600 (Sheet 7 of 10)- CONES detail. Delete notation "Cones To Be Used During Daylight Only" change minimum diameter for plastic drums to 18 inches in lieu of 24 inches.

Note 5: Revise to read, "During hours of darkness, warning lights shall be used on drums, vertical panels, Type I, Type II or Type III Barricades".

Add Note 9: "When used at night, cones shall:

1. Be used only in active work zones, such as milling and resurfacing or other moving operations where cones can be monitored.

2. Be 36 inches tall, with a minimum weight of 12 pounds and be reflectorized as per the MUTCD.

3. Be used only with Department approved reflective collars."

INDEX NO. 600 (Sheet 10 of 10) -
APPLICATION.

CLASS D, Add: "Maximum spacing 5' center to center".

CLASS E, Add: "Maximum spacing 5' Center to Center".

NOTES.

Note 1, Add: "Class A or B" before "RPM's".

Note 3, After the word paint in the first sentence, add:
"however, tape or paint must be used in all transition
areas"

Note 4, first line, Add: "and light Asphalt" after
"Concrete Pavement".

INDEX NO. 605 (Sheet 1 of 1) - General Note 4, first line: Add
"warning" before "signs".

INDEX NO. 607 (Sheet 1 of 1) - General Note 4: Add "The first two
warning" to beginning of note.

INDEX NO 608. (Sheet 1 of 4) - General Note 5: Add "warning" before
"signs".

Add Note 14: "Span wire signals are to be used only in active
work zones, where the contractor can monitor signal operation and
maintain traffic with flaggers in the event of a power failure."

INDEX NO. 608 (Sheet 3 of 4) - Top Center, under notation for "Side
Road": Change "See General Note No. 13" to see General Note No.
12."

INDEX NO. 608 (Sheet 4 of 4) - Bottom right of detail: Change "See
General Note No. 10" to "See General Note No. 9."

INDEX NO. 614 (Sheet 1 of 2) - DETAIL OF TEMPORARY ASPHALT
SEPARATOR. The notation "Entire Separator Shall Be Painted
Reflectorized Yellow" is changed to "Entire Separator Shall Be
Painted Reflectorized Yellow (included in cost of separator)".

INDEX NO. 9535 (Sheet 2 of 4 and 4 of 4) - SIGN COL & STUB COL
ELEVATION I-BEAM SHAPES. The 2x12 bevel is deleted; the slip plane
plates shall be fabricated normal to the I-Beam axis and the column
installed with the slip plane in the horizontal position.

INDEX NO. 11860 - Expanded as follows: The Gore Exit Panel (FTP-
31, Index 17355, Sheet 1 of 4), Sign Identification Number 88, can
be installed on a single column with the following stipulations:

1. Maximum height to bottom of sign is 14 feet.
2. Column size is 6" aluminum round tube with 1/4" wall.
3. 3 Type II Brackets require for attachment.

4. For Type II Bracket details, Attachment, and General Notes see Index No. 11860.

5. For Footing size and Slip Base Details, see Index No. 11863.

INDEX NOS. 11861 through 11864 (Sheet 1 of 1) - Note 4: "3 x 1/2" is deleted and " 3 1/2 x 3/16 " substituted.

SLIP BASE DETAILS table: Information for 3 1/2 x 3/16 column size is deleted.

Sign Post table, COL. SIZE 3 1/2 x 3/16: FOOTING dimension 1-6 x 2-6 is deleted and 0 x 2-6 substituted.

INDEX NO. 17302 (Sheet 1 of 1) - The sheet title is changed from "TYPICAL SECTIONS FOR ONE COLUMN SIGN PLACEMENT" to "TYPICAL SECTIONS FOR PLACEMENT OF SINGLE & MULTI-COLUMN SIGNS".

INDEX NO. 17346 (Sheet 1 of 8) - PAVEMENT ARROW AND MESSAGE DETAILS, Add the following areas: Thru arrow - 12 S.F., Left arrow - 16 S.F. and Combination arrow - 27 S.F.

INDEX NO. 17346 (Sheet 1 of 8) - PAVEMENT MARKINGS FOR INTERSECTIONS WITH MAJOR AND MINOR ROADS: Add note "Delineators optional."

INDEX NO. 17346 (Sheet 2 of 8) - PAINTED LEFT TURN STORAGE LANE(S) DETAILS. The notation "With each additional 50 ft. of turn lane add one arrow." is changed to "With each additional 100 ft. of turn lane, add one arrow."

INDEX NO. 17346 (Sheet 2 of 8) - PAINTED LEFT TURN STORAGE LANE(S) DETAILS, Add Note: "Pavement message 'ONLY' is not required for created (shadowed) turn lanes, single or dual, where the driver must exit the thru lane to enter a turn lane."

INDEX NO. 17346 (Sheet 3 of 8) - TYPICAL INTERSECTIONS 2 THRU LANES PLUS LEFT TURN LANE, WITH CROSSWALK: Delete dimension line and notation upper right of detail.

INDEX NO. 17349 (Sheet 1 of 1) - Add the following note: 4. Case I installations - the arrow panels and object markers shall be located approximately 20 feet, but not less than 12 feet from the edge of the travel lane.

INDEX NO. 17355 (Sheet 2 of 4) - RIGHT TURN ONLY sign: Change sign number from "FTP - 47" to "FTP - 1".
LEFT TURN ONLY sign: change sign number from "FTP - 48" to "FTP - 2".

INDEX NO. 17357 (Sheet 1 of 1) - Signs 1, 2, 3 and NOTE. The Following sign numbers changed: "FTP - 41" to "FTP - 50", "FTP - 42" to "FTP - 51", and "FTP - 43" to "FTP - 52".

INDEX NO. 17358 (Sheet 1 of 1) - PAVEMENT MARKING FOR CURB CUT RAMPS IN REST AREAS. All details deleted and the details on the attachments labeled PAVEMENT MARKING FOR CURB CUT RAMPS IN REST AREAS, INDEX NO. 17358 and sign detail labeled R7-8a, INDEX NO. 17358 substituted.

INDEX NO. 17500 (Sheet 1 of 1) - METAL POLE DETAIL and METAL POLE WIRING DETAIL, notation for U.L. Approved Grounds, second parenthesis: Delete wording and substitute "Resistance to Ground Not To Exceed 25 OHMS."

INDEX NO. 17503 (Sheet 1 of 1) - METAL POLE CONCRETE FOUNDATION DETAIL, notation for anchor bolts: Change specification date from 1986 to 1991; "SCREW TYPE FOUNDATION DETAIL": Change tip dimension from 9" to 6" min.

INDEX NO. 17504 (Sheet 1 of 1) - DETAIL A and DETAIL B: Change Pole type from Type II to Type N-II.

INDEX NO. 17781 (Sheet 1 of 2) - GENERAL NOTES. Add Note No. 6: "Splice Connections in pull boxes may be made with U.L. Listed, watertight, insulated connectors in lieu of the details above. The lead-in cable insulation shall be sealed using electrical tape or heat shrinkable tubing (refer to Step 5 above). The seal shall extend approximately 1" either side of the lead-in cable outer cover."

STANDARD CRITERIA

CLASS	APPLICATION DESCRIPTION	STANDARD INDEX NO.	PERMEABILITY cm/sec	A. O. S. Range U.S. Sieve #	GRAB TENSILE STRENGTH lbs.	PUNCTURE lbs.	TRAPEZOIDAL TEAR No.	MULLER BURST Psi	ELONGATION %	SEAM STRENGTH lbs.	RESISTANCE (Min. Allowed)		FILTRATION EFFICIENCY %	FLOW RATE Gal./Min.	COMMENTS
											U	V			
DRAINAGE (D)	D 1	Reinforced (Special) Reinforced (Standard)	1.0 ⁻⁴	40-70	250	45	50	500	15-30	225	80	500	—	—	When Noninflamed only
	D 2	Cyclopaen Stone	1.0 ⁻⁴	70-100	200	80	50	300	15-50	40	80	500	—	—	When Noninflamed only
		Artificially Blasted Gabbro													
	D 3	Rac Rubber Braided Concrete Underdrain Trench Wrap	280	1.0 ⁻⁴	70-100	50	45	140	50	(Min.)	80	150	—	—	When placed adjacent to temporary sheeting which will be removed the filter fabric shall meet the requirements of D 2 TABLE
		Sheet Piling Filter Filter Fabric Jacket (Quartz)													
	D 4	Slope Reinforced (Sand Concrete)	280	1.0 ⁻⁴	70-100	40	50	15	80	50	62	80	150	—	Non Woven only Min. Thickness 90 Mils
		Precombined Stabilizer Reinforcing Wall													
	D 5	Cast in Place Reinforcing Wall	280	1.0 ⁻⁴	70-100	80	50	40	80	50	80	150	—	—	Non Woven only Min. Thickness 100 Mils
		Slope Reinforced (Concrete)													
	D 6	Slope Reinforced (Concrete)	280	1.0 ⁻⁴	70-100	80	50	15	80	50	62	80	150	—	Non Woven only Min. Thickness 100 Mils
Underdrain Filter Sock															
EROSION (E)	E 1 Stake Silt Fence	286	—	70-100	80	—	—	—	—	—	—	—	—	See Standard Specification 3-48	
	E 2 Wind Screen	403	1.0 ⁻³	NA	80	—	15	80	15-40	80	500	75	0.3	—	
STABILIZATION (R)	R 1 Reinforcement	—	1.0 ⁻³	30	200	80	50	200	15-40	80	150	—	—	—	
	R 2 Separation	—	1.0 ⁻³	30	80	80	50	200	15-40	80	150	—	—	—	

(1) Type refers to FOOT class and application. * See DESIGN NOTE No. 3 ** See TABLE below

TABLE 1

Test	Unit	Test Method
Permeability	cm/sec	ASTM D 409
A.O.S.	U.S. Sieve No.	ASTM D 422
Grab Tensile Strength	lbs	ASTM D 423
C'V Ball Burst Test	lbs	ASTM D 3747 (Include 40311)
Puncture	lbs	ASTM D 4811
Trapezoidal Tear	lbs	ASTM D 4813
Muller Burst	Psi	ASTM D 3746
Elongation	%	ASTM D 4832
Ultra Violet Resistance	% Retention	ASTM D 4355
Filtration Efficiency	%	ASTM D 544
Flow Rate	Gal./Min.	ASTM D 544

- GENERAL NOTES**
- Specifications for materials are Section 805 or the Section Modified by the specific specifications. The criteria for each application is provided by this Standard in conjunction with these methods.
 - All values are MINIMUM AVERAGE ROLL values in the weakest principal direction unless otherwise stated.
 - Range of values do not preclude the responsibility to design the fabric in the fabric materials and conditions.
 - Unless specifically restricted in COMMENTS column any type of material may be used.
- DESIGN NOTES**
- The Designer shall review this criteria and adjust the values as needed for the specific project requirements. These adjustments shall be noted in the project specifications or combined in the project special provisions. (See design note 3.)
 - U.V. Resistance: The value represents the percent of minimum tensile strength retained (ASTM D 4832) after weathering per ASTM D 4355 for the test period shown.
 - A.O.S. Design Guide: No. 200 sieve A.O.S. Range is 40-60. No. 40 sieve A.O.S. Range is 60-70. No. 60 sieve A.O.S. Range is 70-100. No. 100 sieve A.O.S. Range is 100-200. No. 200 sieve A.O.S. Range is 200-400.

STATE OF FLORIDA DEPARTMENT OF TRANSPORTATION
ROAD DIVISION

GEOTEXTILE CRITERIA

Project No.	199
Sheet No.	52

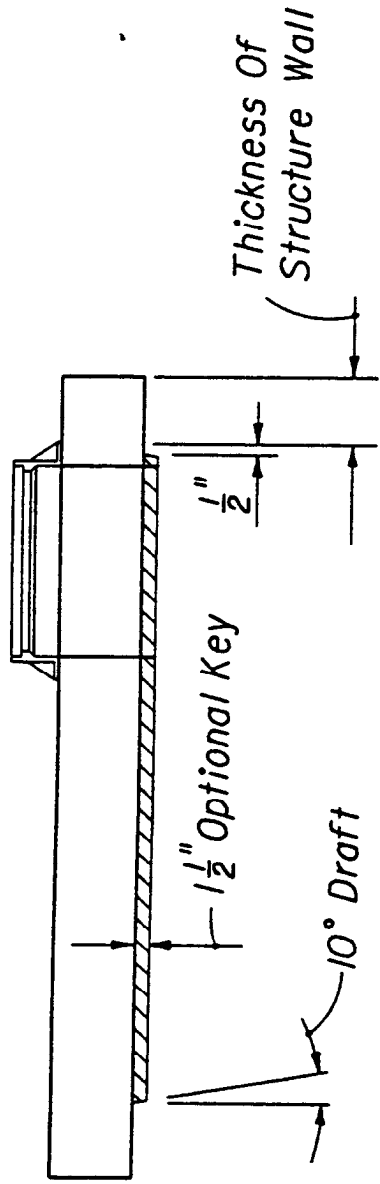

SECTION

Note: See Slab Designs Index 200.

TYPE 7

MANHOLE TOPS

Index No.
201

ROUND PIPE - 2 1/2" x 1/8" CORRUGATION

D (In.)	Area (Sq. Ft.)	Maximum Height Of Fill (ft.)				Min Cover (ft.)
		Sheet Thickness in inches (Gage)				
		0.075 (14)	0.075 (12)	0.135 (10)	0.64 (8)	
12	0.8	NA	NA	NA	NA	
15	1.2	50	NA	NA	NA	
18	1.8	50	NA	NA	NA	
21	2.1	52	NA	NA	NA	
24	3.1	44	NA	NA	NA	
36	6.9	33	NA	NA	NA	
48	9.6	NA	NA	NA	NA	
54	15.9	NA	NA	NA	NA	
60	19.6	NA	NA	NA	NA	
66	23.8	NA	NA	NA	NA	
72	28.3	NA	NA	NA	NA	

ROUND PIPE - 3" x 1" CORRUGATION

D (In.)	Area (Sq. Ft.)	Maximum Height Of Fill (ft.)				Min Cover (ft.)
		Sheet Thickness in inches (Gage)				
		0.060 (16)	0.075 (14)	0.105 (12)	0.135 (10)	0.64 (8)
36	7.1	33	NA	NA	NA	NA
48	9.6	28	NA	NA	NA	NA
54	15.9	28	NA	NA	NA	NA
60	19.6	28	NA	NA	NA	NA
66	23.8	28	NA	NA	NA	NA
72	28.3	28	NA	NA	NA	NA
78	31.2	NA	NA	NA	NA	NA
84	34.5	NA	NA	NA	NA	NA
90	38.5	NA	NA	NA	NA	NA
96	42.2	NA	NA	NA	NA	NA
102	45.7	NA	NA	NA	NA	NA
108	49.8	NA	NA	NA	NA	NA
114	53.5	NA	NA	NA	NA	NA
120	57.5	NA	NA	NA	NA	NA

ROUND PIPE - SPIRAL RIB RIB SPACING (1 1/2" x 3" x 7 1/2")

D (In.)	Area (Sq. Ft.)	Maximum Height Of Fill (ft.)				Min. Cover (ft.)
		Sheet Thickness in inches (Gage)				
		0.060 (16)	0.075 (14)	0.075 (12)	0.135 (10)	0.64 (8)
12	0.79	NA	NA	NA	NA	NA
15	1.23	55	NA	NA	NA	NA
18	1.77	55	NA	NA	NA	NA
21	2.40	47	NA	NA	NA	NA
24	3.14	41	NA	NA	NA	NA
30	4.9	33	NA	NA	NA	NA
36	7.1	28	NA	NA	NA	NA
48	9.6	NA	NA	NA	NA	NA
54	15.9	NA	NA	NA	NA	NA
60	19.6	NA	NA	NA	NA	NA
66	23.8	NA	NA	NA	NA	NA
72	28.3	NA	NA	NA	NA	NA
78	31.2	NA	NA	NA	NA	NA
84	34.5	NA	NA	NA	NA	NA
90	38.5	NA	NA	NA	NA	NA
96	42.2	NA	NA	NA	NA	NA
102	45.7	NA	NA	NA	NA	NA
108	49.8	NA	NA	NA	NA	NA
114	53.5	NA	NA	NA	NA	NA
120	57.5	NA	NA	NA	NA	NA

NOTE
Special installation required.
Refer to AASHTO Standard Specifications for Highway Bridges or ASTM B788 and manufacturer's recommendations.

PIPE ARCH - 2 1/2" x 1/8" CORRUGATION

Span (In.)	Rise (In.)	Eq. Round Pipe (In.)	Area (Sq. Ft.)	Minimum Sheet Thickness Required (In.)	Maximum Height Of Fill (ft.)		Min. Cover (ft.)
					Pressure (Lb./Sq. Ft.)	4000	
12	3	3	1.1	0.060 (16)	12	15	15
15	4	4	1.6	0.060 (16)	12	14	14
18	5	5	2.2	0.060 (16)	7	13	13
21	6	6	2.9	0.075 (14)	5	11	11
24	7	7	3.6	0.075 (14)	5	10	10
27	8	8	4.3	0.075 (14)	5	9	9
30	9	9	5.0	0.075 (14)	5	8	8
33	10	10	5.7	0.075 (14)	5	7	7
36	11	11	6.4	0.075 (14)	5	6	6
39	12	12	7.1	0.075 (14)	5	5	5
42	13	13	7.8	0.075 (14)	5	4	4
45	14	14	8.5	0.075 (14)	5	3	3
48	15	15	9.2	0.075 (14)	5	2	2
51	16	16	9.9	0.075 (14)	5	1	1
54	17	17	10.6	0.075 (14)	5	0	0
57	18	18	11.3	0.075 (14)	5	0	0
60	19	19	12.0	0.075 (14)	5	0	0
63	20	20	12.7	0.075 (14)	5	0	0

PIPE ARCH - 3" x 1" CORRUGATION

Span (In.)	Rise (In.)	Eq. Round Pipe (In.)	Area (Sq. Ft.)	Minimum Sheet Thickness Required (In.)	Maximum Height Of Fill (ft.)		Min. Cover (ft.)
					Pressure (Lb./Sq. Ft.)	4000	
12	3	3	7.0	0.060 (16)	8	12	12
15	4	4	9.4	0.060 (16)	8	11	11
18	5	5	12.1	0.060 (16)	8	10	10
21	6	6	15.0	0.075 (14)	8	9	9
24	7	7	18.0	0.075 (14)	8	8	8
27	8	8	21.0	0.075 (14)	8	7	7
30	9	9	24.0	0.075 (14)	8	6	6
33	10	10	27.0	0.075 (14)	8	5	5
36	11	11	30.0	0.075 (14)	8	4	4
39	12	12	33.0	0.075 (14)	8	3	3
42	13	13	36.0	0.075 (14)	8	2	2
45	14	14	39.0	0.075 (14)	8	1	1
48	15	15	42.0	0.075 (14)	8	0	0
51	16	16	45.0	0.075 (14)	8	0	0
54	17	17	48.0	0.075 (14)	8	0	0
57	18	18	51.0	0.075 (14)	8	0	0

PIPE ARCH - SPIRAL RIB RIB SPACING (1 1/2" x 3" x 7 1/2")

Span (In.)	Rise (In.)	Eq. Round Pipe (In.)	Area (Sq. Ft.)	Minimum Sheet Thickness Required (In.)	Maximum Height Of Fill (ft.)		Min. Cover (ft.)
					Pressure (Lb./Sq. Ft.)	4000	
12	3	3	1.2	0.060 (16)	12	13	13
15	4	4	1.7	0.060 (16)	12	12	12
18	5	5	2.3	0.060 (16)	7	11	11
21	6	6	3.0	0.060 (16)	5	10	10
24	7	7	3.7	0.075 (14)	5	9	9
27	8	8	4.4	0.075 (14)	5	8	8
30	9	9	5.1	0.075 (14)	5	7	7
33	10	10	5.8	0.075 (14)	5	6	6
36	11	11	6.5	0.075 (14)	5	5	5
39	12	12	7.2	0.075 (14)	5	4	4
42	13	13	7.9	0.075 (14)	5	3	3
45	14	14	8.6	0.075 (14)	5	2	2
48	15	15	9.3	0.075 (14)	5	1	1
51	16	16	10.0	0.075 (14)	5	0	0
54	17	17	10.7	0.075 (14)	5	0	0
57	18	18	11.4	0.075 (14)	5	0	0

NOTES:
1. Increase the minimum cover values shown on Sheet 1 of 4 by 6" for pipe and lift combinations below the heavy lines.
2. Height of fill (maximum cover) is measured from top of finished grade to outside top of pipe.

NA Not Available
MS Not Suitable (For Highway M 20 Loadings)
DR Design Review is recommended for each specific application. The review should identify any special handling, installation, modification, and safety requirements which may be required. See TDDI Drainage Manual, Chapter 8, Section 8.1.1. It is the responsibility of the manufacturer to provide the necessary information for the designer to select the correct pipe and cover. The manufacturer is responsible for providing the necessary information for the designer to select the correct pipe and cover. The manufacturer is responsible for providing the necessary information for the designer to select the correct pipe and cover.

1. Limited availability of this product. Check availability before specifying.
2. 360° reflective pipe (French drain pipe) is not recommended in the pipe arch shape. Do not specify without checking with the manufacturer.
3. This site and pipe combination must be specified during installation per manufacturer's recommendations. Extra care will be required during handling and installation.
4. Use of this site and pipe combination must be approved by the State Drainage Engineer.

CORRUGATED ALUMINUM ALLOY ROUND PIPE AND PIPE ARCH COVER HEIGHT

STATE OF FLORIDA DEPARTMENT OF TRANSPORTATION
DESIGN SECTION

PROJECT NO. 205
SHEET NO. 4 OF 4

DATE: 10/1/00
BY: [Signature]

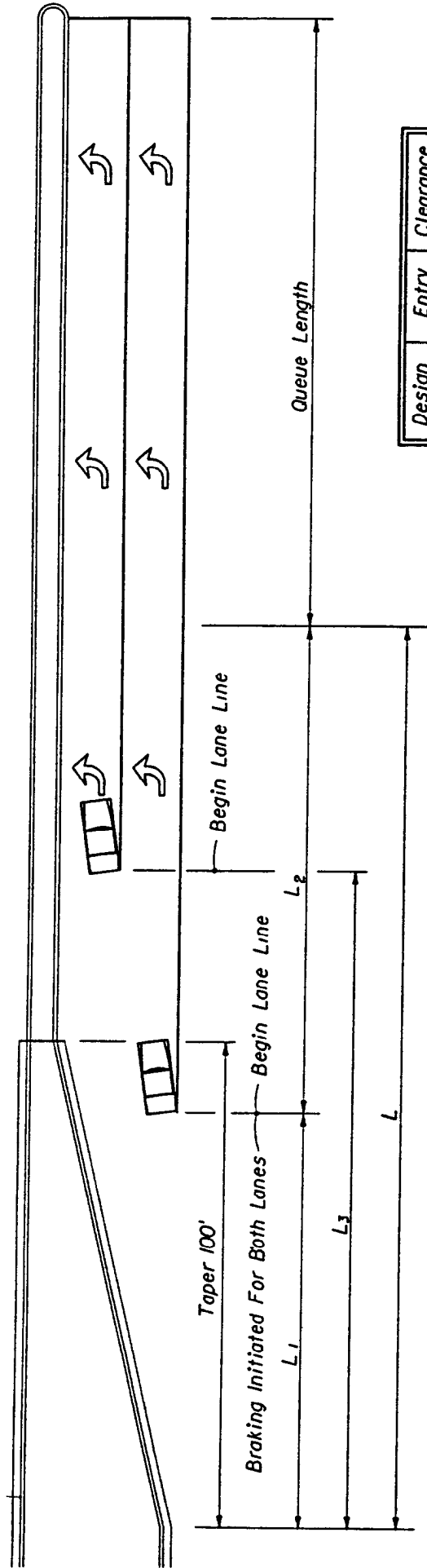

Design Speed (mph)	Entry Speed (mph)	Clearance Distance L_3
65	55	270'
55	45	205'
45	35	135'
35	25	110'

Note: For L , L_1 & L_2 values see table 'TURN LANES - CURBED AND UNCURBED MEDIANS' Sheet No. 1 of 1 Index No. 301. For pavement markings see Sheet No. 2 of 8 Index No. 17346.

DOUBLE LEFT TURN LANES (FULL SHADOW) INDEX NO. 301

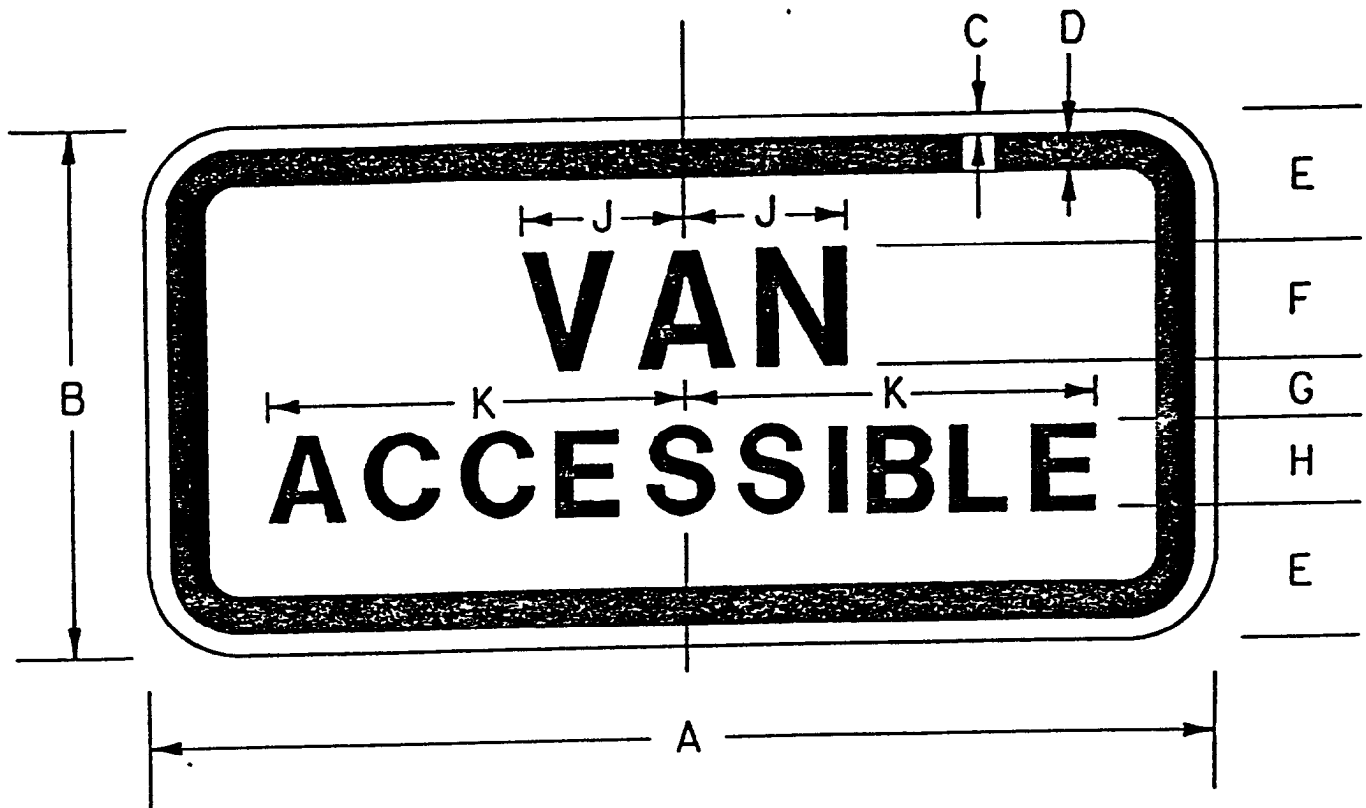

SIGN	DIMENSIONS (INCHES)										
	A	B	C	D	E	F	G	H	J	K	L
MIN.	12	6	$\frac{3}{8}$ "	$\frac{3}{8}$ "	$1\frac{1}{2}$ "	$1\frac{1}{2}$ "	$\frac{1}{2}$ "	1	$2\frac{1}{2}$ "	4	$1\frac{1}{2}$ "
STD.	18	9	$\frac{3}{8}$ "	$\frac{5}{8}$ "	$2\frac{1}{4}$ "	2	1	$1\frac{1}{2}$ "	$2\frac{3}{4}$ "	7	$1\frac{1}{2}$ "

COLORS

REGULATORY
 LEGEND - BLACK
 BACKGROUND - WHITE

DIRECTIONAL
 LEGEND - WHITE
 BACKGROUND - BLUE

ALL LETTERS SERIES "D"

R7-80

INDEX NO. 17358

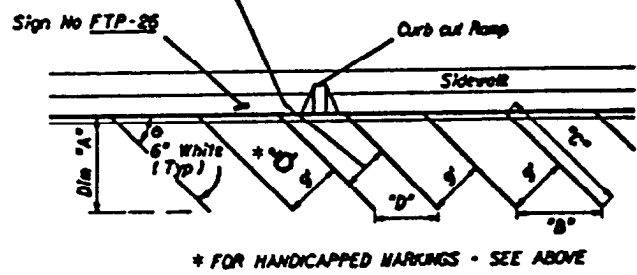
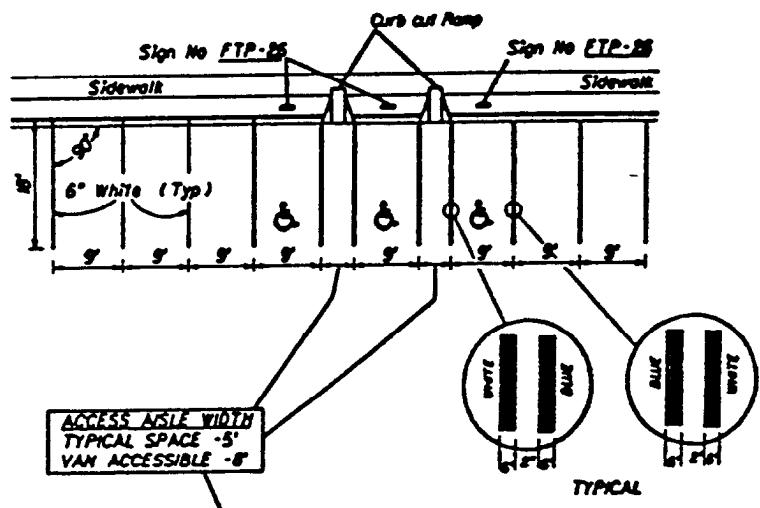
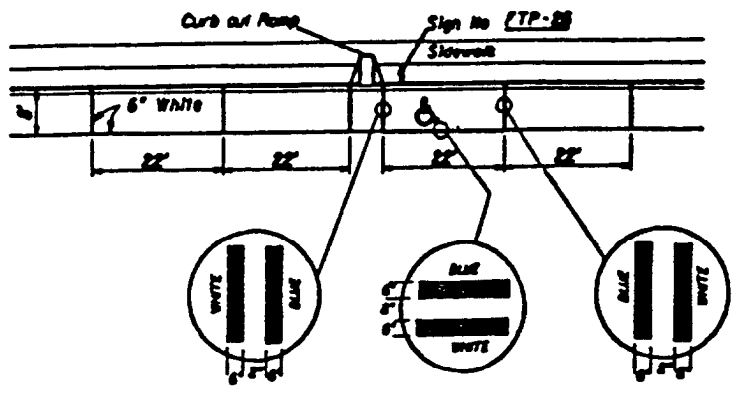

Δθ	"DIMENSIONS"		
	"A"	"B"	"C"
45°	15'-1"	12'-9"	21'-0"
60°	20'-1"	17'-5"	23'-2"

AISLE WIDTH	DIMENSION "D"	
	5'	8'
45°	7'-0"	11'-4"
60°	5'-9"	9'-3"

NOTES:

1. An Access Aisle is required for each handicapped space when angle parking is used.
2. For Van Accessible Spaces Sign No. FTP-25 and the 10-B supplemental panel replaces Sign No. FTP-25.
3. Criteria for pavement markings only, not curb cut ramp locations. For ramp locations refer to plans.
4. Blue pavement markings shall be tinted to match shade 1580 of Federal Standards 595a.

**PAVEMENT MARKING FOR CURB CUT
RAMPS IN REST AREAS**

INDEX NO. 17358

ROADWAY PLANS PREPARATION MANUAL VOLUME I

DESIGN CRITERIA AND PROCESS

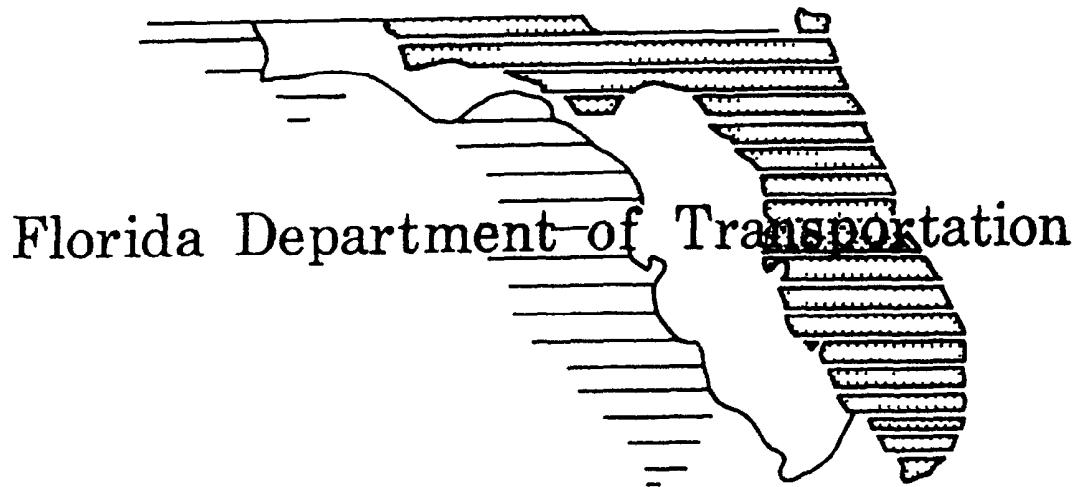

DOCUMENT NO. 625-000-101-B
ROADWAY DESIGN OFFICE
TALLAHASSEE, FLORIDA
1989

ROADWAY PLANS PREPARATION MANUAL

NAME _____

NAME OF FIRM OR
D.O.T. DISTRICT _____

MAILING ADDRESS _____

TELEPHONE _____

Please remove this sheet from your Manual and complete the requested information so that addenda and revisions may be forwarded as necessary.

Please return to:

Florida Department of Transportation
Roadway Design Office
Mail Station 32
605 Suwannee Street
Tallahassee, Florida 32399-0450

SUGGESTIONS AND COMMENTS

ROADWAY DESIGN MANUALS

DOCUMENT NAME & No _____

NAME OF FIRM/D O T
DEPARTMENT _____

ADDRESS _____

NAME AND TELEPHONE No
OF PERSON RESPONSIBLE FOR
SUGGESTION OR COMMENT (_____) _____

SUGGESTIONS OR
COMMENTS _____

(Comments or Suggestions may be attached as marked up copies
of pages from the manuals)

PLEASE COMPLETE THE REQUESTED INFORMATION AND RETURN THIS SHEET TO

FLORIDA DEPARTMENT OF TRANSPORTATION
ROADWAY DESIGN OFFICE
MAIL STATION 32
605 SUWANNEE STREET
TALLAHASSEE, FLORIDA 32399-0450
ATTN LINDA SEIGLE
PHONE (904)487-1949

TABLE OF CONTENTS
VOLUME I

Design Criteria and Process

<u>Introduction</u>	XIX
<u>Chapter 1</u>	Design Parameters	
1 1	General	I-1- 1 0
1 2	Traffic	I-1- 2 0
1 3	Capacity and Level of Service	I-1- 3 0
1 4	Roadway Functional Classification	I-1- 4 0
1 5	3R Design	I-1- 5 0
1 6	Design Consistency and Driver Expectancy	I-1- 6 0
1 7	Aesthetics	I-1- 9 0
1 8	Access Management	I-1-10 0
<u>Chapter 2</u>	Geometrics	
2 1	Standards	I-2- 1 0
2.1.1	Fixed Standards	I-2- 1 0
2.1.2	Design Standard Ranges	I-2- 2 0
2 2	Lane Widths	I-2- 4 0
2.2 1	Through Lanes	I-2- 4 0
2.2 2	Transitions of Pavement Widths	I-2- 5.0
2.2.3	Wide Curb Lanes	I-2- 6 0
2 2 4	Other Lane Widths	I-2- 8 0
2 2 5	Bicycle Lanes	I-2- 8 0
2.2.6	Shoulder Widths	I-2- 9 0
2 2 7	Limits of Friction Course on Shoulders	I-2-12 0
2 3	Other Cross Section Elements	I-2-14 0

2 3 1	Cross Slopes	I-2-14 0
2 3 2	Roadway Structure	I-2-14 0
2 3.3	Side Slope and Side Ditches	I-2-16 0
2.3.4	Border Width	I-2-16 0
2 4	Horizontal Alignment	I-2-17 0
2 4 1	General	I-2-17 0
2 4.2	Supplemental Alignment Control	I-2-17 0
2 4.3	Two-Lane to Four-Lane Transitions	I-2-20 0
2 5	Vertical Alignment	I-2-21 0
2 6	Superelevation	I-2-22 0
2 7	Cross Sections	I-2-23 0
2 8	Intersections and Interchanges	I-2-24 0
2 9	Limited Access Limits at Interchanges	I-2-25 0
2 10	Design of Rural Projects	I-2-26 0
2 10 1	Profiles	I-2-26 0
2.10.2	Cross Sections	I-2-28 0
2.10.3	Preliminary Review	I-2-29 0
2.11	Design of Urban Projects	I-2-30 0
2.11.1	Preparation	I-2-30 0
2.11.2	Geometrics	I-2-31 0
2.11.3	Profiles	I-2-32 0
2.11 4	Cross Sections	I-2-35 0
2.11 5	Preliminary Review	I-2-35 0

Chapter 3 Earthwork

3 1	General	I-3- 1 0
3 2	Classification of Soils	I-3- 3 0
3 3	Removal and Utilization	I-3- 4 0
3.3.1	Criteria for Earthwork Details	I-3- 4 0
3.3.2	Cross Sections - A Design Tool	I-3- 5 0

3 4	Earthwork Quantities	I-3- 6 0
3 4 1	Method of Calculating	I-3- 6 0
3 4.2	Suitable and Unsuitable Materials	I-3- 6 0
3.4.3	Earthwork Accuracy	I-3- 9 0
3 4 4	Variation in Quantities	I-3-10 0
3 4.5	Sequence of Construction	I-3-11 0
3 4 6	Earthwork by Computer	I-3-12 0
3 5	Earthwork Items of Payment	I-3-13 0
3 5 1	Regular Excavation	I-3-13 0
3.5 2	Borrow Excavation	I-3-13 0
3 5 3	Lateral Ditch Excavation	I-3-16 0
3 5 4	Subsoil Excavation	I-3-17 0
3 5 5	Channel Excavation	I-3-18 0
3 5 6	Embankment	I-3-18 0
3 5 7	Regular Excavation - Lump Sum (3-R Projects Only)	I-3-20 0
3 6	Summary	I-3-23 0

Chapter 4 Roadside Safety

4.1	Clear Zone	I-4- 1 0
4 1.1	Clear Zone Concept	I-4- 1 0
4 1 2	Clear Zone Criteria	I-4- 2 0
4.2	Canal Hazard Standards	I-4- 5 0
4 3	Roadside Barriers	I-4- 8 0
4.3.1	Warrants	I-4- 8 0
4 3.2	Barrier Selection	I-4- 9 0
4 3.3	End Treatments	I-4-10 0
4.3.4	Transitions	I-4-11 0
4 3.5	Placement	I-4-11 0
4 3 6	Resetting Guardrail	I-4-13 0
4 4	Median Barriers	I-4-14 0

4 4 1	Warrants	I-4-14 0
4 4 2	Selection	I-4-14 0
4.4.3	End Treatments	I-4-14 0
4 5	Crash Cushions	I-4-15 0
4 5 1	Warrants	I-4-15 0
4 5 2	Selection	I-4-15 0
4.5 3	Design . . .	I-4-16 0
4.6	Roadside Appurtenances .	I-4-18 0
4.6 1	Sign Supports	I-4-18 0
4 6.2	Mailbox Supports	I-4-19 0
4.6 3	Other Appurtenances	I-4-19 0
4 6 4	Location Criteria	I-4-19 0
4.6.5	Bus Benches and Transit Shelters	I-4-19 0

Chapter 5 Utilities

5 1	General	I-5- 1 0
5 2	Relocation	I-5- 2 0
5 3	Utility - Accommodation Guide	I-5- 3 0
5.4	Verification of the Location of Major Existing Utilities	I-5- 4 0
5 4 1	Locating Underground Utilities	I-5- 5 0
5 5	Coordination Process	I-5- 8 0
5 5.1	Coordination of Traffic Monitoring Sites	I-5- 9 0

Chapter 6 Railroad Grade Crossing

6.1	General	I-6- 1 0
6 2	Devices	I-6- 2 0
6 3	Surfaces	I-6- 3 0
6 4	Clearance at Railroad/Highway Structures .	I-6- 4 0

Chapter 7	Signing, Marking, Lighting and Signals	
7 1	General	I-7- 1 0
7.2	Signing and Marking	I-7- 2 0
7 2 1	Design Criteria	I-7- 3 0
7.2.2	Wind Loading Criteria - Signs	I-7- 3 0
7.2.3	Project Coordination	I-7- 5 0
7 3	Lighting	I-7- 6 0
7.3 1	Design Criteria	I-7- 6 0
7 3 2	Conventional Lighting Criteria	I-7- 7 0
7.3 3	High-Mast Lighting Criteria	I-7- 8 0
7 3 4	Pole Design Criteria	I-7- 8 0
7 3 5	Underdeck Lighting Criteria	I-7- 9 0
7 3 6	Foundations Criteria	I-7-10 0
7 3 7	Wind Loading Criteria - Lighting	I-7-10 0
7 3 8	Lighting Project Coordination	I-7-11 0
7.3 9	Voltage Drop Criteria	I-7-13 0
7.4	Traffic Signals	I-7-14 0
7.4 1	Design Criteria	I-7-14 0
7 4.2	Certification and Specialty Items	I-7-15 0
7.4.3	Stop Line Location	I-7-15 0
7.4 4	Controller Timing	I-7-16 0
7 4.5	Left Turn Treatments	I-7-16 0
7 4.6	Signal Preemption	I-7-19 0
7 4.7	Intersection Design - Lane Configuration	I-7-19 0
7.4.8	Signal Loops	I-7-22 0
7 4.9	Wind Loading Criteria - Traffic Signals	I-7-22 0

Chapter 8	Bicycles and Pedestrian Facilities	
8.1	General	I-8- 1 0
8 2	Sidewalks	I-8- 2 0

8.3	Handicap Access	I-8- 4 0
8 4	Bicycle Facilities	I-8- 5 0
Chapter 9	Landscaping	
9 1	General	I-9- 1 0
Chapter 10	Work Zone Traffic Control	
10 1	General	I-10- 1 0
10 2	References	I-10- 2 0
10 3	Comprehensive Work Zone Traffic Control Planning	I-10- 3 0
10 4	Traffic Control Plans	I-10- 5 0
10 5	TCP Development	I-10- 7 0
10.6	Coordination	I-10-11 0
10.6.1	FHWA Review	I-10-12 0
10.6.2	Phase Submittals	I-10-12 0
10 7	Work Zone Traffic Control Training	I-10-13 0
10.7 1	Background	I-10-13 0
10.7.2	Training Requirements	I-10-13 0
10 8	Traffic Control Devices	I-10-14 0
10.9	Signs	I-10-15 0
10.9.1	Advance Warning Signs	I-10-15 0
10.9.2	Length of Construction Sign	I-10-15 0
10.9.3	Sign Covering	I-10-15 0
10.9.4	Existing Signs	I-10-16 0
10.10	Lighting Units	I-10-17 0
10.10.1	Warning Lights	I-10-17 0
10.10.2	Advance Warning Arrow Panels	I-10-18 0
10.10.3	Variable Message Signs	I-10-19 0
10.10.4	Traffic Signals	I-10-22 0
10.11	Channelizing Devices	I-10-23 0

10 11 1	Type III Devices	I-10-23 0
10 11.2	Separation Devices	I-10-23 0
10.11 3	Channelizing Device Alternates	I-10-24 0
10 12	Pavement Markings	I-10-25 0
10 12 1	Removing Pavement Markings	I-10-25 0
10 12 2	Reflectonzed Raised Pavement Marker	I-10-25 0
10 12 3	Work Zone Markings	I-10-25 0
10 13	Safety Appurtenances for Work Zones	I-10-27 0
10 13 1	Traffic Barners	I-10-27 0
10 13 2	Portable Concrete Safety Shapes	I-10-27 0
10 13.3	End Treatments . . .	I-10-28 0
10 13.4	Modifications of Existing Barners	I-10-28 0
10.13 5	Crash Cushion	I-10-28 0
10 13 6	Truck Mounted Attenuator	I-10-29 0
10 14	Flaggers	I-10-31 0
10.14 1	General	I-10-31 0
10.14 2	Location of Flaggers	I-10-31 0
10 14.3	Police Agencies	I-10-31 0
10 15	Layouts	I-10-32 0
10.15.1	Taper Lengths	I-10-32 0
10.15 2	Intersecting Road Signing and Signals	I-10-33 0
10 15 3	Sight Distance to Delineation Devices	I-10-34 0
10.15 4	Pedestrians and Bicyclists	I-10-34 0
10.15 5	Superelevation	I-10-34 0
10 15 6	Lane Widths	I-10-35 0
10 15.7	Lane Closure Analysis	I-10-35 0
10.15 8	Detours	I-10-48 0
10.15 9	Above Ground Hazards	I-10-49 0
10 15 10	Drop offs in Work Zones	I-10-50 0
10.15.11	Narrow Bridges	I-10-50 0

10 15 12	Existing Highway Lighting	I-10-50 0
10 15 13	Work Area Access .	I-10-51 0
10 15 14	Pay Items and Quantities .	I-10-51 0
10 16	Speed Zoning	I-10-52 0
10.16 1	Regulatory Speeds in Work Zones	I-10-52 0
10.16.2	Advisory Speeds in Work Zones	I-10-56 0
<u>Chapter 11</u>	Pay Items, Quantities and Specifications	
11 1	Pay Items and Quantities and Specifications	I-11- 1 0
11.2	New Pay Items .	I-11- 4 0
11 3	Plan Notes . . .	I-11- 4 0
<u>Chapter 12</u>	Right-of-Way	
12 1	General	I-12- 1 0
<u>Chapter 13</u>	Project Development	
13 1	General	I-13- 1.0
13 2	Process	I-13- 1 0
13.2.1	Five Year Work Program	I-13- 1 0
13.2.2	PD & E Process	I-13- 2 0
13.2.3	Final Design	I-13- 3 0
13.2.4	Project Letting	I-13- 3 0
13.3	3R Design	I-13- 5 0
13 4	In-House (DOT) Design .	I-13- 7 0
13 5	Consultant Design	I-13- 8 0
13 6	Project Scheduling	I-13- 9 0
<u>Chapter 14</u>	Data Collection	
14 1	General	I-14- 1 0
14.2	Project Data	I-14- 1 0

14 2 1	Project Description	I-14- 1 0
14 2 2	Project Number	I-14- 2 0
14 2 3	Project Cost	I-14- 2 0
14 2.4	Production Schedule	I-14- 2 0
14 3	Design Data	I-14- 3 0
14 3.1	Surveys	I-14- 3 0
14 3 2	Traffic Data	I-14- 5 0
14 3 3	Pavement Design	I-14- 5 0
14 3 4	Environmental Documents	I-14- 5 0
14 3 5	Original Plans	I-14- 6 0
14 3.6	Accident Data	I-14- 6 0
14 4	List of Requests and Contacts	I-14- 7 0
<u>Chapter 15</u>	Scheduled Submittals	
15 1	General	I-15- 1 0
15 2	Design Plans Phase Review Submittal	I-15- 2 0
15 2 1	Plans Disposition	I-15- 3 0
15 3	Other Submittals and Requests	I-15- 4 0
15.3.1	Structures (Bridges, Walls and Buildings)	I-15- 4 0
15.3.2	Surveys	I-15- 7 0
15 3.3	Typical Sections	I-15- 8 0
15.3 4	Pavement Design	I-15-13 0
15 3.5	Permits	I-15-13 0
15.3.6	Right-of-Way Surveying and Mapping	I-15-15 0
15 3.7	Value Engineering	I-15-17 0
<u>Chapter 16</u>	Quality Control	
16.1	General	I-16- 1 0

<u>Chapter 17</u>	Quality Assurance	
17 1	General	I-17- 1 0
17 2	Authority	I-17- 3 0
17 3	Areas of Responsibility	I-17- 4 0
17 4	Critical Areas to be Monitored	I-17- 5 0
17 5	Documentation	I-17- 7 0
17 6	Consultants Role	I-17- 8.0
17 7	Training	I-17- 9 0
<u>Chapters 18</u>	Pay Items	
18 1	General	I-18- 1 0
18 2	Pay Items	I-18- 1 0
18.3	CES	I-18- 2 0
18 4	Computation Book	I-18- 2 0
18 5	Contract Time	I-18- 2 0
18 6	Shop Drawings	I-18- 3 0
<u>Chapters 19</u>	Signing and Sealing Design Drawings	
19 1	General	I-19- 1 0
19.2	Signing and Sealing of Plans	I-19- 2 0
19.2.1	Original Plans	I-19- 2 0
19.2.2	Record Set	I-19- 2 0
19 3	Signing and Sealing other Engineering Documents	I-19- 3 0
19 4	Signing and Sealing of Revisions	I-19- 4 0
19.4.1	Revisions to Plans	I-19- 4 0
19 4.2	Revisions to Engineering Documents	I-19- 4 0
19.5	Information Requirng Certification	I-19- 5.0
19.5.1	18 Kip Equivalent Single Axle Loads	I-19- 5 0
19.5.2	Project Traffic (to be Used for Design)	I-19- 6 0

Chapter 20	Plans Processing and Revisions	
20.1	Plans Processing .	I-20- 1 0
20 1.1	District Processing	I-20- 1 0
20 1 2	Roadway Design Office .	I-20- 2 0
20 1 3	Specifications	I-20- 3 0
20 1 4	Preliminary Estimates	I-20- 9 0
20 1 5	Reprographics	I-20- 9 0
20 1 6	Federal-Aid Office	I-20-10 0
20 1 7	Production Management .	I-20-10 0
20 1 8	Contracts Administration Office .	I-20-11 0
20.1.9	Construction Office .	I-20-11 0
20 2	Plan and Specification Revisions	I-20-13 0
20 2 1	Signed and Sealed .	I-20-14 0
20 2 2	Signed, Sealed and Shipped (not reproduced)	I-20-15 0
20.2 3	Signed, Sealed, Shipped and Reproduced	I-20-16 0
20 2 4	Let to Contract (LTC)	I-20-21 0
20.2 5	Complete Project Revisions .	I-20-23 0
20 3	Automated Plans (CADD)	I-20-23 0

Chapter 21	Consultant Project Management	
21.1	General	I-21- 1 0
21 2	Project Definition	I-21- 2 0
21.2 1	Project Concept Report	I-21- 2 0
21.2 2	Scope of Services	I-21- 2 0
21 3	Consultant Acquisition	I-21- 3 0
21.4	Technical Management	I-21- 3 0
21 5	Contract Administration	I-21- 4 0
21 6	Scheduling and Coordination	I-21- 4 0
21.7	Consultant Use of Department Computer Programs	I-21- 5 0

Chapter 22	Architectural Plans	
22 1	General	I-22- 1 0
22 2	Codes, Rules and Regulations	I-22- 3 0
22.3	Standard Document Requirements	I-22- 8 0
22 4	Schematic Design Phase Requirements	I-22-10 0
22 5	Design Development Phase	I-22-13 0
22 5 1	General	I-22-13 0
22 5.2	Development Procedures	I-22-13 0
22 5 3	Reviews	I-22-13 0
22.5.4	Submission Requirements	I-22-14 0
22 6	Contract Document Phase	I-22-35 0
22 6 1	General	I-22-35 0
22.6 2	Development Procedures	I-22-35 0
22 6 3	Review and Approvals	I-22-35 0
22 6 4	Documents Required	I-22-37 0
22.6 5	Release for Printing	I-22-41 0
22.6 6	Pre-Bid Conference	I-22-41 0
22 7	Construction Phase Requirements	I-22-42 0
22.7.1	General	I-22-42 0
22.7 2	Preconstruction Conference	I-22-42 0
22 7.3	Periodic Construction Conference	I-22-42 0
22 7 4	Shop Drawings, Materials and Equipment Submittals	I-22-43 0
22.7.4	Clarification Drawings and Specifications	I-22-44 0
22.7.5	Substantial Completion	I-22-45 0
22 7.6	Final Acceptance and Contract Close-out	I-22-46 0

Chapter 23	Design Exceptions	
23 1	General	I-23- 1 0
23 2	Department Design Standards and Criteria	I-23- 1 0

23 3	Design Exceptions	I-23- 2 0
23 4	Design Variations	I-23- 2 0

Chapter 24 Certification Acceptance (CA)

24 1	General	I-24- 1 0
24 2	CA Coverage	I-24- 2 0
24 2.1	Areas Not Included	I-24- 2 0
24 3	CA Responsibilities	I-24- 5 0
24 4	CA Documentation and Reviews	I-24- 9 0

LIST OF EXHIBITS

<u>EXHIBIT</u>	<u>NUMBER</u>	<u>PAGE</u>
Geometrics		
Interstate and Expressway Shoulder Widths	I- 2-A	I- 2-11 0
Added Paved Shoulders	I- 2-B	I- 2-13 0
Standard Pavement Cross Slope	I-2-C	I-2-15 0
Earthwork		
Basic Process	I-3-A	I-3- 2 0
Cut, Subsoil Excavation, Fill	I-3-B	I-3- 8 0
Regular Excavation - Lump Sum (3-R Projects only)	I-3-C	I-3-22 0
Roadside Safety		
Recovery Area and Clear Zone Distance	I- 4-A	I- 4- 4 0
Minimum Standards for Canal Hazards	I- 4-B	I- 4- 7 0
Utilities		
Reproduction Request (Utility Blueines)	I- 5-A	I- 5-10 0
Work Zone Traffic Control		
Lane Closures	I-10-A	I-10-37 0
Pay Items, Quantities and Specifications		
Pay Item Request Form	I-11-A	I-11- 5 0
Project Development		
Plans Process Flow Chart	I-13-A	I-13- 4 0
Design Project Activities Flow Chart	I-13-B	I-13-11 0

Data Collection

Transmittal Letter to:

Highway Statistic Engineers	I-14-A	I-14-11 0
Soils Engineer	I-14-B	I-14-12 0
Request for Survey	I-14-C	I-14-13 0
Transmittal Letter to		
Materials Engineer	I-14-D	I-14-15 0
Environmental Permit Coord	I-14-E	I-14-16 0
District Railroad Coord.	I-14-F	I-14-17 0
Utilities Engineer	I-14-G	I-14-18 0
Computation Book Transmittal	I-14-H	I-14-19 0
Request for CADD and Cross- Sections	I-14-I	I-14-20 0

Scheduled Submittals

Typical Section Data Sheet (Consultant)	I-15-A	I-15- 9 0
Typical Section Data Sheet (In-House)	I-15-B	I-15-10 0
Proposed Typical Section (Consultant)	I-15-C	I-15-11 0
Proposed Typical Section (In-House)	I-15-D	I-15-12 0

Plans Processing and Revisions

Contract File List	I-20-A	I-20- 4 0
Environmental Re-evaluation/ CEI Recommendation	I-20-B	I-20- 5 0
Final Plans Transmittal Letter	I-20-C	I-20- 7 0
Plans Processing Procedure	I-20-D	I-20- 8 0
Revision Letter	I-20-E	I-20-18 0
Plans Key Sheet	I-20-F	I-20-20 0
Sample Revision Letter	I-20-G	I-20-24 0

Architectural Plans

Title Block Requirements	I-22-A	I-22-47 0
Title Block	I-22-B	I-22-48 0
Title Sheets, Pages and Covers	I-22-C	I-22-50 0
Key Sheet	I-22-D	I-22-51 0
Standard Method of Area Calculation and Space Measurement	I-22-E	I-22-53 0

Area Analysis - Summary	I-22-F	I-22-58 0
Facilities Computation Form	I-22-G	I-22-59 0
Design Exceptions		
Request for Exception - Non-CA Projects	I-23-A	I-23- 4 0
Request for Exception - CA Projects	I-23-B	I-23- 5 0
Request for Variation - Non-CA Projects	I-23-C	I-23- 6 0
Certification Acceptance		
Certification Acceptance Approval and Concurrence Process	I-24-A	I-24-10 0
Response to Phase Reviews - CA Projects	I-24-B	I-24-11 0
Request for Design Variation - CA Projects	I-24-C	I-24-12 0
Special Provisions Transmittal - CA Projects	I-24-D	I-24-13 0

Revised 12/08/92

VOLUME I

ROADWAY DESIGN CRITERIA AND PROCESS

INTRODUCTION

The Roadway Design Criteria and Process Manual is part of a two volume set of guidelines, standards and techniques used to develop roadway plans for the Florida Department of Transportation

This volume contains the Florida DOT's roadway design criteria, which, along with other Florida DOT publications, establish highway design policy. This manual includes both design criteria and material describing the design process.

Volume II of this manual, Plans Preparation and Assembly, was prepared to aid the technician and drafter in the development of a set of roadway plans.

Revisions, additions, deletions and interpretations to this manual will be issued quarterly following discussions at the District Design Engineers' meeting, or on an as-needed basis. Changes will be issued with instructions for insertion into this manual.

Revisions to design publications which are to be implemented sooner than the next quarterly Design Engineers' meeting will be issued as Design Bulletins. These Design Bulletins will be numbered and given an expiration date. The expiration date for Design Bulletins revising the Roadway and Traffic Design Standards will be a maximum of two years from the issue date to allow incorporation of the change in the next edition of the standards. The expiration date for Bulletins revising the other design publications will be 180 days from the issue date.

DESIGN CRITERIA AND REFERENCES

There are many excellent publications on design criteria available to the roadway designer. The following list includes criteria manuals or publications which are required or recommended by the Department for use in the development of highway plans.

1.1 Florida Department of Transportation Published References - Unless otherwise noted, all references are available from Maps and Publications, Mail Station 12, 605 Suwannee Street, Tallahassee, FL 32399-0450 or by calling 904-488-9220.

- o Manual of Uniform Minimum Standards for Design, Construction, and Maintenance for Streets and Highways (Green Book) Adopted by Rule Number 14-15.02
- o Florida's Geometric Design Guide for Resurfacing, Restoration and Rehabilitation of Streets and Highways (3R Manual - Orange Book) Doc No. 625-010-004-a
- o Roadway and Traffic Design Standards (Roadway Design Standards) Doc. No. 625-010-003
- o Policy and Guidelines for Vehicular Connections to Roads on the State Highway System (Driveway Manual) Doc No. 850-010-001-a
- o Standard Specifications for Road and Bridge Construction and Supplements
- o Bicycle Facilities Planning and Design Manual
- o CADD Roadway Standards and Guidelines
Doc. No. 625-010-007 - Available from Office of Design, Attn. CADD Development, Mail Station 32, 904-487-1700
- o Drainage Manual - Doc No. 625-040-XXX

- o Handbook for Drainage Connection Permit
Doc No 625-040-400 (Rule 14-86)
- o Soils and Foundations Manual
Doc No 675-020-012-a
- o Project Development and Environmental Guidelines
Doc. No 625-010-002-a
- o Flexible Pavement Design Manual for New Construction
and for Rehabilitation
Doc No 625-010-002
- o Rigid Pavement Rehabilitation Manual
Doc No 625-010-005
- o Jointed Plain Concrete Pavement Design Manual
Doc No 625-010-006
- o R/W Survey and Mapping Manual
Doc No 575-010-000a
- o Location Survey Manual
Doc No 550-030-000 through 550-030-012
- o Utility Accommodation Guide
710-020-0019 Procedure
- o Value Engineering Design Review Procedure 625-030-0029 -
Available through Value Engineering, Mail Station 40, 904-487-
3982
- o Basis of Estimates Manual
Doc. No. 001-600-210-a
- o Contract Estimating System
Document No. 001-600-200-a - Available only to those who have
completed training from Estimates Office, Mail Station 39, 904-
487-4225
- o Project Management Guidelines

- o Landscaping Guidelines
Doc No. 650-050-001b - Available from Office of Environment,
Mail Station 37, 904-488-2911
- o Railroad Procedures Manual
Doc No 725-080-XXX - Available from Rail Bureau, Mail Station
25, 904-488-5704
- o Structures Design Guidelines
Doc. No 625-020-XXX - Available from Structures Office, Mail
Station 33, 904-488-4756
- o Sample Computation Manual
Doc. No 001-600-215-a
- o Guidelines for Contract Duration
Proc No. 700-010-044-a - Available from Office of Construction,
Mail Station 31, 904-488-4756
- o Design Traffic
Proc. No 525-030-120-a - Available from Highway Systems
Planning, Mail Station 27, 904-488-9745

1 2 American Association of State Highway and Transportation Officials
(AASHTO) Published References:

- o A Policy on Geometric Design of Highways and Streets (Policy
on Geometrics Design)
- o Geometric Design Guide for Resurfacing, Restoration, and
Rehabilitation (R-R-R) of Highways and Streets (Purple Book)
- o A Guide on Safety Rest Areas for the National System of
Interstate and Defense Highways
- o A Policy on the Accommodation of Utilities on Freeway Right-
of-Way

- o A Guide for Bicycle Routes
- o A Guide for Accommodating Utilities on Highway Rights-of-Way
- o A Policy on Access Between Adjacent Railroads and Interstate Highways
- o Roadside Design Guide
- o Standard Specifications for Structural Supports for Highway Signs, Luminaires and Traffic Signals
- o An Information Guide for Roadway Lighting
- o A Guide on Erecting Mailboxes on Highways
- o Guidelines for Value Engineering
- o A Guide for Highway Landscape and Environmental Design
- o Highway Drainage Guidelines

1.3 Federal Highway Administration Published References

- o Manual on Uniform Traffic Control Devices (MUTCD)
- o Standard Highway Signs
- o Handbook of Highway Safety Design and Operational Practices
- o Accommodation of Utility Plant Within the Right-of-Way of Urban Streets and Highways - FHWA-RD-75-8 and 9

1.4 Transportation Research Board Publications.

- o Highway Capacity Manual
- o Policies for Accommodation of Utilities on Highway Rights-of-Way

Chapter 1

DESIGN PARAMETERS

1.1 General

Designs for highway and street projects are normally based on established design standards for the various elements of the project, such as width of roadway, side slopes, horizontal and vertical alignment, drainage considerations and intersecting roads. Selection of the appropriate standards is influenced by traffic volume and composition, desired levels of service, terrain features, roadside developments, environmental considerations and other individual characteristics.

The identification of applicable design controls is basic to providing the desired level of service, optimum safety, and cost effectiveness.

1.2 Traffic

The existing and design year traffic volumes, the traffic composition, directional distribution and design speed are all essential elements to the calculation of highway capacity, levels of service and pavement structural designs. This traffic information must be developed and approved during the programming and Project Development and Environmental (PD&E) studies stages of each project. PD&E studies may not be performed on all projects. When that is the case the necessary traffic studies must be part of the design process.

Preliminary capacity analyses and levels of service calculations will produce the numbers and configurations of traffic lanes required for the project.

Designs shall be based upon the projected traffic volume for the expected service life of the project. The pavement design manuals should be referenced for specific information on design periods. Design Hourly Volume (DHV) shall be the 30th highest hour.

1.3 Capacity and Level of Service

The AASHTO A Policy on Geometric Design of Highways and Streets and the Transportation Research Board Highway Capacity Manual provide the detailed analysis and calculation guides necessary for the number and configurations of lanes required and the resulting levels of service provided. As illustrated in those texts, gradients, roadside developments, number, spacing and types of crossings and intersections, traffic volumes, and signalization patterns all greatly influence capacity and levels of services. Those factors, in addition to the roadway functional classification, have a direct influence on the design speed to be adopted at the preliminary design level.

When the design speed and roadway functional classification (and the resulting geometric controls) have been established, the capacity and level of service analyses will have to be checked and adjusted against the more advanced determination of those variable factors outlined above. For a detailed evaluation of a roadway's level of service, a traffic operations model should be used.

1.4 Roadway Functional Classification

The AASHTO Policy on Geometric Design presents an excellent discussion on highway functional classifications. Florida Statutes, Title XXVI, Chapters 334, 335 and 336 give similar definitions, and establish classifications for road design in the State of Florida.

Those classifications serve as the basis for the "Highway Function and Classification" portion of the section on Planning in the Manual of Uniform Minimum Standards for Design, Construction, and Maintenance of Streets and Highways, known as the Florida Green Book, issued by the Florida Department of Transportation. Much of the design criteria and controls adopted by the Florida Department of Transportation are categorized by those classifications and the design speeds adopted for each of those classifications.

1.5 3R Design

Florida's Design Standards for Resurfacing, Restoration, and Rehabilitation (R-R-R) of Streets and Highways, defines design controls for 3R projects, which are generally less restrictive than the criteria for new construction. These standards do not apply to Interstate or freeway facilities.

1.6 Design Consistency and Driver Expectancy

Design consistency is achieved when the geometric features of the roadway are consistent with the operational characteristics expected by the driver. Inconsistencies normally relate to:

- o changes in design speed.
- o changes in cross section.
- o incompatibility in geometry and operational requirements.

Changes in design speed may occur on a given stretch of roadway because portions of the highway were built as separate projects over an extended period of time. Inconsistencies may be due to a number of factors: changes in standards or DOT policy, re-classification of the facility, and lack of necessary funding.

There are two major types of design inconsistencies relative to cross section. These are point inconsistencies and a general incompatibility between cross section and alignment. A point inconsistency may be, for example, the narrowing of lane widths, a narrow bridge, a lane drop, or a change from multi-lane section to two lanes.

A cross sectional inconsistency is usually the result of upgrading a highway cross section without upgrading the alignment. Sometimes pavements are widened and shoulders added on an older two lane highway. The wider cross section on an old alignment might convey a conflicting message to the driver and lead to an inappropriate expectancy based on the visual aspects of the cross section, because cross section features can be more apparent than the alignment.

Of course, this is not to say that widening creates unsafe conditions. Widening alone can measurably improve the safety characteristics of a road, particularly on very narrow, low-volume roads. Designers should, however, be aware of potential inconsistencies that frequently can be overcome with relatively low cost treatments. In the case of widened roads on old alignments, pavement markings, warning signs, and delineation devices can be very helpful to the driver.

Inconsistencies may also relate to incompatibility in geometric and operational requirements. Occasionally elements of the design appear to have been selected for the purpose of fitting together the geometric components conveniently and economically rather than for the purpose of satisfying operational requirements. An example of an inconsistency resulting from the incompatibility is a direct entry ramp which is intended to permit vehicles to enter the stream of traffic without coming to a complete stop but which, in reality, forces the vehicle to stop when a gap in the traffic stream is not immediately available.

Design inconsistencies can result in driver uncertainty, an increase in response time and an increase in the probability of inappropriate driver response.

Driver expectancy relates to the readiness of the driver to respond to events, situations, or the presentation of information. It can be defined as an inclination, based on previous experience, to respond in a set manner to a roadway or traffic situation. It should be stressed that the initial response is to the expected situation rather than the actual one.

Expectancy can affect the perception and use of information. In most circumstances, the expected and actual conditions are the same. However, when design inconsistencies occur and a driver's expectancy is incorrect, it takes longer to respond properly, there may be no response, or the response may be inappropriate to actual conditions.

There are certain elements in the design of various components of the roadway which particularly affect design consistency, driver expectancy, and vehicular operation. These components include horizontal and vertical alignment, embankments and slopes, shoulders, crown and cross slope, superelevation, bridge widths, signing and delineation and guardrail.

1.7 Aesthetics

Highways are built first and foremost for functional purposes, but the designer should be sensitive to how the highway will be perceived by the users. Designing-in aesthetics is more than just providing for landscape plantings. The roadway should blend into the landscape, avoiding large cuts and fills, and round side slopes into the existing terrain. Horizontal and vertical alignment should be coordinated so that a driver has an opportunity to gain a sense of the local environment. Combinations of horizontal and crest vertical curves, and broken-back curves should be avoided. Excessively long tangent sections become monotonous. Either curvature or other features should be added to maintain drivers interest.

Application of the clear zone concept discussed in Chapter 4 of this volume will result in a clean, uncluttered and pleasing roadside. Landscaping of the roadside should be considered early in the design process, so that plantings blend in with the geometric design. Chapter 9 of this volume discusses landscape design criteria. At times extra right-of-way may be obtained for treatments if the need is identified early. Retention/detention ponds and other wetlands can be attractive if well-designed and placed in a location where they can be viewed from the roadway.

Vistas of exceptional beauty should be accentuated by the roadway geometrics. Ideally, such vistas should be on the outside of horizontal curves, without excessive roadside appurtenances and signs to clutter the view.

"Streetscaping" techniques in urban areas include an emphasis on pedestrian accommodation, trees and other plantings, access control, careful signing, and zoning restrictions on commercial signs. Parkway, and other roads specifically intended for pleasing aesthetics should be designed by a multi-disciplined team including landscape architects and planners.

1.8 Access Management

During the development of construction plans, the designer may need to evaluate some of the access connections within the project limits. Driveways and crossovers should be considered in the analysis of safety and operational problems. Modifications or closures to access may be the solution in certain cases. Rule 14-96 003 (3) & (4) and 14-96 015 gives the Department the authority to alter, relocate or replace connections in order to meet current Department standards. This section also allows DOT to close (or revoke) connections. Furthermore, Section 14-96 011 of the Rule allows the DOT to revoke a permit "if the connection causes a safety or operational problem on the State Highway System substantiated by an engineering study."

Rule 14-97 also provides guidance on the treatment of existing features in the highway improvement process.

14-97 003(1)(b)

(b) For the purpose of the interim standards for the assignment of an access classification to a segment of highway by the Department pursuant to Rule 14-97 004, permitted connections and those unpermitted connections exempted pursuant to Section 335-187(1), Florida Statutes, and existing median openings, and signals are not required to meet the interim standards of the assigned classification. Such features will generally remain in place. These features shall be brought into reasonable conformance with the standards of the assigned classification or the interim standards where new connection permits are granted for significant changes in property use, or as changes to the roadway design allow. Applicants issued permits based on the interim standards as set forth in Rule 14-97 004 shall not have to reapply for a new permit after formal classification of

the roadway segment unless significant change pursuant to Rule Chapter 14-96 and Rule 14-97 002 has occurred

Existing connections that are to remain are not required to be shown on the plans, but are to be reconstructed at their existing location in conformance to standards. Those that are to be altered or closed must be detailed in the plans. In some cases where revisions are necessary due to operational or safety problems, it may not be possible to totally upgrade the connection to the newest standards because of existing conditions or constraints. In these cases, the designer should provide the best solution possible. The designers' efforts should be coordinated with those responsible for access connection permitting in the District (i.e., the District Permits Engineer) and those responsible for access management highway classification (i.e., District Planning). Any changes or revocation of a connection must be made in accordance with Rule 14-96 011.

It is important to note that every property owner has the right to reasonable access. However, this does not mean that the property owner has the right to direct access on the mainline state highway. For example, a corner piece of property may be controlled by only allowing access on the side street. Another option for corner property would be "right-in" and/or "right-out" only (partial access) on the mainline with full access on the side street. Rule 14-97 contains connection spacing and median spacing standards.

It should be noted that if there are any conflicts between this policy and the Rules, the Rules (14-96 and 14-97) shall govern.

Chapter 2

GEOMETRICS

2.1 Standards

The design controls discussed in the previous chapter serve as guides for identifying specific levels of design standards that are most appropriate for various highway functional classifications. This chapter discusses specific standards and how they are to be applied by designers.

Standards adopted by the Department, described herein, generally adhere to the AASHTO design policies. Some specific standards reflect judgments by the Department as to appropriate applications for conditions in Florida.

2.1.1 Fixed Standards.

Some standards are defined in terms of fixed values -- standards for elements such as lane width, shoulder width and bridge width. Widths less than standard would not provide adequate levels of service and safety. Widths greater than standard usually would be a considerable economical investment.

Fixed standards apply principally to projects of new construction. These standards are also desirable for rehabilitation and resurfacing projects, but it sometimes becomes necessary to accept a less desirable standard because of economic, social or environmental considerations.

2.1.2 Design Standard Ranges

Many standards will be expressed in terms of a range of acceptable values. Examples are criteria for elements such as sight distance, degree of curvature, median width, vertical and lateral clearances, and slopes. Many of these elements are closely related to traffic safety. The designer should always attempt to satisfy the mid to upper portion of the range. The lower portion of ranges should be used only when dictated by serious constraints imposed by economics, environmental considerations or similar considerations. While minimum values may be acceptable, the accumulative affect of establishing all critical design parameters at the minimum, may result in a project of marginal safety for motorists, pedestrians and bicyclists. Minimum values may also limit future rehabilitation options.

Many design standard considerations are related directly to the design speed, including vertical and horizontal geometry and required sight distances. Always provide at least the minimum values for these standards, regardless of traffic volumes, functional classification or any other considerations. The minimum design ~~standards~~^{values} are very closely related to traffic safety and cannot be compromised without an approved design exception.

The design speeds adopted for the various functional classifications are given in Table III-1 of the Florida Green Book. It should be noted that some design speeds in that table are in excess of nationally imposed speed limits. An expected low speed limit by itself does not provide a basis for using a low design speed. Maximum degrees of curvature and maximum rates of superelevation are given for those design speeds, for both rural and urban applications, in Table III-3 of the Florida Green Book. Roadway Design Standard Indexes 510 and 511 should be referred to for application of superelevation.

Stopping sight distances and the controls they impose on vertical curvature, developed in AASHTO's Policy on Geometric Design, are repeated in Table III-6 of Florida's Green Book. Established passing sight distances for the various design speeds are also given in that table, along with minimum vertical curve lengths adopted in consideration of highway aesthetics.

2.2 Lane Widths

2.2.1 Through Lanes

Both the AASHTO Policy on Geometric Design and Florida's Green Book tabulate the minimum travelled way widths for two-lane rural local, collector and arterial highways, supplemented by discussions that are intended to provide guidance, but not establish a fixed standard for all conditions. Lane widths for all classifications of urban highways are covered by discussions of acceptable widths for various traffic conditions, right-of-way widths and existing development controls.

In general, lane widths should be as wide as possible (up to 12 feet) whenever it is reasonable and prudent. The following shall be minimum criteria:

Freeways - 12 foot lane widths shall be used. AASHTO Policy on Geometric Design give further guidance.

Arterials (Major and Minor) - 12 foot lane widths shall be used. 11 foot lanes may be used on two lane rural facilities under restrictive or special conditions. In these cases, the file must be documented with adequate justification.

11 foot lane widths can be used for urban curb and gutter sections under at least one of the following conditions:

- a. Right-of-way and existing development are stringent controls.
- b. Facility operates under interrupted - flow conditions.
- c. Low Design Speed (40 MPH or less).
- d. Intersection Design controls are not adversely affected.
- e. Design hour truck volume is 10% or less.

The AASHTO Policy on Geometric Design gives further guidance.

Collectors (Major and Minor) - 11 foot lane widths should be used. 12 foot lanes may be provided on rural two lane highways under the following conditions:

- o Average Daily Traffic (ADT) above 1,600.
- o ADT 750 to 1,600 and design speed in excess of 45 MPH.
- o ADT 400 to 750 and design speed in excess of 60 MPH.

12 foot lanes shall be provided in urban industrial areas when right-of-way is available.

The AASHTO Policy on Geometric Design gives further guidance on selection of lane widths.

Local Roads - 10 foot lane widths should be used on rural roads. Greater widths on rural roads may be necessary as required by Table III-8, Florida Green Book. Urban local roads should be 11 foot lane widths. 12 foot lanes should be used in industrial areas when right-of-way is available.

2.2.2 Transitions of Pavement Widths

When new pavement widths are not substantially greater than the joining pavement, grade differentials are slight and future widening is expected, striped transitions may be considered. An alternative approach is an abrupt change in width, with appropriate pavement markings, reflectors and rumble strips.

2.2.3 Wide Curb Lanes

In addition to the safety benefits for bicyclists, wide curb lanes provide benefits that will improve traffic flow, add to the capacity of the roadway and enhance overall highway safety. Some of those benefits are:

- o Assist a vehicle in turning right into driveways and narrow connecting streets without encroachment into the adjacent lane.
- o Assist a vehicle in entering the roadway from an intersecting roadway or driveway without encroachment into the adjacent lane.
- o Allow a motorist to pass a bicyclist without delay.
- o Reduce the need for vehicles to change lanes because of a bicyclist.
- o Improve drainage in constricted areas.

Wide curb lanes are to be provided as the minimum treatment in conjunction with other roadway improvements (curb and gutter construction) in or within one mile of all urbanized (population 50,000 or more) areas unless right of way is inadequate and the cost associated with acquisition for this purpose is not feasible. For those projects that require additional right-of-way for the construction of the road, the additional

width to provide wide curb lanes will be acquired unless the additional cost is ~~excessive~~. ^{excessive} ~~in these cases~~ ^{In these cases} 11 foot continuous two-way turn lanes or painted medians may be used under interrupted flow operating conditions at ~~low~~ speeds, up through 40 MPH. The presence of heavy truck traffic (design hour trucks greater than 10%) and intersection design controls should be evaluated in reducing the center-most lane to 11 feet. The minimum width for curb lanes is 14 feet, measured from the edge of the adjacent travel lane to the lip of the gutter, or 15 feet to the face of the curb, if the 1 foot 6 inch gutter is not constructed.

Heavily congested roadways with significant levels of commerce and numerous intersections are served best with wide curb lanes that are not marked as a bike lane or bike route. In no case should an edge line be marked 2 or 3 feet in on a 14 foot wide curb lane, since this tends to channel bicyclists into a space that is too narrow.

Wide curb lanes are also to be considered in urban areas (5,000 - 50,000 population) based on anticipated bicycle travel needs as previously identified.

Urban resurfacing projects may include restriping to provide wide curb lanes by using 11 foot interior lanes. This policy may be applied on all appropriate urban and urbanized area (curb and gutter) resurfacing projects.

2.2.4 Other Lane Widths

Collector-distributor lanes and auxiliary lanes for speed change, turning, storage for turning, weaving and other purposes supplementary to through-traffic movement should be of the same width as the through lanes. Left-turn storage lanes may be 10 feet wide where speeds are low and the intersection is controlled by traffic signals. Two-way turn lanes should have a desirable minimum of 12 feet wide and an absolute minimum of 10 feet and should not exceed 15 feet.

Ramp widths are discussed in detail in the AASHTO Policy on Geometric Design.

2.2.5 Bicycle Lanes

Bicycle lanes (4 foot minimum width) may be warranted in lieu of wide curb lanes in some areas of the State. Collectors and the more lightly traveled arterials that have only a moderate level of commerce, and have fewer turning movements, may serve bicyclists with a bike lane.

Roadway sections with low to moderate traffic and where it is desirable to attract bicyclists should be considered for 4 foot wide bike lanes in the initial roadway improvement. A 4 foot minimum width with urban curb and gutter construction or 5 foot minimum width with rural type (no curb) construction will be required.

Chapter 8 of this volume discusses bicycle facility design criteria in detail.

2.2.6 Shoulder Widths

Shoulder width criteria are provided in the AASHTO Policy on Geometric Design and the Florida Green Book. In addition to the suggested and minimum criteria presented in those volumes, it is the Department's policy that 4 foot paved shoulders are required on all new construction, reconstruction and lane addition projects for rural, open drainage, free access highways of the following types (does not apply to urban curb and gutter construction):

- a. On all two-lane principal arterial highways.
- b. On all other two-lane highways with a post construction ADT of 5,000 or greater.
- c. On the outside shoulder of all rural multilane facilities. The inside shoulder may be paved 2 feet in those areas of the State where establishing and maintaining a turf shoulder has been difficult. The inside shoulder will be paved (4 foot minimum) on the low side of pavement through superelevated curves, and extended approximately 300 feet beyond the P.C. and P.T. of the curve, irrespective of other conditions. Roadway Design Standard Index 104 contains additional criteria for paved shoulders.
- d. On all coastal routes where material is of poor quality for growing grass. This will generally be within 1/2 mile of the coast but may extend beyond this on some projects. A project-by-project evaluation based on discussions with construction and maintenance personnel will be necessary.
- e. On all projects in or within one mile of urbanized areas with a post construction ADT greater than 1600.

- f. On other projects in urban and rural areas, based on safety and operational needs (including anticipated bicycle travel) .
- g. On projects within 5 miles of urbanized areas where adjacent development is such that significant pedestrian travel would be expected and post construction ADT will exceed:

Two lanes - 5,000

Four lanes - 20,000

- h. Two to four foot paved shoulders can be used in other areas where pavement dropoffs or problems with turf shoulders exists. Maintenance and construction personnel should be consulted for applicable locations

Roadway Design Standard, Index 104 (Erosion Control Details for Permanent Construction) should be applied on all projects. Index 105 should be applied at the edge of shoulder pavement on existing facilities.

Specific widths have also been adopted for interstate, expressway, single and double lane ramps and collector-distributor road shoulders. Total shoulder widths, paved shoulder widths, widths of paved shoulder separations between through pavement edge and the near edge of any shoulder gutter are given for both right (outside) and left (inside) edges of the roadway. These widths and clearances are illustrated in Exhibit I-2-A.

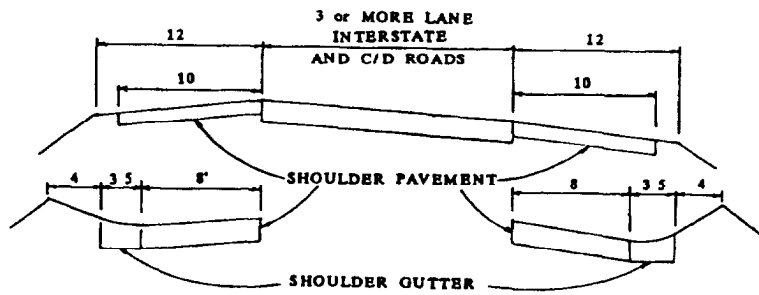
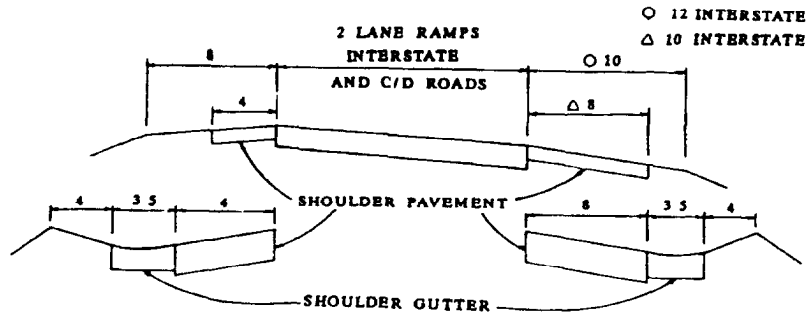
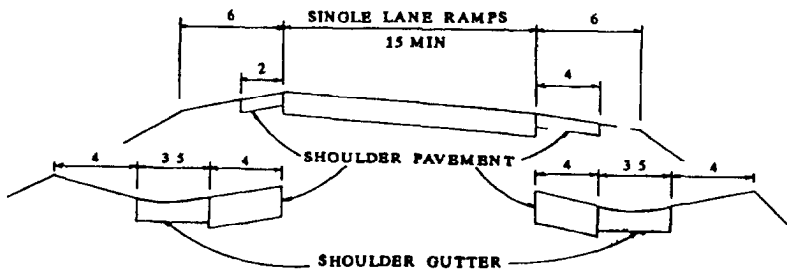

6 for 1 & 2 LANE RAMPS,
INTERSTATE and C/D ROADS
10 for 3 or MORE LANE
INTERSTATE and C/D ROADS

6 for 1 LANE RAMPS and
ADJACENT TO AUXILIARY LANE
10 for 2 LANE RAMPS
INTERSTATE and C/D ROADS



* ROADWAY CROSS SLOPE MAY BE USED TO ELIMINATE
INSIDE DRAINAGE STRUCTURES IF OUTSIDE LANE WATER
SPREAD IS ACCEPTABLE

C/D-COLLECTOR/ DISTRIBUTOR

INTERSTATE AND EXPRESSWAY SHOULDER WIDTHS

It is desirable to pave the outside shoulder and adjacent area under overpass bridges on all projects that do not normally include paved shoulders. This shoulder pavement will provide additional safety, enhance drainage, reduce maintenance and improve appearance. When paved shoulders are not normally provided, indicate paving for the outside shoulders in accordance with Exhibit Ex-I-2-B.

2.2.7 Limits of Friction Course on Shoulders

Friction courses on limited access facilities shall be extended one foot onto both the median and outside shoulders. FC-1 or FC-4, if used on ramps, may be extended one foot onto both the inside and outside shoulders.

Friction courses (FC-1, FC-2 or FC-4) should be extended the full width of the shoulder on free access highways because of bicyclist usage. Terminating the friction course at the edge of travel lane or within the paved shoulder is considered to be a safety problem for bicyclists since they must cross over the drop-off. Bicyclists in rural areas use the mainline pavement and cross to the shoulder when a car approaches from behind. Most paved shoulders on free access facilities are 4 foot in width.

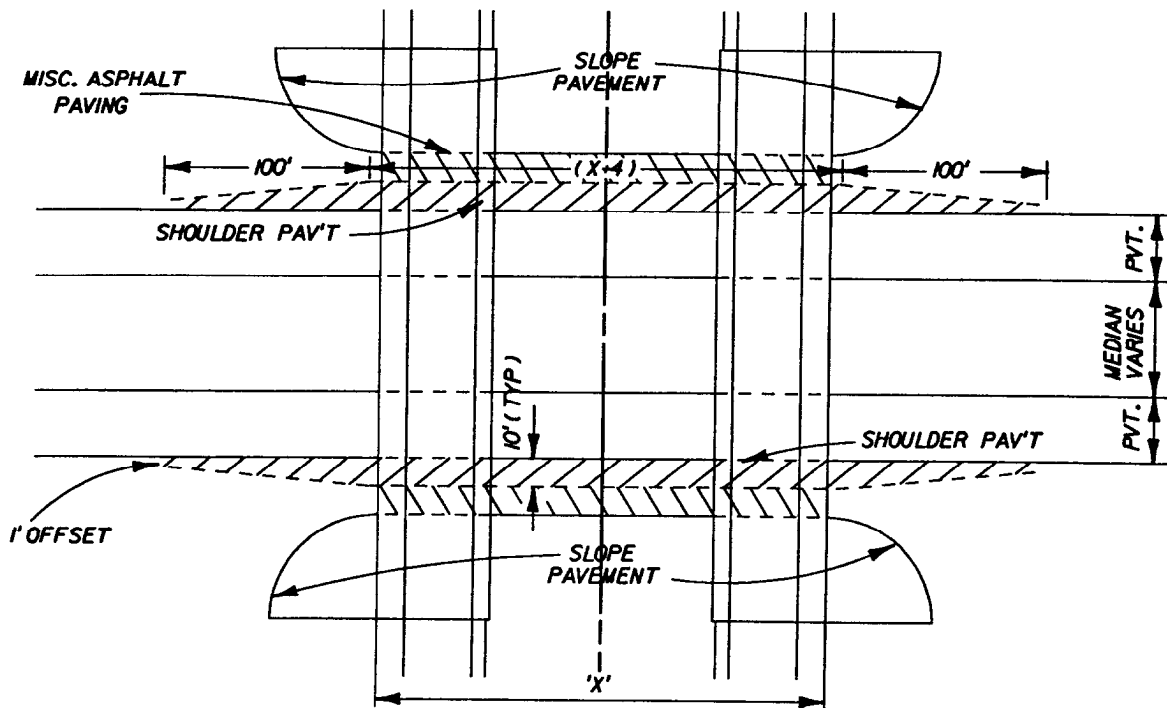

DIVIDED HIGHWAY OVER DIVIDED HIGHWAY

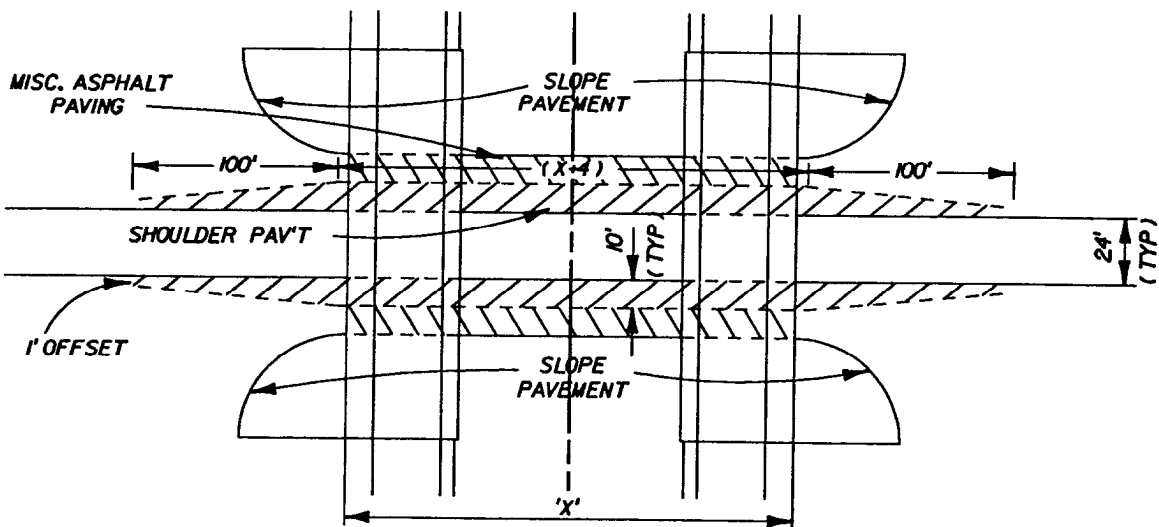

DIVIDED HIGHWAY OVER UNDIVIDED HIGHWAY

ADDED PAVED SHOULDERS
EX-I-2-B

2.3 Other Cross Section Elements

2.3.1 Cross Slopes

| Standard pavement cross-slopes are defined for the sections shown in Exhibit
| EX-I-2-C. The maximum pavement cross slope is 0.04 ft/ft for design speeds
| of 45 mph or less and 0.03 ft/ft for speeds greater than 45 mph. The
| maximum number of through lanes with cross slope in one direction is three
| lanes. The change in cross slope between adjacent lanes should not exceed
| 0.01 and crown crossover shall not exceed 0.04.

| Shoulder cross slope should be greater than the cross slope of the adjacent
| travel lane. High quality shoulders should have a cross slope of
| approximately 0.05 to 0.06 foot per foot. Shoulder cross slopes for standard
| sections shall not be less than 0.03 or greater than 0.08 foot per foot. The
| algebraic difference in cross slopes between a traffic lane and the adjacent
| shoulder should not exceed 0.07 foot per foot.

Chapter 4 of this volume discusses the safety requirements of slopes and other cross section elements in detail.

2.3.2 Roadway Structure

The type of pavement usually is determined by analysis of the volume and composition of traffic, the soil conditions, the availability of materials, the initial cost and the estimated cost of maintenance.

Criteria and procedures for selecting the type of pavement and the structural design of the various surfacing courses are discussed in the pavement design manuals.

STANDARD PAVEMENT CROSS SLOPE, ALL LANES ONE DIRECTION

NEW CONSTRUCTION AND RECONSTRUCTION

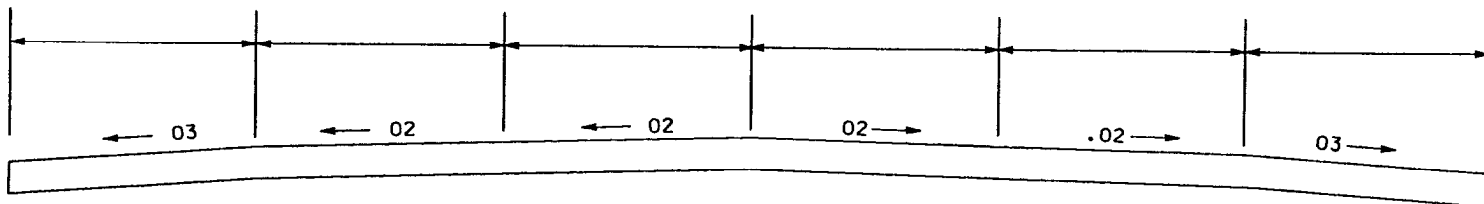
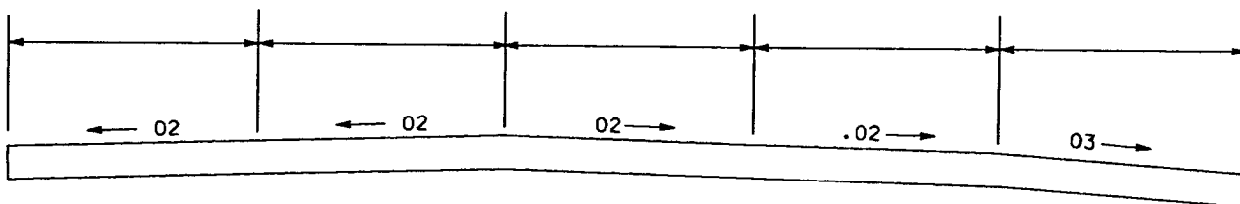
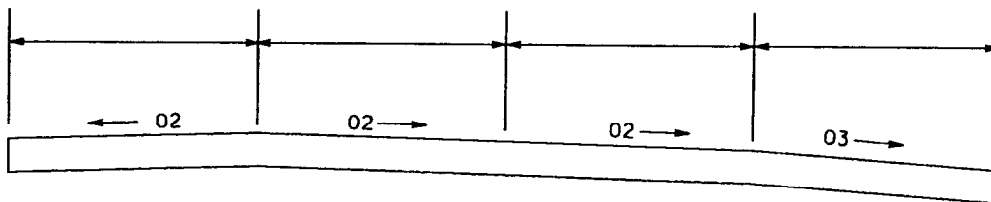
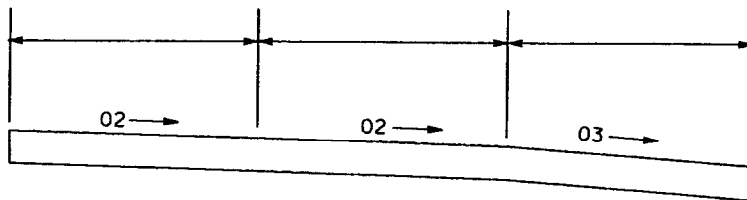
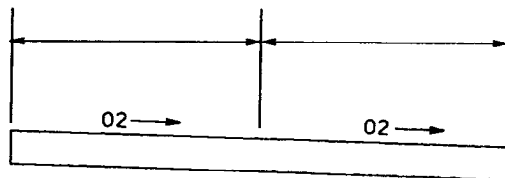

Exhibit EX-I-2-C

2 3 3 Side Slope and Side Ditches

Volume II of this manual discusses the layout of side slopes and ditches in detail. Variations imposed by parallel ditches or canals, barriers and clear zone requirements are addressed in Chapter 4, Roadside Safety, in this volume.

2 3 4 Border Width

Border width requirements for urban collector and arterial highways for new construction or major modifications to existing facilities (with curb or curb and gutter), require a separate set of design controls, as discussed below.

The standard border width is 10 feet, measured from the edge of pavement to the right-of-way line. Wider border widths may be justified under some conditions, i.e. in areas with overhead utilities.

- | The standard sidewalk width with a minimum 2' grass strip adjacent to the curb is 5 feet. When the sidewalk is adjacent to a curb, the width of the
- | sidewalk shall be a minimum of 6 feet.

2.4 Horizontal Alignment

2.4.1 General

Design speed is the principal factor controlling horizontal alignment. Several geometric standards related to design speed are very specific. Other criteria cannot be defined as specifically and require that judgments be made by designers in consideration of local conditions. Guidelines for some of these decisions are outlined in Section III of the Florida Green Book. Limiting values on degrees of curvature are also given in the Green Book, Section III.

2.4.2 Supplemental Alignment Control

Further guidelines have been established by the Department for lengths of horizontal curves, maximum deflections without curves, redirection of through lanes at intersections and minimum transition lengths between reverse curves. The criteria given below are intended for use in establishing minimum lengths for both rural and urban conditions.

Wherever the criteria differ for different types of facilities, the term "interstate" shall mean "interstate and other high speed controlled access facilities", the term "rural" shall mean "rural arterials and collectors and urban arterials and collectors with open drainage", and the term "urban" shall mean "urban arterials and collectors (curb and gutters with design speed 45 MPH or less)."

Table 2.1
Length of Horizontal Curves

Desirable length =	30(S) (INTERSTATE)
	15(S) (RURAL & URBAN)
Minimum length =	15(S) (INTERSTATE)
	500 Foot (RURAL)
	400 Foot (URBAN)

Where S = Design Speed

The desirable length should be provided to the maximum extent practical on new construction projects. The minimum length may be necessary for major modifications of existing facilities and environmentally sensitive areas. Values less than the minimum stated for interstate may be necessary in developed or environmentally sensitive areas.

For small deflection angles (5° or less) curves should be suitably lengthened to avoid the distracting appearance of a kink. Curves should be at least 500 feet long for a central angle of 5° and the minimum increased 100 feet for each 1° decrease in the central angle (900 feet for a 1° central angle.) This treatment may not be practical in developed or environmentally sensitive areas or for major modifications of existing facilities.

For design, the aesthetic control given above should be considered where practical, but may be compromised where other considerations warrant such action. Discernment of alignment changes in an urban setting is normally minimal due to the masking effects of development, traffic signs, various items of interest and similar distracting stimuli.

Curves should be of such length to provide at least a minimum of 200 feet of full superelevation within the curve when superelevation is required

The length of curves for turning roadways may be less, but sufficient length for superelevation should be provided. The lengths shown in Table III-18 of the AASHTO Policy on Geometric Design, should be used for compound curves on turning roadways

Curves are required on all interstate and rural roads with a design speed > 45 mph when a deflection of over 0°45' occurs in alignment on the open highway

Curves are required on arterials and collectors when deflections on the open highway exceed the following

Design Speed equal to or less than 40 MPH - 2°00'

Design Speed equal to 45 MPH - 1°00'

For redirection of through lanes at intersections the formula $L=WS$ should be used for speeds of 45 MPH or greater and $L=WS^2/60$ for speeds of 40 MPH or less, where "L" is the length of taper in feet, "W" is the width of lateral shift in feet and "S" is design or posted speed in MPH. Curves are not required if these formulas are used

Short curves may be desirable at the above locations in lieu of angular breaks. If the maximum deflection without curvature as given above is not exceeded, the minimum length of curve given in the AASHTO Policy on Geometric Design does not apply for design and superelevation is not required

The general controls for horizontal alignment shown in the AASHTO Policy on Geometric Design and Section III of the Florida Green Book, should be used to the extent practical

| A related area is the tangent length between reverse curves. This desirable tangent length should be determined as follows:

- 80% of the transition for each curve should be located on the tangent
- The desirable tangent length is the sum of the two 80% distances
- Where alignment constraints dictate a less than desirable tangent length, AASHTO allows reduction of the 80/20 superelevation transition treatment, (i.e., 20% to 50% of the transition may be placed on the curve)

Sound engineering judgement for establishing the horizontal curve lengths and transition lengths between reverse curves should always be used. Before utilizing lengths less than noted above, full documentation and justification should be placed into the project file. Transition lengths should be sufficiently long to take water off the pavement without allowing it to flow back across the pavement.

Compound curves should be avoided, especially when curves are sharp. They tend to produce erratic and dangerous vehicle operation. When compound curves are necessary, the radius of the flatter curve should not be more than 50% greater than the sharper curve.

2.4.3 Two Lane to Four Lane Transitions

Transitions have been developed and included in the Roadway and Traffic Design Standards to eliminate reverse curvature alignment, to provide suitable length for pavement marking transitions, and to control development at the end of limited access right-of-way at interchange locations.

2.5 Vertical Alignment

The profile grade line defines the vertical alignment for road and street construction. As with other design elements, the characteristics of vertical alignment are influenced greatly by basic controls related to design speed, traffic volumes, functional classification, drainage and terrain conditions. Within these basic controls, several general criteria must be considered. These considerations, along with some specific limiting values, are presented in Section III of the Florida Green Book.

The Department's minimum for structure clearance over all highways provides for 16 feet. Exceptions to this policy shall be permitted only when justified by extenuating circumstances. This clearance should be increased on new facilities to allow for resurfacing. Increased clearance from 16 foot-3 inches to 16 foot-6 inches is recommended. The Structures ^{Design Guidelines} ~~Manual~~ should be referenced for details on clearances for all types of structures.

Clearance required above design high water for roadway base courses, as well as the limiting relationships between shoulder/pavement elevations vs. high water and flood elevations, are discussed and charted in Chapter 6, "Roadway Grades," Volume 2A of the Florida Drainage Manual.

Clearance over major underground utilities is also a vertical alignment control.

and Traffic

The Roadway/Design Standards Index 205 & 280 lists minimum covers and maximum fill heights for all types of ~~culverts~~ culverts.

2.6 Superelevation

Superelevation and transition standards and the application of those standards are discussed and detailed in the Florida Green Book and the Roadway Design Standard Indexes 510 and 511. Further discussion, illustrations and charts are to be found in Chapters III and VI thru IX of the AASHTO Policy on Geometric Design. The AASHTO publication covers the full range of design values, therefore, the use of those design guides and aids is restricted by maximum and minimum rates established for use in Florida.

2.7 Cross Sections

The mechanical composition of cross-section sheets is described, and examples of completed cross-section sheets are given, in Volume II - Plans Preparation and Assembly.

The cross section is the most widely used tool today for the depiction and measurement of the various earthwork volumes that are part of all highway construction projects. Cross sections are used in the review process to check construction clearances and utility adjustment requirements, the appropriateness of roadway and ditch side slopes and adequacy of right-of-way. Their importance as a design tool is often overlooked.

The designer should use the development of the final cross sections as a step by step guide in assuring the proper fit of the various items to be included in the construction plans. As cross section elements are assembled, they provide clear evidence of the incompatibility of certain design features, thus allowing adjustments to be made, or exceptions to be verified, before other designs and plan developments have advanced to a point that revisions would be cumbersome and costly.

Cross section preparation and study is also an essential element in the preparation of staged construction plans, sequence of construction and traffic control plans, particularly where there are detour or bypass alignments to be considered.

2.8 Intersections and Interchanges

Design guides and criteria presented heretofore are also applicable to the proper design of intersections, including interchanges with their inherent ramps, speed change, merging and weaving lanes. Because high speed maneuvers and at-grade merging and crossing patterns impose additional responses and responsibilities upon the driver, it is incumbent upon the designer to ease those driver decisions and responses to the extent possible. Additional and extended criteria and guidelines are necessary for the designer to accomplish his tasks in a manner that will provide safety, reliability and uniformity for the driver.

Where curb is desirable for delineation and channelization, at islands on rural highways, the full approach shoulder width on the main roadway should be carried through the interchange or intersection. On urban sections this curb should not encroach on the refuge lane (if provided on the approach section) and the full section should be carried through the intersection or interchange.

The criteria and guidelines necessary are presented in Sections III-Geometric Design, Subsections 8 & 9 - "Access Control and Intersection Design" of the Florida Green Book. Chapters IX and X of the AASHTO Policy on Geometric Design and the TRB Highway Capacity Manual should also be referenced. They provide invaluable aids for the proper design of high speed weaving sections and at-grade intersection layouts. Their use should only be restricted by specific individual parameters adopted by the Department.

2.9 Limited Access Limits at Interchanges

The following criteria will be used in establishing limited access limits along crossroads at interchanges

For rural interchanges, limited access will extend along the crossroad to a point 300 feet minimum beyond the end of the acceleration or deceleration taper. In the event these points are not opposite, the point most remote from the project will be the control and the limited access on both sides will end at that station along the crossroad. Where no taper is used, the limited access will be carried to a point 300 feet minimum beyond the radius point of the return. In this case also, the radius point most remote from the project will control.

For interchanges in urban areas, the criteria given above will apply except that the limited access will end a minimum of 100 feet beyond the end of taper or the radius point of the return.

In both cases of interchanges in rural and urban areas, a cross-over may be centered no less than 50 feet beyond the end of limited access except that a minimum distance of 660 feet to the ramp median opening will be required. In no case should access be permitted between the interchange proper and the cross-over as established by this criteria.

For partial cloverleaf, the limited access right-of-way along the cross road on that side having no ramp will extend to a point opposite that point controlled by the ramp.

Special cases or exceptions to the above will have to be handled on an individual basis and must be fully supported by realistic right-of-way cost information and other pertinent data covering any recommended alternative.

Revised 12/06/90

2.10 Design of Rural Projects

Highway designs should begin with the following steps

- 1 Familiarization of the squad leader with pertinent project data
2. Indexing field notes
3. Checking field notes
- 4 Drawing proposed typical section or sections
- 5 Plotting alignment, existing topography, underground utilities and ground line profile in plan
- 6 Outlining the drainage map
- 7 Plotting alignment, topography and profile of outfalls

All alignments should be reviewed for undesirable alignment and aesthetic effects such as broken curves, curves in opposite directions with insufficient intervening tangent, curvature exceeding the maximum for the design speed, etc , and a study made of possible remedial measures by realignment A check should also be made of undesirable horizontal-vertical curve combinations

2.10 1 Profiles

After determining that the horizontal alignment is satisfactory, a tentative grade can be established. Existing structures, including major utility facilities, are plotted in plan and profile Several factors influence the choice of grades as listed below

- o A minimum stopping sight distance, based on the design speed, should be maintained throughout the entire project The minimum length of vertical curves will be adhered to as established by the Florida Green Book Values approaching, or at the upper limit of, the range should be used for design wherever conditions permit

- o Established clearance between the bottom of base and design high water (DHW) must be maintained. Superelevation of curves must be taken into account. Standard clearance values for FDOT standard base options and subgrade materials are as follows:

Interstate, Expressway and Rural-type Section Multi-Lane

Mainline	3 feet
Ramps	2 feet
Ramp Terminals at Crossroads	1 foot
Rural Two-Lane (ADT > 1500 vpd)	2 feet
All Other Facilities Including Urban	1 foot

The elevation of the design high water should be obtained from the drainage engineer. Clearances other than those above should only be set after input is received from the pavement design engineer, the geotechnical engineer, and the drainage engineer and must be fully documented in the project file.

Note: Guidance on determination of DHW is contained in Chapter 6, Volume 2A of the Drainage Manual.

- o Grades should not exceed the established ranges, maximum or minimum.
- o Soils data should be examined for the possibility of eliminating or reducing the undercutting of unsuitable material.
- o Crest vertical curvature that results in restricted passing sight distance for two lane roads should be avoided.

- o Sizes of existing drainage structures may give some indication of drainage requirements and allow establishment of grades that will provide the required cover
- o When railroads are crossed at grade, the proposed grade must meet the rail elevations. The District Railroad Coordinator can determine if a railroad track adjustment is necessary or planned by the railroad company. The grades of intersecting streets or highways also should be matched as closely as possible.
- o Economy of construction is an important factor in establishing grades. Total earthwork should be held to a minimum. When practical, cuts should produce sufficient material for construction of fills.

2 10 2 Cross Sections

The roadway cross section ground lines can be plotted using the tentative grade for spacing the sections. The ground line, ground line elevation at the centerline of survey, and the station number are then plotted. Cross sections at driveways are also plotted as necessary to determine access requirements. These may be prepared for file documentation only and not for plans insertion.

Prints of the typical sections, cross sections, plan and profile sheets will be sent to the District Geotechnical Engineer for use in obtaining soils data. Any subsequent changes in alignment, grade or typical section should be forwarded to the Geotechnical Engineer for reconsideration of recommendations. All projects with unsuitable materials, whether they are to be removed or left in place, should have the Phase III plans reviewed by

the Geotechnical Engineer for final concurrence The District Drainage Engineer needs similar information for grade review

Outfall and infall ditch surveys can now be plotted Alignment, topography and profile for each ditch are plotted Cross sections are plotted after it has been determined at which locations outfall ditches will be constructed Property lines should be shown to assure field consideration of right-of-way takings, including access The preliminary plan and profile sheets will be used in the field inspection of drainage and later in establishing lateral ditch grades

The roadway cross section templates are plotted now Any special ditches should be planned at this stage On superelevated curves in well drained soils, the same elevation for both ditches need not be maintained unless drainage considerations dictate otherwise The standard depth ditch is 3 5 feet deep, measured from the shoulder point Use of standard depth ditch design in superelevated sections must be carefully considered The shoulder point varies with superelevation and could create steep grades or flat spots Consider the use of special ditches in these areas or note that the ditch is to be measured at an adjusted depth Special ditch grades must be used when necessary to avoid water pockets The use of too flat a ditch may create a trapped or poorly drained area and potentially have water reach the pavement under severe rainfall events

Only the total thickness of the pavement structure needs to be plotted on the templates

2 10 3 Preliminary Review

The grades can now be re-examined for possible improvements such as

- o Elimination of poor grade alignment combinations
- o Improved passing sight distance
- o Avoidance of unnecessary handling of unsuitable material
- o Accommodation of special conditions revealed by examination of the plotted roadway cross sections
- o Improved match with existing side streets, driveways, railroad grade crossing and other controls

2.11 Design of Urban Projects

Many procedures discussed in Section 2 10 are also applicable to the design of urban projects. Since these procedures have been discussed, complete descriptions will not be repeated. Opportunities for blending roadways into an urban environment for aesthetic effect should not be overlooked.

2 11 1 Preparation

The first several steps in urban plans preparation are the same as for rural projects.

The location of outfalls for urban projects frequently cannot be determined until the storm sewer system is designed, so that operation may be deferred. Outfall and retention/detention locations may dictate the design.

In urban type construction, there is usually relatively little departure of grade from the existing ground, so variation in spacing of cross sections seldom is necessary. Existing pavement must be plotted. It is especially important to show existing pavement such as service drives, parking areas and similar construction at the right-of-way line. Driveways may need to be plotted in cross section when it is necessary to establish right-of-way limits.

Underground utilities are plotted using standard symbols as in rural plans preparation design. Front of building and other improvements near the right-of-way line are indicated at the correct distance from the centerline, and existing floor elevations are shown. Underground storage tanks should also be shown.

2.11.2 Geometrics

The geometric layout is plotted, including proposed sidewalk, curb and gutter returns at intersecting streets, median curbs, traffic separators and left turn storage and other auxiliary lanes. Proposed right-of-way lines are indicated. Care must be exercised to insure conformance of geometrics to the approved typical section and design criteria for the project.

Connections with intersecting streets are centered on the street dedications, except in rare cases when an existing street with curb and gutter is off center and proposed construction must meet existing construction. Offset, if any, to the centerline of pavement should be shown. A minimum width of 24 feet face to face of curbs is used for side street connections. Standard widths should be used for side streets except when connections must conform to existing curb and gutter sections. Right-of-way should accommodate future turn lanes on intersecting streets if the need for such lanes is anticipated.

2.11.3 Profiles

Profiles used for establishing back-of-sidewalk grades now are plotted.

Grade requirements for urban projects are quite different from those for rural projects. Ideally, the proposed grade for the back of the sidewalk should match the existing ground in profile. This condition rarely occurs except for short distances if back-of-sidewalk grades are established in accordance with design criteria, and compromise grades are selected which will minimize damage to adjacent property and reduce drainage complications.

To establish back-of-sidewalk grades, profiles along each proposed back-of-sidewalk location are plotted against the same elevation datum. These profiles usually are plotted from elevations obtained from roadway cross sections at the proposed back-of-sidewalk location. This method is satisfactory when sufficient cross sections or part sections are available to produce a reasonably accurate profile.

Cross sections will be used to establish direction of drainage arrows which are placed above and below the profile. Care must be taken to avoid plotting invalid or misleading elevations, which would be the case if the right-of-way line were to fall in an existing ditch. In this event, the ground line immediately beyond the ditch limits should be plotted.

Elevations and limits of floors, locations of building entrances, and limits of existing pavements along the right-of-way line are indicated. Limits of private drives and entrance walks need not be shown.

Tentative grades for back-of-sidewalk profiles now are established by plotting grade lines as close as possible to existing ground at the back-of-sidewalk location using the following criteria

- o The desirable minimum tangent length of the grade line is 300 feet, with an absolute minimum of 250 feet unless otherwise specifically authorized
- o A minimum longitudinal gradient is important for a curbed pavement, since it is susceptible to stormwater spread. Flat gradients on uncurbed pavements can lead to a spread problem if vegetation is allowed to build up along the pavement

Gutter grades should not be less than 0.3 percent for curbed pavements. Grades can be maintained in very flat terrain by use of a sawtooth profile.

To provide adequate drainage in curbed sag vertical curves, a minimum slope of 0.3 percent should be maintained within 50 feet of the low point in the curve. This is accomplished where the length of the curve (L) divided by the algebraic difference in grades (A) is equal to or less than 167 ($L/A = K \leq 167$). Special gutter profiles should be developed to maintain a minimum slope of 0.3 percent to the inlet. Although ponding is not usually a problem at crest vertical curves, on extremely flat curves a similar minimum gradient should be provided to facilitate drainage.

- o Vertical curves will be required for breaks in grade as shown in the Florida Green Book

- o The high point should be at or near the centerlines of cross streets where possible
- o The placing of low points in the grade at locations which would be detrimental to existing development, such as in intersections, should be avoided
- o Standard clearance above high water elevations should be maintained. Methods of controlling high water, such as underdrains, should be included in the design only as a last resort

The grade must be such that the back-of-sidewalk will not be above building floor elevations at entrances, particularly in the case of buildings at or near the right-of-way line. The grade should be sufficiently lower than floor elevations to allow for provision of adequate drainage away from the entrance. If, at all practical, the grade of the sidewalk should be such that water will not be ponded behind it at locations where ground slopes toward the project. It is generally undesirable to have fill sections at the back of the proposed sidewalk. In case of a definite cross slope of the ground from one side of the project to the other, a compromise grade, compatible to the property development is established, with cut on one side and fill on the other.

Curves requiring superelevation should be avoided in urban areas. When necessary, separate profiles must be used for establishing grades for the right and left back-of-sidewalk.

Occasionally, a situation will arise where extensive development exists on both sides of the street and the ground of development on one side is somewhat higher than on the other. In this situation, a grade line fitting existing development on one side may cause extensive property damage on the opposite side.

In such cases, a reversed crown section may be used on one roadway. Separate profile grades would be required for each side. During transitions from reverse crown to normal sections and in superelevation transitions, care must be taken to avoid gutter grades that are less than the minimums. When preliminary back-of-sidewalk grades have been established, proposed sidewalks are plotted on prints of roadway cross section sheets. The prints are examined carefully for every possible improvement of grades and revised, if necessary.

2.11.4 Cross Sections

~~Preliminary~~ ^C Gross sections are prepared in a similar manner as described in Section 2.8.2 for rural projects. However, special emphasis should be placed on matching existing streets, business drives, etc. and allowing for proper drainage.

2.11.5 Preliminary Review

The preliminary on-site review is now in order, the primary purpose of which is to determine feasibility of the geometrics and to make a careful review of proposed grades. A preliminary drainage inspection also may be made at this time, designating possible outfalls. However, the final drainage system design naturally will depend upon the final grades adopted.

The most important function of preliminary review is to carefully study the proposed grades, and to note any possible improvements. Of particular importance is the matching of grades at entrances of commercial buildings, parking areas, service station drives, etc. Matching of grade at side street intersections also is reviewed carefully. Conditions not evident in location field notes should receive careful attention, and notes concerning possible improvements should be made directly on preliminary prints.

Frequently, state highways slated for improvement are in fast growing areas. Notes on development, that has taken place subsequent to the location survey, should be made, and the District Location Surveyor notified so pertinent additional field information can be obtained. Close coordination with the District Permits Engineer is necessary.

The proposed geometrics at street intersections must be reviewed. This includes the location and appropriate width of side street connections and median openings, turning and storage lanes, and design of channelized intersections, railroad crossings, etc.

CHAPTER 3

EARTHWORK

3.1 General

Earthwork is a generic term for all items of work, materials and operations required to construct the excavated areas and the embankments of a highway project. Sections 120 and 125 of the Standard Specifications define the terms, method of measure, basis of payment and pay items associated with earthwork

In general, earthwork on a highway project consists of

- (1) **Classified Excavation** - Earthwork designated as Regular (Roadway and Borrow), Subsoil, Lateral Ditch and Channel Excavation
- (2) **Unclassified Excavation** - Excavation, removal and disposal of material, for pipe culverts, bridge foundations, box culverts, storm sewers, inlets, manholes and similar structures where the materials are unclassified and considered as excavation regardless of the material encountered
- (3) **Embankment** - Compacted fill material needed to construct the roadway, excluding the base and pavement portions of the roadway and shoulders. Embankment includes compacted backfill to replace unsuitable material excavated within the lines and grades shown in the plans

EARTHWORK

BASIC PROCESS

The most important operation involving earthwork is constructing the roadbed. The roadbed is constructed by excavating soil from CUT sections -- and placing soil as embankments in FILL sections. In cut sections, the roadbed is built below the natural ground -- the natural ground is excavated to the elevation of the proposed roadbed. In fill sections, the roadbed is built above the natural ground -- the earth fills an embankment.

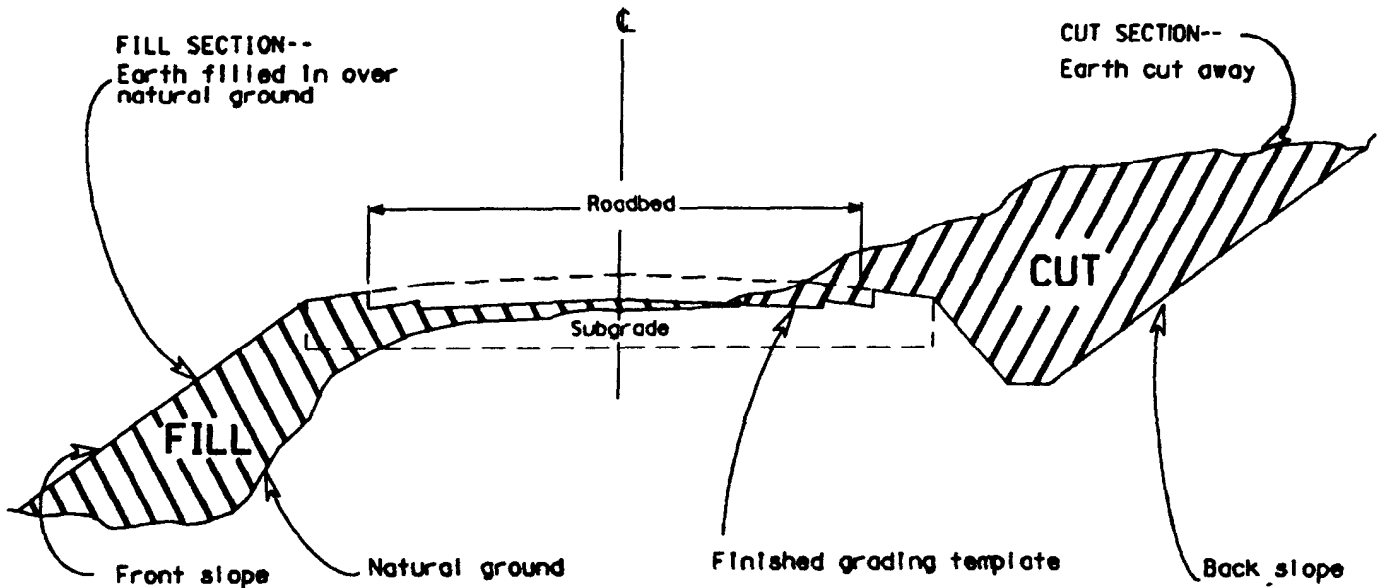

EX-I-3-A

3.2 Classification of Soils

The Department uses a system of soil classification which places materials into groups and subgroups based on soil fracture, liquid limit and plasticity index. This classification determines if and where the materials may be placed or left in their original position on a highway project. The designer cannot determine the proper removal and utilization of earthwork materials until the soils survey, testing and classification of materials has been performed by a qualified geotechnical laboratory. For more details, see Chapter 17, Volume II of the Plans Preparation Manual and Index 305, Roadway and Traffic Design Standards.

3.3 Removal and Utilization

Earthwork is a major cost component of highway construction. The accurate detailing, utilization and calculation of earthwork is a very important part of the design effort. Earthwork is not a simple task, but with proper care and attention, very accurate quantities can be determined.

3.3.1 Criteria for Earthwork Details

The details of removal and utilization of earthwork are shown on the roadway cross sections. The cross sections of the existing surface are usually obtained by location field survey or photogrammetry. The finished profile grades, typical section details, pavement design details, superelevation and horizontal alignments are used in combination to develop the finished roadway template at each location where an existing cross section was obtained. Sometimes it is advisable to develop and plot intermediate cross sections or half-sections to accurately determine quantities.

- | For resurfacing and minor widening and resurfacing projects, refer to
- | Section 3.5.7 of this Chapter

Additional criteria used for plotting the earthwork details are found in the Standard Specifications, Section 120, the Roadway and Traffic Design Standards, Indexes 500 and 505, and Chapters 13, 15, 17 and 18, Volume II of the Plans Preparation Manual.

3 3 2 Cross Sections - A Design Tool

Roadway cross-sections cannot be finalized until late in the design process. However, preliminary cross section templates, developed early in the design process, can assist the designer in establishing many of the other design elements such as guardrail, shoulder gutter, inlets and special ditch grades. Preliminary cross sections are also used in performing the Soils Survey. Cross section templates should be plotted as soon as the alignment, grades and typical section details are established.

3.4 Earthwork Quantities

3.4.1 Method of Calculating

Earthwork quantities can be accurately determined by computer or by plan calculation, if proper care is taken. Therefore, the specifications allow it to be designated for payment as the original plan quantity unless determined to be substantially in error. Earthwork quantities are calculated by the method of average end areas.

$$\text{CUBIC YARDS} = \frac{(\text{EA1} + \text{EA2})}{2} \times \text{LENGTH (FT)} \div 27$$

Each set of end areas for the different types of earthwork (cut, fill, subsoil, etc.) are calculated separately and shown in the appropriate column on the cross section sheets, as indicated in Volume II, Chapter 18, PPM.

3.4.2 Suitable and Unsuitable Materials

Select material or suitable material and plastic, muck or unsuitable materials are calculated and tabulated separately. Material is also summarized in pay item categories as Roadway Excavation, Subsoil Excavation and Embankment or Fill. The designer must be familiar with the material classes, basis of payment and the specifications for earthwork operations in order to properly delineate and calculate earthwork quantities.

**TABULATION OF UNSUITABLE
MATERIAL ON LEFT SIDE OF
CROSS SECTION SHEETS**

(1) A-7 MATERIAL A-8 MATERIAL A-2-5, A-2-7, A-5 MATERIAL					
(2) SUBSOIL EXC		(3) RDWY EXC		(4) FILL	
A	V	A	V	A	V

**TABULATION OF SUITABLE
MATERIAL ON RIGHT SIDE
CROSS SECTION SHEETS**

(5) A-2, A-3 MATERIAL					
(6) SUBSOIL EXC.		(7) RDWY EXC		(8) FILL	
A	V	A	V	A	V

(1) UNSUITABLE MATERIAL on a project may consist of one or more of the classifications shown. The tabulation should be "titled" with the actual classification for the given project as documented by the soil survey.

(2) SUBSOIL EXCAVATION (UNSUITABLE) is material that does not meet the specification requirements in its original position so it must be excavated and backfilled with suitable material. It also must be below the finished grading template to be subsoil excavation.

(3) ROADWAY EXCAVATION (UNSUITABLE) is material that may be used in the earthwork only as stipulated in the standards and specifications, if allowed at all. It will be removed by excavating to the lines and grades of the finished grading template. It must be above the bottom of the finished grading template to be roadway excavation.

(4) FILL (UNSUITABLE) is material that does not meet the requirements for suitable material but may be utilized in certain areas of the embankment as indicated in Standard Index 505.

(5) SUITABLE MATERIAL consists of those classifications that have been determined to be acceptable for construction of the roadbed, shoulders and other embankments of the highway.



(6) SUBSOIL EXCAVATION (SUITABLE) is material that would be acceptable in its original position, but it must be excavated below the finished grading template in order to remove material below it that is unsuitable in its original position.

(7) ROADWAY EXCAVATION (SUITABLE) is the good or acceptable material removed by excavating to the bottom of the finished grading template.

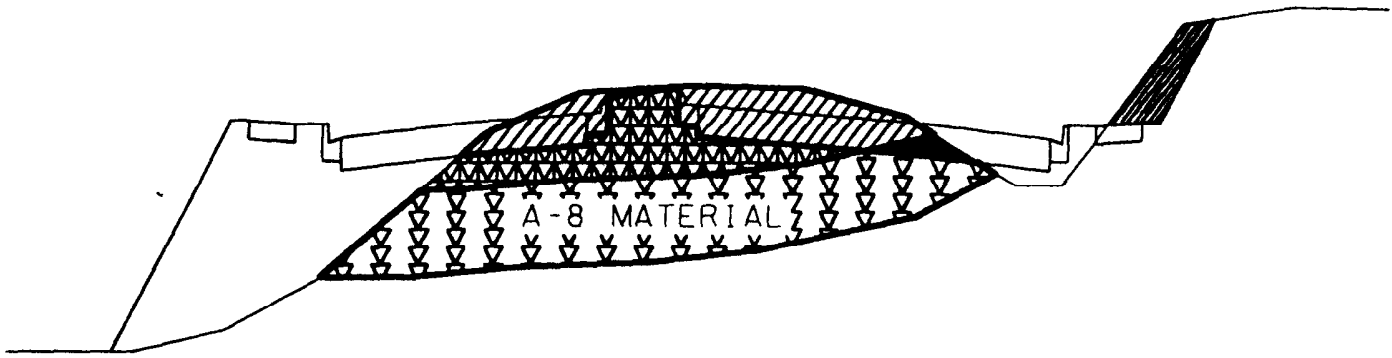

(8) FILL (SUITABLE) is the material utilized in the embankment in those areas calling for select material by the Standards and Specifications. Fill material is placed above the natural ground surface up to the bottom of the finished grading template. Fill material includes the backfill required to replace all subsoil excavation.



CUT
AREA BELOW NATURAL GROUND LINE AND ABOVE THE
BOTTOM OF THE PROPOSED ROADWAY TEMPLATE

-  REGULAR EXCAVATION -- SUITABLE MATERIAL
-  REGULAR EXCAVATION -- UNSUITABLE MATERIAL

SUBSOIL EXCAVATION
ALL SUITABLE AND UNSUITABLE MATERIAL BELOW THE
BOTTOM OF THE PROPOSED ROADWAY TEMPLATE AND
ABOVE THE BOTTOM OF THE LAYER OF UNSUITABLE MATERIAL

-  SUBSOIL EXCAVATION -- SUITABLE MATERIAL
-  SUBSOIL EXCAVATION -- UNSUITABLE MATERIAL

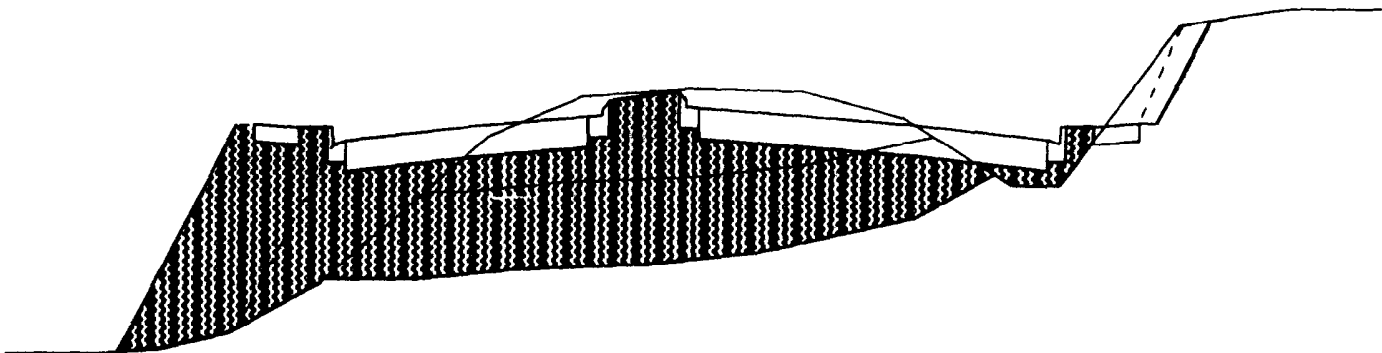

FILL
AREA BELOW THE BOTTOM OF THE PROPOSED ROADWAY TEMPLATE
AND ABOVE THE BOTTOM LAYER OF UNSUITABLE MATERIAL

-  FILL - SUITABLE MATERIAL

EX-I-3-B

3.4.3 Earthwork Accuracy

The calculation of earthwork volumes is not simple but, when performed with care and properly checked, will prevent many of the inaccuracies common in earthwork quantity calculations. The primary causes for inaccurate earthwork quantities are found to be errors in calculating end areas and choosing inappropriate lengths between the average end areas. Correct methods and techniques for computing earthwork quantities will eliminate the gross errors.

1. Calculate end areas and volumes by computer, when possible, and print the calculations for verification and future use by others.
2. Plot cross section details at the largest scale the sheets will permit (1" = 5'-0" Horizontal and Vertical). This is especially critical if plotting is done manually and the end areas are to be calculated from the plots. Care should also be taken when plotting slopes that extend over long distances.
3. If end areas are calculated from cross sections manually, show the breakdown of areas, etc. on work sheets and include these as backup in the computation book.
4. When computing volumes, determine lengths between sets of end areas to compensate for volumes that do not run the entire lengths between the normal station lengths.
5. Properly use match lines and turning lines to divide end areas when separate lengths should be used to calculate volumes.

6. Reduce the interval between cross sections on ramps or sharp turning roadways (50 feet or less), or determine and use the centroid of the section as the length for computing volumes
7. Proper use of cross section pattern sheets (Volume II, Chapter 13) to determine where cross sections should be taken, will help yield more accurate volumes
8. Exclude bridge spans, large culverts or other exceptions where earthwork is not required. Include quantities for fill slopes under bridges, at guardrail installations and at culvert extensions
9. Make sure that backfill for all subsoil excavation is added to the roadway fill quantities
10. Separate all Suitable and Unsuitable Subsoil Excavation. Calculate Roadway Excavation as Suitable and Unsuitable quantities. Show these end areas and tabulations on the work sheets so they can be verified and used by others. Make sure these quantities are tabulated in the proper columns on the cross section sheets

3.4.5 Variation in Quantities

When detailing and determining earthwork quantities, the designer should use the most probable base option within the optional base group, as identified in the pavement design and indicated on the typical section. A plan note should also be shown in the plans stating which option was used for plotting the cross sections and calculating the earthwork quantities. The Specifications do not allow adjustment of the earthwork quantities.

that were designated to be paid as plan quantity because a base of different depth was chosen during construction

3.4.6 Sequence of Construction

The designer must be aware of the Traffic Control Plan and, to some extent, the most likely sequence of construction for the project when figuring earthwork utilization. If the contractor cannot excavate material because of a detour or other TCP requirements, different provisions may need to be made in the earthwork items for the project.

EXAMPLE A project has balanced earthwork quantities, i.e., embankment is balanced by sufficient excavation to offset it. The embankment is required in Phase I of the construction. During this Phase, the area where the excavation is to be obtained is still under traffic and can NOT be excavated. Unless this is realized and taken care of by design, a Supplemental Agreement will most likely be required to establish a pay item for the materials and work. It could even result in the contractor filing a claim for delay of the work.

SOLUTION: The designer should change the TCP and construction sequence to ensure that the material in the excavation area is available when it is needed, if possible. Or, if the project is not a balanced job and already has Borrow set up as a pay item, make sure the quantity includes a sufficient amount to cover the embankment in Phase I. The Excavation could then be used to reduce Borrow later in the project, when it is free of traffic and could be excavated. Or, it may be necessary to set up an item for Borrow and then pay for the excavation as Regular Excavation and waste it.

3.4.7 Earthwork by Computer

The Department has several options for computing earthwork quantities by computer. In detailing the cross sections on the CADD or other automated system, the requirements and techniques noted above are just as applicable and necessary for accuracy

3.5 Earthwork Items of Payment

3.5.1 Regular Excavation

This is the most general classification of earthwork excavation. When Lateral Ditch or other excavation pay items are not called for in the plans, the total quantity of all excavation shall be paid for as regular excavation. Roadway Excavation consists of the net volume of material excavated between the original ground surface and the bottom of the proposed roadway templet.

Retention or detention areas that require considerable excavation should be summarized separately and added into the Regular Excavation. This is especially important if there is a large quantity and the area is removed from the project by some distance.

Projects where the predominate earthwork item is roadway excavation should designate Regular Excavation as the pay item, then the embankment would not be paid for as a separate item, as a general rule.

3.5.2 Borrow Excavation

Borrow Excavation is the pay item used to indicate that the contractor is to furnish earthwork material from areas provided by him and generally outside the project limits, including material with a specific minimum bearing value for building up existing shoulders, when appropriate for the project.

Borrow material, if available, may be obtained from within the right of way of the project, including those projects where the material is to be paid for under the embankment pay item. Each project must be analyzed to determine if this option is feasible. FHWA concurrence is required on federal-aid projects prior to utilization of the right of way as a source of borrow.

Obtaining material from the project right of way shall not create an unsafe condition or unprotected hazard. Proper design criteria shall be applied to proposed excavated areas which will fill with water.

The proposed borrow areas shall be reviewed and coordinated with the District Environmental Coordinator to minimize environmental disturbance and promote a future natural appearance.

The designer has two options for designating the method of payment for borrow material on highway projects. With either option, a fill adjustment must be made to the net total fill material calculated from the plans, to allow for handling. Recommendations on fill adjustment percentages should always be obtained from the District Materials and Construction Offices during the design process. Because the final measurement procedures are very labor intense, the designer should always check with construction before setting up a project for Borrow Excavation (Pit Measure).

1. Borrow Excavation (Pit Measure) - When the designer, with input and recommendations from construction, determines that the borrow material shall be measured by pit measure, the Earthwork Summary should show the adjusted quantity of borrow material estimated to be required.

<u>EXAMPLE</u>	Fill (From Cross Section Totals)	253 CY
	Fill Adjustment (+35%) (253 x 0.35)	<u>89 CY</u>
	Total fill	342 CY
	Roadway Excavation (Select) Deducted	<u>115 CY</u>
	Borrow Excavation (Pay Item Total)	227 CY

2 Borrow Excavation (Truck Measure) - The designer's second option for designating how borrow material shall be bid and paid on projects is truck measure. Truck measure should be specified only for projects which require small amounts of borrow material. Typical types of projects are small resurfacing projects, widening and safety projects. When this option is designated, an additional adjustment (truck) is added to obtain a representative volume of material required. This is not a plan quantity item, but it is very important that the most realistic determination of quantities possible be calculated by the designer.

<u>EXAMPLE.</u>	Borrow Excavation (As Above)	227 CY
	Truck Adjustment (+25%) (227 x 0.25)	<u>57 CY</u>
	Borrow Excavation (Pay Item)	284 CY

On some projects it is desirable that construction have the flexibility to pay for the item of borrow by pit measure, but determine the volume by loose truck measure. When this method of measurement is requested by construction, it will be necessary for the designer to calculate a percentage by which the truck measured quantity will be adjusted to determine the pit measured volume. This percentage compensates for the truck adjustment and converts the quantity back to its in-place volume. A pay item note similar to the following should be shown in the plans.

At the contractor's option, and with the approval of the engineer, measurement of borrow material may be based on loose truck volumes. In this case, payment will be made on _____% of the truck measured quantity

The percentage for the above note is calculated as follows

<u>EXAMPLE</u>	Borrow Excavation	227 CY
	Truck Adjustment (+25%)	<u>57 CY</u>
	Total Borrow	284 CY

Percentage (%) is obtained from $227 \text{ CY} \div 284 \text{ CY} = 80\%$

3 5 3 Lateral Ditch Excavation

Excavation required to construct inlet and outlet ditches at structures, changes in channels of streams and ditches parallel to the right of way, but separated from the roadway template, may be designated by the designer as Lateral Ditch Excavation

On projects with very little of this type of excavation, this earthwork is usually included in the Regular or roadway Excavation. If there is a significant amount of Lateral Ditch Excavation, it should be detailed, calculated and summarized on separate cross section sheets and shown separately in the Earthwork Summary. For more details on lateral ditch cross sections, see Volume II, Chapter 15

Excavation included for payment or that will be bid as work under Section 125 (Excavation for Structures) must not be included again in Lateral Ditch or other Excavation pay items

3 5 4 Subsoil Excavation

The payment for Subsoil Excavation should NEVER be included in other pay items, and subsoil quantities should NOT be included in other quantities, no matter how small the quantities are

The pay item, Subsoil Excavation, consists of the excavation and disposal of muck, clay, rock or any other material that is unsuitable in its original position and that is excavated below the bottom of the finished grading template. Subsoil Excavation also includes all suitable material (usually above the unsuitable material, i.e., overburden) excavated within the above limits in order to excavate the unsuitable material

The soils investigation survey must document the limits of any unsuitable material found on the project. Likewise, the cross sections and the earthwork calculations must use these limits in determining the quantities for Subsoil Excavation

Unsuitable subsoil areas and volumes shall be tabulated on the left side of the cross section sheets, and areas and volumes for the suitable subsoil excavation shall be tabulated on the right side of the cross section sheets (Volume II, Chapter 18). The fill quantities (areas and volumes) on the right shall also include areas and volumes required to backfill the excavated areas created by all subsoil removal. See example given in Section 3 4 2 of this procedure

3.5.5 Channel Excavation

The pay item for Channel Excavation consists of the excavation and satisfactory disposal of all material from the limits of the channel as shown in the plans. This work is generally called for by the plans and has lines, grades, typical sections and other details shown for excavating a channel change or a major modification to an existing canal or stream. This work may be significantly different from regular excavation or lateral ditch excavation, requiring draglines, barges or other special equipment. It should be detailed, calculated and summarized separately, in most cases.

SUMMARY OF EARTHWORK		
ROADWAY EXCAVATION, A-2, A-3 MATERIAL	=	10,000 C Y
ROADWAY EXCAVATION, A-7 MATERIAL	=	800 C Y
ROADWAY EXCAVATION, A-8 MATERIAL	=	1,005 C Y
EXCAVATION FROM LATERAL DITCHES	=	5,000 C Y
TOTAL REGULAR EXCAVATION (ROADWAY AND DITCH)	=	16,805 C.Y.
BORROW EXCAVATION	=	6,000 C.Y.
SUBSOIL EXCAVATION, A-2, A-3 MATERIAL	=	980 C Y
SUBSOIL EXCAVATION, A-7 MATERIAL	=	1,400 C Y
SUBSOIL EXCAVATION, A-8 MATERIAL	=	800 C Y
TOTAL SUBSOIL EXCAVATION	=	3,180 C.Y.

3.5.6 Embankment

This item includes placing material above the original ground line and within the lines and grades indicated by the plans. When subsoil

excavation is involved, the embankment must include the material necessary to backfill all of the material excavated.

When the work of constructing the embankment is shown to be paid for as Embankment, such price and payment shall be full pay for all the earthwork specified in Section 120, including all excavating, dredging, pumping, placing, compacting, dressing and protection of the completed earthwork. So, when Embankment (pay item) is used, no other earthwork items are generally required. Subsoil, however, will always be paid for as a separate item. Also, if there are large quantities of lateral ditch or channel excavation, these should be specified to be paid for as separate items of work.

The decision to use Embankment or Borrow Excavation as items of payment should be made with recommendation from the responsible District Construction Office. This decision will have an impact on the manpower required to control the work and document the final estimate records.

Generally, Embankment should be used as the pay item when the project is predominately a fill earthwork project. Most new construction and major reconstruction projects should be considered for payment under this earthwork item. The Summary of Earthwork quantities will show the net fill quantity, with no shrinkage applied, and a note to this effect will be shown on the plans.

Only when a project has very little embankment or when construction specifically requests it, should the borrow excavation pay item be used. (See borrow excavation, Section 3 5 2.)

SUMMARY OF EARTHWORK		
ROADWAY EXCAVATION, A-2, A-3 MATERIAL	=	10,000 CY
ROADWAY EXCAVATION, A-7 MATERIAL	=	800 CY
ROADWAY EXCAVATION, A-8 MATERIAL	=	1,005 CY
EXCAVATION FROM LATERAL DITCHES	=	<u>5,000 CY</u>
TOTAL ROADWAY EXCAVATION (ROADWAY AND DITCH)	=	16,805 CY
EMBANKMENT	=	70,000 CY
SUBSOIL EXCAVATION, A-2, A-3 MATERIAL	=	980 CY
SUBSOIL EXCAVATION, A-7 MATERIAL	=	1,400 CY
SUBSOIL EXCAVATION, A-8 MATERIAL	=	<u>800 CY</u>
TOTAL SUBSOIL EXCAVATION	=	3,180 CY

3 5 7 Regular Excavation - Lump Sum (3-R Projects only)

The Pay Item for Regular Excavation - Lump Sum (3-R Projects only) is to be used only on resurfacing or minor widening and resurfacing projects which conform to the guidelines in Chapter II-1, Section 17

Earthwork will be paid for as Borrow Excavation (Truck Measure) and Regular Excavation - Lump Sum (3-R Projects only) The designer will calculate these quantities based on information obtained from the field and the proposed typical section The designer will have to allow for additional time in the field to gather data on the existing field conditions using a hand level (See Exhibit EX-I-3-C.)

The designer will continue to show the Summary of Earthwork in the plans
The summary should show all quantities and adjustments

SUMMARY OF EARTHWORK		
FILL	=	253 CY
FILL ADJUSTMENT	=	<u>89 CY</u>
TOTAL FILL	=	342 CY
REGULAR EXCAVATION	=	<u>- 115CY</u>
BORROW EXCAVATION	=	227 CY
TRUCK ADJUSTMENT (25%)	=	<u>57 CY</u>
TOTAL BORROW EXCAVATION	=	284 CY

The pay items used will be

Regular Excavation - Lump Sum

Borrow Excavation (Truck Measure) 284 CY

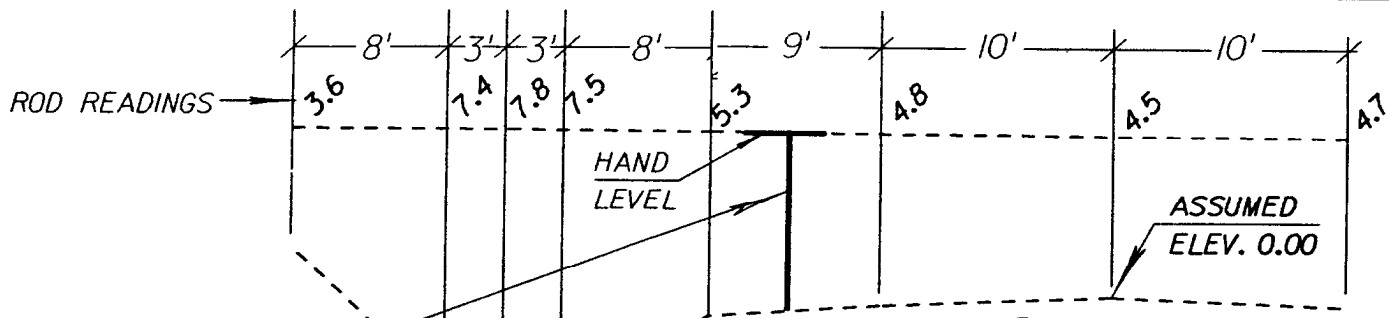

JACOB'S STAFF
(5' LENGTH OR KNOWN LENGTH)
(1 BY 2 OR DOWEL OR ETC)

EQUIPMENT NEEDED

- HAND LEVEL AND STAFF
- LEVEL ROD
- TAPE
- NOTEPAD AND PENCIL
- STRAIGHT LINE DIAGRAMS/ OLD PLANS

FIELD NOTES

OFFSET	ELEV. DIFF.
10	-0.2
CL	0.0
-10'	-0.3
-19'	-0.8
-27'	-3.0
-30'	-3.3
-33'	-2.9
-41	+0.9

FIELD SURVEY

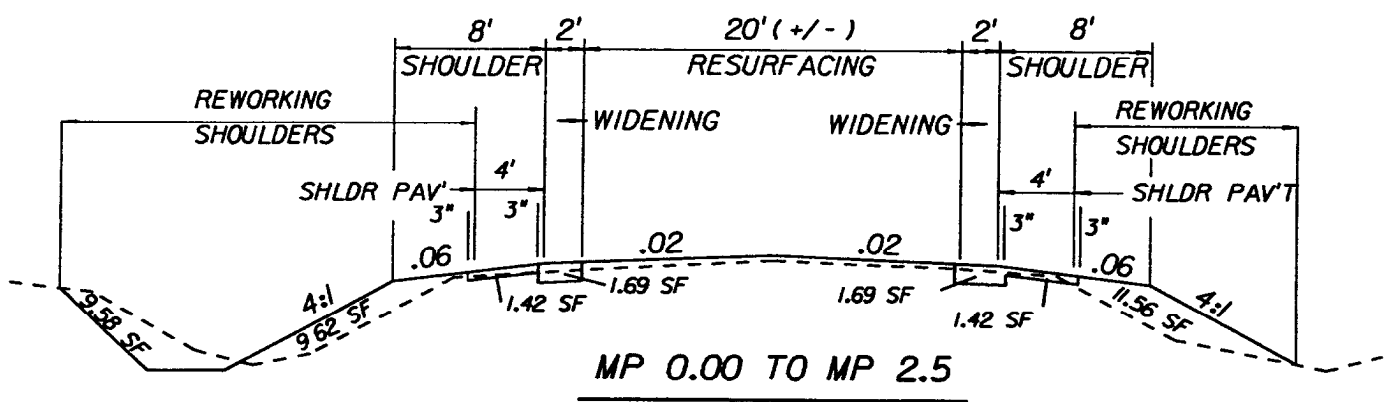

WORKING CROSS SECTION (TYP. FOR LIMITS)

1. WORKING CROSS SECTIONS SHALL BE PLACED IN THE COMPUTATION BOOK.
(PLOTTED FROM FIELD SURVEY NOTES & PROPOSED TYPICAL)
2. CALCULATIONS FOR THE THICKNESS OF THE BASE BOX SHALL BE BASED ON THE THICKEST ALLOWABLE OPTION.
3. SQUARE FOOT END AREAS SHALL BE SHOWN ON EACH WORKING CROSS SECTION.
4. LIMITS WILL BE SHOWN FOR EACH WORKING CROSS SECTION.
(VERIFY ENTIRE PROJECT IS INCLUDED)
5. EARTHWORK CALCULATIONS WILL BE AS SHOWN IN THE PLANS PREPARATION MANUAL VOLUME 1 CHAPTER 3.
PAY ITEMS ARE: REGULAR EXCAVATION, (LUMP SUM)
BORROW EXCAVATION (TRUCK MEASURE)
REWORKING SHOULDERS (SQUARE YARD)

EX-I-3-C

3 6 Summary

Regardless of the decisions made about establishing the items of pay for the earthwork on a project, it is imperative that the designer

- 1 Obtain good soil survey data, especially the limits of unsuitable material within the project limits
2. Accurately detail the earthwork on cross sections
- 3 Determine the areas and volumes of the different earthwork items (Roadway, Subsoil, Lateral Ditch, & Channel Excavation) and embankment very accurately
- 4 Show on the Summary of Earthwork all the different types of earthwork operations the contractor must consider
- 5 Use plan notes and pay item notes to explain any unusual conditions or treatments which are not apparent, not to repeat or modify Specifications
- 6 Make a decision on how to pay for earthwork items with the input and recommendations of the district construction office

Chapter 4

ROADSIDE SAFETY

4.1 Clear Zone

4.1.1 Clear Zone Concept

A significant number of accidents involve a single vehicle leaving the roadway and either overturning or colliding with a fixed object. A roadside that is traversable and unobstructed by fixed objects will allow vehicles that leave the roadway to recover safely. The designer should provide as much traversable and unobstructed area (clear zone) as practical. |

Roadsides are considered traversable if a vehicle can traverse them without seriously endangering the occupants. Roadside are considered recoverable if there is a reasonable probability of regaining control of a vehicle or bringing it to a safe stop. |

If natural or man-made hazards, including slopes steeper than 3:1, occur within the clear zone, the designer should attempt the following treatments, in order of priority. |

- 1 Eliminate the hazard |
 - A Remove the hazard |
 - B Relocate the hazard outside the clear zone |
 - C Make the hazard traversable or crashworthy |

- | 2. Shield the hazard with a longitudinal barrier or crash cushion.
| This treatment should only be taken if the barrier or crash cushion
| presents a lesser hazard
- | 3 Leave the hazard unshielded This treatment should be taken only
| if a barrier or crash cushion is more hazardous than the obstacle
| hazard, if the likelihood of striking the hazard is very small or if
| the expense of treatment outweighs the benefits in terms of
| accident reduction

| If accident data or safety reports indicate that early treatment of the hazards
| will result in fewer or less severe accidents, designers should consider
| directing that those treatments be accomplished as the first order of work, if
| feasible and practical

4 1 2 Clear Zone Criteria

Criteria have been developed with the objective of providing the necessary
recovery area for the vehicles that might leave the roadway The criteria are
based on limited empirical data which was then extrapolated for a wide range
of conditions The criteria represent a reasonable degree of roadside safety,
but they are neither absolute nor precise These criteria must be applied with
judgement In some cases, the clear zone can be adjusted higher or lower
than shown In all cases, the most clear zone that can be practically provided
is desirable

| The Roadway and Traffic Design Standards include criteria for determining
| clear zones, as well as other design criteria related to highway safety for new
| construction or reconstruction projects The designer should keep safety in
| mind as the objective when applying clear zone criteria

If a non-recoverable slope encroaches the clear zone, then a clear runout area should be provided beyond the toe of slope equal to the width of the encroachment. A minimum of 10 feet of clear runout area beyond the toe of slope should be provided.

The Department's 3-R Manual provides clear zone criteria for other projects.

RECOVERY AREA AND CLEAR ZONE DISTANCE

RECOVERY AREA AND CLEAR ZONE DISTANCE

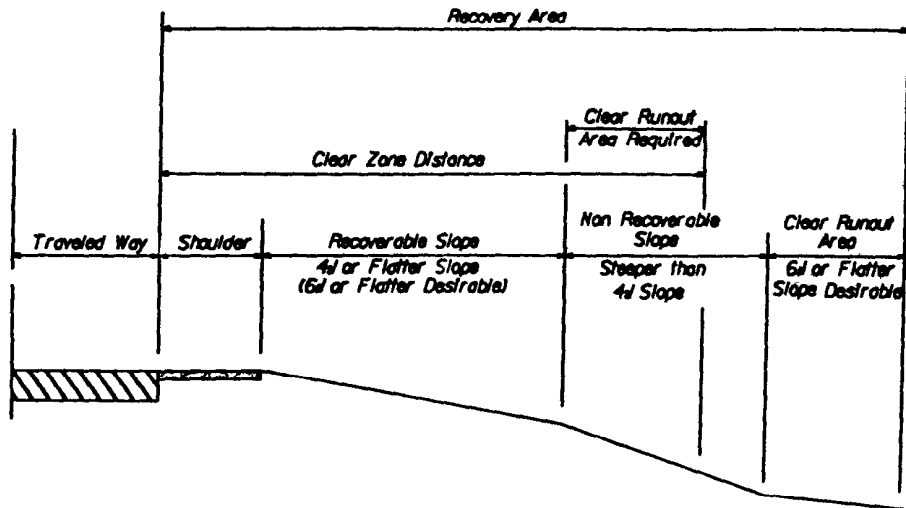

Example of a Parallel Embankment Slope Design This figure illustrates a recoverable slope followed by a non-recoverable slope. Since the clear zone distance extends onto a non-recoverable slope, the portion of the clear zone distance on such a slope may be provided beyond the non-recoverable slope if practical. This clear runout area would then be included in the total recovery area. The clear runout may be reduced in width based on existing conditions or site investigations. Such a variable sloped typical section is often used as a compromise between roadside safety and economics. By providing a relatively flat recovery area immediately adjacent to the roadway, most errant motorists can recover before reaching the steeper slope beyond

ROADSIDE DESIGN GUIDELINES

Exhibit I-4-A

4.2 Canal Hazard Standards

Canals are defined as an open ditch parallel to the roadway for a minimum distance of 1000 feet and with a seasonal water depth in excess of three feet for extended periods of time (24 hours or more)

The distance from the outside edge of the through travel lane to the top of the canal side slope nearest the road will be no less than 60 feet for highways with design speeds of 50 MPH or greater. For highways with design speeds less than 50 MPH this minimum distance may be reduced to 50 feet for rural highways or 40 feet for urban (curb and gutter) highways. When new canal or roadway alignment is required, distances greater than these above should be provided, if possible, to accommodate possible future improvements to the roadway (widening, etc.)

On fill sections, a flat berm (maximum 10:1 slope) of width no less than 20 feet will be provided between the toe of the roadway front slope and the top of the canal side slope nearest the roadway. This minimum berm width applies to all types of highways, both rural and urban (curb and gutter) construction. (See Exhibit EX-I-4-B)

When the slope between the roadway and the "extended period of time" water surface is 6:1 or flatter, the minimum distance can be measured from the edge of the through lane to the "extended period of time" water surface and a berm is not required. |

In sections with ditch cuts 20 feet will be provided between the toe of the front slope and the top of the canal

Guardrail, or other protective devices shall be installed 5' from the canal front slope where it is not possible to meet the above minimum criteria. The design is complicated when clear zone and slope criteria are combined with canal hazard criteria. Extreme caution must be taken to ensure that all criteria are met.

- | If the minimum standards for canal hazards cannot be met, then the standard
- | guardrail treatments as provided in the Roadway and Traffic Design Standards
- | should be used.

MINIMUM STANDARDS FOR CANAL HAZARDS

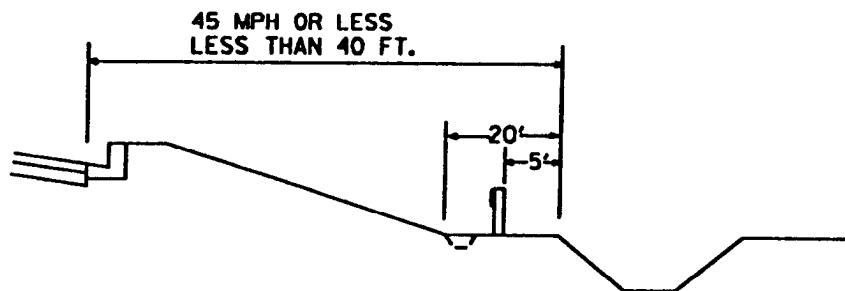
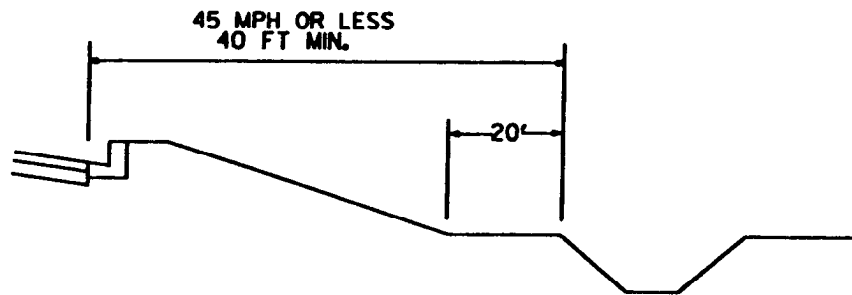
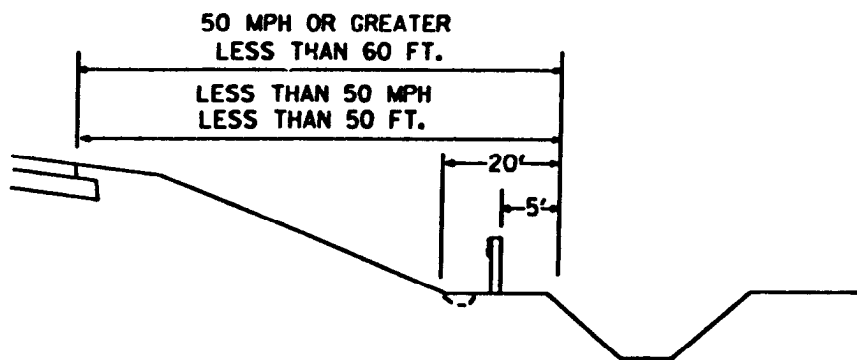
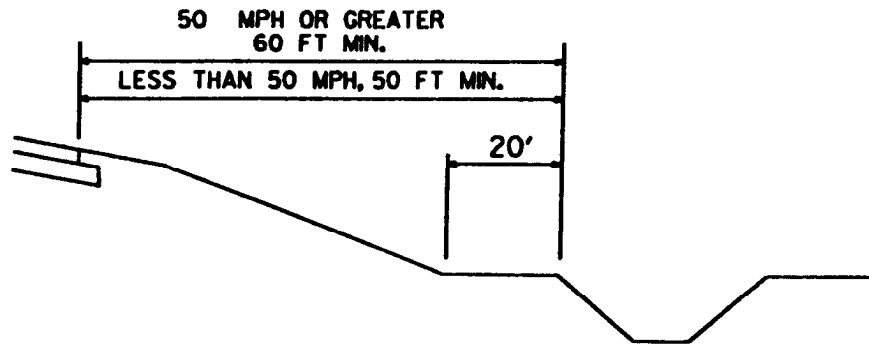

4.3 Roadside Barriers

4.3.1 Warrants

| Roadside barriers are warranted when hazards exist within the clear zone, cannot be cost effectively eliminated or corrected and collisions with the hazards will be more serious than collisions with the barriers

| The length of advancement and length of need necessary to properly shield the hazard must be determined on an installation by installation basis as indicated in the Roadway and Traffic Design Standards

| The following conditions within the clear zone are normally considered more hazardous than a roadside barrier

- o Fill slopes steeper than 3:1
- o Bridge piers, abutments and railing ends
- o Large, non-traversable culverts, pipes and headwalls
- | o Non-traversable parallel or perpendicular ditches and canals
- o Bodies of water other than parallel ditches and canals that the engineer determines to be hazardous
- o Parallel retaining walls with protrusions or other potential snagging features
- o Retaining walls at an approach angle with the edge of pavement larger than 7 degrees (8:1)
- o Non-breakaway sign or luminaire supports
- | o Trees greater than four inches in diameter measured 6" above the ground at maturity
- |

- o Utility poles
- o Rigid protrusions above the ground in excess of four inches in height

In addition to the above hazards, there may be other situations that warrant barrier consideration, such as nearby pedestrian or bicycle facilities, schools, residents or businesses

4.3.2 Barrier Selection

Acceptable standard roadside barriers are detailed in the Roadway and Traffic Design Standards. They include

- o Standard blocked-out W-beam on 6" X 8" wood post (strong post)
- o Standard blocked-out W-beam on 6" "C" steel post (strong post)
- o Standard blocked-out W-beam on W6 X 8 5 or W6 X 9 steel post (strong post)
- o Blocked-out Thrie-Beam on any of the above post systems
- o Standard concrete barrier wall

Most guardrail installations will be blocked-out W-beam on wood or steel posts. The Thrie-Beam guardrail should be considered when additional rail depth is needed because of a potential to under-ride the rail or because additional height may be needed. A special design detail shall be approved by the State Roadway Design Engineer prior to inclusion of Thrie-Beam in the plans. Concrete barrier wall may be used in locations where no barrier deflection can be tolerated. Other barrier designs may be required by specific site conditions. These must be called for and detailed on a project by project basis.

4 3.3 End Treatments

Non-crashworthy longitudinal barrier ends can present serious hazards if they terminate within the clear zone. The FDOT end anchorage Type IV is the only crashworthy end treatment standardized by the Department. Other proprietary end treatments may be required under special circumstances. Special details would be required in the plans.

- o End Anchorage Type IV. It is very important that the standard 37'-6" parabolic flare with 4' offset be provided exactly as shown in the Roadway and Traffic Design Standards. The 4 foot end offset should be measured off a projection of the face of guardrail alignment immediately downstream. If the guardrail alignment is on a flare off the roadway or curve, the standard parabolic flare is an additional flare. The maximum allowable cross slope in front of the rail is 10:1, including the area in front of the Type IV and the upstream approach to the Type IV.
- o Non-crashworthy end treatments will be used outside the clear zone and at downstream terminations, which are not within the clear zone of the opposing traffic flow. The Type II end anchorage is non-crashworthy and, therefore, may not be used as an approach terminal end treatment.
- o Thrie-beam and concrete barrier wall will be terminated as shown in the Roadway and Traffic Design Standards. Appropriate transitions to W-beam guardrail will be necessary to use the End Anchorage Type IV. Crash cushions may also be used to terminate thrie-beam or concrete barrier wall. The sloped Concrete Barrier Wall Terminal will only be used on roadways with a design speed of 45 MPH or less or where the terminal can be located the clear zone width or greater from the traffic lane approaching the sloped terminal.

4 3.4 Transitions

Whenever standard W-beam or Thrie-beam guardrail transitions into bridge rail or concrete barrier wall, a transition section is necessary. Transitions for W-beam guardrail must include sound structural connections, nested beams and additional posts for increased stiffness, as shown in the Roadway and Traffic Design Standards. Transitions for Thrie beams must be included in the plans. Standard flares should be introduced upstream of the transition section. Care must be taken in the details of the junction of the two barrier types to avoid snag points.

4.3.5 Placement

The primary design factors associated with guardrail placement are:

- o Lateral offset from the edge of pavement
- o Terrain effects
- o Flare rate
- o Length of advancement
- o Length of need

The standard offset is the shoulder width plus two feet, not to exceed 12 feet. Alternate guardrail offset locations are shown in the Roadway and Traffic Design Standards.

A two foot distance from the back of the barrier posts to the shoulder line or slope break is desirable for post support.

The length of advancement is dependent on the design speed, the offset distance to the face of guardrail and the lesser distance (a) to the back of the hazard or (b) to the clear zone needed. The designer must establish this

| advancement need for all installations on the project On all facilities the
| guardrail needs must consider traffic from both directions

| A barrier should not be located so close to the hazard that it is shielding that
| it is within the dynamic deflection distance of the barrier The dynamic
| deflection of standard barriers are shown in Table 4 3 2

Table 4.3.2
Dynamic Deflection of Barriers
(Measured from the back of the barrier post)

<u>Barrier Type</u>	<u>Dynamic Deflection (ft)</u>
W-Beam, Strong Post	4
Three-Beam, Strong Post	2
Barrier Wall	0
Double W-Beams (Nested)	
w/Strong Post @ 1'-6 75" cc	0 5

| Curbs shall not be placed in the front of barriers When guardrail is
| necessary, the guardrail shall be located at the face of the curb or in front of
| it.

Barriers should not be placed on slopes steeper than 10 1 This is particularly
important on the approach to the standard flare of the End Anchorage Type
IV.

4 3 6 Resetting Guardrail

For those projects that include the resetting of guardrail, refer to the Standard |
Specifications, the Basis of Estimate and the Roadway and Traffic Design |
Standards for pay items, notes and quantity calculations |

4.4 Median Barriers

4.4.1 Warrants

| A median barrier shall be provided on Interstate and expressway facilities
| where reconstruction reduces the median width to less than the standard for
| the facility. No variances or exceptions to this criteria will be approved.

4.4.2 Selection

The same barrier types as discussed in Section 4.3.2 are available as median barriers. In general, the concrete barrier wall is preferable in narrow medians.

4.4.3 End Treatments

Median barriers can be terminated with any of the treatments discussed in
4.3.3

4.5 Crash Cushions

Crash cushions are attenuating devices that may be non-directive or re-directive |

4.5.1 Warrants

Hazards within the clear zone which present a more serious collision |
potential than a crash cushion, are warrants for the installation of a crash
cushion

4.5.2 Selection

The following types of crash cushions are currently standardized for use |

- o Hex-Foam Sandwich System
- o Guardrail Energy Absorbing Terminal (G-R-E-A-T)
- o Crash Attenuating Terminal (CAT)
- o Brakemaster
- o Sand-filled Plastic Barrels
- o Work Zone Attenuator (G-R-E-A-T-cz)
- o Vehicle Arresting Barrier (DRAGNET)

The Roadway and Traffic Design Standards and manufacturer's publications |
provide detailed information about these systems. Each system has its own
unique physical and functional characteristics. The designer shall indicate in |
the plans which system is to be used at each location. The design engineer |
shall consider the following factors when selecting a system for a particular |
location |

- o Site characteristics
- o Structural and safety characteristics of candidate systems
- o Initial and replacement/repair costs
- o Expected frequency of collisions
- o Maintenance characteristics

l Site characteristics and economics dictate the crash cushion selection. Sand barrels are relatively low in initial cost, but usually must be completely replaced when struck, so are more appropriate in locations with a low likelihood of collision. The other systems have higher initial costs but can be repaired after collisions relatively cheaply, so are more appropriate where frequent collisions are expected. The ability of maintenance forces to perform routine maintenance and to place a crashed system back into service quickly should be a major consideration. Crash cushions that require stocking unusual and expensive parts or that are complex to replace should not be selected.

4.5.3 Design

Crash cushion suppliers normally provide design assistance for their system.

l These systems must decelerate both large and small automobiles from the
 l established design speed of the facility to a gradual stop. If the AASHTO
 l Roadside Design Guide charts are used, the maximum average deceleration
 level should not exceed approximately 7 g's.

All terrain within the likely approach of a vehicle should be relatively flat. An impacting vehicle should strike the unit at normal height, with the
 l vehicle's suspension system neither collapsed nor extended. Curbs exceeding
 l 4" in height shall not be used in the approach area of a crash cushion.

Sand barrels do not have redirection capability, so they should be oriented toward the expected angle of impact |

Care must be taken with all systems shielding a rigid object to ensure that there is not a potential to impact the hazard by opposing traffic |

The nose of all crash cushions shall be delineated with reflective material or standard object markers, as indicated in the Roadway and Traffic Design Standards |

4.6 Roadside Appurtenances

4.6.1 Sign Supports

| All sign supports, except overhead cantilever, truss type or bridge or barrier
| wall mounted, shall be either breakaway or frangible as defined in the
| AASHTO Standard Specifications for Structural Supports for Highway Signs,
| Luminaires and Traffic Signals and the AASHTO Roadside Design Guide.
| Supports not meeting the frangibility or breakaway criteria should not be
| installed within the clear zone. Sign supports not meeting these requirements
| which must be installed within the clear zone shall be protected by a barrier
| or crash cushion. Sign supports shall be of an acceptable and crashworthy
| design as described in the Roadway and Traffic Design Standards.

4 6 2 Mailbox Supports

Mailbox supports shall be of an acceptable crashworthy design, as described in Roadway and Traffic Design Standards |

4 6 3 Other Appurtenances

The Roadway and Traffic Design Standards contain design criteria for numerous other roadside appurtenances |

4 6 4 Location Criteria

Most breakaway mechanisms are designed to be impacted at bumper height, typically about 20 inches above the ground. If impacted at a significantly higher point, the bending moment in the breakaway base may be sufficient to bind the mechanism, resulting in non-activation of the breakaway device. For this reason, it is important that breakaway supports not be located in ditches or on steep slopes where a vehicle is likely to be partially airborne at the time of impact.

4 6 5 Bus Benches and Transit Shelters

Design criteria for these features are discussed in Section III of the Florida Green Book.

Chapter 5

UTILITIES

5.1 General

Highways serve the public by carrying people and goods from place to place. Public and privately owned utilities have a public-serving function similar to that of highways. The needs of utilities (power lines, communication lines, gas and other pipelines, water mains and sewers) to go from place to place (often to or from the same points as the highway system), are recognized by the Department. Utility facilities, both above and under ground level, are permitted by the Department to be accommodated within the road rights-of-way on the state maintained highway system (non-interstate).

For interstate facilities parallel utilities within the right-of-way are not allowed. Lateral crossings are allowed by permit only (see Utilities Policy # 71000-020-001-a). The designer should make every effort to design a project that will avoid conflicts with major utilities. The selection of typical section features, horizontal alignment and location of storm sewer lines are two areas that can sometimes be adjusted without violating safety standards and design criteria. A dual storm sewer system to avoid lateral crossings may be practical on some projects to avoid utility conflicts. The increased cost of some features may be offset by reduced construction time and the associated costs.

5.2 Relocation

Relocation is the adjustment of utility facilities required by a roadway project. Examples are removing and reinstalling a utility at a new location, moving or rearranging existing utilities, changing the type of facility, improving safety and protective measures. Relocation includes constructing a replacement facility functionally equal to the existing facility, where necessary for continuous operation of the utility services, the project economy, or sequence of roadway construction.

5.3 Utility-Accommodation Guide

The Department has established certain guidelines to regulate the location and manner for installation and adjustment of utility facilities in order to ensure safe and efficient operation and maintenance of the roadway facility.

The Department's Utility Accommodation Guide governs on matters concerning future location, manner and methods for the installation or adjustment and maintenance of utilities on highway right-of-way.

A permit must be approved by the Department before any utility is installed on the right-of-way, whether it is for aerial or underground installations. Exceptions and requirements for permits are enumerated in the guide.

Design considerations for accommodating utilities within the highway rights-of-way are given in the AASHTO publications A Guide for Accommodating Utilities within Highway Right-of-Way and A policy on Geometric Design of Highways and Streets. Additional information can be found in the TRB's publication Policies for Accommodation of Utilities on Highway Rights-of-Way.

5.4 Verification of the Location of Major Existing Utilities

Utility delays account for 17 to 18% of the construction contract time extensions. Inaccurate location of existing utility facilities has been identified as a significant contributor to these extensions. As a result, positive horizontal and vertical verification of the location of major existing utilities is required on those urban reconstruction and add lane projects where timely completion is essential because of disruptions to traffic flow.

Major utilities are defined as those underground utilities that potentially conflict with construction activities to the extent that the existing location may interfere with pavement construction, stabilizing, curb and gutter construction, bridge foundations, sign and signal foundation, light poles, drainage structures, and/or storm sewer installation, manholes or inlet construction or those utilities that lie within the normal excavation limits for these structures. Construction personnel should be consulted for assistance in determining the excavation limits. Major utilities are also defined as water mains (6 inches or larger), all gas lines except service lines, telephone-coaxial toll lines and multi-duct lines, telephone cables and ducts (50 pair or larger), sanitary lines (all gravity flow mains), sanitary force mains (6 inches or larger) and electric power cable (all buried electric transmission cables - not service lines). Service connections are not to be considered as major utilities.

Positive verification of utility locations can be either by DOT or consultant survey or utility company verification based on previous surveys or certified as built plans. To avoid obtaining detailed verification at locations that may not be necessary, it is desirable that designs be advanced to the stage that the location of the storm sewer is known. It will be the responsibility of the District

Utility Engineer, or his designee, with assistance from the Designer and construction personnel to determine the appropriate locations of positive verification.

5.4.1 Locating Underground Utilities

To further identify the responsibilities of the Department and utility companies regarding the location of underground utilities, the following will be used along with, and in accordance with, the Location Survey Manual:

1. Contact the utility owner, give details as to the location, length, and/or extent of job. Advise if the underground utilities are to be located horizontally only, or that they will have to be uncovered and located both horizontally and vertically. Request that personnel necessary to locate the utilities meet DOT or consultant forces at a specific time and place.
2. All underground utilities must be marked by the company representative with a DOT employee or consultant present, giving size, type and use. The utility company will furnish the DOT with as built plans, if available. The DOT or consultant survey forces will tie all major utilities and others deemed necessary to the centerline or baseline of survey and record all field data usually horizontally only, giving the approximate depth estimated by the utility company representative. If field verified vertical data are also available, these data will also be shown by positive tie in the field book.

3. During the design of the project, those major utilities requiring vertical location of the underground utilities will be identified. The utility company will be contacted to uncover (dig, excavate, and so forth) their utilities as deemed necessary by the DOT. The DOT location or consultant survey personnel will locate and record all findings, both horizontally and vertically, showing the positive horizontal and vertical ties in the field book for future reference. All storm sewer systems and sanitary sewer gravity flow lines will be shown as presently outlined in the Location Survey Manual.

4. All as built plans obtained from the utility companies are to be marked as follows:

Date
DOT Job No.
Party Chief
Utility Company
Utility Company Representative

All field books in addition to the standard heading, index, etc., will denote the following:

Date
Personnel
Utility Company
Utility Company Personnel
Utility Company Work Order No., if applicable.

Those locations where positive horizontal and vertical location is known will be designated on the plans. It is important to the contractors bidding on projects to know at which locations the information is exact and not interpolated. Volume II gives specific instructions on how to show this information on the plans.

5.5 Coordination Process

Copies of plans, with all utilities shown, should be given to the utility owner for verification at approximately 30% design completion stage. Right-of-way map or R/W key map with existing utilities shown may be used for utility contact. The District Utility Engineer normally coordinates this activity through a utility predesign conference. The utility owners are required to verify or indicate the correct location of their respective utilities within the project limits on the plans provided to them. These marked up plans should be used by the design team to show the correct locations, horizontal and vertical, of the various utilities.

The designer should make every effort to design a project that will avoid conflicts with major utilities. At 60% completion of the project, when the drainage design is well underway, the potential utility conflicts should be identified. Only major utilities potentially in conflict shall be field verified horizontally and vertically.

At approximately 80% completion of plans, the utility companies should be provided with two sets of plans showing all utilities. One marked up set is transmitted back to the designer and the other is retained by the utility company for their use.

To reduce potential problems and delays during the construction phase due to utilities, full size plan sets should be supplied to each utility company after plans are printed in Tallahassee. During the utility design meeting, each district utility office should determine which companies want and need a full size plan set to fulfill their responsibilities. The form shown in Exhibit I-5-A is to be completed and sent to Tallahassee with the plans transmittal package. The form will be detached and sent to the reproduction office with the plans and the required number of full size sets of blueprints will be sent to the District Utility Engineer for disbursement to the appropriate utility.

companies. If no form is attached to the plans transmittal package, it will be assumed that no full size prints are being requested for that project. When or if subsequent plan revisions are made, the District Utility Engineer will automatically receive one set of copies of the revised sheet(s) so copies can be made and forwarded to the utility companies for inclusion in their full size sets.

5.5.1 Coordination of Traffic Monitoring Sites

The Transportation Statistics Office in Tallahassee should be notified of any work within 0.5 mile of a traffic monitoring site. If relocation or reconstruction of the site is required, the action should be made part of the project. The Transportation Statistics Office can provide plans and specifications and other information, if needed.

REPRODUCTION REQUEST
(Utility BlueLines)

PROJECT NO.(S)	COST CENTER	NO. OF FULLSIZE SETS OF BLUELINES
SEND TO	PHONE NO.	DATE
District ____ Utility Engineer		

ATTACH TO TRANSMITTAL MEMO

Chapter 6

RAILROAD CROSSING

6.1 General

A railroad-highway crossing, like any highway-highway intersection, involves either a separation of grades or a crossing at grade. The geometrics of a highway and structure that entails the overcrossing or undercrossing of a railroad are substantially the same as those for a highway grade separation without ramps.

Selection of the warning devices to be used is a function of the geometrics of railroad-highway grade crossing, including the alignment, profile, sight distance and cross section of both the roadway and the railroad. Railroad grade crossing angles should be as near 90 degrees as practical.

Design Criteria and Standards are given in the Florida Green Book and the Department's Railroad Procedures Manual Volume III. Design considerations are discussed in Chapter IX of the AASHTO policy on Geometric Design.

6.2 Devices

Traffic control devices for railroad-highway grade crossings consist primarily of signs, pavement markings, flashing light signals and automatic gates. A large number of significant variables must be considered in determining the types of warning device to be installed at a railroad grade crossing. The type of highway, volume of vehicular traffic, volume of railroad traffic, speed of vehicular traffic, volume of pedestrian traffic, accident record, and geometrics of the crossing are some of the factors influencing the choice of warning devices to be provided at the railroad crossing. Standards and criteria for design placement, installment and operation of these devices are covered in the MUTCD and the Department's Railroad Procedure Manual Volume III. The Department's Roadway and Traffic Design Standards should also be consulted in the design of railroad crossings.

6.3 Surfaces

The highway traveled way at a railroad crossing should be constructed for a suitable length with all-weather surfacing. A roadway section equal to the current or proposed cross section of the approach roadway should be carried across the crossing. The crossing surface itself should have a riding quality equivalent to that of the approach roadway. When selecting the type of crossing and the material to be used in its construction, consideration should be given to the character and volume of traffic using the highway. The Department's Highway-Railroad Grade Crossing Material Selection Handbook should be consulted in selecting the material.

Roadway Design Standard Index #560 contains specifications for the construction of crossings of the following types.

- Bituminous
- Wood Plank Crossing
- Prefabricated Sectional Treated Timber Crossings
- Concrete Slab Crossings (Precast)
- Concrete Slab Crossings (Prestressed)
- Steel Grid Crossing
- Rubber (Elastomeric) Panel Crossings
- Epoxy-Rubber Mix Cast-In-Place Crossings
- Linear High Density Polyethylene Modules Crossings

6.4 Clearances at Railroad/Highway Structures

An offset horizontal dimension to the abutment slope of up to 20 feet from the centerline of tracks requires no special justification. Horizontal offsets in excess of 20 feet should be justified based on individual site conditions. Vertical clearances up to 23 feet require no special justification. Greater vertical clearances can be justified based on special site conditions or the need to meet documented railroad electrification plans. The horizontal clearance to an obstruction is a minimum of 9 feet. Greater clearances may be necessary to preclude the placement of piers in drainage ditches. Roadway Design Standard Index 280 contains additional criteria for culvert clearances below railroads.

Chapter 7

SIGNING, MARKING, LIGHTING AND SIGNALS

7.1 General

Traffic control devices are necessary to help ensure highway safety by providing the orderly and predictable movement of all traffic, motorized and non-motorized, throughout the highway transportation system, and to provide such guidance and warnings as are needed to ensure the safe and informed operation of individual elements of the traffic stream. The design and layout of signs, signals, pavement marking and lighting should complement the basic highway design.

7.2 Signing and Marking

The designer responsible for a signing and marking project should be aware that the design must comply with various standards. In addition to Department Standard Specifications, the following standards should be consulted:

Manual on Uniform Traffic Control Devices (MUTCD) - The MUTCD was adopted by the Department as the uniform system of traffic control for use on the streets and highways of the State. This action was in compliance with Chapter 316.0745 of the Florida Statutes. The MUTCD is therefore the basic guide for signing and marking. The requirements of the MUTCD must be met, as a minimum, on all roads in the State.

Standard Highway Signs, FHWA - This manual contains detailed drawings of all standard highway signs. Each sign is identified by a unique designation. Signs not included in this manual or in the Roadway and Traffic Design Standards must be detailed in the plans.

Standard Specifications for Structural Supports for Highway Signs, Luminaires and Traffic Signals, AASHTO - This specification contains the strength requirements of the sign supports for the various wind loadings in the State as well as frangibility requirements. All signs supports must be in compliance with these specifications.

Roadway and Traffic Design Standards - These standards are composed of a number of standard drawings or indexes which address specific situations which occur on a large majority of construction projects.

7.2.1 Design Criteria

The MUTCD and the Roadway and Traffic Design Standards should be consulted for sign location. All signs not bridge or barrier wall mounted and installed within the clear recovery zone, must be frangible or protected by an approved barrier. Chapter 4 of this volume contains detailed instructions on safety design.

Post sizes for single column signs are covered in ~~the~~ Roadway and Traffic Design Standards. The supports for multi-post signs are not in that reference and must be included in the plans. The designer must provide post sizes and length for each multi-post sign. The Structures Design Office has written a program for personal computers that calculates post sizes and length for multi-post signs. This program may be used for these calculations.

Signs will be illuminated with 175 watt mercury vapor Deluxe White Lamps. The following table gives the number of luminaires for various sign widths. See Roadway and Traffic Design Standard Index 17505 for spacing details and mounting location.

Sign Width	To 10'	To 21'	To 32'	To 43'
Luminaires	1	2	3	4

7.2.2. Wind Loading Criteria - Signs

The wind loadings given below were taken from the AASHTO Standard Specification For Structural Supports For Highway Signs, Luminaires and Traffic Signals. The Counties are listed by wind loading for the appropriate sign type.

GROUND SIGNS

- 60 MPH Alachua, Baker, Bay, Bradford, Calhoun, Clay, Columbia, Escambia, Gadsden, Gilchrist, Hamilton, Holmes, Lafayette, Lake, Leon, Liberty, Jackson, Jefferson, Madison, Marion, Okaloosa, Putnam, Santa Rosa, Sumter, Suwannee, Union, Walton, Washington
- 70 MPH Citrus, DeSoto, Dixie, Duval, Flagler, Franklin, Glades, Gulf, Hardee, Hendry, Hernando, Highlands, Hillsborough, Levy, Nassau, Okeechobee, Orange, Osceola, Pasco, Pinellas, Polk, Seminole, St. Johns, Taylor, Wakulla
- 80 MPH Brevard, Charlotte, Collier, Indian River, Lee, Manatee, Martin, Palm Beach, Sarasota, St. Lucie, Volusia
- 90 MPH Broward, Dade, Monroe

OVERHEAD SIGNS

- 80 MPH Baker, Columbia, Gadsden, Hamilton, Holmes, Jackson, Jefferson, Lafayette, Leon, Madison, Suwannee
- 90 MPH Alachua, Bay, Bradford, Calhoun, Charlotte, Citrus, Clay, Collier, DeSoto, Dixie, Duval, Escambia, Flagler, Franklin, Glades, Gilchrist, Gulf, Hardee, Hendry, Hernando, Highlands, Hillsborough, Lake, Lee, Levy, Liberty, Manatee, Marion, Nassau, Okaloosa, Okeechobee, Orange, Osceola, Pasco, Pinellas, Polk, Putnam, Santa Rosa, Sarasota, St Johns, Sumter, Taylor, Union, Wakulla, Walton, Washingt
- 100 MPH Brevard, Indian River, Martin, Seminole, St. Lucie, Volusia
- 110 MPH Broward, Dade, Monroe, Palm Beach

3
7.2.2 Project Coordination

Coordination with other offices and other agencies is a very important aspect of project design. The offices discussed in this section are not intended to be an all inclusive list with which the designer should coordinate, but are those that are typically involved in a signing and marking project.

Roadway Design - The designer of a signing and marking project receives the base sheets for design from the roadway designer, who can also provide any required cross sections. If the signing project is not an active roadway design project, base sheets may be obtained from existing plans or aerial photographs.

Utilities - The District Utilities Engineer provides the coordination between the designer and the various utilities involved in the project. The Utilities Section can also identify potential conflicts with overhead and underground utilities or verify those which have previously been identified. The District Utilities Engineer should be contacted as early in the design phase as possible.

7.3 Lighting

The designer responsible for a highway lighting project should be aware that the design must comply with various standards. In addition to the Department's Standard Specifications, the following standards should be consulted:

An Information Guide for Roadway Lighting, AASHTO -- This is the basic guide for highway lighting. It includes information on warranting conditions and design criteria.

Standard Specifications for Structural Supports for Highway Signs, Luminaires and Traffic Signals, AASHTO -- This specification contains the strength requirements of the poles and bracket arms for the various wind loadings in Florida as well as the frangibility requirements. All luminaire supports, poles and bracket arms must be in compliance with these specifications.

Roadway and Traffic Design Standards -- These indexes are composed of a number of standard drawings or indexes which address specific situations which occur on a large majority of construction projects.

7.3.1 Design Criteria

The AASHTO Guide for Roadway Lighting permits either the illuminance technique or the luminance technique to be used in the design of highway lighting. The luminance technique requires a more complex design process and a knowledge of the reflective characteristics of the pavement surface used. These reflective characteristics change as the pavement ages and with variations in weather conditions. The Department has elected to

use the illuminance technique for lighting design. The design values for light levels given by the AASHTO Guide for Roadway Lighting are maintained values. The light levels given in this criteria have been adjusted and are listed as average initial horizontal footcandles (H.F.C.). This, in effect, sets the maintenance factor to be used in the calculation process to a value of 1.

Mounting height (M.H.) for conventional lighting is the vertical distance from the roadway to the light source, regardless of lateral placement of the pole. Pole setback is the horizontal distance from the edge of the travel lane to the pole.

7.3.2. Conventional Lighting Criteria

o Illumination Level:

Urban Arterials	1.5 average initial H.F.C.
All Other Roadways	1.0 average initial H.F.C.
Weigh Stations	2.0 average initial H.F.C.
Rest Areas	1.0 average initial H.F.C.

Note: These values should be considered as standard, but should be increased if necessary to maintain an acceptable uniformity ratio. The Maximum value should be one and one-half these values. Rest Area sections with pedestrian activity should be increased to 1.5.

o Uniformity:

4:1 or less	Avg/Min
10:1 or less	Max/Min

o Light Sources:

High Pressure Sodium 400 Watt or Less

- o Mounting Height Restrictions:

400 Watt HPS	40 FT. M.H. Min
250 Watt HPS	30 FT. M.H. Min
150 Watt HPS	25 FT. M.H. Min

7.3.3 High Mast Lighting Criteria

- o Illumination Level: 0.7-0.9 average initial H.F.C. over the area
- o Uniformity:

3:1 or Less	Avg/Min (on the roadway)
10:1 or Less	Max/Min (on the roadway)
- o Light Sources:
 - High Pressure Sodium 1000 Watt, 400 Watt
- o Mounting Height: 80 to 150 FT. (as design needs dictate)

7.3.4. Pole Design Criteria

Roadway and Traffic Design Standards Index 700 specify minimum setbacks for conventional lighting. A 20 feet minimum should be used where possible. Poles should be located at least 4 feet behind the face of guard rail and from the face of curbs. High mast lighting poles should be located as far from the travelled way as possible and in no case ~~within 10 feet of the edge of travelway~~ ^{shall they be within the clear zone} unless the pole is protected by barrier wall or guardrail. High mast lighting poles should not be located in gore areas within the runout length as defined in the AASHTO Roadside Design Guide. Engineering judgement should be used when locating high mast poles adjacent to bridges and high fills. All conventional height poles shall be frangible unless bridge or barrier wall mounted.

Frangible pole installations shall not be used in areas of heavy pedestrian traffic where the hazard of a falling pole is a greater hazard to others than it is to the motorist. See Roadway and Traffic Design Standards for frangibility requirements.

The installation of lighting in certain locations (e.g. adjacent to residential areas) may require the luminaires to be shielded. This is especially true for high mast poles.

Poles on bridges over open bodies of water or on causeway sections should be considered for dampers. These poles are subject to sustained winds of a critical velocity which may induce vibrations in the pole.

7.3.5 Underdeck Lighting Criteria

- o Luminaires - Pendant hung or pier cap mounted.
- o Light Source - High Pressure Sodium 150 Watt or 250 Watt
- o Illumination Level - The Light levels should be equal to the adjacent lighting.
- o Location - The location of pendant hung luminaires mounted between the bridge beams should not be such that the beams interfere with the spread of light. Normally the luminaires are mounted with 50 percent of the lamp below beams.

Pier cap mounted luminaires should be used when piers are less than 15 feet from the edge of the travel lane. They should be mounted on the bridge piers at 15 feet to 17 feet mounting height.

7.3.6 Foundations Criteria

Foundations for high mast poles are not standard and designs must be provided for each project. The Department has determined that drill shaft footings are the most economical. Drill shaft footings should be used unless special conditions require other types. Drill shafts are typically 4' in diameter as a minimum and have a minimum of 6" of cover on the reinforcing. Boring data should be requested to provide a basis for the design.

7.3.7 Wind Loading Criteria - *Lighting*

The wind loadings given below were taken from the AASHTO Standard Specification For Structural Supports For Highway Signs, Luminaires and Traffic Signals. The counties for each wind loading are listed for the appropriate mounting height.

M.H. of 50 Feet and Under

70 MPH	Alachua, Baker, Bradford, Calhoun, Clay, Columbia, Gadsden, Gilchrist, Hamilton, Holmes, Lafayette, Lake, Leon, Liberty, Jackson, Jefferson, Madison, Marion, Putnam, Sumter, Suwannee, Taylor, Union, Wakulla, Washington.
80 MPH	Bay, Charlotte, Citrus, DeSoto, Dixie, Duval, Escambia, Flagler, Franklin, Glades, Gulf, Hardee, Hendry, Hernando, Highlands, Hillsborough, Lee, Levy, Manatee, Nassau, Okaloosa, Okeechobee, Orange, Osceola, Pasco, Pinellas, Polk, Santa Rosa, Sarasota, Seminole, St. Johns, Volusia, Walton.
90 MPH	Brevard, Collier, Indian River, Martin, St. Lucie
100 MPH	Broward, Dade, Monroe, Palm Beach

M.H. over 50 Feet

80 MPH	Baker, Columbia, Gadsden, Hamilton, Holmes, Jackson, Jefferson, Lafayette, Leon, Madison, Suwannee
90 MPH	Alachua, Bay, Bradford, Calhoun, Charlotte, Citrus, Clay, Collier, DeSoto, Dixie, Duval, Escambia, Flagler, Franklin, Glade, Gilchrist, Gulf, Hardee, Hendry, Hernando, Highlands, Hillsborough, Lake, Lee, Levy, Liberty, Manatee, Marion, Nassau, Okaloosa, Okeechobee, Orange, Osceola, Pasco, Pinellas, Polk, Putnam, Santa Rosa, Sarasota, St. Johns, Sumter, Taylor, Union, Wakulla, Walton, Washington
100 MPH	Brevard, Indian River, Martin, Seminole, St. Lucie, Volusia
110 MPH	Broward, Dade, Monroe, Palm Beach

7.3.8 Lighting Project Coordination

Coordination with other offices and other agencies is a very important aspect of project design. The offices discussed in this section are not intended to be an all inclusive list with which the designer should coordinate, instead it includes offices that are normally involved in projects.

o Roadway Design - Normally the designer of a lighting project receives the base sheets for lighting design from the roadway designer. The roadway designer can also provide any required cross sections. If the lighting project is not an active roadway design project, base sheets may be obtained from existing plans or aerial photographs. If copies of existing plans are used for base sheets, the drainage maps are usually a good choice.

o Utilities - The District Utilities Engineer provides the coordination between the designer and the various utilities involved in the project. This usually is limited to agreements with the power company for electrical service. The Utilities Section can also identify potential conflicts with overhead and underground utilities or verify those which have previously been identified.

The Utilities Engineer should be contacted as ~~soon~~^{soon} as pole locations are set and the electrical load has been determined. The designer should indicate a preferred location for the electrical service location.

o Soils - Conventional height poles require the standard base shown in the Roadway and Traffic Design Standards, and only require foundation designs in special cases. High mast poles, on the other hand, require foundation designs for each location. Soil Borings are required for the design of the foundations. The District Soils Engineer should be requested to provide soils data as soon as high mast pole locations are determined.

o Drainage - ~~When the locations of high mast poles are established, they should be checked with the Drainage Section to determine if high water level is a problem. High mast poles are often located in the center of interchange loops. These same areas may be used as drainage retention areas. Coordination with the Drainage Section will alleviate this type problem.~~ When the locations ^{of high mast poles} are established, they should be checked with the Drainage Section to determine if high water level is a problem. High mast poles are often located in the center of interchange loops. These same areas may be used as drainage retention areas. Coordination with the Drainage Section will alleviate this type problem.

Chapter 14-64 of the Department Rules established the maintenance responsibility of lighting systems not on limited access or toll facilities as a local government function.

Normally the District Traffic Operations Engineer in conjunction with the District Utilities Engineer obtain the required maintenance agreements. The designer should coordinate with these offices to ensure that this activity is either underway or scheduled.

Any lighting project, especially high mast, adjacent to or in the vicinity of an airport, may be a potential problem. Any lighting project within 3 miles of an airport should be discussed with the Office of Public Transportation, Aviation Office to determine if a problem exists.

7.3.9 Voltage Drop Criteria

When determining conductor sizes for lighting circuits, the maximum allowable voltage drop from the service point on any one circuit is 7%.

7.4 Traffic Signals

The designer responsible for a traffic signal project should be aware that the design must comply with various standards. In addition to the Department's Standard Specifications, the following standards should be consulted:

Manual on Uniform Traffic Control Devices (MUTCD), FHWA - The MUTCD was adopted by the Department as the Uniform System of traffic control for use on the streets and highways of the State. The action was in compliance with Chapter 316.0745 of the Florida Statutes. The MUTCD is therefore the basic guide for traffic signals. The requirements of the MUTCD must be met, as a minimum, on all roads in the State.

Standard Specifications for Structural Supports for Highway Signs, Luminaires and Traffic Signals AASHTO - This specification contains the strength requirements of the signal supports for the various wind loadings in the State. All signal supports must be in compliance with these specifications.

Roadway and Traffic Design Standards - These standards are composed of a number of standard drawings or indexes which address specific situations which occur on a large majority of constructions.

7.4.1 Design Criteria

The MUTCD, as noted above, has been adopted as the uniform system of traffic control for use on the streets and highways of the state. The MUTCD is the basic guide for traffic signal design; therefore, the traffic signal designer should be familiar with this document. The criteria below supplements the MUTCD.

7.4.2. Certification and Specialty Items

Traffic signal equipment installed in Florida is required to be certified by the Department. The Office of Traffic Engineering in the Central Office is charged with the responsibility of certifying traffic control equipment. The designer of a traffic signal project, if requiring new equipment types or types not normally used, should contact Traffic Engineering in Tallahassee to determine the certification status of the equipment. Non-certified equipment cannot be used.

Standard specifications have not been developed for all signal equipment. Some items are project dependent and the development of standard specifications is difficult. Specifications for these items must be developed on a project by project basis and included in the contract as a special provision. Some of these specialty items are included on the Departments approved products list. For these items, detailed specifications are not required. The Office of Traffic Engineering should be consulted on these items.

7.4.3 Stop Line Location

A stop line which is not properly located invites violation by the motorist. The MUTCD specifies the minimum and maximum distances from the signal head to the stop line for adequate visibility. The traffic signal designer must insure that this requirement is met.

Instead of relocating the signal heads, the stop lines at many intersections have been moved from their proper location to comply with these requirements. The tendency for the motorist is not to stop at the new stop line location, but rather to creep beyond the stop line. This could in some cases result in valid calls being dropped, thereby increasing delay and decreasing the overall efficiency of the intersection.

The first step in the design process should be to locate crosswalks and stop lines properly. Then the signal head location should be determined to meet the MUTCD requirements. This may require changing the mounting configuration. A box span, for example, may be required where a diagonal span would normally be installed.

7.4.4 Controller Timings

The development of controller timings is a basic part of traffic signal design. A recent ruling from the Board of Professional Engineers stated that the development of timings is considered engineering and therefore requires the signature and seal of a professional engineer.

All traffic signal designs prepared for or by the Department shall include initial timings of all controllers. This is also true for signals to be included in local systems. If the timings in the plans are not implemented, it will be the responsibility of the agency providing the timings to insure they were prepared under the supervision of a professional engineer.

7.4.5. Left Turn Treatments

The guidelines given below should be followed when determining signal treatments for left turns.

o Single Turn Lane

Restrictive/Permissive Phasing - A five-section cluster should be used for this location. The head should be installed over the lane line between the left turn lane and through lane. The five-section cluster can serve as one of the two indications required for the through traffic.

Restrictive Phasing - A separate signal head for the left turn lane with red, yellow and green arrow indications should be positioned over the center of the left turn lane.

o Dual Turn Lanes

Only restrictive phasing should be used. Permissive movements should not be allowed for dual turn lanes. A single three section head with red, yellow, and green arrow indications should be centered over each turn lane. These heads are in addition to the dual indications required for the thru movement.

o Separated Turn and Thru Lanes

Turn lanes that are separated from the thru lanes more than 10 feet by a raised or painted island shall not be operated in the permissive mode.

o Single Lane Approach on Stem of "T"

Two three-section heads are required as minimum. All indications must be circular in this situation.

o Two Approach Lanes on Stem of "T"

Option #1: The approach may display two three-section heads with circular indications on all sections.

Option #2 : The approach may display a five-section cluster in conjunction with a three-section head. If the lanes are exclusive left and right turn lanes, then the five-section cluster should be placed over the center of the lane line and the three-section head over the major movement lane. If one of the lanes is a shared left and right lane, then the five-section cluster should be placed over the center of this lane and the three-section head over the center of the other lane.

Option #3: The approach may display two three-section heads for the major movement and a single three-section head for the secondary movement

o Three Approach lanes on Stem of "T"

Option #1: The approach may display two three section heads for the major movement and one for the secondary movement (Exclusive left and right turn lanes).

Option #2: The approach may display a five-section cluster in conjunction with three-section head (exclusive left and right turn lanes). The five-section cluster should be placed over the center of the lane line separating the left turn lane(s) from the right turn lane(s). The three-section head should be placed over the other lane line to provide dual indication for the major movement.

Option #3: When the middle lane is a shared left and right turn lane, then a five-section cluster should be placed over the center of this lane and a three section head placed over each of the other two lanes. Each head must contain green and yellow arrow indications in this situation.

NOTE:

1. For all cases, the approach shall display "dual indications". This means that there must be at least two heads with identical indications on the major approach. For example, if a green arrow is displayed on one head of the major movement or approach then a green arrow must be displayed on the second head.
2. The same signal display option should be used throughout an urban area to provide consistency in display to the motorist.

3. The use of advance and/or overhead lane use signs should be used as a supplement to pavement arrows on stems of signalized "T" intersections.

7.4.6. Signal Preemption

The engineer responsible for the design of a traffic signal project should, as a matter of routine, check each intersection to determine if the need for signal preemption is present.

Intersections located within 200 feet of moveable span bridges or railroad crossings should be considered. Those located at distances greater than 200 feet should be considered if the queues frequently extend to the moveable span or crossing.

Intersections near fire stations require individual study. This is necessary to determine the interaction between the fire station vehicles and the intersection operation. This information must be known before the preemption sequence can be developed.

7.4.7 Intersection Design - Lane Configuration

The engineer responsible for the traffic signal design may be asked to verify the number and configuration of traffic lanes required for an intersection to function properly when signalized.

The results are dependent upon the traffic volumes used in the analysis. The traffic used for this calculation shall be the design hourly volume based on the 30th highest hour (k factor) and not a peak to daily (P/D) ration based on a 24 hour count. The k factor volumes account for traffic variations through the year, and, in most case, are higher than P/D volumes.

The K, D, and T factors convert the two-way AADT volumes to a one-way Design Hour Volume (DHV). This is appropriate for the total approach movements. The AM and PM peak turning movement counts on each approach should be addressed individually. Current turning movement counts should be taken to determine the percentage of turns for each approach. These percentages should then be applied to the DHV for each approach volume to determine the turning volumes which should be used for the turn lane design calculations. These values should be compared to the movement counts supplied by Planning and the greater of the two values used for the design of turn lanes. The District Planning Office should be contacted to determine if recent counts are available and also if any use changes are planned which would require adjustments to the turn percentages found in the current counts.

Storage lanes for left turns can affect the capacity and safety of intersections. The storage length of a left turn lane is a critical design element. The queue of left turn vehicles in a storage lane of inadequate length may extend into the through lanes. The result is loss of capacity for the through lanes. The queue of through vehicles may also extend beyond the entrance of a short left turn storage lane blocking access to the storage lane. Either case results in a less efficient operation of the intersection and may cause last minute lane changes, thereby increasing the possibility of conflicts.

The important factors which determine the length needed for a left turn storage lane are:

- o The design year volume for the peak hour (see discussion above).
- o An estimate for the number of cycles per hour.
NOTE: If the cycle length doubles, the length of the storage for the same traffic also doubles.
- o The type of signal phasing and timing which will control the left turn lanes.

There are several techniques used to determine necessary storage length. The following are suggested guidelines for left turn lanes.

- o Where protected left turn phasing is provided, an exclusive turn lane should be provided.
- o Left turn lanes should be provided when turn volumes exceed 100 vph and may be considered for lesser volumes if space permits.
- o For signalized intersections, the following formula may be used, assuming an average vehicle length of 25 feet.

$$L = \frac{2.0}{(20)} \frac{(DHV) (25)}{N}$$

Where

L = design length for left turn storage in feet

DHV = left turn volume during design peak hour, in vph

N = number of cycles per hour for peak hour, use N = 30 as default.

- o Where left turn volumes exceed 300 vph, a double left turn should be considered.
- o When right of way has already been purchased, and the designer has to choose between a long wide grass median or a long left turn lane, the storage length for the left turn should be as long as practical without hindering other access.

Right turn lanes are provided for many of the same reasons as left turn lanes. Right turns, are, however, generally made more efficiently than left turns. Right turn storage lanes should be considered when right turn volume exceeds 300 vph and the adjacent through volume also exceeds 300 vphpl.

7.4.8. Signal Loops

Traffic signal loops are detailed in Roadway and Traffic Design Standard 17781. These loops are standard and will be appropriate for most locations.

The traffic signals for each intersection should be individually designed. The requirement for type and placement of loops is a part of this design. The above standard allows for some variation in size and placement of the standard loops. These modifications are intended to be used only when required by the design of a particular location.

7.4.9 Wind Loading Criteria - Traffic Signals

The wind loadings given below were taken from the Standard Specifications For Structural Supports For Highway Signs, Luminaires and Traffic Signals, AASHTO. The Counties for each wind loading as as listed.

70 MPH Alachua, Baker, Bradford, Calhoun, Clay, Columbia, Gadsden, Gilchrist, Hamilton, Holmes, Lafayette, Lake, Leon, Liberty, Jackson, Jefferson, Madison, Marion, Putnam, Sumter, Suwannee, Taylor, Union, Wakulla, Washington

80 MPH Bay, Charlotte, Citrus, DeSoto, Dixie, Duval, Escambia, Flagler, Franklin, Glades, Gulf, Hardee, Hendry, Hernando, Highlands, Hillsborough, Lee, Levy, Manatee, Nassau, Okaloosa, Okeechobee, Orange, Osceola, Pasco, Pinellas, Polk, Santa Rosa, Sarasota, Seminole, St. Johns, Volusia, Walton

90 MPH Brevard, Collier, Indian River, Martin, St. Lucie

100 MPH Broward, Dade, Monroe, Palm Beach

Chapter 8

Bicycles and Pedestrian Facilities

8.1 General

Pedestrians and bicycle riders may often wish to travel between the same locations as other vehicular traffic. When this occurs, the designer should consider the effects on the safety and operation of the roadway system. A special effort should be made to provide the greatest degree of safety within the economic constraints that must always be considered.

Additional special bicycle and pedestrian facilities should be provided where the use of travel lanes or wide paved shoulders is deemed unacceptable or unsafe for the pedestrian or bicycle rider. It is the Department's policy to provide for bicycle and pedestrian needs within one mile of urban areas.

Pedestrian facilities include sidewalks, crosswalks, traffic control features, special walkways, curb cut ramps for the handicapped and bus facilities.

8.2 Sidewalks

The design of sidewalks is affected by pedestrian volume, traffic volume, average pedestrian age, walking rate, required level of service, location, etc. The Florida Green Book and the AASHTO Policy on Geometric Design present the various factors that influence the design of sidewalks and other pedestrian facilities.

All urban projects that have sufficient right-of-way to provide adequate lane, median, sidewalk and border widths should be thoroughly evaluated to provide a reasonably safe and cost effective design. A distance of as little as 2' between the back of sidewalk and right-of-way can be effective in minimizing construction easements by using a 1' berm and 2:1 slope or a 4:1 slope between the sidewalk and right-of-way. Differences in elevation up to 6" can be accommodated in this manner. Caution must be exercised in using this treatment at connections to driveways since this distance and slope will not assure adequate vehicular connections (see Index 515).

Sidewalks should be constructed in conjunction with all new construction, major reconstruction and lane addition curb and gutter projects. As a general practice, sidewalks should be constructed along both sides of arterial streets that are not provided with shoulders, even though pedestrian traffic may be light. Exceptions may be made to the construction of sidewalks on both sides of the street when the roadway parallels a railroad or drainage canal and pedestrians would not be expected and in some cases on bridges. If sidewalks are constructed on the approaches to bridges, they should be continued across the structure.

The standard width for sidewalks is 5 feet when separated from the curb by a buffer strip. A 4 foot minimum may be used in areas with few pedestrians. When sidewalks are constructed adjacent to the curb, the minimum width should be 6 feet. Additional width of sidewalk may be provided when traffic volumes, truck volumes, pedestrian volumes or vehicular speeds are high. Proximity to schools should also be considered for additional width. The Department's Bicycle Facilities Planning and Design Manual states that it is important to recognize that the development of wide sidewalks does not necessarily add to the safety of sidewalk bicycle travel. Wide sidewalks encourage higher-speed bicycle use and can increase the potential for conflicts with motor vehicles at intersections, as well as with pedestrians and fixed objects. Both the AASHTO Guide for Bicycle Facilities and the Florida Green Book state that bicycle riding on sidewalks can be expected in residential areas with young children who are too inexperienced to ride in the street. This type of bicycle use is generally accepted, but it is not appropriate to sign a sidewalk as a bicycle path. It is not appropriate to provide both wide curb lanes for the benefit of the experienced bicyclist and wide sidewalks that may encourage high speed bicycle use. Five foot sidewalks are to be provided unless greater widths are justified for pedestrian use. A method for determining pedestrian facility needs is given in the Highway Capacity Manual.

8.3 Handicap Access

Pedestrian facilities such as walkways and sidewalks must be designed to accommodate the physically handicapped persons whose mobility is dependent on wheelchairs and other devices. Street intersections with steep-faced curbs are one form of obstacle that can be alleviated while still providing reasonable mobility for the handicapped without sacrificing the mobility of others.

In areas with sidewalks curb cut ramps must be incorporated. The basic ramp type and design application depends on the geometrical characteristics of the intersection. Standard Index No. 304 sets forth the requirements and standards for curb cut ramps. Placement of inlets should not conflict with curb cut ramps.

All Department facilities (roadway, parking lots, rest areas, buildings, pedestrian bridges, etc.) must be designed in compliance with current handicap Florida statutes, rules and regulations. Design must also meet minimum requirements of the American National Standards Institute (ANSI 117.1) for accommodation of the handicapped.

8.4 Bicycle Facilities

The bicycle has become an important element for consideration in the highway design process. In recent years the emphasis in bicycle system planning has changed from attempts to provide completely separate facilities for bicyclists to the growing recognition that bicyclists are legitimate users of the roadway. Recent studies have shown that in many cases shared roadway facilities afford greater safety for the bicyclists than sidewalk facilities because of the increased visibility and maneuverability. Certain measures such as :

- o Paved shoulders
- o Wide outside traffic lanes if no shoulders
- o Bicycle-safe drainage grates
- o Adjusting manhole covers to grade
- o Maintaining a smooth, clean riding surface

can considerably enhance a route's safety and capacity for bicycle traffic without impacting the service for motor vehicles on the roadway.

Planning and design consideration for bicycle facilities are given in the AASHTO ^{Policy on Geometric Design} ~~Manual~~ and the AASHTO Guide for Development of New Bicycle Facilities.

The Department's current policy is to give special emphasis to the needs of bicyclists in and within one mile of urban areas. This policy will generally provide for the construction of wide curb lanes, bicycle lanes or paved shoulders for the needs of bicyclists in conjunction with other planned roadway improvements. The lack of adequate right of way and the cost associated with its acquisition in built up areas may not allow provision of the additional width for bicyclists on all projects. Roadway improvements in the smaller urban areas (5,000 to 50,000 population) and the more rural areas

should be reviewed on a case-by-case basis depending on anticipated bicycle travel and the need for wider pavement or paved shoulders based on other safety and operational benefits. Anticipated bicycle travel should be considered of sufficient volume when the roadway section is identified for bicycle improvements in the Transportation Improvement Program, the State Transportation Plan (Bicycle Elements) or other approved Community Comprehensive Bicycle Transportation Plans.

The Department's Bicycle Facilities Planning and Design Manual should be referenced for the design of bicycle facilities. Chapter 2 of this volume discusses shoulder width criteria when bicycle use is anticipated.

Chapter 9

Landscaping

9.1 General

The complete highway is one wherein the elements of design, construction and maintenance have been integrated to provide a facility that possesses utility, safety, beauty and economy. The highway should be considered as an element of the total environment, not apart from it or in conflict with it. All highway-oriented disciplines should collaborate at each stage of highway corridor selection, location, and design to obtain the maximum beneficial potential of the highway, its roadsides, and its environment.

The highway roadside is an integral unit of a total highway facility. The term "roadside" generally refers to the area between the outer edge of the roadway and the right-of-way boundary. It could include extensive areas in a wide median of a divided highway. Roadside development is the treatment given to the roadside to conserve, enhance, and effectively display the natural beauty of the landscape through which the highway passes. It should provide safety, utility, economy, and highway-related recreation facilities by means of proper location, design, construction, and maintenance.

Because the potential for conflict between the highway and environmental values is greatest in urban areas, it is essential that special attention be given to the multiple use-joint development possibilities in areas over, under, and adjacent to the highway to ensure that land and space above the highway provides the greatest benefit to the greatest number.

Landscape development should be in keeping with the character of the highway and its environment. Programs include the following general areas of improvement:

- o Preservation of existing vegetation.
- o Transplanting of existing vegetation where feasible.
- o Planting of new vegetation.
- o Selective clearing and thinning
- o Regeneration of natural plant species and material.

The objectives in planting or the retention and preservation of natural growth on roadsides are closely related. In essence, they are to provide vegetation that will be an aid to esthetics and safety, aid in lowering construction and maintenance costs, and create interest, usefulness, and beauty for the pleasure and satisfaction of the traveling public.

Landscaping of urban highways and streets assumes additional importance by mitigating many of the nuisances associated with urban traffic. Landscaping should be arranged to permit sufficiently wide, clear, and safe pedestrian walkways. Combinations of turf, shrubs, and trees are desirable in border areas along the roadway. However, care should be exercised to ensure that requirements for sight distances and clearance to obstructions are observed, especially at intersections.

Further information concerning landscape development and erosion control is presented in AASHTO's A Guide for Highway Landscape and Environmental Design. The Department's Roadway and Traffic Design Standards Booklet sets forth specific criteria and standards for erosion control and roadside landscaping. The Department's Landscaping Guidelines (document No. 650-050--001b) provides the general criteria for use in the development of landscaping plans for roadway projects.

Chapter 10

WORK ZONE TRAFFIC CONTROL

10.1 General

The need to improve the capacity of, and to rehabilitate Florida's highways, has greatly increased the frequency of highway construction taking place immediately adjacent to or under traffic. The travelling public, as well as construction and inspection personnel, are exposed to conflicts that may become hazardous. In addition to the safety issue, the potential delays to the public, as traffic is interrupted by construction, can be significant. As a result, the Department places a great deal of emphasis upon ensuring that traffic can be accommodated through construction zones with minimum delay and exposure to unsafe conditions.

10.2 References

The following references contain the basic criteria for work zone traffic control in Florida

The Manual on Uniform Traffic Control Devices for Streets and Highways, (MUTCD), Federal Highway Administration. Part VI of the MUTCD deals specifically with work zone traffic control. Other parts of the MUTCD may also be useful in designing a traffic control plan

Traffic Control Devices Handbook, (TCDH) Part VI, Federal Highway Administration

Policy on Geometric Design of Highways and Streets, AASHTO

Roadside Design Guide, AASHTO, Chapter 9

Roadway and Traffic Design Standard Index Series 600, 415 and 700.

Federal-aid Highway Program Manual (FHPM) 6-4-2-12

10.3 Comprehensive Work Zone Traffic Control Planning

Consideration of traffic control must begin at the Project Development and Environmental (PD&E) study stage. Impacts on traffic, traffic handling options, constructability, and design features and constraints, as they affect traffic, are to be evaluated for each alternate alignment studied. The preliminary and final engineering reports must specifically address work zone traffic control.

Traffic control considerations must begin in the early stages of design, using the work zone traffic control material from the PD&E study as the basis. As the design progresses, the following should be considered

Design features and constraints. Length of the project, lane configuration, and grade differentials between existing and proposed, interchanges and intersections, pavement materials, storm sewers, roadway lighting, utilities and bridge features are some of the design element decisions that might be influenced by work zone traffic control considerations.

Contract specifications. Provisions such as time restrictions on construction activities; incentive-disincentive clauses, daily, weekly and seasonal restrictions and special materials may be necessary. Public relations activities such as media releases, television and radio spots, hand bills, and highway advisory radio may be specified

Other actions. Actions may need to be taken by the Department prior to or during construction that may not be a contract requirement. Examples are dealing with the media and local businesses, provisions for mass transit options to commuters, service patrols, improvements to alternate routes, coordination with other projects and maintenance activities, and special inspection requirements

Public input. On very large and complicated projects, it may be necessary to involve the public through informal public meetings to be held early in the design of a project. Close coordination with city and county officials may be necessary. Citizen and business advisory committees may be established as sources of input.

Utility work. If contract utility work is anticipated in conjunction with or during the highway construction, the Traffic Control Plan (TCP) must account for and adequately protect all work activities. The phasing of construction activities must be compatible with the utility work. Utilities, whose work affects traffic, are required to have a TCP by FHWA's FHPM 6-6-3-2. This requires early and effective coordination with utilities.

10.4 Traffic Control Plans (TCP)

A TCP is a set of specific plan sheets, references to standard (typical) layouts, and/or notes on roadway plans describing how traffic will be controlled through a work zone. All projects and work on highways, roads and streets shall have a traffic control plan, as required by Florida Statute and Federal regulations. All work shall be executed under the established plan and Department approved procedures. The TCP is the result of considerations and investigations made in the development of a comprehensive plan for accommodating traffic through the construction zone. These considerations include the design itself, contract specifications, and plan sheets.

TCP sheets detail the proper delineation of traffic through the work zone during all construction phases. The complexity of the TCP varies with the complexity of the traffic problems associated with a project. Many situations can be covered adequately with references to specific sections from the Manual on Uniform Traffic Control Devices (MUTCD), the Traffic Control Devices Handbook (TCDH), or Roadway and Traffic Design Standard Series 600. Specific TCP sheets shall be required in the plans set whenever project conditions are not specifically addressed in a typical layout from the manuals noted above. This is usually the case for complex projects, and therefore references to Standard Indexes, as well as specific TCP sheets, will both likely be necessary.

A quality traffic control plan should include the following information for the mainline and any affected cross roads, side streets, and ramps:

- (1) the location of all advance warning signs and lighting units
- (2) temporary pavement markings, (including RPM's) for detours, transitions or other special situations
- (3) location of temporary barriers and attenuators
- (4) temporary drainage devices
- (5) channelizing devices at special locations
- (6) locations for special devices such as variable message signs (VMS), arrow boards, and temporary signals

- (7) VMS messages for each phase
- (8) signal timing for each phase, including method of temporary actuation if needed (Check with Traffic Operations Engineer)
- (9) location and geometry for transitions and detours
- (10) typical sections for each phase of work on all projects, except simple resurfacing projects, in order to show lane widths, offsets, barrier locations and other features influencing traffic control
- (11) the proposed regulatory speed(s) for each phase
- (12) reference to appropriate Standard Indexes or MUTCD drawings whenever applicable
- (13) appropriate quantities, pay items and pay item notes
- (14) resolve any conflicts between permanent signing and markings and work zone signing and markings
- | (15) key strategies such as service patrol, police, public service
| announcements, Highway Advisory Radio, night work
- | (16) good plan notes
- | (17) address the need for maintaining existing roadway lighting
- | (18) work area access plan

Chapter 19, Volume II, Plans Preparation and Assembly, explains the required information for specific TCP sheets

Consideration must also be given to adjoining, intersecting or sequential work zones. This can be a particular problem with maintenance operations, bridge or roadway projects under different contracts, operations of other jurisdictions or utilities. When such work must take place, the operations must be coordinated and taken into account in the TCP so that the motorist encounters one, consistently designed, work zone.

TCP's for project designs "on the shelf" must be updated prior to contract letting.

10.5 TCP Development

The following step-by-step process should be followed by designers when preparing traffic control plans

STEP #1 Understand the Project

- o Field reviews by designers should be required
- o Review the scope
- o Examine the plans (30% - 60%)
- o Look at plan-profiles and cross-sections for general understanding.
- o Review PD&E study for any constraints
- o Consider bicycle/pedestrian needs during construction
- o For complex projects consider developing a TCP study and possible TSM strategies such as public awareness campaigns, alternate route improvements, service patrols, etc

STEP #2 Develop Project Specific Objectives

What are your objectives? Examples might be

- o use barrier wall to separate workers from traffic
- o close road if adequate detour exists
- o maintaining 2-way traffic at all times
- o maintaining existing roadway capacity during peaks
- o maintaining business/resident access
- o provide bike/pedestrian access
- o minimize wetland impacts
- o expedite construction

| STEP #3 Brainstorm TCP Alternatives

Develop some rough alternatives, considering what could be used to accomplish the work, such as constructing temporary pavement and/or temporary detours, using auxiliary lanes, placing 2-way traffic on one side of divided facility, using detour routes, etc. Also, southside as opposed to northside on an east-west roadway. Don't worry that an alternate doesn't meet all objectives

Designers should check condition of any proposed detour routes. If off state system, may need agreement with locals.

| STEP #4 Develop a Construction Phasing Concept

- o Examine existing facility versus what is to be built
This is a major task on jobs other than resurfacing
- o Coordinate with bridge designers
- o Color or mark the plan and profile sheets to show existing roadway versus new construction. Then, check station by station, the plan sheet against cross-section sheets. Make notes on plan sheets as to dropoffs or other problems. Use profile grade lines or centerlines for reference points.

- o List out major tasks to be completed, such as

- construct new WB Roadway
- construct new EB Roadway
- construct frontage roads
- construct bridge/flyover

NOTE The designer may need input from construction personnel or even contractors representatives in determining construction phases

- o Make notes on plan sheets or notepad as to "decisions" that you make along the way

STEP #5 Examine/Analyze Alternatives Which Meet Objectives (for each phase).

Next, consider how you could achieve the proposed alternatives and meet the stated objectives.

Examine pros and cons of various alternatives

Consider how much work and expense is involved for each alternative

Consider detour/transition locations, signal operations during construction, how to handle alternate modes of transportation-buses, bikes, pedestrians, service vehicles, etc.

STEP #6 Develop Detailed TCP

Select the most feasible alternative for each phase Add details such as

- o detour/transition geometrics and locations
- o if lane closures are needed, use the lane closure technique discussed in 10 15 7 to determine time frame for closures,
- o advanced signing scheme and locations, revisions needed to existing signs - including guide signs, and proposed signs for all work activities - lane closures, detours, etc., on mainline, sideroads, x-roads and ramps
- o need for portable traffic signals, variable message signs, and barriers,
- o how existing operations will be maintained - side streets, businesses, residents, bikes, pedestrians, buses - bus stops, etc ,
- o revisions to signal phasing and/or timing during each TCP phase,
- o regulatory speed desired for each phase,
- o all pay items and quantities needed for TCP

- o how existing Auxiliary lanes will be used and any restriction necessary during construction.
- o typical sections for each phase
- o outline key strategies to be used
 - (a) service patrol
 - (b) police
 - (c) public service announcements
 - (d) Highway Advisory Radio
 - (e) night work

- o need for Alternate route improvements

10.6 Coordination

Work zone traffic control can be a complex undertaking that requires the coordination of a number of agencies and other interested parties. Planning and coordination must begin early in a project design.

Traffic control is a joint responsibility of design (both roadway and bridge), construction and traffic operations personnel. Coordination is necessary by all three parties in the development of TCPs. Both traffic operations and construction personnel must routinely review TCPs in the early stages of development (30 - 60% plans) to ensure that the plan is sound and constructible and bid items are complete and quantities reasonable. Designers are also encouraged to contact contractors for ideas on Traffic Control Plans.

Traffic control plans should also be reviewed with other appropriate offices such as maintenance, FHWA, community awareness teams, public, businesses, freeway coordinator management teams and local agencies. Initial reviews should be made by construction and traffic operations no later than the 60% plans stage with subsequent reviews of 90% plans. Input from local engineering and law enforcement agencies should be obtained early in the process, such as during the PD&E study and the 30% plans stage.

Adjoining work zones may not have sufficient spacing for standard placement of signs and other traffic control devices within their traffic control zones. These situations can occur when separate contracts adjoin each other (separate bridge and roadway contracts are a typical example), utility work performed separately from roadway work or when maintenance activities are performed adjacent to a construction project. Where such restraints or conflicts occur, or are likely to occur, the designer should try to resolve the conflicts in order to prevent misunderstanding on the part of the travelling public.

10.6.1 FHWA Review

The type and format of TCPs on Federal-aid projects must be coordinated with FHWA early during design. TCPs for federal aid projects are to be submitted to FHWA for review not later than at the 60% plan stage.

| 10.6.2 Phase Submittals

| TCP phase submittals should include the following

| Phase I (30%) - a typical section for each phase as well as a description of the phasing sequence and work involved

| Phase II (60%) - a majority of the TCP completed (~75-90%) including the information outlined in section 4 of this chapter (Section 10.4) and a list of the pay items needed

| Phase III (90%) - a final TCP, including all notes, pay items and quantities

10.7 Work Zone Traffic Control Training

10 7 1 Background

Work zone traffic control is an important function affecting the safety of the traveling public, contractor personnel and equipment, and department employees. Every reasonable effort should be made to eliminate or reduce involvement in accidents within work zones. Proper traffic control training is vital to achieving this objective.

The Department's Maintenance of Traffic Committee consists of representatives from Roadway Design, Construction, Safety, Maintenance, Traffic Engineering, Value Engineering and FHWA. Its purpose is to develop, review or revise procedures, standards and specifications regarding work zone traffic control to maximize efficiency and enhance safety of motorists, pedestrians, and workers in these zones.

10 7 2 Training Requirements

The Department's Maintenance of Traffic Committee has prescribed work zone traffic control training requirements for Department employees and shall furnish training course information and requirements to each District's Human Resource Development Manager.

Every employee, including consultants, whose activities affect maintenance and construction work zone safety, from upper-level management through construction and maintenance field personnel, shall complete appropriate training as prescribed above and as required by Department procedure number 750-030-006-a.

District Design, Construction, and Maintenance Engineers shall ensure that employees, including consultant personnel, who are responsible for traffic control plan design, implementation, inspection or supervision of the design, selection, placement, or maintenance of traffic control schemes and devices in work zones have been certified under the provisions of this procedure.

10.8 Traffic Control Devices

Traffic control devices/methods that are available for use include:

- Signs (warning, regulatory and guide)
- Lighting units (arrow panels, barricade and sign lights, illumination devices, temporary signals and variable message signs)
- Channelizing devices (cones, tubular markers, plastic drums, vertical panels, Types I, II and III barricades)
- Markings (pavement markings, raised pavement markings, delineators, and removal of conflicting markings)
- Safety appurtenances (portable concrete barriers, guardrail and crash cushions) - See AASHTO Roadside Design Guide (Chapter 9).
- Flaggers
- Police
- Guardrail attached to barrels for work zones \leq 45 mph - See AASHTO Roadside Design Guide.

The MUTCD contains detailed instructions on the use of traffic control devices. Special design considerations applicable to Florida are discussed in the following sections.

10.9 Signs

10.9.1 Advance Warning Signs

The TCP should identify the advance construction warning signs, including legends and location , These include signs such as "Road Construction Ahead", and "Road Construction One Mile" The TCP should provide the advanced warning signs, legends and locations for all proposed operations which require signing These include detours, lane closures, and flagging operations on the mainline as well as crossroads The sequence for advance signing should be from general to more specific . As an example Road Construction Ahead (general), Left Lane Closed Ahead (more specific), Merge Right (specific)

10 9.2 Length of Construction Sign

The length of construction sign (G20-1) bearing the legend "ROAD CONSTRUCTION NEXT ____ MILES" is required for all projects of more than 2 miles in length The sign shall be located at begin construction points Mileages should be to nearest 0 1 mile

10 9.3 Sign Covering

Signs (temporary and permanent) that warn of conditions shall be covered or removed when the condition is not present, such as might occur in work zones with daytime only operations Traffic control signs that require covering shall be fully covered with a durable opaque sheet materials Plastic film and woven fabrics including burlap will not be permitted Covering of only the legend or symbol will not be permitted Reflective coverings will not be permitted Hinged signs designed to cover when folded and sign blanks are permitted Signs to be covered or removed will be identified in the TCP, along with acceptable procedures

10.9.4 Existing Signs

| Existing (regulatory, warning, etc) signs that conflict with the TCP shall be removed. Existing guide signs should be modified as necessary. It is good practice to revise existing guide signs by using black on orange panels to show changes made necessary by the construction operations.

If permanent guide signs are to be removed during construction, provisions should be made for temporary guide signing. The temporary sign should be black on orange with the legend designed in accordance with MUTCD requirements for permanent guide signing whenever possible.

10.10 Lighting Units

10.10.1 Warning Lights

Warning lights shall be in accordance with Section 6E-5 of the MUTCD except for the limitations below

Flashing

Type A low intensity flashing warning lights should be mounted on barricades, drums, or vertical panels and are intended to continually warn drivers that they are approaching or proceeding in a hazardous area. Flashing lights shall not be used to delineate the intended path of travel, and shall not be placed with spacings that will form a continuous line to the driver's eye. The Type A light will be used to warn of isolated obstructions that are located adjacent to or in the intended travelway, and to mark the approach to closed or detoured travel lanes. Type A lights shall not be used in conjunction with the first and second advance warning signs.

Type B high intensity flashing warning lights shall be mounted on the first advanced warning sign and on the first and second advanced warning sign where two or more signs are used. This applies to all approaches to any work zone. The first and second advance warning signs shall be supplemented with an 18 inch by 18 inch warning flag.

Steady-Burn

Type C steady-burn lights are to be mounted on barricades, drums, concrete barrier walls or vertical panels and used in combination with those devices to delineate the travel way on lane closures, lane changes, detour curves and other similar conditions. Steady-burn lights are intended to be placed in a line to delineate the traveled way through the work zone and around obstructions in the transition area, buffer space, work space and termination area of the traffic control zone. Steady burn lights often serve the dual purpose of delineation and hazard warning.

10.10.2 Advance Warning Arrow Panels

Arrow panels shall be used to supplement other devices for all lane closures on high-speed and high-traffic density multi-lane roadways. The use of arrow panels should be considered for all other multi-lane closures. These devices are also useful for short-term operations, such as during work zone installation and removal. Arrow panels should not be used in lane shift situations. Research has shown that motorists tend to change lanes (on multi-lane facilities) whenever an arrow panel is used to indicate a lane shift. Since this "response" is not desired, the arrow panel should not be used for lane shift situations on multi-lane roadways. Refer to MUTCD 6E-7 for further information.

Arrow panel locations shall be shown on the TCP, along with any necessary notes concerning the use of this device.

10 10.3 Variable Message Signs

Variable message signs may be used to supplement a traffic control zone. As a supplemental device, it cannot be used to replace any required sign or other device. These devices can be useful in providing information to the motorist about construction schedules, alternate routes, expected delays, and detours. Variable message signs should be considered for use in complex, high-density work zones. Messages must be simple, with a minimum number of words and lines and should require no more than three displays of no more than three lines each. The TCP should include the location and messages to be displayed.

The message displayed should be visible and legible to the motorist at a minimum distance of 900 feet on approach to the signs. All messages should be cycled so that two message cycles are displayed to a driver while approaching the sign from 900 feet at 55 mph.

The VMS units may be used

- To supplement conventional traffic control devices in construction work areas and should be placed approximately 500' to 800' in advance of potential traffic problems, or
- 1-2 miles in advance of complex traffic control schemes which require new and/or unusual traffic patterns for the motorists

Message Selection

Programmed messages should provide appropriate messages for the conditions likely to be encountered. The following items must be carefully considered in the development of a message.

(1) Message elements - not necessarily in order

- (a) problem statement (where?)
- (b) effect statement (what?)
- (c) attention statement (who?)
- (d) action statement (do?)

(2) Message format

- (a) will vary depending on content
- (b) "where" or "what" will generally lead
- (c) "who" and "do" follow in that order
- (d) "who" often understood from "where"

(3) Message length

- (a) limited by reading time (e.g., 900' at 55 mph provides 11 seconds of reading time)
- (b) limited by driver's processing capability
- (c) 4 word maximum, one part message
- (d) 8 word desirable max if two or three sequence message is used
- (e) shorter messages desirable to permit multiple readings
- (f) if two or three sequence messages is programmed, allow for off-time between messages

(4) Display format

- (a) discrete with entire message displayed at once is most desirable
- (b) sequential is OK, 2 part preferred, 3 part maximum
- (c) run-on moving displays prohibited
- (d) one abbreviation per panel display desirable, two abbreviations are maximum. Route designation is considered as one abbreviation and one word

EXAMPLE

	Display 1	Display 2	Display 3
(a)	R A M P TO SR 26 E C L O S E D	U S E A L T R O U T E	
(b)	I-95 R O A D C L O S E D	F O L L O W D E T O U R R O U T E	
(c)	I-495 A T E X I T 30	2 R I G H T L A N E S C L O S E D	E X P E C T D E L A Y S

Typical Conditions

Consistent with the factors described above, VMS messages should be considered under the following conditions

- (1) Road closures
- (2) Ramp closures
- (3) Delays one hour or longer created by
 - (a) congestion
 - (b) accidents
 - (c) lane closures
 - (d) two-way traffic on divided highway
 - (e) multiple lane closures
 - (f) unexpected shifts in alignment

10.10.4 Traffic Signals

Frequently portable or temporary traffic signals will be a preferred alternative to a flagger. Also, existing signal operations may need to be revised to accommodate the construction operations. The TCP should identify the specific alterations (physical location and timing) necessary for existing signals and the location and timing of portable signals. Signal displays and location must meet MUTCD requirements.

10.11 Channelizing Devices

10.11.1 Type III Barricades

12 foot Type III barricades have proven too cumbersome for work site applications. Two 6 foot Type III barricades should be used to block off or close a roadway. Whenever two 6 foot barricades are used together, only one warning light is required on the 12 foot of barricade.

10.11.2 Separation Devices

Placing two lane two-way operations (traffic) on one roadway of a normally divided highway (TLTWO) should be a last resort and should be done with special care. An analysis similar to that presented on pp 6-57 thru 6-61 of the TCDH, should be performed and documented when contemplating the need for TLTWO.

"Separation" is defined in FHPM 6-4-2-12 and requires the use of devices such as those presented on pp 6-57 and 58 of the TCDH. These include temporary barrier, drums, cones, tubular markers, or vertical panels. Separation devices are required for TLTWO unless (1) it is used on an urban street where speeds are low, or (2) drivers entering the TLTWO can see the transition back to normal one-way operation on each roadway. Striping, RPM's and signing alone, are not allowed when separation devices are required.

Experience has also shown that stand alone tubular markers for long term operations are difficult to maintain and therefore their effectiveness is questionable. The use of a temporary asphalt separator in conjunction with the tubular markers has been very effective (see Index 614)

| 10.11.3 Channelizing Device Alternates

| It is intended that cones, Type 1 and 2 barricades, vertical panels, drums
| and tubular markers be considered as alternative channelizing devices to
| be used at the contractor's option. The only exception to this is that
| cones and tubular markers are not allowed at night. If the designer wants
| to further restrict the options (i.e. require drums, etc.) it must be so
| noted on the plans or in the supplemental specifications.

10.12 Pavement Markings

10.12 1 Removing Pavement Markings

Existing pavement markings that conflict with temporary work zone traffic patterns must be obliterated where operations will exceed one work period. Painting over existing pavement markings is not permitted.

10.12 2 Reflectorized Raised Pavement Marker (RPM)

Temporary RPMs are required on the lane lines of all transitions, crossovers and detours and to delineate temporary gore areas within the work zone. The spacing shall be 40 feet on tangent sections and 20 feet on transitions, curves and crossovers.

The designer should also consider using temporary RPMs on temporary lane lines, particularly on high-volume, high-speed facilities. An example would be on urban freeways where lane line removal and restriping is required due to lane shifts.

10.12 3 Work Zone Markings

Section 102-3.3 of the Standard Specifications, provides a pay item for "Non-Removable Pavement Markings" (Item #102-92-3 for skip and 102-92-4 for solid) which includes Non-Removable or Removable Pavement Markings depending upon the traffic pattern changes as noted in the Specifications. There is also a separate pay item for Removable Pavement Markings (Item #102-91-1 for skip and 102-91-2 for solid) that can be used in addition to the Non-Removable Pavement Marking Pay Item at the designers option. If both non-removable and removable pavement markings are anticipated, then both pay items should be included in the plans. This will make contract administration and enforcement much easier for construction personnel.

The designer should also consider using a miscellaneous asphalt pavement pay item for covering unneeded markings, especially in areas such as detours or crossovers.

10.13 Safety Appurtenances for Work Zones

10 13 1 Traffic Barriers

Work zone traffic barriers are designed either as permanent barriers or as temporary barriers that can be easily relocated. They have four specific functions: to protect traffic from entering work areas, such as excavations or material storage sites, to provide positive protection for workers, to separate two-way traffic, and to protect construction such as false work for bridges and other exposed objects. The designer should anticipate when and where barriers will be needed and include this information and the quantities on the plans.

10 13 2 Portable Concrete Safety Shape (Temporary Barrier Walls)

Portable concrete safety shape barriers, also known as portable concrete barriers (PCB's), are widely used in work zones to protect motorists as well as workers. However, improper use of these barriers can provide a "false sense of security" for both the motorist and the worker. Therefore, care must be taken in their design, installation and maintenance. Installation instructions and flare rates are given in Standard Index 415.

To perform properly and redirect vehicles, the PCB system must be capable of withstanding severe impacts. The PCB's weakest point is its connector which includes the physical connection and mating faces of adjoining barriers or guardrail. |

Acceptable connections are noted on Standard Index 415.

The designer should show or note the location of all temporary barrier wall in the plans. The plans should also include a work area access plan for those projects with median work which is shielded with barrier wall. |

10 13.3 End Treatments

The desirable treatments for exposed ends of barriers are

- connecting to an existing barrier (smooth, structural connections are required - Refer to Index 410 and 415) or
- attaching a crashworthy terminal such as a crash cushion or
- flaring away to the edge of the clear zone (See Chap. 6)

10 13 4 Modifications of Existing Barriers

When 2-way traffic is placed on a facility that is normally one-way, the existing permanent or temporary barriers will be modified as necessary to ensure their proper crashworthiness during the temporary situation. This will include eliminating non-crashworthy end-treatments, snag points or other protrusions normally angled away or hidden from approaching vehicles

10.13 5 Crash Cushions

Crash cushions in work zones may be used in the same manner as at permanent highway installations. Crash cushions are used to protect the motorists from the exposed ends of barriers, fixed objects and other hazards within the clear zone. Two types of stationary crash cushions are commonly used, the sand filled plastic barrel (Index 415) system, and the GREAT CZ system. Selection of a system should be the result of an analysis of site condition (i.e. space and need), first cost and replacement cost after hits. The GREAT system is designed to shield a hazard and redirect vehicles, whereas sand barrels only provide hazard shielding. Therefore, the designer must determine what is needed in order to provide the appropriate device. The designer should anticipate the need for these devices and provide appropriate quantities on the plans. The AASHTO Roadside Design Guide can be consulted for more information.

10 13 6 Truck-Mounted Attenuator (TMA)

In many short-term, mobile and moving work zones, trucks can be used as blocking vehicles to protect workers. Large trucks are effective in preventing vehicle encroachment into the work site, however, serious injury to occupants of the impacting vehicle and truck can result.

Crash cushions called truck-mounted attenuator (TMA) can be attached to the rear of these protective vehicles to reduce the severity of rear-end crashes. TMA may either be trailer or truck-mounted. If the designer sees the need for TMAs for a particular work zone activity, it should be noted on the plans and included in the pay items.

TMAs are used for three classes of protective vehicles in work zones:

1. Shadow Vehicle a moving truck spaced a short distance from a moving operation, giving physical protection to workers from traffic approaching from the rear.
2. Barrier Vehicle a truck parked upstream from a stationary operation and usually unoccupied.
3. Advance Warning Truck a truck parked a considerable distance upstream of a moving or stationary operation displaying an arrow panel and other signs as appropriate.

Shadow trucks and barrier vehicles may be equipped with a TMA. Advance sign trucks should use TMAs if they encroach on the traveled way. Protective vehicles usually are equipped with arrow panels, variable message signs or flashing amber lights.

A truck with a TMA must be positioned properly with respect to the work. If the TMA is too close to the work when hit, it may strike the worker, if too far back, traffic may go around it and hit the workers. The manufacturer's recommendations should be followed for deployment and use. A "rule of thumb" for spacing is less than 2 times the speed limit in feet (e g., 2 X 55 mph = 110 ft.) and at least 30 feet.

10.14 Flaggers

10.14.1 General

Flaggers shall be used only when other traffic control devices cannot adequately ensure safe and smooth traffic operations. Alternate devices such as temporary signals should be considered. Appropriate advanced warning signs shall be used in conformance with the MUTCD, and shall be removed when flaggers are not in use.

10.14.2 Location of Flaggers

Location of flaggers for known flagging operations shall be shown on the TCP, along with all notes necessary to fully explain conditions and requirements for their use. Refer to the MUTCD for further information on flagging.

10.14.3 Police Agencies

Police agencies (FHP, Sheriffs, or City Police) should be contacted for assistance in speed enforcement in work zones. Police escorts can also be used to assist dump trucks and other construction equipment in re-entering the traffic stream on high speed congested facilities. The designer should use plan notes or specifications to state which operations/ phases are anticipated as needing police assistance.

10.15 Layouts

Roadway Standard Index 601 through 650 are layouts of work zone traffic control for typical conditions. These indexes should be referenced only if project conditions are nearly the same as the typical layout. Otherwise, specific plan sheets or details must be prepared. Some conditions that will require specific plan sheets include

- Work not covered by a typical layout.
- Nighttime work requiring special lighting, oversized or additional devices
- Ramps and intersections that interrupt the standard layout.
- Sight distance restrictions such as horizontal or vertical curves.
- Lane or shoulder configurations that do not match the standards.
- Special considerations during installation, intermediate traffic shifts and removal.
- Complex projects, including add-lane projects, that involve many phases, traffic shifts, entrances and exits

When designing layouts, the following shall be considered

10.15.1 Taper Lengths

Minimum taper lengths shall be calculated by the following formulas

- o $L = S \times W$ for speeds of 45 MPH or more
- o $L = W \times S^2/60$ for speeds of 40 MPH or less

Where "L" is the length of the taper, "W" is the width of the closed lane and "S" is the posted regulatory speed for the work zone, in MPH. Both L and W are measured in feet

The following table (taken from MUTCD 6C-2) gives the formulas for the lengths of the various taper types

Table 10 15 1
Taper Length Criteria for Work Zones

<u>Type of Taper</u>	<u>Taper Length</u>
UPSTREAM TAPERS	
Merging Taper	L Minimum
Shifting Taper	1/2 L Minimum
Shoulder Taper	1/3 L Minimum
Two-way Traffic Taper	100 feet Maximum
DOWNSTREAM TAPERS	
(use is optional)	100 feet per lane

10 15.2 Intersecting Road Signing and Signals

Signing for the control of traffic entering and leaving work zones by way of intersecting highways, roads and streets shall be adequate to make drivers aware of work zone conditions. Under no condition will intersecting leg signing be less than a "ROAD CONSTRUCTION AHEAD" sign for approaching vehicles and a "END CONSTRUCTION" sign for departure vehicles unless the intersecting street consists of a shell, sand, or dirt surface, in which case it shall be left to the discretion of the engineer as to the need for this type signing. The designer should remember to include these signs in the estimated quantity for Construction warning signs

Existing traffic signal operations that require modification in order to carry out work zone traffic control shall be as approved by the District Traffic Operations Engineer. If lane shifts occur, signal heads may have to be adjusted to maintain proper position. The DTOE should also determine the need for temporary loops for traffic actuated signals. The TCP should include all necessary signal adjustments.

10.15.3 Sight Distance To Delineation Devices

Merging (lane closure) tapers should be obvious to drivers. If restricted sight distance is a problem (e.g., a sharp vertical or horizontal curve approaching the closed lane), the taper should begin well in advance of the view obstruction. The beginning of tapers should not be hidden behind curves.

10.15.4 Pedestrians and Bicyclists

When pedestrians and/or bicyclists are accommodated on the existing facility (mainline or sidestreet), provisions must be included in the TCP to accommodate them during construction. Pedestrian accommodations through the work zone must include provisions for the handicapped.

10.15.5 Superelevation

Horizontal curves constructed in conjunction with temporary work zone detours, transitions, and crossovers should have the required superelevation. Under conditions where superelevation is not used, the minimum radii that can be applied are listed in the Table 10.15.2. Superelevation must be included with the design whenever the minimum radii cannot be achieved.

TABLE 10.15.2

**MINIMUM RADII FOR
NORMAL CROSS SLOPES**

<u>SPEED (MPH)</u>	<u>MINIMUM RADIUS (FEET)*</u>
45	1080
40	830
35	620
30	450

* At higher speeds (>45 mph) use a 20:1 taper rate. The designer may also choose to use the 20:1 taper rate for speeds ≤45 mph.

10 15.6 Lane Widths

Existing lane widths of through roadways should be maintained through work zone travel ways wherever practical. The minimum widths for work zone travel lanes shall be 10' for all roadways other than Interstate. On Interstate highways the minimum width for work zone travel lanes shall be 11' except at least one 12' lane in each direction shall be provided.

10 15 7 Lane Closure Analysis

The lane closure analysis is a process used by designers to calculate the peak hour traffic volume and the restricted capacity for open road and signalized intersections. The analysis will determine if a lane closure should or should not be allowed and the time of day or night a lane closure could occur without excessive travel delay.

Exhibit I-10-A includes the Lane Closure Analysis Worksheets and two sample analyses. The Sample Lane Closure Worksheet (EX-I-10-A, sheet 3 of 11) has been cross-referenced to the Lane Closure Symbols and Definitions Sheet (EX-I-10-A, sheets 1 & 2 of 11) with circled numbers. The circled numbers correspond to the numbers of the symbols and definitions. The symbols and definition sheet shows the designer where to find the necessary information to fill out the Lane Closure Worksheet.

Fill out the top part of the Lane Closure Worksheet and complete the formulas to calculate the hourly percentage of traffic at which a lane closure will be permitted. Transfer these percentages to the graph on the Lane Closure 24 Hour Counts Sheet (EX-I-10-A, sheet 5 of 11). Draw a line across the graph representing the percentage for both open road and signalized intersections (see example EX-I-10-A, sheet 7 of 11). Plot the hourly percentages (hourly volume divided by total volume) on the graph. Any hourly percentage extending above the restricted capacity percentage lines for open road or signalized intersections indicated lane closure problems. The bottom of the graph gives times for AM and PM. By coordinating the lane closure problem areas to the time of day, a designer knows when to restrict lane closure.

| Many of Florida's roadways have directional peak hour traffic volumes,
| with inbound morning traffic and outbound afternoon traffic. Doing a
| composite lane closure analysis would in many cases require night work.
| However, if a separate lane closure analysis is calculated for inbound and
| outbound separately, a lane closure may be allowed and the contractor
| could work in daylight hours. (See example EX-I-10-A, sheet 10 of 11
| and EX-I-10-A, sheet 11 of 11.)

LANE CLOSURES

Symbols and Definitions

- 1 ATC = Actual Traffic Counts Use current traffic counts Traffic counts can be obtained from the Office of Planning, or you may need to get traffic counts done The designer needs hourly traffic volumes with a total traffic volume for a 24 hour period (see example EX-I-10-A, sheet 7 of 11)
- 2 P/D = Peak Traffic to Daily Traffic Ratio Highest hourly volume divided by the total twenty four hour volume Convert the percentage to a decimal on the Lane Closure Worksheet (see example EX-I-10-A, sheet 7 of 11)
- 3 D = Directional Distribution of peak hour traffic on multi-laned roads This factor does not apply to a two lane roadway converted to two way, one lane The directional distribution can be obtained from the Office of Planning
- 4 PMF = Peak Month Factor Many counties in Florida have a significant variance in monthly traffic volumes and since the actual date of a lane closure would be difficult to estimate, the designer should use the highest monthly factor divided by the factor for the month the counts were actually taken in calculating the volume on the Lane Closure Worksheet The Office of Planning has tables showing monthly traffic factors for every county in Florida (see sample table on EX-I-10-A, sheet 4 of 11)
- 5 RTF = Remaining Traffic Factor is the percentage of traffic that will not be diverted onto other facilities during a lane closure. Convert the percentage to a decimal on the Lane Closure Worksheet This is an estimate that the designer must make on his own, or with help from the Office of Planning Range 0% for all traffic diverted to 100% for none diverted
- 6 G/C = Ratio of Green to Cycle Time This factor is to be applied when lane closure is through or within six hundred feet of a signalized intersection The Office of Traffic Engineering has timing cycles for all traffic signals
- 7 V = Peak Hour Traffic Volume The designer calculates the peak hour traffic volume by multiplying the actual traffic count, times peak to daily traffic ratio, times directional factor, times peak month factor, times remaining traffic factor This calculation will give the designer the expected traffic volume of a roadway at the anticipated time of a lane closure

EX-I-10-A
Sheet 1 of 11

LANE CLOSURES

Symbols and Definitions

8. C = Capacity of a 2L, 4L or 6L roadway with one lane closed, and the remaining lane(s) unrestricted by lateral obstructions. The capacity of a 4L or 6L roadway is based on lane closure in only one direction (see Lane Closure Capacity Table on EX-I-10-A, sheet 3 of 11).
9. RC = Restricting Capacity of the above facilities by site specific limitations detailed in the MOT plans which apply to travel lane width, lateral clearance and the work zone factor. The work zone factor only applies to two lane roadways (see the tables on EX-I-10-A, sheet 4 of 11 to obtain the Obstruction Factor and Work Zone Factor).
10. OF = Obstruction Factor which reduces the capacity of the remaining travel lane(s) by restricting one or both of the following components: Travel lane width less than 12 feet and lateral clearance less than six feet (see MOT plans and Obstruction Factor Table in EX-I-10-A, sheet 4 of 11).
11. WZF = Work Zone Factor is directly proportional to the work zone length. The capacity is reduced by restricting traffic movement to a single lane while opposing traffic queues. The WZF and WZL only apply to a two lane roadway converted to two way, one lane (see the Work Zone Factor Table on EX-I-10-A, sheet 4 of 11).
12. TLW = Travel Lane Width is used to determine the obstruction factor (see MOT plans and the Obstruction Factor Table on EX-I-10-A, sheet 4 of 11).
13. LC = Lateral Clearance is the distance, in feet, from the edge of the travel lane to the obstruction. The lateral clearance is used to determine the obstruction factor (see MOT plans and Obstruction Factor Table on EX-I-10-A, sheet 4 of 11).

EX-I-10-A
Sheet 2 of 11

LANE CLOSURES

CAPACITY ADJUSTMENT FACTORS

PMF SAMPLE

Tropic County Monthly Factors			
January	1 12	July	0 88
February	1 20	August	0 85
March	1 18	September	0 88
April	1 12	October	0 94
May	1 05	November	1 00
June	0 95	December	1 06

NOTE
 February is the peak month in Tropic County-therefore the PMF in the 2L and 4L samples is $1.20 \div 1.00$
 The counts were taken in November

OBSTRUCTION FACTORS (OF)

Lateral Clearance (LC)	Travel Lane Width (TLW)			
	12'	11'	10'	9'
≥6'	1 00	0 96	0 90	0 80
4'	0 98	0 94	0 87	0 77
2'	0 94	0 90	0 83	0 72
0'	0 86	0 82	0 75	0 65

WORK ZONE FACTORS (WZF)

WZL	WZF	WZL	WZF	WZL	WZF
200'	0 98	2200'	0 81	4200'	0 64
400'	0 97	2400'	0 80	4400'	0 63
600'	0 95	2600'	0 78	4600'	0 61
800'	0 93	2800'	0 76	4800'	0 59
1000'	0 92	3000'	0 74	5000'	0 57
1200'	0 90	3200'	0 73	5200'	0 56
1400'	0 88	3400'	0 71	5400'	0 54
1600'	0 86	3600'	0 69	5600'	0 52
1800'	0 85	3800'	0 68	5800'	0 51
2000'	0 83	4000'	0 66	6000'	0 50

Work Zone Length (WZL) for 2 Lane Roadways =
 Distance between opposing traffic queues

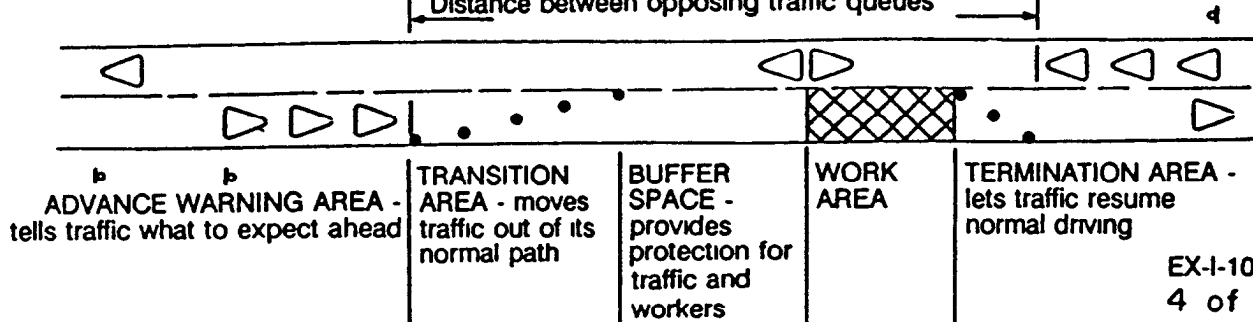

LANE CLOSURES

24 HR COUNTS

TIME	AM HOURLY VOLUME	ATC %	PM HOURLY VOLUME	ATC %
12 - 1	_____	_____	_____	_____
1 - 2	_____	_____	_____	_____
2 - 3	_____	_____	_____	_____
3 - 4	_____	_____	_____	_____
4 - 5	_____	_____	_____	_____
5 - 6	_____	_____	_____	_____
6 - 7	_____	_____	_____	_____
7 - 8	_____	_____	_____	_____
8 - 9	_____	_____	_____	_____
9 - 10	_____	_____	_____	_____
10 - 11	_____	_____	_____	_____
11 - 12	_____	_____	_____	_____
		TOTAL		

DATE _____

DESIGNER _____

PROJECT NO _____

LOCATION _____

HOURLY VARIATION OF DAILY TRAFFIC

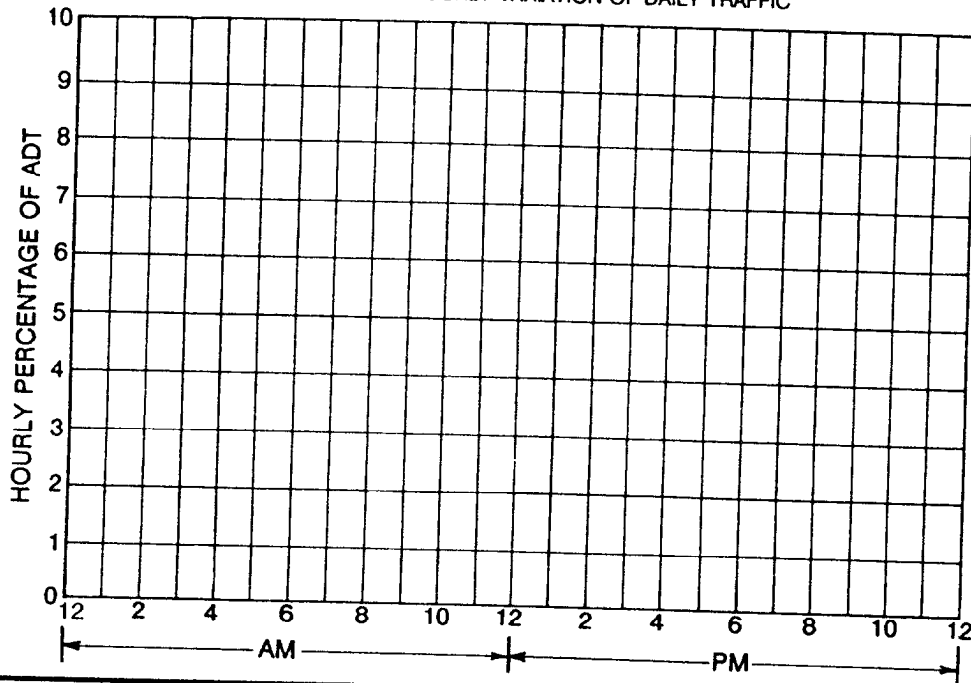

— CONCLUSIONS —

Round to the nearest
1/2 hour conservatively

OPEN ROAD LANE
CLOSURE

SIGNALIZED LANE
CLOSURE

EX-I-10-A
5 of 11

LANE CLOSURE WORKSHEET

STATE PROJECT NO. 12345-6789 FAP NO. NA

WPI NO. 1234567 COUNTY TROPIC DESIGNER YATES

NO. EXISTING LANES 2 SCOPE OF WORK WIDEN & RESURFACE

Calculate the peak hour traffic volume (V)

$$V = ATC \underline{15,000} \times P/D \underline{0.083} \times D \underline{4/A} \times PMF \underline{1.20} \times RTF \underline{0.75} = \underline{1120}$$

LANE CLOSURE CAPACITY TABLE

Capacity(C) of an Existing 2 Lane-Converted to 2 Way, 1 Lane = 1400VPH

Capacity(C) of an Existing 4 Lane-Converted to 1 Way, 1 Lane = 1800VPH

Capacity(C) of an Existing 6 Lane-Converted to 1 Way, 2 Lane = 3600VPH

Factors restricting Capacity

TLW 10' LC 4' WZL 2100' G/C 0.64

Calculate the Restricted Capacity (RC) at the Lane Closure Site by multiplying the appropriate 2L, 4L, or 6L Capacity (C) from the Table above by the Obstruction Factor (OF) and the Work Zone Factor (WZF) If the Lane Closure is through or within 600' of a signalized intersection, multiply the RC by the G/C Ratio

$$RC \text{ (Open Road)} = C \underline{1400} \times OF \underline{0.87} \times WZF \underline{0.82} = \underline{999}$$

$$RC \text{ (Signalized)} = RC \text{ (Open Road)} \underline{999} \times G/C \underline{0.64} = \underline{639}$$

If $V \leq RC$, there is no restriction on Lane Closure

If $V > RC$, calculate the hourly percentage of ADT at which Lane Closure will be permitted

$$\% = \frac{RC \text{ (Open Road)} \underline{999}}{ATC \underline{15,000} \times D \underline{1.00} \times PMF \underline{1.20} \times RTF \underline{0.75}} = \underline{7.40\%}$$

$$\text{Signalized \%} = \text{Open Road \%} \underline{7.40} \times G/C \underline{0.64} = \underline{4.74\%}$$

Plot 24 hour traffic to determine when Lane Closure permitted (See EX-I-10-A, Sheet 5 of 11)

NOTE For Existing 2 Lane Roadways, D = 1 00

Work Zone Factor (WZF) applies only to 2 Lane Roadways

For RTF < 1 00, briefly describe alternate route 25% of

existing traffic diverted on Ballard Blvd. North on Newhall Ave, then East on Sanders X-way

LANE CLOSURES

24 HR COUNTS
Taken in Nov

TIME	AM		PM		P/D
	HOURLY VOLUME	ATC %	HOURLY VOLUME	ATC %	
12 - 1	160	1.1	960	6.4	
1 - 2	90	0.6	830	5.5	
2 - 3	30	0.2	810	5.4	
3 - 4	25	0.2	1080	7.2	
4 - 5	30	0.2	1190	7.9	.083
5 - 6	130	0.9	1240	8.3	
6 - 7	525	3.5	930	6.2	
7 - 8	1135	7.6	680	4.5	
8 - 9	910	6.1	530	3.5	
9 - 10	870	5.8	425	2.8	
10 - 11	825	5.5	365	2.4	
11 - 12	960	6.4	270	1.8	
	TOTAL		15,000	100	

DATE
Dec. 1988

DESIGNER:
YATES

PROJECT NO
12345-6789

LOCATION
Buck Lake Rd.

HOURLY VARIATION OF DAILY TRAFFIC

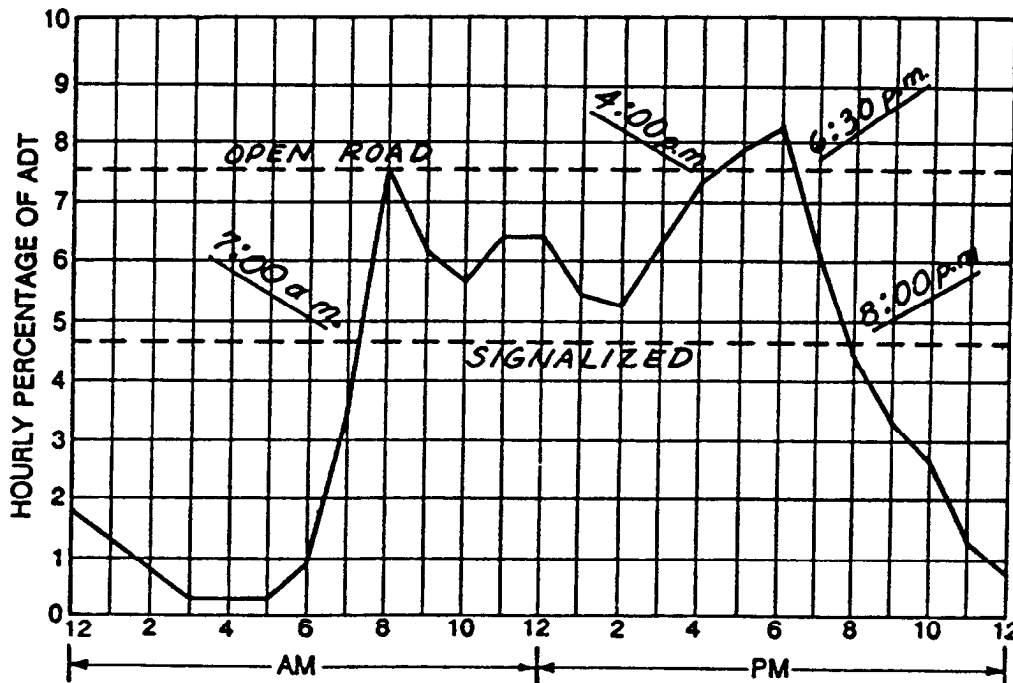

— CONCLUSIONS —
 7.40 Round to the nearest 1/4 hour conservatively
 4.74 OPEN ROAD LANE CLOSURE RESTRICTION 4 00 PM - 6 30 PM.
 SIGNALIZED LANE CLOSURE RESTRICTION 7 00 AM - 8 00 PM

LANE CLOSURE WORKSHEET

STATE PROJECT NO.: 12345-6789 FAP NO.: NA

WPI NO.: 1234567 COUNTY: TROPIC DESIGNER: GIDDENS

NO. EXISTING LANES: 4 SCOPE OF WORK: RESURFACE

Calculate the peak hour traffic volume (V)

$$V = ATC \underline{30,000} \times P/D \underline{0.083} \times D \underline{0.55} \times PMF \underline{1.20} \times RTF \underline{1.00} = \underline{1643}$$

LANE CLOSURE CAPACITY TABLE

Capacity(C) of an Existing 2 Lane-Converted to 2 Way, 1 Lane = 1400VPH

Capacity(C) of an Existing 4 Lane-Converted to 1 Way, 1 Lane = 1800VPH

Capacity(C) of an Existing 6 Lane-Converted to 1 Way, 2 Lane = 3600VPH

Factors restricting Capacity:

TLW 11' LC 6' WZL NA for 4L G/C 0.74

Calculate the Restricted Capacity (RC) at the Lane Closure Site by multiplying the appropriate 2L, 4L, or 6L Capacity (C) from the Table above by the Obstruction Factor (OF) and the Work Zone Factor (WZF). If the Lane Closure is through or within 600' of a signalized intersection, multiply the RC by the G/C Ratio

$$RC \text{ (Open Road)} = C \underline{1800} \times OF \underline{0.96} \times WZF \underline{1.00} = \underline{1728}$$

$$RC \text{ (Signalized)} = RC \text{ (Open Road)} \underline{1728} \times G/C \underline{0.74} = \underline{1279}$$

If $V \leq RC$, there is no restriction on Lane Closure

If $V > RC$, calculate the hourly percentage of ADT at which Lane Closure will be permitted

$$\% = \frac{RC \text{ (Open Road)} \underline{1728}}{ATC \underline{30,000} \times D \underline{0.55} \times PMF \underline{1.20} \times RTF \underline{1.00}} = \underline{8.73\%}$$

$$\text{Signalized \%} = \text{Open Road \%} \underline{8.73} \times G/C \underline{0.74} = \underline{6.46\%}$$

Plot 24 hour traffic to determine when Lane Closure permitted (See EX-I-10-A, Sheet 5 of 11)

NOTE: For Existing 2 Lane Roadways, D = 1.00.

Work Zone Factor (WZF) applies only to 2 Lane Roadways.

For RTF < 1.00, briefly describe alternate route: NA

LANE CLOSURES

24 HR COUNTS
Taken in Nov

TIME	AM		PM	
	HOURLY VOLUME	ATC %	HOURLY VOLUME	ATC %
12-1	<u>320</u>	<u>1.1</u>	<u>1920</u>	<u>6.4</u>
1-2	<u>180</u>	<u>0.6</u>	<u>1660</u>	<u>5.5</u>
2-3	<u>60</u>	<u>0.2</u>	<u>1620</u>	<u>5.4</u>
3-4	<u>50</u>	<u>0.2</u>	<u>2160</u>	<u>7.2</u>
4-5	<u>60</u>	<u>0.2</u>	<u>2380</u>	<u>7.9</u>
5-6	<u>260</u>	<u>0.9</u>	<u>2480</u>	<u>8.3</u>
6-7	<u>1050</u>	<u>3.5</u>	<u>1860</u>	<u>6.2</u>
7-8	<u>2270</u>	<u>7.6</u>	<u>1360</u>	<u>4.5</u>
8-9	<u>1820</u>	<u>6.1</u>	<u>1060</u>	<u>3.5</u>
9-10	<u>1740</u>	<u>5.8</u>	<u>850</u>	<u>2.8</u>
10-11	<u>1650</u>	<u>5.5</u>	<u>730</u>	<u>2.4</u>
11-12	<u>1920</u>	<u>6.4</u>	<u>540</u>	<u>1.8</u>
	TOTAL		<u>30,000</u>	<u>100.0</u>

DATE
Dec. 1988

DESIGNER
GIDDENS

PROJECT NO
12345-6789

LOCATION
BUCK LAKE RP.
STA 100 - STA 200

HOURLY VARIATION OF DAILY TRAFFIC

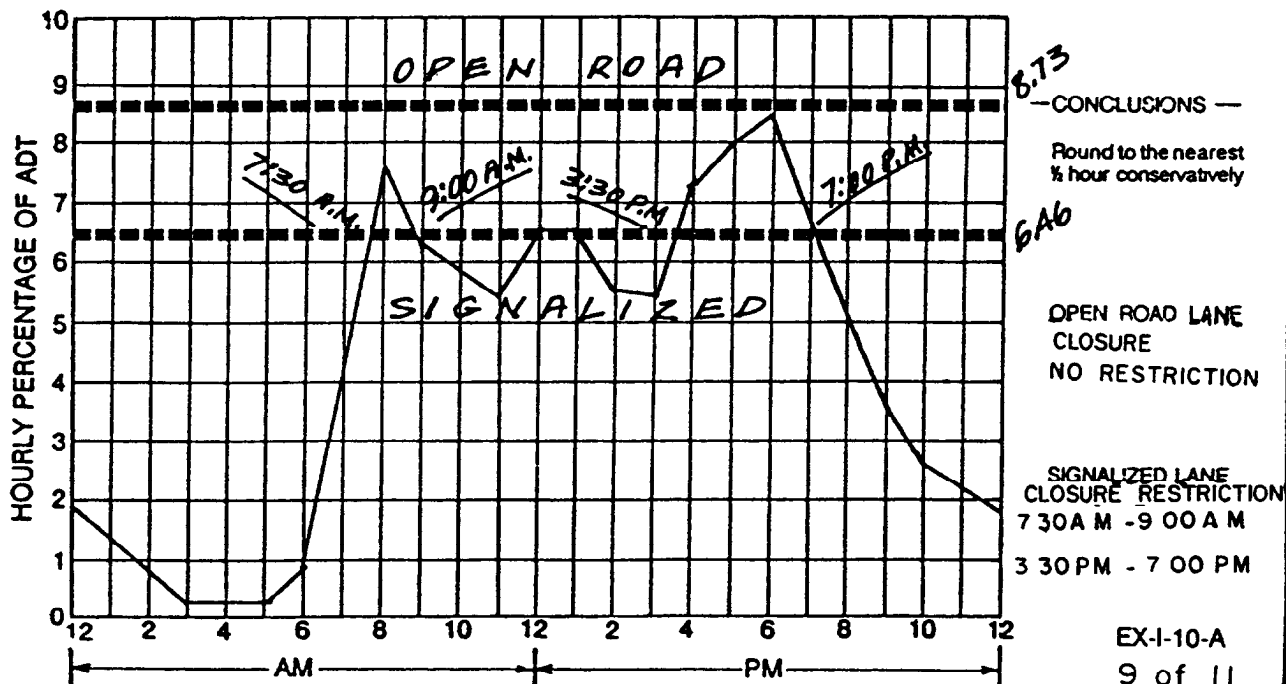

SAMPLE 4-LANE SITE = SR 60 @ US 301 EAST OF TAMPA - HILLSBOROUGH CO

INBOUND LANE CLOSURES

24 HR COUNTS

TIME	AM HOURLY VOLUME	ATC %	PM HOURLY VOLUME	ATC %
12 1	146	0.7	1437	6.6
1 2	88	0.4	1387	6.4
2 3	99	0.5	1357	6.2
3 4	94	0.4	1358	6.2
4 5	158	0.7	1261	5.8
5 6	392	1.8	1188	5.5
6 7	1377	6.3	998	4.6
7 8	2235	10.3	901	4.1
8 9	1602	7.4	594	2.7
9 10	1339	6.2	518	2.4
10 11	1276	5.9	380	1.7
11 12	1316	6.0	259	1.2
TOTAL			21,760	100.0

COMPOSITE LANE CLOSURES

24 HR COUNTS

TIME	AM HOURLY VOLUME	ATC %	PM HOURLY VOLUME	ATC %
12 1	444	1.1	2836	6.7
1 2	232	0.5	2594	6.1
2 3	195	0.5	2644	6.3
3 4	245	0.6	2823	6.7
4 5	294	0.7	3066	7.3
5 6	599	1.4	3080	7.3
6 7	1895	4.5	2362	5.6
7 8	3070	7.3	1775	4.2
8 9	2552	6.1	1291	3.0
9 10	2403	5.7	1212	2.8
10 11	2367	5.6	890	2.1
11 12	2694	6.4	662	1.5
TOTAL			42,232	100.0

OUTBOUND LANE CLOSURES

24 HR COUNTS

TIME	AM HOURLY VOLUME	ATC %	PM HOURLY VOLUME	ATC %
12 1	298	1.5	1399	6.8
1 2	144	0.7	1207	5.9
2 3	96	0.5	1287	6.3
3 4	151	0.7	1465	7.2
4 5	136	0.7	1805	8.8
5 6	207	1.0	1892	9.2
6 7	518	2.5	1364	6.7
7 8	835	4.1	874	4.3
8 9	957	4.7	697	3.4
9 10	1064	5.2	694	3.4
10 11	1091	5.3	510	2.5
11 12	1378	6.7	403	2.0
TOTAL			20,472	100.0

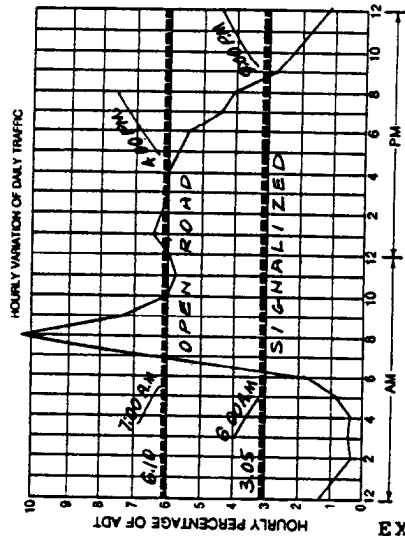

HOUR OF DAY

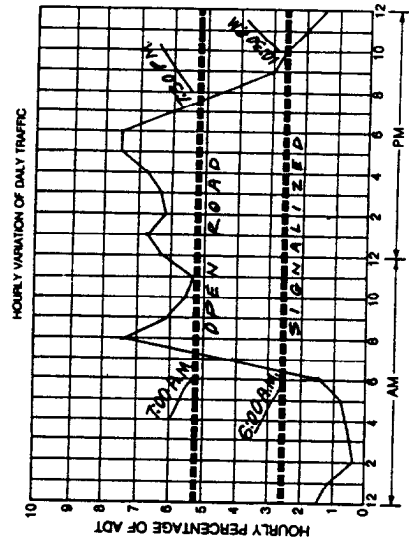

HOUR OF DAY

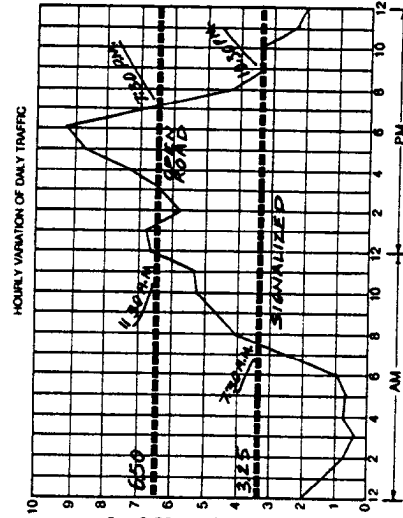

HOUR OF DAY

LANE CLOSURE WORKSHEET SUMMARY

LANE SAMPLE WITH SIGNIFICANT AM-PM PEAKS

SAMPLES = INBOUND (WB), COMPOSITE (EB & WB), OUTBOUND (EB)

SITE = SR 60 @ US 301 EAST OF TAMPA, HILLSBOROUGH CO

COMPONENT	INBOUND	COMPOSITE	OUTBOUND
ADT	21,760	42,232	20,472
P/D	0.103	0.073	0.092
D	1.00	0.60	1.00
PMF	1.17	1.17	1.17
RTF	1.00	1.00	1.00
V	2622	2164	2203
TLW	12'	12'	12'
LC	0'	0'	0'
C	1800	1800	1800
OF	0.86	0.86	0.86
RC(OPEN ROAD)	1548	1548	1548
G/C	0.50	0.50	0.50
RC(SIGNAL)	774	774	774
% OPEN ROAD	6.10	5.20	6.50
% SIGNAL	3.05	2.60	3.25
LANE CLOSURE (OPEN ROAD)	7:00 A.M. - 4:00 P.M.	7:00 A.M. - 7:30 P.M.	11:30 A.M. - 7:30 P.M.
LANE CLOSURE (SIGNAL)	6:00 A.M. - 9:00 P.M.	6:00 A.M. - 10:30 P.M.	7:30 A.M. - 10:30 P.M.

CONCLUSIONS

10.15.8 Detours

A detour is a deviation from the normal roadway and is initiated when traffic is directed to leave the roadway. Activities such as traffic shifting and/or splitting accomplished within the confines of the roadway do not involve detours, but a crossover involves a detour because traffic is directed to depart the directional roadway.

| There are two types of detours on-site and off-site. An on-site detour
| is generally defined as a shift in the traffic of one lane or more. At an on-
| site detour traffic is diverted onto a temporary roadway generally
| constructed within or adjacent to the right-of-way or onto a frontage
| road. At an off-site detour traffic is diverted onto another highway in
| order to bypass the work zone.

For off-site detours, the detour signing is usually done under the direction of the traffic engineer who has authority over the roadway. The detour should be signed clearly so drivers can traverse the entire detour and return to the original roadway. Detour signing is not required for minor shifts from the direct or regular route. There will be situations that are between minor shifts and re-routing. In these cases engineering judgement must be applied to ensure that traffic is given clear and adequate direction. When shifts and detours are required the designer should analyze the effects of the action on the capacity of the roadway and take the necessary steps to minimize adverse impacts. The structural capacity of the shoulder or detour pavement should also be considered and additional structure provided if necessary.

| The designer has two methods of paying for detours by (1) using the
| "special detour" lump sum pay item or (2) using the lump sum Mot pay
| item. When the special detour pay item is used, the work and quantities
| included for pay under the item are to be tabulated and noted in the
| plans. The special detour pay item is intended to be used in all situations
| where traffic is shifted one lane width or more onto temporary pavement.

All work and materials necessary to construct temporary pavement widening for shifts less than one lane width shall be included under lump sum MOT.

Even though shifts may meet the definition of a detour and a "special detour" may be called for contract pay purposes, it may not be appropriate to sign the shift as a detour. Signing should match the perceptions and desired responses of the driving public as per the MUTCD rather than administrative definitions.

TCPs should include sufficient detail for detour geometry. Detours should be designed with shoulders (2' min) whenever practical. The radius of curvature and taper lengths should be shown. Detours should be designed and operated as close to the normal speed as possible. When speed reductions are necessary, the reduction should be in 10 mph increments. The recommended minimum radius of curvature (without superelevation) for detours is shown in Table 10.15.2.

10.15.9 Above Ground Hazards

An above ground hazard is any object, material, or equipment, which does not meet the Department's safety criteria for clear zones - i.e., anything that is greater than 4 inches in height and is firm and unyielding or doesn't meet breakaway requirements.

Construction hazards located within the travel way or from the outside edge of pavement through the clear zone for the highway are to be considered work areas and treated as required by the appropriate warning devices during the contractor's work hours or eliminate the hazard. During non-working hours, all objects, materials, or equipment that constitutes a hazard, must be stored/placed outside the clear zone or be shielded by a barrier wall.

For above ground hazards within a work zone, the clear zone used should be based on the regulatory speed posted during construction. (See Index 700)

10.15.10 Drop-offs in Work Zones

Acceptable warning and barrier devices for traffic control at drop-offs in work areas are detailed in Standard Index 600

The designer should anticipate dropoffs which are likely to occur during construction and provide the appropriate devices thru pay items and quantities. For those projects where barrier wall would be needed and yet it is not practical - such as highly developed urban areas where numerous driveways exist - the designer should consider adding plan notes which restrict the length of the contractors operations in order to reduce the dropoff at acceptable level, prior to the end of the days operations.

10.15.11 Narrow Bridges

Simultaneously working on both sides of a bridge (bridge widening, etc.) may be hazardous due to the narrow width of some bridges. Consideration should be given to specifying that work be done only on one side at a time, particularly on high speed roadways. In some situations, the installation of barrier wall on both shoulders can totally eliminate any shoulder or refuge area. The designer should consider whether or not this restriction of the effective bridge width is acceptable and consistent with the desired operational ability of the facility

10 15 12 Existing Highway Lighting

If the project has existing roadway lighting, the designer shall prepare a specification that completely describes what is to be done with the existing lighting during all phases of construction. Give detailed information on any poles that have to be relocated or any new conduit or conductors that would have to be installed. A field survey should be conducted to establish the condition of the existing system and what responsibility the contractor will have in bringing the existing lighting system back to an acceptable condition

The designer shall determine what work is to be done and, using the pay items established for roadway lighting shown on Index 17506 of the Roadway and Traffic Design Standards, develop pay items and quantities for all work to be done for maintaining existing lighting throughout construction

10 15 13 Work Area Access

The TCP must also include a work area access plan, if necessary. This is a constructability issue in which the designer addresses the question of how the contractor is to get materials and equipment into the work area safely. This is a particularly critical issue on high speed facilities (such as the Interstate) where barrier wall is used to protect median work areas.

10 15 14 Pay Items and Quantities

The Basis of Estimates Manual has been updated to provide better instructions on calculating many of the MOT quantities.

10.16 Speed Zoning

10.16.1 Regulatory Speeds in Work Zones

The goal of traffic control plans for construction, maintenance, and utility operations is to route traffic through such areas in a manner comparable to normal highway conditions. Changes to the existing posted speed limits should only be made after consideration of actual or anticipated field conditions including vehicular volumes, congestion, TCP phasing, lane restrictions, type of construction, closeness of traffic to workers, equipment, flagger usage, pedestrians, geometrics, and physical conditions. By virtue of F.S. 316.187, all regulatory speeds must be established on the basis of a traffic and engineering investigation. The justification for establishing work zone regulatory speeds different from normal speed limits must be included in the project file.

When developing a TCP, the considerations noted above must be addressed in determining the appropriate regulatory speeds. The TCP and the project file will suffice as the traffic and engineering investigations. TCPs for all projects must show specific regulatory speeds for each phase of work. This can either be the existing posted speed or a reduced speed. The speed shall be noted in the TCP. Guidelines for determining the appropriate speed reduction are given in Table 10.16.1.

If field conditions warrant speed reductions greater than those shown in the Traffic Control Plan (TCP), then the contractor may submit to the project engineer for approval by the Department, a signed and sealed study to justify the need for further reducing the posted speed or the engineer may request the District Traffic Operations Engineer (DTOE) to investigate the need. It will not be necessary for the DTOE to issue regulations for regulatory speeds in work zones due to the revised provisions of F.S. 316.0745(2)(b). However, all other regulatory signs, work zone or permanent, require issuance of a regulation by the DTOE.

Table 10.16.1

REGULATORY SPEED REDUCTIONS
FOR USE IN CONSTRUCTION AND MAINTENANCE OPERATIONS

CONDITIONS	TYPICAL APPLICATIONS	DURATION OF WORK	REDUCTIONS TO EXISTING REGULATORY SPEEDS	SUGGESTED AMOUNT OF SPEED REDUCTION
Activities are more than 15' from the edge of pavement.	Landscaping Work Utility Work Fencing Work Cleaning Drainage Structures Reworking Ditches	Any Time Period	SHOULD NOT BE USED*	N/A
Activities which encroach the area closer than 15' but not closer than 2' to the edge of pavement.	Utility Work Culvert Extensions Side Slope Work Guardrail Maintenance Landscaping Work Cleaning Drainage Structures Reworking Ditches Sign Installation and Maintenance Shoulder Work	One daylight period or less	SHOULD NOT BE USED*	N/A
Activities which encroach the area from the edge of the pavement to 2' from the edge of pavement.	Utility Work Guardrail Maintenance Shoulder Work	One daylight period or less Greater than one daylight period	SHOULD NOT BE USED* MAY BE USED	N/A 10 MPH

NOTE: Regulatory Speed signs shall meet all requirements of the Manual on Uniform Traffic Control Devices (MUTCD).
*Unless drop-offs or other situations create hazardous conditions for motorists, pedestrians or workers.

Table 10.16.1
(Continued)

REGULATORY SPEED REDUCTIONS
FOR USE IN CONSTRUCTION AND MAINTENANCE OPERATIONS

CONDITIONS	TYPICAL APPLICATIONS	DURATION OF WORK	REDUCTIONS TO EXISTING REGULATORY SPEEDS	SUGGESTED AMOUNT OF SPEED REDUCTION
Activities which encroach the area between the centerline and the edge of pavement. (lane closures)	Pavement marking Pavement Resurfacing Pavement Repair Utility Work Bridge Repair Widening	One hour or less Greater than one hour	SHOULD NOT BE USED* MAY BE USED	N/A 10-20 MPH
Activities which require inter-mittent or moving operation on the shoulder.	Shoulder and Slope Utility Work Guardrail Maintenance Landscape Work Delineator Installation Widening	One hour or less Greater than one hour	SHOULD NOT BE USED* SHOULD NOT BE USED*	N/A N/A
Activities requiring a temporary detour to be constructed**	Bridge Construction Subgrade Restoration Culvert Repair Roadway Construction	Any time period	MAY BE USED	10-20 MPH
Activities which encroach the area beyond either the centerline of a roadway or lane line of a multi-lane highway	Pav't Marking Pav't Resurfacing Use of Temporary Barrier Wall Installation of Drainage Laterals	Any time period	MAY BE USED	10-20 MPH

NOTE: Regulatory Speed signs shall meet all requirements of the Manual on Uniform Traffic Control Devices (MUTCD).

*Unless drop-off or other situations create hazardous conditions for motorists, pedestrians or workers
**Detour and transition geometrics which meet the existing regulatory speed should be provided whenever possible.

Regulatory speed signs in rural areas (Interstate and Non-Interstate) are to be preceded by a "REDUCE SPEED AHEAD" sign positioned as follows

Interstate (Rural) - 1000 feet in advance
Non-Interstate (Rural) - 500 feet in advance

All urban areas do not require an advance sign, however, it may be included at the designer's option

The "Regulatory Speed" and "Reduce Speed Ahead" signs are to be paid for under a pay Item, 102-96 Temporary Regulatory Signs per each per day

If the existing regulatory speed is to be used, consideration should be given to supplementing the existing signs when the construction work zone is between existing regulatory speed signs. For projects greater than one mile in length for rural areas (Non-Interstate) and on Rural or Urban Interstate, regulatory signs are to be placed at no more than one mile intervals. For urban situations (Non-Interstate) regulatory speed signs are to be placed at a maximum of 1000 feet apart

The 85 percentile speed used to establish normal regulatory speeds does not apply for construction zones. Changes to the existing speed should be made on actual or anticipated field conditions such as vehicular volumes, congestion, TCP phasing, lane restrictions, type of construction, closeness of traffic to workers, equipment, flagger usage, pedestrians, geometrics and physical conditions. This is interpreted to mean, using engineering judgement, the responsible designer is to establish the regulatory speed and so note in the plans and project file, after considering the above conditions and the degree to which warning devices are required. In general, the regulatory speed should be established to route vehicles safely through the work zone as close to

normal conditions as possible. The regulatory speed should not be reduced more than 20 MPH below the posted speed without the approval of the District Traffic Operations Engineer and the appropriate District Director. (See Index 600.) This reduction is to be done in 10 MPH per 500 foot increments.

To ensure credibility with motorists and enforcement agencies, reductions in the existing posted speed shall be removed as soon as the conditions requiring the reduced speed no longer exist. On longer projects, such as interstate resurfacing, the speed reductions should be located in proximity to the activities which merit a reduced speed and not "blanketed" for the entire project.

When the regulatory speed is changed in a work zone, the permanent speed limit signs are to be removed during the period when the work zone regulatory speed zones are in effect.

Once the work zone regulatory speeds are removed, the regulatory speed existing prior to construction will automatically go back into effect unless a new regulation is issued by the DTOE to revise the previous speed.

10 16 2 Advisory Speeds in Work Zones

Advisory Speed plates should not normally be specified in the plans, unless they are being used merely to reinforce the regulatory speed signs. Advisory Speed plates will be used at the option of the field engineer for temporary use while processing a request to change the regulatory speed specified in the plans when deemed necessary. Advisory speed plates cannot be used alone, but must be placed below the construction warning sign for which the advisory speed is required.

CHAPTER 11

PAY ITEMS, QUANTITIES AND SPECIFICATIONS

11.1 Items and Quantities and Specifications

The Federal-Aid Highway Program Manual (FHPM), Vol. 6, Chap. 4, Sec 1, Subsec. 6 states that federal-aid construction contracts shall provide that the Contractor is to furnish all necessary materials and that the Contractor shall be permitted to select the source from which materials are to be obtained. Exceptions may be made when there is a definite finding by the Department and concurred by the FHWA Division Administrator that it is in the public interest to require use of state furnished material or use of material from a designated source.

Payment for materials used in the construction project is made for each pay item included in the project. Calculations and tabulations that substantiate the quantities for each pay item for both federal-aid and non federal-aid projects, should be considered as part of the plans package. These computations should be on standard forms as described in the Department's Computation Manual. The Basis of Estimates Manual presents the Department's standard method of calculating design quantities for construction pay items. All nonstandard methods used in computing quantities should be clearly and completely documented in the Computation Book by showing calculations and the basis of estimates used. Items calculated using the standard basis of estimate may sometimes require clarification especially if several intermediate computations are necessary to arrive at the total quantity. These computations should also be documented in the Computation Book.

The Department's current practice is to provide for final payment under the plan quantity concept for a large number of commonly used items. Items under this concept require that the estimated quantities be calculated and documented as accurately as possible. Exceptions to this will be allowed for asphalt and base items for resurfacing, widening and intersection improvement projects. These items may be evaluated for payment under final measurement on a project by project basis. Projects for which the Districts desire to have these items paid under final measurement shall include in the plans transmittal package to Tallahassee, a letter to the Engineer of Specifications, listing the specific items desired to be paid by final measurement. The items for which payment may be allowed under final measurement are the pavement and base square yard items. Tonnage items are not included in the plan quantity concept.

Allowing final measurement on these items does not release the designer from calculating the quantities as accurately as possible. Field reviews and design surveys are still required, when necessary, to define or establish scope and/or essential topography. Planimetry of areas from plans for resurfacing and widening is allowed, as long as the scale is such that the area can be calculated as accurately as possible.

For projects that have partial federal-aid, adequate distinction should be clearly made between participating (included in federal aid) and nonparticipating (not included in federal-aid) items. All nonparticipating items or partial quantities should be identified on the plans and on the Summary of Quantities sheet as has been done in the past. The method of presenting this information must be of sufficient detail for project personnel to readily distinguish between participating and nonparticipating work, including its physical location in the project. Project personnel must be able to properly account for the necessary separation of quantities. These separated quantities should also be properly identified as to

participating and nonparticipating work when entered into CES. In a few cases certain lump sum items such as mobilization, maintenance of traffic, etc. may be at least partially Federal Aid nonparticipating depending upon the nature of other nonparticipating items which must be separated. Where it is determined that certain lump sum items should be partially Federal Aid nonparticipating, the percentage assignment of nonparticipating should be negotiated with the FHWA. Upon mutual agreement the summary of quantities should so note the appropriate percentage by footnote to the summary, and describe the area of the project to which this note applies. This percentage should also be reflected when entering data into CES. Where joint project agreements are involved between the Department and the City or County, appropriate participation information regarding this particular phase of the work should be so noted. These items should be determined during early stages of project development. Appropriate final adjustments should be included in the plans package and CES entries appropriately modified, if such items arise during the PS & E phase.

All projects (including resurfacing, widening, traffic operations, safety, etc.) shall utilize the individual pay items as listed in the Master Pay Item List.

Utility contract plans which have a 6000 job number, and are let in the contract as roadway work, need to have special attention given to the establishment of pay items and loading CES. All items of work related to the utility work shall be included in the CES under 6000 project numbers. Lump sum items such as Mobilization and Maintenance of traffic should be loaded for both the roadway work (3000 series project number) and utility work (6000 series project number). Traffic Control Plan (TCP) items that are paid by per each or per each per day (barricades, signs, etc.) are to be included under the 6000 project when the work is clearly done separately from the roadway construction work. If the utility work is done concurrently with the roadway work, individual TCP items are not required under the 6000. However, the TCP Lump Sum item must be included in all cases under both the 3000 and 6000 projects when TCP work is anticipated.

For those projects which have minor joint project agreement work, (such as adjusting manholes, valves, etc), the lump sum items of mobilization and maintenance of traffic do not have to be included under the 6000 series projects

11.2 New Pay Items

New construction material and new uses of existing construction materials require new pay item definitions. The Department has established the following procedure to establish new pay items:

The originator of a new pay item should submit a draft of the pay items specification, any manufacturer's brochures, estimated material and labor cost, a completed 781-25R form (Exhibit I-11-A) and any other relevant data to the central roadway design office. This package will be thoroughly reviewed. Any inquiries arising during the review will be addressed to the originator through the Central office design coordinator. Upon successful completion of review, the package will be forwarded to the specifications office for further review, approval and pay item number assignment, after which it is transmitted to the estimates office for review, approval and entry into the data base system. After the pay item number is entered into the estimates office's database system, the design coordinator will be notified of the approval and copies of the new pay item will be distributed.

11.3 Plan Notes

Plan notes are intended to be used to clarify design detail, construction practices or method for payment. In general, plan notes should be kept to a minimum. Only those notes which are job specific should be used. The standard notes provided in other sections of this manual are considered job specific type notes.

Only those that apply should be included in the plans. As the design process |
changes, these standard notes may also change. Many of the "old" standard notes |
have been eliminated recently and incorporated into the specifications. Notes |
which restate the standard specifications or standard indexes should not be used. |
This will help to place proper emphasis on those notes that are job specific. |

PAY ITEM REQUEST

JOB NO _____ - _____ PAY ITEM NO _____ - _____ - _____ UNIT OF MEASURE _____
FULL ITEM NAME _____

DETAIL PAY ITEM INFORMATION (Attach Additional Sheet if Necessary)

Spec Yr _____ COST DATA _____

ORIGINATOR _____ DISTRICT _____ DATE ___/___/___ PHONE _____

DESIGN COORDINATOR _____ APPROVED ___ DISAPPROVED ___

COORDINATOR _____ DESIGN SECTION _____ DATE ___/___/___ PHONE _____

DESIGN CHECKLIST DATA _____

NEW CHECKLIST ITEM _____

SIGNATURE _____ DATE ___/___/___ PHONE _____

SPECIFICATIONS OFFICE

SPECIFICATION BOOK SPECIAL PROVISIONS APPROVED DISAPPROVED

DEVELOPMENT ATTACHMENT SUPPLEMENTAL SPECIFICATION

SIGNATURE _____ DATE ___/___/___ PHONE _____

ESTIMATES (Engineering Support) _____ APPROVED ___ DISAPPROVED ___

SIGNATURE _____ DATE ___/___/___ PHONE _____

* DISAPPROVAL REASON _____

NOTE ORIGINAL TO BE PROCESSED THROUGH ESTIMATES
COPY TO BE RETAINED BY COORDINATOR AND SPECIFICATIONS

JOB NUMBER

USE CURRENT STATE PROJECT NUMBER FOR WHICH NEW ITEM NUMBER WILL FIRST BE USED

PAGE ITEM NUMBER.

THIS NUMBER WILL BE ASSIGNED BY THE STATE SPECIFICATIONS ENGINEER IN THE CENTRAL OFFICE

UNIT OF MEASURE

A MAXIMUM OF TWO SPACES USED TO ABBREVIATE THE METHOD OF MEASURE FOR THIS ITEM (SEE STANDARD INDEXES FOR STANDARD ABBREVIATIONS)

FULL ITEM NAME.

DESCRIBE THE NEW PAY ITEM SO THAT THIS "NAME" BEST RELATES TO FUTURE USERS WHAT THIS ITEM IS USED FOR

DETAILED PAY ITEM INFORMATION

PROVIDE DRAFT SPECIFICATIONS WHICH FULLY DESCRIBES THE NEW PAY ITEM FORMATTED TO THE CURRENT SPECIFICATION BOOK THE SPECIFICATIONS OFFICE WILL PUT THE DRAFT INTO THE FINAL FORM BUT THEY MUST HAVE THE USERS IDEAS ON THE DESCRIPTION METHOD OF MEASUREMENT, HOW THIS ITEM WILL BE USED AND SUGGESTED METHOD OF PAYMENT

COST DATA

PROVIDE A BREAKDOWN OF THE COST PER UNIT OF MEASUREMENT WITH NUMBER OF SKILLS REQUIRED AND EQUIPMENT SHOULD SUPPLIER OR MANUFACTURER BE KNOWN PLEASE INCLUDE NAME & PHONE

ORIGINATOR SIGNATURE

WHEN THE ORIGINATOR HAS PREPARED THE DRAFT SPECIFICATIONS COST DATA AND ANY OTHER AVAILABLE DATA HE/SHE WILL SIGN THIS FORM SIGNIFYING THEIR APPROVAL OF THE ATTACHED MATERIAL

DISTRICT

THE DISTRICT NUMBER OF THE ORIGINATOR

DATE AND PHONE NUMBER SEE NOTE BELOW

DESIGN COORDINATOR

THE CENTRAL OFFICE DESIGN COORDINATOR WILL RECEIVE THE PAY ITEM PACKAGE REVIEW FOR COMPLETENESS EVALUATE THE REQUEST FOR STATEWIDE UNIFORMITY AND AFTER FINAL APPROVAL DISTRIBUTE PAY ITEM PACKAGE TO DISTRICT DESIGN ENGINEERS, ORIGINATOR AND DISTRICT ESTIMATOR FOR THEIR FUTURE REFERENCE

DESIGN SECTION

THE DESIGN SECTION APPROVING THE USE OF ABOVE PAY ITEM,(EXAMPLE ROADWAY, STRUCTURES BRIDGE REFURB, LIGHTING, ETC) DATE AND PHONE NUMBER SEE NOTE BELOW

CES DESIGN CHECKLIST INFORMATION

THE DESIGN COORDINATOR WILL ASSIGN THE STANDARD STATEMENT NUMBERS APPROPRIATE FOR THIS PARTICULAR ITEM, AND ADD ANY NEW STATEMENTS THAT ARE APPROPRIATE

DESIGN COORDINATOR SIGNATURE

WHEN THE DESIGN COORDINATOR HAS REVIEWED, EVALUATED AND CHOSEN CES CHECKLIST STATEMENTS HE/SHE WILL SIGN THIS FORM SIGNIFYING THEIR APPROVAL OF THE ATTACHED MATERIAL

SPECIFICATIONS

SPECIFICATIONS OFFICE WILL REVIEW AND EVALUATE REQUEST AND DESIGNATE SECTION LOCATION SECTION LOCATION IS INDICATED BY THE 2ND, 3RD & 4TH DIGIT IN THE FIRST GROUP OF THE PAY ITEM NUMBER

TYPE OF SPECIFICATION

THIS OFFICE WILL ALSO DESIGNATE SPECIFIC LOCATION OF THE REQUEST IN SPECIFICATIONS PACKAGE (SPECIAL PROVISIONS, SUPPLEMENTAL SPECIFICATIONS, ETC)

SIGNATURE

SIGNATURE OF THE AUTHORIZED PERSON IN SPECIFICATIONS OFFICE

DATE AND PHONE NUMBER SEE NOTE BELOW

ENGINEERING SUPPORT

SIGNATURE

SIGNATURE OF AUTHORIZED PERSON FOR ESTIMATES ENGINEERING SUPPORT OFFICE

DATE AND PHONE NUMBER. SEE NOTE BELOW

NOTE

DATE IS THE MONTH, DAY AND YEAR REQUEST IS LEAVING THAT OFFICE, PHONE NUMBER - THE PHONE NUMBER OF THE AUTHORIZED PERSON TO CONTACT IF ADDITIONAL INFORMATION SHOULD BE REQUIRED

Chapter 12

RIGHT-OF-WAY

12.1 General

Right-of-way requirements must be carefully checked during the design process. Roadway cross sections should be reviewed to determine if the limits of construction lie outside the established right-of-way, additional right-of-way must be requested, or cut and fill slopes must be revised so that all proposed construction will be within the right-of-way. Retaining walls may be necessary to avoid damaging key parcel remainders.

Close cooperation and coordination of activities is to be maintained with the Right-of-way Office in the selection of corridors for location of the improvement and establishment of reasonable right-of-way limits based on property ownerships, economics, alignment, grades, land use, typical sections, etc. As the preliminary layout progresses, the District Right-of-way Surveyor should be coordinated with, on-site reviews held, and rough appraisals obtained where necessary in order to assure a reasonable and practical facility that can be economically, aesthetically and operationally justified.

The Right-of-way Office should be involved in the development of the approximate right-of-way requirements as early as possible in the plans preparation stage so that title searches and acquisitions may be initiated on a timely basis.

If the requirements are altered, the Right-of-way Office must be notified immediately in writing. The right-of-way check of completed plans is made by representatives of the Design Office and the Right-of-way Office.

The right-of-way shown on the plans must be in exact agreement with that shown on the right-of-way map. If a connection can be provided outside right-of-way which does not significantly reduce the utility or value of the parcel, then a restoration agreement should be sought by our Right-of-way Department. If the agreement cannot be secured, a wall should be constructed. If a connection outside right-of-way will, in the opinion of the Right-of-way Department, significantly impact the utility or value of the parcel, then a construction easement should be obtained to provide a mechanism or opportunity to compensate the owner for the impacts. Every effort should be made in the latter situation to avoid this impact by adjusting the design since it will add a right-of-way phase to the project and possibly delay the project.

On projects which otherwise require right-of-way, an attempt should be made to obtain the restoration agreement so that a connection can be made. If the owner refuses to grant the restoration agreement, and no other reasonable access is available, and the appraised value and administrative cost to obtain an easement is less than a wall, or if a connection will significantly impact the utility of the property, the construction easement should be acquired.

Lateral ditch cross sections should be examined, and right-of-way requirements for the ditches established. A reasonable distance will be required between top of slope and right-of-way line, on one side at least, if maintenance equipment cannot be operated in the ditch.

After right-of-way requirements are determined, these data are referred to the Right-of-way Office for completion of the right-of-way maps.

Chapter 13

PROJECT DEVELOPMENT

13.1 General

This chapter explains the overall process of highway project development, from the Five Year Work Program to the project letting stage. A brief outline of the scope requirements at the various significant phases of the process will also be discussed.

13.2 Process

13.2.1 Five Year Work Program

The development of a Five Year Work Program begins with the identification of short and long range statewide transportation needs. Planning documents are developed with inputs from Florida DOT, regional planning groups and local governments. Data concerning the condition of existing highways are also used to establish priorities among the proposed projects. Once the basic needs are established, a financial plan identifying the sources and amounts of available funding is developed. Funding allocations are made based on each district's transportation needs, population, lane-miles, gasoline sales and other appropriate factors. Each district then refines their list of proposed projects to be consistent with the amount of funding available.

Process

13.2.2 PD&E ~~Integrates~~

The project development phase for projects included in the Five Year Work Program and requiring PD&E includes environmental studies, the determination of project alignment and completion of preliminary design. Coordination with the Federal Highway Administration (FHWA), the State Departments of Environmental Regulation and Natural Resources, and public input are important elements of this phase. The PD&E process is described in detail in the PD&E Manual.

A detailed engineering report is normally produced in the PD&E stage which documents some of the key criteria to be used in the design of the particular facility. Typical sections, interchange and intersection locations and configurations, drainage features, conceptual bridge design, highway lighting justification, and right-of-way requirements are some of the elements that are sometimes finalized during the PD&E phase of the project. For some projects, value engineering reviews are conducted during the PD&E ~~stage~~ ^{phase}. Traffic control through work zones should also be considered.

Environmental investigations made during the course of a PD&E study are documented in the Environmental Impact document. Environmental documents frequently commit the State to certain restrictions, features and mitigation measures that must be included in the final design. The designer should carefully review the environmental documents before beginning the design. Sometimes restrictions, features and/or mitigation measures stipulated in the environmental document are such that the final design becomes unworkable. This will require a change in the environmental document. This document also lists the permits required to be obtained prior to construction of the project.

Although the district offices take the lead role in project development, the central office performs a quality assessment review of selected projects to ensure compliance with department standards and procedures. The project development phase usually takes from 12 to 36 months to complete.

13.2.3 Final Design

The next major phase in the project life cycle includes engineering design and right-of-way acquisition. During this phase of the project, the final and detailed engineering design is completed and plans, specification and contract documents prepared for construction. For most projects, right-of-way acquisition is planned and carried out during this phase of the project. All required permits are also obtained. The various elements of the final design phase are explained in detail in subsequent chapters of this manual.

Engineering and right-of-way activities normally require from 12 to 36 months to complete, depending upon the size and scope of the project.

13.2.4 Project Letting

Project letting is the next phase after final design. Once the design is complete and approved, the contract is let. To prepare a project for letting the DOT prepares specifications, plans packages, project cost estimate, and administers various procurement activities leading up to and including contract execution. These activities are performed primarily in the DOT's central office and require approximately 3 months to complete. Exhibit I-13-A illustrates the process leading up to the letting.

13.3 3R Design

Resurfacing, Restoration and Rehabilitation (3R) work is defined as work undertaken to extend the service life of an existing highway and enhance highway safety. This includes the placement of additional surface materials and other work necessary to return an existing roadway to a condition of structural and functional adequacy. It may include resurfacing, pavement structural and joint repair, minor lane and shoulder widening, the removal of parking and restriping as through lanes, removal of median curb to provide a turning lane or 2-way left turn lane, shoulder pavement, alterations to vertical and horizontal curvature, superelevation upgrading, bridge widening, modifications to bridge rails, intersection improvements, the addition of sidewalks and bikeways, utility relocation, removal or shielding of roadside obstacles, modification of side slopes and ditches, drainage modifications, upgrading of at-grade railroad crossings, aesthetic improvements, landscaping, lighting, and signing, signals and pavement markings. Pavement repairs on short segments, and patching and repair of minor pavement failures are considered by FHWA to be routine maintenance and are ineligible for 3R projects. To qualify for Federal funding, a resurfacing structural overlay must be a minimum thickness of 3/4" based on a structural analysis and the 3R project is required to adequately meet existing and probable future traffic needs in a manner conducive to safety, durability and economy of maintenance, within acceptable levels of community and environmental impact. The 3R project must be designed and constructed in a manner that will enhance highway safety and accomplish the foregoing objectives according to the particular needs.

Design criteria and standards to be used for the 3R projects are given in Florida's Design Standards for Resurfacing, Restoration, and Rehabilitation (R-R-R) of Streets and Highways Manual. These standards and criteria are not applicable to interstate projects.

13.4 In-House (DOT) Design

For in-house (DOT) design projects, all activities related to the project are performed by the various sections of the department. The complete design and preparation of the contract documents is accomplished by a team of roadway design personnel lead by the DOT Project Manager/Coordinator. Guidelines for in-house project flow are available in FDOT's Project Management Guidelines.

13.5 Consultant Design

Some design projects are contracted to consultants for design. A DOT project manager/coordinator is assigned to coordinate the project with the consultant and the various sections of the department. At specified stages in the project, the consultant is required to submit his plans to the Department for review. The DOT Project Coordinator/Manager distributes the plans as needed to the various sections for their review and comments. However, it is the consultant's responsibility to thoroughly check the plans for quality, accuracy and completeness before submitting to the Department. The DOT reviews the plans for compliance with scope, project requirements and progress.

Coordination with utility companies, permitting agencies, railroad companies, and adjacent projects is an important aspect of the design project. Responsibility for this coordination is usually specified in the consultant's scope of services.

At the completion of the design the complete plans package - consisting of the design plans, computations book, engineer's cost estimate, special provisions and other related data - is submitted to the department by the consultant. At this stage, the project is production ready. The consultant's scope of services will define the required number of plan sets and distribution.

13.6 Project Scheduling

As mentioned earlier in this chapter, engineering and right-of-way activities of final design phase normally takes 12 to 36 months. Usually the project letting date is decided well in advance and, hence, other project activities are scheduled accordingly.

A design project undergoes four phase reviews, at 30%, 60%, 90%, and 100% completion. Some small projects (less than \$2,000,000) may undergo only two or three reviews depending upon the scope of work or the district's discretion. District's may also require reviews in addition to these phase reviews.

The 30% plans review, also known as Phase I review, is the first milestone in the design of the project. The plans developed at this stage, with all existing utilities, topography, drainage, and other relevant data shown are used for preliminary utility and railroad coordination and review of preliminary proposed roadway geometrics. For complex projects, the preliminary or conceptual traffic control plan is also reviewed at this stage. If bridge structures are included in the project, then this phase also marks the review of the preliminary structural drawings including bridge data sheets and soil borings. Phase I completion of the project triggers other activities such as final drainage design, soil survey, utility contact conference, permit activities, requirements for final right-of-way maps, and foundation investigation activities for structures.

The next milestone, in a design project is the 60% complete, or Phase II review. At the completion of this phase, the geometrics should be final and the mainline and sidestreet drainage design and soil survey are complete. New activities which start at this point are signalization, signing and marking, and roadway lighting design. Other ongoing activities are permits, bridge design, utility contact conference and adjustments, engineer's cost estimate, and right-of-way acquisition. At this stage of completion, the plans should be submitted to Construction for a constructability review.

Revised 12/06/90

The WPA data should be reviewed and updated, if needed at this stage of plans completion. The 60% plans should be used to compare the "net" project length as shown on the key sheet with the gross project length obtained by subtracting the mileposts in the WPA system. If the project length shown on the plans is more than 1/2 mile less than that in the WPA system, the project manager/designer should update the value by entering the correct values in the "length" field on the "WPATS02A" screen and inform the district programming staff.

Updating project information on the "WPATS02A" screen should be coordinated with the entry of project stations and equations on the "WPATS27A" screen, which is the responsibility of the District Design Engineer

At Phase III, or 90% complete plans, most activities including quantities, computation books and technical special provisions are complete, except, in some cases, the permit process and R/W acquisition. At this stage of completion, the plans and comp book should be submitted to Construction for a biddability review.

Once the 100% plans are reviewed and approved, and all utility agreements, R/W certifications and required permits are completed, the project is at the PID (Plans in District) stage. At this stage, the transmittal letter can be completed and the plans package transmitted to the central office in Tallahassee. Plans package requirements are listed in Chapter 20 of this volume. Exhibit EX-I-20-C is an example of the transmittal letter utilized to transmit final plans to Tallahassee

For a detailed description of plans requirements for each phase, please refer to Chapter 2, Volume II of this manual

Exhibit I-13-B shows the various activities of the design project.

Revised 12/06/90

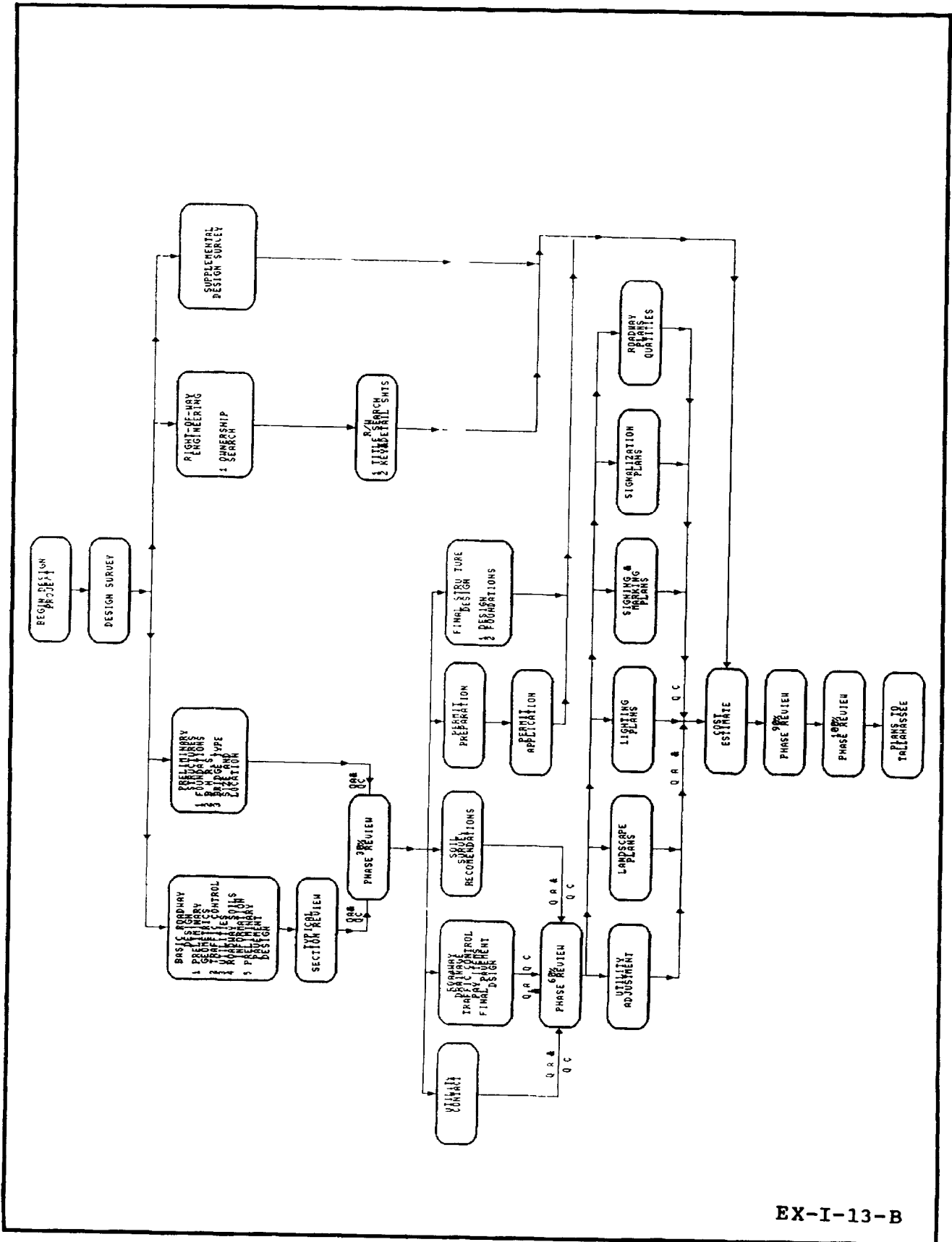

EX-I-13-B

CHAPTER 14

DATA COLLECTION

14.1 General

Data required for the design of a project are available from various sources in different forms. Prior to the start of design of the project, all available relevant data should be collected. The remainder of this chapter explains the various types of data required for the design process and their sources.

14.2 Project Data

Project data are the data specific to the project and identify the project.

14.2.1 Project Description

A complete description of the type of project, or facility, to be designed is available in the scope of services. The project length, location, county and milepost, type of facility and proposed modification or construction and total time to completion of the design are key items pertaining to the project description.

14.2.2 Project Number

Each DOT project is assigned a project number and a work program identification (WPI) number. The project number indicates the county of the location of the project, the type of facility and the type of project - i.e., PD&E, or R/W, or construction.

For federal-aid projects, the project has a DOT project number and federal-aid project number.

The project and WPI numbers are shown on the keysheet of the project plans. (See exhibit II-3-A).

14.2.3 Project Cost

The construction cost is estimated during the five-year program phase of the project, and this information is included in the program data documents. As costs are refined the Contract Estimating System (CES) should be updated to reflect the most current estimate. As a minimum, this should be done at each design phase.

14.2.4 Production Schedule

As mentioned in Chapter 13, the project goes through various phases during the design process. Each of these phases marks a production milestone which is of particular importance to the overall schedule of the project. Certain activities in the production schedule are critical and cannot be delayed without jeopardizing the production schedule. Usually, the production schedule is set using two main constraints - the letting date and the total design project time.

14.3 Design Data

Technical data required for the design of a roadway project can be available from various sources in different forms. Some of those major sources and forms are discussed below:

14.3.1 Surveys

a) Design Survey: A design survey documents the horizontal and vertical alignment, along a baseline or centerline of a project. This alignment is established with reference to fixed horizontal and vertical control points. Locations of other features - both natural and man-made - are also documented and tied to the baseline or centerline. Horizontal and vertical locations of existing aboveground and underground utilities are also given in the design survey, as described in Chapter 5. Requirements and details of conducting a design survey are given in the DOT Location Survey Manual.

b) Topographical Survey. This is one of the most important of field surveys. This survey documents all the existing features of the project site such as buildings by type, size and location with respect to baseline of survey, locations of streets and sidewalks, locations and limits of grassed or paved areas, wood lines, fence locations, lakes or ponds, changes in type of cultivation, drainage structures, and breaks in terrain. The Location Survey Manual describes procedures to be used in detail. All information from the topographical survey is input into the CADD file to provide the base data for the project.

c) Aerial Survey: Another method of obtaining project site existing features information is by aerial photographic survey. The information obtained by aerial photography survey is digitized and used as base data for the project. Good aerial

photo control is very important in order to get accurate aerial mapping. Procedures for establishing horizontal and vertical control points for aerial photo mapping are given in the Department's Location Survey Manual.

Digitized aerial mapping proves to be of great value in the preparation of drainage maps as it effectively records the development of the project vicinity at the time of design as well as the existing ground features.

d) **Drainage Survey:** All information pertaining to existing drainage conditions at the project site can be obtained from the drainage survey documents. A good drainage survey records pertinent historical facts related to the drainage of the area, reflects land use trends and any other data that may help in solving drainage problems of the project. Details of survey information required for drainage design are given in Chapter 4 of Volume 2A of the DOT Drainage Manual.

Location

e) **Right-of-Way Survey:** Project right-of-way is one of the important factors of the project and should be documented precisely. The R/W survey documents the existing R/W of the project facility. It also documents all public land corners, monuments, property lines, property owners, and complete dimensions of the properties.

f) **Soil Survey:** Soils information is required for the design of foundations for structures, pavement design and drainage design. A soils report for the project documents the type and extent of different types of soils encountered within the limits of the project. Physical properties and classifications of the soils together with the soils engineer's recommendations are documented in the soils and foundation report.

14.3.2 Traffic Data

Traffic volumes and/or counts to be used for the design of a new facility or for the improvement of an existing one are obtained from the District Planning and/or Traffic Operations office.

Traffic data are obtained by actual traffic counts on existing roads, roadside interviews and polls of potential users. The ADT (Average Daily Traffic) volume is projected over the expected life of the facility. The total volume and the percent trucks are factors used in determining geometric design criteria, projected truck volume and truck weight data. Traffic counts, classification data, weight-in-motion data and W-4 Tables are used to produce 18 kip equivalent single axle loadings (ESAL), used for pavement design.

14.3.3 Pavement Design

The pavement design should be completed as early as possible. For some projects, it is completed during the PD&E phase and for other projects it is one of the tasks to be completed during the design phase. The pavement type, composition and thickness, are determined using traffic data, projected ESALS, expected life-span of the facility, serviceability, and existing soils information. Details on pavement design can be found in DOT's pavement design manuals.

14.3.4 Environmental Documents

During the PD&E phase of ^a ~~the~~ projects, studies are made to ~~evaluate~~ ^{evaluate} the impact of the project on the environment. Factors such as noise generation and its abatement, business and residential relocations, wildlife habitat impact, and wetlands mitigation are documented in the Environmental document.

Information relating to the expected permits required for the construction of the project, and other related data are also contained in the environmental document. For small projects, a formal EIS may not be available, but all environmental data is usually available in the form of environmental reports. The environmental document may commit the State to certain design features. The designer should carefully review these documents to determine what design commitments have been made. Significant changes to the scope of the project may require reevaluation of the environmental factors.

14.3.5 Original Plans

Original plans of existing facilities requiring reconstruction prove to be a very good source of information. Information pertaining to existing alignment - both horizontal and vertical - and R/W can be helpful in the design of the new facility.

14.3.6 Accident Data

Accident data are provided by the District Safety Engineer. These data should be requested for all projects, but are especially useful for the design of 3R, safety and intersection projects and justification of signalized intersections.

14.4 List of Requests and Contacts

During the design process, the design engineer will require various items of information from different sections or departments. The following is a list of some of those items and their source.

A) Planning and Programs

- 1) Request pavement design (18 KIPS)
- 2) Request traffic data (motorized)
- 3) Request projected traffic data for intersections
- 5) Request updates of traffic data (as needed)
- 6) Railroad contact (Phase I) |
- 7) Railroad contact (Phase III) |
- 8) Plans transmittal letter data (railroad)
- 9) Notification that project is in vicinity of a traffic monitoring site

B) Location

- 1) Request survey

C) Traffic Plans

- 1) Request turns and counts for intersection design
- 3) Notification that project includes milling
- 4) Signing and pavement marking plans (Phase I) |
- 5) Signing and pavement marking plans (Phase II) |
- 6) Signing and pavement marking plans (Phase III) |
- 7) Traffic signal plans (Phase I) |
- 8) Traffic signal plans (Phase II) |
- 9) Traffic signal plans (Phase III) |
- 10) Lighting plans (Phase I) |
- 11) Lighting plans (Phase II) |
- 12) Significant review of accident data
- 13) Safety review of design plans
- 14) Response to safety review of design plans
- 15) Operational and capacity review of design plans

D) Soils and Foundations

- 1) Request pavement design LBR
- 2) Request roadway soil survey
- 3) Submit cross-sections for plotting of soils data
- 4) Request foundation investigations
- 5) Request pavement composition and mulling recommendations
- 6) Request dynaflect testing
- 7) PH and soils resistivity for culvert material selection

E) Drainage

- 1) Pavement design comments
- 2) Request grade and high water review
- 3) Request drainage design
- 4) Request final drainage review
- 5) Permit review

F) Maintenance

- 1) Pavement design comments
- | 2) Phase I Plans review
- | 3.) Phase II Plans review
- | 4) Phase III Plans review
- | 5) Response to Phase I plans review
- | 6) Response to Phase II plans review
- | 7.) Response to Phase III plans review

G) Construction

- 1) Pavement design comments |
- 2) Phase I Plans review |
- 3) Phase II Plans review (Constructability Review) |
- 4) Phase III Plans review (Biddability Review) |
- 5) Response to Phase I plans review |
- 6) Response to Phase II plans review |
- 7) Response to Phase III plans review |
- 8) Submit traffic control plan request |
- 9) Transmit marked-up utility adjustment plans |

H) R/W Surveying and Mapping

- 1) Submit title search request
- 2) Request existing right-of-way maps
- 3) Transmit right-of-way requirements
- 4) Final right-of-way check
- 5) Plans transmittal letter data

I) Utilities

- 1) Preliminary (First) contact (Phase I) |
- 2) Horizontal and vertical verification of utilities |
- 3.) Pre-Design conference and contact (Phase II) |
- 4) Final contact (Phase III) |
- 5) Plans transmittal letter data (utilities)
- 6) Number of sets of final prints for utility companies

J) Estimates and Specifications

- 1) Preliminary estimate and time (LRE)
- 2) Preliminary estimate and time (Phase I) |
- 3) Preliminary estimate and time (Phase II) |
- 4) Preliminary estimate and time (Phase III) |
- 5.) Complete estimate and contract time (Phase IV) |

K) Right-Of-Way Department

- 1) Project schedule updates as needed
- 2) R/W estimates as needed
- 3) Pre-Proposal appraisal conference
- 4) Field questions from R/W agents as needed
- 5) Plans transmittal letter data
- 6) Hazardous waste determination

| N) FHWA (if not CA or exempt)

- | 1) Phase I Plans review
- | 2) Phase II Plans review
- | 3) Phase III Plans review
- | 4) Phase IV Plans Review
- 5) Submit for typical section approval
- 6) Submit for pavement design approval
- | 7) Response to Phase I plans review
- | 8) Response to Phase II plans review
- | 9) Response to Phase III plans review
- 10) Submit exception request letters

O) Value Engineering (\$2,000,000+)

- | 1) Phase I review
- | 2.) Phase II review

Exhibits EX-I-14-A thru I are examples of some request forms utilized in obtaining the various information items required for design

DATE:

TO: Highway Statistics Engineer

FROM:

COPIES TO:

SUBJECT: State Road No.....

W.P.I. No.....

State Project No..

F.A.P. No.....

County.....

Description.....

*Description

Limits of Job

Budget Construction Year

Year Open to Traffic.....

No. of Lanes, Existing.....

No. of Lanes, Proposed.....

Type of Facility.....

(e.g. major, intermediate, or minor arterial,
freeway, expressway, city street, rural road, ramp)

System Name.....

(Interstate, FAU, FAS, etc.)

Pavement Type.....

Type of Work.....

Please forward this Design Section, the following information
for the subject project:

A. Traffic Parameters requested are:

1. ADT's
2. K, D & T Factors
 - a. T Factor Breakdown
 1. % of ADT

B. Equivalent 18 KIP Loadings

C. Years

1. _____ Current Year
2. _____ Construction Year
3. _____ Mid-year (10 years from opening)
4. _____ Design year (20 years from opening)

EX-I-14-A

DATE:
TO: Soils Engineer
FROM:
COPIES TO:

SUBJECT: State Road No....
W.P.I. No.....
State Project ...
F.A.P. No.....
County
Description.....

Transmitted herewith are prints of Plan and Profile Sheets and Cross Section Sheets on the subject project, indicating proposed alignment, gradient and flow line of proposed structures.

(For Widening and/or Resurfacing, Key Map and Typical Section Sheets only).

This is for your use in obtaining the following:

- () Soils Survey
- () Percolation Test
- () Water Samples
- () Thickness and Type of Asphalt
- () Thickness and Type of Base
- () Thickness and L.B.R. Value of Existing Subgrade
- () Design L.B.R.
- () Amount and Type of Leveling Recommended
- () Milling Recommendation
- () Soil Boring (For Structure)
- () Pavement Composition

Please furnish this information by _____.

If additional information is required, please feel free to contact this office.

Enclosure

EX-I-14-B

SURVEY REQUEST

PROJECT NO. _____

B.I. NO. _____

PROJECT
DESCRIPTION

LIMITS
SURVEY

REQUEST:

1. ALIGNMENT

2. TOPO

3. R/W

4. CROSS SECTION

5. OUTFALLS

6. SIDE STREETS

7. UTILITIES

8. OTHER

Charges can be made to Project No. _____

Comments: _____

Requested by _____ Date _____

DATE:
TO: Materials Engineer
FROM:
COPIES TO:

SUBJECT: State Road No.....
W.P.I. No.....
State Project No..
F.A.P. No.....
County.....
Description.....

Enclosed for your use are Key Map Cross Sections and marked prints of Plan and Profile Sheets for boring locations on the subject project.

If additional information is required, please feel free to contact this office.

Enclosures

EX-I-14-D

DATE:

TO: Environmental Permit Coordinator

FROM:

COPIES TO:

SUBJECT PERMIT SKETCH

State Road No.....
W.P.I. No.....
State Project No..
F.A.P. No.....
County.....
Description.....

Transmitted herewith are the original permit sketches for the above referenced project.

The following information is included to enable you to apply for the necessary permits:

1. Production date _____.
2. Letting date _____.
3. Approximate construction days _____.
4. Natural _____ or man-made _____ body of water.
5. Name of waterway _____.
6. Brief description of project:

If additional information is required, please feel free to contact this office.

Enclosures

EX-I-14-E

DATE:
TO: District Railroad Coordinator
FROM:
COPIES TO:

SUBJECT: State Road No.....
W.P.I. No.....
State Project No..
F.A.P. No.....
County.....
Description.....

Submitted this date is Sheet _____ of the signalization plans for your handling with the railroad.

The following work is proposed within railroad right-of-way.

If additional information is required, please feel free to contact this office.

Enclosure

EX-I-14-F

DATE:
TO: Utilities Engineer
FROM:
COPIES TO:

SUBJECT UTILITIES TRANSMITTAL

State Road No.....
W.P.I. No.....
State Project No..
F.A.P. No.....
County.....
Description.....

Transmitted herewith are ____ sets for your use in the coordination of utilities for the subject project.

If additional information is required, please feel free to contact this office.

Enclosures

EX-I-14-G

DATE:

TO: Construction Engineer

FROM:

COPIES TO:

SUBJECT: State Road No.....

W.P.I. No.....

State Project No..

F.A.P. No.....

County.....

Description.....

Transmitted herewith is the Record Computation Booklet for the above referenced project.

Please note the following comments:

1. This project is scheduled for a _____ production.
2. The district Construction Engineer recommends a contract time of _____ calendar days for this project.
3. The record prints are on file in the District Office.

If additional information is required, please feel free to contact this office.

Enclosure

EX-I-14-H

BUREAU OF TOPOGRAPHY
FLORIDA DEPARTMENT OF TRANSPORTATION

SUPPLEMENTAL WORK REQUEST FORM
FOR
CADD AND CROSS SECTION PROJECTS

(ATTACH TO WORK REQUEST
FORM PD 100) #87-1417

PROJECT NAME _____ STATE JOB NO _____

REQUESTED BY _____ DATE _____

DELIVER TO _____

DIGITIZED TOPOGRAPHY
SCALE OR SCALES
DESIRED

1" = 20'	1" = 40'	1" = 50'	OTHER

LIMITS OF
COMPILATION

LEFT LIMITS	RIGHT LIMITS

HAS HORIZ ALIGNMENT BEEN CODED IN ROADS DESIGN FILE?

YES	NO

NAME OF PERSON IN CHARGE OF ROADS FILE _____

ARE PHOTOGRAMMETRIC CROSS SECTIONS DESIRED

YES	NO

WHAT CENTERLINE INTERVALS _____

COVERAGE RIGHT
AND LEFT

LEFT LIMITS	RIGHT LIMITS

SPECIAL REQUEST REQUIREMENTS OR COMMENTS _____

FIELD CHECK BY

DELIVERY MEDIA

PLOTTED ON MYLAR _____

PLOTTED ON PAPER _____

WRITTEN ON TAPE _____

WRITTEN TO DISC _____

DISTRICT	TOPO	OTHER

EX-1-14-I

Chapter 15

Phase Reviews and Scheduled Submittals

15.1 General

All major projects will have four phase reviews prior to transmittal of plans to the Central office for letting. Phase I, II, III, and IV reviews will be performed and documented. Minor projects, such as resurfacing, will have a minimum of two phase reviews. The two reviews should consist of a final phase and one prior phase review.

Phase reviews are performed to allow other District Office units (Safety, Maintenance, Construction, etc.) to provide input regarding the development of the project and to review the adequacy and completeness of the plans. Phase reviews are not intended to be the only Quality Control. Quality Control shall be performed prior to each submittal of the plans for a phase review as discussed in Chapter 16 of this volume.

Each District shall develop a procedure for accomplishing all phase reviews. The procedure will identify the persons responsible for coordinating the phase reviews and distributing the plans for the reviews. The individuals and offices that will review and provide comments on each phase review should be identified in the procedure. The procedure must also outline the method of documenting all phase reviews, including the resolution of any comments made during the reviews.

The District shall ensure that the requirements of each phase review as shown in this manual are met. Phase reviews are complete when the comments from all the various offices have been resolved and documented.

15.2 Design Plans Phase Review

| On minor projects reviews will be held at a final phase and at one prior phase. One of these reviews must be an on-site review. All reviews will include personnel from Design, Construction, Maintenance, Safety, FHWA (for Federal Aid Projects which are not CA or exempt) and any other department representatives who can provide review input. A formal on-site review shall be made to ensure the design is appropriate and that no physical features have been altered or added.

| On complex projects reviews must be held at the Phase I, II and III stages as well as the final check at Phase IV. Two on-site reviews will be required. Generally these are held at Phases I and III with personnel from the offices noted under minor project reviews. Also, an on-site visit before design by the senior designer is desirable.

| For phase reviews which are not held on-site, construction, maintenance, Safety and FWHA (for federal aid projects which are not Certification Acceptance or exempt) offices must be sent copies of the plans and requested to furnish comments.

An additional update review, including an on-site review, will be required on all projects that have been delayed and shelved for more than nine months since the final review.

| The District Safety Engineer shall be given an opportunity to be included in these reviews. The use of accident history is required on all reconstruction, intersection improvements and 3R type projects to ensure that all accident problems have been addressed.

The District Project Manager/Coordinator is responsible for ensuring that prints are distributed to the appropriate personnel and that the above reviews are held on each project. Size "B" (11" x 17") prints may be used for reviews, at the District's option.

For consultant projects, the Districts are to specify the number of prints required and the size prints, if there is a preference. This should be stated on the consultant's scope of services.

For detailed requirements of each phase review submittal, please refer to Chapter 2 of Volume II of this manual.

15.2.1 Plans Disposition

As discussed in Chapter 13 of this Volume, each phase of the plans preparation triggers other activities in the process of the project's design life cycle.

The Phase I plans are used for the initial contact with the utility companies. The alignment, horizontal and vertical, and typical sections are checked for compliance with design criteria, project and site requirements, compatibility with adjacent projects and drainage requirements.

The Phase II plans are used for the signing and marking design, roadway lighting design, signalization design, traffic control sheets, other component plans preparation, permit package preparation, constructability review and updating of the WPA system. Usually at this stage of the project a utility predesign conference also occurs. CES data input is recommended at the completion of Phase II plans.

At Phase III all plans are usually complete including the Quantity Computation Book(s) and the cost estimate and Construction has performed a biddability

review After Phase IV a record set of plans are signed, sealed and dated, and the originals placed in PID Status to be transmitted to the Central Office in Tallahassee

The disposition of the plans after they are transmitted to the Central Office is shown in Exhibit EX-I-13-A in Chapter 13

15.3 Other Submittals and Requests

Other design plans, besides the roadway plans, of a project also go through reviews at various stages of the design as listed below

15 3 1 Structures (Bridges, Walls and Buildings)

1 Bridges

Bridge design begins when the foundation investigation is complete and on a schedule which permits preliminary bridge plans and the Phase II roadway plans to be reviewed simultaneously In the case of a stream or river crossing, the drainage design, including preliminary scour considerations, must also be complete prior to beginning structures design All structures design work is coordinated through District Structures Engineer or the State Structures Design Office in the Central Office, depending on the category or complexity of the structure. A typical section of the facility crossing, horizontal and vertical clearances required and the profile grades should be determined prior to beginning structures design For complete details and requirements for structural designs and plans preparation, the reader is referred to the Structures Design Guidelines (Topic 625-020-101) and the Structures Detailing Manual (625-020-201) issued by the Structures Design Office

Generally, the completion and review of bridge plans are completed in three phases as listed below. These reviews do not necessarily coincide with the phase reviews of the roadway plans.

Preliminary - (30%)

Final (90%)

Tracings (100%)

In order to prevent problems and to "Do it right the first time," the following procedures should be used:

Typical Section Package - The typical section approval package should include a section showing width of bridge that is to be provided for all bridges. The structural design should not proceed until the typical section has been approved by the District Design Office.

Request for Structural Design - (Bridges and Retaining Walls) All requests for structural design should include roadway plan and profile sheets showing horizontal and vertical alignment and cross sections within 500 feet on each end of the bridge or ends of retaining walls. Horizontal curvature that is on or near the end of the bridge or retaining wall must be shown. Superelevation transition (runoff) details must be included with the transmittal if any part or all of the transition is on the bridge or wall. The approved typical section should be included with the transmittal.

Provisions for access to property near the end of bridges and adjustments to avoid costly right-of-way takings should be resolved prior to submittal. An attempt should be made to avoid horizontal and vertical curvature on the bridge, if possible, without sacrificing safety. Superelevation transition lengths may be appropriately adjusted, to avoid transitions on the bridge.

Coordination of Final Plans - The District will request prints of bridge plans prior to submittal of the final roadway plans to Tallahassee to ensure that roadway and bridge plans are consistent, i.e., widths, superelevation transitions, vertical and horizontal alignment, and work zone traffic control agree

2 Other Structural Submittals and Reviews

In addition to bridge plans, structure plans may include retaining walls, noise barrier walls, box culverts, pedestrian overpasses, and special structural appurtenances

For projects where bridges and other structure plans are involved, preliminary and final plan submittals (usually along with bridge plans) should be handled according to the instructions for current and future handling of structures tracings (reproducibles) for both Category 1 and 2 structures, dated August 23, 1991, from the Structures Design Office

For projects where retaining walls are required along with roadway plans only (no bridge in the project), DOT District Offices shall be responsible for development of wall plans, proper reviews and submittal of preliminary and final plans and submittals to the FDOT prequalified wall companies, if applicable.

3. Mechanically Stabilized Earth Walls

Where proprietary walls are involved, the detailed control plans shall be submitted to DOT approved wall companies. This will be the responsibility of the consultant or the DOT Office responsible for development of wall plans. The preliminary control plans should be submitted early in the project development. This will give the wall companies time to prepare a good bid by the time the contract is let.

After appropriate structural and geotechnical review, the wall plans are submitted directly to all appropriate prequalified wall companies for their bidding information. The Florida DOT District Office is responsible for the structural and geotechnical review prior to submitting these plans for review. The submittal of detailed control plans should occur as early in the design process as possible to give companies plenty of time to prepare a good construction bid proposal.

Where the District Office cannot carry out the structural review or verify the review as proper by a consultant, such review may be requested from the Structures Design Office.

The wall companies only claim responsibility for their system, the wall and soil mass engaged - thus the geotechnical review must include analysis of the boundary soil conditions. Chapter 18 of the Structures Design Guidelines (Topic 625-020-101) contains the procedures and requirements for the engineering and geotechnical design of retaining walls.

15.3.2 Surveys

Most field surveys will be completed before the start of the design since the survey information is needed for the design. The Roadway soils survey is normally completed between the Phase I and Phase II Roadway plans review. |

Survey for bridge data sheets and channel alignment should be completed during this same period. |

15 3 3 Typical Sections

All projects except intersection improvements and state funded resurfacing projects require approval of the typical section. For most projects, the typical section is approved during the PD & E phase. For Final design projects that require approval of typical sections, the typical section package should be submitted before the Phase I review to allow ample time for approval. Typical sections shall be submitted on 8 1/2" x 14" sheets, approved, signed and sealed by the responsible engineer. Space must be provided for concurrence by the DOT and, for projects with FHWA oversight, by FHWA. Exhibits EX-I-15-A thru EX-I-15-D are samples of Typical Section Data Sheets utilized for Typical Section approval. Exhibits EX-I-15-A and C are to be used when prepared by a consultant for the Department. Exhibits EX-I-15-B and D are to be used when prepared in-house.

When preparing typical section packages, only typical sections for the main roadway and/or bridge are necessary. Minor variations to these do not need typical sections. All side street tie-ins, etc., can be handled as part of the routine plan review process or as partial sections which show typical details.

TYPICAL SECTION DATA SHEET

PROJECT IDENTIFICATION	WORK PROJ. ITEM	COUNTY	SECTION	JOB	STATE RD	F.A. PROJ. NO.
PROJECT LENGTH		PROJECT LIMITS				
		BEGINS:		ENDS:		
FUNCTIONAL CLASSIFICATION	() RURAL () URBAN	TRAFFIC (ADT)		DISTRIBUTION	DESIGN SPEED	
() FREEWAY/EXP	() MAJOR COLL	_____ CURRENT		K _____ %	_____	
() PRINCIPAL ART	() MINOR COLL	_____ POST CONST		D _____ %	POSTED SPEED	
() MINOR ART	() LOCAL	_____ FUTURE () YEAR		T _____ %	_____	
DESIGN STANDARDS		WILL CONFORM WITH REQUIRED STANDARDS		FEDERAL AID PROGRAM		
() NEW CONST		YES NO		YES NO		
() MAJOR RECONST		() () VERTICAL ALIGNMENT		() () FEDERAL AID SYSTEM		
() RRR		() () HORIZONTAL ALIGNMENT		() () F.A. INTENDED		
		() () OTHER DESIGN STANDARDS		() () ADD TO SYSTEM		
IF NO (ABOVE) LIST DEVIATIONS				RECOMMENDED MAINTENANCE		
				() FOOT		
				() COUNTY		
				() OTHER _____		
RR CROSSINGS				NO. OF TRACKS		
RAILROAD _____ LOCATION _____				_____ MAIN _____ PASSING _____ NO		
EXISTING PROTECTION _____						
PROPOSED PROTECTION _____						
LAND USE (GIVE NO. PER MILE)		NONMOTORIZED TRAFFIC *				
_____ RESIDENTIAL DRIVEWAYS		PEDESTRIAN		LIST TYPE OF PED./BIKE TRAFFIC		
_____ COMMERCIAL DRIVEWAYS		() NONE		() NONE		
_____ WITH ACCEL./DECEL. LANES		() MODERATE		_____/_____/ GRADE SCHOOL ____/_____/ ADULT		
_____ 2-LANE NON-SIGNALIZED INT		() HEAVY (SCHOOL)		_____/_____/ MIDDLE SCHOOL ____/_____/ PROFICIENT		
_____ 2-LANE SIGNALIZED INT		() HEAVY		_____/_____/ HIGH SCHOOL ____/_____/ SENIOR ADULT		
_____ 4-LANE NON-SIGNALIZED INT				_____/_____/ ESTIMATED ANNUAL GROWTH		
_____ 4-LANE SIGNALIZED INT				NO. OF EACH WITHIN 2 MILES *		
_____ MEDIAN OPENINGS		_____ GRADE SCHOOLS		_____ VO-TECH/COLLEGES		_____ MAJOR EMPLOYERS
_____ OTHER (SPECIFY) _____		_____ MIDDLE SCHOOLS		_____ SHOPPING/SERVICES		_____ % OF UNDEV. LAND IN CORRIDOR
		_____ HIGH SCHOOLS		_____ OTHER SIGNIFICANT ATTRACTORS		
MAJOR INTERSECTIONS (LOCATION/DESCRIPTION - REQUIRING SPECIAL DESIGN)						
MAJOR STRUCTURES (LOCATION/DESCRIPTION - REQUIRING INDEPENDENT STRUCTURE DESIGN)						
UTILITY CONFLICTS (POSSIBLY AFFECTING PROJECT CONCEPT)						
TRAFFIC SIGNALIZATION (LIST INTERSECTIONS)						
HIGHWAY LIGHTING (DESCRIBE LIMITS)						
REMARKS (REGARDING MOTORIZED AND NONMOTORIZED USAGE)						
CONCURRENCE:		CONCURRENCE:		APPROVED BY:		
_____		_____		_____		
FHWA DISTRICT ENGINEER		DISTRICT DESIGN ENGINEER		CONSULTANT		
_____		_____		_____		
DATE:		DATE:		DATE:		
_____		_____		_____		

* SECTIONS MARKED BY AN "*" ARE TO BE COMPLETED BY THE DISTRICT BICYCLE COORDINATOR

TYPICAL SECTION DATA SHEET

PROJECT IDENTIFICATION	WORK PROJ. ITEM	COUNTY	SECTION	JOB	STATE RD	F.A. PROJ. NO
PROJECT LENGTH		PROJECT LIMITS				
		BEGINS:		ENDS:		
FUNCTIONAL CLASSIFICATION	() RURAL () URBAN	TRAFFIC (ADT)		DISTRIBUTION	DESIGN SPEED	
() FREEWAY/EXP	() MAJOR COLL.	_____ CURRENT		K _____ %	_____	
() PRINCIPAL ART	() MINOR COLL.	_____ POST CONST		D _____ %	POSTED SPEED	
() MINOR ART	() LOCAL	_____ FUTURE () YEAR		T _____ %	_____	
DESIGN STANDARDS		WILL CONFORM WITH REQUIRED STANDARDS		FEDERAL AID PROGRAM		
() NEW CONST		YES NO		YES NO		
() MAJOR RECONST		() () VERTICAL ALIGNMENT		() () FEDERAL AID SYSTEM		
() RRR		() () HORIZONTAL ALIGNMENT		() () F.A. INTENDED		
		() () OTHER DESIGN STANDARDS		() () ADD TO SYSTEM		
IF NO (ABOVE) LIST DEVIATIONS				RECOMMENDED MAINTENANCE		
				() FDOT		
				() COUNTY		
				() OTHER _____		
RR CROSSINGS				NO OF TRACKS		
RAILROAD _____ LOCATION _____				_____ MAIN _____ PASSING _____ MD		
EXISTING PROTECTION _____						
PROPOSED PROTECTION _____						
LAND USE (GIVE NO. PER MILE)		NONMOTORIZED TRAFFIC *				
_____ RESIDENTIAL DRIVEWAYS		PEDESTRIAN		LIST TYPE OF PED./BIKE TRAFFIC		
_____ COMMERCIAL DRIVEWAYS		() NONE		___/___ X GRADE SCHOOL ___/___ X ADULT		
_____ WITH ACCEL./DECEL. LANES		() MODERATE		___/___ X MIDDLE SCHOOL ___/___ X PROFICIENT		
_____ 2-LANE NON-SIGNALIZED INT		() HEAVY (SCHOOL)		___/___ X HIGH SCHOOL ___/___ X SENIOR ADULT		
_____ 2-LANE SIGNALIZED INT				___/___ X ESTIMATED ANNUAL GROWTH		
_____ 4-LANE NON-SIGNALIZED INT						
_____ 4-LANE SIGNALIZED INT		NO. OF EACH WITHIN 2 MILES *				
_____ MEDIAN OPENINGS		_____ GRADE SCHOOLS		_____ VO-TECH/COLLEGES		_____ % OF UNDEV. LAND IN CORRIDOR
_____ OTHER (SPECIFY) _____		_____ MIDDLE SCHOOLS		_____ SHOPPING/SERVICES		_____ MAJOR EMPLOYERS
		_____ HIGH SCHOOLS		_____ OTHER SIGNIFICANT ATTRACTORS		_____ PARKS/RECREATION
MAJOR INTERSECTIONS (LOCATION/DESCRIPTION - REQUIRING SPECIAL DESIGN)						
MAJOR STRUCTURES (LOCATION/DESCRIPTION - REQUIRING INDEPENDENT STRUCTURE DESIGN)						
UTILITY CONFLICTS (POSSIBLY AFFECTING PROJECT CONCEPT)						
TRAFFIC SIGNALIZATION (LIST INTERSECTIONS)						
HIGHWAY LIGHTING (DESCRIBE LIMITS)						
REMARKS (REGARDING MOTORIZED AND NONMOTORIZED USAGE)						
CONCURRENCE:				APPROVAL:		
FHWA DISTRICT ENGINEER:				DISTRICT DESIGN ENGINEER:		
DATE:				DATE:		

* SECTIONS MARKED BY AN "*" ARE TO BE COMPLETED BY THE DISTRICT BICYCLE COORDINATOR

STATE OF FLORIDA DEPARTMENT OF TRANSPORTATION
PROPOSED TYPICAL SECTION

COUNTY	ROAD NO.	LENGTH	TERMINI		SECTION	JOB	EST. COST
			APPROVED BY: _____ CONSULTANT _____ DATE _____				
FEDERAL AID PROJECT NO.	M.P. NO.	CONCURRENCE:		CONCURRENCE:	JOB	EST. COST	
		DISTRICT DESIGN ENGINEER _____ DATE _____					
						CONSTRUCTION	

STATE OF FLORIDA DEPARTMENT OF TRANSPORTATION
PROPOSED TYPICAL SECTION

COUNTY	ROAD NO.	LENGTH	TERMINI	SECTION	JOB	EST. COST (CONSTRUCTION)

15 3 4 Pavement Design

For projects that require pavement design in the design phase, the pavement design package should be submitted as early as possible. For some projects, a preliminary pavement design is approved at or before the Phase I review with the final pavement design being approved at the Phase II completion stage.

Pavement design packages sent to the FHWA for approval should only be for the major items of the main roadway. Minor variations can be handled as part of the normal plans review process.

15 3 5 Permits

The required permits will be determined during Project development and Environmental Study phase. The District permitting office is responsible for coordinating and processing the permits and must be contacted early in the project to determine the level of detail needed in the permit packages. The DOT Project Manager/Coordinator must communicate this information to the appropriate office preparing the permit packages. In general, permit approval is a lengthy process and permit applications must be submitted early enough so that the construction schedule will not be delayed due to permits being processed.

The permitting agencies and the estimated processing time frame should be listed in the overall project schedule developed by the Project Manager/Coordinator.

Agencies with permitting authority are listed below

Florida Department of Environmental Regulation

U S Coast Guard

Local Environmental Agencies

U.S Army Corps of Engineers

Florida Department of Natural Resources - Bureau of Beaches
and Shores.

Agencies with an interest but no permitting authority are listed below

Florida Department of Natural Resources - Bureau of Beaches
and Shores

Florida Game and Freshwater Fish Commission - Office of
Environmental Services

Florida Department of Veterans and Community Affairs -
Bureau of Land and Water Management

U.S. Fish and Wildlife Services

National Marine Fisheries Service - Environmental
Assessment Branch

Regional Planning Councils

Local Governments and Transportation Authorities

U S Environmental Protection Agency

15 3 6 Right of Way Surveying and Mapping

During right-of-way map preparation there are typically four phases as described below. All map preparation procedures shall be in accordance with the DOT Right-of-Way Surveying and Mapping Manual.

- Preliminary - involves project alignment, curve data, section corners, cross road alignments
- Intermediate - revisions from preliminary submittal, existing right-of-way, subdivisions, interchanges, proposed right-of-way with takings dimensioned
- Near Final - revisions from intermediate submittal, easements, tabulation of ownerships, right-of-way requirements for drainage easements
- Final - revisions from near final submittal, complete right-of-way maps in accordance with the DOT Procedure 575-010-000

Right-of-way maps are prepared in accordance with the procedures as described in the Department's Right-of-Way Surveying and Mapping Manual. Information is added to the right-of-way maps as it becomes available and close coordination is required between the design and right-of-way sections. R/W requirements should be well identified on roadway plans as early as possible. Final requirements on project alignment must be identified by Phase II roadway plans and transmitted to R/W office.

Title search will be ordered as soon as feasible alternatives are determined. It is necessary, particularly on urban projects, to obtain ownership search to assist in the establishment of the right-of-way limits. The ownership search may be

conducted by the District Right-of-Way Surveying and Mapping office or the design consultant.

Access road and drainage (outfalls) requirements are generally the last requirements to be established in the R/W phase and must not be overlooked. They should be established in the PD&E phase when possible and adjustments made as necessary. Access road studies (justification) are required on limited access and federal aid projects and will necessitate appraisals. The appraisals and justification are developed by Department personnel or by fee appraisers. This activity takes time and therefore should be requested as soon as possible. Appraisals have an age limit, therefore, they must be compatible with the acquisition schedule.

The instruments are prepared by the Department, although the legal descriptions may be prepared by the design consultant's surveyor.

It is important to note that, on federal-aid projects, the formal appraisal activity cannot begin until the final right-of-way map is approved and the function is programmed with the FHWA. The right-of-way requirements must be made available for R/W map preparation at the earliest possible time to facilitate the timely acquisition of title searches.

Occupancy permit requirements must be defined by the 100% plans completion stage so they can be obtained by the right-of-way office.

15 3.7 Value Engineering

Any FDOT project with a construction cost in excess of \$2,000,000 are candidates for a value engineering review. The Value Engineering Coordinator will screen and select projects based on cost saving potential. The Project Manager and/or Designer should expect recommendations from the value engineering team that will need to be incorporated into the design. However basic concepts established during the PD&E phase will not be altered except in extraordinary circumstances.

If a project has been selected for a value engineering review, it is the Project Manager's/Designer's responsibility to ensure the review is conducted in a time frame that allows maximum opportunity for value improvement considerations and still maintain proper project progress. Value engineering reviews shall be conducted in accordance with the Value Engineering Design Review Procedure No 625-030-002a. As such, value engineering reviews should occur no later than Phase I plans completion. Accepted design changes can be accomplished with minimal impact of project schedule if value engineering recommendations are provided early in the design phase.

VALUE ENGINEERING TEAM

The Project Manager, as the leader of the design effort, should be available to the value engineering team to provide input concerning project decisions and data. When the project is being developed by a consultant, a representative of the consultant should be available to present to the team, assumptions and data for project decisions. The Project Manager should maintain close communications with the value engineering team leader as the study progresses, continually providing input for consideration by the team.

VALUE ENGINEERING FINDINGS

After completion of the value engineering team study, a draft summary report will be prepared. The Project Manager should make a thorough review of the findings with the team's input. Questions that should be asked are

- o Do the recommendations achieve the objectives of the project?
- o Have all design and existing conditions been considered?
- o Are all changes suggested economically feasible?
- o Will the project schedule be affected by the changes? Are the delays justified by the savings resulting from the changes?
- o Are the changes consistent with agreements with the local community or citizen groups?
- o Will additional public meetings be required?
- o Are any design controls altered? Are they acceptable?
- o Do the recommendations provide a long term advantage or short term solutions?
- o Will the recommended changes improve the project?

The purpose of this session is to afford the Project Manager with a "first" review of the team's recommendations, and to evaluate with the team, their potential implementation. The Project Manager, being the most knowledgeable person of the project specifics and objectives, should use this opportunity to ensure that recommended changes are consistent with project intent.

If the Project Manager and the value engineering team are in agreement, the value engineering summary study should be finalized and distributed to all persons concerned with the project, along with written concurrence of implementation by the Project Manager. In the event that the Project Manager and value engineering team cannot reach an agreement, a presentation to management will be

scheduled At this meeting, the value engineering team will present their recommendations The Project Manager will present his evaluation of the value engineering recommendations

At the conclusion of the management presentation, a decision should be made to accept all, or a portion of, the value engineering recommendations Having this decision, the Project Manager should inform, in writing, all persons involved in the project of the recommendations accepted for the continuation of the work

Chapter 16

QUALITY CONTROL

16.1 General

The design and preparation of plans for all projects shall include the necessary assurances for accuracy, proper engineering criteria application, completion, and quality. This is the responsibility of the designer, and shall be accomplished by adhering to a Quality Control Plan. A Quality Control Plan is a comprehensive, well defined, written set of procedures and activities aimed at developing designs that meet or exceed Department criteria, and producing plans in accordance with this manual. The plan will identify the organization or individuals responsible for quality control and the specific procedures used to insure the control of quality. The plan will also detail the method of accountability and documentation.

Each District will adopt its own Quality Control Plan. Consultant firms working for the Department will also have a QC Plan in place. The Project Manager/Coordinator is responsible for ensuring that the appropriate District or Consultant Quality Control Plan is adhered to.

16.3 3R Projects Checklist

3R (Restoration, Rehabilitation and Resurfacing) projects have different requirements than design projects, hence the checklist for phase review of 3R projects is different. For a complete discussion of 3R project requirements, please refer to the current 3R manual.

16.4 Field Reviews

As mentioned in Chapter 15 of this volume, all projects will have at least two field reviews. For major projects, a minimum of three field reviews, including the pre-design field review, are desirable. An additional update field review shall be required for all projects delayed and shelved for more than nine months since the final 100% review.

Chapter 17

QUALITY ASSURANCE

17.1 General

Quality Assurance is the planned, coordinated and continuing activities performed to compare process, work products and services with written predetermined critical requirements. The objective of all Quality Assurance activities is the continual improvement of the total delivery process to ensure quality, productivity and user satisfaction.

The offices under the State Transportation Engineer have developed a Quality Assurance monitoring plans. The Roadway Design monitoring plan is designed to compare work product processes with the predetermined critical requirements necessary to ensure quality designs and control.

Critical areas to be monitored are based on well established roadway design policy and practice. These policies, guidelines and accepted practices formulate the criteria used to measure compliance in the areas critical to quality. The plan designates methods to be used to monitor design functions on a two year frequency or as necessary. Latitude is granted to the reviewer for the depth and frequency of reviews, based on the individual district's observed performance, review findings or the needs of the unit being reviewed.

Results of the monitoring activities are reported to management in exit interviews and reports to point out areas that need improvement, to obtain feedback on the effectiveness and appropriateness of established policies, procedures and standards and to recognize outstanding areas of quality success. The reports are

| also used to share improvement ideas between districts, to maintain consistency
| in process and practice and to transfer technology

|
| While the Q A plan covers only the main functional areas of roadway design, the
| designers and reviewers must recognize that quality is the result of doing many
| individual activities and details correctly All activities must conform with the
| valid requirements no matter how large or small their overall contribution Good
| drafting techniques, attention to details, making the plans legible and
| reproducible are just as essential to quality as good engineering practice

17.2 **Authority**

The Florida Statutes (20 23(3)) specifically states that the Central Office shall |
establish departmental policies, rules, procedures and standards and shall monitor |
the implementation in order to ensure uniform compliance and quality |
performance by the districts and central office units that implement transportation |
programs |

17.3

Areas of Responsibility

- I A) Central Office Role--Quality Assurance Provide all the planned and systematic actions necessary to provide adequate direction to the districts so that all resulting design products can meet predetermined requirements This involves the establishment of design policies, procedures, standards and guidelines, training, and the monitoring and review of district compliance with these items

- B) District Role--Quality Control Following established design policies, procedures, standards and guidelines in the preparation of all design products, and the checking and review of individual designs for compliance and good engineering practice

- C) Area Design Engineer (ADE) Manage the Quality Assurance plan, document findings and maintain continuity with the department on design policy, procedures, standards and guidelines

17.4 Critical Areas to be Monitored

The current Roadway Design monitoring plan for Quality Assurance lists the following critical areas to be monitored

- 1 Geometric Design - Design functions include typical sections, horizontal and vertical alignment, decision and conflict points and pedestrian and other non-motor vehicle elements.
- 2 Traffic Design - Design functions include traffic signals, signing and pavement markings and highway lighting
- 3 Drainage Design - Design functions include stormwater management, conveyance, permitting, erosion and scour
- 4 Estimates and Specifications - Design functions include pay item list, documentation of quantity take-off, summary of quantities and preparation of special provisions to cover items of work, measurement and payment
- 5 Contract Plans - Design functions include plans assembly, proper signing and sealing and proper handling of revisions. This area is also monitored for results such as completeness, reproductivity, legibility, biddability and constructability
6. CADD Design - Design functions include file naming convention, working units, cell library, symbolism, proper software and geometry programs

| 7 Certification Acceptance - Critical requirements of the certification
| acceptance agreements cover all areas of engineering design functions
| Functions and responsibilities are covered in detail in the procedures
|

| 8 Utilities - Critical functions include advance coordination, detailed
| adjustment documentation and quality standards and criteria for clearing
| utilities prior to construction
|

| 9 Special Facilities - Critical functions include architectural design services,
| asbestos management and fixed capital outlay management
|

| The foregoing critical areas and design functions can be revised from time to time
| with input and feedback from the districts Compliance with the criteria and
| critical requirements defined in the procedures and standards referenced is
| essential to ensure quality, productivity and user satisfaction in the roadway
| design delivery process

17.5

Documentation

- A. Documentation The Quality Assurance process will be documented in a quarterly report that will be distributed to the District Secretaries and other affected offices. A brief summary of the data will also be entered in the Quality Assurance Reporting (QAR) data base.
- B. Area Design Engineer (ADE). An ADE is assigned to each district and will be responsible for conducting and/or coordinating all roadway design QA activities with that district.
- C. Review. A review will be conducted in each design function and its associated components a minimum of once every two years. This review will be for assurance that the districts have adequate control measures in place and are complying with policy, procedures, standards, guidelines and processes and for identification of any areas of excellence, noncompliance and need.

17.6 Consultant's Role

The consultant's role is much the same as the districts' (Quality Control) since their primary responsibility is the preparation of contract plans as agents for the districts. Consultants must ensure quality and adherence to policies just as must any office with the Department. The consultant firms are held responsible for the quality, accuracy and completeness of the work supplied to the Department.

17.7 **Training**

Training and assistance are also a mandated role of the Central Office units and the Quality Assurance program

A Development Roadway Design will formulate a training plan based upon the districts' requests and needs as determined by the Q A reviews

B Delivery Training courses will be conducted for district personnel as requested, with schedules and locations sensitive to budgets and production schedules

Chapter 18

PAY ITEMS

18.1 General

Project cost estimating and the establishment of contract time are important phases of the design project and occur after the roadway design is complete. This chapter briefly describes the various requirements for the completion of the Bid Package.

18.2 Pay Items

Pay Items are the various roadway construction elements for which payment is made to the contractor. A method of measurement and payment is established for each separate construction element of the roadway design. The Basis of Estimate Manual contains the description, item number and unit of measurement of each construction element. This manual also explains the establishment of pay item numbers for each construction element.

As mentioned in Volume II of this manual, pay items are identified at the 60% completion of the project and quantities added at the 90% completion. At the final or 100% completion of the project, all pay items are finalized and the final Summary of Pay Items is obtained.

18.3 CES

The purpose of the Contract Estimating System (CES) is to compile and produce an accurate contract cost estimate in the same manner as that of a contractor preparing his bid. For detailed procedures on the use of the CES program, please refer to "Contract Estimating System, District Manual "

18.4 Computation Book

The computation book contains all computations required to calculate pay item quantities required for the project. All computations should be done on relevant computation forms as described in the Basis of Estimates Manual and completed as required in the Computation Manual. The computation book supports the pay item quantities and is required to be submitted with Phase III and Phase IV review submittals. The original Comp book, including the Structures Comp book, shall be sent to Tallahassee as part of the transmittal package. After the project is let, the Comp book will be sent to the District Construction Office with the reproducible plans.

18.5 Contract Time

After the Phase III completion of the design project including the completion of the cost estimate, the plans package is submitted to the district construction office scheduling engineer for establishing the contract duration. Contract duration is the time required for the complete construction of the contract. A copy of the contract time is submitted to the Central Office in Tallahassee with the complete package. Certain large complex projects should have the desired contract duration established earlier in the design process.

Once the contract time has been established for federal-aid projects, trainee manhours should be computed. The Basis of Estimates Manual has instructions for computing the number of trainees and the number of manhours required.

18.6 Shop Drawings

For non-structural shop drawings, the Engineer of Record that will be responsible for the review must be listed on the key sheet of the specific plans, along with his/her mailing address.

Example:

Engineer of Record
Lighting Shop Drawings
John Doe, P E
111 S Avery Street
Tallahassee, Florida 32301

Chapter 19

SIGNING AND SEALING DESIGN DRAWINGS

19.1 General

The Florida State Board of Professional Engineers has reviewed this Chapter and is in concurrence with its requirements. To assure continued concurrence, the Board will have the opportunity to review future changes.

Section 334.175 of the Florida Statutes, requires that all design drawings prepared by or for the Department be signed, sealed and dated by the professional engineer in responsible charge of the project work, in accordance with Chapter 471, Rules 21H-19, 21H-23 and 21H-26. Such professional engineer must be duly registered in this state. Responsible charge means direct control and personal supervision of engineering work done by oneself or by others over whom the engineer exercises supervisory authority.

This chapter will outline the proper procedures of signing and sealing the Department's drawings and engineering documents. It shall be the District's responsibility to ensure that all record sets and documents are properly signed, sealed and dated and are retrievable on reasonable notice.

19 2 Signing and Sealing of Plans

19 2 1 Original Plans

l No signatures or seals are to be placed on the original sheets of a plan set
l Filling out the title block with initials and dates is optional If the "Approved
l by" box is used, the name shall be printed

The key sheet for each component set (i e , roadway, signing, etc) shall have the responsible professional engineer's name (printed or leroyed) The professional engineer's registration number shall be placed under the completion date The following format shall be used

Roadway Plans Approved By _____
Date _____
P E No _____

For the other components, "Roadway" should be substituted with the title of the component set, such as "Signing and Marking"

19 2 2 Record Set

l The Record Set shall be a xerographic copy For CADD developed plans, 11"
l X 17" ("B" size) plotted to scale, i e 1" = 40', may be used All plans with
l hand drawn sheets shall be 24" X 35" or 36" ("D" size), plotted to scale, i e 1"
l = 20' Each sheet of the Record Set must be signed and sealed by the responsible professional engineer in charge The date shall be placed immediately under the signature and the embossed seal placed over the signature and date For convenience of storage, it is recommended that the location of this seal be varied across the bottom area of the sheet

19.3 Signing and Sealing Other Engineering Documents

Engineering Documents are defined as any reports, computations, or recommendations that influence or limit the design engineer's decisions in the development of design plans. Bound Engineering Documents must be signed and sealed on a signature page or cover letter by each professional engineer who is in responsible charge of any portion of the document. The date shall be placed immediately under the signature and the embossed seal placed over the signature and date. Any document, report or computations not bound shall require all sheets to be signed and sealed.

A signed and sealed record copy of the following Engineering Documents shall be placed in the District Project Records File

- Specifications & Special Provisions
- Pavement Design Package
- Typical Section Package
- Drainage Computations
- Hydraulics Reports
- Traffic Engineering Reports and Recommendations
- Environmental Reports and Recommendations
- Soil Survey Reports and Geotechnical Analysis
- Value Engineering Record
- Roadway and Traffic Design Standards
- All other Engineering Reports
- *Permit documentation*

19.4 Supplemental Specifications and Special Provisions

When more than one engineering discipline (Civil, Electrical, etc.), is involved, more than one signature may be required on the specifications. This can be accommodated on an index sheet indicating the pages of specifications which were the responsibility of each engineer in his discipline. This does not mean, for example, that a civil engineer who has expertise in traffic signals or highway lighting, cannot seal the signal plans or specifications, as it is entirely possible that a civil engineer could have that expertise. If, however, a professional electrical engineer was used, he must sign and seal the portions for which he was responsible.

19.5 Information Requiring Certification

Engineering decisions are often made on the basis of support data furnished by non-engineering staff or offices. These data are to be certified as being obtained in accordance with official Department procedures. The following data are to have the noted certification attached when submitted for use in engineering related work.

19 5 1 18 KIP Equivalent Single Axle Loads

"I have reviewed the Traffic Forecasting Procedure, adopted by the Florida Department of Transportation, and have arrived at the projected 18 Kip loading volumes. I have found these to be consistent with the historical traffic data and other available information."

Name

Signature

Title

Organizational Unit

Date

19.5.2 Project Traffic (Traffic to be used for Design)

"I have reviewed the Traffic Forecasting Procedure, adopted by the Florida Department of Transportation, and arrived at the project traffic volumes I have found these to be consistent with the historical traffic data and other available information."

Name

Signature

Title

Organizational Unit

Date

Chapter 20

PLANS PROCESSING AND REVISIONS

20.1 Plans Processing

The plans package, when complete in the District, is mailed to the State Roadway Design Engineer's Office in Tallahassee. This is the first step in the plans processing for letting.

The Plans Processing Section is responsible for initiating the processing of each set of plans received in Tallahassee. Once the plans package has been checked for completeness by the Roadway Design Office, copies are sent to the Specifications Office and to Estimates for preparation of the official estimate. The reproducible are then sent to Reprographics for reproduction and copies are sent to the Federal-Aid Office for Plans, Specifications and Estimates (PS&E) package preparation and to the Contracts Office for preparation of the bidding documents and advertisements. The time frame, for processing the plans through Central Office to receiving bids, is approximately three months (two months to process and one month for advertising).

The processing done by each of these offices is discussed in more detail in the following sections:

20.1.1 District Processing

The designer or project manager should prepare a contract file either during design or before plans transmittal to Tallahassee. EX-I-20-A is a list of documents required for preparation of the contract file for the project. This list shall be attached to the front of a file containing all the applicable documents which must accompany the plans to Tallahassee. EX-I-20-B consists of statements, required by FHWA, concerning environmental re-evaluation and recommendations for construction inspection. These statements must be in the contract file.

The plans package transmitted to the Roadway Design Office in Tallahassee shall include, in addition to the contract file, the reproducible plans, a signed and sealed xerographic bond copy of the contract plans, the computation book and the Transmittal Letter (EX-I-20-C) All changes after the plans have been signed and sealed must be processed as a revision following the appropriate procedure given in section 20.2 of this volume.

20 1 2 Roadway Design Office

When the plans package is received by the Plans Processing Section in Tallahassee, they are logged in Any components produced in Tallahassee, i.e. structures plans, etc., are added in the package The contract file will be checked to be sure that all documents needed are included in the file If the file is incomplete, the District Design Engineer and the Production Management Office will be notified and no further processing will be done until the missing information is received

No plans checking is done in the Central Office. The checklist used for processing the plans package is shown in EX-I-20-D Some common errors that are caught as a result of normal processing include

- 1 Plans components listed on the Key Sheet are not included in package.
- 2 CES sheets are not numbered If more than one project is let under one contract, all CES sheets are not in the lead job or the CES's are not properly strung
- 3 Trainee manhours are not included
- 4 Box culvert data sheets are not included, if applicable.
- 5 FAP number is not correct
- 6 Number of sheets is incorrect

If all components are present, two half size copies are made of the signed and sealed Official Record copy One half size set and the contract file are taken to Specifications, the other half size copy and the comp book go to Preliminary Estimates, the Official Record copy is filed and the reproducible plan set is put in a temporary file

After the Specifications Office has finished processing the plans, while Preliminary Estimates finalizes the estimate, aerial photo sheets in the reproducible plans will be taken to Topographics and metal plates will be made of these sheets.

If the plans are not FA, the reproducible plans are taken to Reprographics for printing after the estimate is complete.

If the plans are FA, the reproducible plans are taken to the Federal Aid Office after the plates are made. The FA Office will make copies of plan sheets needed for FA programming and send the reproducible plans to Reprographics.

20.1.3 Specifications

The Specifications Office reviews the plans for the purpose of assembling the specifications package for the project. The Specifications engineer will review the typical section and plan notes relating to specs and check the summary of pay items for flagged items that require inclusion of Supplemental Specifications and/or special provisions. Permits, utility schedules and other necessary information are pulled from the contract file. Job specific and technical special provisions that were prepared and signed and sealed by the designer are reviewed. During this time the Specifications engineer has been building a "notebook" of supplemental specs and special provision paragraphs necessary to cover the work required by the plans. The specs package is assembled by word processors from the "notebook", proofread, signed and sealed, sent to Legal for review and then sent to Reprographics for printing.

The contract file is sent to the Federal-Aid Office.

Project # _____ CONTRACT FILE INDEX

WPI # _____

Number
Req'd Included
in File

- # Special Provisions/Supplemental Spec prepared by District _____
- ** CEI Recommendation _____
- # Incentive/Disincentive Justification Report _____
- # Incentive/Disincentive SP Recommendations _____
- # Special Work Conditions/Times, etc (Including night work) _____
- | * DISTRICT CONSTRUCTION "STATEMENT OF APPROVAL" OF TCP PLANS _____
- # CONTRACT TIME RECOMMENDATION
 Calendar Days Recommendation _____
- Special Acquisition Period _____
- * Preliminary Engineering Certification _____
- * R/W Certification _____
- # Utility Adjustment Schedules _____
- * Utility Certification _____
- Railroad Adjustment Schedules/wage rates, etc _____
- * Railroad Certification _____
- * Environmental Re-evaluation _____
- # Original Permit(s) & Copy of Env Permits Transmittal Letter _____
- # Occupancy Permits _____
- * Maintenance Agreement where appropriate _____
- Joint Project Agreements (J.P A) _____
- | # Pavement Composition Reports (Milling Projects > 500 TONS) _____
- | @ FA Project Certification to Standards _____
- | * Form - 37 (on-line form for Form FHWA-37, Federal Project Status Record) _____

This project was developed under Certification Acceptance procedures Yes___ No___

Name _____ Sig _____
Project Manager/Designer

* Required PS&E component for submittal to FHWA # Required on Plans to Tallahassee Date

| @ Required for projects exempt from FHWA oversight
EX-I-20-A

ENVIRONMENTAL RE-EVALUATION

ENVIRONMENTAL DOCUMENT

- 1 The project is a Categorical Exclusion under (check one)
 23 CFR 771 117(c) (Type 1) or
 "Programmatic" list approved by FHWA on 2/25/88 & amended 8/10/89
which was reevaluated in accordance with 23 CFR 771 129 on _____, and the
determination remains valid

- 2 The environmental document for this project was a (check one)
 Categorical Exclusion under 23 CFR 771 117(d) (Type 2) approved on _____,
 FONSI under 23 CFR 771 121 approved on _____,
 Final Negative Declaration approved on _____), or
 Final Environmental Impact Statement under 23 CFR 771 125 approved on
_____ A reevaluation in accordance with 23 CFR 771 129 was approved on

Name _____ Sig _____
Project Manager/Designer

CEI RECOMMENDATION

CONSTRUCTION ENGINEERING INSPECTION

In-house ___ or Consultant ___
Date shortlisted _____
Scheduled Execution* _____
Scheduled award of highway contract _____

Provide recommendation for resolution if highway contract award occurs before CEI contract execution (Be specific) _____

Does this project require any items to be furnished by the contractor which upon completion will be retained by the D O T for use outside the limits of this project? _____
If so, describe the items (e g Detour Bridge, Barrier Walls, Computers, Equipment, etc) _____

*This date must be prior to FHWA authorization

Name _____ Sig _____
Project Manager/Designer

DATE

*

TO Director, Office of Design
Attn: State Roadway Design Engineer

FROM District Director of Production

COPIES TO

SUBJECT **TRANSMITTAL OF PLANS** - Scheduled Letting Date Mo, Yr

WPI NO (GOES WITH)

LEAD STATE JOB NO

P E Job Number

* F A NO

DESCRIPTION

WORK TYPE/MIX

Other work to be performed by Contractor via J P A
Job # Description

Information contained herein has been checked and verified as needed. A plans package, suitable for processing, which consists of the following is forwarded under separate cover:
Reproducible Plans
Official Record plans set
Contract File
Computation Book

The affixed signatures below indicate and attest that:

1. The plans package is complete, free of known errors and has been reviewed for constructibility and bidability and is ready for processing to an advertisement status.
2. The contract file is complete as noted on the Contract File Checklist and accurate and contains all documentation required for the PS&E package.
3. The Official Record plan set represents a true copy of the reproducible plans set.
4. WPA and CES project descriptive information is correct for advertisement purposes.
5. Where appropriate, I certify that the project was designed in compliance with the Certification Acceptance Agreement dated July 30, 1990.

Name: Sig.
Project Manager/Designer

Name: Sig.
District Director - Production

*Place a block letter "F" (1" X 1") in the upper right corner for:
(1) I Funds completion, new or reconstruction projects > \$1M
(2) NHS (Off Interstate) new or reconstruction > \$5M

EX-I-20-C

PLANS PROCESSING PROCEDURE

W.P.I. No.: _____

State Project No.: _____

F.A. Project No.: _____

Processed by: _____ Date: _____

- _____ 1. Log plans in.
- _____ 2. Check Plans Transmittal Memo for signature of District Director of Production or the District Secretary.
- _____ 3. Check Contract File for list of contents.
- _____ 4. Check for structure plans and include in package if requested by District.
- _____ 5. Order 3 (4 if Turnpike) half-size copies.
- _____ 6. Check number of sheets in one half-size copy.
- _____ 7. Log reproducible and signed & sealed plans and comp book, if available, to file room.
- _____ 8. Deliver contract file and one half-size plan set to Specifications Office.
- _____ 9. Deliver one half-size plan set to Preliminary Estimates Office.
- _____ 10. Get plates of aerial photo sheets.

20 1 4 Preliminary Estimates

Estimates makes a run of the estimate as entered by the District. This locks the job so that no further changes can be made. Currently, the personnel in C O Plans Processing are the only people who can authorize an unlock.

Estimates then takes a brief look at the plans from a contractor's standpoint to see if there is enough information to bid the job. The Estimates engineer runs searches to check prices, calls suppliers, etc. to be sure he has the most current price information available. He checks the District's price overrides and contacts the District as necessary to resolve differences of opinion.

The Specifications are reviewed. Geographic location, maintenance of traffic, special permit conditions, etc. may weigh heavily in the overall estimate. After all issues are resolved, the job is transferred into the official estimate system. A copy of the estimate is sent to the FA office for use in the PS&E package. The Comp book is returned to Plans Processing.

20 1 5 Reprographics

Reprographics prints and assembles sufficient reduced size plan sets and specification packages for distribution and sale to interested bidders, material suppliers, etc. as requested. Distribution of half-size plan sets and spec packages is made to the offices of design, federal-aid, specifications, estimates, minority programs, and the appropriate District and Gainesville Testing offices.

Immediately upon printing both the plans and the specs, the Project Manager named on the key sheet will be furnished a complete set of half-size plans and complete specifications. The Project Manager will initiate a concurrent review for inconsistencies and will handle appropriate revisions as necessary to maintain the letting schedule.

When Reprographics has completed processing the plans, the reproducible plan set shall be returned to the design file room

20 1 6 Federal-Aid Office

If a project is federal-aid and was prepared under Certification Acceptance, the Federal-Aid Office certifies that fact to FHWA and requests authorization to advertise for receipt of bids and obligation of Federal funds. The PS&E package and appropriate program documents are transmitted to FHWA.

If the FA project was not eligible for CA, the Federal-Aid Office assembles the complete Plans, Specifications, & Estimates (PS&E) package. This package, along with appropriate program documents, is submitted to FHWA for review, approval, authorization to advertise for receipt of bids and obligation of Federal finance.

20 1 7 Production Management

The Contract Letting Coordinator, in the Production Management Office, tracks the progress of plans, etc. through the various processing stages. Progress is tracked via the "Plans Processing Report", which shows the ten week critical schedule a project must meet when being processed for a particular monthly letting. Outstanding issues that must be resolved to meet the processing schedule are highlighted in this report.

The Production Management Office and the Plans Processing Section of Roadway Design verify plans to Tallahassee. Projects with complete plans and contract file on time and no outstanding issues are immediately accepted for processing. During the ten week schedule, any problem which impedes processing is reported to the Contract Letting Coordinator. Projects having deficiencies which are not resolved by the Authorization Date/Advertisement Date are rescheduled for a later month. The Production Management Office produces and distributes a report which shows project deficiencies and production slippage.

Approximately three weeks before scheduled advertisement, a list of prospective projects for advertisement is circulated to the Comptroller and Contracts Administration. On the scheduled date of advertisement, Production Management is advised of Authorization by the FA Office and of funding the Comptroller and advises Contracts Administration as to which projects to advertise. Immediately upon advertisement, the Production Management Office produces and distributes a list of all projects currently and successfully advertised for the next letting.

20 1 8 Contracts Administration Office

After completion of processing by Preliminary Estimates, the Contracts Administration Office begins preparing the project advertisement and Contract Proposal. Upon receipt of Production Management's list of prospective projects, Contracts Administration prepares and prints the "Notice to Contractors", including approximate quantities from the CES. The legal advertisement is prepared and mailed to local newspapers. The first publication of the advertisement is twenty-eight days before letting and the next is seven days later.

Any revisions to the plans package during the advertisement period are handled as addenda to the contract advertisement.

Orders for plans and related documents pertaining to advertised projects are received by the Contracts Administration Office and sent to Reprographics to fill and process for mailing.

Bids are received, opened, recorded and read aloud on the scheduled day of letting.

20 1 9 Construction Office

The reproducible plans and the comp book(s) are sent to the District Construction office by the Central Office after the project is let. As

changes are made during construction, these changes are to be shown, in legible form, on the reproducible plan sheets. Xerographic bond copies of the revised sheet shall be signed and sealed by the Engineer responsible for the construction change and transmitted to the District Design office and to the Roadway Design Office in Tallahassee for insertion in the Official Record¹. At the completion of construction, all signed and sealed revisions should be on file in the central Office of Design's files. Final Estimates will use the Official Record plans as the "as-built" plans for final payment. Three years after payoff, the Official Record will be microfilmed.

¹These sheets will be inserted behind the Key Sheet and will **NOT** replace the original signed and sealed sheet.

20.2 Plan and Specification Revisions

Plan revisions are occasionally necessary to change reproducible plans after the Official Record has been signed and sealed by the responsible professional engineer. Any such change after signing and sealing is a revision.

Necessary revisions are the responsibility of the District, however, Central Office staff are available to assist with minor revisions. **All revisions shall be processed through the Plans Processing section in Central Office Design.** For major revisions the Plans Processing Section will coordinate the change or send plans back to the District and/or provide space in Tallahassee for the District to come and make the changes.

There are four possible 'Revision Stages' for any project.

- 1 **Signed and Sealed (SS)** Record prints or Technical Special Provisions are signed and sealed and are in the District.
- 2 **Signed, Sealed and Shipped (SSS) (Reproduction is not complete)** Record prints and Technical Special Provisions are signed and sealed and processing by the Central Office in Tallahassee has begun.
- 3 **Signed, Sealed and Shipped (SSSR) (Reproduction is complete)** The Plans and Specifications package is in Tallahassee, all processing is complete and plans and the Specifications have been reproduced.
- 4 **Let to Contract (LTC)** Project let to contract. Project may be under construction.

The revision process for each stage is discussed in the following sections.

20 2 1 Signed and Sealed (SS)

| Plans When plans are in this stage and changes are necessary, the following steps will be
| required:

- | 1 Once the plans are in the District office, the District Project Manager/ Coordinator
| must concur in a revision by a consultant. The responsible professional engineer
| making the plans revisions shall complete the revision block on all revised sheets and
| sign and seal revisions as noted in Chapter 19 Where no revision block exists (key
| sheets, pay items sheets etc), the revision date, brief description of revision and the
| initials of reviser shall be noted on the sheet. (Lower right for key sheets and along
| the top of computer generated pay item sheets)
- | 2 For in-house projects, the designer must follow the revision process outlined in
| Chapter 19
- | 3 No revision letter is required for plans revised at this stage

| Specifications When Technical Special Provisions are in this stage and changes are
| necessary, no revision letter is required

20 2 2 Signed, Sealed and Shipped (SSS) - Reproduction is not complete

Plans When plans are in this stage and revisions are necessary, the following steps will be required

- 1 Unless revisions are being made in Tallahassee, plans must be requested to be returned to the District for both in-house and consultant plans. When consultant-prepared plans are returned for revision, the District will be responsible for sending plans to the Consultant.
- 2 If plans are federal-aid and are not eligible for CA, FHWA concurrence must be obtained prior to making major revisions.
- 3 The District Design Engineer or Project Manager/ Coordinator must concur in revision.
- 4 The responsible professional engineer making the revision shall complete the revision block on all revised sheets and sign and seal revisions as noted in Chapter 19. Where no revision block exists (key sheets, pay item sheets, etc.), the revision date, brief description of revision and the initials of revisor shall be noted on the sheet. (Lower right for key sheet and along the top of computer generated pay item sheets.)
- 5 A revision letter is required (see Exhibit I-20-E).
- 6 Whenever a revision involves pay items and/or quantities, the CES will be unlocked for 24 hours once the revision letter is received. All quantities, pay items, computation books, etc., shall be updated as part of the revision.
- 7 The roadway key sheet shall have all the revisions noted in the lower left hand corner of the sheet. See Exhibit I-20-F. (A revision to the Key Sheet is noted on the right side of the sheet.)
- 8 When the project contains other components such as signing and pavement markings or signalization plans, the revisions shall be made on the plan sheets, and all the revisions, along with the other component revisions, noted on the lead key sheet only.
- 9 The revision package submitted to Tallahassee shall include the revised reproducible plan sheets, one signed and sealed bond copy of the revised sheets, two 11" x 17" copies of the revised sheets and the revision letter.

Specifications When Technical Special Provisions are in this stage and revisions are necessary, no revision letter is required.

20.2.3 Signed, Sealed and Shipped (SSSR) - Reproduction is Complete

Plans When plans are in this stage and revisions are necessary, the following steps will be required:

- 1 Unless the revisions are being made in Tallahassee, plans must be requested to be returned to the District for both in-house and consultant plans. When consultant-prepared plans are returned for revision, the District will be responsible for sending plans to the Consultant.
- 2 If plans are federal-aid and are not eligible for CA or if authorization to proceed with advertisement has been received, FHWA approval must be obtained prior to making major revisions.
- 3 The District Design Engineer or Project Manager/ Coordinator must concur in revision.
- 4 The responsible professional engineer making the revision shall complete the revision block on all revised sheets and sign and seal revisions as noted in Chapter 19. Where no revision block exists (key sheets, pay item sheets, etc.), the revision date, brief description of revision and the initials of revisor shall be noted on the sheet. (Lower right for key sheet and along the top of computer generated pay item sheets.)
- 5 A revision letter is required (see Exhibit I-20-E).
- 6 Whenever a revision involves pay items and/or quantities, the CES will be unlocked for 24 hours once a revision letter is received. All quantities, pay items, computation books, etc., shall be updated as part of the revision.
- 7 The roadway key sheet shall have all the revisions noted in the lower left hand corner of the sheet. See Exhibit I-20-F.
- 8 When the project contains other components such as signing and pavement markings or signalization plans, the revisions shall be made on the plan sheets and all the revisions, along with the other component revisions, noted on the lead key sheet only.
- 9 One signed and sealed bond copy of the revised sheets, and a copy of the revision letter shall be sent to Central Office Design to update the Official Record.

- 10 If time remaining until letting date is fifteen working days or less by the time the revision will reach the Central Office, processing of the revision must be approved by the Director, Office of Design and the Director, Office of Construction
- 11 No revisions are allowed within five working days of letting. After this date, the project must be let as is or withdrawn from the letting, unless otherwise approved by the State Highway Engineer and the District Secretary. Withdrawal of the plans package after advertisement requires the approval of the State Highway Engineer and the District Secretary.

Specifications All revisions that deal with Specifications only shall be sent to the State Specifications Office, Attn: State Specifications Engineer, Mail Station 31. Items 10 and 11 above also apply to the specification revision process.

20 2 4 Let to Contract (LTC)

Plans When changes to the plans are required after the letting, the revision process is as follows

- 1 The District Design Engineer or Project Manager/ Coordinator and the responsible professional engineer should be contacted to concur in revision
- 2 If plans are subject to FHWA oversight, FHWA approval must be obtained prior to making revisions
- 3 The responsible professional engineer making the revision shall complete the revision block on all revised sheets and include in the description that the revision is for a Supplemental Agreement, engineering change, etc The revised sheets shall be signed and sealed as noted in Chapter 19. Where no revision block exists (key sheets, pay item sheets etc), the revision date, brief description of revision, and the initials of reviser shall be noted on the sheet (Lower right for key sheet and along the top of computer generated pay item sheets)
- 4 All pay item sheets, quantity sheets and tabulation of quantity sheets, shall have the original quantity marked through, not erased, and the revised quantity written above, below or beside the old The computation book must be updated
5. The roadway key sheet shall have all the revisions noted in the lower left hand corner of the sheet and note the revision as being for Supplemental Agreement, engineering change, etc See Exhibit I-20-F.
- 6 When the project contains other components such as signing and pavement markings or signalization plans, the revisions shall be made on the plan sheets and noted on the roadway key sheet only

7 A letter addressed to the District Construction Engineer must accompany signed and sealed bond copies of the revised sheets to the District Construction Office. The letter will address the reason for the revision, who requested the revision, who approved the revision, and, when applicable, if FHWA has concurred. All existing pay items that are affected must be listed with original and revised quantities. Deleted or added pay items must also be shown. Copies of the letter will go to the District Secretary, District Design Engineer, FHWA, State Construction Office and State Roadway Design Office (see Exhibit I-20-G for example letter). The District Construction Office shall send signed and sealed bond copies of the revised sheets to the District Design Engineer, to the Responsible Professional Engineer, if an outside firm, and to the State Roadway Design Office, Attn: Plans Retention, MS 32.

Specifications When revisions to the specifications package are required after the letting, the following process will apply:

1. The revision shall be signed and sealed by the professional engineer making the revision.
2. A letter addressed to the District Construction Engineer must accompany signed and sealed revised specs to the District Construction Office. The letter will address the reason for the revision, who requested the revision, who approved the revision, and, when applicable, if FHWA has concurred. All existing pay items that are affected must be listed with original and revised quantities. Deleted or added pay items must also be shown. Copies of the letter will go to the District Secretary, District Design Engineer, FHWA, State Construction Office and State Roadway Design Office (see Exhibit I-20-G for example letter). The District Construction Office shall send signed and sealed copies of the revised specs to the District Design Engineer and to the State Specifications Office, Attn: State Specs Engineer, MS 31.

20.2.5 Complete Project Revisions

If an entire project is requested to be returned to the District for revisions during or after Central Office processing, the following steps will be required for resubmittal

- 1 The plans and computation books shall be resubmitted with a new contract file containing those items which need to be updated
- 2 The lead Key Sheet shall be noted "Plans Completely Revised" in the lower left corner and dated The revision block on each sheet that is revised shall be completed by the revisor and dated
- 3 A revision letter stating that a complete reprint is necessary shall accompany the transmittal package
- 4 A copy of each plans sheet that is revised shall be signed and sealed in accordance with Chapter 19 The signed and sealed sheets will be included with the Record Set in the Central Office

20.3 Automated Plans (CADD)

Until the contract is awarded, the revision process will be the same for manual or CADD produced plans, except that if the plans are automated the revisions must also be automated to be compatible with the future plans retention system Revisions made during construction need not be automated

DATE July 22, 1988
TO John Doe
FROM Jack Smith
COPIES TO Jimmy Brown, Charlie Black, Frank White
SUBJECT State Project 00000-0000
Meridian Road Revisions

Due to a commitment by the Department, the retention area #1 right of Station 75+87 has been revised to provide additional storage. These changes are indicated on sheets

5 Summaries of Earthwork and Sodding revised
32 Excavation in SW corner indicated
83 Excavation indicated

The City's project on John Knox Road has not been let. Therefore, the following revisions are required, with changes indicated on sheets

13 Existing revised, exception removed
43 Existing revised
S-5 Existing revised, exception removed

We have also corrected an error on Sheet 5 on the Summary of Underdrain. The plans have been changed to show 300 LF between Station 60+00 to 72+00, the total has been revised to 6039 LF

The above revisions have changed the Quantities for the following pay items

EX -I-20-G

1 of 3

John Doe

July 27 1988

Page 2

<u>ITEM</u>		<u>ORIGINAL</u>	<u>NEW</u>		
<u>NO</u>	<u>DESC</u>	<u>QUANTITY</u>	<u>QUANTITY</u>	<u>INCREASE</u>	<u>DECREASE</u>
120-1	Reg Exc	1412 CY	3,399	1,987	
300-1-2	Bit Mat'l (Tack)	6334 gals	6,545	211	
300-1-6	Bit Mat'l (St)	6268 gals	6,522	254	
312-70	Cover Mat'l	20893 SY	21,738	845	
440-1-10	Underdrain Type 1	8239 LF	6,039		2,200
520-1-10	Curb & Gutter	14,324 LF	14,515	191	
570-5	Fertilizer	1 2 Ton	1 4	0 2	
570-9	Water	13.535	15.885	2 350	
575-1	Scdding	13,103 SY	15,377	2,274	
5331-2	Type S	2,799 1	2,830.8	31 7	
5332-2-7	Type II	2256 7 TN	2,332.7	76 54	
5337-1-5	Friction Course	34,386.0 SF	35,231	845	
706-1-12	Ref Pav't Marker	966 EA	997	31	
711-4	Directional Arrows	58 EA	59	1	
711-6-181	Traffic Stripe (18")	961 LF	1029	68	
711-6-241	Traffic Stripe (24")	562 LF	639	77	
711-8-41	Traffic Stripe (4")	5 713 NM	5 864	0 151	

EX -I-20-G

2 of 3

John Doe
July 27, 1988
Page 3

In addition to these changes, the project number has been changed on sheet 25, 27, and S-2, on Sheet 28, signatures have been added

It has been requested by Property Analysis Corporation that the outfall right of Station 75+87 be shifted. Mr. Miller advised me the City is in agreement with this shift of right-of-way for the outfall. Since the Department has a joint project agreement with the City to construct the outfall of Station 75+87, Stuart Christmas advises me that the agreement should be modified. Mr. Christmas is reviewing the agreement to determine if the City can be held responsible for all additional cost caused by the change in the outfall location. These plan revisions will be transmitted at a later date.

By copy of letter, I am requesting that Frank White coordinate any revisions for permits.

If you have any questions, please call me at XXX-XXXX.

EX -I-20-G

3 of 3

Rev 09/05/90

I-20-26 0

Chapter 21

CONSULTANT PROJECT MANAGEMENT

21.1 General

The Florida DOT may elect to use a consultant to provide all or a portion of the engineering services required for a transportation project. Guidelines for use in acquiring and managing such a consultant are contained in the Florida DOT Project Management Guidelines. ~~Revised manual is available~~ The revised manual is now available

21.2 Project Definition

Once the project is included in the Florida DOT's Adopted Five Year Work Program and a decision has been made to acquire professional services, the work to be performed by the consultant must be carefully defined and stated in Project Concept Reports and Scopes of Work.

21.2.1 Project Concept Report

The Project Concept Report serves the function of identifying project goals and constraints. This document would precede and be supplemental to the normal scope of services and would identify and define existing conditions, issues, concepts and criteria. It then could provide the basis for the detailed scope of consultant services.

21.2.2 Scope of Services

The Scope of Services document is the cornerstone of the consultant procurement process. This document specifically outlines the features of the project in sufficient detail to form the basis of the technical and price proposals to be submitted by the consultants. It also forms the basis for the Florida DOT's evaluation of these proposals and for the preparation of the Florida DOT's man-hour estimates for each work component. Subsequently, it becomes the primary component of all contract agreements. This document should itemize all aspects for which the consultant is responsible and all aspects for which the department is responsible.

21.3 Consultant Acquisition

Consultant acquisition is accomplished according to established rules and procedures and includes; requests for proposals, proposal evaluation, negotiation and contract execution. Each of these are further explained in the Project Management Guidelines and in the procedures of the Contractual Services Office ~~the procedures~~.

21.4 Technical Management

Technical Management consists of the application of proper planning, monitoring and control techniques applied throughout the life of the project. This process is used to guide the project through the many technical disciplines and their interfaces in order to ensure timely interaction and successful completion. Proper documentation of all deliverables as required by the scope of services as well as every decision reached as a result of inquiry or coordination meetings is required. For further explanation, consult the Project Management Guidelines.

21.5 Contract Administration

Contract administration is required to ensure that the terms of the consultant contract are met and to verify that any modifications to the contract, such as time extensions and supplemental agreements, are necessary and conform to the original agreement. Periodically, throughout the life of the contract, consultant progress will be measured and documented for the purpose of providing progress payments. Ultimately, all of the above is used as a basis to grade the consultant upon completion of the contract. Each of these areas is covered in the Project Management Guidelines and by existing Contractual Services Office's procedures.

21.6 Scheduling and Coordination

A major objective of project management is to determine the relationship of different tasks to each other, and to schedule and control these tasks so that the project is carried out logically and efficiently. In accomplishing this, the project manager should include status meetings as a routine part of the project schedule. The meetings should be held on a periodic basis, usually monthly. The purpose of these meetings will be to discuss the progress of the project and to make decisions for the remainder of the services. Functional area managers as well as ^{representatives of} other agencies should attend as required to share information and to develop an understanding of how their activities blend into the overall project objectives. Further discussion of these areas can be found in the Project Management Guidelines.

21.7 Consultant Use of Department Computer Programs

The Department has various computer programs which are of great value to the designer. A listing of available programs should be included in the scope of services. Consultants may request the use of appropriate programs through the FDOT Project Manager/Coordinator.

Various CADD files are also available for use by the consultant on projects for the Department. Information and authorization for use of these files may be obtained from the District CADD Coordinator.

Chapter 22

ARCHITECTURAL PLANS

22.1 General

Designs for building construction projects are normally based on square footage requirements as established by the Florida DOT's owner/user unit and the District Fixed Capital Outlay coordinator. Square footage requirements shall be in compliance with the Department of General Services space criteria (Form BPM 4056 R2-86) and based on anticipated staffing and use. The size of rest area buildings is determined by the number of toilet fixtures required. The number of toilet fixtures and parking places required at the rest area are computed based on the 20 year design traffic of the highway. These computations are done on a Facilities Computation from (Ex-I-22-G) and become a part of the project file.

The construction of all new Florida DOT buildings and renovations or additions to existing buildings require plans and specifications signed and sealed by a Licensed Florida Architect (F.S. 481).

Consultant contracts for architectural design of buildings in the Districts shall be administered and managed in the District office. A very detailed project definition and scope of services is essential to a successful architectural design contract.

Architectural plans often include other engineering plans. Typically, this requires the acquisition of engineering subconsultant(s) to perform those services for which the architect is not qualified under F.S. 481.

The architectural services required for the design of a building are generally done in four phases as listed below:

1. Schematic Design Phase
2. Design Development Phase
3. Contract Documents Phase
 - a. Construction Plans
 - b. Specifications & Special Provisions
 - c. Construction Cost Estimate
4. Construction Phase
 - a. Shop Drawing Review
 - b. Scheduled Periodic Construction Site Visits
 - c. Review of Contractor Pay Requests
 - d. Substantial and Final Inspections

Requirements and criteria for the four phases are addressed in this chapter.

22.2 Codes, Rules and Regulations

A. Codes, Rules and Regulations

1. Certification: The Design Professional shall provide with each of his formal design review submissions a listing of all codes and regulations which are applicable to the project. He shall further certify over his signature, that his design documents fully comply with those codes and regulations.

B. Applicable Codes, Rules and Regulations

1. Building Codes: The design professional should use the following codes as applicable. Refer to Chapter 13D-17, Florida Administrative Code and Sections 553.43 and 553.73, Florida Statutes.

The Standard Building Code applies, current edition. Dade County does not use the Standard Building Code.

2. Fire and Life Safety: All requirements of the National Fire Protective Association, including the Life Safety Code (NFPA 101), current edition, shall apply.
3. Electrical and Plumbing Codes: Florida Electrical Code Part II, Chapter 533.19, Florida Statutes (National Electrical Code, current edition). NFPA 90A, 1978, air conditioning and ventilation.
4. Handicap Code: All requirements of the "Uniform Federal Accessibility Standards", and ANSI A117.1, "Standards for Making Buildings and Facilities Accessible to, and Usable by, Physically Handicapped People", current editions, shall apply.

5. State Requirements: The following agencies have been charged by law with the responsibility of protecting the public health, safety and welfare in the following areas:
- a. Fire Protection Rules and Regulations, State Fire Marshal's Office.
 - b. Rules of Florida Industrial Commission, Department of Commerce, Division of Labor, Bureau of Workman's Compensation enforce OSHA Building Standards CFR-291926.
 - c. Florida Hotel and Restaurant Division, Statutes and Rules, Department of Business Regulation.
 - d. Rules and Regulation of the Division of Health, Department of Health and Rehabilitative Services.
 - e. Rules for the Physically Disabled, Chapter 13D-1, Department of General Services.
 - f. Florida Electrical Code, Part II, Chapter 533.19, Florida Statutes, Department of General Services.
 - g. FLEET, Florida Lifecycle Energy Evaluation Technique, Chapter 255.251, Florida Statutes and Chapter 13D-10, Florida Administrative Code, Department of General Services.
 - h. Energy Efficiency Code for Building Construction, Chapter 553, Florida Statutes.

In every case where the regulations and rules of the above agencies apply, they shall be complied with in the development of the project.

C. Approval

It is the responsibility of the Design Professional to determine which other authorities have jurisdiction and assure that the development of the project is fully coordinated with these agencies and that their requirements are accommodated in the documents so that all approvals can be readily obtained. This coordination starts with the schematic design and must be completed prior to taking of bids, so that delays in start of construction do not occur.

1. Sewage

Connections or facilities for discharge of 2,000 gallons or less in 24 hours requires submission of DER-14-4 to the Florida Department of Environmental Regulation or other designated permitting agency. See DER 17-3, Water Quality Standards and DER 17-16, Waste and Domestic Wastewater Plants.

2. Zoning and Comprehensive Planning

All local governments, as required by Chapters 163.315(5), 163.3165(8), 163.3194(1) and 163.3211 Florida Statutes, have or will adopt comprehensive plans and zoning. The State, as is any Owner, is obligated to develop their property in accordance with the adopted plans or codes and obtain reviews and approvals including variances as required. The Architect should begin this coordination early in the design process and carry it through to the end to ensure that the project meets all local requirements and to resolve conflicts as they arise.

3. Use and Development Permits

Certain use and development permits are required by local, State and/or federal agencies prior to commencement of construction. These permits, covering such items as sewage, water, air quality, etc., must be obtained prior to release of documents for bidding. It is the responsibility of the Architect/Engineer to identify each such permit and to apply for these on behalf of the Owner.

4. Fire Department

The Design Professional is expected to work closely with the Fire Department serving the project area, and to accommodate their fire fighting methods, equipment, hose threads, etc.

5. Flood Prone Areas

Every site plan shall be evaluated for flood hazard and meet the minimum building requirements mandated by the National Flood Insurance program. If the local permitting office can not provide the necessary information, a flood hazard evaluation may be requested from: Mr. Howard Glassman, State Assistance Office, Federal Flood Insurance Program, 256 Howard Building, 2571 Executive Center Circle East, Tallahassee, Florida 32301.

6. FLEET

Every building over 5,000 square feet in area and leased space of over 20,000 square feet is subject to the provisions of Chapter 255.251, Florida Statutes and Chapter 13D-10 Florida Administrative Code. This program is administered by the Technical Evaluation Section, Bureau of Construction, Department of General Services.

22.3 Standard Document Requirements

A. Drawing Size

All drawings shall be ^{24" X 35" or 36"} ~~20" X 34" (B size)~~. For border size and other sheet format information see paragraph 1.4 (II-1-3.0) of this manual.

B. Specification Size

All specifications and special provisions shall be printed in an 8 1/2" by 11" format, bound on the left hand side in a permanent type binder.

C. Lettering

All lettering shall be vertical uppercase and must be plain, free of adornment, and legible; minimum size shall be 1/8" when reduction is proposed. All symbols shall be clearly separated from one another and from adjacent lettering or lines.

D. Scales

Scales should be located directly under the title of each plan, elevation, section, detail, etc. The scale should be given as an example of the object drawings, i.e., Scale: 1/8" = 1'-0".

E. Title Blocks

The title block on each drawing shall appear in the lower right hand corner along the right margin. It shall contain information as delineated in Ex-I-22-A & I-22-B.

F. Title Sheet, Pages and Bindings

Title sheets, title pages, and binding of documents shall comply with the provisions of Ex-I-22-C (text) & I-22-D (layout of drawing, key sheet).

G. Signature and Seal

All final reproducible contract documents submitted by the Design Professional shall bear the appropriate professional signature. The Architect shall submit three originally signed and sealed sets of prints of the plans and specifications to serve as record sets of contract documents.

H. Drawing Arrangement

The drawing shall be arranged by subject category.

1. Key Sheet
2. Civil
3. Architectural (including site plan)
4. Structural
5. Mechanical
6. Plumbing
7. Electrical

I. Specification Organization

Specifications shall be organized in accordance with the format of the Uniform Construction Index as adopted and established by the Construction Specifications Institute (CSI) or The American Institute of Architects (AIA).

22.4 Schematic Design Phase Requirements

- A. A Schematic Design Phase shall be required as a part of all architectural design services.
- B. The Schematic Design Phase shall include, as appropriate, but not be limited to:
 - 1. A narrative description of the design and construction concepts and how they are responsive to the project requirements.
 - 2. A plan showing how the project fits into the master plan for total facility development.
 - 3. Site plans showing existing and proposed roads, circulation elements, utility systems, plantings and special site features.
 - 4. Studies and reports relative to the site and its topographical, ecological, botanical and other features contributing to the solution or requiring significant alteration of the existing site.
 - 5. A description of existing zoning and other site conditioning factors restricting development and their solutions or recommendations for resolving them.
 - 6. Floor plans, elevations, building sections, and sketches as necessary to adequately present the concept.

7. If the project is an addition, or is otherwise related to existing buildings on the site, the plans shall show such facilities and their general arrangements and relationships.
8. The general description analysis, and sketches, where applicable, of the design and construction concepts shall be provided for architectural, structural, plumbing, fire protection, mechanical (HVAC), communications, electronics and electrical systems.
9. Mechanical and electrical descriptions, including computerized building management systems, shall indicate proposed systems and equipment in suitable detail, and be accompanied by a complete schematic format to enable an energy design submission of FLEET in compliance with Florida Energy Conservation in Building Act. See Volume III of the Energy Conservation Guide.
10. Specific layouts of complex areas such as mechanical rooms, computer rooms, operation areas and conference rooms.
11. Description of the features and provisions provided in the facility for use by the handicapped.
12. Details as required.
13. A statement of the provisions that will be taken to satisfy acoustic requirements.

14. Outline specifications, using CSI/AIA format.

15. An identification and presentation of code requirements. Provide a review of codes having a bearing on the project and report specific problems encountered in conforming to these codes as well as solutions, waivers or variances, if any, being pursued or required.

22.5 Design Development Phase

22.5.1 General

Upon approval of the Schematic Design Phase and receipt of the Notice to Proceed into the Design Development Phase, the Design Professional should proceed with the amplification and refinement of his advanced schematic design study to comprehensive Design Development documents.

22.5.2 Development Procedures

The Architect should, with the concurrence of the Florida DOT, schedule necessary conferences and meetings with the Florida DOT and other affected parties, to ensure that the project is developed in a coordinated and optimum manner.

22.5.3 Reviews

A. General

The Design Professional shall submit the Design Development documents to the Florida DOT and other agencies (those agencies having jurisdiction or approval requirements) as designated by the Florida DOT's Project Manager and with his concurrence, schedule a Design Development review conference. At that conference, the Design Development shall be presented by the Architect/Engineer and be explained in depth and detail as appropriate. The Architect shall provide minutes of this review conference to all attending parties.

The Design Professional shall confer with the Florida DOT and other persons attending this conference, responding to all questions and comments. If the comments are critical and require response prior to proceeding with the next phase of the project, it shall be the responsibility of the Design Professional to submit such response as soon as possible.

B. Conceptual Approval

If the development is found to be acceptable by those present, the Florida DOT may issue conceptual approval of the Design Development Phase in order that the Architect may proceed with the development of the next phase.

22.5.4 Submission Requirements

A. General

The Architect shall present sufficient documentation in the form of drawings, specifications, design criteria, and cost factors. This shall include working sketches and models as necessary to fully explain and establish the scope of the project and all of its particulars so as to be readily understood by lay and technical reviewer. The design criteria shall supplement the Design Development drawings, specifications and cost estimates. It shall be a presentation of facts sufficiently complete to demonstrate that the concept of the project is fully understood and that the subsequent design details in their presentation in the final plans and specifications will be on a sound professional basis.

The criteria, the basis for design, may be in any form or any combination of forms. It should be for all intents and purposes a copy of the working data upon which the design is based. Sketches, calculations, notes, economic analysis and any other pertinent data shall be presented as the design criteria. The information to be presented consisting of drawings, specifications, cost estimates and design criteria, should be complementary and should include, but not be limited to, the categories described.

B. Site

The information pertaining to the site and its development should be presented as an entity passing across professional disciplines. It should include, but not be limited to:

1. Information Data

Location plots, property and topographical surveys, subsurface boring, lots and plans, ecological and botanical surveys, and other appropriate information.

2. Master Plan

A copy of the Master Plan indicating the location of the project and total scheme, if applicable.

3. Environmental Considerations

Necessary design data, specifications, and cost estimates for preservation, dust, erosion,

sedimentation and runoff control, where applicable, as an integral part of the design and construction project. Such controls will be limited to the areas involved in the construction operation and those required by applicable ordinances, rules, laws, etc. Environmental control will not be confused with landscaping. The information provided will include statements regarding the type of treatments selected, the affected areas, and the reasons for the selection of the type of controls chosen.

4. Grading and Site Development.

a. Site Construction

All permanent features to be constructed on the site.

b. Roads, Walks, Paths and Parking

The data provided, in addition to the proposed development, should include a statement of the general soil conditions with a brief outline of the soil exploration and testing performed as related to the development of roads, etc. The type and volume of traffic, controlling wheel loads, classes of surfacing under consideration with justification for same, and any deviation from criteria fitness for those classes should also be included.

5. Utility Services

All existing and proposed utility services including runs, locations capacities, sources, characteristics, materials and installation methods should be fully described.

a. Electrical

- (1) A statement relative to the adequacy of the primary supply at the point of takeoff. If the primary source is inadequate, state measures proposed to correct the deficiency.
- (2) The electrical characteristics of the power supply to the site or area, including circuit interrupting requirements, and voltage regulations.
- (3) An estimate of the total connected load and resulting kilowatt demand load by applying proper demand and diversity factors if a group of loads is involved.
- (4) The basis for selecting a primary and/or secondary distribution voltage.
- (5) The type, size and location of conductors.

- (6) Statements describing the pertinent standards of design, such as voltage drop, physical characteristics of overhead or underground circuit, types of lighting units and lighting intensities.
 - (7) The type and adequacy of telephone, signal, fire alarm and other communication systems, including a statement as to the number of spare telephone conductors available and spare capacity on fire alarm circuits.
 - (8) Emergency power systems.
- b. Fuel Distribution and Storage Information provided shall include for the following types:
- (1) Gas
 - (a) Statement of type, location of take-off from supply, and available pressure.
 - (b) Statement of type and material for pipes and valves.
 - (2) Liquid Petroleum Products
 - (a) Statement of unloading facilities, such as dock, tank car, or truck.

- (b) Description of the type of system and proposed features.
- (c) Statement of the basis for storage capacity, rate of pumping and number of dispensing outlets.
- (d) Description of power supply and power requirements.
- (e) Selection of type of materials for pipes, tanks and valves.

c. Steam Distribution

Data provided should include points of connection, pressure, size, material and method of installation of proposed piping.

d. Central Chilled Water and Refrigeration

The information provided should include sizes, material and method of installation of proposed piping.

e. Domestic Water and Fire Protection

- (1) Source, minimum and maximum pressure at each building and in the system, and an explanation of the existing system covering particularly the type, capacity, condition, present water use, and unsatisfactory elements of the

component parts.

- (2) A statement of the type of construction proposed, materials for water mains, or wells, etc.
- (3) The distribution system, a statement of design, domestic and fire flow usage of well pressure, elevation differential, and the designer's basic estimate of tentative pipe sizes.
- (4) A statement of tentative sizes, elevations, capacities, etc. as can be readily determined without long computations or design considerations for reservoirs, treatment units, pumping plans, well pumps and such units.

f. Sewers and Sewage Disposal Systems

Information provided shall include:

- (1) An explanation of existing systems covering particularly the type, capacity, conditions, present flow and unsatisfactory elements or components.
- (2) The interpretation of the degree of treatment necessary by field requirement and units necessary for treatment.

- (3) A statement of the design factors with present design population per various units for the sewage treatment plant.
- (4) Statements of materials to be used for the sewage system, sewage collection system and the sewage treatment plants.
- (5) Means of effluent disposal.

g. Storm Drainage

- (1) An explanation of the existing system covering particularly the type, capacity, condition, and unsatisfactory elements or components.
- (2) A statement of the type of construction proposed, material, etc.
- (3) A statement of the design requirements and tentative pipe sizes.

h. Electronics and Instrumentation

As related to the site, the following information shall be provided:

- (1) System engineering concepts.
- (2) Site and location considerations.

- (3) Antenna requirements such as types, separation, height, aircraft clearance, and area requirements.
 - (4) Site communications and control linkages.
 - (5) Electronic security considerations.
- i. Cathodic Protection (in addition to the proposed development provided):
- (1) Results of soil resistivity measurements.
 - (2) Variations in soil makeup.
 - (3) Soil moisture content and normal seasonal variations.
 - (4) Results of temporary cathodic protection tests, if any.
 - (5) Results of structure to soil potential measurements where protection is to be provided.
- j. Lawn Sprinkling Systems: Provided tentative layouts, material, sizes, etc.

6. Fencing

Type, height and justification for fencing.

7. Landscaping

Plant species, size and layout.

8. Lateral and transverse sections through the site shall indicate development of the site, when necessary, due to substantial elevation changes or circulation at more than one level.

9. Any special consideration pertinent to the site and its development.

C. Buildings

Each building should be fully described. The information should include, but not be limited to:

1. Architectural

- a. The plan of each floor showing furniture, equipment and any other use-determining factors.
- b. Area recap and square footage should be indicated for each floor area and for the projects in total in comparison to that required by the program.

- c. Exterior elevations, delineated and shadowed, giving floor elevations at each level and showing finish materials.
- d. Transverse and lateral sections through the building, indicating heights, vertical circulation, and relationship. The finished floor elevations of each level should be given.
- e. Wall sections and wall details necessary to indicate the methods of construction and to determine the overall values achieved as required by the Florida Energy Code.
- f. Schedules indicating finishes and equipment in specific areas.
- g. Provide color schemes and schedules for all areas interior and exterior. Material and sample pallets shall be provided.
- h. The class of construction, occupancy, openings, and fire ratings for hall doors and other such openings shall be provided or indicated.
- i. Provide large scale plans describing complex, intensely equipped or furnished areas, and areas needing clarification.

- j. Provide a list of all safety equipment, including costs that have been included in the project.
 - k. Sketches as necessary to portray the design concept. The formal architectural renderings, if required by the Contract for Professional Services, should be submitted after approval of the Design Development documents.
 - l. A description of the materials used for all major items of construction.
 - m. Other information considered necessary for the development of the program or explanation of the design.
2. Structural
- a. A description of foundation conditions, types of foundations to be used, the method by which the allowable bearing value is to be determined, and the maximum allowable bearing capacity for the foundation.
 - b. Statement as to the type of construction adopted and reasons therefore, with capacities, dimension, or other size criteria.

- c. Preliminary floor plans showing framing members and column sizes indicating special design features and noting floor elevations. The description of structural floor system proposed with length and spacing of principal members, dimensions etc.
 - d. The description of structural roof system proposed with principal members, dimensions etc.
 - e. Provide structural building sections, transverse and longitudinal, indicating vertical relationships and headroom.
 - f. Note limited load carrying capacities and statements of live loading to be used including floor loads, winds, earthquake etc., with justifying data.
 - g. Provide calculations and design criteria when requested.
 - h. A statement of any special considerations that affect the design.
3. Heating, Ventilation, Air Conditioning (HVAC)
- a. Provide floor plan showing equipment layouts and single line layouts of duct work.
 - b. Provide sections showing equipment and locations of duct work.

- c. Energy Conservation: Provide calculations and criteria in the form and detail required to fully comply with the requirements of the Energy Conservation Manual and the requirements as set forth by the Energy Conservation Project Director.

- d. Provide full description of automated management systems proposed for use, including current and future capabilities.

Heating System

- (1) Statement of indoor and outdoor design temperatures and "U" factors for walls, ceilings, floors, etc., to be used in design.

- (2) Heating medium, such as steam, hot water, gas or electric.

- (3) Type of heating system such as convector baseboard, forced warm air, unit heaters, etc.

- (4) Types of building temperature control; such as electric, electronic or pneumatic, and indicate outdoor anticipator or indoor thermostat.

- (5) Location and type of heating plant.

- (6) Brief explanation of the basis for selection of type of fuel, including an economic comparison with other fuels.

f. Ventilation

- (1) Statement of whether gravity or mechanical system.
- (2) Number of air changes per hour in various areas.
- (3) Ventilation air quantity during heating season and how acquired.

g. Air Conditioning

- (1) Provide a brief description of the air conditioning system proposed, such as factory assembled or built-up system; number of zones, if applicable; or unit type, chilled water system, or direct expansion, type of refrigerant, etc.
- (2) A statement of areas to be air conditioned.

-
- (3) Statement of inside temperatures and relative humidities, if applicable, outside wet and dry bulb design temperatures, "U" factors for the type of construction proposed and a statement of the economics of applying insulation and/or sun shades.
 - (4) Description of equipment to be used such as reciprocating or centrifugal compressor, condensers, air handling equipment, duct system, piping, etc.
 - (5) Type of building temperature control system such as electric, electronic or pneumatic and sequence of operation.

h. Evaporative Cooling

- (1) Statement of areas that are to be evaporatively cooled.
- (2) Description of equipment to be used.
- (3) Provide any other data as deemed necessary.

4. Electrical

- a. Indicate electrical service entrance characteristics, transformer requirements, etc.

- b. Indicate electrical characteristics such as phase, voltage, number of wires, etc., of each circuit. Provide a breakdown of the estimated connection load to show:
- (1) Lighting and convenience outlet load.
 - (2) Power load for building equipment such as heating, air conditioning, etc.
 - (3) Loads for special operating equipment such as compressors, welders, pumps, motors, etc., and for power receptacles being provided to energize special equipment. Apply an appropriate demand factor to each to compute a total demand load.
- c. Indicate the location of the main switchboard or power panels, light panels and all equipment panels.
- d. Indicate type of wiring system, such as rigid conduit, electrical metallic tubing, non-metallic sheathed cable, and where proposed for use.
- e. The type of conductors such as rubber insulated, varnished cambric, lead covered, etc., and their proposed location.
- f. Show the location of all lights, power outlets, switches, etc.

- g. Describe the proposed pertinent standards of design such as voltage drop, lighting intensities, and types of lighting fixtures.
 - h. Describe the short-circuit duty required for all protective devices and switch gear.
 - i. Indicate the requirements for emergency electrical systems.
 - j. Ensure that the electrical information for the facility is fully coordinated with the site electrical requirements and with the low voltage communications systems requirements.
 - k. Provide any other information necessary.
5. Communications, Electronic and Instrumentation Provisions
- a. Provide sufficient information including engineering concepts for review purposes of the systems proposed; i.e., intercom system, telephone system,, public address system, radio and antenna systems, television antenna systems, protective alarm system, response tie-ins and any other data or systems deemed necessary.
 - b. Indicate equipment selection, including special equipment requiring development, research, or breadboard methods to meet the requirements.
 - c. Site or location consideration.

- d. Required radio paths and propagations.
- e. Antenna requirements such as types, separation, tower heights, aircraft clearance and area requirements.
- f. Antenna transmission lines, terminations and switching.
- g. Bonding and grounding requirements.
- h. Communication, control cables and radio links.
- i. Test equipment, repair shop and spare parts storage requirements.
- j. Equipment and instrumentation arrangement and space requirements indicating requirement for racks, consoles, and for individual mounting.
- k. Wiring and cable requirement plus terminations.
- l. Power and lighting requirements, including emergency or standby requirements.
- m. Air conditioning requirements including humidity and dust control requirements.
- n. Interference and clearance requirements

6. Plumbing

- a. Provide preliminary layout of utility lines and building construction services lines and elevations and sizes fundamental to design.
- b. Preliminary floor plans showing major horizontal and vertical services, the location and size of fixtures, equipment and the number of persons served.
- c. Preliminary building sections showing riser and branch lines, fixtures and equipment.
- d. Provide the estimated number of fixtures units in order, demand and GPM for all plumbing fixtures.
- e. Provide the estimated minimum and maximum water pressure at each building.
- f. Indicate the type of heater and capacity for hot water supply.
- g. Additional details as necessary to describe or clarify any other conditions.

7. Fire Protection

- a. Indicate service hydrants, stand pipes and test values.
- b. Indicate risers and hose cabinets.

- c. For sprinkler systems, indicate the authority for the installation, the hazard rate of occupancy, the type of sprinkler system (wet or dry), and the water volume and pressure required. Delineate any special system such as carbon dioxide, foam, etc., that will be required.
- d. Provide insurance rating groups governing the design.
- e. Provide any other data deemed necessary.

8. Special Equipment

Indicate all special equipment such as:

- a. Kitchen equipment
- b. Window coverings
- c. Lawn sprinkler equipment systems
- d. Any other systems deemed necessary for inclusion

D. Area Analysis

The Design Professional should submit an area analysis of the project. Use the criteria shown in EX-I-22-E and the summary form shown in Ex-I-22-F.

E. Other Data

Provide such data as deemed necessary to explain the design concept and Design Development documents.

22.6 Contract Document Phase

22.6.1 General

Subsequent to the receipt of approval of the Design Development documents, and upon authorization by the Florida DOT, the Architect, shall, in accordance with his Contract prepare complete contract documents of adequate and sufficient scope for construction purposes.

22.6.2 Development Procedures

The Architect shall hold conferences and meetings with the Florida DOT, applicable permitting agencies, and others as required to fully amplify the project and prepare his contract documents.

22.6.3 Review and Approvals

- A. Initial Reviews and Conferences: The Architect shall review in detail with the Florida DOT all codes and permits required for the project prior to proceeding with the development of his construction documents.
- B. 50% Contract Document Review Submittal: In accordance with the Contract, the Architect shall submit "in progress" review documents to the Florida DOT at 50% completion of Contract Documents.
- C. Final Reviews and Approvals
 - 1. Upon completion of his contract documents, the Architect shall submit complete document review

sets to the Florida DOT in a quantity sufficient to cover simultaneous review. He shall also submit review sets to any other agency having jurisdiction over the project and from which approvals will be required.

2. The complete contract documents will be reviewed by and commented on by all agencies having jurisdiction. Their comments should be transmitted by the Florida DOT to the Architect for response prior to scheduling, if necessary, a review conference at which the Architect should respond to all comments.
3. The Architect shall respond in writing to the comments received and shall correct or modify his documents as required. If necessary, he will resubmit the Construction Documents for additional review and comment.
4. Upon satisfactory response to all comments, and modification and correction of the contract documents, the Florida DOT will formally review and comment on the acceptability of the contract documents.

22.6.4 Documents Required

A. General

The completed contract documents shall be in accordance with the requirements of the Contract.

B. Area Analysis

The Architect shall submit an area analysis of the project, shown as Exhibit I-22-E.

C. Color Schedules

The Architect shall include in his specifications and on his drawings, where applicable, the actual colors or color ranges chosen to be used on the project. The Design Professional shall also submit with his contract documents a complete listing of colors to be used, providing pallets and material samples as necessary.

D. Drawing Requirements

1. General

The Architect shall ensure that his drawings are final and complete with all elements thoroughly checked and coordinated to ensure that there are no conflicts between architectural, structural, mechanical, electrical and other portions of the work. Particular emphasis shall be placed on this coordination when certain elements of the design are performed under

subcontract to the Design Professional. The drawings should be prepared so that change orders to construction will not be necessary due to errors, omissions, inadequacies or conflict between various component parts or with the specifications. When applicable, the design data should be shown on the drawings, i.e.:

a. Loads

- (1) Roof and Floor Live Loads
- (2) Wind Loads
- (3) Total Loads

b. Basic Working Stresses For

- (1) Concrete
- (2) Structural Steel
- (3) Wood
- (4) Concrete Block, Masonry

c. Foundations

- (1) Allowable Soil Pressure for Spread Footings
- (2) Bearing Value for Piles

2. Material

Unless otherwise instructed, the working documents shall be prepared in ink on plastic film (mylar).

E Specification and Special Provision Requirements

1 General

The specifications shall be complete and final with all elements thoroughly checked and coordinated. Particular emphasis should be placed on the coordination of various elements of the specifications or portions of the specifications prepared under subcontract to the Design Professional.

2 Standard Specifications

Maximum use shall be made of standard materials and methods of construction and standard specifications.

Specifications for classifications of work and material issued by an approved association, such as ASTM, ASA, ASME, etc., may be included. Each referenced specification must be examined before its use to ensure that it is suitable for its intended purpose and that proper choice is made of the options given in it.

When a small quantity of materials is needed and a standard commercial product would be suitable, reference to a standard specification should not be made. Federal and military specifications may be used with the expressed approval of the Florida DOT.

When specifying by product, model number, etc., three acceptable manufacturer's products or equal will be specified.

In referencing standard specifications the following rules should be followed

- a Avoid reference to specific paragraphs in the standard specifications, since it limits the requirements to the paragraph referenced
- b Avoid repeated references to a standard specification within the same section
- c Specify types, classes, weights and similar applicable characteristics required to ensure an accurate description

The Architect shall submit to the Florida DOT with his construction documents submittal a copy of each referenced specification

| F Construction Cost Estimate

| Architectural contract documents shall include a statement of
| probable construction costs This "estimate" shall be organized
| according to the 16-division Construction Specifications Institute
| (CSI) "Master Format"

| The statement of probable costs shall consist of a lump sum total
| estimate, with specific pay items listed, and background cost data
| The background cost data shall describe quantities, unit costs and
| their products for the applicable subdivisions within the CSI
| format

22 6 5 Release for Printing

Upon receipt of formal review and comment from the Florida DOT, and upon authorization, the Architect shall print and properly sign and seal three sets of documents for record purposes only

22 6 6 Pre-Bid Conference

The Architect will attend a pre-bid conference administered by the Department and he will be prepared to answer questions from prospective bidders who have reviewed the contract documents

22.7 Construction Phase Requirements

22.7.1 Notice to Proceed

The Notice to Proceed, authorizing the Contractor to proceed with the construction phase work, will be issued by the Florida DOT

22.7.2 Preconstruction Conference

The Florida DOT, prior to commencement of construction, will arrange and chair a meeting with the Contractor, Design Professional, major subcontractors, and other interested parties. The purpose of this conference shall be

- A To discuss requirements and responsibilities of the various parties involved to achieve expeditious handling of the construction contract
- B The instruction of all parties concerning required and standard procedures, required submissions and federal or other regulations that are applicable to the project
- C Resolution of all problems as to the scope of the project and the signing of plans and specifications by all parties to the contract

22.7.3 Periodic Construction Conferences

The Florida DOT shall schedule construction conferences monthly and/or at a frequency at the discretion of the Florida DOT in order to resolve current problems or to ensure that the project is progressing in a satisfactory manner. It shall be essential that the Contractor and the Architect attend

These meetings should cover the project as a whole, and certain essential information shall be sought and reported in every conference. The items are.

- A Progress, as related to the schedule, to be reviewed by the Department and the Contractor prior to the meeting
- B Payment Request
- C Change Orders
- D The Florida DOT and Architect evaluations of the progress of the work
- E Special problems and remedial actions, and results of previous remedial actions

22 7 4 Shop Drawings, Material, and Equipment Submittals

A General

It shall be the responsibility of the Architect to expeditiously review all equipment brochures, shop drawings, catalog data, finished hardware schedules, etc, which are required to be submitted by the construction documents. The Architect should review all equipment and material submittals in such a manner as to determine whether or not the materials submitted are being offered as a substitute to those specified, and that the requirements of the contract documents are fully met.

22 7 5 Clarification Drawings and Specifications

A General

The Architect will be required to issue supplementary drawings and/or specifications clarifying his contract documents as required. Whenever such drawings and specifications are issued by the Architect, he should ensure that said drawings and specifications do not obligate the Florida DOT for a change in scope of the project, either positively or negatively. Such changes in scope must be handled by Supplemental Agreement.

B Issuance and Transmittal

Whenever the Architect finds it necessary to issue to the Contractor drawings and specifications to modify or clarify the work, a copy shall be supplied to the Florida DOT.

C Final Inspection

Upon completion of construction and completion of all punchlist items, the Contractor shall arrange and schedule, with the concurrence of the Department, a final inspection of the project. He should coordinate the schedule with representatives of the Department and any other interested party. The Architect shall administer the inspection.

Following the inspection, the Architect shall provide the Contractor with a list of any additional requirements for corrective action and make another inspection, if necessary, to satisfy himself that the work has been completed.

22.7.6 Substantial Completion

A. General

The Architect shall conduct a substantial completion inspection upon notification by the contractor that the project is ready for such. The Architect shall coordinate with all parties in determining the time of the substantial completion inspection (FDOT, A/E, Subconsultants, contractor, etc.).

B. Requirements

Upon completion of the substantial completion inspection, the Architect shall prepare the Certificate of Substantial Completion and punchlist.

Punchlist items shall include all items not satisfactory or not completed at the time of inspection.

C. Approvals and Declaration

Official occupancy of the project will not occur until substantial completion has been declared by the Architect and accepted by the Florida DOT.

22.7.7 Final Acceptance and Contract Close-Out

A. General

The Contractor shall notify the Florida DOT when the project has been fully completed and schedule the final inspection. The Architect shall provide the Contractor with a list of any items requiring correction and ascertain that the items have been corrected. The Architect shall then coordinate and conduct the final inspection and prepare the Certificate of Contract Completion and shall then distribute the certificates to the Contractor, who shall complete all copies and return them to the Florida DOT. The total contract amount must include all Supplemental Agreements.

Drawings and Title Block Requirements

Project Title
Project Location
State Project Number

Phase of Development
(i.e., Conceptual Schematics, Advanced Schematics,
Design Development, Contract Documents)

State of Florida
Department of Transportation

Name of Architect
Address of Architect
Telephone Number of Architect

Sheet Number
Date of Preparation
Initials of Preparer
Signature of Reviewer
Date of Review

Date of Revisions
Initials of Revisers
Signature of Reviewer
Date of Review

On Each Sheet as Applicable
Name of Consultant
Address of Consultant

EX-I-22-A

STATE OF FLORIDA DEPARTMENT OF TRANSPORTATION
OFFICE OF SPECIAL FACILITIES

REVISIONS		ROAD NO	COUNTY	PROJECT NO
Dates	Descriptions			
		APPROVED BY		
		Names	Dates	
		Designed by		
		Checked by		
		Quantities by		
		Checked by		
		Supervised by		
			Drawing No	Index No

Note:

The basic organization of the title block (Ex-I-22-B) shall be the same for each drawing, changing the information on each sheet as appropriate.

The sheet number shall always appear either on the lower right hand corner or along the right margin of the drawing.

Three prints of each drawing shall be sealed and signed by the responsible professional so as to produce three record sets of plans.

Title Sheets, Pages and Covers

Note:

The title sheet for drawings and the title page for specifications and/or special provisions should be made as simple as possible without undue embellishment and shall contain the following information:

Drawings, Specifications, Special Provisions

Project Title
Project Location
State Project Number
Work Program Item Number
For State of Florida
Department of Transportation

Name of Architect
Address of Architect

Date of Publication

Drawings Only

Map of Florida showing project location
Range Scale vicinity map showing location of project

EX I-22-C

THIS CONTRACT PLAN SET INCLUDES

STATE OF FLORIDA

DEPARTMENT OF TRANSPORTATION

PLANS OF
ST. AUGUSTINE
MAINTENANCE OFFICE BUILDING

ST. JOHNS COUNTY, FLORIDA

STATE PROJECT NO 78000--3516

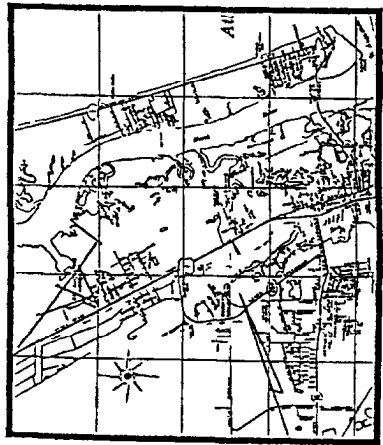
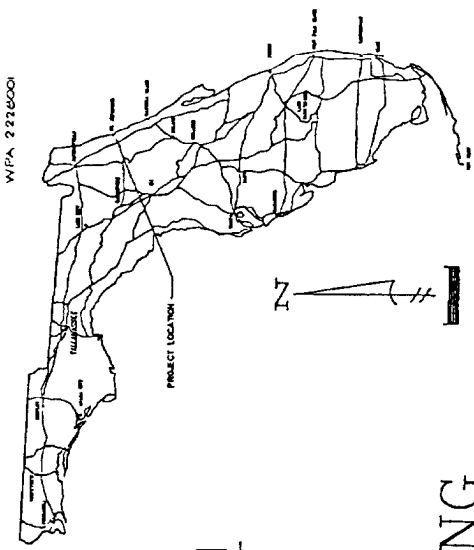

SUMMARY OF PAY ITEMS (1 SHEET)

K-1 KEY SHEET

ARCHITECTURAL DRAWINGS

- 1 SITE PLAN
- 2 FOUNDATION & ROOF FRAMING PLANS AND DETAILS
- 3 FLOOR PLAN AND ROOM FINISH SCHEDULE
- 4 ELEVATIONS, DOOR SCHEDULE AND DETAILS
- 5 WALL SECTIONS AND DETAILS
- 6 1/4 TOILET PLAN AND ELEVATIONS BUILDING SECTIONS
- 7 ROOF PLAN REFLECTED CEILING PLAN DETAILS
- 8 WINDOW DETAILS
- 9 RECEPTION DESK
- 10 STRUCTURAL DETAILS
- 11 STRUCTURAL DETAILS

C-1 CIVIL DRAWINGS
UTILITY SITE PLAN

MECHANICAL DRAWINGS

- P-1 SCHEDULE NOTES
- P-2 PLUMBING FLOOR PLANS RISER DIAGRAMS
- M-1 SCHEDULES NOTES
- M-2 DUCTWORK LEGEND
- M-3 H V A C FLOOR PLAN
- M-4 CONTROL DIAGRAMS

ELECTRICAL DRAWINGS

- E-1 SYMBOLS AND ABBREVIATIONS
- E-2 LIGHTING PLAN
- E-3 POWER PLAN
- E-4 SCHEDULES

ATTENTION IS DIRECTED TO THE FACT THAT THESE PLANS MAY HAVE BEEN REDUCED IN SIZE BY REPRODUCTION THIS MUST BE CONSIDERED WHEN OBTAINING SCALED DATA

GOVERNING SPECIFICATIONS - STATE OF FLORIDA DEPARTMENT OF TRANSPORTATION STANDARD SPECIFICATIONS DATED 1988 AND SUPPLEMENTS THERETO IF NOTED IN THE SPECIAL PROVISIONS FOR THIS PROJECT

DESIGNED BY _____
DIRECTOR OF PRECIPITATION AND RELIANCE

DATE _____

The covers for the specifications should indicate only the project title, location, state project number and work program item number.

The title sheet for the drawings may serve as the drawings cover or a plain manila sheet may be used for protection.

Specifications (Special Provisions) and drawings shall be bound in such a manner as to discourage separation or removal of pages.

Standard Method of Area Calculation and Space Measurement

Purpose

The purpose of the standard is: (1) to permit communication and computation of building areas and space measurement on a standard clear and understandable basis. (2) to allow comparison of values on the basis of generally agreed upon units of measurement (re: net square footage and gross square footage).

Applicability

This standard shall be used in measuring space in old as well as new buildings, leased space as well as State-owned space. It is applicable to any architectural design or type of construction, being based on the premise that the net area being measured is that which the agency may occupy and use for its furnishings and its people.

Type and Measurement of Space

The following types of space shall be applicable for measurements:

1. Net Usable Area

Net usable area shall be the sum of all occupiable space in a building, that is the measurable area of a building actually having usable value. The area shall be measured from the inside finish of permanent outer building walls to the office side of permanent corridors and/or other permanent partitions, and to

EX-I-22-E

1 of 5

the center of partitions that separate the premises from adjoining usable areas. This usable area shall include; bathrooms, stairs, elevator shafts, flues, pipe shafts, vertical ducts, air-conditioning rooms, fan rooms, janitor closets, electrical closets, and such other rooms not actually available to the tenant for his use.

No deductions shall be made for columns and projections to the building. For glass walls measure from the inside glass face.

2. Public Convenience Area

The public convenience area shall be the sum of all areas devoted to the welfare of the general public such as toilets, vending machine areas, telephone booths, etc.

3. Mechanical Area

The mechanical area shall be the sum of all areas devoted to the mechanical operation of the facility. Spaces shall include mechanical rooms, electrical closets, telephone closets, machinery rooms, pipe and mechanical chases, etc.

EX-I-22-E

2 of 5

4. Building Service and Storage Area

The building service and storage area shall be the sum of all areas within a building devoted to building service, such as janitor's closets, general building storage, maintenance areas and room, receiving areas, loading docks, etc.

5. General Circulation

The general circulation area shall be the sum of all areas within the building devoted to horizontal and vertical circulation, which are for general use and not assignable as net usable area.

6. Exterior Sheltered Area

Exterior sheltered area shall be the sum of all covered walkways, open roofed-over areas that are paved, porches, and similar space. In calculating total footage this area shall be multiplied by a factor of 0.50.

7. Structural Area

The structural area shall be the sum of all areas structurally devoted to the building. Generally it shall be the gross building area less the space designated as areas above including the exterior sheltered area multiplied by a factor of 0.50.

EX-I-22-E

3 of 5

8. Gross Building Area (Architectural Area)

The gross building areas of a building shall be the sum of:

- a. The several floors of the building including basements, mezzanine, and intermediate floored tiers and penthouse of headroom height, measured from the exterior faces of exterior walls or from the centerline of walls separating buildings.
- b. Gross building area shall not include such features as pipe trenches, exterior terraces or steps, chimneys, roof overhangs, etc.
- c. Void areas such as elevator shafts, mechanical shafts, etc., on each floor shall be included in the gross building area.

9. Exterior Developed Area

The exterior developed area shall be the sum of all hard surfaced specific purpose areas, such as decorative walls, plazas, fountains, etc.

10. Gross Project Area

Gross project area shall be the sum of the gross building area and the exterior developed area multiplied by a factor of 0.25.

EX-I-22-E

4 of 5

11. Net Maintainable Area

The net maintainable area shall be the gross project area less the structural area.

NOTE: Generally all area measurements should be taken at a plane 4'5" above finished floor and shall include all partitions in non-usable areas.

EX-I-22-E

5 of 5

AREA ANALYSIS - SUMMARY

Project Title: _____

Project Number: _____

- 1. Net Usable Area + _____
- 2. Public Convenience Area + _____
- 3. Mechanical Area + _____
- 4. Building Service & Storage Area + _____
- 5. General Circulation Area + _____
- 6. Exterior Sheltered (x 0.50) + _____
- 7. Structural Area + _____
- 8. Gross Building (AIA) + _____
- 9. Gross Project + _____
- 10. Gross Project + _____
- 11. Less Structural Area - _____
- 12. Net Maintainable - _____

Efficient = Net Area (1) _____ = _____ =
Gross Area (8) _____

EX-I-22-F

FACILITIES COMPUTATION FORM

A = _____ = 20 Year ADT (Allow for local commuter traffic) T = _____ = Percent of overall traffic represented by trucks

K = _____ = Ratio of Design Hourly Volume to ADT
(Generally 0.135)

D = _____ = Directional distribution of Design Hourly Volume
(Generally 0.6+)

	Insert Factor			Total
	A	K	D	
B = Peak hourly directional traffic				
C = Traffic composition				
C1 - Cars (80% to 85%)		% x B =		
C2 - Cars with trailers (3% to 8%)		% x B =		
C3 - Trucks (5% to 13%) (T = _____)		% x B =		
C = B = _____		100% x B =		
D = Vehicles per hour stopping at Rest Area				
D1 - Cars		% x C1		
(a) Near commercial or recreational facilities (5%)				
(b) Typical rural route (9%)				
(c) Information and welcome centers (15%)				
D2 - Cars with trailers (10% to 15%)		% x C2		
D3 - Trucks (10% to 15%)		% x C3		
D = Total of D1, D2 and D3				
E = Total parking spaces				
E1 - Cars		x D1		
(a) Avg stop - 15 to 20 min. (0.25 to 0.33 hr.)				
(b) At information and welcome centers - 20 to 30 min. (0.33 to 0.5 hr.)				
E2 - Cars with trailers - 30 min. avg (0.5 hr)		0.50 x D2		
E3 - Trucks, 30 min avg (0.5 hr)		0.50 x D3		
F = Persons per hour using comfort facilities:		D x 2.25 =		
G = Toilet and urinal fixtures 2.5 min avg use		0.04 x F =		
(a) Men		0.50 x G =		
(b) Women		0.50 x G =		
(If the resultant number is uneven, the extra fixture shall be on the men's side.)				

Chapter 23

Design Exceptions

23.1 General

Occasionally, it becomes necessary to deviate from the standard criteria used in the design process. When this is the case, documentation and approval shall be required. Two specific deviations may occur: (1) design exception, (2) design variation.

It is very important that the correct term is used when it becomes necessary to deviate from standard criteria. Design Exceptions require specific action and documentation, while Design Variations require less formal action. In both cases, the design project file should clearly document the action taken and approval given.

It is the policy of the Department to utilize design criteria and standards that are within the desirable ranges established by AASHTO, and the Plans Preparation Manual, Volume I. When appropriate, allowable AASHTO criteria and standards and criteria in the Florida Green Book and RRR Manual may be used.

23.2 Department Design Standards and Criteria

While the Department utilizes AASHTO and the Florida Green Book in establishing allowable criteria, it must be noted that the standards and criteria adopted may exceed the minimum recommended values given in both. The Florida Green Book was the result of Florida Statutes requiring minimum standards for all streets and highways in Florida. While the Department oversees the development of these minimum standards, they do not necessarily represent the minimum standards or criteria adopted by the Department. Department criteria will be found in specific manuals such as this one.

23.3 Design Exceptions

Design Exceptions are required anytime design parameters are specified which fall below the minimums established by AASHTO for the following controlling design elements design speed, lane widths, shoulder widths, bridge widths, structural capacity, vertical clearance, vertical alignment, horizontal alignment, stopping sight distance, cross slope, superelevation and grade

For federal aid projects, this requires a formal request for a design exceptions from the FHWA This request must be submitted under the District Secretary's or Director's signature, with concurrence from the State Roadway Design Engineer Currently, only the Division Administrator for the FHWA can approve Design Exceptions This approval shall be documented
l in the project file. (See Exhibit I-23-A.)

For non federal aid projects, the project file must contain the justification for the exception as developed by the responsible professional engineer, and have approval from the District Design
l Engineer and concurrence from the State Roadway Design Engineer (See Exhibit I-23-B)

23.4 Design Variation

A Design Variation is required anytime design parameters are specified which fall below Department established values or any other AASHTO minimum standard not covered by the 12 controlling design elements requiring a design exception

For federal aid projects not developed under Certification Acceptance procedures, this requires approval of the District Design Engineer and the FHWA (usually the Area Engineer), with
l concurrence by the State Roadway Design Engineer, during the plans development stage This
l approval shall be documented in the project file (See Exhibit I-23-C)

For approval of design variations on projects developed under Certification Acceptance procedures and for non federal aid projects, the designer should follow the process in Chapter 24 of this volume, which requires approval be the District Design Engineer, with concurrence from the State Roadway Design Engineer

For approvals of design variations on projects to be let by the District, the approval of the District Design (or Project Management) Engineer, with concurrence by the District Director of Production, is required. This approval shall be documented in the project file.

Date

Mr. J. R. Skinner
Division Administrator
Federal Highway Administration
227 North Bronough Street, Room 2015
Tallahassee, Florida 32302

| ATTN: Bob Robertson

SUBJECT: Design Exception
State Project Number
W.P.I. Number
F.A Project Number
County
Description

Include a brief background statement concerning project and item(s)
of concern.

Indicate design element(s) requiring exception and specific
exception requested.

Also, include justification, supporting documentation, etc.

REQUESTED BY:

District Secretary or Production Director

CONCURRENCE:

APPROVAL:

State Roadway Design Engineer

Division Administrator
Federal Highway Administration

EX I-23-A

DATE:

TO: District Design Engineer

FROM:

COPIES:

SUBJECT: Design Exception

REF: State Project Number
W.P.I. Number
County
Description

Include a brief background statement concerning project and item(s) of concern

Indicate design element(s) requiring exception and specific exception requested.

Also, include justification, supporting documentation, etc

RECOMMENDED BY:

Responsible Professional Engineer
(Name of Consultant Firm)

APPROVAL:

CONCURRENCE:

District Design Engineer

State Roadway Design Engineer

EX I-23-B

I-23-50

Revised 03/04/92

DATE:

TO: District Design Engineer

FROM:

COPIES:

SUBJECT: Design Variation *

REF. State Project Number
W.P.I. Number
F.A. Project Number
County
Description

Include a brief background statement concerning project and item(s) of concern.

Indicate design element(s) for which variation is requested, along with specific variation description.

Also, include justification, supporting documentation, etc

RECOMMENDED BY:

APPROVED BY:

Responsible Professional Engineer
(Name of Consultant Firm)

FHWA Area Engineer

APPROVAL:

CONCURRENCE:

District Design Engineer

State Roadway Design Engineer

* For FA projects not under Certification Acceptance.

EX I-23-C

Revised 03/04/92

I-23-60

CHAPTER 24

CERTIFICATION ACCEPTANCE

6.1 General

Certification Acceptance (C A) is an agreement between the Department and the Federal Highway Administration (FHWA) Under this agreement FHWA accepts the Department's certification that the design and construction phases of specific Federal-Aid highway projects have been carried out in accordance with all appropriate Federal and State laws, regulations and standards Under C A the Department assumes many of the responsibilities and duties previously performed by FHWA on Federal-Aid projects

24 2 Certification Acceptance Coverage

C A. applies to the design phases for Roadway, Signing, Marking, Lighting, Signalization, Structural, Landscaping and Architectural plans on Federal-Aid projects C A. also applies to the award and construction activities on Federal-Aid projects where the official cost estimate for construction is less than five million dollars Final design and plans preparation for projects will be developed under C A. after FHWA's acceptance of the project's location and design concepts (see chapters 3, 5 and 7 of the PD&E Manual) FHWA reviews and approvals are not required during the final design phases for any projects developed under C A , up to and including the authorization to advertise for bids.

24.2.1 Areas not Included

The final design phases of some Federal-Aid projects are not included under C A. and will be developed with routine FHWA involvement These types of projects are projects on the Interstate system as well as projects that affect the Interstate system. Projects affecting the Interstate might involve a crossing of the Interstate or work associated on a cross road at the ramp terminals, regardless of the source of funding If there are questions as to whether a project affects the Interstate system, the appropriate Area Design Engineer should be consulted.

In addition to the above projects that are not included in C.A., there are special project features that require FHWA reviews and concurrences These special features are:

- | A. Individual structures with an estimated total deck area greater than
| 125,000 square feet, unusual or moveable bridges, tunnels and unusual
| hydraulic or geotechnical structures.

- B Major storm drainage systems designed to carry more than 200 cfs, or regardless of quantity of discharge, systems which have a surface detention storage system with an accumulated volume greater than five acre feet.
- C. Storm water pumping facilities designed to discharge more than 20 cfs
- D Major channel changes which may significantly change the stream regimen or ecology.
- E. Experimental features in the project design, including materials or construction methods.
- F Traffic surveillance and control systems with an estimated construction cost greater than \$1 million
- G. The use of proprietary or sole source items or materials
- H. Operational plans for motorist-aid systems.

Projects including these features may be developed under C A , however, the design of these features must be coordinated with FHWA to obtain the necessary reviews and approvals. Current and accurate areas, discharges and cost estimates must be used to determine if FHWA involvement is required FHWA should be involved in a feature as soon as it is evident that any of the above criteria apply.

C A. also does not apply to the processing of the environmental document for a project (including reevaluations), any right-of-way phases, construction

| activities on projects where the official cost estimate is greater than five
| million dollars, or the acquisition of professional services, including
authorizations for in-house design. FHWA should be kept fully involved in
these phases of Federal-Aid projects in accordance with current procedures
Hazard elimination projects (HES funded) and railroad grade crossing
improvement projects (RRP/RRS funded) are covered under alternate C A
procedures approved by FHWA on 9-12-88 (HES) and 11-17-88 (RRP/RRS)

243 Certification Acceptance Responsibilities

The final design documents, reports and plans prepared under C.A. will be developed in accordance with all applicable Department manuals, guidelines and procedures, and in compliance with all applicable Federal Statutes, Regulations, Executive Orders, and FHWA Directives and Standards. The Department is responsible for assuring that all appropriate criteria has been adhered to, and for documenting its findings in lieu of FHWA reviews. Several of the major areas and the method to be used by the Department to document the acceptability of various final design activities in place of an FHWA review are:

A. Typical Section Package.

The typical section package should be prepared as described in Chapter 15.3.3 of this volume. Concurrence by the District Design Engineer documents the acceptability of the package. Concurrence from the District Structures Engineer may also be required on unusual bridge typical sections.

B. Pavement Design Package.

The pavement design is developed and approved by the responsible professional engineer in accordance with Department pavement design procedures. Concurrence from the District Design Engineer is required to document the acceptability of the package in lieu of FHWA review and concurrence.

C. Bridge Hydraulics Report

The hydraulics report is developed and approved by the responsible professional engineer in accordance with appropriate design standards. Concurrence from the District Drainage Engineer is required to

document the acceptability of the package in lieu of FHWA review and concurrence.

D Bridge Development Report

The bridge development report is developed and approved by the responsible professional engineer in accordance with appropriate design standards. Concurrence from the District Design, Structures, or Project Management Engineer is required to document the acceptability of the report in lieu of FHWA review and concurrence.

E. Design Plans Phase Reviews.

Plan reviews should be conducted as described in chapters 15.2, 15.3.1, and 16 of this volume. Concurrence in the resolution of phase review comments from the District Design, Structures, or Project Management Engineer is required to document the acceptability of the reviews in lieu of FHWA review and concurrence (See Exhibit I-24-B)

F. Roadside Safety

Roadside safety should be a consideration in the design process, as is discussed in Chapter 4 of this volume. The District Safety Engineer is required to review all project designs to ensure and document that all accident and safety problems have been addressed in lieu of FHWA compliance reviews.

G. Design Variations.

Design variations described in Chapter 23.4 of this volume must be approved by the District Design Engineer. Concurrence from the State Roadway Design Engineer is required to document the acceptability of the variation in lieu of FHWA concurrence (See Exhibit I-24-C)

H. Design Exceptions

Design exceptions, as described in chapter 23.3 of this volume, still require approval by FHWA. A design exception is required when less than minimum AASHTO criteria is used for any of the following 12 controlling design elements: design speed, lane width, shoulder width, bridge width, structural capacity, vertical clearance, vertical alignment, horizontal alignment, stopping sight distance, cross slope, elevation and grade. A request to allow a design exception must be submitted to FHWA by the District Secretary or the District Production Director, with concurrence from the State Roadway Design Engineer.

I. Special Provisions.

Special provisions, which include project specific and technical special provisions, will be developed and approved by the responsible professional engineer. Concurrence from the District Design, Structures (or, for Category II structures, the State Structures Engineer), or Project Management Engineer is required to document the acceptability of the special provisions in lieu of FHWA review and concurrence. (See Exhibit I-24-D.)

J. Plans, Specifications and Estimate.

The plans package and contract file will be transmitted to Tallahassee as described in chapter 20 of this volume. The District Production Director will sign the transmittal letter certifying that the design and plans have been prepared according to the approved C.A. procedures. The specifications package will be approved by the State Specifications Engineer. The Department's official estimate will be approved by the State Estimates Engineer.

K. Authorization to Advertise

| The letter requesting FHWA authorization to advertise for bids and the
| PS&E package, including reimbursible utility agreements, will be
| submitted to FHWA by the Federal Aid Office. The Federal Aid
| Manager will certify in the letter to FHWA that the package was
| prepared under C.A. An FHWA PS&E checklist (filled out by the
| District and submitted with the plans package) will be submitted to
| FHWA.

L Revisions.

Revisions to the PS&E will be processed as described in chapter 20.2 of this volume. Concurrence from the District Design, Structures, or Project Management Engineer is required to document the acceptability of the revision in lieu of FHWA review and concurrence.

In special cases where programs or projects are developed in the Central Office, an appropriate Central Office Manager will provide any necessary concurrences in lieu of a District Manager. Exhibit I-24-A outlines the approval and concurrence procedures used in the C.A. process.

24 4 Certification Acceptance Documentation and Reviews

FHWA will perform periodic reviews of projects developed under C A and may have access to review project phases and records at any time. To support C A , adequate documentation throughout the design phase is critical. All approvals and concurrences outlined in the previous section must be sufficiently documented. A complete, well-organized design project file should be able to support a C.A. review. All correspondence and documents must include the federal aid project number. The Quality Assurance procedures described in chapter 17 of this volume will be used by the Central Office to monitor district compliance with C.A. requirements.

CERTIFICATION ACCEPTANCE APPROVAL AND CONCURRENCE PROCESS

<p>TYPICAL SECTION PACKAGE</p> <p>Approved: 6 Concurrence: 3 or 4</p> <p>(PPM Vol 1, Chap. 15 3 3)</p>	<p>PAVEMENT DESIGN PACKAGE</p> <p>Approved: 6 Concurrence: 3</p> <p>(Pav't Design Manual)</p>	<p>DESIGN CRITERIA DESIGN EXCEPTIONS</p> <p>Requested: 1 or 2 Concurrence: 8 Approved FHWA DESIGN VARIATION Recommended: 6 Approved: 3 Concurrence: 8</p> <p>(PPM Vol 1, Chap. 23)</p>	<p>BRIDGE HYDRAULICS REPORT</p> <p>Approved: 6 Concurrence: Dist Drainage Engr</p> <p>(Drainage Manual Vol 2, Chap 9)</p>
<p>BRIDGE DEVELOPMENT REPORT</p> <p>Approved: 6 Concurrence: 3 4 5 or 7</p> <p>(Struct. Design Guidelines Chap. 3.3)</p>	<p>APPROVAL OF PHASE REVIEW PLANS (Roadway and Structures)</p> <p>Approved: 6 Concurrence: 3 4 5 or 7</p> <p>(PPM Vol. 1, Chap 15)</p>	<p>PLANS, SPECIFICATIONS AND ESTIMATE</p> <p>PLANS PACKAGE Approved: 2</p> <p>SPECIFICATIONS PACKAGE Approved: 9</p> <p>OFFICIAL ENGINEERS ESTIMATE Approved: 10</p> <p>(PPM Vol 1, Chap 20 1)</p>	<p>REVISIONS TO PS & E</p> <p>Approved: 6 Concurrence: 3 4 or 5</p> <p>(PPM Vol. 1, Chap 20 2)</p>
<p>ACCIDENT/SAFETY REVIEW</p> <p>Approved: Dist. Safety Engr</p>	<p>SPECIAL PROVISIONS</p> <p>Approved: 6 Concurrence: 3 4 or 5</p>		<p>ASSEMBLY OF PS & E & CERTIFICATION OF OTHER REPORTS AS REQUIRED</p> <p>Responsibility: FA Manager</p>
<p>1 DISTRICT SECRETARY</p> <p>2 DISTRICT PRODUCTION DIRECTOR</p> <p>3 DISTRICT DESIGN ENGINEER</p> <p>4 DISTRICT STRUCTURAL ENGINEER</p> <p>5 DISTRICT PROJECT MANAGEMENT ENGINEER</p> <p>6 RESPONSIBLE PROFESSIONAL ENGINEER</p> <p>7 STATE STRUCTURES DESIGN ENGINEER</p> <p>8 STATE ROADWAY DESIGN ENGINEER</p> <p>9 STATE SPECIFICATIONS ENGINEER</p> <p>10 STATE ESTIMATES ENGINEER</p>			
<p>NOTE</p> <p><i>In special cases where programs or projects are developed in the Central Office, an appropriate Central Office Manager will provide concurrence in lieu of the District Manager.</i></p>			

DATE:

TO: (See Below) *

FROM:

COPIES:

SUBJECT: Response to _____ Phase Review

REF: State Project Number
W.P.I. Number
F.A. Project Number
County
Description

In content of letter include a statement confirming that all review comments have been responded to or satisfactorily resolved.

Include appropriate copies of review comments, responses and other pertinent data.

APPROVED:

CONCURRENCE:

Responsible Professional Eng.
(Name of Consultant Firm)

* District Design Engineer
* District Structures Engineer
* District Project Mgmt. Eng

* As appropriate

EX I-24-B

I-24-110

Revised 03/04/92

DATE:
TO: District Design Engineer
FROM:
COPIES:
SUBJECT: Design Variance
REF: State Project Number
W.P.I. Number
F.A. Project Number
County
Description

Include a brief background statement concerning project and item(s) of concern.

Indicate design element(s) for which variation is requested, along with specific variation description.

Also, include justification, supporting documentation, etc.

RECOMMENDED BY:

Responsible Professional Engineer
(Name of Consultant Firm)

APPROVED BY:

CONCURRENCE:

District Design Engineer

State Roadway Design Engineer

EX I-24-C

Revised 03/04/92

I-24-12 0

DATE:

TO: District Design, Structures or
Project Management Engineer

FROM:

COPIES: State Specifications Engineer

SUBJECT: Special Provisions

REF: State Project Number
W.P.I. Number
F.A. Project Number
County
Description

Include detailed information concerning special provisions required.

Appropriate section(s) of F.D.O.T. Standard Specifications should be referenced.

Questions concerning format and content should be directed to the Specifications Office of F.D.O.T.

APPROVED:

CONCURRENCE:

Responsible Professional Eng.
(Name of Consultant Firm)

* District Design Engineer
* District Structures Engineer
* District Project Mgmt. Eng

* As appropriate

EX I-24-D

I-24-130

Revised 03/04/92

APPENDIX A

GLOSSARY OF TERMS

AADT	Average Annual Daily Traffic.
ADE	Area Design Engineer
ADT (two way)	Average Daily Traffic.
Approach Slab	A section of a roadway adjacent to, and at the end of a bridge, requiring special design and construction considerations.
Arterial	A general term denoting a highway primarily for through traffic, usually on a continuous route.
A-2 or A-3 Material	Materials consisting of sands deficient in coarse materials and soil binder.
A-8 Material	A national classification of a type of unsuitable material.
Base course	The layer or layers of specified or selected material of design thickness placed on a subbase or subgrade to support a structural course.
Baseline	An accurately measured line from which the position of other points may be determined, or on which a survey may be based.

Benchmark	A relatively permanent object, natural or artificial, bearing a marked point whose elevation above or below an adopted datum is known.
BHRS	Bridge Hydraulic Recommendation Sheet.
Bifurcated Section	A section of a divided roadway separated by a very wide area of natural ground.
Border Width	A term usually used in conjunction with urban roadway cross section denoting the width of cross section from the face of curb to the right-of-way.
Borrow or Borrow Material	Material excavated from designated areas for use as 'fill'.
Borrow Pit	An excavation site outside the limits of a roadway for producing material necessary for roadway construction.
Bridge Culvert	Culverts whose dimensions exceed a 20' distance measured along project centerline between the inside faces of exterior walls..
Bulkage	Increase in soil volume due to manipulation.
CADD	Computer Aided Design and Drafting.

Catagorical Exclusion:	Projects that may be excluded from the Environmental Impact Process due to the type of work involved - example resurfacing projects.
Centerline	The axis along the middle of a road or other facility from which features can be conveniently measured.
CES	Cost Estimating System - The Department's program for estimating construction costs for projects.
Channelization	Usage of traffic islands and other devices to direct traffic into definite paths.
Clear zone	A traversable and unobstructed roadside area available for errant vehicles to safely regain control.
Clearing and Grubbing	Process of clearing the roadway construction site of unwanted features.
Collector	A general term denoting a roadway that links neighborhoods or areas of homogeneous land use with arterial streets.
Compound Curve	A curve consisting of two or more arcs of different radii curving in the same direction and having a common point.

Contract	A legal document stating the terms and conditions of an agreement between the Department and a private company to provide a service.
Contract Time	Number of calendar days allowed for completion of the contract, including authorized time extensions.
Contractor	An individual or company that undertakes to provide service specified in contract documents.
Control Radius	Radius by which a turning vehicle can maneuver with the least amount of difficulty.
Crest Vertical Curve	A convex parabolic curve providing a smooth transition between two grades.
Cross Slopes	Lateral slope given to the pavement to provide adequate drainage.
Cross Drain	A drainage structure utilized to convey water from one side of the roadway to the other, including median drains and culverts under intersecting streets.
Crown Line	The inside top of a culvert.
Culverts	A round or special shaped pipe or box used to convey water, especially under roadways or other facilities.

Curb Returns	The curved portion of the curb at which driveways and cross roads intersect with a roadway.
Cut	That portion of a road site where the formation has been excavated below ground level.
Datum	A known or measured point, line or plane to which others may be referred for vertical or horizontal control.
Delineator	Reflector units capable of clearly reflecting light under normal atmospheric conditions from a distance of 1000 feet when illuminated by the upper beam of standard automobile lights.
Design Speed	A speed determined for design and correlation of the physical features of a highway that influence vehicle operation.
Design Exception	Approved deviation from AASHTO or Department criteria.
Detention Area, Basins, and Pond	Drainage basins specially constructed and used to retard stormwater, discharging at a controlled rate for a specific period of time.
DHV	Design Hourly Volume - the traffic volume on which the functional design of a highway is based.

DPI	Ditch Point of Intersection of ditch grades.
Drainage Areas	The portion of the land surface which drains to a specific point, including paved areas, roofs and unpaved land.
Drainage Divides	The area of higher ground separating drainage areas or basins.
Driver Expectancy	A condition whereby drivers are conditioned, by encounters with repetitive features, to expect a certain driving environment. When that environment is provided, driver reaction is very predictable. When expectancy is violated, drivers may react slowly or improperly.
DHW	Design High Water elevation.
Earthwork	The excavation and filling required to construct embankment.
EIS	Environmental Impact Statement
Embankment	The constructed earth fill and excavation built to carry a road.
ESAL	Equivalent single axle load.
Esthetics	Visual impact of the roadway environment on drivers and other vehicle occupants.

Excavation	Removal of all materials of whatever nature to complete earthen cuts, ditching, sub-excavation and borrow pits.
Exceptions	Those portions of the roadway within the project limits that are excluded.
Fill	A portion of the proposed cross section which falls above the existing groundline and indicating volume of fill.
Flow Line	The inside low point or lowest line of water flow in an open gutter, swale, ditch or other drainage element.
Freeway	An expressway with fully controlled access - the highest type of arterial highway.
Friction Course	The top layer of an asphalt pavement to provide resistance to skidding, traffic abrasions and the disintegrating effects of climate.
Functional Classification	Classification of highways by design types based on the major geometric features.
F.A.	Federal Aid - used in conjunction with projects having Federal Aid funds.
Geometrics	Visible elements of a roadway, such as alignment, grades, sight distances, widths, slopes, etc.

Grade	A rate of rise or fall on any length, with respect to horizontal.
G.M.	Gross Mile.
High mast	Free standing poles or towers of height 80' or more utilized for highway lighting to provide uniform, and glare free, light distribution over large areas of highway.
30th Highest Hourly Volume	The hourly volume that is exceeded by 29 hourly volumes during a designated year.
Imagery	Visible representation of characters, line drawings and symbols.
K, D and T Values	K: Ratio of DHV to ADT. D: Directional distribution of DHV expressed as a percentage. T: Percentage of trucks, inclusive of light delivery, expressed as percentage of DHV.
Lane Taper	Divergence of lane edge for the purpose of adding or dropping lanes.
Lane Transition	Lateral shift of a travel lane.
Lateral Ditch	A ditch which runs more or less perpendicular to the centerline of roadway.

LER	Limerock Bearing Ratio - specifies load bearing capacity of the material, as related to that of limerock.
Level of Service:	A qualitative rating of the effectiveness of a highway in serving traffic, measured in terms of operating conditions.
Leveling Course	One or more layers of asphalt mix used to restore a distorted existing pavement to a uniform cross section and an acceptable level of rideability.
Limited Access R/W	The Right-of-Way wherein the right of owners or occupants of abutting land, or other persons to access a highway facility is limited to designated points, such as interchanges.
May	Permissive condition.
MUTCD	Manual of Uniform Traffic Control Devices.
MUTS	Manual on Uniform Traffic Studies.
Mylar	Polyester film used as reproducible drafting media.
National Sign Code	Code numbers assigned to standard road signs.
N.M.	Net mile.

Overbuild	Multiple layers of asphalt mix used to build up one side of an existing crown to provide a uniform cross-slope.
Overland Flow	Diffused surface flow of water.
Overlay	The construction of a structural course and, if necessary, leveling course and overbuild course, to increase the source life and improve the rideability of an existing pavement.
Overtopping Elevation	Elevation at or above which water will flow over a structure, the highway grade or a drainage divide.
Pavement Design	Description of the types and thicknesses of various layers constituting a pavement structure.
Pay Item Number	Number assigned by the Department to construction components for pay purposes.
PC Station	Point of Curvature Station - station at the beginning of a horizontal curve.
PD & E Study	Project Development and Environmental Study.

Photogrammetry	Photographic process of topographic mapping using stereographic plotters.
PID	Plans In District.
PI Station	Station of the Point of Intersection of two tangents.
Plans	The approved plans, including reproductions thereof, showing the location, character, dimensions and details of the work to be done.
Posted Speed	Regulatory speed limit established in accordance with department policy and posted on the roadway.
Profile Grade Line	A longitudinal line which controls the vertical geometry of the project, usually the inside edge of a divided highway or the centerline of an undivided highway.
Profile Grade Point	A specific point along the Profile Grade Line.
PS & E	Plans, Specifications and Estimate.
PT Station	Point of Tangent Station - station at the termination of a horizontal curve and at the beginning of the tangent.

Quality Assurance

Is all planned and systematic actions necessary to provide adequate direction so that all resulting design products can meet predetermined requirements. This includes the establishment of design policies, procedures, standards, guidelines, training and monitoring for compliance.

Quality Control

Following established design policies, procedures, standards and guidelines in the preparation of all design products. This includes the checking and review of individual designs for compliance and good engineering practice.

Ramp

That portion of the traveled way connecting two roadways at a grade separated intersection.

Range

An area of 36 square miles enclosed between nationally established survey lines running north-south, six miles apart, and township lines.

Recovery Area

See "Clear Zone".

Reference Points

One of several fixed objects for which measurements are made to enable a point to be accurately located.

Resurfacing	A supplemental or replacement surface placed on an existing pavement to improve its surface or increase its strength.
Retention Area, Basin or Pond	A drainage facility designed to retain runoff without a direct outlet discharge structure.
Returns	That extension of the roadway which allows entrance and exit to sidestreets, parking lots, etc.
Reverse Curve	A combination of two horizontal curves in opposite directions with a common tangent.
3R	Resurfacing, Restoration, Rehabilitation of a roadway.
R/W	The areas, existing or acquired by permanent easement, for highway purposes.
Sag Vertical Curve	A concave parabolic curve providing a smooth transition between two grades.
Section Lines	Established survey grid lines enclosing approximately a one mile square area of land.
Shall	Mandatory condition.
Shop Drawings	Detailed drawings of elements requiring special fabrication.

Should	Advisory condition.
Shoulder	The portion of the roadway contiguous with the traveled way and used for lateral support of base and surface courses, emergencies and safe recovery of errant vehicles.
Shrinkage	Reduction in volume of soil mass.
Sidedrain	A drainage structure placed more or less parallel to the centerline of a roadway for conveyance of water under driveways, and other such obstructions.
Soil Survey	The exploring and recording of soil types and conditions.
Special Ditch	Roadside ditch whose dimensions do not conform to those shown on the typical section.
Special Provisions	Special directions, provisions or requirements peculiar to the project under consideration and not otherwise thoroughly or satisfactorily detailed or set forth in the specifications.
Specifications	Document containing the directions, provisions, requirements and stipulations relating to the method and manner of performing the work.

Speed Change Lanes	Special lanes provided for the use of accelerating or decelerating vehicles.
Station Equations	Station along an alignment where the numerical continuity is broken.
Storm Sewer or Storm Drain	Pipe system or portion thereof used to collect or convey storm water runoff.
Stabilizing	Process by which the subbase is brought up to a bearing value sufficient to support the base.
Structural Course	One or more layers of asphalt mix placed to provide the major structural component of the pavement or to increase the service life of an existing pavement.
Subbase	The layer or layers of specified or selected material of designated thickness placed on a subgrade to support the basecourse.
Subgrade	The top surface of a roadbed upon which the pavement structure and shoulders are constructed.

Superelevation	A tilt given to a road at a horizontal curve to counteract the effect of centrifugal force.
Superelevation Transition	Transition of a cross section from normal cross slope to full superelevated cross slope, or vice versa.
Surface Course	One or more layers of a pavement structure designed to accommodate traffic load.
Survey Reference Points	Same as reference point.
Template	The sum of elements of widths, depths and cross slopes which define the roadway cross section.
Topography	Representation, on a plan, of the existing physical features in an area.
Township	An area of 36 square miles enclosed between nationally established survey lines running east-west, six miles apart, and range lines.
Travelway	The portion of the roadway for the movement of vehicles, exclusive of shoulders and auxiliary lanes.

Traversable	Crashworthy roadside conditions that would allow an errant vehicle to regain control without serious damage.
Turning Radius	Outside wheel path of a turning vehicle.
Typical Section	Shows the design elements for the cross section of a proposed roadway.
Underdrains	A subsurface drainage system.
Unsuitable Material	Types of dirt that are classified unsuitable for roadway construction.
Value Engineering	An analysis of materials, processes and products in which functions are related to costs and from which a selection may be made for the purpose of achieving the required function at the lowest overall cost consistent with the requirements for performance reliability and maintainability.
Vellum	Translucent paper used as reproducible drafting media.
Vertical Curve	A parabolic curve used to give smooth transition between tangent grade-change.

Weaving Movement

The crossing of traffic streams moving in the same general direction, accomplished by merging and diverging.

W.P.I. Number

Work Program Item number (assigned by the Department).

INDEX

VOLUME I

PLANS PREPARATION AND ASSEMBLY

3R Design	1-5, 13-5
3R Projects	16-2
Accident Data	14-6
Advance Warning Arrow Panels	10-20
Advisory Speeds	10-55
Aesthetics	1-9
Architectural Plans	22-1
Area Design Engineer	17-2
Auxiliary Lanes	2-8
Bicycle Facilities	8-1, 8-5
Bicycle Lanes	2-8
Bicycles	8-1
Border Width	2-14
Borrow	3-1, 3-2
CADD	20-9
Canals	4-5
Capacity	1-3
CES	18-1
Channelizing Devices	10-25
Clear Zone	4-1
Clearing and Grubbing	3-6
Codes	22-3
Comprehensive Planning	22-5
Consultant Design	13-8
Consultants	17-3, 21-1
Contract Administration	21-4
Contract Documents	22-35
Contract Time	18-2
Controller Timing	7-16
Crash Cushions	4-16, 10-28
Cross Sections	2-23, 2-28, 2-35
Cross Slopes	2-14
Crossing Surfaces	6-3
Data Collection	14-1
Design Consistency	1-6
Design Plans	15-2, 16-1
Design Parameters	1-1
Design Speed	2-2
Design Standard Ranges	2-2
Detours	10-47

Ditches	2-14
Driver Expectancy	1-6
Drop-offs	10-49
Earthwork	3-1
Embankment	3-1
End Treatments	4-9, 10-28
Environmental Documents	14-5
Final Design	13-3
Final Dressing	3-6
Five Year Work Program	13-1
Fixed Standards	2-1
Flaggers	10-31
Friction Course	2-12
Functional Classification	1-4
Geometrics	2-31
Handicap Access	8-4
Horizontal Alignment	2-17
Horizontal Curves	2-17
HVAC	22-26
In-house Design	13-7
Interchanges	2-24
Intersections	2-24, 7-19
Landscaping	9-1
Lane Closure Analysis	10-35
Lane Widths	2-4, 10-35
Layouts	10-32
Left Turns	7-16
Level-of-Service	1-3
Lighting	7-6
Limited Access	2-25
Mailbox Supports	4-20
Marking	7-2
Median Barriers	4-15
Original Plans	14-6
Passing Sight Distance	2-3
Pavement Design	14-5, 15-13
Pavement Marking	10-26
Pay Items	11-1, 18-1
PD & E Studies	1-2, 10-3, 13-2
Pedestrians	8-1
Permits	15-13, 22-6
Plans Processing	17-4
Plans Review	16-1
Plan Revisions	20-1
Pole Design	7-8
Profiles	2-26, 2-32
Project Concept Report	21-2
Project Cost	14-2
Project Description	14-1
Project Development	13-1
Project Letting	13-3

Project Number	14-2
Project Scheduling	13-9, 14-2, 21-4
Quality Assurance	17-1
Quantities	11-1
Railroad Crossings	6-1
Ramp Widths	2-8
Regulatory Speeds	10-51
Right-of-Way	12-1, 15-15
Roadside Barrier	4-8
Rural Projects	2-26
Scope of Services	21-2
Sewage	22-5
Shoulder Widths	2-9
Side Slopes	2-14
Sidewalks	8-2
Sight Distance	10-34
Sign Supports	4-19
Signal Preemption	7-19
Signing	7-2
Signing and Sealing	19-1
Signs	10-17
Specifications	11-1
Speed Zoneing	10-51
Stop Line	7-15
Stopping Site Distance	2-3
Structural Clearances	6-4
Structural Plans	15-5
Submittals	15-1
Subsoil Excavation	3-6
Superelevation	2-22, 10-34
Surveys	14-3, 15-8
Taper Lengths	10-32
Temporary Barrier Walls	10-27
Through Lanes	2-4
Traffic Barriers	10-27
Traffic Control Devices	7-1, 10-16
Traffic Control Plan	10-5, 10-8
Traffic Data	1-2, 14-5
Traffic Signals	10-24, 7-14
Training	10-14
Transitions	2-5, 2-20, 4-11
Truck-Mounted Attenuator	10-29
Typical Sections	15-8
Underdeck Lighting	7-9
Urban Projects	2-30
Utilities	5-1
Utility Coordination	5-8
Utility Relocation	5-2
Value Engineering	15-17
Variable Message Signs	10-21

Verification of Utilities	5-4
Vertical Alignment	2-21
Warning Lights	10-19
Wide Curb Lanes	2-6
Work Zone Traffic Control	10-1
Zoning	22-5