



MEMORANDUM

DATE: September 20, 1991
TO: Plans Preparation Manual Owners
FROM: Ray E. Reissener, State Roadway Design Engineer

A handwritten signature in black ink, appearing to read "Ray E. Reissener".

COPIES:

SUBJECT: **REVISIONS TO THE 1989 PLANS PREPARATION MANUAL**

Enclosed are the revisions to the Plans Preparation Manual that were reviewed by the District Design Engineers in their August 1991 meeting. The revisions, which will be effective on October 15, 1991, were approved with recommended changes. These changes and their disposition are as follows:

- I-1-30 - Deleted the existing paragraph and the proposed revision concerning minimum design LOS
- Section 4.2 - Adopted as revised. The reference to EX-I-4-D was omitted since the exhibit was omitted in June
- Page I-5-90 - Reprinted due to omission of exhibit during last revision
- Chapter 10 revisions were adopted as proposed
- Page I-11-4 - Adopted as proposed. Added section on the purpose of plan notes
- Page I-14-90 - Adopted as proposed (reprint due to repagination)
- Page I-19-20 - Adopted with revisions. Section 19.2.1 - added paragraph making initials and dates on title block optional. Section 19.2.2 - Revised wording defining Record Set

Plans Preparation Manual Revisions
September 20, 1991
Page 2 of 2

- Page I-20-23 0 - Adopted as proposed. Added section 20.2.5 on complete plan revisions. Revised section 20.3 to clarify the revision process after award of the contract.
- Chapter II-1 - Adopted as proposed narrative and exhibits on the preparation of letter plans.
- Page II-2-11 - Proposal to remove the requirement for showing utilities on the profile of the plan/profile sheet was not adopted.
- Page II-3-8.0 - Adopted as proposed. Reworded Section 3.7.1
- Page II-7-4 0 - Adopted as proposed. Revised pay item notes
- Page II-10-5 - Revision was not adopted. (See II-2-11)
- Page II-14-5.0, II-18-2 0 - Revisions requiring utility verification information on drainage structures and cross sections were adopted

Included with the revisions is a list of the pages revised, with a brief description of the section revised. All revised sheets except indexes have been reprinted.

RER Ss

Attachments

PLANS PREPARATION MANUAL REVISIONS

VOLUME I

Index

Add Section 11 3, Page I-11-4.0

Add Section 20 5.5, Page I-20-23 0

Page I-1-3.0

Revised 2nd. paragraph on capacity and level of service Deleted third paragraph

Page I-4-5 0

Delete last sentence referring to exhibit EX-1-4-D, which was removed

Page I-5-9 0 - 10 0

Reprinted. Exhibit I-5-A was omitted when page 9 was revised

Page I-10-18 0

Revised Section 10 10.2, Advance Warning Arrow Panels

Page I-10-51 0

Delete paragraph on Lump Sum MOT

Page I-11-4 0 - 4 1

Added Section 11 3 on plan notes

Pages I-14-9 0 - 10 0

Repaginated due to changes approved 06/05/91

Page I-19-2 0

Added paragraph to 19 2 1, revised Section 19 2.2

Revision Date 08/30/91
Page 2 of 4

Page I-20-23.0

Added Section 20 2 5 for plans completely revised during or after CO processing
Revised Section 20 3 to clarify.

VOLUME II

Index

Add

Section 1.7, Preparation of Letter Plans (8 5" x 14") - General

Section 1 7.1, Scope of Work

Section 1.7.2, Typical Section

Section 1 7 3, Detailed Drawings

Section 1 7.4, Summary of Quantities

Section 1 7 5, Traffic Control Plan

Section 1 8, Letter Plan Format

List of Exhibits - Page x

Add Letter Plan Exhibits, exhibit numbers II-1-B - II-1-G

Page II-1-10 0 - 13.0

Exhibits II-1-B - II-1-G

Added Section on letter plans with exhibits

Page II-3-8 0

Revised Section 3 7 1.

Pages II-7-4 0 -5.0

Deleted Pay Item notes for 325-75 and 327-70, revised note for 5331-2

Page II-14-5 0

Revised Section 14 3

Revision Date 08/30/91
Page 4 of 4

Page II-18-2.0

Revise 3rd. paragraph to require utility verification information to be shown.

ROADWAY PLANS PREPARATION MANUAL

VOLUME II

PLANS PREPARATION AND ASSEMBLY

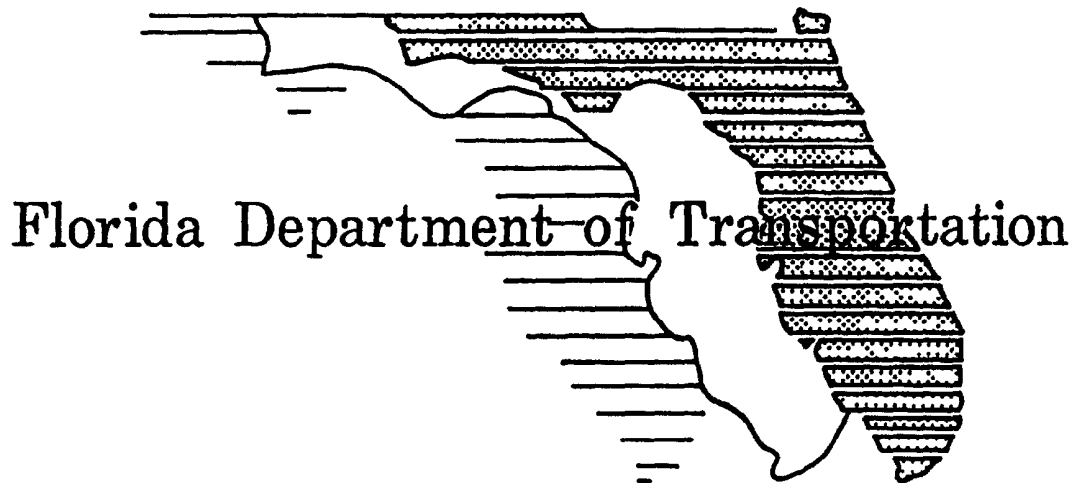

DOCUMENT NO. 625-000-101-B
ROADWAY DESIGN OFFICE

TALLAHASSEE, FLORIDA
1989

TABLE OF CONTENTS

VOLUME II

PLANS PREPARATION AND ASSEMBLY

		<u>Page</u>
<u>Introduction</u>		xv
<u>Chapter 1</u>	Production of Plans	II-1-1.0
1.1	General	II-1-1.0
1.2	Legibility Guidelines	II-1-1.0
1.3	Material	II-1-3.0
1.4	Base Sheet Format	II-1-3.0
	1.4.1 Title Block	II-1-3.0
1.5	Plan Sheets	II-1-5.0
1.6	Material Purchasing	II-1-7.0
	1.6.1 Partial List of Vendors and Products	II-1-7.0
	1.6.2 Partial List of Vendors	II-1-8.0
<u>Chapter 2</u>	Sequence of Plans Preparation	II-2-1.0
2.1	General	II-2-1.0
2.2	Data Collection and Presentation	II-2-2.0
2.3	Phase Submittals	II-2-5.0
2.4	Requirements for Phase I-30-35% Complete Plans Submittal	II-2-7.0
2.5	Phase I-30-35% Submittal	II-2-8.0
2.6	Requirements for Phase II-60-65% Complete Plans Submittal	II-2-14.0
2.7	Phase II-60-65% Submittal	II-2-15.0

2.8	Requirements for Phase III-90-95% Complete Plans Submittal	II-2-27.0
2.9	Requirements for Phase IV- 100% Complete Plans Submittal	II-2-28.0
<u>Chapter 3</u>	Key Sheet	II-3-1.0
3.1	General	II-3-1.0
3.2	Project Data	II-3-2.0
	3.2.1 Project Number, County Name and Road Number	II-3-2.0
	3.2.2 Item Number ^{Program} Item Number and Fiscal Year	II-3-2.0
	3.2.3 Length of Project Box	II-3-3.0
3.3	Project Location Map	II-3-4.0
3.4	North Arrow and Scale	II-3-6.0
3.5	Plans in Contract Plans Set	II-3-6.0
3.6	Index of Sheets and Standard Index Reference	II-3-6.0
3.7	Approval Signatures and Consultant's Name	II-3-8.0
	3.7.1 Approval Signature	II-3-8.0
	3.7.2 Consultant's Name	II-3-8.0
3.8	Governing Specifications	II-3-10.0
3.9	State Map	II-3-10.0
3.10	Railroad Crossing	II-3-10.0
3.11	Revision Dates	II-3-10.0
	Exhibits	II-3-A to F
3.12	R-R-R Projects	
<u>Chapter 4</u>	Summary of Pay Items	II-4-1.0
4.1	General	II-4-1.0
4.2	Summary of Pay Items Sheet Exhibits	II-4-1.0 II-4 A to B

<u>Chapter 5</u>	Drainage Map	II-5-1 0
5 1	General	II-5-1 0
	5 1 1 Flood Data Summary Box	II-5-2 0
5 2	Plan Portion	II-5-3 0
5 3	Profile Portion	II-5-5 0
5 4	Interchange Drainage Map	II-5-7 0
5 5	Bridge Hydraulic	
	Recommendation Sheet	II-5-8 0
	5 5 1 Required Information	
	on BHRS	II-5-8 0
	Exhibits	II-5-A to C
<u>Chapter 6</u>	Typical Sections	II-6-1 0
6 1	General	II-6-1 0
6 2	Mandatory Information	II-6-3 0
6 3	Standard Notes for Typical	
	Section Sheets	II-6-5 0
	Exhibits	II-6-A to H
<u>Chapter 7</u>	Summary of Quantities	II-7-1 0
7 1	General	II-7-1 0
7 2	Item Quantity "Boxes" and	
	Format	II-7-1 0
7 3	Box Culvert Data Sheets	II-7-2 0
7 4	Standard Notes for Summary	
	of Quantities Sheet	II-7-3 0
7 5	Pay Item Notes	II-7-5 0
	Exhibits	II-7-A to C
<u>Chapter 8</u>	Summary of Drainage Structures	II-8-1 0
8 1	General	II-8-1 0
8 2	Sheet Setup and Data	II-8-2 0
	Exhibits	II-8-A to C

<u>Chapter 9</u>	Project Layout	II-9-1 0
9 1	General	II-9-1 0
9 2	Alignment Sheet Sequence	II-9-2 0
9 3	Survey Reference Points	II-9-3 0
9 4	General Notes	II-9-3 0
	Exhibit	II-9-A
<u>Chapter 10</u>	Roadway Plan and Profile	II-10-1 0
10 1	General	II-10-1 0
10 2	Roadway Plan Portion	II-10-2 0
	10 2 1 Centerline	II-10-2 0
	10 2 2 Horizontal Curves	II-10-3 0
	10 2 3 Existing Topography	II-10-4 0
	10 2 4 Reference Data	II-10-5 0
	10 2 5 Construction and Project Limits	II-10-6 0
	10 2 6 Drainage Structures and Bridges	II-10-7 0
	10 2 7 Plan Layout	II-10-8 0
10 3	Roadway Profile Portion	II-10-10 0
	10 3 1 General Data	II-10-10 0
	10 3 2 Vertical Curves	II-10-11 0
	10 3 3 Grades	II-10-12 0
	10 3 4 Superelevation	II-10-12 0
	10 3 5 Drainage Features	II-10-12 0
10 4	General Notes for Plan-Profile Sheets	II-10-16 0
	Exhibits	II-10-A to C

<u>Chapter 11</u>	Special Profiles	II-11-1.0
11.1	General	II-11-1.0
11.2	Intersections	II-11-2.0
11.3	Curb Returns	II-11-3.0
11.4	Ramps	II-11-4.0
11.5	Spline Grade	II-11-5.0
11.6	Superelevation	II-11-6.0
	Exhibits	II-11-A to B
<u>Chapter 12</u>	Back-of-Sidewalk Profiles	II-12-1.0
12.1	General	II-12-1.0
12.2	Required Information	II-12-2.0
12.3	Sheet Setup	II-12-4.0
	Exhibit	II-12-A
<u>Chapter 13</u>	Intersection and Interchange	
	Details/Layout	II-13-1.0
13.1	General	II-13-1.0
13.2	Intersections	II-13-2.0
13.3	Interchanges	II-13-3.0
	13.3.1 Geometric Layout	II-13-3.0
	13.3.2 Ramp Terminal Details	II-13-6.0
	13.3.3 Cross Section Pattern	
	Sheet	II-13-7.0
	Exhibits	II-13-A to F
<u>Chapter 14</u>	Drainage Structures	II-14-1.0
14.1	General	II-14-1.0
14.2	Required Information	II-14-3.0
14.3	Utility Conflicts	II-14-5.0
14.4	Sheet Setup	II-14-6.0
	Exhibits	II-14-A to G

<u>Chapter 15</u>	Outfall/Lateral Ditch System	II-15-1.0
15.1	General	II-15-1.0
15.2	Plan Portion	II-15-2.0
	15.2.1 Lateral Ditch	II-15-2.0
	15.2.2 Outfall	II-15-2.0
15.3	Profile Portion	II-15-3.0
	15.3.1 Lateral Ditch	II-15-3.0
	15.3.2 Outfall	II-15-4.0
15.4	Typical Section	II-15-5.0
15.5	Ditch Cross Sections	II-15-5.6
15.6	Retention or Detention Pond	II-15-7.0
	Exhibits	II-15-A to B
<u>Chapter 16</u>	Special Details	II-16-1.0
16.1	General	II-16-1.0
<u>Chapter 17</u>	Soil Survey	II-17-1.0
17.1	General	II-17-1.0
17.2	Roadway Soil Survey	II-17-2.0
	17.2.1 Method of Compilation and Presentation	II-17-2.0
17.3	Borrow Pit Soil Survey	II-17-3.0
	Exhibits	II-17-A to B
<u>Chapter 18</u>	Roadway Cross Sections	II-18-1.0
18.1	General	II-18-1.0
18.2	Required Information	II-18-2.0
18.3	Sheet Setup	II-18-4.0
	Exhibits	II-18-A to C
<u>Chapter 19</u>	Traffic Control Sheets	II-19-1.0
19.1	General	II-19-1.0
19.2	Required Information	II-19-2.0
19.3	Format and Scale	II-19-4.0
	Exhibits	II-19-A to B

<u>Chapter 20</u>	Utility Adjustment	II-20-1.0
20.1	General	II-20-1.0
20.2	Required Information	II-20-1.0
20.3	Sheet Format and Scale	II-20-2.0
	Exhibit	II-20-A
<u>Chapter 21</u>	Selective Clearing and Grubbing	II-21-1.0
21.1	General	II-21-1.0
21.2	Required Information and Sheet	
	Setup	II-21-1.0
21.3	Standard Symbols and Notes	II-21-2.0
	Exhibits	II-21-A
<u>Chapter 22</u>	Approach Slabs	II-22-1.0
22.1	General	II-22-1.0
<u>Chapter 23</u>	Signing and Pavement Marking Plans	II-23-1.0
23.1	General	II-23-1.0
23.2	Key Sheet	II-23-1.0
23.3	Tabulation of Quantities and	
	Standard Notes	II-23-2.0
23.4	General Notes	II-23-2.0
23.5	Plans Sheets	II-23-3.0
	23.5.1 Format and Scale	II-23-3.0
	23.5.2 Required Information	II-23-4.0
23.6	Guide Sign Work Sheet	II-23-5.0
23.7	Overhead Sign Cross Section and	
	Support Structure	II-23-5.0
23.8	Typical Pavement Marking Sheet	II-23-5.0
	Exhibits	II-23-A to F

<u>Chapter 24</u>	Signalization Plans	II-24-1.0
24.1	General	II-24-1.0
24.2	Key Sheet	II-24-1.0
24.3	Tabulation of Quantities and Standard Notes	II-24-2.0
24.4	General Notes	II-24-2.0
24.5	Plan Sheets	II-24-3.0
	24.5.1 Format and Scale	II-24-3.0
	24.5.2 Required Information	II-24-4.0
24.6	Pole Schedule	II-24-6.0
24.7	Interconnect/Communication Plan Exhibits	II-24-7.0 II-24-A to C
<u>Chapter 25</u>	Highway Lighting	II-25-1.0
25.1	General	II-25-1.0
25.2	Key Sheet	II-25-2.0
25.3	Tabulation of Quantities and Standard Notes	II-25-2.0
25.4	Pole Data and Legend Sheet	II-25-3.0
25.5	Plan Sheets	II-25-4.0
	25.5.1 Format and Scale	II-25-4.0
	25.5.2 Required Information	II-25-5.0
25.6	Foundations and Boring Detail Sheets Exhibits	II-25-7.0 II-25-A to H
<u>Chapter 26</u>	Highway Landscape	II-26-1.0
26.1	General	II-26-1.0
26.2	Key Sheet	II-26-1.0
26.3	Tabulation of Quantities	II-26-2.0
26.4	Standard Details and Notes	II-26-2.0
26.5	Plan Sheet	II-26-3.0
	26.5.1 Format and Scale	II-26-3.0
	26.5.2 Plan Sheets	II-26-4.0
	Exhibits	II-26-A to D

<u>Chapter 27</u>	Utility Contract Plans	II-27-1.0
27.1	General	II-27-1.0
27.2	Key Sheet	II-27-1.0
27.3	Summary of Quantities	
	Standard Notes and	
	Summary of Pay Items	II-27-1.0
27.4	Plan Sheets	II-27-2.0
Appendix A		II-A-1

List of Exhibits

Exhibit	Number
Key Sheet	
Roadway Plans	II-3-A
Signing and Pavement Marking Plans	II-3-B
Signalization Plans	II-3-C
Lighting Plans	II-3-D
Landscape Plans	II-3-E
Examples of Key Sheet Titles	II-3-F
 Summary of Pay Items	
Computer Output	II-4-A
Plan Sheet	II-4-B
 Drainage Map	
Drainage Map (Urban)	II-5-A
<i>Flood Data Summary Box</i>	<i>II-5-A-1</i>
Supplementary Drainage Map	II-5-B
<i>Bridge Hydraulic Recommendation Sheet</i>	<i>II-5-C</i>
 Typical Sections	
Rural	II-6-A
Urban with Refuge Lanes	II-6-B
Without Refuge Lanes	II-6-C
Urban Minimum Requirements	II-6-D
Interstate	II-6-E
Interstate Ramps	II-6-F
Widening and Resurfacing	II-6-G
Milling and Resurfacing	II-6-H
 Summary of Quantities	
Box Culvert Computer Output	II-7-A
Box Culvert Plan Sheet	II-7-B
Summary of Quantities	II-7-C

Summary of Drainage Structures	
Summary of Drainage Structures	II-8-A
Optional Pipe Materials Tabulation	II-8-B
Optional Pipe Materials Tabulation (Suppl.)	II-8-C
Project Layout	
Project Layout Sheet	II-9-A
Roadway Plan Profile	
Plan - Profile Urban	II-10-A
Plan - Profile Rural	II-10-B
Begin and End Stations	II-10-C
Special Profiles	
Intersection Profiles	II-11-A
Interchange and Ramp Profiles	II-11-B
Back-of-Sidewalk Profile	
Back-of-Sidewalk Profile	II-12-A
Intersection and Interchange Details/Layout	
Intersection Detail	II-13-A
Intersection Detail Plan	II-13-B
Intersection Detail - Profile	II-13-C
Interchange Layout	II-13-D
Interchange Detail	II-13-E
Cross Section Pattern	II-13-F
Drainage Structures	
Drainage Structures (Urban)	II-14-A
Drainage Structures (Urban)	II-14-B
Drainage Structures (Rural)	II-14-C
Drainage Structures	II-14-D
Drainage Structures	II-14-E
Drainage Structures	II-14-F
Typical Drainage Structure	II-14-G

Lateral Ditch	
Lateral Ditch Plan - Profile and Detention Pond Details	II-15-A
Lateral Ditch Cross Section	II-15-B
Soil Survey	
Roadway Soil Analysis	II-17-A
Borrow Pit Soil Survey	II-17-B
Roadway Cross Sections	
Rural Undivided	II-18-A
Urban	II-18-B
Rural Divided	II-18-C
Traffic Control Plans	
Traffic Control Plan	II-19-A
Traffic Control Plan - Phasing	II-19-B
Utility Adjustment	
Utility Adjustment	II-20-A
Selective Clearing and Grubbing	
Legend Legend Sheet	II-21-A
Signing and Marking	
Tabulation of Quantities	II-23-A
Tabulation of Quantities Con't.	II-23-B
Typical Marking Plan	II-23-C
Plan Sheet	II-23-D
Sign Detail	II-23-E
Guide Sign Worksheet	II-23-F

Signalization Plans	
Tabulation of Quantities	II-24-A
Signalization Plan	II-24-B
Interconnect/Communication Cable Plan	II-24-C
Highway Lighting	
Tabulation of Quantities	II-25-A
Pole Data and Legend Sheet	II-25-B
Lighting Plan Sheet	II-25-C
Lighting Plan Sheet	II-25-D
Plan Sheet	II-25-E
High Mast Pole Foundations	II-25-F
Boring Locations	II-25-G
Boring Data	II-25-H
<i>Highway Landscape</i>	
Tabulation of Quantities	II-26-A
Standard Details	II-26-B
Landscape Plans	II-26-C
Landscape Plans	II-26-D

VOLUME II
PLANS PREPARATION AND ASSEMBLY
INTRODUCTION

The Plans Preparation and Assembly Manual is part of a two volume set of criteria guidelines, standards and techniques used to develop roadway plans for the Florida Department of Transportation.

This volume has been prepared to aid in the development of a set of roadway plans. The first two chapters of this volume are introductory in nature. Following these, there is a chapter for each plan sheet, describing the purpose of the sheet and providing specific instructions on its preparation. Exhibits of sample sheets follow each chapter. A complete glossary can be found at the back of this volume. This volume is specifically written for Computer Aided Drafting and Design (CADD) procedures. If plans are prepared by manual methods, the same information is to be shown using good drafting standards and practices. Reproduction Quality of all plans must be considered during their preparation. The drafting quality and lettering size must be adequate to be read when reduced in size by 50%

In addition to this volume, the DOT's CADD Roadway Standards and Guidelines provides information specifically applicable to CADD. The DOT CADD manual, in conjunction with this volume, provides requirements, techniques, standards and guidelines necessary to prepare and assemble a set of roadway plans. The technician should also have the Roadway and Traffic Design Standards available during the preparation of roadway plans.

Volume I of this manual, "Design Criteria and Process," provides directions on the criteria to be applied to roadway design and the process to be followed in developing a highway project from beginning to completion of design. Volumes I and II, collectively, make up the Roadway Plans Preparation Manual.

CHAPTER 1

PRODUCTION OF PLANS

1.1 General

The readability and quality of plans is highly dependent upon the choice of appropriate drafting materials, the utilization of correct drafting techniques and the reproduction processes that are employed. Therefore, these techniques and material choices are of paramount importance for they dictate the degree of success achieved.

It is the responsibility of the technician and drafter to ensure the accuracy, timeliness, legibility and neatness of the plans.

1.2 Legibility Guidelines

Normally, all letters and figures should be readable from either the bottom or right edge of the sheet. The guide for reading is as follows:

- (1) Horizontal Line Read left to right
- (2) Vertical Line Read bottom to top
- (3) Diagonals Read left to right

Abbreviations may be used where they save time and space. Abbreviations must be clear and easily understood. A list of standard abbreviations is given in the booklet of Roadway and Traffic Design Standards - Index 001.

Any object which is drafted repeatedly should be symbolized. Symbols are necessary to reduce drafting time, increase legibility, and conserve space.

Standard symbols for Roadway Design are shown in the booklet of Roadway and Traffic Design Standards - Index 002 and in the Roadway CADD Manual

| Bearings should be shown on plans to the nearest second, station pluses to
| the nearest 1/100 (two decimal places), coordinates to the nearest 1/1000
| (three decimal places), percent of grade to the nearest 1/10000 (four decimal
| places), surface elevations on paved surfaces to the nearest 1/100 (two
| decimal places) and ground elevations to the nearest 1/10 (one decimal place)

When aerial photo sheets are used in plans, they must be original sheets. No
2nd generation copies of photo sheets are to be used. Aerial photo images
| should not be so dark as to obscure the drafting. Xerographic prints of aerial
| photo sheets shall be made early in the design process to ensure legibility.
| If the photocopies are too dark, the aerials should be remade. In areas where
the photo image may block the drafted image, the photo image must be removed
| from the back of the sheet. (Make sure the emulsion is removed behind all
| notes so areas will not be burned out.)

Black ink must be used on aerial photo sheets, both in the plan and profile
portion. No lead or grease pencils are to be used. No colored ink is to be
used.

Reverse sepias are not to be used as final plan sheets.

1.3 Material

Polyester film (mylar) shall be a highly translucent, 3 mil minimum thickness,
with black imagery. Translucent paper (Vellums) shall be 16 or 17 lb
(medium weight) or 0027" thickness, 100% white rag, fine or medium toothed
with 50% transparency.

CADD prepared mylar shall be tested for ink durability, if laser or electrostatic plotters are utilized

CADD prepared plan sheets may also be 20 lb opaque paper or 18 lb semi-translucent paper

1.4 Base Sheet Format

All final plan sheets except CADD-prepared plans shall be 24 inches by 35 or 36 inches. The border shall be 1 1/2 inch from the top and bottom edge, 1/2 inch from the right edge, and 2 1/2 or 3 1/2 inches from the left edge. Two 1/4" holes on 12" centers shall be punched 6" from the top and bottom and 1/2" (to center of hole) from the left edge. The viewing area for all sheet formats shall be 21" X 32"

Final plots and xerographic signed and sealed prints of CADD prepared plans may be plotted to true scale on 11" X 17" bond

1.4.1 Title Block

All sheet formats, except the key sheet, shall have a standard title block at the bottom of the sheet. The title block shall provide for the listing of sheet revisions, the name and logo of the design consultant (if applicable), and the sheet title. The title block may also provide for the date and initials of the designer, the checker, the drafter (CADD operator) and the supervising engineer, FDOT title, approval signature (responsible professional engineer, in-house or consultant) and date. Initials shall be mechanically produced by CADD. Signing and sealing requirements are discussed in greater detail in Volume I of this manual.

A block shall be provided in the upper right corner to show the project and sheet numbers For a complete illustration of the sheet format with a title block, see the Exhibits at the end of the chapters

For alternate title block formats, see Exhibit II-1-A

1.5 Plan Sheet Formats

The following is a description of the various plan sheet formats and their use. The CADD Manual contains descriptions of the CADD cells that contain these formats, and their use.

Key Sheet:

Material - Mylar or vellum

Format - See Chapter 3

Use - Key Sheet

Plan and Profile

Material - Mylar or vellum

Format - The top half for the plan, the bottom half profile grid format (See Chapter 10)

Use - Plan and Profile, ~~Drainage/Utility~~ Utilities, Selective Clearing and Grubbing, Traffic Control Sheets, Lateral Ditch or Outfall Ditch Sheet

Profile (Also used as a Cross Section Sheet):

Material - Mylar or vellum

Format - Cross Section grid format (See Chapter 18)

Use - Roadway Cross Sections, Special Profiles, Superelevation Diagrams (if needed), and Drainage Structure Sheet

Plan:

Material - Mylar or vellum

Format - Border with the project number and sheet number box in the upper right hand corner of the sheet and the signature/revision/title block along the bottom. For base sheet format, see Chapter 9. Use - Typical Sections, Summary of Quantities, Summary of Drainage Structures, Special Details, Design Data, Roadway Soil Survey Sheets, Curve and Coordinate Data Sheet, Interchange Drainage Map, Project Layout, Traffic Control Sheets, Roadway Lighting Sheet, Signing and Pavement Marking and Signalization Sheet.

Bridge Hydraulic Recommendation Sheet:

Material - Mylar

Format - Plan format with 'boxes' (see chapter 5)

Use - Bridge Hydraulic Recommendation Sheet

~~For safe storage purposes, the first and last sheets in a plan's set of reproductions shall be mylar sheets.~~

Drainage Map

Material - mylar or vellum

Format - Top portion profile grid, bottom portion plan (see chapter 5)

Use - Drainage Map

1.6 Material Purchasing

1.6.1 Partial List of Vendors and Products

Statewide Vendor	Roll Mylar	Roll Vellum	Bond Paper
<hr/>			
Anderson			
Reprographics	-	-	-
Bruning	X	X	X
Dietzgen	X	X	X
K & E	X	X	X
Teledyne Post	X	X	X
United Paper Co.	X	X	X
Triangle			
Reprographics	X	X	X

1.6.2 Partial List of Vendors

Anderson Reprographics
250 Park Street
Jacksonville, FL 32204
1-800-356-4271

AM International
Bruning Division
7151 Lake Eleanor Drive
Orlando, FL 32809
(407) 855-7121

Dietzgen Corporation
4268 L.B. McLeod Road
Orlando, FL 32811
1-800-228-5244

Dietzgen Corporation (for Panhandle area west of Tallahassee)
4920 Lewis Road
Stone Mountain, GA 30083
1-800-241-6663

K & E Company
1604 Sligh Blvd.
Orlando, FL 32806
1-800-552-6733
1-800-552-6734 (FAX)

Teledyne Post
4210 L B McLeod Road
Suite 109
Orlando, FL 32811
(407) 841-1034

Triangle Reprographics
417 West Gore Street
Orlando, FL 32806
1-800-432-6866

United Paper Company
1090 King Georges Post Road
Suite 507
Edison, NJ 08837
1-800-526-2364
1-201-417-0897(FAX)

1.7 Preparation of Letter Plans (8.5" x 14") - General

The Letter Plan preparation procedure as described in this chapter is approved for use on both State funded and Federal Aid participating projects. Projects such as Resurfacing, Intersection Improvements, Sidewalk Construction, Signal Installations, and Guardrail Construction are all candidates for this format.

This method is not an attempt to reduce the amount of construction information in the plans but to accurately describe the project in a form that is more convenient for reproducing, handling and storing. The main intent of the Letter Plan format is to reduce the amount of drafting that is normally done with a standard set of plans. It is not intended to compromise good engineering practices. All criteria, engineering responsibility and documentation normally required are applicable to Letter Plans.

The designer must carefully consider the scope of work to determine how much detail is required. Letter size typical sections, detailed sketches, and tabulations of quantities may still be needed in the plans to accurately describe the project. The various components of a set of letter plans are discussed below.

1.7.1 Scope of work

Since plan/profile sheets are not used a detailed scope of work narrative is required. It should include any drainage work, signal work, signing, and pavement marking work that will be required. The scope does not necessarily need to be a detailed description of the work but should outline each major operation.

172 Typical Section

Letter plans, like standard plans, are required to have a typical section. For many projects a detailed description can be used in place of a drawing. Cross slopes, proposed pavement widths, ditch slopes, and grassing limits can often be described sufficiently without a drawing of a standard section. The design speed is also required for each Typical

Along with the typical section the plans are also required to contain the proposed pavement design. This can be done in the same manner as standard size plans. The pavement design shall show thicknesses and/or options for base, structural course, leveling course, and friction course. It shall also include proposed milling depths.

173 Detailed Drawings

On some Letter Plan projects detailed drawings will be needed to show dimensions of certain pavement areas or other special construction information. When details are used they should be legible and free of extraneous information. Too much text on this size sheet can make it difficult to read.

174 Summary of Quantities

In order to document quantity calculations a tabulation may be required in the plans. All tabulations shall be clear and concise. Space shall be provided for both plan and final quantity. Good judgement should be used in determining if a tabulation of a specific item is truly needed for this type of project.

175 Traffic Control Plan

Selecting the letter plan format does not exempt the project from having a well documented traffic control plan. Phasing descriptions, sketches, general notes, and typical sections should still be utilized when construction warrants it.

1.8 Letter Plan Format

The preparation of a set of letter plans should follow the guidelines as shown below

- 1 Use legal size (8 5" x 14") for all sheets
- 2 The F A project number and W P I number shall be shown on the Key Sheet Show the state project number on all sheets
- 3 Space must be provided on the Key Sheet for the designer/Project Manager and approval by the responsible professional engineer
- 4 All railroad crossings shall be shown on the Key Sheet in accordance with chapter 3 10 of Volume II of this manual
- 5 If the project is designed with R-R-R standards this should be noted on the Key Sheet
- 6 All sheets including pay item sheets are to be numbered sheet 1 of __, sheet 2 of __, etc Signing and pavement marking sheets are to be numbered consecutively with the rest of the plans
- 7 The standard governing specifications note used on all plans must be shown on letter plans The Roadway and Traffic Design Standards booklet shall be referenced in the plans also
- 8 All summary of pay item sheets are to be inserted directly behind the Key Sheet Trim the "green bar" computer sheets to proper size, do not reduce by xeroxing
- 9 Revisions to letter plans shall be documented in the same manner as standard size plans Space should be provided on each sheet for a revision log

SAMPLE (A)

DATE	FLORIDA DEPARTMENT OF TRANSPORTATION	JOHN Q. PUBLIC ENGINEERING COMPANY	TABELATION OF QUANTITIES
	APPROVED BY :		
	DATE :		

SAMPLE (B)

DATE	FLORIDA DEPARTMENT OF TRANSPORTATION	JOHN Q. PUBLIC ENGINEERING COMPANY	TABELATION OF QUANTITIES
	APPROVED BY :		
	DATE :		

SUMMARY OF ROADWAY PAY ITEMS		UN	IT	FA PART	QUANTITY	
A S L P T C	ITEM NUMBER	ITEM	UN	IT	FA PART	QUANTITY
1	101-1-1	MOBILIZATION	LS		1,000	1,000
1	102-1-1	MAINT OF TRAFFIC BARRICADE (TEMPORARY TYPES: 1, 1 1/2, VP & DRUM)	ED		1,000	1,000
2	102-74-1	CONSTRUCTION SIGNS (TEMP - POST MOUNTED)	ED		7560,000	7560,000
2	102-75-1	ADVANCE WARNING ARROW PANELS	ED		2520,000	2520,000
2	102-76-1	HIGH INTENSITY FLASHING LIGHTS (TEMP - TYPE B)	ED		180,000	180,000
2	102-77-1	REMOVABLE PAVEMENT MARKING (SOILID)	ED		1320,000	1320,000
2	102-98-2	TEMPORARY REGULATORY SIGNS (POST-MOUNTED)	ED		4126,000	4126,000
1	104-10-1	BALED HAY OR STRAW	ED		240,000	240,000
1	110-1-1	CLEARING & GRUBBING (F&B)	LS		1,000	1,000
2	110-7-1	MATERIAL EXCAVATION (SINGLE)	EA		10,000	10,000
1	120-1-1	REGULAR EXCAVATION	CT		722,000	722,000
1	160-4-1	TYPE B STABILIZATION (BASE GROUP 11)	SY		1242,000	1242,000
1	285-71-1	OPTIONAL BASE (TACK COAT)	SY		2051,000	2051,000
1	300-1-3	BIT MALT	GA		240,000	240,000
1	339-1-1	MISC ASPHALT PAVEMENT INLETS (OT BOT) (TYPE E)	TN		14,200	14,200
1	425-1-551	CONC PIPE: CULV (CLASS 111)	EA		2,000	2,000
1	430-11-325	MITERED END SECTION (CONR PIPE ROUND)	EA		16,000	16,000
3	430-984-325	CONC CURB & GUTTER (TYPE E)	EA		2,000	2,000
1	520-1-7	END ANCHORAGE ASSEM TYPE IV	EA		79,000	79,000
1	536-9-1	RESET GUARDRAIL	EA		1,000	1,000
1	538-1-1	SEED & MULCH (PERMANENT TYPE)	EA		425,000	425,000
1	570-2-1	GRASS SEED	SY		1297,000	1297,000
1	570-3-1	MULCH MATL	LB		13,000	13,000
1	570-4-1	FERTILIZER	TN		1,100	1,100
1	570-5-1	WATER FOR GRASS	MG		2,000	2,000
1	570-9-1	SOODING (QUICK-GROWING TYPE)	LB		337,000	337,000
1	575-1-6	TYPE S ASPH CONC (INC BIT)	SY		399,600	399,600
2	5331-2-5	ASPH CONC (FRICION COURSE) (INC BIT) (11" X 1/2" OR 4")	TN		1998,000	1998,000
2	5331-1-5		ST			
		TOTAL				

NOTE: IDENTIFIES ITEMS NORMALLY REQUIRING SHOP DRAWINGS - CONTRACTOR SHALL DETERMINE OTHER ITEMS REQUIRING SHOP DRAWINGS.

SUMMARY OF SIGNING PAY ITEMS		UN	IT	FA PART	QUANTITY	
A S L P T C	ITEM NUMBER	ITEM	UN	IT	FA PART	QUANTITY
1	700-72-1	RELOCATE EXISTING SIGN (ONE POST)	AS		6,000	6,000
1	706-1-12	REFLECTIVE PAVEMENT MARKER (B)	EA		30,000	30,000
1	711-4-1	DIRECTIONAL ARROWS THERMOPLASTIC	EA		8,000	8,000
1	711-6-41	SOLID TRAFFIC STRIPE THERMOPLASTIC (4")	LF		2255,000	2255,000
		TOTAL				

NOTE: IDENTIFIES ITEMS NORMALLY REQUIRING SHOP DRAWINGS - CONTRACTOR SHALL DETERMINE OTHER ITEMS REQUIRING SHOP DRAWINGS.

XXXXX-XXXX

Scope of Work

This project consists of adding left turn lanes at two locations and adding an acceleration lane at a third location. It also includes removing two existing ditch bottom inlets and replacing them with type 'E' inlets with traversable slots to the north. Each of the inlets will require an additional 8' of 18" concrete pipe and a pipe collar for connection to existing pipe. An existing 18" C.M.P. side drain culvert under a paved drive located at M.P. 22.031 (rt.) will require the installation of 2 mitered end sections.

This project will also require 4" thermoplastic traffic stripes (white and yellow) with reflective pavement markers and thermoplastic directional arrows to be placed in accordance with the Roadway and Traffic Design Standards.

This scope also includes resetting approximately 425 feet of existing guardrail which is located at M.P. 21.873 (Rt.) and replacing an existing Type II end anchorage with a Type IV end anchorage. This work is also to conform to the Roadway and Traffic Design Standards.

Roadway and Traffic Design Standards Booklet Dated January 1990

Governing Specifications:

State of Florida Department of Transportation, Standard Specifications, dated 1991 and supplements thereto if noted in the special provisions for this project.

Typical Section and Pavement Design

The proposed widening at each location shall be constructed using Optional Base Group 11 with Type S Structural Course (400 lbs./S.Y. avg.) and Friction Course FC-1 or FC-4 (1" thick). This pavement shall have a cross slope of .02 ft./ft. adverse to the existing roadway to drain into the median.

In addition to the proposed pavement a 6' stabilized shoulder shall be constructed (min. LBR 30) in the median adjacent to the new pavement edge. The proposed shoulder shall be stabilized to a depth of 6" and have a .06 ft./ft. cross slope down from the edge of pavement to provide drainage to the median.

A 6:1 slope shall be used from the edge of the proposed shoulder to natural ground in the median. Standard Clearing and Grubbing will be required within the areas of construction. A 16" sod strip shall be placed in the median adjacent to the proposed pavement edge with the remaining shoulder and 6:1 slope being seeded and mulched.

Design Traffic Data

Design Speed 55 m.p.h.

Est. 1989 (2 way)	16,000 ADT
Est. 1994 (2 way)	19,500 ADT
Est. 1999 (2 way)	23,600 ADT
Est. 2009 (2 way)	32,400 ADT

K = 10%, D = 59%, T = 5%

Pg. ___ of ___

EX 11-1-D

SUMMARY OF INTERSECTIONS

M. P.	TYPE
21.910	I
22.031	I
22.477	II

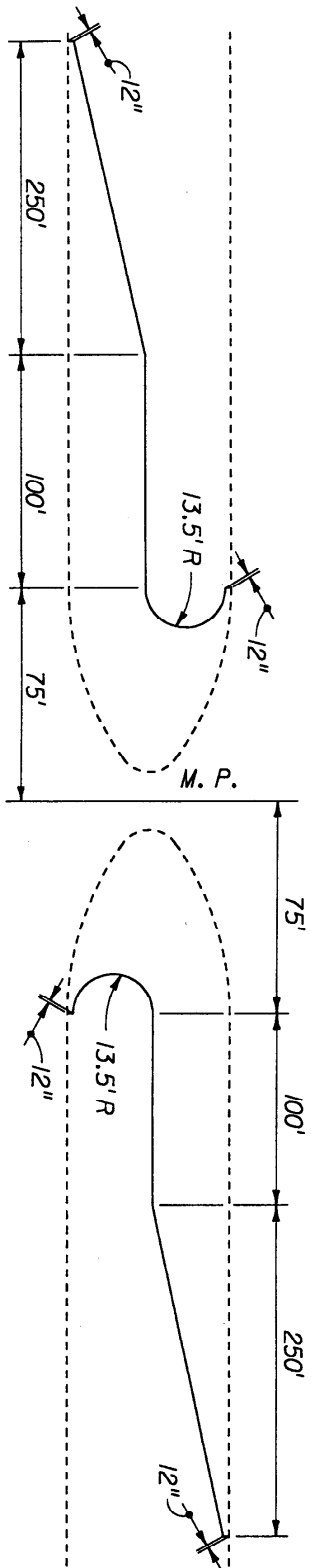

TYPE I

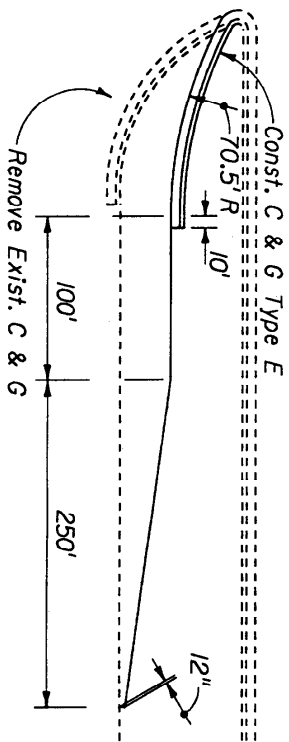
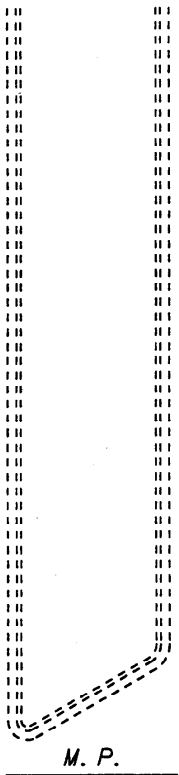

TYPE II

XXXXX-XXXX

General Notes

1. Stabilized subgrade is not required on this project. The widening strip shall be compacted to the density specified in specification 120-9-2.1.
2. For additional details see index nos. 500, 505, and 513.
3. All of the existing limerock base that is removed is to be incorporated in the stabilized portion of the shoulder.
4. The contractor shall use low profile relective pavement markers, Class B specifications as per special provisions 706-2.2 and as listed in the Qualified products list.
6. The existing buried telephone duct crossing the roadway at M.P. 22.537 is to remain.

Utility Owners

Telephone Numbers

Southern Bell Telephone (904) 331-9123

Summary of Quantities

SUMMARY OF EARTHWORK

Roadway Excavation	722 C.Y.
Fill	300 C.Y.
Fill + 50%	451 C.Y.
Excess	271 C.Y.

Pay Item Notes

- 102-1 Includes the cost of all items which are needed for traffic control and are not specifically included in the roadway Summary of Pay Items.
- 110-1-1 Includes the cost of removing 15.75 SY of type "E" curb and gutter.
- 300-1-3 Based on three lifts.
- 339-1 To be used as needed for paving under the reset guardrail.
- 538-1 Includes the cost of replacing any post and panels determined to be non-salvageable during resetting.
- 570-3 All permanent grass seed shall be hulled bermuda grass seed and shall be of the common variety.
- 570-4 Dry mulch material shall consist of bermuda, oat, wheat and/or rye straw.
- 700-72-1 Consists of 4 green/amber single post delineators and 2 single post regulatory signs. A "Reduced Speed Ahead" sign (M.P. 21.916) is to be relocated ten feet ahead. A "Speed Limit 55" sign (M.P. 22.051) is to be relocated directly in front of an existing "Speed Limit 45" sign in the center of the median.
- 711-6-41 Based on 1755 L.F. of yellow and 500 L.F. of white.

Pg. ___ of ___

EX-11-1-F

~~XXXXX-XXXX~~

Maintenance of Traffic

1. Use Index 623 to close inside lane(s) while constructing base and pavement for turn lanes.
2. Maintain median access for turn movements at all times.
3. Use Index 611 for guardrail and drainage structure activities.
4. NORTHBOUND: Place "Road Construction Ahead" signs at M.P. 21.638 and "End Construction" signs at M.P. 22.604.
SOUTHBOUND: Place "Road Construction Ahead" signs at M.P. 22.642 and "End Construction" signs at M.P. 21.638.

CHAPTER 2

SEQUENCE OF PLANS PREPARATION

2.1 General

The contract plans set and the specifications are the key documents on which the contractor bases his bid for a construction project. These documents are also used in the construction of the project. Hence, it is imperative that the contract plans and specifications set forth the work to be done in a clear and concise manner to avoid misinterpretation.

The set of plans depicting in detail the desired construction work is known as the "Contract Plans Set". This set consists of all sheets pertaining to roadway design, together with "Component Plan Sets." The component plan sets are comprised of:

- Signing and pavement marking plans
- Signalization plans
- Highway lighting plans
- Landscape plans
- Utility contract plans
- Architectural plans
- Structural plans

The contract plans set should be prepared systematically, undergoing various stages of review and revision to ensure technically correct and clear plans.

2.2 Data Collection and Presentation

Data required for a roadway design project may be obtained from field survey, aerial survey, preliminary engineering reports, plats and utility as-builts. These data are then compiled, reduced and used for roadway design, which in turn, is produced in the form of plan sheets for actual construction.

Initial data required for the production of plans are:

- Existing Topography
- Existing Utilities
- Existing Drainage Structures
- Existing Ground Elevations and Profiles
- Existing R/W
- Preliminary Soils and Foundation Data
- Preliminary Horizontal Geometrics
- Preliminary Vertical Geometrics
- Proposed Typical Sections

2.2.1 Existing Topography and Field Data

Existing topography shows the existing characteristics of the project site. This also includes the existing utilities and drainage structures within the limits of the project.

All data pertaining to topography, horizontal location of existing utilities and drainage structures shall be shown on the plan portion of the plan - profile sheets.

Existing ground line along the baseline of survey, vertical location of major existing utilities (refer Chapter 5 Vol. I) and utility structures shall be shown on the profile portion of the plan - profile sheets.

2.2.2 Proposed Typical Section ~~XXXXXXXX~~

Typical sections show the design elements of a roadway in the form of cross sections. Pavement design data should be shown, if available. For some projects typical sections are approved prior to the start of design, for others, typical sections are developed by the design engineer and submitted for approval.

2.2.3 Preliminary Geometrics

The design engineer sets the preliminary horizontal and vertical geometrics for a project and provides the production personnel with information to be produced on plans.

Horizontal geometrics consist of the roadway construction centerline and its bearings, curve data, angles at street intersections, pavement widths, taper lengths, left turn lanes, etc., and is plotted on the plan portion of the plan - profile sheets.

Vertical geometrics show the vertical curves and grades of the roadway along the profile grade line. The existing groundline along the baseline of survey and the proposed profile grade line shall be plotted on the profile portion of the plan - profile sheets.

2.2.4 Cross Sections

Information required for drafting existing cross sections is obtained from survey data. Proposed cross sections are compiled from typical sections and proposed vertical geometry. These templates are then superimposed at specified intervals on the existing cross sections to depict "cut" or "fill" along the project. Locations of existing utilities within construction limits shall also be shown in the cross sections.

2.3 Phase Submittals

The remainder of this chapter outlines, in detail, the sequence of contract plans preparation and assembly, the review process and the information required to be presented on the various plan sheets at the various phases of submission on a project.

The submittal phases are as follows:

SUBMITTAL PHASES

Phase I 30-35% complete
Phase II 60-65% complete
Phase III 90-95% complete
Phase IV 100% complete

Phase review for minor projects (less than \$2 million) shall be held at the 60 and 100% stages at a minimum.

Figure 2.1 summarizes the requirements for each submittal. *No phase is complete until response has been made to all review comments.*

Phase submittal stages and number may vary for some projects.

Prior to submitting the plans for a formal DOT Phase review, the design organization shall conduct a "Quality Control" (Q.C.) review to ensure technically correct and complete plans. Any revisions or corrections noted during the Q.C. review shall be incorporate into the ~~the~~ plans before submittal for the formal Phase review.

For consultant prepared plans prior to a formal phase submittal to DOT, the consultants shall conduct a peer review and a Q.C. review to ensure technically correct and complete plans. The Q.C. review should be fully documented and submitted with the plans. This document will be a part of the project documents. Any comments or corrections noted during the reviews shall be incorporated into the plans before submittal to DOT.

FIGURE 2.1

SUMMARY OF PHASE SUBMITTALS

PLANSHEETS	PHASE I 30-35%	PHASE II 60-65%	PHASE III 90-95%	PHASE IV 100%
Key Sheet	P	P	C	F
Summary of Pay Items		P	C	F
Drainage Map	P	P	C	F
Interchange Drainage Map	P	P	C	F
Typical Section	P	C	C	F
Summary of Quantities and Box Culvert Data			C	F
Summary Drainage Structures		P	C	F
Project Layout	P	C	C	F
Roadway Plan-Profile	P	P	C	F
Special Profile	P	P	C	F
Back-of-Sidewalk Profile	P	C	C	F
Interchange Layout	P	P	C	F
Ramp Terminal Details		P	C	F
Intersection Layout/ Detail	P	P	C	F
Drainage Structures		P	C	F
Lateral Ditch Plan-Profile		P	C	F
Lateral Ditch Cross Section		P	C	F
Cross Section Pattern Sheet		P	C	F
Borrow Pit Soil Survey		P	C	F
Roadway Soil Survey		P	C	F
Cross Sections	P	P	C	F
Traffic Control Plans	P	P	C	F
Utility Contract Plan-Profile		P	C	F
Utility Adjustment		P	C	F
Selective Clearing and Grubbing		P	C	F
Approach Slabs		P	C	F
Signing and Marking Plans		P	C	F
Signalization Plans		P	C	F
Roadway Lighting Plans		P	C	F
Landscape Plans	P	P	C	F

Status Key:

P - Preliminary

C - Complete but subject to change

F - Final

2.4 Requirements for Phase I - 30-35% Complete Plans Submittal

A plans checking team will perform a formal checking of the design plans submitted for the formal phase review. For this procedure, a computer generated checklist will be completed and submitted with the plans. The plans will be checked for completeness and conformance to DOT Standards and criteria. The technical accuracy required for the design is the designer's responsibility. A "marked up" set of the plans and/or comments shall be returned to the design team for incorporation of the comments into the plans. When the review comments have been addressed, the plans are ready to proceed to the next phase of completion.

A conceptual plan which outlines the proposed drainage design to be developed, should accompany the phase I plan submittal.

2.5 Phase I-30-35% Submittal

The following elements are required for a Phase I - 30-35% complete set of plans

2 5.1 KEY SHEET (Chapter 3)

Location Map

Begin and end project station with begin milepost

Begin and end bridge and bridge culvert stations

All applicable project numbers

Exceptions

Equations

County Name

State Road Number

Length of project box

North arrow and scale

Consultant's name (for consultant prepared projects)

Approval signature lines

Location of project on map

Railroad crossing (if applicable)

Revision box

Standards date

Project Manager's Name

2.5.2 DRAINAGE MAP: (Chapter 5)

PLAN VIEW

North arrow and scale
Drainage divides and ground elevations
Drainage areas and flow direction arrows
Begin and end stations of project, bridge and
 exceptions
Equations
High water information as required
Existing structures and pipes with relevant information
Preliminary horizontal alignment
Section, township, range lines
Street names
State, Federal, county highway numbers (as appropriate)

PROFILE VIEW

Horizontal scale
Vertical scale
Begin and end stations of project, bridges and
 exceptions
Equations
 Preliminary profile grade and existing ground line

2.5.3 INTERCHANGE DRAINAGE MAP: (Chapter 5)

North arrow and scale
Preliminary interchange configuration
Preliminary interchange drainage with drainage areas
and flow direction arrows
Ramp baselines with nomenclature
Stationing along baselines
Begin and end bridge stationing
R/W lines

2.5.4 TYPICAL SECTIONS: (Chapter 6)

Mainline and crossroad typicals
Special details (bifurcated sections, high fills, etc.)
Standard Notes
Traffic data

2.5.5 PROJECT LAYOUT: (Chapter 9)

Plan-profile sheet sequence (mainline and crossroads)
Reference points

2.5.6 PLAN AND PROFILE: (Chapter 10)

PLAN VIEW

North arrow and scale

Baseline of survey

Centerline of construction (if different from the
baseline of survey)

Curve data (including superelevation)

Begin and end stations for the project, bridges, bridge
culverts and exceptions

Equations

Existing topography including utilities

Preliminary horizontal geometrics

Proposed R/W lines (if available)

Reference points (if project layout sheet not included
in plans set)

PROFILE VIEW

Scale

Appropriate existing utilities

Bench mark information

Existing ground line with elevations at each end of
sheet

Preliminary profile grade line

Equations

Begin and End Stations for the Project, bridges, bridge
culverts and exceptions.

2.5.7 SPECIAL PROFILE: (Chapter 11)

Scale

Ramp profile worksheet including nose sections

Existing ground line of cross-street

Proposed grade line of cross-street

2.5.8 BACK-OF-SIDEWALK PROFILE (Worksheet): (Chapter 12)

Scale

Begin and end project stations

Begin and end sidewalk stations

Cross-street locations and elevations

Drainage flow direction arrows

Mainline equations

Final back-of-sidewalk profile grades and vertical
curve information

Building floor elevations with offset distance left and
right

Existing driveway locations and details

Superelevation details

Gradeline notation: Specifically the numeric
difference relative to roadway profile gradeline

2.5.9 INTERCHANGE DETAIL: (Chapter 13)

North arrow and scale

Preliminary configuration and geometrics

Proposed bridge limits

R/W lines

Schematic of traffic flow and volumes

2.5.10 INTERSECTION LAYOUT: (Chapter 13)

North arrow and scale

Existing topography (if applicable)

Proposed R/W limits

Length of turn lanes

Taper lengths

Geometric dimensions (radii, offsets, widths)

Existing Utilities

2 5 11 CROSS SECTIONS (Chapter 18)

Scale

Existing ground line

Existing survey baseline elevations

Station numbers

Baseline of survey labeled

Existing utilities

Proposed template with profile grade elevations along mainline
and cross-streets as necessary

2.5 12 TRAFFIC CONTROL SHEETS (Chapter 19)

Project specific

2.6 Requirements for Phase II-60-65% Complete Plans Submittal

A plans checking team will perform a formal checking of the design plans submitted for the formal phase review. For this procedure, a computer generated checklist will be completed and submitted with the plans. The plans will be checked for completeness and conformance to DOT Standards and criteria and a constructability review shall be performed by Construction. The technical accuracy required for the design is the designer's responsibility. A "marked up" set of the plans and/or review comments shall be returned to the design team for incorporation of the review comments into the plans. When all review comments have been addressed by the design team, the plans are ready to proceed to the next phase of completion.

Drainage tabulations should accompany the Phase II plan submittal. Although not finalized, the tabulations should be complete and comprehensive.

2.7 PHASE II-60-65% Submittal

The following elements are required for a Phase II - 60-65% complete set of plans

2.7.1 KEY SHEET (Chapter 3)

Index of sheets

Contract plans and component plans list

Date of governing specifications

2.7.2 SUMMARY OF PAY ITEMS (Chapter 4)

Item numbers with descriptions

2 7 3 DRAINAGE MAP (Chapter 5)

PLAN VIEW

- Proposed structures with structure numbers
- Proposed storm sewer pipes
- Flood data (if applicable - may be shown in either plan or profile)
- Flow arrows along proposed ditches
- Retention/Detention ponds and area size
- Cross drains with pipe sizes and structure numbers
- Bridges/bridge culverts with begin and end stations
- Standard alternate materials note (may be shown in profile portion)

PROFILE VIEW

- Ditch gradients including DPI's
- Final roadway profile grade line
- Mainline structures with structure numbers and pipes
- Mainline storm sewer pipes
- Mainline flow line elevations
- Cross drains with pipe sizes, structure numbers and flow line elevation
- Bridge, Bridge Culvert

2 7 4 INTERCHANGE DRAINAGE MAP (Chapter 5)

- Final geometrics including P C and P T
- Proposed structures with structure numbers
- Proposed storm sewer pipes
- Special ditches with DPI and elevation

2.7.5 TYPICAL SECTIONS: (Chapter 6)

Pavement Design

2.7.6 PROJECT LAYOUT: (Chapter 9)

Complete

2.7.7 PLAN AND PROFILE: (Chapter 10)

PLAN VIEW

Final geometrics and dimensions including radii,
station pluses, widths, taper/transition lengths
Curb return numbers, station ties and elevations
Proposed drainage structures with structure numbers
Proposed storm sewer pipes including size
Proposed side drain pipe requirements (including size)
for access and crossroads
Proposed R/W lines
General notes (if project layout sheet not included)
may be shown in profile portion

PROFILE VIEW

Final profile grades and vertical curve data
Mainline drainage structures with structure numbers
Mainline storm sewer pipes
Proposed special ditches
Cross drains with structure number, size and flow line
elevations
Ditch gradients with DPI station and elevation
Non-standard superelevation transition details
High water elevations

2.7.8 SPECIAL PROFILE: (Chapter 11)

Final ramp profile grades including nose sections

Final intersection profile grades

Curb return profiles (if applicable)

Preliminary access and frontage road profiles

(Note: Projects may contain one or more types of special profiles.)

Non-Standard Superelevation Diagram

2.7.9 BACK-OF-SIDEWALK PROFILE: (Chapter 12)

Complete

2.7.10 INTERCHANGE LAYOUT: (Chapter 13)

Curve data including superelevation and design speed

Coordinate data

Fence location

Access and/or frontage roads with dimensions and R/W

2.7.11 RAMP TERMINAL DETAILS: (Chapter 13)

Preliminary geometrics

Radius, transition/taper lengths

2.7.12 INTERSECTION LAYOUT: (Chapter 13)

Final geometrics including dimensions, radii, offsets,
station pluses and taper/transition lengths
Limits of proposed construction along side roads
Storm sewer pipes including sizes
Cross drains with structure numbers and pipe sizes
Applicable notes

2.7.13 DRAINAGE STRUCTURES: (Chapter 14)

Vertical and horizontal scale
Roadway template with profile grade elevation
Drainage structures with numbers in numerical order,
type, size, location, flowline elevations and
applicable index numbers
Underground utilities
Special sections at conflict points
R/W lines (at critical locations)
Storm sewer construction notes
Flow arrows
Structure numbers and location station along right side
of sheet
Applicable notes

2.7.14 OUTFALL/LATERAL DITCH SYSTEM: (Chapter 15)

PLAN VIEW

North arrow and scale
Existing topography
Existing drainage structures (if any)
Roadway centerline
Existing and/or survey ditch centerline
Proposed ditch centerline with stationing
Begin and end ditch stations
Equations (if any)
Ditch centerline intersection stations (if any)
Ditch PI stations with deflection angle left or right
Bearings of ditch and mainline centerlines
R/W lines
Proposed drainage structures with structure numbers
Proposed storm sewer pipes (if any)
Existing utilities

PROFILE VIEW

Bench mark information
Scale
Existing ground line
Proposed ditch profile with grades
Begin and end ditch stations
High water elevations
Existing Utilities
Proposed drainage structures with structure numbers
Proposed storm sewer pipes (if any) with size
Overland flow or overtopping elevations
Typical section can be placed in either plan or profile

2.7.15 LATERAL DITCH CROSS SECTIONS: (Chapter 15)

Horizontal and vertical scale
Existing ground line
Station numbers
Survey centerline and elevation
Proposed template with ditch bottom elevation
R/W
Begin and end ditch stations
Begin and end excavation stations
Earthwork quantities
Total earthwork quantity in cubic yard (C.Y.)
Existing utilities

2.7.16 CROSS SECTION PATTERN SHEET: (Chapter 13)

North arrow and scale
Interchange layout
Access and frontage roads
Mainline and ramp stationing
Begin and end bridge stations
Ramp baselines with nomenclature and stationing
Cross section location lines

2.7.17 BORROW PIT SOIL SURVEY: (Chapter 17)

Soil data
Project specific

2.7.18 ROADWAY SOIL SURVEY: (Chapter 17)

Soil data
Project specific

2.7.19 CROSS SECTIONS: (Chapter 18)

Proposed template with profile grade elevation
R/W

Begin and end stationing for project, construction and
earthwork, bridge and bridge culvert

Special ditch bottom elevations

Equivalent stations for ramps and mainline

Mainline equation stations

Soil borings

Water table

Extent of unsuitable material

2.7.20 TRAFFIC CONTROL SHEETS: (Chapter 19)

Preliminary traffic control plan

Detour plan

Phasing plan

R/W - existing and additional if required

Existing Utilities

2.7.21 UTILITY ADJUSTMENT: (Chapter 20)

All existing utilities highlighted

2.7.22 UTILITY CONTRACT PLANS: (Chapter 27)

Key Sheet

Mainline plan-profile

Proposed utility horizontal and vertical locations

KEY SHEET

W P I Number

State Project Number

Federal Aid Project Number

State Road Number

County Name

FDOT Project Manager's Name

Begin/End Stations

Begin/End Exceptions

Station Equations

Roadway and Traffic Design Standards Date

Engineer of Record

PLAN SHEETS

North arrow

Scale

Basic Roadway Geometrics

Begin/End Stations

Begin/End Exceptions

Conflicting utilities, lighting or drainage

Pavement markings

Sign locations

Applicable pay items

KEY SHEET

W P I Number

State Project Number

Federal Aid Project Number

State Road Number

County Name

FDOT Project Manager's Name

Begin/End Stations

Begin/End Exceptions

Station Equations

Roadway and Traffic Design Standards Date

Engineer of Record

PLAN SHEET

North arrow

Scale

Basic Roadway Geometrics

Begin/End Stations

Begin/End Equations

Station Equations

Conflicting utilities, lighting or drainage

Signal Pole Location

Type and location of loops

Type and location of signal heads

Pedestrian Signal

Location of Stop Bars

Location of Pedestrian Crosswalks

Sheet Title

Applicable pay items

KEY SHEET

W P I Number
State Project Number
Federal Aid Project Number
State Road Number
County Name
FDOT Project Manager's Name
Begin/End Stations and Exceptions
Station Equations
Roadway and Traffic Design Standards Date
Engineer of Record

POLE DATA AND LEGEND SHEET

Each pole by number with location, arm length, mounting height and
luminaire wattage noted
Design value for light intensities and uniformity ratios shown
Legend
Sheet title

PLAN SHEETS

North arrow and scale
Basic Roadway Geometrics
Begin/End Stations and Equations
Station Equations
Conflicting utilities, lighting or drainage
Sheet title
Applicable pay items
Pole symbols shown at correct station location and approximate offset

2 7 26 LANDSCAPE PLANS (Chapter 26)

KEY SHEET

STANDARD DETAIL SHEET

Applicable standard details

PLAN SHEETS

Roadway and sidewalk plan

Plant placement by symbol

Legend for plant symbols

IRRIGATION PLAN (if applicable)

Type of system

Location of pipes

Size of pipes

Type and location of heads

SPECIFICATIONS PLAN SHEET

Project specific

2 7 27 SELECTIVE CLEARING AND GRUBBING (Chapter 21)

Limits by station and dimension of selective clearing and grubbing

2 7 28 APPROACH SLABS. (Chapter 22)

Project specific

2.8 Requirements For Phase III - 90 - 95% Complete Plans Submittal

The only other remaining work to be done will be to comply with comments received as a result of the review. The Work Zone Traffic Control items paid for on a 'per day' basis shall be estimated by the design organization and included in the Phase III - 90-95% complete submittal. The DOT construction department will make a biddability review and will establish construction duration as a part of the phase III review. This information shall be included in the phase III review comments transmitted back to the design organization. The estimated pay items for Work Zone Traffic Control shall be revised as necessary based on the established construction duration.

All plan sheets and computation books are complete and the WPA system has been updated. Final drainage tabulations shall also be furnished for review.

A plans checking team will perform a formal checking of the design plans submitted for the formal phase review. For this procedure, a computer generated checklist will be completed and submitted with the plans. The plans will be checked for completeness and conformance to DOT standards and criteria. The technical accuracy required for the design is the designer's responsibility. A "marked up" set of the plans and/or review comments shall be returned to the design team for incorporation of the comments into the plans. When the review comments have been addressed by the design team, the plans are ready to proceed to the next phase of completion.

2.9 Requirements For Phase IV - 100 % Complete Plans Submittal

After all corrections noted in the 90% submittal are complete and the cost estimate is complete, the plans are considered 100% complete. Volume I of this manual contains instructions for the final plans submittal.

CHAPTER 3

KEY SHEET

3.1 General

This is the first sheet in the plans set. It contains general information concerning the project and the plans themselves. Section 4 of the DOT CADD manual - Plans Procedures - contains the formatted sheet with information common to all projects. Levels and fonts for additional data can also be found in the CADD manual.

For complete illustrations of key sheets, see Exhibits II-3-A thru F.

3.2 Project Data

All general project data are shown on the key sheet in the following manner

3 2 1 Project Number, County Name and Road Number

These are in the form of a title in large heavy letters They are positioned above the location map (see Exhibit II-3-A)

Where Federal project numbers are involved, the corresponding State project number is placed to the right of the Federal project number, within brackets

Projects that are independently prepared but are to be let in the same construction contract shall have the additional project numbers (Federal and State) noted on the key sheet

3 2 2 Work Program Item Number and Fiscal Year

The work program item number shall be placed adjacent to the sheet number box in the top right corner The construction fiscal year that is to be entered in the fiscal year box is the second year in the fiscal year, i e , enter 90 for fiscal year beginning July 1989 and ending June 1990

3 2 3 Length of Project Box

Lengths of roadway, bridges, bridge culverts, exceptions, and net and gross lengths of the project shall be shown in a box in the center of the sheet below the location map. The net length¹ of the project is computed by taking the total length of roadway and bridges in feet and converting it to miles, dropping all decimals past a thousandth of a mile, without rounding off. The roadway and bridge mileage shall then be rounded so that their total equals the net length. The survey line should be used to compute the length of the project unless the construction line is substantially different in length (100' or more), or the survey line is outside the right-of-way, or the survey line bridge length is different from the construction line bridge length. The use of the survey line will generally result in less equations on the key map. If divided highways have significantly different lengths for the left and right roadways, the project length shall be based on the longest roadway. A note stating which roadway was used shall be placed adjacent to the project length box.

The 'Begin Project' and 'End Project' stations are the basis for computing the length. Begin and end construction stations are not to be used in computing the length of the project.

A length of project box is not required on component key sheets.

¹ Roadway length = End Project - Begin Project - Exceptions - Bridges
Net Length = End Project - Begin Project - Exceptions + Bridges
Gross Length = End Project - Begin Project

3.3. Project Location Map

This map is placed in the center of the sheet and consists of a reproduced portion of one or more maps showing the project location. The map may be a county or other appropriate map. "Clippings" of digitized county maps are available upon request, from the District CADD manager by supplying him with the lower left and upper right-corner coordinates of the required area. The coordinates shall be on the State Plane coordinate system. For consultant prepared plans, the Consultant Project Manager shall request the District Project Manager, who in turn shall request the District CADD manager for the map "clipping". The map clippings shall be made available to the consultant on a tape or diskette for a fee.

The intent of the location map is to provide enough information so that the project location is easily understood. This may make it necessary to show the Section, Township, Range and County lines together with Section, Township and Range numbers to make the location clear. City and urban limits should be shown where applicable. The mile post, correct to three decimal places, shall be shown under the begin project station.

Streets shall be designated by name and State road number or U. S. Highway number, if appropriate. The name of the next incorporated city to which these roads lead shall be placed at the edge of the map. Roads and topography shall be indicated by standard symbols as shown in the Roadway and Traffic Design Standards booklet - Index No. 002.

Project location shall be shown by a heavy solid line of substantial width. It is sometimes advantageous to show station numbers at regular intervals, particularly with city street projects. The begin and end of projects, any station equations, begin and end of proposed bridges along the state project, bridge culverts and exceptions shall be stationed and flagged.

When several projects are covered by the same set of plans, the beginning and end of each project shall be indicated clearly by the project number and stationing. The beginning of each project shall also be indicated by a mile post correct to three decimal places

The scale of the location map should be chosen so that it will not interfere with other features on the key sheet. A common error is to position the location map on the sheet and then discover that insufficient space remains for the index of sheets, project title or the length of project box

A location map is not required on component key sheets

3.4 North Arrow and Scale

The north arrow shall be placed on either side of the location map, preferably to the right. The map scale shall be shown directly below the north arrow. The scale shall be indicated by using a bar scale 1" long with "ticks" at each end. The scale distance shall be shown between the ticks. The map shall be oriented so that the arrow will be either toward the top of the sheet or to the right.

3.5 Plans in Contract Plans Set

A listing of plans included in the contract plans set shall be shown in the upper left corner. The order of listing shall be: roadway, signing and pavement marking, signalization, lighting, landscaping, architectural, and structure. If the summary of pay items, box culvert data, and flood data sheets are included as computer outputs rather than the plan sheets, they should be listed after the roadway component.

If sheets covering items such as signing and pavement markings, signalization, lighting and landscaping are numbered consecutively with roadway plans, they are not required to be shown as separate contract plans set components.

3.6 Index of Sheets and Standard Index Reference

A complete index of roadway plan sheets shall be placed on the left side of the key sheet under the heading. When projects contain plan components, each plan set shall have an index of sheets on its respective key sheet. The date of the governing Roadway and Traffic Design Standards shall be inserted in a note at the lower left corner of the key sheet.

Roadway plan sheets shall be assembled as follows

Sequence of Plans Assembly

Key Sheet

* Summary of Pay Items

* Box Culvert Data Sheet

Drainage Map (optional)

Interchange Drainage Map

Typical Section

Summary of Quantities

Summary of Drainage Structures

Project Layout (optional)

Roadway Plan-Profiles

Special Profiles

Back-of-Sidewalk Profiles (optional)

Interchange Layout

Ramp Terminal Details

Intersection Layout/Detail

Drainage Structures (optional)

Outfall/Lateral Ditch Plan-Profiles

Outfall/Lateral Ditch Cross Sections

Special Details

Cross Section Pattern Sheet

Borrow Pit Soil Survey

Roadway Soil Survey

Cross Sections

Traffic Control Sheets

Utility Contract Plan-Profiles

Utility Adjustments

Selective Clearing and Grubbing

* Represents computer output transferred to a graphics design file and placed on a normally formatted plan sheet

Signing and Marking Plans (when included as part of roadway plans)

Signalization Plans (when included as part of roadway plans)

Roadway Lighting Plans (when included as part of roadway plans)

Landscape Plans (when included as part of Roadway plans)

Approach Slabs

NOTE Contract/Construction Plans set may or may not contain all of the above listed sheets

l 3 7 Engineers Approval and Consultant's Name

l 3 7 1 Engineers Approval

For in-house and consultant prepared plans, the responsible Professional Engineer's name, registration number and approval date shall be included on the right side of the sheet For specific instructions on signing and sealing plans, see Volume I, Chapter 19

3 7 2 Consultant's Name

For plans prepared by a consulting firm, the name and address of the firm shall be shown on the right side of the sheet with the responsible registered, Professional Engineer's name below it

The DOT Project Manager's/Coordinator's name shall be shown below the length of project box for consultant and DOT prepared plans For key sheets where length of project is not required, the DOT Project Manager's name shall be shown in the same relative location on the sheet

If shop drawings are anticipated for a project, the name(s) and address of the Engineer(s) of Record shall be shown on the right side of the sheet

3.8 Governing Specifications

The date of the governing specifications shall be inserted in a note at the lower right corner of the key sheet. The supplement note available in the CADD cell library shall be added.

3.9 State Map

A small scale state map shall be shown at the upper right portion of the key sheet. The location of the project shall be indicated thereon.

3.10 Railroad Crossing

When the project involves a railroad crossing which falls within the limits of an exception, a sketch shall be shown on the key sheet showing the station of crossing, railroad company name and DOT/AAR National Inventory Crossing Number. A location sketch on the key sheet is not required on any project containing plan - profile sheets that cover crossing locations. A sketch should be included on the key sheet for resurfacing projects.

3.11 Revision Dates

The lead key sheet (usually roadway) shall show a complete record of all plans revisions. This record shall list the component (such as roadway structures, signing and pavement marking), the sheet numbers involved and the revision date. This record shall be shown directly below the reference to the Roadway and Traffic Design Standards.

A revision box shall be shown on the right side of each component key sheet which shall contain a record of all revisions particular to that sheet. It shall list the revision date, the initials of the person responsible for the revision and a brief description of the change.

3.12 R-R-R Projects

If applicable, a note stating that the plans were prepared according to R-R-R criteria shall be shown on the right side of the sheet.

THIS EXHIBIT IS FOR EXAMPLE ONLY AND DOES NOT REFLECT THE DEPARTMENT'S DESIGN CRITERIA.

00 S-1

S.P.I. NO. 00000000

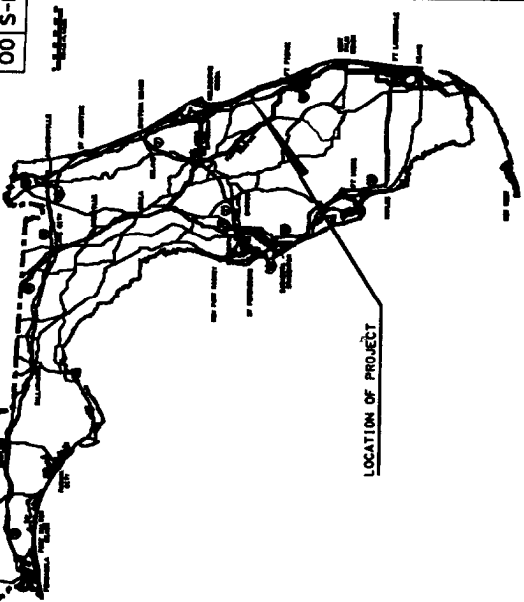

**STATE OF FLORIDA
DEPARTMENT OF TRANSPORTATION**

**PLANS OF PROPOSED
STATE HIGHWAY**

F.A. PROJECT NO. ACI-000-0(00)0
[STATE PROJECT NO. 00000-0000]
INDIAN RIVER COUNTY
STATE ROAD NO. 000

INDEX OF SIGNING AND PAVEMENT MARKING PLANS

SHEET NO.	SHEET DESCRIPTION
5 1	KEY SHEET
5 2	TABULATION OF QUANTITIES
5 3	GENERAL NOTES
5-4	PLAN SHEETS
5 15	PAVEMENT MARKING DETAILS S R 00
5 16	GUIDE SIGN DETAIL
5 17	SIGN CROSS SECTIONS

CONTRACT PLAN SET INFORMATION NOT REQUIRED WHEN THE INFORMATION IS SHOWN ON THE LEAD KEY SHEET OF THE PLAN SET

SIGNING AND PAVEMENT MARKING PLANS

THE LOCATION MAP IS NOT REQUIRED WHEN THE MAP IS SHOWN ON THE LEAD KEY SHEET OF THE PLAN SET

REVISION BLOCK INFORMATION IS REQUIRED WHEN THE INFORMATION IS PROVIDED ON THE KEY SHEET OF SIGNING & PAVEMENT MARKING PLANS

LENGTH OF PROJECT INFORMATION IS NOT REQUIRED FOR INTERSECTIONS, INTERCHANGES AND SIMILAR SITES OR WHEN INFORMATION IS SHOWN ON LEAD KEY SHEET OF PLAN SET

NO.	DATE	REVISIONS
12	80	BLH ADDED F A PROJ NO

NAME OF DOT PROJECT MANAGER OR COORDINATOR AS APPROPRIATE

REVISION INFORMATION IS NOT REQUIRED WHEN SHOWN ON THE LEAD KEY SHEET OF THE PLAN SET

THESE PLANS HAVE BEEN PREPARED IN ACCORDANCE WITH THE STANDARDS BY THE STATE OF FLORIDA AND GOVERNED BY THE STANDARDS OF THE DEPARTMENT OF TRANSPORTATION, (BOOKLET DATED JANUARY 1980)

SIGNING AND PAVEMENT MARKING PLANS, ENGINEER OF RECORD

NAME(S) AND ADDRESS(ES) OF THE ENGINEER(S) OF RECORD WHEN REVIEW OF SHOP DRAWINGS REQUIRED

PLANS PREPARED BY :
NAME AND ADDRESS OF THE CONSULTANT FIRM WHEN THE PLANS ARE PREPARED BY A CONSULTANT

NOTE THIS PROJECT TO BE LET TO CONTRACT WITH STATE PROJECT NO 00000 0000

ATTENTION IS DIRECTED TO THE FACT THAT THESE PLANS MAY HAVE BEEN REDUCED IN SIZE FROM THE ORIGINALS WHICH MUST BE CONSIDERED WHEN OBTAINING DATA, GOVERNING SPECIFICATIONS, STATE DEPARTMENT OF TRANSPORTATION, STANDARD SPECIFICATIONS, STATE OF FLORIDA, THESE DOCUMENTS DATED 1980 AND SUPPLEMENTARY THEREIN IN THE SPECIAL PROVISIONS FOR THIS PROJECT

SIGNING AND PAVEMENT MARKING PLANS
APPROVED BY: _____
DATE: _____
P.E. NO. _____

DOT PROJECT MANAGER

THIS EXHIBIT IS FOR EXAMPLE ONLY AND DOES NOT REFLECT THE DEPARTMENT'S DESIGN CRITERIA.

00 T-1

P.P.I. No. 00000000

**STATE OF FLORIDA
DEPARTMENT OF TRANSPORTATION**

**PLANS OF PROPOSED
STATE HIGHWAY**
F.A. PROJECT NO. 1R-00-0(000)00
[STATE PROJECT NO. 00000-0000]
DUVAL COUNTY
STATE ROAD NO. 0

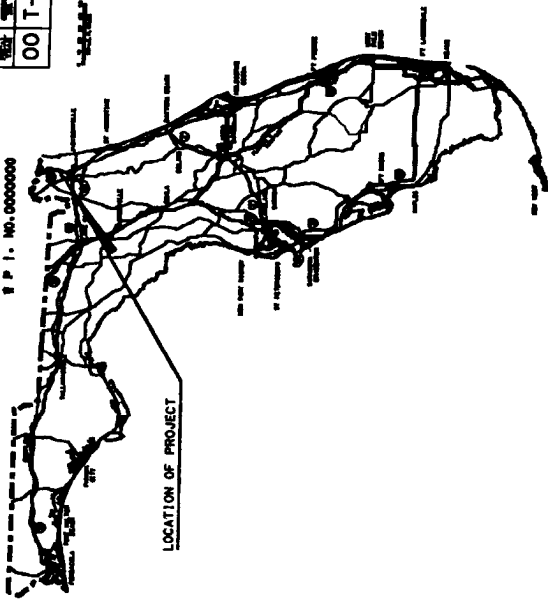

LOCATION OF PROJECT

CONTRACT PLAN SET INFORMATION NOT REQUIRED WHEN THE INFORMATION IS SHOWN ON THE LEAD KEY SHEET OF THE PLAN SET

INDEX OF SIGNALIZATION PLANS

SHEET NO.	SHEET DESCRIPTION
T 1	KEY SHEET
T 2	TABULATION OF QUANTITIES
T 3	GENERAL NOTES
T-4 T 6	SIGNALIZATION PLAN SHEETS

SIGNALIZATION PLANS

SIGNALIZATION PLANS
ENGINEER OF RECORD

NAME(S) AND ADDRESSES OF THE ENGINEERS OF RECORD WHEN REVIEW OF SHOP DRAWINGS REQUIRED

PLANS PREPARED BY :

NAME AND ADDRESS OF THE CONSULTANT FIRM WHEN THE PLANS ARE PREPARED BY A CONSULTANT

THE LOCATION MAP IS NOT REQUIRED WHEN THE MAP IS SHOWN ON THE LEAD KEY SHEET OF THE PLAN SET

THESE PLANS HAVE BEEN PREPARED IN ACCORDANCE WITH THE DESIGN CRITERIA GOVERNED BY THE STATE OF FLORIDA DEPARTMENT OF TRANSPORTATION, ROADWAY AND TRAFFIC CONTROL MANUAL, DATED JANUARY 1982.

LENGTH OF PROJECT INFORMATION IS NOT REQUIRED FOR INTERSECTIONS, INTERCHANGES AND SIMILAR SITES OR WHEN INFORMATION IS SHOWN ON LEAD KEY SHEET OF PLAN SET

NAME OF DOT PROJECT MANAGER OR COORDINATOR AS APPROPRIATE

REVISION BLOCK INFORMATION IS REQUIRED WHEN THE INFORMATION IS REVISED ON THE KEY SHEET OF SIGNALIZATION PLANS

DATE	BY	REVISION
OR 30 DEC		ADDED SHEET T 6 TO INDEX OF PLANS

NOTE THIS PROJECT TO BE LET TO CONTRACT WITH STATE PROJECT NO 00000 0000

ATTENTION IS DIRECTED TO THE FACT THAT THESE PLANS HAVE BEEN REDUCED IN SIZE BY AN UNSTATED FACTOR AND SHOULD BE CONSIDERED WHEN OBTAINING SCALED DATA. GOVERNING SPECIFICATIONS STATE OF FLORIDA, DEPARTMENT OF TRANSPORTATION, STANDARD DRAWINGS, SHALL BE APPLIED TO THE SUPPLEMENT THEREIN TO BE NOTED IN THE SPECIAL PROVISIONS FOR THIS PROJECT

CONSULTING FIRM APPROVED BY: DATE: P.L. No.:

FDOT PROJECT MANAGER :

THIS EXHIBIT IS FOR EXAMPLE ONLY AND DOES NOT REFLECT THE DEPARTMENT'S DESIGN CRITERIA.

00 L-1

F.P. NO. 00000000

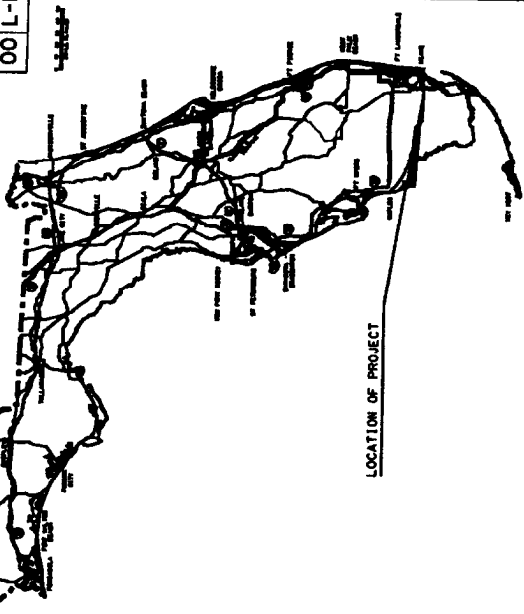

LOCATION OF PROJECT

STATE OF FLORIDA
DEPARTMENT OF TRANSPORTATION

PLANS OF PROPOSED
STATE HIGHWAY

F.A. PROJECT NO. 1-000-0(000)000
[STATE PROJECT NO. 00000-0000]
DADE COUNTY
STATE ROAD NO. 00

CONTRACT PLAN SET INFORMATION NOT REQUIRED WHEN THE INFORMATION IS SHOWN ON THE LEAD KEY SHEET OF THE PLAN SET

INDEX OF LIGHTING PLANS

SHEET NO.	SHEET DESCRIPTION
L 1	KEY SHEET
L 2	TABULATION OF QUANTITIES
L 3	POLE DATA AND LEGEND SHEET
L 4	PLAN SHEETS
L 5	HIGHMAST POLE FOUNDATIONS
L 6 & L 7	BORING DATA

LIGHTING PLANS

THE LOCATION MAP IS NOT REQUIRED WHEN THE MAP IS SHOWN ON THE LEAD KEY SHEET OF THE PLAN SET

LIGHTING PLANS ENGINEER OF RECORD

(NAME(S) AND ADDRESS(S) OF THE ENGINEER(S) OF RECORD WHEN REVIEW OF SHOP DRAWINGS REQUIRED ARE PREPARED BY A CONSULTANT

PLANS PREPARED BY :

NAME AND ADDRESS OF THE CONSULTANT FIRM WHEN THE PLANS ARE PREPARED BY A CONSULTANT

THESE PLANS HAVE BEEN PREPARED IN ACCORDANCE WITH AND ARE GOVERNED BY THE DESIGN STANDARDS AND SPECIFICATIONS OF THE DEPARTMENT OF TRANSPORTATION, FLORIDA, AND THE STANDARD SPECIFICATIONS FOR HIGHWAY CONSTRUCTION, LATEST EDITION, AND SUPPLEMENTS THEREOF.

REVISION INFORMATION IS NOT REQUIRED WHEN SHOWN ON THE LEAD KEY SHEET OF THE PLAN SET

LENGTH OF PROJECT INFORMATION IS NOT REQUIRED FOR INTERSECTIONS, INTERCHANGES AND SIMILAR SITES OR WHEN INFORMATION IS SHOWN ON LEAD KEY SHEET OF PLAN SET

NAME OF DOT PROJECT MANAGER OR COORDINATOR AS APPROPRIATE

REVISION BLOCK INFORMATION IS REQUIRED WHEN THE INFORMATION IS REVISED ON THE KEY SHEET OF LIGHTING PLANS

NO.	DATE	DESCRIPTION
1	10 90	1B CHANGED FA PROJ NO

DATE: _____
F.A. NO.: _____

DDOT PROJECT MANAGER

NOTE THIS PROJECT TO BE LET TO CONTRACT WITH STATE PROJECT NO 00000 0000

ATTENTION IS DIRECTED TO THE FACT THAT THESE PLANS MAY HAVE BEEN REDUCED IN SIZE FROM THE ORIGINAL UNLESS OTHERWISE INDICATED. THE ORIGINAL UNLESS OTHERWISE INDICATED. THE ORIGINAL UNLESS OTHERWISE INDICATED. THE ORIGINAL UNLESS OTHERWISE INDICATED.

THIS EXHIBIT IS FOR EXAMPLE ONLY AND DOES NOT REFLECT THE DEPARTMENT'S DESIGN CRITERIA.

00 LD-1

State P.I. NO. 00000000

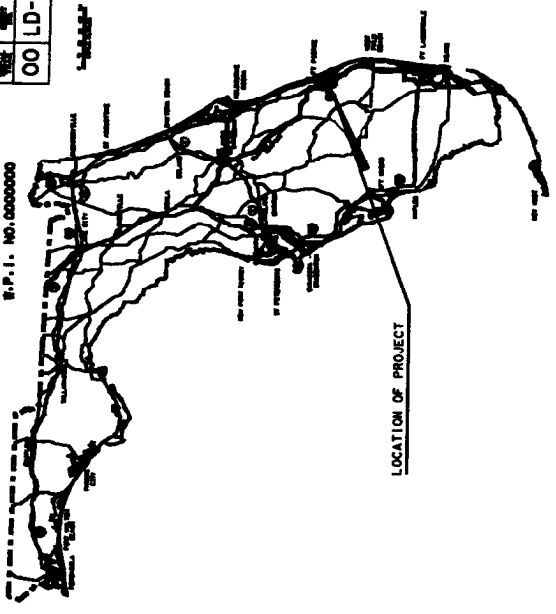

STATE OF FLORIDA
DEPARTMENT OF TRANSPORTATION
PLANS OF PROPOSED
STATE HIGHWAY

STATE PROJECT NO. 00000-0000
 PALM BEACH COUNTY
 STATE ROAD NO. 000 (UNIVERSITY BLVD.)

LANDSCAPE PLANS

CONTRACT PLAN SET INFORMATION NOT REQUIRED WHEN THE INFORMATION IS SHOWN ON THE LEAD KEY SHEET OF THE PLAN SET

INDEX OF LANDSCAPE PLANS

SHEET NO.	SHEET DESCRIPTION
LD 1	KEY SHEET
LD 2	TABULATION OF QUANTITIES
LD 3	GENERAL NOTES
LD 4	LD 6
LD 7	STANDARD DETAILS SHEET

THE LOCATION MAP IS NOT REQUIRED WHEN THE MAP IS SHOWN ON THE LEAD KEY SHEET OF THE PLAN SET

LANDSCAPE PLANS ENGINEER OF RECORD
 NAME(S) AND ADDRESSES OF THE ENGINEER(S) OF RECORD WHEN REVIEW OF SHOP DRAWINGS REQUIRED

PLANS PREPARED BY :
 NAME AND ADDRESS OF THE CONSULTANT FIRM WHEN THE PLANS ARE PREPARED BY A CONSULTANT

THESE PLANS HAVE BEEN PREPARED BY THE STATE OF FLORIDA, DEPARTMENT OF TRANSPORTATION, ROADWAY DESIGN DIVISION, TALLAHASSEE, FLORIDA, JANUARY 1990.

REVISION INFORMATION IS NOT REQUIRED WHEN SHOWN ON THE LEAD KEY SHEET OF THE PLAN SET

LENGTH OF PROJECT INFORMATION IS NOT REQUIRED FOR INTERSECTIONS, INTERCHANGES AND SIMILAR SITES OR WHEN INFORMATION IS SHOWN ON LEAD KEY SHEET OF PLAN SET

NAME OF DOT PROJECT MANAGER OR COORDINATOR AS APPROPRIATE

REVISION BLOCK INFORMATION IS REQUIRED WHEN THE INFORMATION IS REVISED ON THE KEY SHEET OF LANDSCAPE PLANS

NO.	DATE	DESCRIPTION
08	90	RRR DELETED PLAN SHEET LD 7 FROM INDEX

LANDSCAPE PLANS APPROVED BY: _____ DATE: _____ P.E. No. _____

NOTE THIS PROJECT TO BE LET TO CONTRACT WITH STATE PROJECT NO 00000 0000

ATTENTION IS DIRECTED TO THE FACT THAT THESE PLANS MAY HAVE BEEN REDUCED IN SIZE BY MEANS OF REDUCING SCALE, CONSIDERED WHEN OBTAINING SCALED DATA, GOVERNING SPECIFICATIONS, STATE OF FLORIDA DEPARTMENT OF TRANSPORTATION, STANDARD SPECIFICATIONS FOR ROADWAY AND SUPPLEMENTARY SPECIFICATIONS TO THE STANDARD SPECIFICATIONS FOR THIS PROJECT

DOT PROJECT MANAGER :

THIS EXHIBIT IS FOR EXAMPLE ONLY AND DOES NOT REFLECT THE DEPARTMENT'S DESIGN CRITERIA.

**STATE OF FLORIDA
DEPARTMENT OF TRANSPORTATION**

DATE: 00 K-1

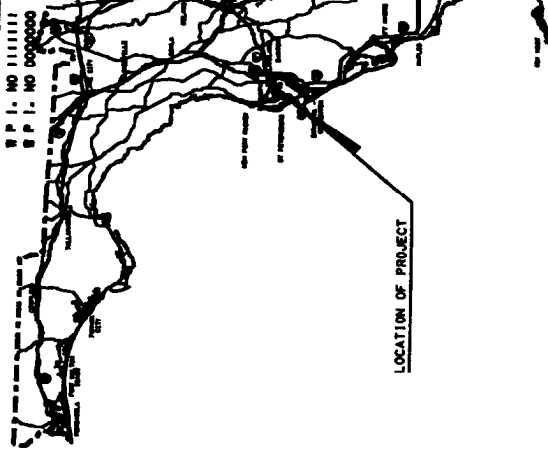

INDEX OF BUILDING CONSTRUCTION PLANS

SHEET NO	SHEET DESCRIPTION
ARCHITECTURAL DRAWINGS	
K 1	KEY SHEET
A 1	SITE PLAN NORTHBOUND
A 2	SITE PLAN SOUTHBOUND
A 3	FOUNDATION PLAN
A 4	FLOOR PLAN ROOM FINISH SCHEDULE
A 5	ROOF FRAMING PLAN
A 6	ELEVATIONS DOOR SCHEDULE AND DETAILS
A 7	WALL SECTIONS AND DETAILS
A 8	1/4" TOILET PLAN AND ELEVATIONS
A 9	STRUCTURAL DETAILS
A 10	FINISH SCHEDULE AND DETAILS
A 11	UTILITY SITE PLAN
CIVIL DRAWINGS	
C 1	UTILITY SITE PLAN
MECHANICAL DRAWINGS	
M 1	SITE PLAN NORTHBOUND
M 2	SITE PLAN SOUTHBOUND
M 3	SCHEDULES NOTES
M 4	DUCTWORK LEGEND
M 5	N.Y.A.C FLOOR PLAN
M 6	CONTROL DIAGRAMS
M 7	JACKING AND BORKING DETAILS
ELECTRICAL DRAWINGS	
E 1	SYMBOLS AND ABBREVIATIONS
E 2	LIGHTING PLAN
E 3	PUMPER PLAN
E 4	SCHEDULES
SUB SURFACE INVESTIGATION	
B 1	SOIL BORINGS NORTHBOUND
B 2	SOIL BORINGS SOUTHBOUND
PICNIC PAVILIONS	
PP 1	PICNIC PAVILION DETAILS
PP 2	PICNIC PAVILION DETAILS
PP 3	PICNIC PAVILION DETAILS
PP 4	PICNIC PAVILION DETAILS

CONTRACT PLAN SET INFORMATION NOT REQUIRED WHEN THE INFORMATION IS SHOWN ON THE LEAD KEY SHEET OF THE PLAN SET

**PLANS OF PROPOSED
REST AREAS**

- F.A. PROJECT NO. 1-ID-000-0(000)0
[STATE PROJECT NO. 13000-0000]
- F.A. PROJECT NO. 1-ID-000-0(001)0
[STATE PROJECT NO. 15000-0000]
MANATEE & PINELLAS COUNTIES
(MANATEE REST AREA SOUTHBOUND)
(PINELLAS REST AREA NORTHBOUND)

BUILDING CONSTRUCTION PLANS

THE LOCATION MAP IS NOT REQUIRED WHEN THE MAP IS SHOWN ON THE LEAD KEY SHEET OF THE PLAN SET

BUILDING CONSTRUCTION PLANS ARCHITECT OF RECORD

NAME(S) AND ADDRESS(ES) OF THE ARCHITECT(S) OF RECORD WHEN REVIEW OF SHOP DRAWINGS REQUIRED

PLANS PREPARED BY: NAME AND ADDRESS OF THE CONSULTANT FIRM WHEN THE PLANS ARE PREPARED BY A CONSULTANT

NOTE THIS PROJECT TO BE LET TO CONTRACT WITH STATE PROJECT NO 00000 0000

REFERENCE NOTE IS REQUIRED FOR "ROADWAY AND TRAFFIC DESIGN STANDARDS" WHEN APPLICABLE INDEXES ARE INCLUDED (GRADING PARKING AND OTHER DETAILS)

REVISION BLOCK INFORMATION IS REQUIRED WHEN THE KEY SHEET OF BUILDING CONSTRUCTION PLANS

NO.	DATE	DESCRIPTION
04	91	JOH DELETED UTILITY SHEET

REVISION INFORMATION IS NOT REQUIRED WHEN SHOWN ON THE LEAD KEY SHEET OF THE PLAN SET

THESE PLANS HAVE BEEN PREPARED IN ACCORDANCE WITH AND ARE GOVERNED BY THE STANDARD BUILDING CODE.

ATTENTION IS DIRECTED TO THE FACT THAT THESE PLANS MAY HAVE BEEN REDUCED IN SIZE FROM THE ORIGINAL DRAWINGS. ANY DIMENSIONS CONSIDERED WHEN OBTAINING SCALED DATA, GOVERNMENT SPECIFICATIONS, STATE OF FLORIDA, DEPARTMENT OF TRANSPORTATION, STANDARD SPECIFICATIONS FOR ROADWAY AND SUPPLEMENTARY TENDERS IN MANATEE IN THE SPECIAL PROVISIONS FOR THIS PROJECT

BUILDING CONSTRUCTION PLANS APPROVED BY: DATE: PROJECT NO.:

STATE PROJECT NO. 00000-0000

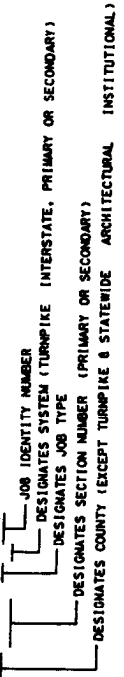

STATE PRIMARY CONSTRUCTION WITHIN ONE COUNTY OF ONE STATE ROAD

INTERSTATE ONE FEDERAL AID PROJECT FOR ONE STATE PRIMARY CONSTRUCTION PROJECT WITHIN ONE COUNTY CONSTRUCTION ALONG STATE ROAD AND INTERSTATE

TWO STATE SECONDARY CONSTRUCTION PROJECTS WITHIN ONE COUNTY (STATE ROAD NO N/A) DESCRIPTION LOCATION, COUNTY ROAD & NAME

INTERSTATE ONE FEDERAL AID PROJECT FOR SPLIT FUNDED INTERSTATE CONSTRUCTION WITHIN ONE COUNTY OF ONE STATE ROAD DESCRIPTION LOCATION, INTERSTATE NUMBER

FLORIDA'S TURNPIKE (IF A N/A) CONSTRUCTION WITHIN TWO COUNTIES OF ONE STATE ROAD

ARCHITECTURAL INSTITUTIONAL STATE PRIMARY CONSTRUCTION WITHIN ONE COUNTY (STATE ROAD NO N/A)

FEDERAL AID PROJECT WITH STATE PRIMARY CONSTRUCTION AND SEPARATE FEDERAL AID CONSTRUCTION WITHIN ONE COUNTY OF ONE STATE ROAD

FEDERAL AID PROJECT FOR STATE PRIMARY CONSTRUCTION WITHIN ONE COUNTY OF ONE STATE ROAD

FEDERAL AID PROJECT WITH STATE PRIMARY CONSTRUCTION AND SEPARATE FEDERAL AID PROJECT WITH STATE PRIMARY CONSTRUCTION WITHIN ONE COUNTY OF ONE STATE ROAD

BRIDGE & APPROACHES FEDERAL AID PROJECT STATE SECONDARY CONSTRUCTION WITHIN ONE COUNTY (STATE ROAD NO N/A) DESCRIPTION LOCATION, COUNTY ROAD & NAME

STATE PROJECT NO. 13120-3521
MANATEE COUNTY
STATE ROAD NO. 70

STATE PROJECT NO. 48527-3601
AND STATE PROJECT NO. 48577-3602
ESCAMBIA COUNTY
C.R. 95-A (OLD PALAFOX)

STATE PROJECT NO. 97930-3325
PALM BEACH AND MARTIN COUNTIES
STATE ROAD NO. 91 (FLORIDA'S TURNPIKE)

STATE PROJECT NO. 99007-3519
HILLSBOROUGH COUNTY

F.A. PROJECT NO. F-400-1(20)
[STATE PROJECT NO. 31010-3511]
GILCHRIST COUNTY
STATE ROAD NO. 26

F.A. PROJECT NO. BRS-4644(1)
[STATE PROJECT NO. 03000-3622]
COLLIER COUNTY
C.R. 92 (SAN MARCO ROAD)

F.A. PROJECT NO. I-ID-275-7(214)13
[STATE PROJECT NO. 15170-3427]
PINELLAS COUNTY
STATE ROAD NO. 55 AND STATE ROAD NO. 93 (I-275)

F.A. PROJECT NO. I-MAIR-IR-595-1(333)11
[STATE PROJECT NO. 86095-3463
AND STATE PROJECT NO. 86095-3488]
BROWARD COUNTY
STATE ROAD NO. 862 (I-595)

F.A. PROJECT NO. F-300-1(11)
[STATE PROJECT NO. 08070-3515]
AND STATE PROJECT NO. 08070-3517
HERNANDO COUNTY
STATE ROAD NO. 50 (U.S. 98)

F.A. PROJECT NO. FFD-485-1(132)
[STATE PROJECT NO. 90060-3588]
F.A. PROJECT NO. OH-485-1(139)
[STATE PROJECT NO. 90060-3509]
MONROE COUNTY
STATE ROAD NO. 5 (U.S. 1)

PROJECT LOCATION AND DESCRIPTION EXAMPLES

The CES output from all design groups should be numbered consecutively.

CHAPTER 4

SUMMARY OF PAY ITEMS

4.1 General

The summary of pay items sheet is generated from information input by the designer into the CES system. This sheet may be the output generated by the CES system, and placed directly behind the lead key sheet. As an alternate, the CES file may be transferred to a graphics design file and placed on a normally formatted plan sheet. In all cases, the CES file must be established and kept current with the quantities listed in the plans.

4.2 Summary of Pay Items Sheet

The summary of pay items shows all items and estimated quantities for the project, or projects, in a contract. This includes all summaries for the component parts, such as structures, signing and pavement markings, etc.; as well as for additional projects in the contract.

Summary of pay items notes may be included on this sheet when a normally formatted plan sheet is used, or on the summary of quantities sheet when the computer output is placed directly in the plans. For small projects, the two sheets may be combined into one sheet.

Summary of pay items sheet without quantities is required at the 60% phase submittal and a complete summary of pay items sheet with quantities is required at the 90% and 100% phase submittals. Refer to Chapter 2 for "requirements of phase submittals".

00000-0000

A L T	S P C	ITEM NUMBER	SUMMARY OF ROADWAY ITEM	PAY ITEMS	UN		QUANTITY
					00000-0000	FA PART	
1	101-1	1	MOBILIZATION		LS	1 000	1 000
1	102-1	1	MAINT OF TRAFFIC		LS	1 000	1 000
1	102-3	1	COMMERCIAL MAIL FOR DRIVEWAY MAINT		CY	121 000	121 000
2	102-72	1	CONC BARRIER (TEMPORARY)		LF	6387 000	387 000
2	102-74-1	2	BARRICADE (TEMPORARY) (TYPE I, VP & DRUM)		ED	81348 000	8348 000
2	102-74-2	2	BARRICADE (TEMPORARY) (TYPE III) (6')		ED	1312 000	312 000
2	102-75	2	CONSTRUCTION SIGNS (TEMP - POST MOUNTED)		ED	18596 000	1596 000
2	102-76	2	ADVANCE WARNING ARROW PANELS		ED	132 000	132 000
2	102-77	2	HIGH INTENSITY FLASHING LIGHTS (TEMP - TYPE B)		EA	6679 000	679 000
2	102-78	2	REFLECTIVE PAVT MARKER		EA	1128 000	128 000
2	102-81	2	VEHICULAR IMPACT ATTENUATOR (TEMPORARY)		EA	2 000	2 000
2	102-82	2	RELOCATE TEMPORARY VEHICULAR IMPACT ATTENUATOR		EA	2 000	2 000
2	102-83	2	RELOCATE TEMPORARY CONC BARRIER WALL		LF	6387 902	387 902
2	102-92-1	2	TEMPORARY PAVEMENT MARKING (SKIP)		GM	16 175	16 175
2	102-92-2	2	TEMPORARY PAVEMENT MARKING (SOLID)		NH	16 175	16 175
2	102-96	2	TEMPORARY REGULATORY SIGNS (POST-MOUNTED)		ED	7572 000	572 000
1	104-5	1	SANDBAGGING		CY	3 000	3 000
1	104-6	1	SLOPE DRAINS (TEMPORARY)		LF	30 000	30 000
1	104-10	1	BALED HAY OR STRAW		TN	19 400	19 400
2	105-70	2	TRAINEE MANHOURS		MH	4000 000	000 000
2	110-2	2	CLEARING & GRUBBING		AC	34 206	34 206
2	110-7	2	MAILBOX (SINGLE)		EA	52 000	52 000
1	120-1	1	REGULAR EXCAVATION		CY	6493 000	6493 000
1	120-2	2	BORROW EXCAVATION (TRUCK MEASURE)		CY	36098 000	3098 000
1	120-4	1	SUBSOIL EXCAVATION		CY	18718 000	1718 000
1	160-4	1	TYPE B STABILIZATION		SV	85918 000	8918 000
3	162-2	3	TOPSOIL		SV	28211 000	2211 000
1	285-705	1	OPTIONAL BASE		SV	10360 000	1380 000
1	285-706	1	OPTIONAL BASE		SV	12443 000	1443 000
1	285-709	1	OPTIONAL BASE		SV	72398 000	7398 000
1	285-716	1	OPTIONAL BASE		SV	4512 000	512 000
1	286-1	1	TURNOUT CONSTRUCTION		SV	4132 000	132 000
1	286-2	1	TURNOUT CONSTRUCTION		TN	142 400	142 400
1	339-1	1	MISC ASPHALT PAVEMENT		TN	301 000	301 000
1	400-1	1	CLASS 1 CONC		CY	11 840	11 840
1	400-2	2	CLASS 1 CONC (ENDWALLS)		CY	195 300	195 300
1	400-2-1	1	CLASS 1 CONC (RETAINING WALLS)		CY	38 970	38 970
1	400-2-2	1	CLASS 1 CONC (GULVERTS)		CY	552 000	552 000
1	415-1	1	REINF STEEL (RETAINING WALLS)		LB	4210 000	210 000
1	415-2	2	REINF STEEL (ROADWAY)		LB	42805 000	4805 000
1	425-1	1	INLETS (CURB) (TYPE P-1)		EA	49 000	49 000
1	425-1-311	1	INLETS (CURB) (TYPE P-1)		EA	2 000	2 000
1	425-1-315	1	INLETS (CURB) (TYPE P-2)		EA	2 000	2 000
1	425-1-321	1	INLETS (CURB) (TYPE P-2)		EA	2 000	2 000
1	425-1-351	1	INLETS (CURB) (TYPE P-5)		EA	7 000	7 000
1	425-1-411	1	INLETS (CURB) (TYPE J-1)		EA	5 000	5 000
1	425-1-421	1	INLETS (CURB) (TYPE J-2)		EA	4 000	4 000
1	425-1-471	1	INLETS (CURB) (TYPE 7)		EA	1 000	1 000
1	425-1-521	1	INLETS (DT BOT) (TYPE C)		EA	5 000	5 000
1	425-1-541	1	INLETS (DT BOT) (TYPE D)		EA	5 000	5 000
1	425-1-543	1	INLETS (DT BOT) (TYPE D) (J BOT)		EA	2 000	2 000

THIS EXHIBIT IS FOR EXAMPLE ONLY AND DOES NOT REFLECT THE DEPARTMENT'S DESIGN CRITERIA.

STATE PROJ. NO. 0000 0000
 SHEET NO. 00

CEP011.5.2
 PAGE 07 OF 07

CEP011.5.2
 PAGE 07 OF 07

ITEM NUMBER	ITEM	UNIT	QUANTITY	CONTRACT ITEM	UNIT PRICE	TOTAL
1 01	MOBILIZATION	LS	1 000			1 000
1 02	MAINT OF TRAFFIC FOR DRIVEWAY MAINT	LS	1 000			1 000
1 03	CONC BARRIER (TEMPORARY)	LF	137 000			137 000
1 04	CONC BARRIER (TEMPORARY) - 1.5' H	LF	5397 000			5397 000
1 05	CONSTRUCTION SIGN (POST MOUNTED)	EA	18358 000			18358 000
1 06	CONSTRUCTION SIGN (POST MOUNTED) - 1.5' H	EA	18358 000			18358 000
1 07	ADVANCE WARNING SIGN PANELS	EA	152 000			152 000
1 08	REFLECTIVE PANT MARKER (TEMPORARY)	EA	128 000			128 000
1 09	VERTICAL IMPACT ATTENUATOR (TEMPORARY)	EA	2 000			2 000
1 10	REFLECTIVE PANT MARKER (TEMPORARY) - 1.5' H	EA	152 000			152 000
1 11	REFLECTIVE PANT MARKER (TEMPORARY) - 1.5' H	EA	152 000			152 000
1 12	TEMPORARY PAVEMENT MARKING (SKEWED)	LS	15 902			15 902
1 13	TEMPORARY PAVEMENT MARKING (SKEWED)	LS	15 902			15 902
1 14	TEMPORARY REGULATORY SIGNS (POST MOUNTED)	EA	7572 000			7572 000
1 15	TEMPORARY REGULATORY SIGNS (POST MOUNTED) - 1.5' H	EA	3 000			3 000
1 16	TRAFFIC MARKINGS	MS	19 400			19 400
1 17	TRAFFIC MARKINGS - 1.5' H	MS	19 400			19 400
1 18	TRAFFIC MARKINGS - 1.5' H	MS	19 400			19 400
1 19	TRAFFIC MARKINGS - 1.5' H	MS	19 400			19 400
1 20	REGULAR EXCAVATION (TRUCK MEASURE)	CY	8 443 000			8 443 000
1 21	REGULAR EXCAVATION (TRUCK MEASURE) - 1.5' H	CY	1878 000			1878 000
1 22	TYPE B STABILIZATION	CY	57 000			57 000
1 23	TYPE B STABILIZATION	CY	57 000			57 000
1 24	OPTIONAL BASE (BASE GROUP 01)	CY	37 000			37 000
1 25	OPTIONAL BASE (BASE GROUP 02)	CY	12443 000			12443 000
1 26	OPTIONAL BASE (BASE GROUP 03)	CY	4317 000			4317 000
1 27	OPTIONAL BASE (BASE GROUP 04)	CY	4317 000			4317 000
1 28	OPTIONAL BASE (BASE GROUP 05)	CY	4317 000			4317 000
1 29	OPTIONAL BASE (BASE GROUP 06)	CY	4317 000			4317 000
1 30	OPTIONAL BASE (BASE GROUP 07)	CY	4317 000			4317 000
1 31	OPTIONAL BASE (BASE GROUP 08)	CY	4317 000			4317 000
1 32	OPTIONAL BASE (BASE GROUP 09)	CY	4317 000			4317 000
1 33	OPTIONAL BASE (BASE GROUP 10)	CY	4317 000			4317 000
1 34	OPTIONAL BASE (BASE GROUP 11)	CY	4317 000			4317 000
1 35	OPTIONAL BASE (BASE GROUP 12)	CY	4317 000			4317 000
1 36	OPTIONAL BASE (BASE GROUP 13)	CY	4317 000			4317 000
1 37	OPTIONAL BASE (BASE GROUP 14)	CY	4317 000			4317 000
1 38	OPTIONAL BASE (BASE GROUP 15)	CY	4317 000			4317 000
1 39	OPTIONAL BASE (BASE GROUP 16)	CY	4317 000			4317 000
1 40	OPTIONAL BASE (BASE GROUP 17)	CY	4317 000			4317 000
1 41	OPTIONAL BASE (BASE GROUP 18)	CY	4317 000			4317 000
1 42	OPTIONAL BASE (BASE GROUP 19)	CY	4317 000			4317 000
1 43	OPTIONAL BASE (BASE GROUP 20)	CY	4317 000			4317 000
1 44	OPTIONAL BASE (BASE GROUP 21)	CY	4317 000			4317 000
1 45	OPTIONAL BASE (BASE GROUP 22)	CY	4317 000			4317 000
1 46	OPTIONAL BASE (BASE GROUP 23)	CY	4317 000			4317 000
1 47	OPTIONAL BASE (BASE GROUP 24)	CY	4317 000			4317 000
1 48	OPTIONAL BASE (BASE GROUP 25)	CY	4317 000			4317 000
1 49	OPTIONAL BASE (BASE GROUP 26)	CY	4317 000			4317 000
1 50	OPTIONAL BASE (BASE GROUP 27)	CY	4317 000			4317 000
1 51	OPTIONAL BASE (BASE GROUP 28)	CY	4317 000			4317 000
1 52	OPTIONAL BASE (BASE GROUP 29)	CY	4317 000			4317 000
1 53	OPTIONAL BASE (BASE GROUP 30)	CY	4317 000			4317 000
1 54	OPTIONAL BASE (BASE GROUP 31)	CY	4317 000			4317 000
1 55	OPTIONAL BASE (BASE GROUP 32)	CY	4317 000			4317 000
1 56	OPTIONAL BASE (BASE GROUP 33)	CY	4317 000			4317 000
1 57	OPTIONAL BASE (BASE GROUP 34)	CY	4317 000			4317 000
1 58	OPTIONAL BASE (BASE GROUP 35)	CY	4317 000			4317 000
1 59	OPTIONAL BASE (BASE GROUP 36)	CY	4317 000			4317 000
1 60	OPTIONAL BASE (BASE GROUP 37)	CY	4317 000			4317 000
1 61	OPTIONAL BASE (BASE GROUP 38)	CY	4317 000			4317 000
1 62	OPTIONAL BASE (BASE GROUP 39)	CY	4317 000			4317 000
1 63	OPTIONAL BASE (BASE GROUP 40)	CY	4317 000			4317 000
1 64	OPTIONAL BASE (BASE GROUP 41)	CY	4317 000			4317 000
1 65	OPTIONAL BASE (BASE GROUP 42)	CY	4317 000			4317 000
1 66	OPTIONAL BASE (BASE GROUP 43)	CY	4317 000			4317 000
1 67	OPTIONAL BASE (BASE GROUP 44)	CY	4317 000			4317 000
1 68	OPTIONAL BASE (BASE GROUP 45)	CY	4317 000			4317 000
1 69	OPTIONAL BASE (BASE GROUP 46)	CY	4317 000			4317 000
1 70	OPTIONAL BASE (BASE GROUP 47)	CY	4317 000			4317 000
1 71	OPTIONAL BASE (BASE GROUP 48)	CY	4317 000			4317 000
1 72	OPTIONAL BASE (BASE GROUP 49)	CY	4317 000			4317 000
1 73	OPTIONAL BASE (BASE GROUP 50)	CY	4317 000			4317 000
1 74	OPTIONAL BASE (BASE GROUP 51)	CY	4317 000			4317 000
1 75	OPTIONAL BASE (BASE GROUP 52)	CY	4317 000			4317 000
1 76	OPTIONAL BASE (BASE GROUP 53)	CY	4317 000			4317 000
1 77	OPTIONAL BASE (BASE GROUP 54)	CY	4317 000			4317 000
1 78	OPTIONAL BASE (BASE GROUP 55)	CY	4317 000			4317 000
1 79	OPTIONAL BASE (BASE GROUP 56)	CY	4317 000			4317 000
1 80	OPTIONAL BASE (BASE GROUP 57)	CY	4317 000			4317 000
1 81	OPTIONAL BASE (BASE GROUP 58)	CY	4317 000			4317 000
1 82	OPTIONAL BASE (BASE GROUP 59)	CY	4317 000			4317 000
1 83	OPTIONAL BASE (BASE GROUP 60)	CY	4317 000			4317 000
1 84	OPTIONAL BASE (BASE GROUP 61)	CY	4317 000			4317 000
1 85	OPTIONAL BASE (BASE GROUP 62)	CY	4317 000			4317 000
1 86	OPTIONAL BASE (BASE GROUP 63)	CY	4317 000			4317 000
1 87	OPTIONAL BASE (BASE GROUP 64)	CY	4317 000			4317 000
1 88	OPTIONAL BASE (BASE GROUP 65)	CY	4317 000			4317 000
1 89	OPTIONAL BASE (BASE GROUP 66)	CY	4317 000			4317 000
1 90	OPTIONAL BASE (BASE GROUP 67)	CY	4317 000			4317 000
1 91	OPTIONAL BASE (BASE GROUP 68)	CY	4317 000			4317 000
1 92	OPTIONAL BASE (BASE GROUP 69)	CY	4317 000			4317 000
1 93	OPTIONAL BASE (BASE GROUP 70)	CY	4317 000			4317 000
1 94	OPTIONAL BASE (BASE GROUP 71)	CY	4317 000			4317 000
1 95	OPTIONAL BASE (BASE GROUP 72)	CY	4317 000			4317 000
1 96	OPTIONAL BASE (BASE GROUP 73)	CY	4317 000			4317 000
1 97	OPTIONAL BASE (BASE GROUP 74)	CY	4317 000			4317 000
1 98	OPTIONAL BASE (BASE GROUP 75)	CY	4317 000			4317 000
1 99	OPTIONAL BASE (BASE GROUP 76)	CY	4317 000			4317 000
2 00	OPTIONAL BASE (BASE GROUP 77)	CY	4317 000			4317 000
2 01	OPTIONAL BASE (BASE GROUP 78)	CY	4317 000			4317 000
2 02	OPTIONAL BASE (BASE GROUP 79)	CY	4317 000			4317 000
2 03	OPTIONAL BASE (BASE GROUP 80)	CY	4317 000			4317 000
2 04	OPTIONAL BASE (BASE GROUP 81)	CY	4317 000			4317 000
2 05	OPTIONAL BASE (BASE GROUP 82)	CY	4317 000			4317 000
2 06	OPTIONAL BASE (BASE GROUP 83)	CY	4317 000			4317 000
2 07	OPTIONAL BASE (BASE GROUP 84)	CY	4317 000			4317 000
2 08	OPTIONAL BASE (BASE GROUP 85)	CY	4317 000			4317 000
2 09	OPTIONAL BASE (BASE GROUP 86)	CY	4317 000			4317 000
2 10	OPTIONAL BASE (BASE GROUP 87)	CY	4317 000			4317 000
2 11	OPTIONAL BASE (BASE GROUP 88)	CY	4317 000			4317 000
2 12	OPTIONAL BASE (BASE GROUP 89)	CY	4317 000			4317 000
2 13	OPTIONAL BASE (BASE GROUP 90)	CY	4317 000			4317 000
2 14	OPTIONAL BASE (BASE GROUP 91)	CY	4317 000			4317 000
2 15	OPTIONAL BASE (BASE GROUP 92)	CY	4317 000			4317 000
2 16	OPTIONAL BASE (BASE GROUP 93)	CY	4317 000			4317 000
2 17	OPTIONAL BASE (BASE GROUP 94)	CY	4317 000			4317 000
2 18	OPTIONAL BASE (BASE GROUP 95)	CY	4317 000			4317 000
2 19	OPTIONAL BASE (BASE GROUP 96)	CY	4317 000			4317 000
2 20	OPTIONAL BASE (BASE GROUP 97)	CY	4317 000			4317 000
2 21	OPTIONAL BASE (BASE GROUP 98)	CY	4317 000			4317 000
2 22	OPTIONAL BASE (BASE GROUP 99)	CY	4317 000			4317 000
2 23	OPTIONAL BASE (BASE GROUP 100)	CY	4317 000			4317 000
2 24	OPTIONAL BASE (BASE GROUP 101)	CY	4317 000			4317 000
2 25	OPTIONAL BASE (BASE GROUP 102)	CY	4317 000			4317 000
2 26	OPTIONAL BASE (BASE GROUP 103)	CY	4317 000			4317 000
2 27	OPTIONAL BASE (BASE GROUP 104)	CY	4317 000			4317 000
2 28	OPTIONAL BASE (BASE GROUP 105)	CY	4317 000			4317 000
2 29	OPTIONAL BASE (BASE GROUP 106)	CY	4317 000			4317 000
2 30	OPTIONAL BASE (BASE GROUP 107)	CY	4317 000			4317 000
2 31	OPTIONAL BASE (BASE GROUP 108)	CY	4317 000			4317 000
2 32	OPTIONAL BASE (BASE GROUP 109)	CY	4317 000			4317 000
2 33	OPTIONAL BASE (BASE GROUP 110)	CY	4317 000			4317 000
2 34	OPTIONAL BASE (BASE GROUP 111)	CY	4317 000			4317 000
2 35	OPTIONAL BASE (BASE GROUP 112)	CY	4317 000			4317 000
2 36	OPTIONAL BASE (BASE GROUP 113)	CY	4317 000			4317 000
2 37	OPTIONAL BASE (BASE GROUP 114)	CY	4317 000			4317 000
2 38	OPTIONAL BASE (BASE GROUP 115)	CY	4317 000			4317 000
2 39	OPTIONAL BASE (BASE GROUP 116)	CY	4317 000			4317 000
2 40	OPTIONAL BASE (BASE GROUP 117)	CY	4317 000			4317 000
2 41	OPTIONAL BASE (BASE GROUP 118)	CY	4317 000			4317 000
2 42	OPTIONAL BASE (BASE GROUP 119)	CY	4317 000			4317 000
2 43	OPTIONAL BASE (BASE GROUP 120)	CY	4317 000			4317 000
2 44	OPTIONAL BASE (BASE GROUP 121)	CY	4317 000			4317 000
2 45	OPTIONAL BASE (BASE GROUP 122)	CY	4317 000			4317 000
2 46	OPTIONAL BASE (BASE GROUP 123)	CY	4317 000			4317 000
2 47	OPTIONAL BASE (BASE GROUP 124)	CY	4317 000			4317 000
2 48	OPTIONAL BASE (BASE GROUP 125)	CY	4317 000			4317 000
2 49	OPTIONAL BASE (BASE GROUP 126)	CY	4317 000			4317 000
2 50	OPTIONAL BASE (BASE GROUP 127)	CY	4317 000			4317 000
2 51	OPTIONAL BASE (BASE GROUP 128)	CY	4317 000			4317 000
2 52	OPTIONAL BASE (BASE GROUP 129)	CY	4317 000			4317 000
2 53	OPTIONAL BASE (BASE GROUP 130)	CY	4317 000			4317 000
2 54	OPTIONAL BASE (BASE GROUP 131)	CY	4317 000			4317 000
2 55	OPTIONAL BASE (BASE GROUP 132)	CY	4317 000			4317 000
2 56	OPTIONAL BASE (BASE GROUP 133)	CY	4317 000			4317 000</

CHAPTER 5

DRAINAGE MAP

5.1 General

The drainage map shall be prepared and included in the project file. Inclusion of a drainage map in the plans set is optional at the District's discretion.

The drainage map shall be prepared on sheet format having a profile format across the upper 5" - 10" portion. This area shall be used for plotting the project profile. Topography of the project area shall be located in the remaining portion of the sheet. For inclusion in the plans set, only digitized topography drainage maps shall be used.

If the drainage map is included in the plans set, the presentation of the profile portion is optional to be prepared at the discretion of the District.

The horizontal and vertical scales of the profile should be such that the stations and elevations can be read directly from the grid without the use of a scale. The horizontal scale must be the same for both the plan and profile views. Recommended scales for various facilities are as follows:

<u>Type of Facility</u>	<u>Horizontal Scale</u>	<u>Vertical Scale</u>
Interstate Urban	1" = 200'/400'	1" = 5'/1" = 10'
Interstate Rural	1" = 500'/1,000'	1" = 10'/1" = 20'
Municipal & Other	1" = 100'/200'	1" = 5'/1" = 10'

5 1 1 Flood Data Summary Box

The flood data shall be shown on the drainage map either in the plan or in the profile portion. If the drainage map is not included in the plans set, then the flood data shall be shown on the summary of quantities sheet or on the first plan - profile sheet.

Design, base and overtopping or greatest flood discharge and stage values are required on all federal-aid projects for all cross structures, regardless of size. A "disclaimer" and definitions are required to avoid misuse and possible responsibility for changes in the flood information values over which the DOT has no control.

The drainage designer should provide the information required to complete the box. An example of a completed box is shown on Exhibit EX II-5-A-1.

5.2 Plan Portion

The plan portion shall include the following data

- 1 Stationing shall be shown every 500 feet for all recommended scales except 1" = 1000 for which stationing shall be shown every 5000 feet. Centerline of project with begin and end project stations, station equations, begin and end stations for exceptions and bridge/bridge culverts shall be flagged.
- 2 Physical land features affecting drainage, such as lakes, streams, and swamps shall be clearly labeled by name and direction of flow. Past high water elevations and date of occurrence, if available, and present water elevations along with the dates the readings were taken shall be shown.
- 3 Existing road numbers and street names, drainage structures, showing type, size, flow line elevations, flow arrows and any other pertinent data shall be shown. Refer to Standard Index No. 002 for correct symbols for existing drainage facilities. In a situation of limited space, all data relating to existing drainage structures and pipes may be compiled in a table format and shown in either the plan or profile portion of the sheet. Should the space limitations be such that a table would not fit within the plan or profile view, a supplemental drainage data sheet would be acceptable.
- 4 Drainage divides and information, where applicable, to indicate the overland flow of water shall be shown. Drainage areas on maps shall be shown in acres.

Inserts shall be used to show areas that are of such magnitude that the boundaries cannot be plotted at the selected scale.

- 5 Proposed drainage structures, pipes, outfall structures and retention/detention pond locations shall be shown and noted by structure number Refer to Standard Index No 002 for correct symbols Arrows shall be shown to indicate direction of flow along proposed ditches
- 6 Section, Township, Range and county lines shall be indicated for rural projects and when possible, urban projects
- 7 A north arrow and graphic scale shall be drawn, preferably in the upper right corner
- 8 When not provided on the supplemental drainage structure sheet, culvert backfill values for pH, resistivity, sulfates and chlorides for the various optional culvert materials shall be shown in either the plan or profile portion See Section 8 2

5 3 Profile Portion

The profile portion, if shown, shall include the following data

- 1 The recommended vertical scale for rural and urban projects is 1" = 5' in level terrain and 1" = 10' in rolling terrain although a scale of 1" = 20' may sometimes be used for rural projects through rough terrain to avoid numerous profile breaks Profile can be broken for rolling terrain in urban areas However a scale of 1" = 20' should never be used at locations of proposed storm sewer systems
- 2 Elevation datum shall be shown at each side of the sheet In cases where the 5" profile block is insufficient and excess space is available on the plan portion of the sheet, the profile block may be expanded from a 5" depth to a 8" or 10" depth
- 3 The existing natural ground shall be plotted with a light, solid line and the existing elevation noted at each end of the profile
- 4 The proposed profile grade line shall be plotted using a heavy solid line Percents of grade need not be shown The P C , P I , and P T of vertical curves shall be plotted using their respective standard symbols, however, no data (station, elevation, length of curve) needs be noted Begin and end project bridge and bridge culvert stations, station equations and exceptions shall be flagged and noted Profile grade line elevations shall be shown at begin and end project stations and at the beginning and end of each additional drainage sheet

- 5 When horizontal and vertical scales permit, all proposed special ditches, except median, shall be plotted and indicated with a heavy broken line (long dashes) and D P I elevations and stations noted

- 6 Proposed cross drains shall be plotted and identified by structure number Do not attempt to show skew or pipe slope in plotting but merely plot to elevation and location at point of crossing the construction centerline In cases of more than usual slope, the elevation at each end of the structure shall be shown Median drains need not be shown

- 7 For projects with storm sewer systems, only the mainline structure and pipes shall be shown Laterals need not be shown Each structure shall be flagged with its appropriate structure number, and flow line elevations noted for the incoming and outgoing mainline pipes

- 8 All high waters affecting construction shall be shown (including year) Any high water that is to be lowered shall be so noted and the design high water elevation given A light, broken line shall be drafted at the high water elevation, and the elevation noted

5 4 Interchange Drainage Map

If projects involve interchanges or rest areas, a supplemental drainage map on a 1" = 100' or 1" = 200' scale shall be required showing only the plan portion on a sheet, without a profile grid. The purpose of this detail is to show the small areas needed to calculate pipe sizes for the tabulation of drainage structures within these special areas. Should major drains pass through one of these areas, a cross reference note should indicate the proper sheet which reflects the drainage area for that through-structure.

5 5 Bridge Hydraulic Recommendation Sheet

A bridge hydraulic recommendation sheet (BHRS) shall be prepared on preformatted sheet for all projects involving bridge culverts connecting bodies of water or bridges spanning a body of water, except for minor bridge widening projects. Preformatted sheets can be obtained from the DOT Project Manager/Coordinator or CADD cell library. The inclusion of this sheet in the plans set is optional at the discretion of the District. When included in the plans the BHRS for bridges shall be placed in the structure plans. For bridge culverts it shall be placed in the roadway plans. If the BHRS is not included in the plans, sufficient detail to show the location and extent of bottom and slope protection shall be contained in the plans.

In addition to the hydraulic design data, plan and profile of the bridge structure, existing topography, site location, and drainage areas shall also be shown. The effective area of opening should be shown for existing structures within a reasonable proximity on the same waterway. Parallel (dual) bridges may be shown on one sheet, although a second sheet should be used, if necessary, to clearly convey the fit of the bridge to the stream bank. When two sheets are used, only the plan and profile information needs to be furnished on the second sheet.

A completed Bridge Hydraulic Recommendation Sheet is shown as Exhibit EX II-5-C.

5 5 1 Required Information on BHRS

- 1 Sufficient existing topography and contours shall be shown in the vicinity of the bridge to depict how the structure ties to natural ground. Hydraulic and other data on existing structures shall be provided. On bridge culverts in some cases such as in level topography with a cut canal, the contours may be omitted.

- 2 High water information shall be shown on the BHRS. The elevation measured at the time of the survey with month, day and year should be shown in the profile.
- 3 The drainage area and location map section should include a map with a north arrow. The map shall be of a scale so that the entire drainage area for the proposed structure is shown. The drainage area boundaries should be shown using a very heavy broken line with the area in acres or square miles shown within the boundary. The proposed structure location should be shown. Existing structures over the same water body should be located and numbered and corresponding existing structure information listed in the appropriate columns.
- 4 Proposed bridges shall be shown indicating abutments, slope protection, anticipated scour depths with protective recommendations, if any, and other recommendations.

THIS EXHIBIT IS FOR EXAMPLE ONLY AND DOES NOT REFLECT THE DEPARTMENT'S DESIGN CRITERIA.

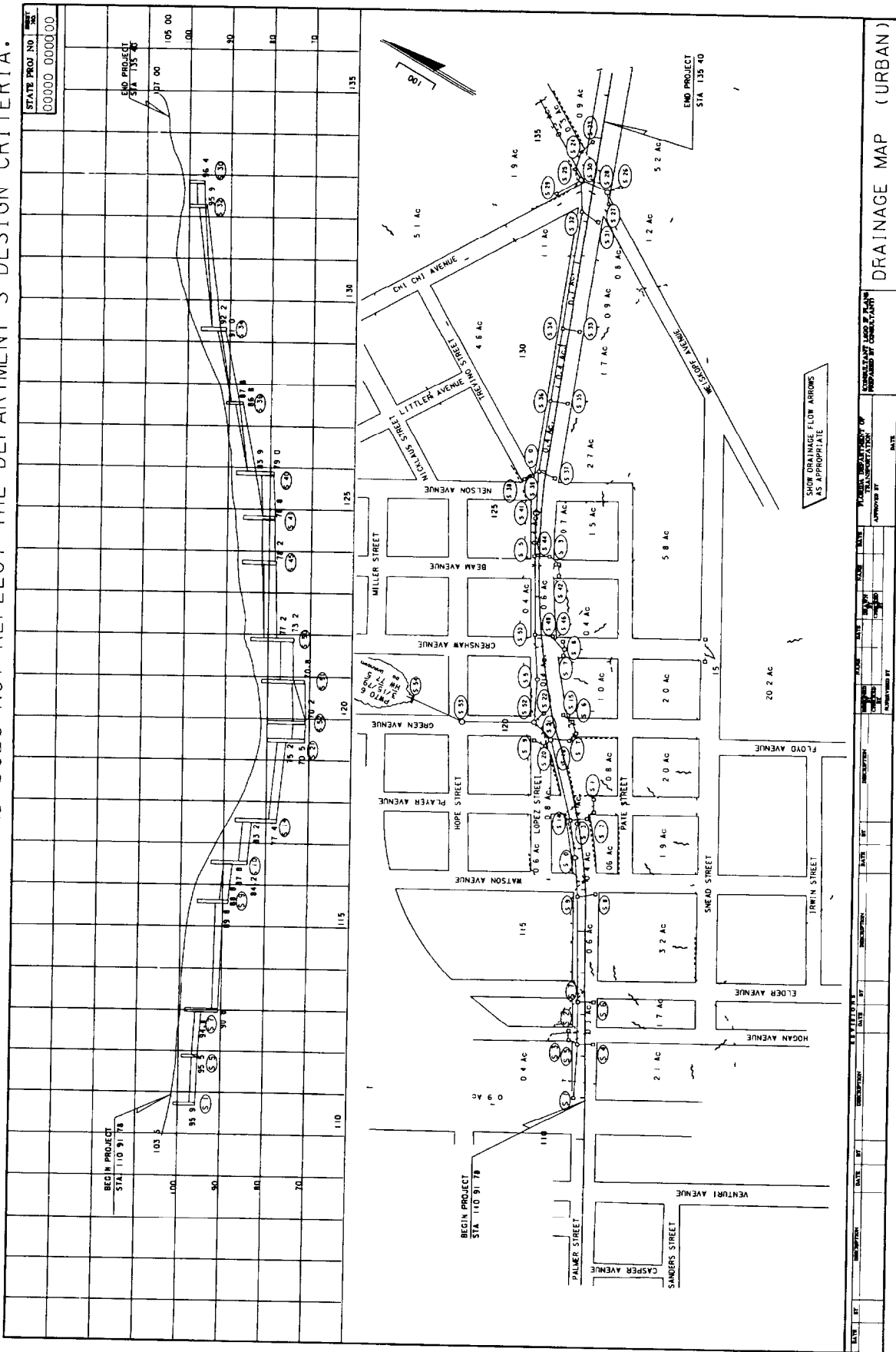

STATE PROJ NO	00000	00000000
BEGIN PROJECT STA	110 91 78	
END PROJECT STA	135 40	
DATE		
DESCRIPTION		
DATE		
BY		
CHECKED BY		
DATE		
APPROVED BY		
DATE		
SCALE		
PROJECT NO		
DATE		
BY		
CHECKED BY		
DATE		
APPROVED BY		
DATE		

DRAINAGE MAP (URBAN)

EX II 5 A

STATE PR NO
00000 0000 0

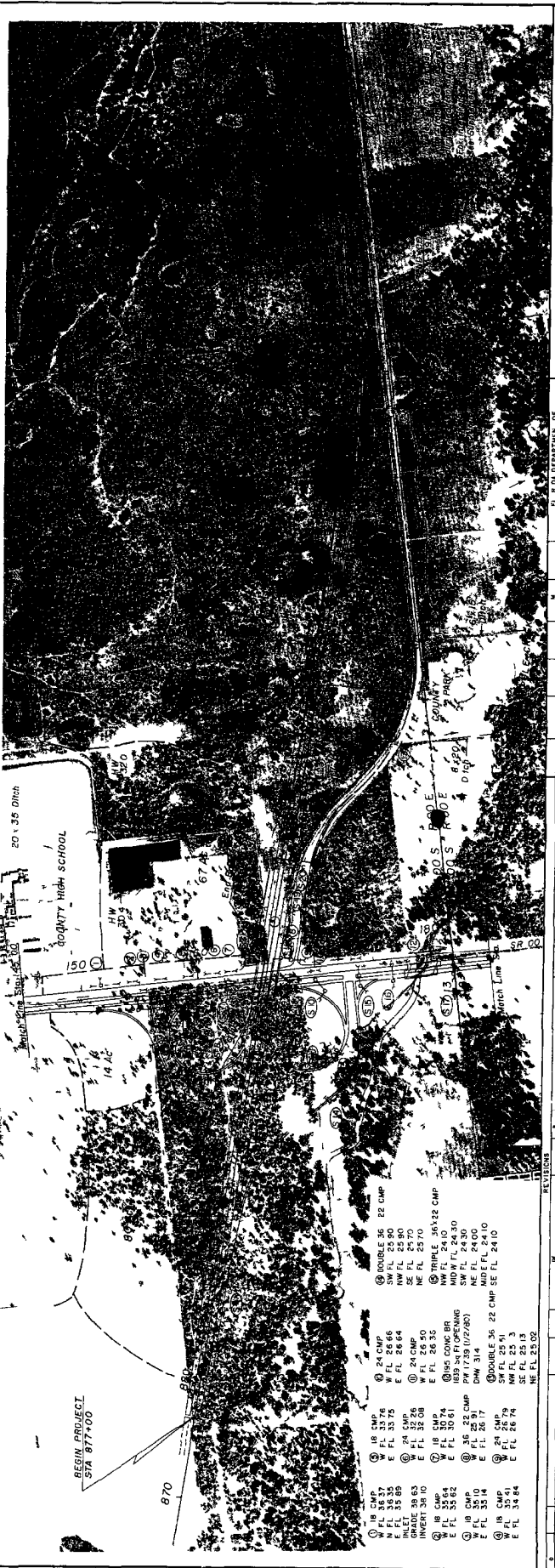
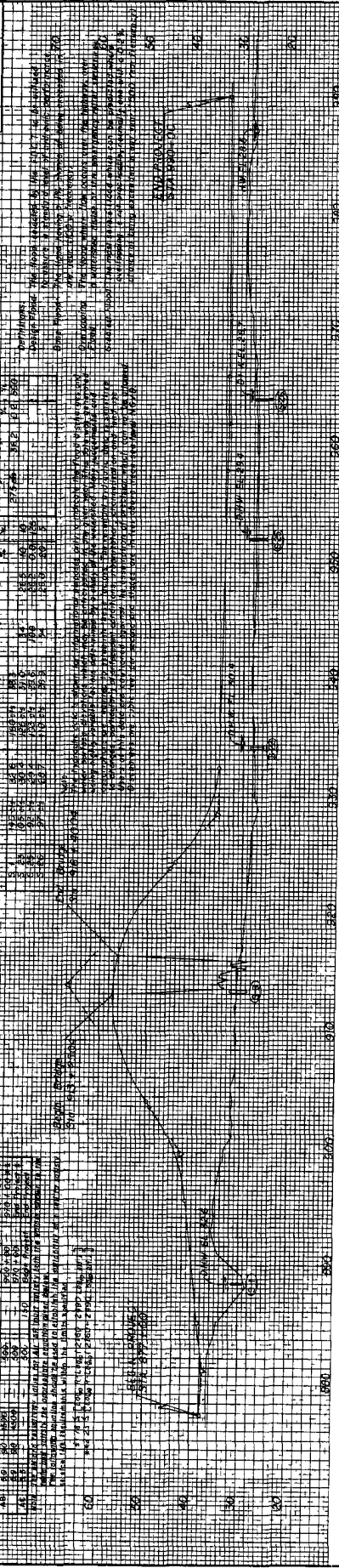

NO.	DATE	REVISIONS
1		
2		
3		
4		
5		
6		
7		
8		
9		
10		
11		
12		
13		
14		
15		
16		
17		
18		
19		
20		
21		
22		
23		
24		
25		
26		
27		
28		
29		
30		
31		
32		
33		
34		
35		
36		
37		
38		
39		
40		
41		
42		
43		
44		
45		
46		
47		
48		
49		
50		
51		
52		
53		
54		
55		
56		
57		
58		
59		
60		
61		
62		
63		
64		
65		
66		
67		
68		
69		
70		
71		
72		
73		
74		
75		
76		
77		
78		
79		
80		
81		
82		
83		
84		
85		
86		
87		
88		
89		
90		
91		
92		
93		
94		
95		
96		
97		
98		
99		
100		

DRAINAGE MAP

EX II 5-A I

STATE PROJ NO
00000 0000 00
BRIDGE NO 000000

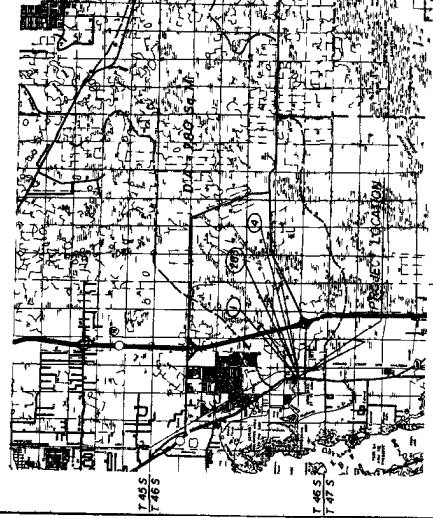

(REFERENCE)	(1)	(2)	(3)	(4)
FOUNDATION	Timber Pile	C (2) Pile	T (3) Pile	C (4) Pile
OVERALL LENGTH	107.00	70.00	50.00	70.00
TYPE CONSTRUCTION	Timber	Concrete	Concrete	Concrete
AREA OF OPENING @ H.W.	200.00	100.00	100.00	100.00
ELEV LOW NUMBER	2.00	1.00	1.00	1.00

HYDRAULIC DESIGN DATA

NOTE: The hydraulic design is based on the assumption that the bridge will be a single span structure with a clear span of 100 feet. The design is based on the assumption that the bridge will be a single span structure with a clear span of 100 feet.

DEFINITIONS

1. BEGIN BRIDGE STA 1103+35.00
2. END BRIDGE STA 1105+10.00
3. LIMITING SECTION STA 1104+50.00
4. CLEARANCE NAVIGATION HORIZ 25 FEET 3 INCHES ABOVE EL. 100.00
5. SCOUR PROTECTION 5 FEET ABOVE EL. 100.00
6. SLOPE PROTECTION 5 FEET ABOVE EL. 100.00
7. DECK DRAINAGE 5 FEET ABOVE EL. 100.00
8. OTHER 5 FEET ABOVE EL. 100.00

FLOOD DATA

STAGE ELEV (AGD) (FT)	100.00
DISCHARGE (CFS)	10000
EXCESSIVE PROB (%)	10
FREQUENCY (YR)	100

HYDRAULIC RECOMMENDATIONS

1. BEGIN BRIDGE STA 1103+35.00
2. END BRIDGE STA 1105+10.00
3. LIMITING SECTION STA 1104+50.00
4. CLEARANCE NAVIGATION HORIZ 25 FEET 3 INCHES ABOVE EL. 100.00
5. SCOUR PROTECTION 5 FEET ABOVE EL. 100.00
6. SLOPE PROTECTION 5 FEET ABOVE EL. 100.00
7. DECK DRAINAGE 5 FEET ABOVE EL. 100.00
8. OTHER 5 FEET ABOVE EL. 100.00

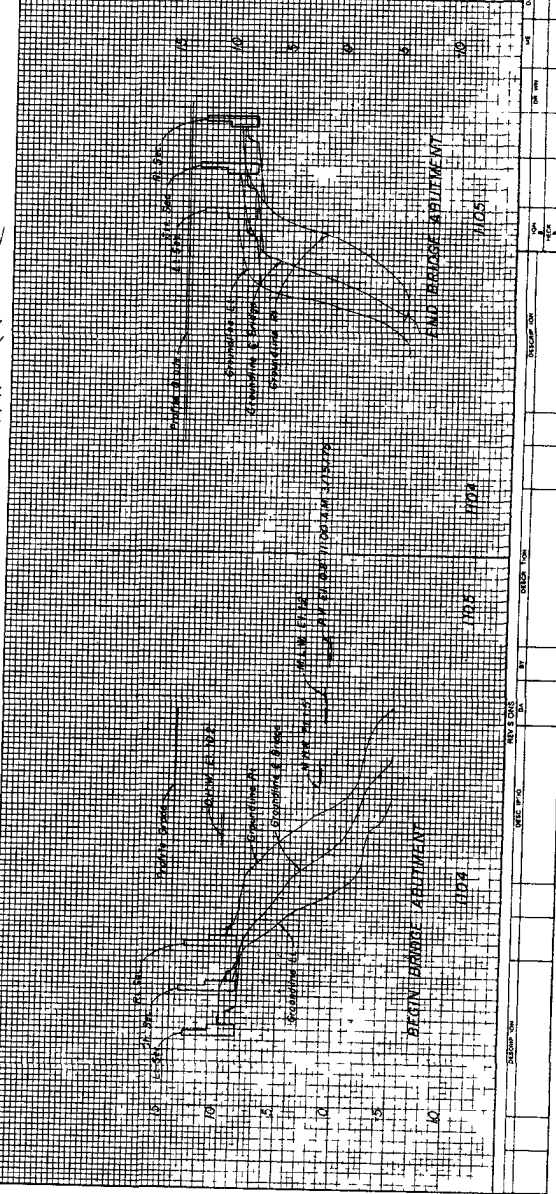
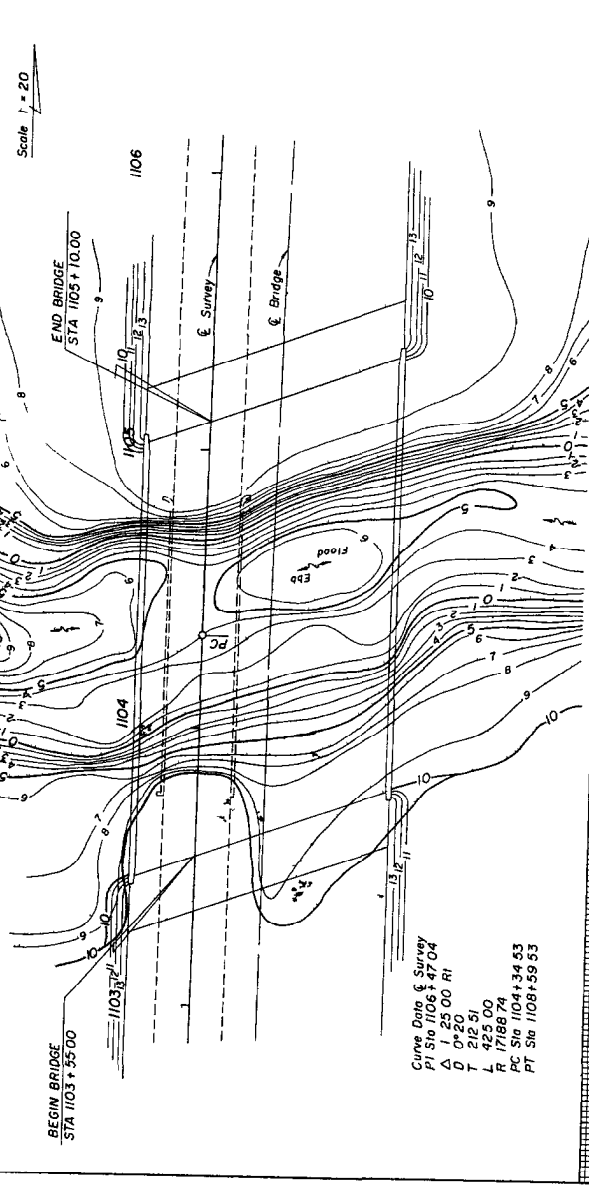

BRIDGE HYDRAULIC RECOMMENDATIONS

EXII 5 C

CHAPTER 6

TYPICAL SECTIONS

6.1 General

Typical sections depict the design elements of the proposed roadway, and shall be shown in the form of cross sections depicting the work which is standard or typical within certain station-to-station limits.

The typical sections for a project are either established prior to starting the final design, or are developed by the design engineer. The DOT CADD Manual's Library of Cells contains a number of typical sections that can be used and adjusted to suit the conditions of a particular project. Usually typical sections are not drafted to scale, but the horizontal dimensions should be proportionate.

Typical sections should show typical conditions only. Non-standard conditions that prevail for short distances only should not be shown.

When more than one typical section is necessary for a project, the station limits of each section shall be shown below the typical section title. Typical section stationing shall cover the entire project. Transitions from one typical to another shall be included in the stationing of one or the other typical section.

When partial sections are necessary to cover the details, these sections shall be shown near the main typical section to which they apply. If space is not available, they may be grouped on a separate sheet.

For complete illustrations of typical sections, see (Exhibits II-6A thru H.)

6.2 Mandatory Information

Typical sections for all projects shall include the following data:

1. Design speed for each typical section
2. Traffic data (2-way ADT)
 - a. Current year
 - b. Post construction year
 - c. Design year
 - New Construction - 20 years
 - Overlay - 8 - 12 years
 - Milling & Resurfacing - 10 - 12 years
 - d. Traffic data (ADT) is required to be noted for the current year or the post construction year on skid hazard project only.
 - e. K, D and T factors

The data shown shall be consistent with the data used for pavement design.
3. Cross Slopes
 - a. Cross slopes of roadway pavement, shoulder surfaces, sidewalks and bridge decks shall be expressed as a decimal part of a foot vertical per foot horizontal. These cross slopes shall be rounded to two decimal places, i.e., .02, .06.
 - b. Median and outer slopes shall be shown by ratio, horizontal to vertical, i.e., 4:1., 2:1.
 - c. Either feathering details or notes (or both) shall be shown when resurfacing in urban ^{curb and sections} gutter ~~areas~~ is specified.
4. Profile grade point shall be flagged.

5. The scope of pavement construction shall be described in a clear, precise manner by indicating the IFR requirement and the thickness of the subgrade stabilization, subbase or base, structural course, friction course and shoulder pavement. Pavement structure information shall be obtained from the approved pavement design and shall be described in the order of construction, i.e. starting with bottom layer and ending with friction course.
 6. Limits of grassing.
 7. Sidewalk location and width.
 8. Curb and gutter location and type.
 9. Reference to all standard indexes necessary for construction of proposed typical section shall be indicated below the pavement description.
 10. Template dimensions. For widening projects, the existing pavement width shall be shown as a +/- dimension, and the base widening width shall be shown with an asterisk. As near to this noted asterisk as possible, the following statement shall be shown: "*Actual width of base widening may vary due to actual existing pavement width. Contractor may elect to place uniform width base widening strip at no additional cost."
- NOTE: For typical sections with varying dimensions, the dimensions shall be clearly indicated on the plan - profile sheets.
11. Limits of clearing and grubbing, where applicable.
 12. R/W, where applicable.

6.3 Standard Notes for Typical Section Sheets

Below are standard notes which shall be shown on typical section sheets as applicable

- 1 "All seeding and seeding and mulch areas are to receive a 6" muck blanket or topsoil treatment "
(Note When muck or topsoil is required under sodded areas, the above note shall say "All grass areas are to receive a 6" muck blanket or topsoil treatment ")
2. "For details and limits of selective clearing and grubbing see _____ "
- 3 "None of the existing limerock base that is removed is to be used in the construction of the new limerock base "
- 4 "All of the existing limerock base that is removed is to be incorporated in the stabilized portion of the subgrade "
- 5 "The contractor shall bid on only one friction course alternate " |
- 6 (Under paved shoulders) "At the contractor's option, this area |
may be constructed of base material at no additional
compensation "
- 7 "Only one dense graded friction course FC-1 or FC-4 is to be |
used throughout the limits of the project "

- | 8. (To appear on typical section only when component plans are not included). "It shall be the contractor's responsibility to determine the field location and length of any no-passing zone. No-passing zones shall be established in accordance with Section 3B-3, 3B-4, and 3B-5 of the current MUTCD and chapter 4-6 16 of the Department's Manual on Uniform Traffic Studies. The contractor's proposed method of establishing no-passing zones must be approved in advance of construction by the Engineer. The cost of establishing the no-passing zones shall be considered as incidental to traffic striping items included in the contract."
- | 9 "Actual width of base widening may vary due to actual existing pavement width. Contractor may elect to place uniform width base widening strip at no additional cost."

THIS EXHIBIT IS FOR EXAMPLE ONLY AND DOES NOT REFLECT THE DEPARTMENT'S DESIGN CRITERIA.

STATS PROJ. NO. 00000-0000 00

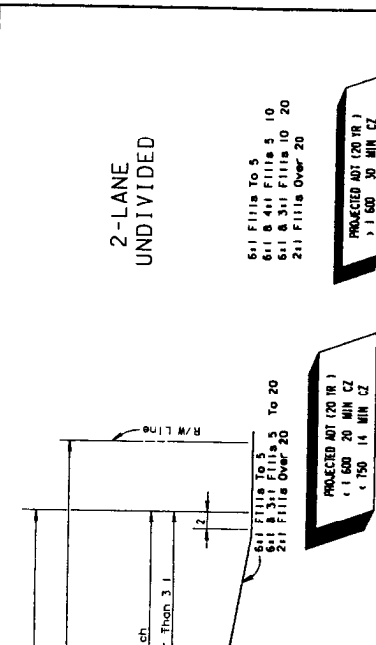

2-LANE
UNDIVIDED

6:1 FILL TO 5
6:1 & 4:1 FILL TO 10
6:1 & 3:1 FILL TO 20
2:1 FILL OVER 20

PROJECTED ADT (20 YR)
1,500 20 MIN CZ
5,100 30 MIN CZ

NOTE:
ALL PAVEMENT DESCRIPTIONS
FOR EXAMPLE ONLY

4-LANE
DIVIDED

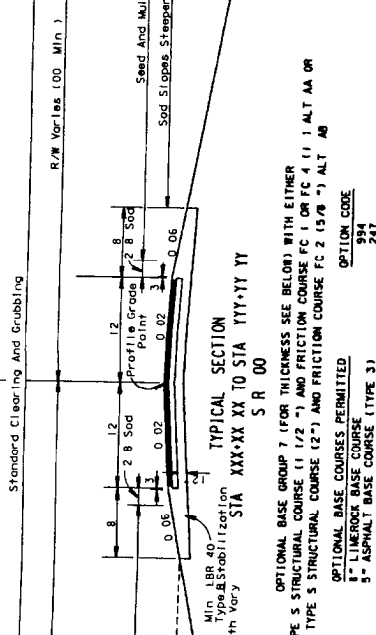

NOTE: Contractor should identify the proposed option on which the bid is based by entering the three digit optional code to the right of the item number of optional base item on the submitted bid proposal

OPTIONAL BASE GROUP 7 (FOR THICKNESS SEE BELOW) WITH EITHER
TYPE 5 STRUCTURAL COURSE (1 1/2") AND FRICTION COURSE FC 1 OR FC 4 (1) ALT AA OR
TYPE 5 STRUCTURAL COURSE (2") AND FRICTION COURSE FC 2 (15/8") ALT AB
OPTIONAL BASE COURSES PERMITTED
934 LIME ROCK BASE COURSE
247 ASPHALT BASE COURSE
FOR ADDITIONAL DETAILS SEE INDEX NOS 104 281 400 508 509 510 & 513

Const & Survey
Standard Clearing And Grubbing

6:1 FILL TO 5
6:1 & 4:1 FILL TO 10
6:1 & 3:1 FILL TO 20
2:1 FILL OVER 20

NOTE:
THE CONTRACTOR SHOULD

PAVEMENT DESCRIPTION

TRAFFIC DATA

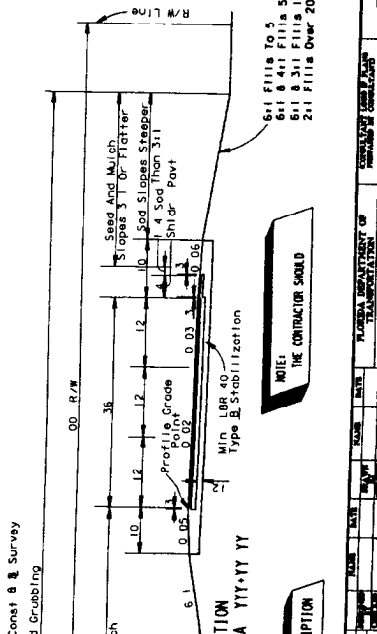

6-LANE
DIVIDED

6:1 FILL TO 5
6:1 & 4:1 FILL TO 10
6:1 & 3:1 FILL TO 20
2:1 FILL OVER 20

NOTE:
THE CONTRACTOR SHOULD

PAVEMENT DESCRIPTION

TRAFFIC DATA

DATE	BY	DESCRIPTION	SCALE	DATE	BY	DESCRIPTION	SCALE	DATE	BY	DESCRIPTION

TYPICAL SECTIONS RURAL

FX-11-6-A

STATE PROJ NO. 00000 0000 00
 SHEET NO. 00

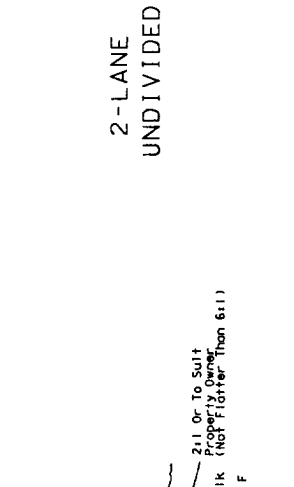

2-LANE
UNDIVIDED

NOTE: The Contractor should identify the proposed option on which his initial bid is based by entering the three digit option code to the right side of the item number of optional base item on the submitted bid proposal.

OPTIONAL BASE GROUP 8 (FOR THICKNESS SEE BELOW) WITH TYPE 5 STRUCTURAL COURSE (1 1/2") AND FRICTION COURSE FC 1 OR FC 4 (1")
 10" LIMESTONE BASE COURSE PERMITTED. DETAIL CODE 990
 6" ASPHALT BASE COURSE (TYPE 3)
 327
 FOR ADDITIONAL DETAILS SEE INDEX NOS. 300 303 304 500 511 513 & 515

Current Design Year 19 ADT
 Estimated Opening Year 19 ADT
 Design Year 20 ADT
 K 3 0 1 T 1 24 Hr
 Design Speed MPH

△ Either Sod or Sod, or both by station limits.

△△ Either Sod, Sod Bed Mulch, Sod or Sod or Sod. If Sod or Sod the percentage of each shall be given by station, or each shall be shown by station limits.

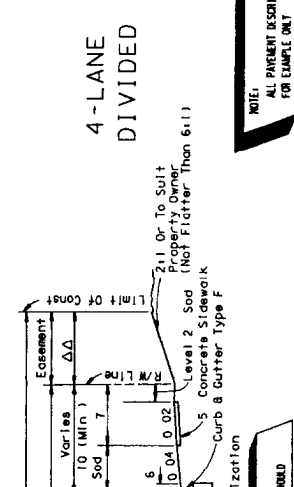

4-LANE
DIVIDED

TRAFFIC DATA

NOTES FOR TYPICAL SECTION NOTES SEE SECTION 8.3

2.1 Or To Suit Property Owner (Not Flatter Than 6:1)

PAVEMENT DESCRIPTION

NOTE: THE CONTRACTOR SHOULD

NOTE: ALL PAVEMENT DESCRIPTION FOR EXAMPLE ONLY

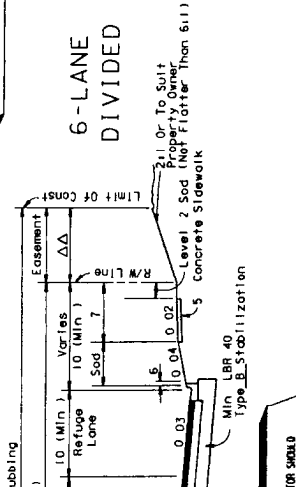

6-LANE
DIVIDED

TRAFFIC DATA

2.1 Or To Suit Property Owner (Not Flatter Than 6:1)

PAVEMENT DESCRIPTION

NOTE: THE CONTRACTOR SHOULD

DATE	BY	DESCRIPTION	DATE	BY	DESCRIPTION	DATE	BY	DESCRIPTION

TYPICAL SECTIONS
URBAN WITH REFUGE LANES

EX-11-6-B

THIS EXHIBIT IS FOR EXAMPLE ONLY AND DOES NOT REFLECT THE DEPARTMENT'S DESIGN CRITERIA.

STATE PROJ. NO. 00000 00000 00

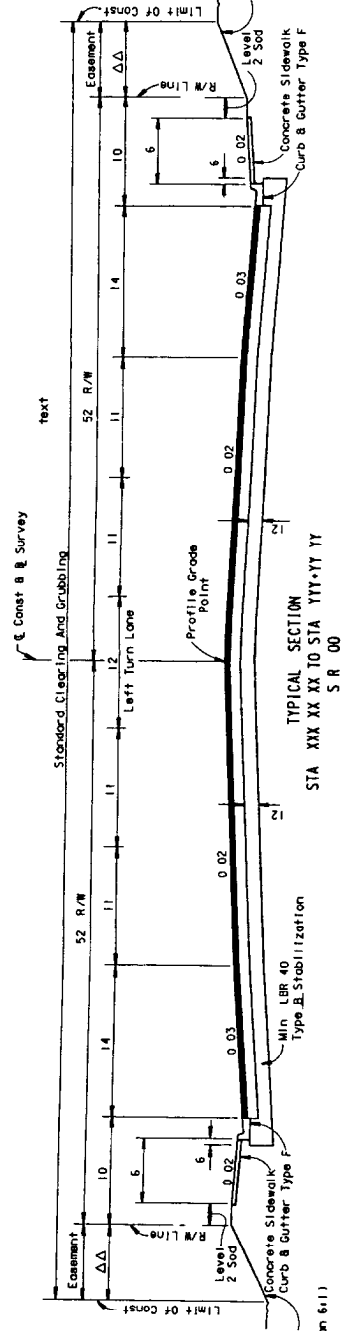

6-LANE
UNDIVIDED

NOTE:
ALL PAVEMENT DESCRIPTION
FOR EXAMPLE ONLY

OPTIONAL BASE GROUP 9 (FOR THICKNESS SEE BELOW) WITH EITHER
TYPE 5 STRUCTURAL COURSE (11/2") AND FRICTION COURSE FC 1 OR FC 4 (1") ALT AA OR
TYPE 5 STRUCTURAL COURSE (2") AND FRICTION COURSE FC 2 (5/8") ALT AB
OPTIONAL BASE COURSES PERMITTED
10" LIME ROCK BASE COURSE
6 ASPHALT BASE COURSE (TYPE 3)
FOR ADDITIONAL DETAILS SEE INDEX NOS 300 304 500 511 513 514 & 515

NOTES:
For Typical Section Notes
See Section 6.3

Current Year 19 __ ADT
Estimated Opening Year 19 __ ADT
Design Year 19 __ ADT
K 3.0 S T 1.5 T 1.24 Hr 1
Design Speed __ MPH

NOTE:
Contractor should identify the proposed option on which
his initial bid is based and the number of optional base items on
the submitted bid proposal

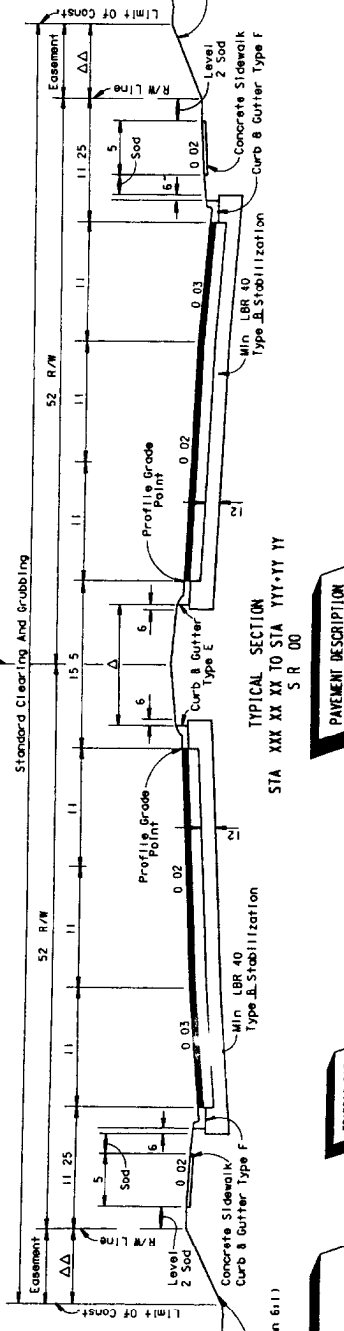

6-LANE
DIVIDED

NOTE:
THE CONTRACTOR SHOULD

PAVEMENT DESCRIPTION

TRAFFIC DATA

△ Either Seed or Sod or both by station limits

△△ Either Seed, Seed and Mutch Sod or Sod or Sod. If Sod or Sod, the percentage of each shall be given by station or each shall be shown by station limits.

DATE	BY	DESCRIPTION	SCALE	DATE	BY	DESCRIPTION	SCALE	DATE	BY	DESCRIPTION

TYPICAL SECTIONS
URBAN MINIMUM REQUIREMENTS
EX-11-6-D

THIS EXHIBIT IS FOR EXAMPLE ONLY AND DOES NOT REFLECT THE DEPARTMENT'S DESIGN CRITERIA.

STATE PROJ. NO. 100
00000-0000 00

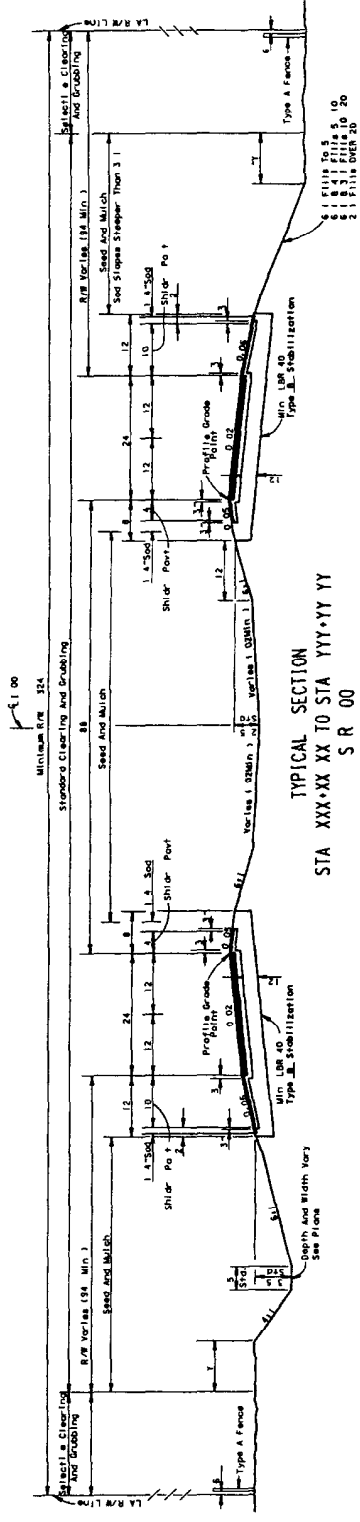

4-LANE

TYPICAL SECTION
STA XXX-XX XX TO STA YYY-YY YY
S R 00

OPTIONAL BASE GROUP 9 (FOR THICKNESS SEE BELOW) WITH
TYPE 5 LIMESTONE COURSE 14" AND FRICTION COURSE FC 2 (15/8")
OPTIONAL BASE COURSES PERMITTED ORIGINAL CODE
10" LIMESTONE BASE COURSE 990
6" ASPHALT BASE COURSE (TYPE 3) 327

FOR ADDITIONAL DETAILS SEE INDEX NOS 104 281 400 450 491 500 505 510 513 514 8 825

ON AREA DISTURBED DURING CONSTRUCTION

NOTES
TYPICAL SECTION NOTES
SEE SECTION 67

Current Year 19 ___ ADT ___
Estimated Opening Year 19 ___ ADT ___
Design Year 19 ___ ADT ___
K = 1.0 S T = 3 T = 3124 Hr)
Design Speed ___ MPH

NOTES
ALL PAVEMENT DESCRIPTIONS
FOR EXAMPLE ONLY

NOTE:
The Contractor should identify the proposed option
on which this initial bid is based by entering the three
digit number in the space provided. The number
of optional base from the substituted bid proposed.

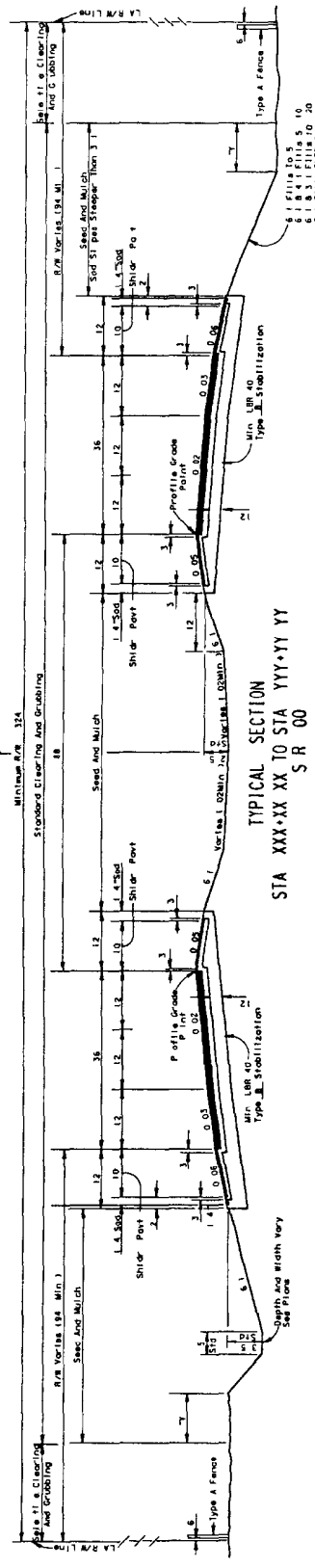

6-LANE

TYPICAL SECTION
STA XXX-XX XX TO STA YYY-YY YY
S R 00

OPTIONAL BASE GROUP 9 (FOR THICKNESS SEE BELOW) WITH
TYPE 5 STRUCTURAL COURSE 14" AND FRICTION COURSE FC 2 (15/8")
OPTIONAL BASE COURSES PERMITTED ORIGINAL CODE
10" LIMESTONE BASE COURSE 990
6" ASPHALT BASE COURSE (TYPE 3) 327

FOR ADDITIONAL DETAILS SEE INDEX NOS 104 281 400 450 492 505 510 513 514 8 825

Current Year 19 ___ ADT ___
Estimated Opening Year 19 ___ ADT ___
Design Year 19 ___ ADT ___
K = 1.0 S T = 3 T = 3124 Hr)
Design Speed ___ MPH

DATE	BY	DESCRIPTION	DATE	BY	DESCRIPTION	DATE	BY	DESCRIPTION

TYPICAL SECTION(S) (INTERSTATE)

EX-11-6-E

THIS EXHIBIT IS FOR EXAMPLE ONLY AND DOES NOT REFLECT THE DEPARTMENT'S DESIGN CRITERIA.

STATE PROJ. NO. 00000 0000 0000
 SHEET NO. 00

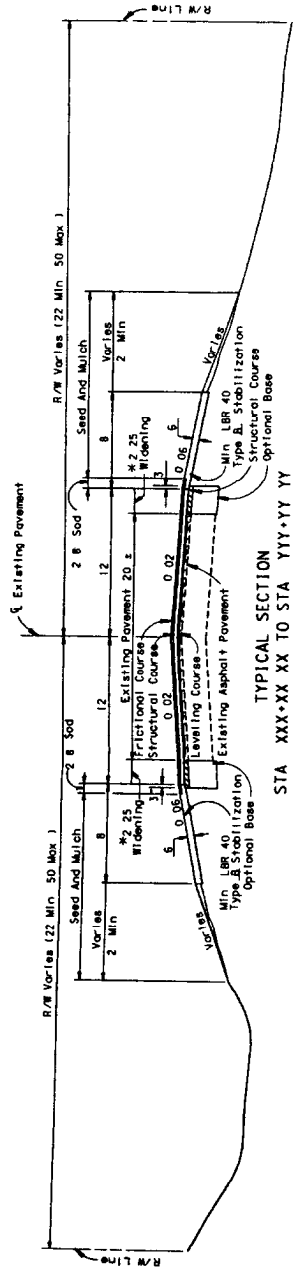

2-LANE
UNDIVIDED

TYPICAL SECTION
 STA XXX-XX XX TO STA YYY+YY YY

RESURFACING
 TYPE 5 LEVELING COURSE (175 LBS/SY AVG.) WITH EITHER
 TYPE 5 STRUCTURAL COURSE (175 LBS/SY) AND FRICTION COURSE FC 1 OR FC 4 (1) ALT. AA OR
 TYPE 5 STRUCTURAL COURSE (200 LBS/SY) AND FRICTION COURSE FC 2 (15/8) ALT. AB
 WIDENING

WIDENING
 OPTIONAL BASE GROUP 11 (FOR THICKNESS SEE BELOW) WITH EITHER
 TYPE 5 STRUCTURAL COURSE (350 LBS/SY) AND FRICTION COURSE FC 1 OR FC 4 (1) ALT. AA OR
 TYPE 5 STRUCTURAL COURSE (400 LBS/SY) AND FRICTION COURSE FC 2 (15/8) ALT. AB
 OPTIONAL BASE COURSES PERMITTED
 1 1/2 LIMESTONE BASE COURSE (TYPE 3)
 987
 7 ASPHALT BASE COURSE (TYPE 3)

FOR ADDITIONAL DETAILS SEE INDEX NOS 105 280 400 510 514 B 516

NOTE:
 Actual width of base widening may vary due to actual existing pavement width. Contractor must adjust to base uniform width base widening strip of no additional cost.

NOTE:
 The Contractor should identify the proposed option on which his initial bid is based by entering the three digit option code to the right side of the item number of optional base item on the submitted bid proposal.

Current Year
 Estimated Opening Year
 Design Year

19 — ADT
 20 — ADT
 K — D — T — S — T — (124 Hr)
 Design Speed — MPH

NOTE:
 FOR TYPICAL SECTION NOTES
 SEE SECTION 6.3

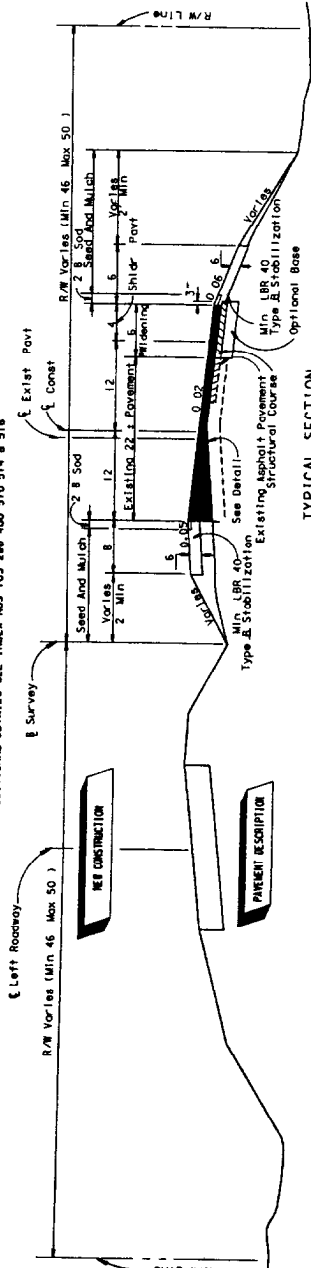

4-LANE
DIVIDED

TYPICAL SECTION
 STA XXX-XX XX TO STA YYY YY YY

RESURFACING
 TYPE 5 OVERBUILD COURSE (275 LBS/SY AVG. INSIDE LANE) AND
 LEVELING COURSE (175 LBS/SY) WITH EITHER
 TYPE 5 STRUCTURAL COURSE (175 LBS/SY) AND FRICTION COURSE FC 1 OR FC 4 (1) ALT. AA OR
 TYPE 5 STRUCTURAL COURSE (200 LBS/SY) AND FRICTION COURSE FC 2 (15/8) ALT. AB
 WIDENING

WIDENING
 OPTIONAL BASE GROUP 11 (FOR THICKNESS SEE BELOW) WITH EITHER
 TYPE 5 STRUCTURAL COURSE (350 LBS/SY) AND FRICTION COURSE FC 1 OR FC 4 (1) ALT. AA OR
 TYPE 5 STRUCTURAL COURSE (400 LBS/SY) AND FRICTION COURSE FC 2 (15/8) ALT. AB
 OPTIONAL BASE COURSES PERMITTED
 1 1/2 LIMESTONE BASE COURSE (TYPE 3)
 987
 7 ASPHALT BASE COURSE (TYPE 3)

FOR ADDITIONAL DETAILS SEE INDEX NOS 105 280 400 510 514 B 516

NOTE:
 Actual width of base widening may vary due to actual existing pavement width. Contractor must adjust to base uniform width base widening strip of no additional cost.

NOTE:
 The Contractor should identify the proposed option on which his initial bid is based by entering the three digit option code to the right side of the item number of optional base item on the submitted bid proposal.

Current Year
 Estimated Opening Year
 Design Year

19 — ADT
 20 — ADT
 K — D — T — S — T — (124 Hr)
 Design Speed — MPH

NOTE:
 FOR TYPICAL SECTION NOTES
 SEE SECTION 6.3

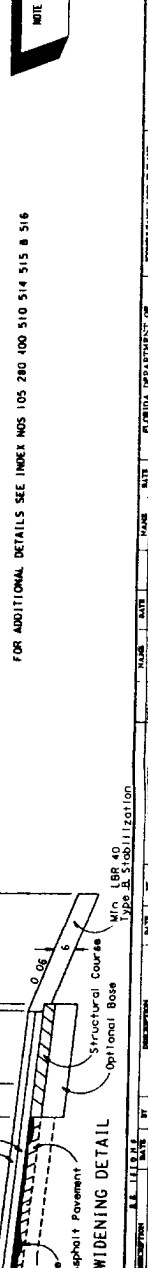

RESURFACING & WIDENING DETAIL

NOTE:
 ALL PAVEMENT DESCRIPTIONS
 FOR EXAMPLE ONLY

NOTE:
 THE CONTRACTOR SHOULD

DATE	BY	DESCRIPTION	DATE	BY	DESCRIPTION	DATE	BY	DESCRIPTION

FLORIDA DEPARTMENT OF TRANSPORTATION
 UNIVERSITY OF FLORIDA
 DATE

CHAPTER 7

SUMMARY OF QUANTITIES

7.1 General

The summary of quantities shows individual summaries of guardrail, fence, turnouts, sodding, ditch pavement, side drains, mitered end sections, underdrains, and earthwork when applicable. The tabulation shall show widths, lengths and area in the plan quantity column. The final quantity column is reserved for construction and final estimates. As noted in Chapter 4, the necessary pay items and the estimated quantities shall be shown on the summary of pay items sheet.

For a complete illustration of summary of quantities see Exhibit II-7-A.

7.2 Item Quantity "Boxes" and Format

The various "boxes" used for each type of summary are contained in the cell library, found in the DOT CADD manual. The arrangement of these "boxes" on the sheet is dependent on the number used and the size each one must be to contain all of the necessary information. Aesthetics should be considered.

Standard notes, listed in Section 7.4, shall be shown under the appropriate box.

Applicable pay item notes, listed in Section 7.5, ~~shall~~^{may} also be included on this sheet.

On contracts with multiple project numbers or federal aid and non-federal aid quantities, provisions shall be made to tabulate and summarize their respective quantities.

7.3 Box Culvert Data Sheet

Box culvert data sheets are obtained by computer design of the box culvert. Only the hard copy of data sheets showing concrete and steel quantities shall be included in the construction plans. Station numbers shall be inserted for cross reference. This sheet may be the output for concrete and steel quantities generated by the box culvert program, and placed behind the CES computer summary of pay items. As an alternate, the concrete and steel output files may be transferred to a graphics design file and placed on a normally formatted plan sheet.

7.4 Standard Notes for Summary of Quantities Sheet

Below are standard notes which should be used on the summary of quantities sheet, as applicable

- 1 (Under Summary of Earthwork) "Earthwork has been calculated using the ___ base option. If another option is constructed, there shall be no revision to the earthwork quantities for which payment is made by plan quantity."

- 2 (Under Summary of Earthwork) "Estimated _____ C Y of unclassified material to be displaced by the storm sewer (or drainage structure) system not included in quantities shown above."

7.5 Pay Item Notes

- | | | |
|---|---------|--|
| 1 | 105-70 | A total of ____ trainee(s) is (are) required on this project. Total manhours were estimated at an average of 1000 manhours per trainee. |
| 2 | 110-3 | <u>(To be used when maintenance indicates a desire for the salvageable material)</u> All salvageable material as determined by the project engineer is to be stockpiled within the right-of-way for removal by DOT forces. |
| 3 | 120-2-1 | To be furnished by the contractor from areas provided by him. Measurement shall be based on the measurement of the borrow pit. At the contractor's option, measurement may be based on loose truck volume, in which case payment will be made on ____% of the truck measured quantity. |
| 4 | 120-2-2 | To be furnished by the contractor from areas provided by him. |
| 5 | 120-6 | Any borrow excavation required shall be furnished by the contractor from areas provided by him and the cost of furnishing such material is to be included in the price for embankment. |

- | | | |
|----|----------|--|
| 6 | 331-2 | Includes removal of existing raised reflective pavement markers prior to starting operations Included (or includes ___ tons) for adjustment of connections to existing drives, streets, etc as directed by the Engineer |
| 7 | 400-1-15 | Includes _____ C Y for miscellaneous construction as directed by the Project Engineer |
| 8 | 536-73 | <u>(To be used only when material is to become the property of DOT)</u> Existing guardrail to be dismantled and stockpiled within the right-of-way in areas designated by the Project Engineer for removal by DOT maintenance forces |
| 9 | 538-1 | This is to include furnishing and installing ___ panels, ___ regular posts and ___ special posts which have been determined to be non-salvageable Additional posts and panels determined to be non-salvageable during resetting shall be paid for under Section 538-5 of the standard specifications |
| 10 | 570-5 | Based on ___ applications |

5. 105-70 A total of _____ trainee(s) is (are) required on this project. Total manhours were estimated at an average of 1000 manhours per trainee.
6. 110-3 All salvageable material as determined by the project engineer is to be stockpiled within the right-of-way for removal by DOT forces.
7. 110-3 Material has no salvage value for the DOT and will become the property of the contractor.
8. 120-1 Includes the cost of removal and disposal of unsuitable material that may be encountered during excavation for widening strips as directed by the Engineer. *(To be used when no soil survey is available)*
9. 120-2 -1 To be furnished by the contractor from areas provided by him. Measurement shall be based on the measurement of the borrow pit. At the contractor's option, measurement may be based on loose truck volume, in which case payment will be made on ____% of the truck measured quantity.
10. 120-2-1 To be furnished by the contractor from areas provided by him.
11. 120-2-2 To be furnished by the contractor from areas provided by him.

12. 120-6 Any borrow excavation required shall be furnished by the contractor from areas provided by him and the cost of furnishing such material is to be included in the price for embankment.
13. 300-1-1 (Note: To be used for milling projects.)
Included for prime in areas where milling exposes existing base. Estimated quantity to be increased, decreased or omitted as directed by the Project Engineer.
14. 325-75 Includes removal of existing reflective pavement markers prior to starting milling operations.
15. 327-70 Includes removal of existing raised reflective pavement markers prior to starting milling operations.
16. 400-1-15 Includes _____ C.Y. for miscellaneous construction as directed by the Project Engineer.
17. 536-73 Existing guardrail has no salvage value for the DOT and will become the property of the contractor.
18. 536-73 Existing guardrail to be dismantled and stockpiled within the right-of-way in areas designated by the Project Engineer for removal by DOT maintenance forces.

19. 538-1 This is to include furnishing and installing ____ panels, ____ regular posts and ____ special posts which have been determined to be non-salvageable. Additional posts and panels determined to be non-salvageable during resetting shall be paid for under Section 538-5 of the standard specifications.
20. 538-1 Posts and panels determined to be non-salvageable during resetting shall be paid for per Section 538-5 of the Standard Specification.
21. 570-5 Based on ____ applications.
22. 5331-2 Included (or includes ____ tons) for adjustment of connections to existing drives, streets, etc. as directed by the Engineer.

FLORIDA DEPARTMENT OF TRANSPORTATION

BOX CULVERT AND WINGWALL DESIGN

PROJECT NUMBER 00000-0000

LOCATION DESCRIPTION : STA 000+00 00 ENVIRONMENT : SLIGHTLY AGGRESSIVE, USE CLASS II CONCRETE

STEEL QUANTITIES AND BAR SCHEDULE

BARREL QUANTITIES

LOCATION	BAR	NUMBER	SETS	SIZE	SPACING	TYPE	LENGTH	WEIGHT	B LENGTH	C LENGTH	D LENGTH
TOP SLAB	A100	166	5	5	0 500	1	11- 2	1933			
BOT SLAB	A200	133	6	6	0 625	1	11- 2	2231			
CORNER (TOP)	A1	308	4	4	0 542	10	4- 5	909	2- 1	2- 4	
CORNER (BOTTOM)	A2	308	4	4	0 542	10	4- 5	909	2- 1	2- 4	
EXTERIOR WALL (INSIDE)	B1	308	4	4	0 542	1	7-10	1612			
EXTERIOR WALL (OUTSIDE)	B2	308	4	4	0 542	1	5- 8	1166			
LONGITUDINAL	C1	120	(3)	4	1 500	1	28- 8	2298			
HEADWALL BOTH SIDES	G1	4	(1)	4	SEE INDEX	1	11- 2	30	0-11	1- 6	1- 2
HEADWALL BOTH SIDES	P	24	(1)	4	1 000	11	3- 7	57			
								132	LBS /FOOT		
								11145	LBS		

WINGWALL QUANTITIES

LOCATION	BAR	NUMBER	SETS	SIZE	SPACING	TYPE	LENGTH	WEIGHT	B LENGTH	C LENGTH
STEM	F	48	5	5	1 208	10	10- 5	520	1- 9	8- 8
STEM	J	48	4	4	1 208	1	8- 8	276		
STEM	K	48	4	4	1 500	1	14- 8	472		
FOOTING	KF	16	4	4	SEE INDEX	1	14- 8	156		
FOOTING	L	52	4	4	1 208	1	6-10	188		
FOOTING LEFT SIDE	M1	2	(1)	4	SEE INDEX	1	41- 2	55		
FOOTING RIGHT SIDE	M2	2	(1)	4	SEE INDEX	1	41- 2	55		
STEM TO BARREL DOWELS	M **	36	6	6	1 000	10	6- 0	324	3- 0	3- 0
FOOTING SPILLWAY	R	24	4	4	1 000	1	2- 7	41		
								29	LBS /FOOT	
								2067	LBS	

* LENGTH IS THE SUM OF BAR LENGTH AT BEGINNING/TOP AND ENDING/BOTTOM OF WINGWALL, NUMBER OF BAR IS THE AMOUNT REQUIRED FOR THIS SUMMATION OF LENGTH B AND C LENGTH IS FOR THE FIRST BAR OF WINGWALL CLOSE TO THE JOINT OF WINGWALL AND BARREL ** FOR SKEWED WINGS BLEND BARS N TO ACCOMMODATE SKEW, PROVIDE FOR 3 FT OF BAR IN THE WINGWALL AND HEADWALL

PER FOOT WINGWALL STEEL QUANTITY	TOTAL WINGWALL STEEL QUANTITY	TOTAL STEEL QUANTITIES
29	2067	11145
LBS	LBS	LBS
		2067
		LBS
		13212
		LBS

THIS EXHIBIT IS FOR EXAMPLE ONLY AND DOES NOT REFLECT THE DEPARTMENT'S DESIGN CRITERIA

STATE PROJ. NO. 00000 0000 000
SHEET NO. 00

FLORIDA DEPARTMENT OF TRANSPORTATION
BOX CULVERT AND WINGWALL DESIGN
LOCATION DESCRIPTION: BOX CULVERT AND WINGWALL DESIGN
ENVIRONMENT: SUBURBAN - AGGRESSIVE USE CLASS II CONCRETE

PROJECT NUMBER: 00000 0000
VERSION: 2.1

CONCRETE QUANTITIES FOR REINFORCING BARS

BARREL EXTERIOR COVER: TOP SLAB 0.17 FT, BOTTOM SLAB 0.7 FT, WALL 0.17 FT
BARREL INTERIOR COVER: ALL LOCATIONS 0 FT

NO. OF BARS: 2
SPACING: 18.00 FT
THICKNESS: TOP SLAB 0.75 FT, BOTTOM SLAB 0.75 FT, INTERIOR WALL 0.75 FT

WINGWALL NO. OF WINGS: 2
WINGWALL THICKNESS: 0.75 FT
WINGWALL HEIGHT: 0.75 FT
WINGWALL LENGTH: 0.75 FT

CONCRETE QUANTITIES

BARREL: 20.353 C Y
WINGWALL: 11.820 C Y
TOTAL: 32.173 C Y

STEEL QUANTITIES

BARREL: 2998 LBS
WINGWALL: 813 LBS
TOTAL: 3811 LBS

STEEL QUANTITIES NO. BARS BY SIZE

BAR	NUMBER	SETS	SIZE	ACTING	TYPE	LENGTH	B. LENGTH	C. LENGTH	D. LENGTH	WEIGHT
A 00	2	4	0	833		13.1				223
A 00	25	4	0	192		13.1				272
B 00	12	4	0	192		13.1				156
B 00	12	4	0	192		13.1				156
C 00	12	4	0	192		13.1				156
D 00	12	4	0	192		13.1				156
E 00	12	4	0	192		13.1				156
F 00	12	4	0	192		13.1				156
G 00	12	4	0	192		13.1				156
H 00	12	4	0	192		13.1				156
I 00	12	4	0	192		13.1				156
J 00	12	4	0	192		13.1				156
K 00	12	4	0	192		13.1				156
L 00	12	4	0	192		13.1				156
M 00	12	4	0	192		13.1				156
N 00	12	4	0	192		13.1				156
O 00	12	4	0	192		13.1				156
P 00	12	4	0	192		13.1				156
Q 00	12	4	0	192		13.1				156
R 00	12	4	0	192		13.1				156
S 00	12	4	0	192		13.1				156
T 00	12	4	0	192		13.1				156
U 00	12	4	0	192		13.1				156
V 00	12	4	0	192		13.1				156
W 00	12	4	0	192		13.1				156
X 00	12	4	0	192		13.1				156
Y 00	12	4	0	192		13.1				156
Z 00	12	4	0	192		13.1				156
AA 00	12	4	0	192		13.1				156
AB 00	12	4	0	192		13.1				156
AC 00	12	4	0	192		13.1				156
AD 00	12	4	0	192		13.1				156
AE 00	12	4	0	192		13.1				156
AF 00	12	4	0	192		13.1				156
AG 00	12	4	0	192		13.1				156
AH 00	12	4	0	192		13.1				156
AI 00	12	4	0	192		13.1				156
AJ 00	12	4	0	192		13.1				156
AK 00	12	4	0	192		13.1				156
AL 00	12	4	0	192		13.1				156
AM 00	12	4	0	192		13.1				156
AN 00	12	4	0	192		13.1				156
AO 00	12	4	0	192		13.1				156
AP 00	12	4	0	192		13.1				156
AQ 00	12	4	0	192		13.1				156
AR 00	12	4	0	192		13.1				156
AS 00	12	4	0	192		13.1				156
AT 00	12	4	0	192		13.1				156
AU 00	12	4	0	192		13.1				156
AV 00	12	4	0	192		13.1				156
AW 00	12	4	0	192		13.1				156
AX 00	12	4	0	192		13.1				156
AY 00	12	4	0	192		13.1				156
AZ 00	12	4	0	192		13.1				156
BA 00	12	4	0	192		13.1				156
BB 00	12	4	0	192		13.1				156
BC 00	12	4	0	192		13.1				156
BD 00	12	4	0	192		13.1				156
BE 00	12	4	0	192		13.1				156
BF 00	12	4	0	192		13.1				156
BG 00	12	4	0	192		13.1				156
BH 00	12	4	0	192		13.1				156
BI 00	12	4	0	192		13.1				156
BJ 00	12	4	0	192		13.1				156
BK 00	12	4	0	192		13.1				156
BL 00	12	4	0	192		13.1				156
BM 00	12	4	0	192		13.1				156
BN 00	12	4	0	192		13.1				156
BO 00	12	4	0	192		13.1				156
BP 00	12	4	0	192		13.1				156
BQ 00	12	4	0	192		13.1				156
BR 00	12	4	0	192		13.1				156
BS 00	12	4	0	192		13.1				156
BT 00	12	4	0	192		13.1				156
BV 00	12	4	0	192		13.1				156
BW 00	12	4	0	192		13.1				156
BX 00	12	4	0	192		13.1				156
BY 00	12	4	0	192		13.1				156
BZ 00	12	4	0	192		13.1				156
CA 00	12	4	0	192		13.1				156
CB 00	12	4	0	192		13.1				156
CC 00	12	4	0	192		13.1				156
CD 00	12	4	0	192		13.1				156
CE 00	12	4	0	192		13.1				156
CF 00	12	4	0	192		13.1				156
CG 00	12	4	0	192		13.1				156
CH 00	12	4	0	192		13.1				156
CI 00	12	4	0	192		13.1				156
CJ 00	12	4	0	192		13.1				156
CK 00	12	4	0	192		13.1				156
CL 00	12	4	0	192		13.1				156
CM 00	12	4	0	192		13.1				156
CN 00	12	4	0	192		13.1				156
CO 00	12	4	0	192		13.1				156
CP 00	12	4	0	192		13.1				156
CQ 00	12	4	0	192		13.1				156
CR 00	12	4	0	192		13.1				156
CS 00	12	4	0	192		13.1				156
CT 00	12	4	0	192		13.1				156
CV 00	12	4	0	192		13.1				156
CW 00	12	4	0	192		13.1				156
CX 00	12	4	0	192		13.1				156
CY 00	12	4	0	192		13.1				156
CZ 00	12	4	0	192		13.1				156
DA 00	12	4	0	192		13.1				156
DB 00	12	4	0	192		13.1				156
DC 00	12	4	0	192		13.1				156
DD 00	12	4	0	192		13.1				156
DE 00	12	4	0	192		13.1				156
DF 00	12	4	0	192		13.1				156
DG 00	12	4	0	192		13.1				156
DH 00	12	4	0	192		13.1				156
DI 00	12	4	0	192		13.1				156
DJ 00	12	4	0	192		13.1				156
DK 00	12	4	0	192		13.1				156
DL 00	12	4	0	192		13.1				156
DM 00	12	4	0	192		13.1				156
DN 00	12	4	0	192		13.1				156
DO 00	12	4	0	192		13.1				156
DP 00	12	4	0	192		13.1				156
DQ 00	12	4	0	192		13.1				156
DR 00	12	4	0	192		13.1				156
DS 00	12	4	0	192		13.1				156
DT 00	12	4	0	192		13.1				156
DV 00	12	4	0	192		13.1				156
DW 00	12	4	0	192		13.1				156
DX 00	12	4	0	192		13.1				156
DY 00	12	4	0	192		13.1				156
DZ 00	12	4	0	192		13.1				156
EA 00	12	4	0	192		13.1				156
EB 00	12	4	0	192		13.1				156
EC 00	12	4	0	192		13.1				156
ED 00	12	4	0	192		13.1				156
EE 00	12	4	0	192		13.1				156
EF 00	12	4	0	192		13.1				1

THIS EXHIBIT IS FOR EXAMPLE ONLY AND DOES NOT REFLECT THE DEPARTMENT'S DESIGN CRITERIA

SUMMARY OF SIDE DRAIN PIPE AND MITERED END SECTIONS

LOCATION	STA TO STA	SIDE	PIPES		SECTIONS	
			L	R	L	R
S.R. 00	130.00	L	24	83	2	2
	131.25	L	24	83	2	2
	132.50	L	24	83	2	2
	133.75	L	24	83	2	2
	135.00	L	24	83	2	2
	136.25	L	24	83	2	2
	137.50	L	24	83	2	2
	138.75	L	24	83	2	2
	140.00	L	24	83	2	2
	141.25	L	24	83	2	2
	142.50	L	24	83	2	2
	143.75	L	24	83	2	2
	145.00	L	24	83	2	2
	146.25	L	24	83	2	2
	147.50	L	24	83	2	2
	148.75	L	24	83	2	2
	150.00	L	24	83	2	2
	151.25	L	24	83	2	2
	152.50	L	24	83	2	2
	153.75	L	24	83	2	2
	155.00	L	24	83	2	2
	156.25	L	24	83	2	2
	157.50	L	24	83	2	2
	158.75	L	24	83	2	2
	160.00	L	24	83	2	2
	161.25	L	24	83	2	2
	162.50	L	24	83	2	2
	163.75	L	24	83	2	2
	165.00	L	24	83	2	2
	166.25	L	24	83	2	2
	167.50	L	24	83	2	2
	168.75	L	24	83	2	2
	170.00	L	24	83	2	2
	171.25	L	24	83	2	2
	172.50	L	24	83	2	2
	173.75	L	24	83	2	2
	175.00	L	24	83	2	2
	176.25	L	24	83	2	2
	177.50	L	24	83	2	2
	178.75	L	24	83	2	2
	180.00	L	24	83	2	2
	181.25	L	24	83	2	2
	182.50	L	24	83	2	2
	183.75	L	24	83	2	2
	185.00	L	24	83	2	2
	186.25	L	24	83	2	2
	187.50	L	24	83	2	2
	188.75	L	24	83	2	2
	190.00	L	24	83	2	2
	191.25	L	24	83	2	2
	192.50	L	24	83	2	2
	193.75	L	24	83	2	2
	195.00	L	24	83	2	2
	196.25	L	24	83	2	2
	197.50	L	24	83	2	2
	198.75	L	24	83	2	2
	200.00	L	24	83	2	2
	201.25	L	24	83	2	2
	202.50	L	24	83	2	2
	203.75	L	24	83	2	2
	205.00	L	24	83	2	2
	206.25	L	24	83	2	2
	207.50	L	24	83	2	2
	208.75	L	24	83	2	2
	210.00	L	24	83	2	2
	211.25	L	24	83	2	2
	212.50	L	24	83	2	2
	213.75	L	24	83	2	2
	215.00	L	24	83	2	2
	216.25	L	24	83	2	2
	217.50	L	24	83	2	2
	218.75	L	24	83	2	2
	220.00	L	24	83	2	2
	221.25	L	24	83	2	2
	222.50	L	24	83	2	2
	223.75	L	24	83	2	2
	225.00	L	24	83	2	2
	226.25	L	24	83	2	2
	227.50	L	24	83	2	2
	228.75	L	24	83	2	2
	230.00	L	24	83	2	2
	231.25	L	24	83	2	2
	232.50	L	24	83	2	2
	233.75	L	24	83	2	2
	235.00	L	24	83	2	2
	236.25	L	24	83	2	2
	237.50	L	24	83	2	2
	238.75	L	24	83	2	2
	240.00	L	24	83	2	2
	241.25	L	24	83	2	2
	242.50	L	24	83	2	2
	243.75	L	24	83	2	2
	245.00	L	24	83	2	2
	246.25	L	24	83	2	2
	247.50	L	24	83	2	2
	248.75	L	24	83	2	2
	250.00	L	24	83	2	2
	251.25	L	24	83	2	2
	252.50	L	24	83	2	2
	253.75	L	24	83	2	2
	255.00	L	24	83	2	2
	256.25	L	24	83	2	2
	257.50	L	24	83	2	2
	258.75	L	24	83	2	2
	260.00	L	24	83	2	2
	261.25	L	24	83	2	2
	262.50	L	24	83	2	2
	263.75	L	24	83	2	2
	265.00	L	24	83	2	2
	266.25	L	24	83	2	2
	267.50	L	24	83	2	2
	268.75	L	24	83	2	2
	270.00	L	24	83	2	2
	271.25	L	24	83	2	2
	272.50	L	24	83	2	2
	273.75	L	24	83	2	2
	275.00	L	24	83	2	2
	276.25	L	24	83	2	2
	277.50	L	24	83	2	2
	278.75	L	24	83	2	2
	280.00	L	24	83	2	2
	281.25	L	24	83	2	2
	282.50	L	24	83	2	2
	283.75	L	24	83	2	2
	285.00	L	24	83	2	2
	286.25	L	24	83	2	2
	287.50	L	24	83	2	2
	288.75	L	24	83	2	2
	290.00	L	24	83	2	2
	291.25	L	24	83	2	2
	292.50	L	24	83	2	2
	293.75	L	24	83	2	2
	295.00	L	24	83	2	2
	296.25	L	24	83	2	2
	297.50	L	24	83	2	2
	298.75	L	24	83	2	2
	300.00	L	24	83	2	2
	301.25	L	24	83	2	2
	302.50	L	24	83	2	2
	303.75	L	24	83	2	2
	305.00	L	24	83	2	2
	306.25	L	24	83	2	2
	307.50	L	24	83	2	2
	308.75	L	24	83	2	2
	310.00	L	24	83	2	2
	311.25	L	24	83	2	2
	312.50	L	24	83	2	2
	313.75	L	24	83	2	2
	315.00	L	24	83	2	2
	316.25	L	24	83	2	2
	317.50	L	24	83	2	2
	318.75	L	24	83	2	2
	320.00	L	24	83	2	2
	321.25	L	24	83	2	2
	322.50	L	24	83	2	2
	323.75	L	24	83	2	2
	325.00	L	24	83	2	2
	326.25	L	24	83	2	2
	327.50	L	24	83	2	2
	328.75	L	24	83	2	2
	330.00	L	24	83	2	2
	331.25	L	24	83	2	2
	332.50	L	24	83	2	2
	333.75	L	24	83	2	2
	335.00	L	24	83	2	2
	336.25	L	24	83	2	2
	337.50	L	24	83	2	2
	338.75	L	24	83	2	2
	340.00	L	24	83	2	2
	341.25	L	24	83	2	2
	342.50	L	24	83	2	2
	343.75	L	24	83	2	2
	345.00	L	24	83	2	2
	346.25	L	24	83	2	2
	347.50	L	24	83	2	2
	348.75	L	24	83	2	2
	350.00	L	24	83	2	2
	351.25	L	24	83	2	2
	352.50	L	24	83	2	2
	353.75	L	24	83	2	2
	355.00	L	24	83	2	2
	356.25	L	24	83	2	2
	357.50	L	24	83	2	2
	358.75	L	24	83	2	2
	360.00	L	24	83	2	2
	361.25	L	24	83	2	2
	362.50	L	24	83	2	2
	363.75	L	24	83	2	2
	365.00	L	24	83	2	2
	366.25	L	24	83	2	2
	367.50	L	24	83	2	2
	368.75	L	24	83	2	2
	370.00	L	24	83	2	2
	371.25	L	24	83	2	2
	372.50	L	24	83	2	2
	373.75	L	24	83	2	2
	375.00	L	24	83	2	2
	376.25	L	24	83	2	2
	377.50	L	24	83	2	2
	378.75	L	24	83	2	2
	380.00	L	24	83	2	2
	381.25	L	24	83	2	2
	382.50	L	24			

CHAPTER 8

SUMMARY OF DRAINAGE STRUCTURES

8.1 General

The summary of drainage structures sheet shows the location, size, length, number, type of drainage structures and index numbers of standard details used in a project. The sheet format is available in the CADD cell library. Specific levels and fonts which shall be used are also explained in the DOT CADD Manual. Provision shall be made to show both the plan and final quantities.

For a complete illustration of summary of drainage structures see Exhibit II-8-A thru C

8.2 Sheet Setup and Data

A summary of drainage structures shall be prepared and included in the plans. The structures shall be listed by structure numbers in numerical order. Location of each structure shall be identified by station along construction centerline (Exhibit II-8-A)

For cross drains, the summary of drainage structures shall be tabulated by structure number, providing the station, size, length and incidental quantities appropriate for the material detailed in the plans. Optional culvert material will usually be provided and a supplemental tabulation form shall be prepared and included. Information for the optional pipe materials, which will be shown by structure number on the form, includes design service life (DSL), size, length, flow line elevations, thickness or class, corrugation requirements if necessary, and protective coatings if any. The optional material which was plotted and used to establish the pay quantities shall be identified. A table giving maximum and minimum backfill soil values shall be provided (Exhibits II-8-B and II-8-C). The general notes shown on Exhibit II-8-B are required when optional culvert materials are provided.

For storm sewer, the summary of drainage structures shall be tabulated by structure number, providing station, location, size, length, type, and incidental quantities. Usually, only one culvert material will be designed for a storm sewer. If optional materials are designed, a sheet supplemental to the summary of drainage structures sheet shall be provided.

Various drainage elements shall be shown in columns This information shall be obtained from drainage structure sheets or plan - profile Sheets The order in which the elements are listed should be as follows

Pipe Sizes for
Cross Drains
Storm Sewer
Gutter Drain
Curb Inlets
Manholes
Ditch Bottom Inlets
Gutter Inlets
Flared End Sections
Mitered End Sections
Sod
Class of Concrete
Reinforcing Steel
Rip Rap

The "Type" column shall be used to specify the type of structure, the outgoing pipe and the end treatment of that pipe if applicable.

The remarks column shall contain all special notes pertaining to the structure

The "F" line is for construction to document the final quantity and should be left blank by the designer

On smaller projects the summary of quantities and the summary of drainage structures may be combined on one sheet

It is recommended that structure numbers be established using the convention shown in the exhibits and described below

- 1 For simple cross-drains, one structure number is appropriate for the inlet and outlet treatments and the pipe

Example #1 (cross drain
w/o median inlet)

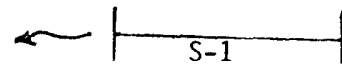

- 2 For complex cross drains, it is suggested that the first and all intermediate structure numbers identify the hydraulically upper end treatment and pipe. The last structure number should identify the hydraulically upper end treatment, pipe and hydraulically lower end treatment.

Example #3 (double pipe CD & median inlet)

S-19 endwall & pipe
S-19A pipe only (barrel # 2)
S-19B inlet, pipe & endwall

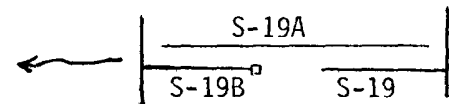

CHAPTER 9

PROJECT LAYOUT

9.1 General

The project layout sheet (or sheets) shows the horizontal alignment and plan - profile sheet sequence and numbering for the project. This is an optional sheet, to be included in the plans set at the discretion of the District Office. The project layout sheet can prove to be of great advantage for large or complicated projects involving large interchanges with a number of diverging routes. If included in the plans set, this sheet should also show all survey reference points and list all general notes applicable to the project.

The layout sheet shall be prepared on a standard plan format. Scale shall be such that clarity and legibility are preserved even if the plans are reduced to half size. North arrow and graphic scale shall be shown at a point of maximum visibility on the sheet. For large, complicated projects, more than one sheet may be required to clearly depict all required information. Appropriate match lines shall be shown if more than one sheet is required.

9.2 Alignment Sheet Sequence

Complete project alignment with centerline of construction shall be shown. Edge of pavements shall be shown if scale permits. Outlines of the plan, or plan - profile sheets shall be superimposed on the alignment to depict the sheet sequence with relation to the alignment stationing. Match lines and match line stations shall be shown on the plans, or plan - profile sheet outline with sheet numbers shown in the upper, right-hand corner. The order of plan/plan - profile sheet numbering shall be as follows:

Mainline (for widely separated roadways, the right roadway in the direction of stationing takes precedence, see Exhibit II-9-A).

Crossroads

Ramps

Frontage roads

Access roads

Beginning and ending stations for project, construction and ramps shall be flagged and labeled.

9.3 Survey Reference Points

Survey reference points should be shown on the project layout sheet just beneath the alignment sheet sequence plan. Baseline survey and reference points with all ties shall be clearly indicated. Complete length of survey baseline between two consecutive reference points need not be shown. Each reference point shall be clearly labeled and numbered, with the numbering beginning at the first reference point within the limits of the project and progressing in the direction of stationing. Usually, reference points need not be drawn to any particular scale, but distances and angles shown shall be proportionate. Care should be taken to ensure that clarity and legibility are maintained on half size plans.

9.4 General Notes

When the layout sheet is included in the plans set, applicable general notes shall be included on the layout sheet instead of the plan - profile sheet to help simplify the plan - profile sheets.

For a list of general notes, refer to Section 10.4 of Roadway Plan and Profile Chapter 10 of this Volume.

THIS EXHIBIT IS FOR EXAMPLE ONLY AND DOES NOT REFLECT THE DEPARTMENT'S DESIGN CRITERIA.

STATE PROJ NO 00000 00000000

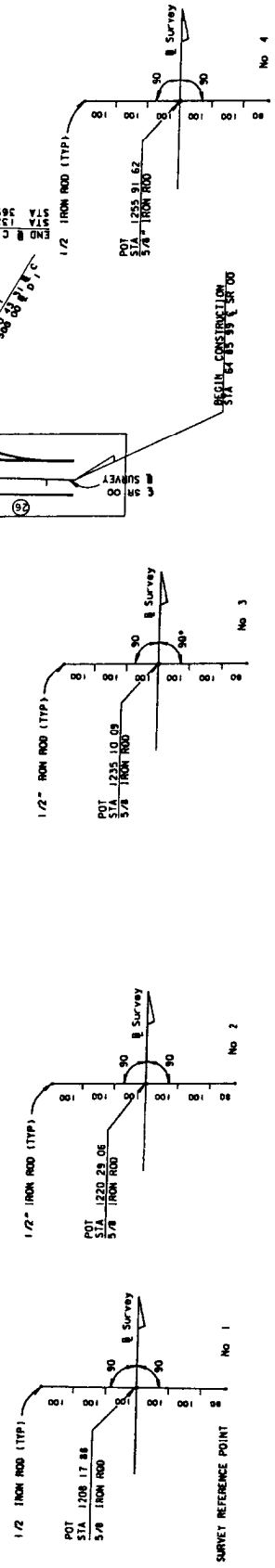
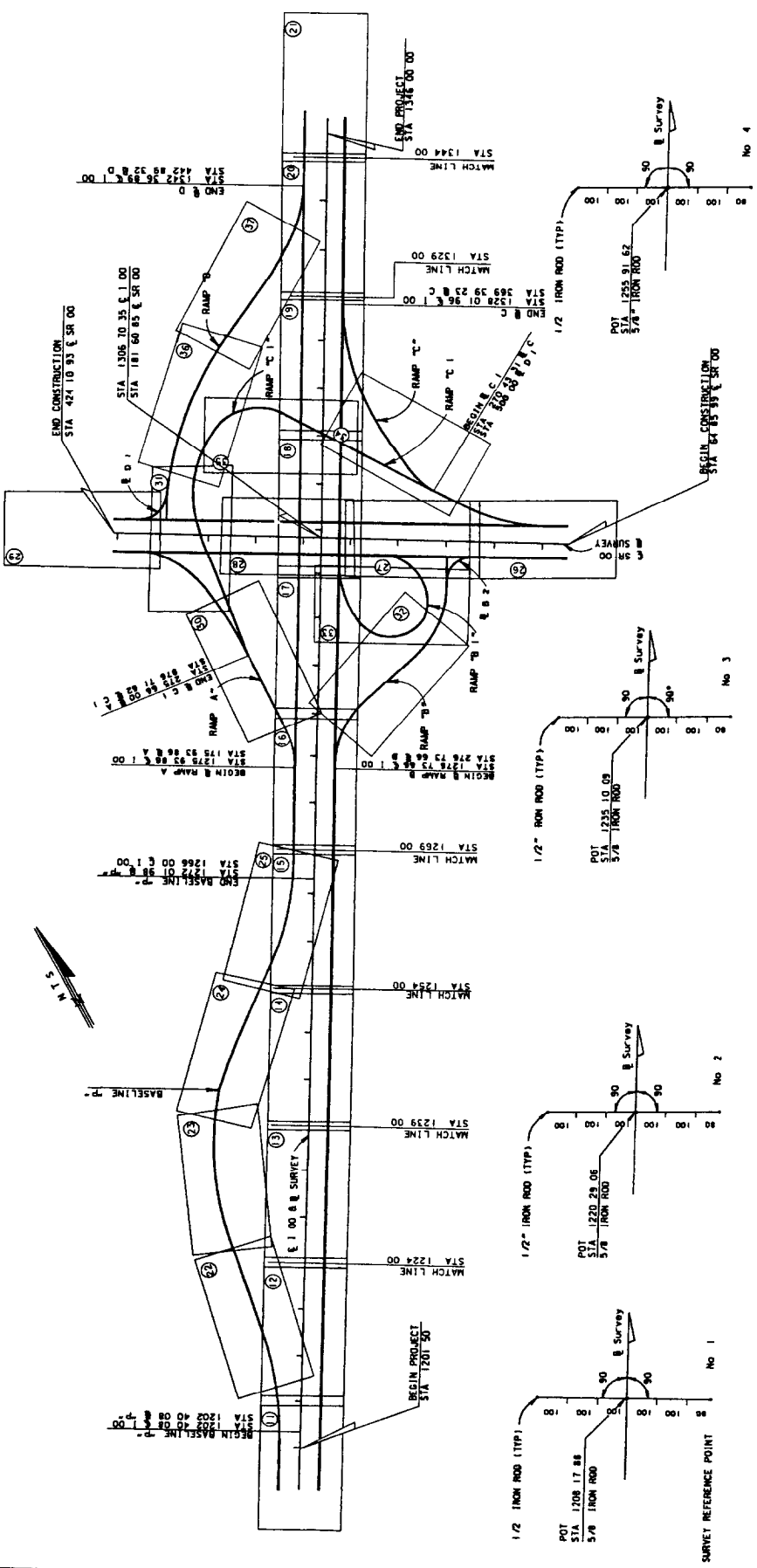

GENERAL NOTES:
(FOR A LIST OF GENERAL NOTES SEE SECTION 10 4)

SURVEY REFERENCE POINT SYMBOL

DATE	BY	DESCRIPTION	DATE	BY	DESCRIPTION	DATE	BY	DESCRIPTION	DATE	BY	DESCRIPTION

PROJECT LAYOUT

PLANNING

CHAPTER 10
ROADWAY PLAN AND PROFILE

10.1 General

The plan - profile sheet shows the project's complete horizontal and vertical alignments. Various roadway elements such as pavement width, medians, paved shoulders, curbs, drainage elements, tapers, turn provisions, and intersecting roadways, are also shown on this sheet.

Roadway plan - profiles shall be prepared on standard plan-profile format. Scales used should be such that the sheet is legible when reduced to half size. Standard scales for rural construction are 1" = 100' in the plan and 1" = 100' horizontally and 1" = 10' vertically in the profile. Scales for urban construction are usually 1" = 20' in the plan and 1" = 20' horizontally and 1" = 2' vertically in the profile. To provide additional clarity, scales other than these standards may be used, such as, 1" = 50' horizontally and 1" = 5' vertically. The scale shall be shown graphically along the north arrow. The north arrow shall be placed on the plan portion at a point of maximum visibility. The usual position is near the top right corner of the plan portion.

CADD Roadway Standards and Guidelines explains in detail the production of the plan - profile sheet.

If a project layout sheet is not included in the plans set, then provision shall be made on the first plan - profile sheet to show applicable general notes. Refer to Section 10.4 for a list of general notes.

10.2 Roadway Plan Portion

10.2.1 Centerline

The centerline of construction should be centered in the plan portion of the sheet, with stationing running from left to right. When horizontal curves are involved, the centerline shall be positioned on the sheet such as to avoid breaks or match lines.

A "tick" mark shall be placed on the upper side of the centerline at every station. "Tick" marks at every 5" (true scale) shall be 0.2" long and the station number should be shown above the "tick" mark, usually outside of the R/W lines. The remaining "tick" marks at every 1" (true scale) shall be 0.1" long with no station numbers shown. Station numbers may be shown inside the R/W.

Thirty stations per sheet should be shown when the horizontal scale is 1" = 100' and if a scale of 1" = 20' is used, six stations per sheet should be shown. Each sheet shall begin and end with a whole station and shall begin on an even 10 station for a scale of 1"=100'. The first and last plan-profile sheets may be exceptions.

In cases where the construction centerline does not coincide with the survey baseline, the construction centerline shall be identified with complete alignment data and ties to the survey baseline. However, the construction centerline may not be shown when it is uniformly offset from the survey baseline for the entire length of the project, and is shown on the typical sections. All station equations shall be included. These include equations occurring on the survey baseline and those equating survey baseline and construction centerline.

10.2.2 Horizontal Curves

P.C., ^{and} P.T. points of horizontal curves shall be indicated by small circles. Short radial lines shall be drawn from these points and identified. P.I.'s shall be noted by the use of a small triangle with a short section of tangent on either side. In cases where the curve extends over more than one sheet, the curve data shall be repeated on each sheet showing the curve.

Complete curve data shall be shown for each horizontal curve using the following format:

CURVE DATA

P.I. Station

Δ (Delta Angle with Direction)

D (Degree of Curvature)

T (Tangent Length)

L (Length of Curve)

R (Radius Length)

P.C. Station

P.T. Station

e (Superelevation Rate)

10.2.3 Existing Topography

All existing topography shall be shown. Existing roads, streets, drives, buildings, underground and overhead utilities, walls, curbs, pavements, fences, railroads, bridges, drainage structures and similar items shall be drafted and labeled. Streams, ponds, lakes, wooded areas, ditches and all other physical features shall also be shown. Existing curbs, sidewalks, pipes, etc. shall be drafted using a light broken line; existing pavement edges shall be shown by a different broken line pattern (longer dashes). All existing utilities shall be shown on the plan and noted by an appropriate symbol (see Index 002 for standard symbols). If the type of utility pipe is unknown it should be labeled as such. Existing gasoline storage tanks within limits of topographical survey shall be located and illustrated by broken lines on the plan.

10.2 4 Reference Data

Bearings, in the direction of stationing, shall be shown for all tangent sections.

Station equivalencies, angles with mainline centerline and/or bearings in the direction of stationing of the crossroad shall be shown for all roads and streets intersecting or crossing the project

All the survey reference points shall be shown (if layout sheet is not included in plans set) at locations removed from the centerline

If Section lines or city limits are encountered within the limits of the project, then the intersection shall be tied by station and angle/bearings to the baseline of survey

10 2 5 Construction and Project Limits

The project's proposed construction limits shall be indicated in the plans. The limits to be flagged and stationed are

1. Begin and end of project, and begin and end of construction where construction limits are other than project limits. If plans cover more than one project, the limits of each shall be clearly identified by station and project number. Limits identification shall be shown both in plan and in profile.

It is the responsibility of the designer to set the project and construction limits. If the plans cover more than one project or are part of a corridor improvement, the project limits should be at the beginning of the full typical sections, with any construction (transitions, etc.) outside these limits being within the construction limits. Examples of types of work that may fall within construction limits but outside project limits are feathering, friction course, guardrail, drainage work and signing and marking work. For other projects the designer may wish to set project limits at the limits of major construction, i.e. begin project at the beginning of a transition.

2. The limits of project breakdown necessary for separation of length and quantities for federal-aid and non-federal-aid projects.
3. The limits of each type of construction classification where more than one type is involved, such as, resurfacing, bridging, widening, and milling.
4. The begin and end of exceptions.

10.2 6 Drainage Structures and Bridges

Proposed cross drain pipes and culverts shall be indicated in the plan by a symbol and identified by a drainage structure number only. Box culverts (single or multiple) of 20' total span or more between inside faces of end supports, measured along the center of the roadway, shall be designated as bridge culverts and shall be identified by both a bridge number and a drainage structure number. The beginning and ending stations (outside wall to outside wall) shall be flagged.

Proposed bridges and approach slabs shall be shown by simple outline. Bridges shall be identified by bridge number and their beginning and ending stations noted by station flags. The beginning and ending stations of approach slabs shall be noted by station pluses (plus station).

A short section of lateral ditch centerline shall be shown, when appropriate, on the roadway plan - profile sheet, together with a note referring to lateral ditch sheets for ditch details.

The proposed drainage system is indicated by drafting storm sewer pipes with a single line, and the outline of inlets, manholes and junction boxes. The pipe size between structures shall be given. Structure numbers shall be provided for inlets, manholes, junction boxes and special structures. When drainage structure sheets are included in the plans, no further information shall be noted. When drainage structures are not included in the plans, a complete description of the pipes and drainage structures shall be shown.

When plans are prepared utilizing optional pipe materials, the most logical option, as specified by the drainage engineer, shall be the pipe size shown, and the "Optional Cross-Drain Tabulation Sheet", shall be prepared. If the tabulation sheet is not prepared, a complete description of all pipe options shall be shown on the plan-profile sheet.

10 2 7 Plan Layout

- 1 Right-of-way lines shall be shown Right-of-way shall be dimensioned only if the applicable typical section shows a varying dimension from the baseline or centerline Dimensions of the R/W line shall be from the centerline or baseline, if survey and construction lines are parallel, otherwise it shall be dimensioned from the construction centerline
2. The showing of detailed information regarding crossovers or intersections should be avoided when they are of a type which can be handled by a standard detail Crossover and intersections shall be identified by station location
- 3 At locations along the alignment where travelway dimensions change, or begin to change, the station and dimensions of the travelway shall be shown For rural projects the edges of pavement may not be shown in the plan if shown in typical section projects
- 4 Curb, curb and gutter, traffic separators, sidewalks, curb cut ramps, retaining walls, etc shall be shown.
5. Stations of return points, shall be shown in tabular form (see Exhibit II-10-A) or shown on the plan, unless shown on the intersection details Offsets shall also be shown, if not governed by a typical.
- 6 Station of radius points of traffic separator or median curb at median openings shall be shown in the plan Elevation of these points shall also be shown if not shown in the intersection details sheet or unobtainable in plans
7. Control radii for traffic turns that set median nose locations shall be indicated, unless shown on the intersection detail sheet

8. Station of end of curb and gutter at side street intersections, (when end is not at a return point) shall be shown with proposed gutter grade elevation of these points. No station needs to be shown for driveways when the curb and gutter on the returns is terminated five feet back of the sidewalk or the right-of-way line, since the point of termination is set by the back of sidewalks or project right-of-way

9. Limits of pavement and grading at side street intersections shall be indicated

10 When incidental construction extends beyond the right-of-way lines, construction easements or restoration agreements may be required and should be shown on the plan sheets

11 All utilities shall be shown in the plan Elevations of utilities greater than 4 inches in diameter shall be flagged in the plan view All major utilities that have been field verified shall be labeled in accordance with the following symbols.

V_v = Verified Vertical Location

V_h = Verified Horizontal Location

$V_{v,h}$ = Verified Vertical Elevation and Horizontal Location

11 All traffic monitoring sites on or within 0.5 mile of the project shall be identified with the following notation

Traffic Monitoring Site Number (XXXX)

Roadway Identifying Number (RCI Section #) Milepost (XX.XXX)

Site includes vehicle detectors in roadway and pedestal mounted metal cabinet, buried cable, and solar power unit on right-of-way.

10.3 Roadway Profile Portion

10 3 1 General Data

The horizontal scale for the profile portion of the sheet shall be the same as that used for the plan portion. Station limits of the profile shall correspond to those of the plan of each sheet. Station numbers shall be placed across the bottom of the sheet just above the title block. The full station number should be shown every five inches, regardless of scale, and the first and last stations on a sheet. Single digit numbers may be shown for other stations. A general guideline for horizontal and vertical scale is the vertical scale should be 10% of the horizontal scale.

Vertical elevation datum selected shall be such that the profile will not crowd either the upper or lower limits of the profile format. Elevation datum shall be shown on both the left and right sides of the sheet.

The existing groundline profile at baseline of survey (regardless of the location of profile grade line) shall be drafted using a light solid line. Existing groundline elevations on the survey line shall be noted vertically, just above the station numbers at each end of the sheet only.

High water elevations shall be shown by use of a light broken line (long dashes) at the high water elevation, with the elevation and the year of the indicated high water identified. If high water is to be lowered, the design high water elevation shall be stated.

Bench mark data shall normally be given just below the upper margin of the profile portion. However, if space permits, it may be placed in the plan portion just above the upper profile margin at the appropriate corresponding station. Refer to Exhibit II-10-A for correct format.

Station equations and exceptions shall be shown. Begin and End stations of project, construction, bridge and bridge culverts shall also be shown.

10.3.2 Vertical Curves

The proposed profile grade shall be shown by a heavy solid line. Vertical curve P.C.'s and P.T.'s shall be indicated by small circles and P.I.'s by a small triangle with short sections of tangent drafted with a light line on each side. Percents of grade to 4 significant decimal places shall be shown on the tangent line (zeros need not be shown). Vertical lines shall be extended from the P.C. and P.T. points and a dimension line placed between these lines indicating the length of the vertical curve. The P.C. and P.T. stations and elevations shall be indicated on the vertical lines.

For vertical curves, the profile grade elevations shall be given on even stations and, where appropriate, at 20' ^{or} ~~and~~ 50' intervals. The elevations shall be placed between the dimension line and the grade line. The curve length, dimension and the profile grade elevations shall be placed above the grade line for sag vertical curves and below the grade line for crest vertical curves. The dimensions and elevations shall be placed reasonably near the grade line whenever possible. The P.I. station and elevation shall be noted, lettered vertically above the P.I. symbol for crest curves and below for sag curves.

The profile grade elevation of the beginning and ending station of each sheet shall be shown vertically just above the grade line, except when the beginning or ending station on the sheet is on a vertical curve.

10.3.3 Grades

Percents of grades to 4 significant decimal places shall be indicated for each tangent section on every sheet (zeros need not be shown). When two tangent grades intersect and no vertical curve is required the P.I. station and elevation shall be labeled vertically, using the same criteria as for vertical curves.

10.3.4 Superelevation

For non-standard superelevated sections of the project, the begin and end superelevation stations should be indicated on the profile with a note "For Superelevation details see sheet ___" (special profiles sheet).

10.3.5 Drainage Features

For rural construction projects, special ditches shall be indicated in the profile with a medium light broken line (long dashes). Percent of ditch grade and a beginning or ending ditch P.I. with symbol (see figure 10.1), and elevation and station plus shall be shown. For multi-lane divided projects, three special ditch grades (right and left roadway ditches and median ditch) sometimes occur at the same location. In such cases it may be advantageous to show the median ditch at a convenient location on the sheet with a separate elevation datum.

FIG. 10.1

DITCH POINT INTERSECTION (D.P.I.)

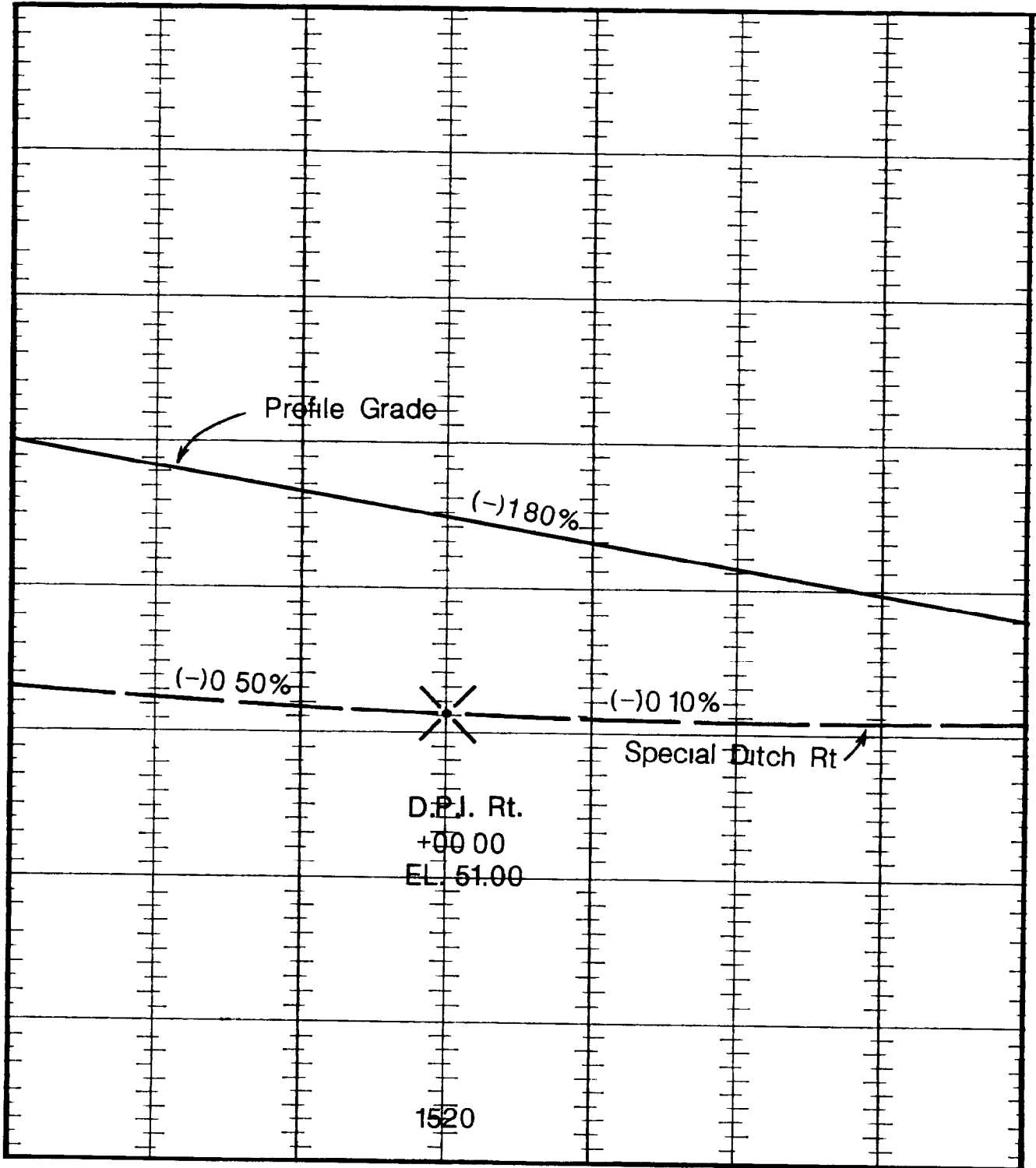

Uniform ditches of non-standard depth should be indicated by a dimension line in the lower portion of the grid and noted as a special ditch with location and depth or they should be indicated by flagging the DPIs at each end with station elevation and side. Standard depth ditches are not shown.

Special gutter grades shall be shown in profile for cases where the gutter grades are not controlled by the typical section and "special profiles" are not included in the plans set.

Prolongations of gutter profile grades across street intersections shall be included on plan - profile sheets if an inlet is not provided before the intersection.

Storm sewer pipe, inlets and manholes along the main line shall be shown. Pipes shall be noted by size. If drainage structure sheets are included in the plans, proposed structures may be shown by structure number only. Proposed drainage structures shall be drafted with a medium heavy line. The grate elevation and flow line elevations shall be shown for all pipes entering and leaving the structure. If drainage structure sheets are not included in the plans, sufficient information to construct the structure should be given.

Proposed cross drain pipes and culverts shall be plotted in section with a heavy solid line. The section shall be shown at the correct location and elevation of the proposed structure crossing the centerline of construction. If drainage structures are drawn, cross drains shall be identified by structure number only. If optional materials are provided, only the structure number is shown and the optional material cross drain tabulation sheet is provided. Bridges and bridge culverts shall be noted as such and their beginning and ending stations shown.

For road/railroad under bridge situations, the cross-section template of the road/railroad under the bridge shall be shown at the appropriate location in profile

All major underground utilities¹ located in the field shall be shown to scale in profile and labeled in accordance with the following symbols

v_v = Verified Vertical Elevation

v_h = Verified Horizontal Location

V_{vh} = Verified Vertical Elevation and Horizontal Location

¹ Note "Major Utilities" are defined as water mains (4" or larger), all gas lines except service lines, telephone ducts (50 pair or larger), sanitary lines (all gravity flow mains), sanitary force mains (4" or larger) and electric power cable (all buried electric transmission cables - not service lines)

10.4 General Notes for Plan - Profile Sheets

General notes for the project shall be placed on the left portion of the first plan-profile sheet if a layout sheet is not included in the plans set, otherwise, they shall be included on the layout sheet

List of General Notes

- 1 Buildings to be removed by others, unless otherwise noted
- 2 Existing drainage structures within construction limits shall be removed (or remain) unless otherwise noted
- 3 If there are no utility adjustment sheets in the plans, the following notes shall be included in the general notes
 - a The location of the utilities shown in the plans are approximate only The exact location shall be determined by the Contractor during construction
 - b For utility adjustment symbols, see Index No 002
 - c Utilities are to be adjusted by others as directed by the Engineer
 - d Utility Owners (Note Should have names and emergency phone numbers)

Companies

Telephone Nos

4 If there are no drainage structure sheets in the plans, the following notes shall be included in the general notes, if applicable. |

a Special attention is directed to the fact that portions of some drainage structures extend into the stabilized portion of the road bed and extreme caution will be necessary in stabilization operations at these location

b To be used when optional materials are provided)

(Some) (All) _____ of the drainage structures have optional culvert materials One of the optional materials has been used as the basis of the pay quantities All optional materials are described, and design information has been provided in the tabulation of optional cross drain (and/or storm sewer) pipe culvert materials

5 Any public land corner within the limits of construction is to be protected If a corner monument is in danger of being destroyed and has not been properly referenced, the project engineer should notify the district location surveyor without delay by telephone

6 If there is a traffic monitoring site on the project or within 0.5 mile |
of the construction, add the Transportation Statistics Office in |
Tallahassee to the list of utility owners |

THIS EXHIBIT IS FOR EXAMPLE ONLY AND DOES NOT REFLECT THE DEPARTMENT'S DESIGN CRITERIA.

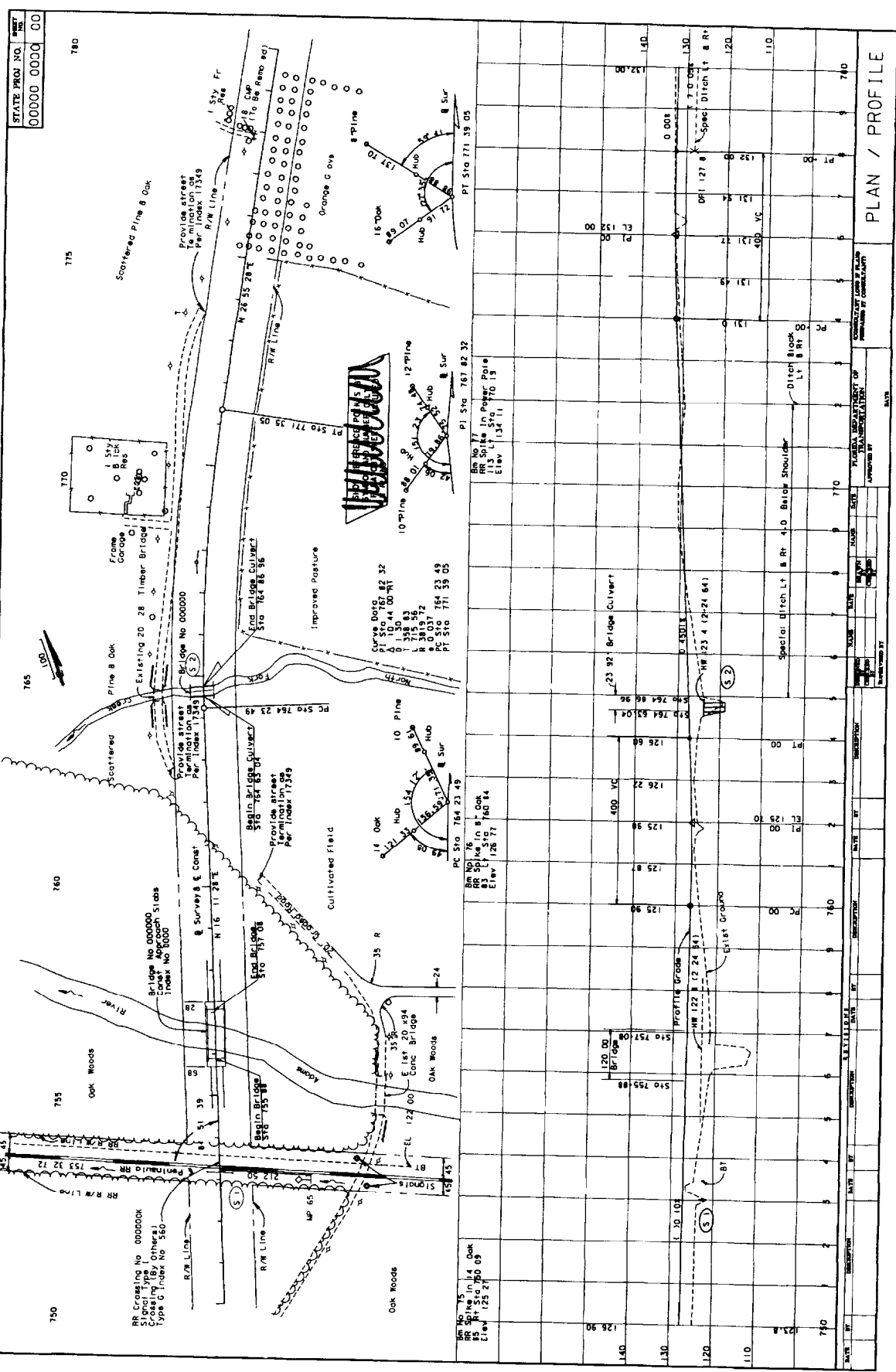

EX 11-10-B

CHAPTER 11

SPECIAL PROFILES

11.1 General

The special profiles sheet shows profile of pavement edges or gutter flowline at street intersections, ramp termini, curb returns, railroad crossings and roadway sections requiring special superelevation details. These areas require special analysis and design to ensure a safe, efficient, water free, and smooth roadway system. The special profiles sheet shall show details at close intervals and at a scale large enough to clearly identify all construction details within these areas.

11.2 Intersections

In addition to normal profile grade lines, supplemental profiles and sections at intersections may be necessary to define edge of pavement profiles. Sections showing pavement surface elevations shall be shown for nose points and other critical locations. It is important to develop accurate profiles and sections at locations of curbed channelization to ensure proper drainage.

When plan - profile format is used for intersection details, the profile's horizontal scale shall be the same as that for the plan portion. A vertical scale of 1" = 1' for the profile portion is recommended as it enables intermediate elevations to be determined from the profile with reasonable accuracy. The existing ground line and/or curb line may be shown by a light broken line.

For intersections detailed on separate plan format, the profile and sections shall be shown on standard cross section format.

For street intersections of municipal projects, a scale of 1" = 10' horizontal, and 1" = 1' vertical is recommended.

11.3 Curb Returns

Curb return profiles show the profiles of the gutter flowline from the PC to the PT point of the return at an intersection.

Curb return profiles shall be shown on standard cross section format. They shall be included in the plans set if the required information cannot clearly be shown on the plan - profile sheet or intersection detail sheet, or if extreme grades are involved rendering the standard curb return profiles (Index 303) inadequate. Standard scale used should be 1"=20' horizontally and 1"=2' vertically. Other scales may be used provided all construction details are clearly and legibly shown, when the plans are reduced to half size. Each return profile shall be identified and its PC ^{and} PT stations ~~indicated~~ ^{shown}. Elevations should be shown at 20' intervals and low and high spots shall be identified by location and elevation.

11.4 Ramps

Ramp profile grades shall be developed along the baseline of each ramp. A profile of the edge of the pavement opposite the baseline shall also be shown. These profiles shall be shown on standard cross section format. Data required to be shown shall be similar to that required for roadway profile. (Chapter 10).

Recommended scales for ramp profiles are 1"-10' horizontally and 1" = 1' vertically, or 1"=50' horizontally and 1"=1' or 2' vertically.

Sections at nose points are required. They may be shown using a scale of 1"=10' horizontally and 1"=1' vertically.

11.5 Spline Grade

Intersections of ramp pavement with mainline pavement and other sections of pavement within special superelevated zones need special attention, not only during the design phase of the project, but also during the construction phase. Hence, all construction details pertaining to these areas should be clearly and accurately shown in the plans. Spline grade shows the interconnection and interrelation of the edges of pavement with the mainline edge of pavement. This profile proves to be valuable especially if the mainline pavement is superelevated or within the superelevation transition zone.

Spline grade shall show the elevations at a minimum of 20' and a maximum of 100' intervals of the outer edge of mainline pavement and inner and outer edges of the ramp pavement at the nose areas. Grades of the three pavement edges shall be shown on a standard cross section format; recommended scales: 1"=10' horizontally, 1"=1' vertically or 1"=20' horizontally and 1"=2' vertically. Grades of each pavement edge shall be joined by smooth spline or simple curve. The three grade profiles shall be clearly labeled and all equality stations indicated. Nose stations shall be flagged and labeled. Scale shall be indicated in close proximity of the profile and shall be clearly visible.

11.6 Superelevation

For projects involving simple curves, no superelevation diagram shall be required as it is covered in the Roadway and Traffic Design Standards. For projects involving reverse curves, or compound curves or any other situation requiring special superelevation not covered in the standards, the superelevation diagram shall be shown in the plans. Complete profile grade line and right and left edges of pavement within the superelevation zone shall be shown on the cross section format. A scale of 1"=10' horizontally and 1"=1' vertically is recommended for clarity. The begin and end superelevation stations shall be labelled and indicated by a solid vertical line of medium weight at the appropriate station. A horizontal dimension line shall be utilized to indicate a section in full superelevation.

THIS EXHIBIT IS FOR EXAMPLE ONLY AND DOES NOT REFLECT THE DEPARTMENT'S DESIGN CRITERIA

STATE PROJ. NO. 00000 0000 00

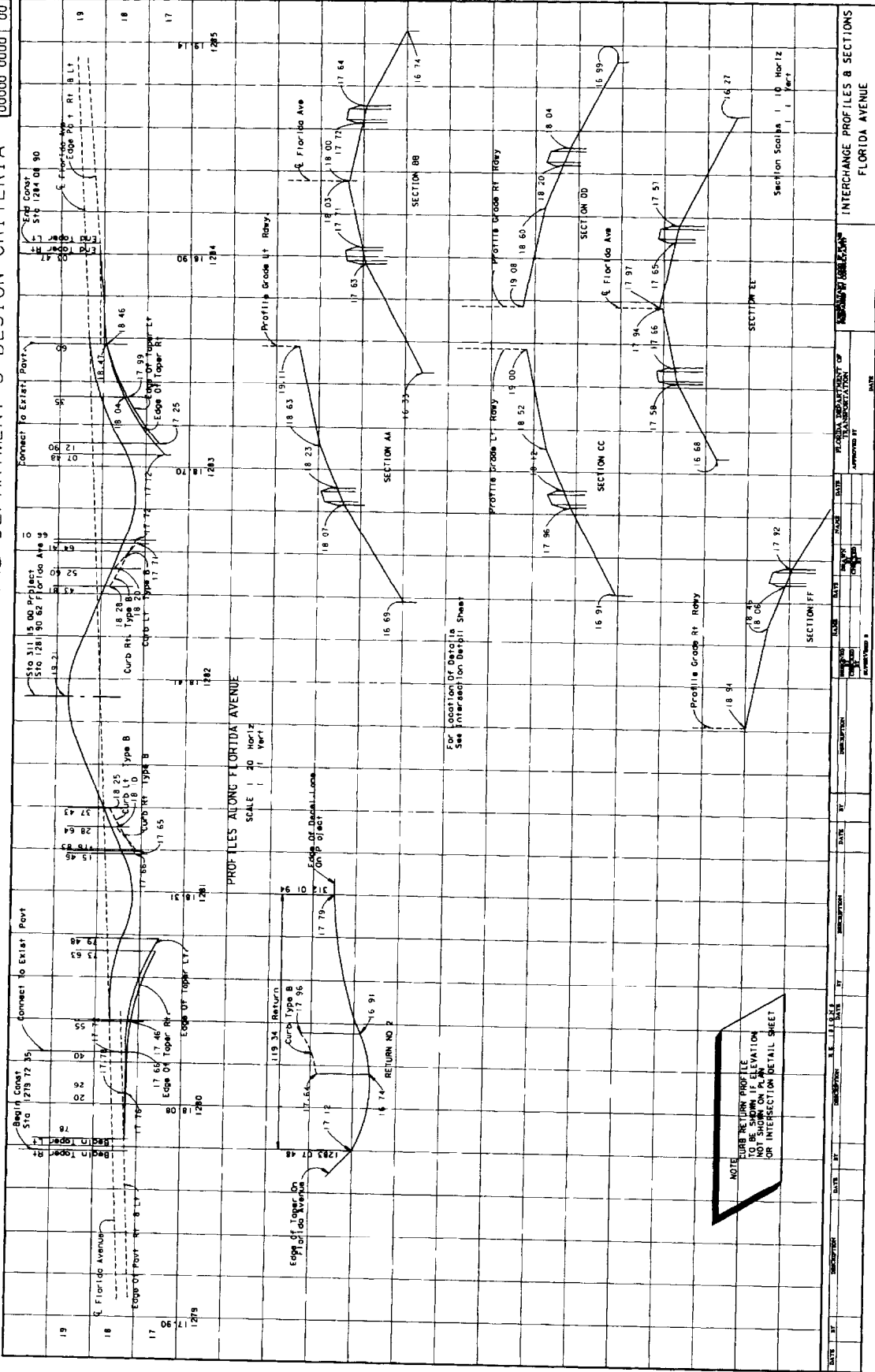

EX 11-11-A

CHAPTER 12

BACK-OF-SIDEWALK PROFILES

12.1 General

Back-of-sidewalk/right of way line profiles are used to establish the profile grade and hence play an important role in plan preparation, especially if the project site is located in a built-up urban area. Profiles help determine the constructability of the project within the right-of-way without excessive disturbance or rework of adjoining properties. Back-of-sidewalk profiles are also used for checking of storm water trapped behind the sidewalks and as a major input for establishing centerline grade profiles. Grades shown on this sheet are at the back of the proposed sidewalk, and grades shown on plan - profile sheets are centerline grade profiles.

The inclusion of the back-of-sidewalk profiles in the plans set is optional - at the discretion of the District Office, but work sheets must be submitted with phase reviews.

12.2 Required Information

Profiles for use in establishing back-of-sidewalk grades consist of profiles along the outside edge of each sidewalk, drafted against the same elevation datum. The profiles shall be drafted with light broken lines, using different line patterns and labels to distinguish between the right and left sidewalk profiles.

The standard scale is 1" = 100' horizontally and 1" = 5' vertically. This combination works well for projects having few locations where back-of-sidewalk grades would be critical. For clarity, it may be advantageous to use a vertical scale of 1" = 2' and a horizontal scale of 1' = 50' or 1" = 20' for projects located in business and commercial areas. Elevation datum shall be shown on both sides of the sheet with station numbers below the profile. If a horizontal scale of 1" = 100' is used, full station numbers shall be shown at each even ten stations and single digit numbers at the remaining stations. For other horizontal scales, full station numbers shall be given at each station.

Percents of grade for the sidewalk profile, P.I. stations and elevations shall be shown. Vertical curves, if any, shall be dimensioned. Elevations along vertical curves are not required.

Begin and End project and sidewalk stations shall be flagged and labeled. Mainline station equations within the limits of the sidewalk profile shall also be flagged and labeled.

Limits of existing pavement, such as parking areas and service station drives, which should be matched as closely as possible, shall be identified on all sidewalk profiles. The centerline for each intersecting street and driveway shall be indicated with a vertical line at the proper station and the street name and station noted. Intersecting streets and driveways on the right shall be shown below the profile, and those on the left above the profile.

At locations of significant drainage, arrows shall be drawn at each station to indicate the slope of ground at the outer edges of the sidewalk.

Drainage arrows shall be placed below the profile line for the right profile and above the profile line for the left profile. Arrows pointing outwards from the profile indicate drainage away from the project.

Floor elevations for buildings shall be indicated by a horizontal line drawn at the floor elevation between the building limits.

~~width~~ (and side) The numeric elevation shall be shown, as well as the *offset* (distance) from centerline of project to face of building. ~~distance~~ ~~width~~ ~~of~~ ~~building~~. Entrances to buildings, elevations of top of existing utilities, and water table elevation may be shown when appropriate. Stations and elevations of intersecting side streets shall also be shown.

The difference in elevation between the profile grade and back-of-sidewalk profile grade shall be noted on the sheet. Superelevation notes, if applicable, shall also be noted on the sheet.

12.3 Sheet Set Up

Back-of-sidewalk profiles shall be prepared on standard cross section format. For simple projects which do not involve many cross streets or driveways, the sheet may be sectioned horizontally to maximize usage. Stationing shall progress from left to right and top to bottom. Match lines shall be at even stations. Care should be taken to preserve clarity and legibility even when the plans are reduced to half scale. For normal projects, the profiles shall be drafted as shown in Exhibit II-12-A.

CHAPTER 13

INTERSECTION AND INTERCHANGE DETAILS/LAYOUTS

13.1 General

These sheets provide layouts and details for intersections and interchanges involving turning and weaving movements of vehicular traffic. For a safe and efficient roadway system, these areas must be designed with special attention to channelization, turning movements, signalization, drainage and vertical alignment. The various design details shall be shown explicitly for accurate construction.

Intersection/interchange layout sheets shall show all necessary details of channelization, tapers, turn lanes, special drainage, grading, and radii. The sheets shall be prepared on a standard plan format using a scale large enough to show details clearly and legibly, at both full and half size.

13.2 Intersections

Intersection details shall be shown on separate plan sheet format if they cannot be shown clearly on the plan - profile sheet format.

In cases of simple, non-signalized intersections covering relatively small areas, regular plan - profile format may be used. The intersection layout shall be placed, using an appropriate scale, in the plan portion and the necessary profile grades in the profile portion.

For larger, more complicated intersections involving channelization, signalization or long connections, the layout shall be placed on a standard plan format using match lines when more than one sheet is required. The profiles shall be presented separately on a standard cross section format. (See Chapter 11 - Special Profiles).

Existing topography need not be shown on these details if it is shown elsewhere in the plans. Information given is generally the same as in the plan portion. Pavement edges, curb and gutter, channelizing and median curbs, drainage structures, pavement dimensions, radii and appropriate notes shall be included.

All intersection layouts shall be dimensioned, stationed adequately, and shall include all pertinent construction notes and alignment data. Design speed data shall be given when appropriate. A north arrow and graphic scale shall be shown at a point of maximum visibility on the plan.

The scale used shall be sufficient to cover all necessary details, preferably 1"=20'. The scale shall not be smaller than 1" = 40'. Widths of turning lanes and turning paths shall be checked for possible encroachments or conflicts.

13.3 Interchanges

13.3.1 Geometric Layout

Interchange layouts shall be prepared on a standard plan format. The entire interchange shall be placed on one sheet when possible, using a scale of 1" = 200'. In cases of large cloverleaf or directional interchanges, more than one sheet may be required. Appropriate match lines shall be shown. Layouts shall be dimensioned and completely stationed, with all alignment data and construction notes included. All curves shall be assigned a number and curve data presented in a tabular form. It is preferred that the tabular curve and coordinate data be placed on the same sheet as the interchange layout.

Interchange ramps shall be identified by the use of letters. The recommended practice for assigning ramp names is as follows:

or a combination of letters and numbers.

Ramps in the first left quadrant along mainline stationing should be assigned first. Name assignments shall progress in an counterclockwise direction around the interchange (See Figure 13.1). For projects with two or more interchanges, continue name assignments with the next letter and in same counter clockwise direction noted above.

Ramp baselines are usually located on the right edge of the pavement with relation to the direction of traffic, and shall be clearly indicated. Stationing of ramps should be in the same direction as the project.

FIG. 13.1

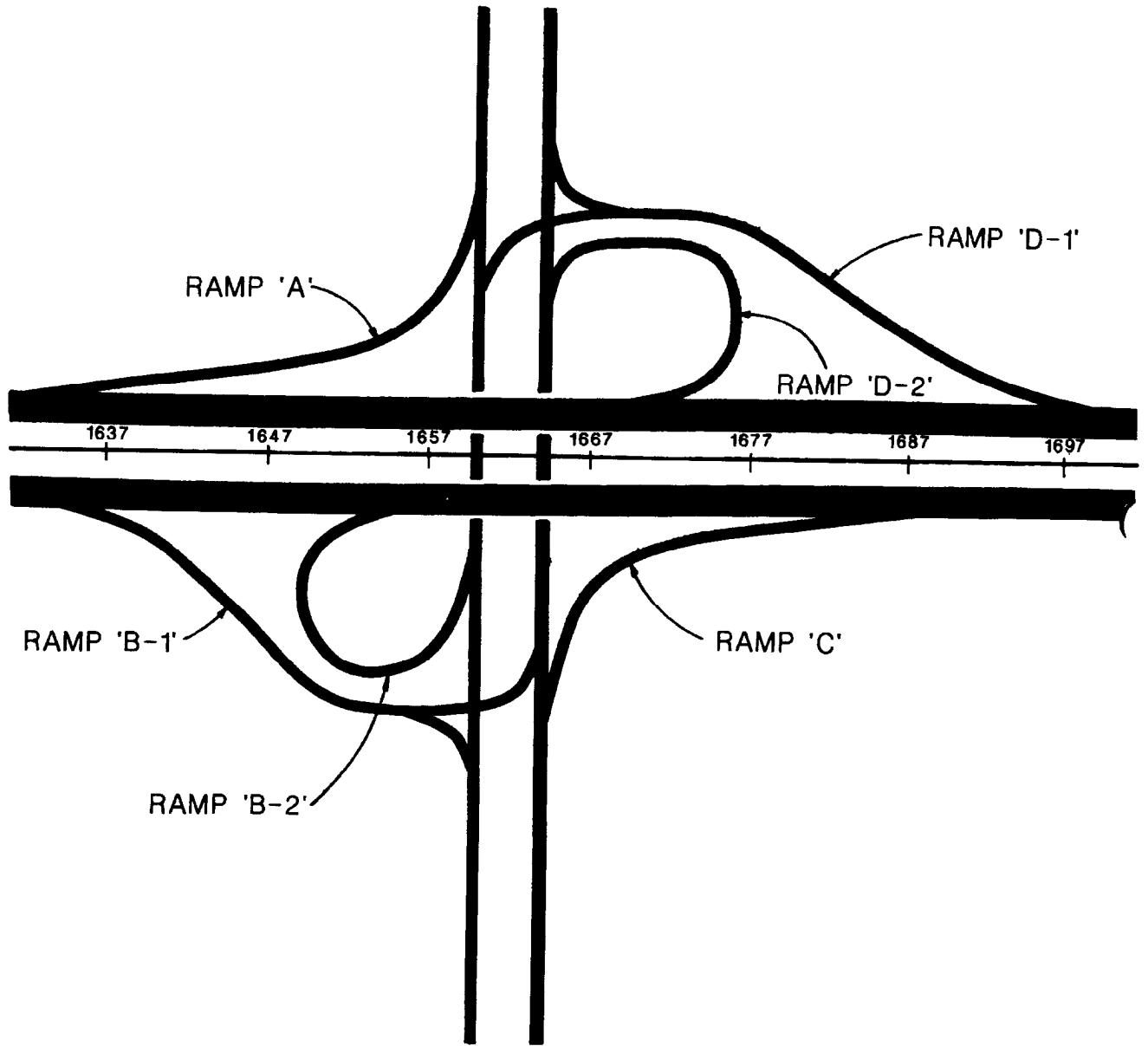

II-13-4 0

A topographic worksheet for all interchanges is required and will be considered as the preliminary layout of the interchange. This worksheet shall be prepared on a standard plan format on a scale of 1" = 200'. The following information shall be shown:

1. All topography, such as existing roads, property lines, utilities, houses, and driveways, etc.
2. Preliminary interchange geometrics and proposed right-of-way limits.
3. Drainage right-of-way.
4. Proposed reconstruction of the crossroad, and all access roads and frontage roads within the interchange.
5. Frontage roads should be assigned ~~unique alpha or numeric designation~~ ^{a unique alpha or numeric designation} to avoid confusion with ramp nomenclature.
6. Contours, unless the terrain is relatively flat.
7. Traffic diagram with ADT, DHV, K, D and T values.
8. The length of speed change lanes.
9. Design speed for ramps and crossroads.
10. Proposed bridge limits.
11. Pavement transitions.
12. Limits of construction along the crossroad.

The final plans set shall include the following interchange sheets:

1. Interchange geometric layout.
2. Interchange drainage map.
3. Interchange topographic map.
4. Interchange cross section pattern sheet.
5. Ramp terminal details.
6. Ramp cross sections.

13.3.2 Ramp Terminal Details

Details of ramp terminals with mainline and crossroads shall be shown on separate plan sheets. The scale used shall not be smaller than 1" = 40'. Standard scale 1"=20' is preferred. Complete details of the terminal shall be shown including:

Curve data

Station equality to mainline or crossroad at critical ramp locations

Turning radii, taper/transition lengths, curb/curb and gutter (if any)

Channelization (if any)

Ramp and crossroad intersection station and angle

Median nose data (if any)

Limits of construction

R/W

Limited Access R/W and fence location

Drainage structures

Spot elevations (as needed)

Roadway dimensions

Station pluses and offsets

13.3.3 Cross Section Pattern Sheet

The cross section pattern sheet shows the entire interchange layout including frontage and access roads, if any, with location and extent of proposed cross sections. This is of ~~the~~ ^{special} importance for projects involving new interchanges located in rural, undeveloped areas. Information to be shown shall include:

- North arrow and scale
- Interchange layout
- Access and frontage roads (if any)
- Centerline construction and baseline survey
- Ramp base lines
- Stationing along mainline, crossroads, ramps, access and frontage roads
- P.C. and P.T. points by symbol
- Bridge outline
- Cross section pattern

This sheet shall be prepared on a standard plan format. The scale shall be such that the complete interchange is shown on one plan sheet, with care taken to ensure clarity and legibility if the plans are reduced to half size. Normal scale is 1" = 200'. North arrow and graphic scale shall be located at a point of maximum visibility.

THIS EXHIBIT IS FOR EXAMPLE ONLY AND DOES NOT REFLECT THE DEPARTMENT'S DESIGN CRITERIA.

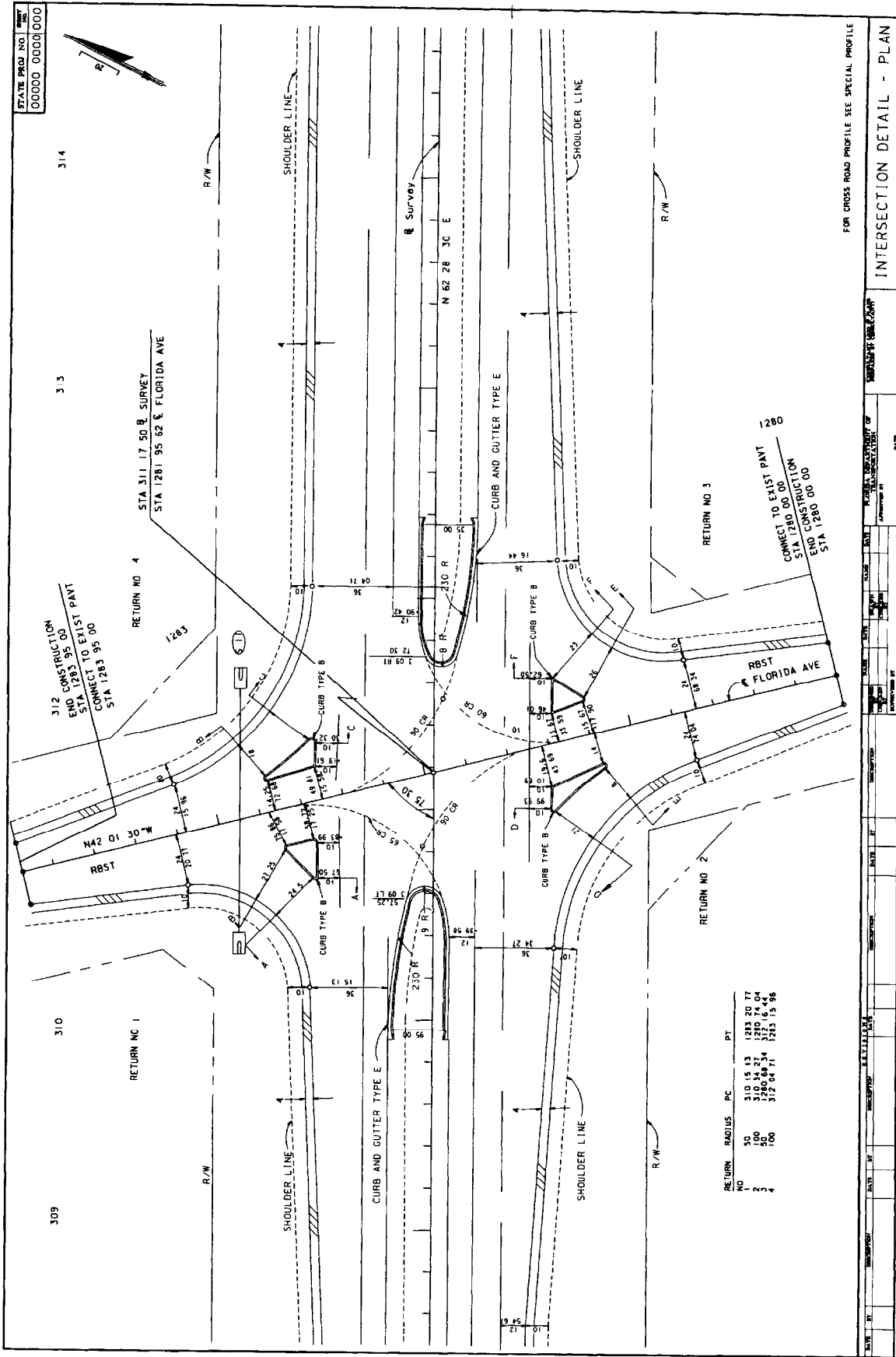

FOR CROSS ROAD PROFILE SEE SPECIAL PROFILE

INTERSECTION DETAIL - PLAN

EX 11-13-B

STATE PROJ NO 00000 0000 000

THIS EXHIBIT IS FOR EXAMPLE ONLY AND DOES NOT REFLECT THE DEPARTMENT'S DESIGN CRITERIA.

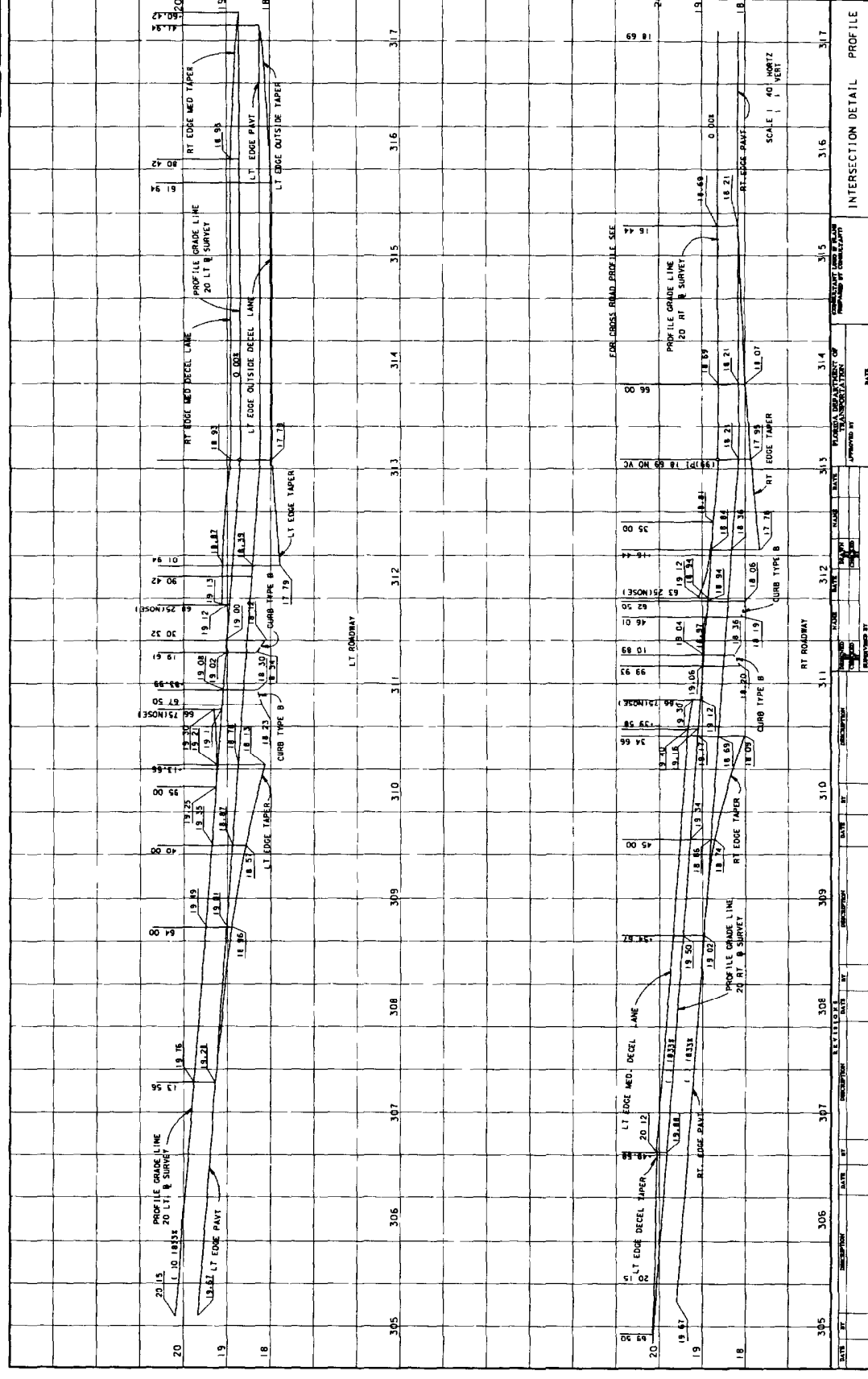

DATE	BY	DESCRIPTION	DATE	BY	DESCRIPTION	DATE	BY	DESCRIPTION	DATE	BY	DESCRIPTION
305			306			307			308		
309			310			311			312		
313			314			315			316		
317											

INTERSECTION DETAIL PROFILE

EX 11-13-C

THIS EXHIBIT IS FOR EXAMPLE ONLY AND DOES NOT REFLECT THE DEPARTMENT'S DESIGN CRITERIA.

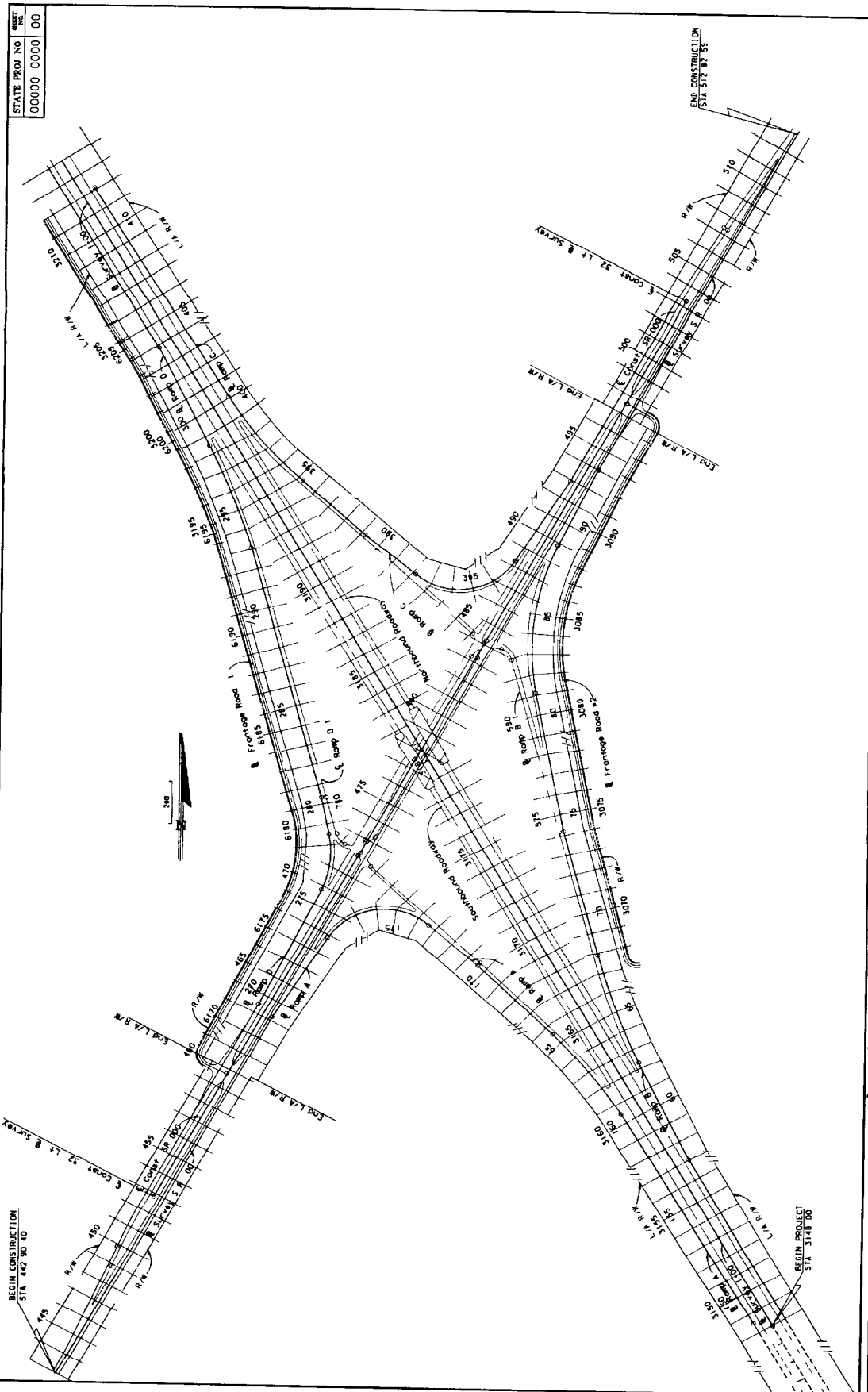

STATE PROJ. NO.	00000 0000 00
SHEET NO.	00

DATE	BY	DATE	BY	DATE	BY	DATE	BY	DATE	BY	DATE	BY
FEDERAL DEPARTMENT OF TRANSPORTATION APPROVED BY COMM. PLAT.											
CROSS SECTION PATTERN											

EX-11-13-F

DRAINAGE STRUCTURES

14.1 General

Drainage structure sheets show all the drainage structures, their location, cross section, flowline elevations of all weirs or slots, top of grates and top of manhole elevations, index numbers of standard details used and similar data. Drainage structure sheets also show the vertical relationships of the entire drainage system. During the process of drafting the drainage structures, potential conflicts with existing or proposed utilities shall be identified and resolved early, thereby avoiding costly time delays during the construction phases.

The inclusion of the drainage structure sheets in the plans set is a District option. Most projects require the plotting of drainage structures to avoid utility conflicts. One of the following options shall be required for each structure on a project. A mix of these options can be used on a single project.

- 1) All drainage structures can be plotted and included in the plan set.
- 2) A "Typical Drainage Structure Sheet" may be prepared and included in the plans set if the construction details can be shown in tabular form. This sheet shall show the typical cross section for the various types of drainage structures and their structure numbers, types, sizes, flow line elevations, flow lengths, end treatments and locations in tabular form (See Exhibit II-14-G). Only drainage structures with potential conflicts should be drawn and included in the plan set. A work sheet may be required to show cross sections at all structure locations. Worksheets should be prepared to show drainage structures at potential conflicts.

- 3) No drainage structures shall be plotted. Information concerning structures shall be shown in the plan view. A work sheet should be prepared which should show the cross sections at all structure locations. All information pertaining to drainage structures and the drainage system shall be available elsewhere in the plans package for this option. When optional culvert materials are provided, the required information must be plotted or tabulated elsewhere.

14.2 Required Information

The existing ground line for rural projects shall be drafted with a light solid line at the location of the structure, with the existing elevation placed immediately below the groundline at the survey baseline. No existing structures shall be shown except those to be incorporated into the proposed drainage system or otherwise modified. These shall be drafted using a medium broken line, and their flowline elevations noted. Where storm sewers run laterally or diagonally across the project, the drawing should show the pipe cover.

Roadway template and proposed structures shall be drafted using a heavy solid line, with the proposed profile grade elevation shown above the grade point. The structure shall be located by station and offset to the centerline of construction. Flowline information shall be provided at each structure and at each culvert end. Structures are to be plotted in detail according to the applicable Index, with walls, grates, tops, pipes, etc. shown.

Sections for skewed cross drains shall be drafted along the centerline of the structure. For all structures, clear zone distances shall be measured at right angles to the project centerline and noted on the sheet.

All structure locations should be checked and right-of-way shown where the right-of-way may have potential impact on construction of a structure.

For each drainage structure which does not have options, all necessary information shall be shown by note, including, as appropriate: size, length, class or gauge (thickness), corrugation size restriction, protective coatings, end treatments and flow lines. The note shall be placed as close to the structure as possible, preferably below the plotted structure. Standard index numbers shall be shown for endwalls, inlets, and other accessory structures and details. Elevations shall be given for manhole tops, and ditch bottom inlet grates and slots. Grate elevations for shoulder gutter and curb and gutter inlets shall be shown if not controlled by typical section.

For drainage structures which have material options, the Optional Cross Drain Material Tabulation sheet should be used, and only the structure number with size and length of the selected option shall be shown. Elevations shall be given appropriate for the option shown.

Alternate "G" or other special grate treatment shall be included with the inlet note. Additional details, such as special bedding, shall be indicated. Flow direction arrows shall be shown.

If existing structures are to be plugged and abandoned, they shall be shown with an appropriate note.

| Applicable notes are to be shown on the first drainage structure sheet. These
| notes are listed in the Design Aids section of the Basis of Estimates Manual and
| are shown on the exhibits in this chapter.

14.3 Utility Conflicts

All major underground utilities shall be plotted in conjunction with the structures so that conflicts may be detected during design, and to alert construction forces of close conflicts

Utilities that have been positively verified should be noted and plotted to scale in the appropriate locations on the Drainage Structure Sheets, Cross Section Sheets and bridge foundation plans. These utilities should be labeled with the following symbols

- V_v = Verified Vertical Location
- V_h = Verified Horizontal Location
- V_{vh} = Verified Vertically and Horizontally

14.4 Sheet Set Up

Structures should be drafted as sections along the centerline of the structure. They should be drafted on a standard cross section format with the sections spaced sufficiently apart to avoid overlapping of structures or notes. Beginning at the bottom of the sheet, the sections should be shown successively by stations and should be numbered sequentially from the beginning to the end of the project. The structure number and location station should be shown near the right border of the sheet. If a structure must be shown out of order, a note shall be placed in the correct sequence, referring to the sheet where the structure is shown. The scale shall be the same as that used for roadway cross sections, with the centerline of construction placed near the center of the sheet.

THIS EXHIBIT IS FOR EXAMPLE ONLY AND DOES NOT REFLECT THE DEPARTMENT'S DESIGN CRITERIA

STATE PROJ. NO. 00000 0000 00
 SHEET NO. 00

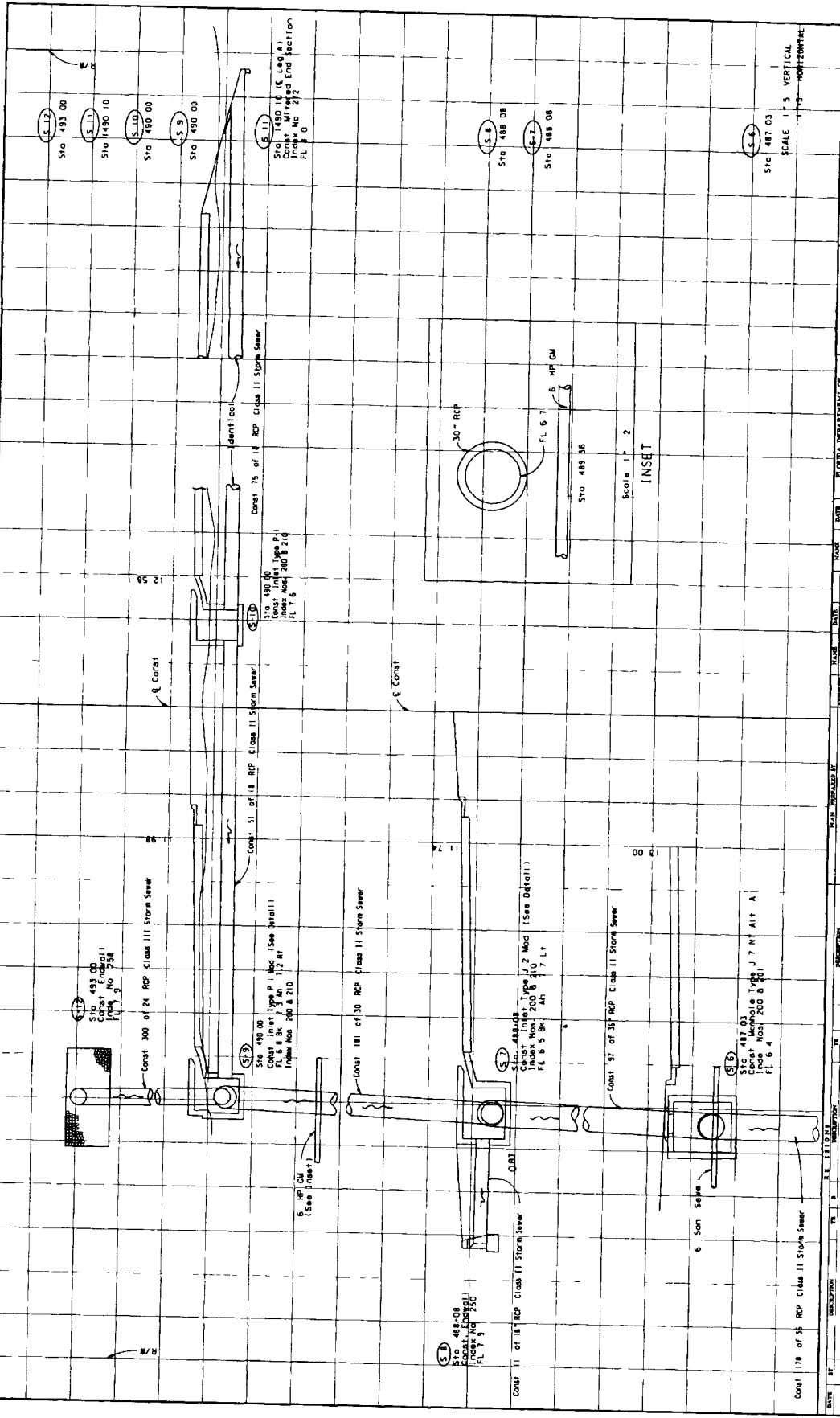

DATE	BY	DESCRIPTION

SCALE: 1" = 2'
 INSET
 SCALE: 1" = 2'
 1/3 VERTICAL
 1/3 HORIZONTAL

FLORIDA DEPARTMENT OF TRANSPORTATION
 APPROVED BY: _____
 DATE: _____

DESIGNED BY: _____
 CHECKED BY: _____
 DATE: _____

DATE: _____

PROJECT NO. 00000 0000 00

SHEET NO. 00

EX II-14-B

THIS EXHIBIT IS FOR EXAMPLE ONLY AND DOES NOT REFLECT THE DEPARTMENT'S DESIGN CRITERIA

STATE PROJ. NO. 00000 0000 00

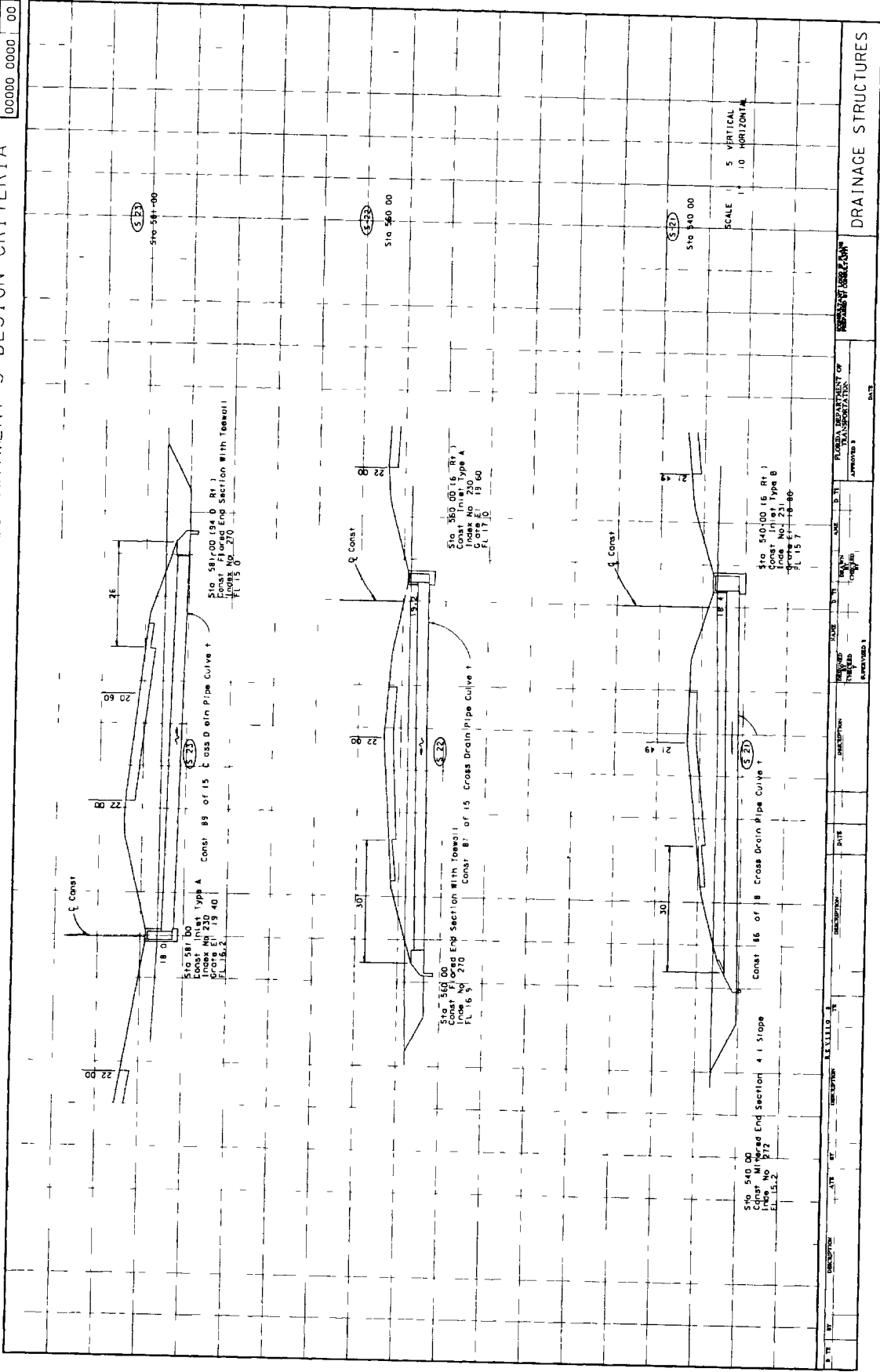

DRAINAGE STRUCTURES

EX 11-14 F

CHAPTER 15

OUTFALL/LATERAL DITCH SYSTEM

15.1 General

A lateral ditch is one that runs more or less perpendicular to the centerline of roadway. The purpose of the ditch is to provide drainage to or from areas ^{which lie} outside of the immediate project limits ~~that~~ ^{by which} are involved by the proposed roadway project. The lateral ditch plan and profile sheets shall provide the necessary details for the construction of the ditch.

"Outfall" is the term used for the conveyance of storm water (by ditch, pipe or other means) from a stormwater collection or cross drain to a stormwater management system such as a retention or detention area, or to a receiving system. The receiving system can be a ditch or a drainage canal with Retention/Detention pond.

Lateral ditch plans and profiles shall be prepared on a standard plan - profile format using a horizontal scale of 1" = 100'. However, if storm sewer construction is proposed for a portion of the ditch, a scale of 1" = 20', 40' or 50' may be used.

Data presentation in the plan portion shall be so oriented that the ditch or outfall centerline is parallel to the long side of the sheet and the project centerline runs from the bottom to the top.

Lateral ditch cross sections are included in the plans set to show details of the lateral ditch within the project limits. This sheet also shows the right-of-way required for the ditch, the extent of clearing and grubbing required and the amount of earthwork. Lateral ditch cross sections are prepared on a standard profile format.

15.2 Plan Portion

15.2.1 Lateral Ditch

Centerlines of the ditch and roadway shall be plotted and stationed in a manner similar to that described in Chapter 10-Roadway Plan and Profile. Ditch alignment data and topography shall be shown in the plan portion. Bearings and curve points for the project centerline shall also be shown. The north arrow and graphic scale shall be placed at the proper location on the sheet (refer to Chapter 10).

15.2.2 Outfall

The drainage system below the portion shown elsewhere on the plans, but at least the last section leading to the outfall structure shall be shown in plan with complete data. The location of the outfall structure shall be clearly shown in the plans and shall be identified by station.

15.3 Profile Portion

15.3.1 Lateral Ditch

The profile portion shall be prepared in the same manner as the profile portion of the roadway plan - profile sheets (Chapter 10). Existing ground line profiles, high water elevations, underground utilities, bench mark information and elevation datum shall be shown as described for roadway plan-profiles.

For projects where the ditch survey baseline does not follow the flow line of the existing ditch or channel, the existing channel profile shall be shown with a broken line and identified.

If lateral ditch cross sections are not included in the plans, the limits and quantities of proposed ditch excavation shall be shown by a dimension line above the ditch profile.

If storm sewer construction is proposed along a lateral ditch, all of the proposed structures should be drafted as drainage structures or in the profile showing flow line, structure numbers, pipe or culvert sizes, standard index numbers and utilities (if applicable).

At locations of probable overland flow, natural ground or overtopping elevations shall be shown by a broken line and labeled.

15.3.2 Outfall

The discharge end of the drainage system leading to the outfall structure shall be shown in profile when drainage structure sheets are not included in the plans. Flow elevations, flow arrows, pipe or ditch slopes, standard index numbers, ^aseparate lateral ditch outfalls, pipe outfalls, structures with their numbers or DPIs etc. of the last section before the outfall shall be shown in profile. The outfall structure shall be shown by a heavy solid line and its station location flagged and labelled. The normal and high water elevations of the receiving system shall be indicated and labelled.

15.4 Typical Section

A typical section showing width of proposed clearing and grubbing, right-of-way, ditch bottom width and side slopes shall be shown on the profile portion of the lateral ditch plan and profile sheet. This section may not be to any particular scale, but shall be dimensionally proportionate. If the width of clearing and grubbing is variable for a project, then the various widths and their respective station limits shall be noted below the typical section.

15.5 Ditch Cross Sections

Lateral ditch cross sections shall be prepared in a manner almost identical to that of roadway cross sections (Chapter 18). The standard scale, generally, shall be 1" = 5', vertical and horizontal. ~~However,~~ Regardless of the horizontal scale used, the vertical scale shall always be 1" = 5'.

Ditch rights-of-way are usually narrow, and often it is possible to place two or more columns of ditch cross sections on one sheet. They shall be drafted exactly as the roadway cross sections with the stationing progressing from the bottom of the sheet to the top, and from left to right.

Usually, soil surveys are made along the lateral ditch only when a large amount of material is expected to be excavated and if suitable material is to be used in the roadway. Excavation shall be tabulated whether the material is classified or unclassified.

All other points mentioned in "Roadway Cross Sections" (Chapter 18) shall be applicable equally to lateral ditch cross sections.

15.6 Retention or Detention Pond

The retention or detention pond, including the outlet structure, is usually the end point of the drainage system for a particular project. The retention/detention pond detail sheet shall show the pond in plan view, cross sections of the pond, side slopes, fence locations, right-of-way, pond drainage structures (if any) with their locations and cross sections and any other necessary data pertaining to the pond.

The pond location shall be shown by station and offset to the centerline of construction of the project. Side slopes, base dimensions and bottom and top elevations of the pond shall be shown in plan. The pond cross sections shall show the bottom width and elevation, side slopes, normal water depth, if applicable, design highwater and overtopping elevations and soil borings. A minimum of two (2) cross sections, taken in directions perpendicular to each other, shall be shown. Refer to Exhibit II-15-A.

CHAPTER 16

SPECIAL DETAILS

16.1 General

Special details sheets are usually included in the plans set if the project involves areas which require special attention to some construction elements. Construction details that are not covered in the Roadway and Traffic Design Standards booklet or elsewhere in the plans set shall be shown on the special details sheet. Crash cushion details shall also be shown on this sheet. This sheet shall be prepared on a standard plan format. Any convenient scale may be used, provided the information shown is clear and legible at half size reduction of plans. Details shown shall be clear, legible, labelled, complete in all respects and should be adequately cross-referenced to the plans in the plans set.

CHAPTER 17

SOIL SURVEY

17.1 General

The soil survey sheet, essentially a soil test analysis sheet, depicts the various types of soils encountered within the limits of the project. This sheet also shows the classification, mechanical properties and recommended usage of those soils. Soils having identical characteristics shall be assigned to the same stratum and group for identification and recommendation purposes. The test analysis sheet shall be signed by the responsible Engineer, (the District Materials Engineer for in-house projects, and a Registered Professional Engineer for consultant prepared plans).

17. 2 Roadway Soil Survey

17.2.1 Method of Compilation and Presentation

Upon completion of the proposed typical section, and after placing alignment, proposed grades and existing utilities on the plan - profile sheets and preliminary sections, prints of these sheets shall be utilized by the appropriate soil survey group (District Materials Engineer for in-house projects and a Soils and Foundation Engineer for consultant prepared plans) for determining the location and depth of borings for the sampling of soils for testing and classifications. These classification and test results, including pH, resistivity, sulfides and chlorides shall be shown on the test analysis sheet. Date and weather conditions at the time of sampling shall also be shown. Refer to Exhibit EX-II-17-A for an example of soil survey sheet.

After completion of soils testing, the boring data shall be shown on cross sections by columns approximately 0.4" wide below the ground line at test sample locations. Stratum limits and numbers shall be shown inside the column. This information shall be transmitted to the appropriate responsible materials engineer for verification. One hard copy of the soils information, including cross sections with soils information, shall be retained in the Soils Engineer's Record.

17.3 Borrow Pit Soil Survey

The borrow pit soil survey shall be included in the roadway plans set only if the borrow material is to be provided to the contractor by DOT. This sheet is similar to the roadway soil survey sheet and shows the location of test holes, various strata encountered, soil properties, classification and recommended usage.

The location of the borrow pit with respect to the project centerline shall be clearly shown. The survey baseline for the borrow pit shall be tied to the project centerline by station and angle. Begin and end borrow pit baseline stations shall be flagged and labelled. The borrow pit shall be completely dimensioned with all internal angles shown clearly. Boring locations shall be indicated and labelled. The north arrow and graphic scale shall be shown at a point of maximum visibility in close proximity to the borrow pit location map. Benchmark information with elevation shall be shown. Complete information with respect to Section, Township, Range and county shall be shown together with the borrow pit number. A description of the soils strata encountered shall also be shown.

The various strata encountered at each boring location shall be placed on a standard cross section format by columns of approximately 0.4" wide. The recommended vertical scale is 1"=5'. Strata shall be identified by number and water table elevation indicated by symbol at the appropriate elevation.

A complete soils analysis report and recommended usage shall be shown including date of survey and date(s) of analysis/test.

For complete sheet set up, see Exhibit II-17-B.

CHAPTER 18

ROADWAY CROSS SECTIONS

18.1 General

Cross sections depict the existing ground conditions, including all manmade features, as sections perpendicular to the respective stations along a survey baseline or construction centerline baseline. The proposed cross-sectional outline of the new facility with all its functional elements is also shown on cross sections. Standard cross section sheets shall be used for showing roadway cross sections. The recommended scale is 1" = 5' vertical. The horizontal scale shall be such that the entire roadway R/W is shown on the sheet, but shall not be smaller than 1" = 20' horizontal. If the entire R/W cannot be shown on one sheet, more sheets may be utilized and appropriate match lines shall be shown with referenced sheet numbers. The scale shall be shown at the bottom right corner of the sheet above the title box.

18.2 Required Information

Existing ground lines shall be shown with a light dashed line. The existing ground line elevation at the centerline shall be noted just below the ground line at the centerline. The station number of the section shall be indicated in heavy numerals opposite the ground line on the right side of the sheet and location base line of survey indicated along the top and bottom of the sheet. Lines parallel to the baseline of survey should show station equivalencies to the base line of survey.

The surface of existing construction such as pavements, curbs, and sidewalks, shall be shown using a solid line. The bottom of the pavement, curbs and sidewalks, shall be shown by a light broken line.

Existing parallel underground utilities which lie within the horizontal limits of the project shall be shown along with verification notation for those locations which have been verified. Utilities that have been verified should be labeled as shown in Section II-14.3 (page II-14-5.0). Small distribution or service lines need not be drafted.

Soil data and water table shall be shown on cross sections as described in Section 17.2.1 of this volume. Limits of unsuitable material shall also be shown.

The proposed roadway template shall be shown using a heavy solid line. Proposed profile grade elevation shall be placed vertically or at an angle to the horizontal, just above the profile grade line. Special ditch elevations shall also be shown.

Station equations shall be shown, even though a cross section may not be plotted at that point. For ramp cross sections equivalent mainline stations shall also be shown.

The right-of-way limits shall be symbolically shown for each cross section.

The begin and end stations for project, construction, exceptions, |
bridge/bridge culvert and the toe of slope under the bridge shall be shown

The beginning and ending earthwork stations shall be shown On projects
with grade separations, intersections interchanges, etc , the earthwork shall
be totaled on the last cross section sheet for each of the above and noted as
to the station in which the earthwork is included on the project cross sections
Earthwork quantities for suitable material shall be indicated in the appropriate
columns on the right side of the sheet, quantities for all other materials should
be indicated in appropriate columns on the left side of the sheet Earthwork
summaries shall be shown on the last cross section sheet of each roadway,
ramp, etc The grand total shall be shown on the last cross section sheet of
the plans set

The order of assembling the cross sections in the plans set shall be

Mainline
Side streets
Ramps

18.3 Sheet Set Up

Cross sections shall be shown on a standard cross section format with stations increasing from the bottom to the top of the sheet. Usually, only one column of sections shall be placed on a sheet.

Sections shall be centered on the sheet with the survey baseline or the construction centerline placed vertically in the center. In cases where additional lanes are to be constructed adjacent to existing lanes, centering the sections will depend upon the location of the survey line and the side on which the new construction is to be placed. Sections shall be oriented such that the complete ultimate section will be approximately centered on the sheet. When the centerlines of construction and survey are not parallel, the distance between the two at each cross section shall be shown.

As many sections as possible shall be placed on a sheet with sections being spaced to avoid overlapping. The soil profile should be checked for possible unsuitable material below existing ground which may cause overlapping of sections.

Profile grade elevations shall be shown and may be written vertically or at an angle to the horizontal.

When right-of-way is narrow enough and a horizontal scale of 1" = 10' is used, two columns of cross sections may be placed on a sheet. Cross section placing progresses from the left to the right as well as from the bottom to the top of the sheet. The sheet shall be set up to provide earthwork columns for each column of sections. Usually, access roads and lateral ditches can be plotted in this manner.

THIS EXHIBIT IS FOR EXAMPLE ONLY AND DOES NOT REFLECT THE DEPARTMENT'S DESIGN CRITERIA

STATE PROJ. NO. 00000 0000 00
 DIST. NO. 0000 0000 00

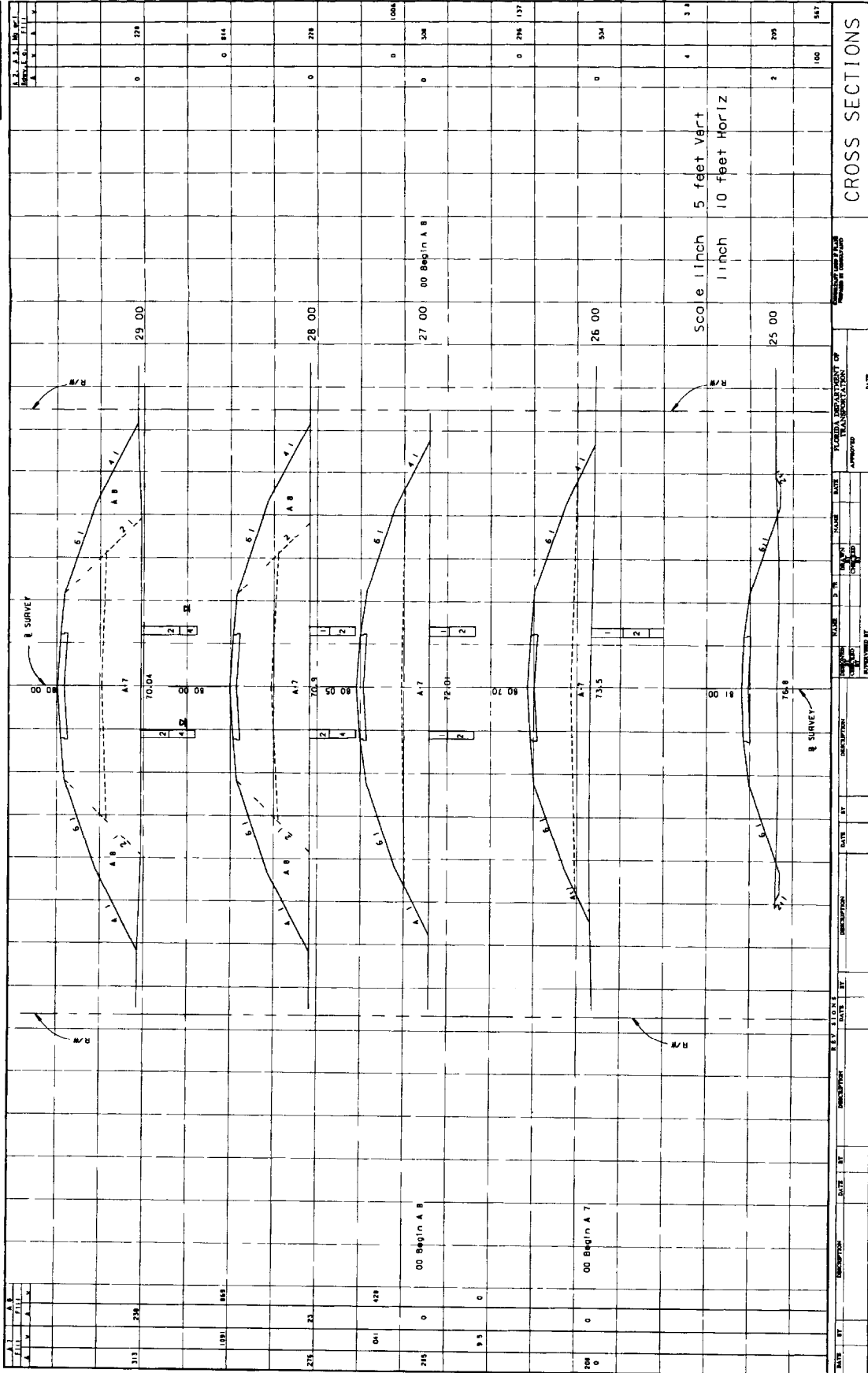

EX-II-18-A

THIS EXHIBIT IS FOR EXAMPLE ONLY AND DOES NOT REFLECT THE DEPARTMENT'S DESIGN CRITERIA.

STATE PROJ. NO. 00000 0000 00

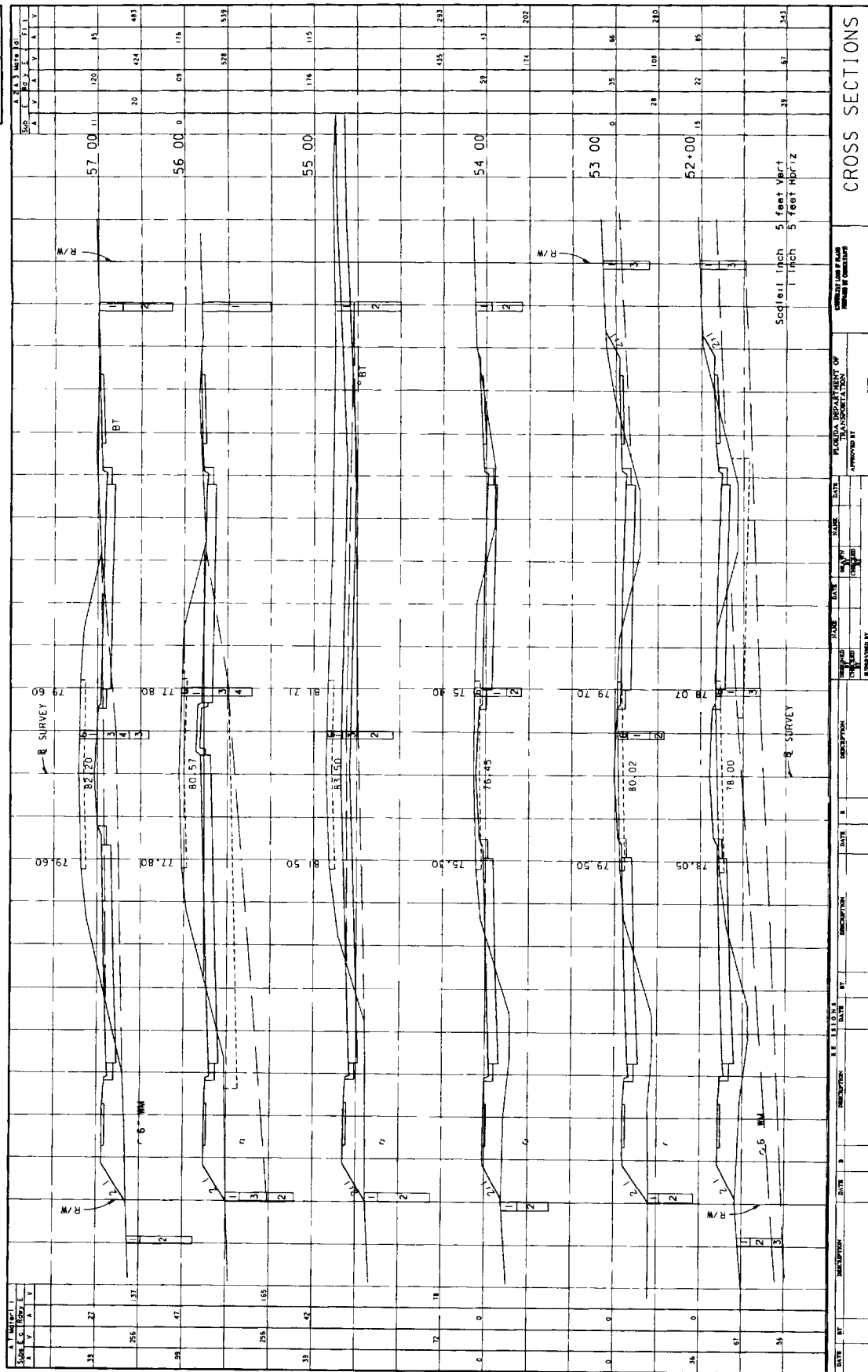

DATE: _____

DESCRIPTION: _____

DATE: _____

DESCRIPTION: _____

DATE: _____

DESCRIPTION: _____

DATE: _____

DESCRIPTION: _____

DATE: _____

DESCRIPTION: _____

APPROVED BY: _____

FLORIDA DEPARTMENT OF TRANSPORTATION

SCALE: 1 inch = 5 feet Vert, 1 inch = 5 feet Horiz

CROSS SECTIONS

EX-II-18-B

THIS EXHIBIT IS FOR EXAMPLE ONLY AND DOES NOT REFLECT THE DEPARTMENT'S DESIGN CRITERIA

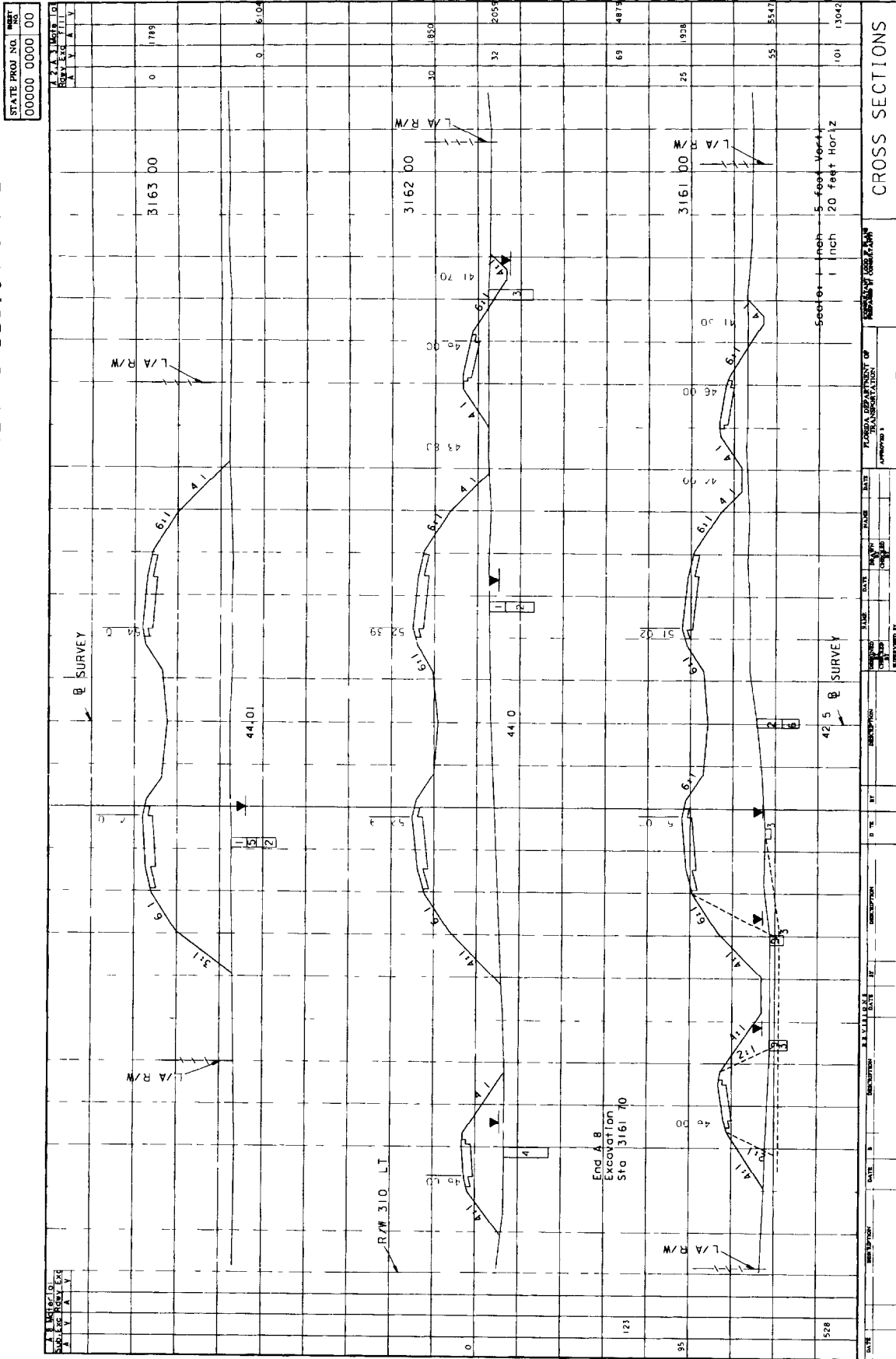

DATE	DESCRIPTION	BY	DATE	DESCRIPTION	BY	DATE	DESCRIPTION	BY

APPROVED BY: _____ DATE: _____

FLORIDA DEPARTMENT OF TRANSPORTATION

SECTION: 1 inch 5-foot Vert. 20 feet Horiz.

CROSS SECTIONS

EX II 18 C

CHAPTER 19

TRAFFIC CONTROL SHEETS

19.1 General

The need to improve the capacity of and to rehabilitate Florida's highways has greatly increased the frequency of highway construction taking place immediately adjacent to or under traffic. The exposure of both the travelling public and construction and inspection personnel, to conflicts that may become hazardous is tremendous. In addition to the safety issue, the potential delays to the public as traffic is interrupted by construction can be significant. As a result, the Florida DOT places a great deal of emphasis upon ensuring that traffic can be accommodated through construction zones with minimum delay and exposure to unsafe conditions.

A Traffic Control Plan (TCP) accompanies the plans and specifications for a construction project. The TCP documents the considerations and investigations made in the development of a comprehensive plan for accommodating traffic through construction work zones.

A TCP describes all actions to be taken to minimize traffic impacts, such as design of the project itself, contract specifications, actions to be taken by DOT personnel and traffic control sheets. It is important to understand that the traffic control sheets which are part of the construction plans are the result of the TCP, and as such, are a part of a comprehensive effort to minimize impacts on traffic.

19.2 Required Information

Specific traffic control sheets shall be prepared using information from the plan - profile sheets and interchange and intersection layout sheets, if necessary. The plans shall show the following details:

- Centerline, pavement edge, curb lines, shoulders, lane configurations, intersections, and access openings.
- Locations of construction signs (including variable message signs), advance warning arrow panels, portable concrete barriers, crash cushions, temporary signals, flaggers and all regulatory speed signs.
- Sign faces with leader lines connecting the sign face to the appropriate location, including temporary modifications to permanent signs.
- Location and legends of permanent signs with appropriate notes for their dispositions. (e.g. "To Be Removed" etc.)
- Dimensioned locations of channelizing devices, with notes indicating the type, spacing and lane taper lengths required.
- Pavement markings to be removed and required temporary markings.

Locations of existing utilities that may conflict with construction necessary for traffic control.

- Notes referencing Roadway and Traffic Design Standard Series 600 as applicable, and any others necessary to clarify the plan. Special notes might include instructions for the use of service patrols, police and highway advisory radio.

Plan sheets shall be prepared for each phase of traffic control during construction and each major traffic pattern that will be used during each phase (for example, in the case of night work, the daytime and nighttime traffic patterns shall be shown for a particular traffic phase.)

The traffic control sheets shall use relevant existing or proposed roadway features for the phase being illustrated. Data shall be transferred from the appropriate CADD levels of the plan - profile sheets. Appropriate CADD library cells shall be used for sign faces and standard notes.

19.3 Format and Scale

The plan sheets shall be prepared on standard plan sheets. The scale shall be such that all details are clear and legible at half-size reduction of plans. However, the scale shall not be smaller than 1"=100'. For simple, uncomplicated projects, or sections of a project, it may be possible to "stack" two plans on one sheet, one below the other. Clarity and legibility shall be preserved in all cases.

A north arrow and graphic scale shall be shown at a point of maximum visibility on the sheet. If two plans are "stacked" on one sheet, then each plan portion shall contain a north arrow and graphic scale.

THIS EXHIBIT IS FOR EXAMPLE ONLY AND DOES NOT REFLECT THE DEPARTMENT'S DESIGN CRITERIA.

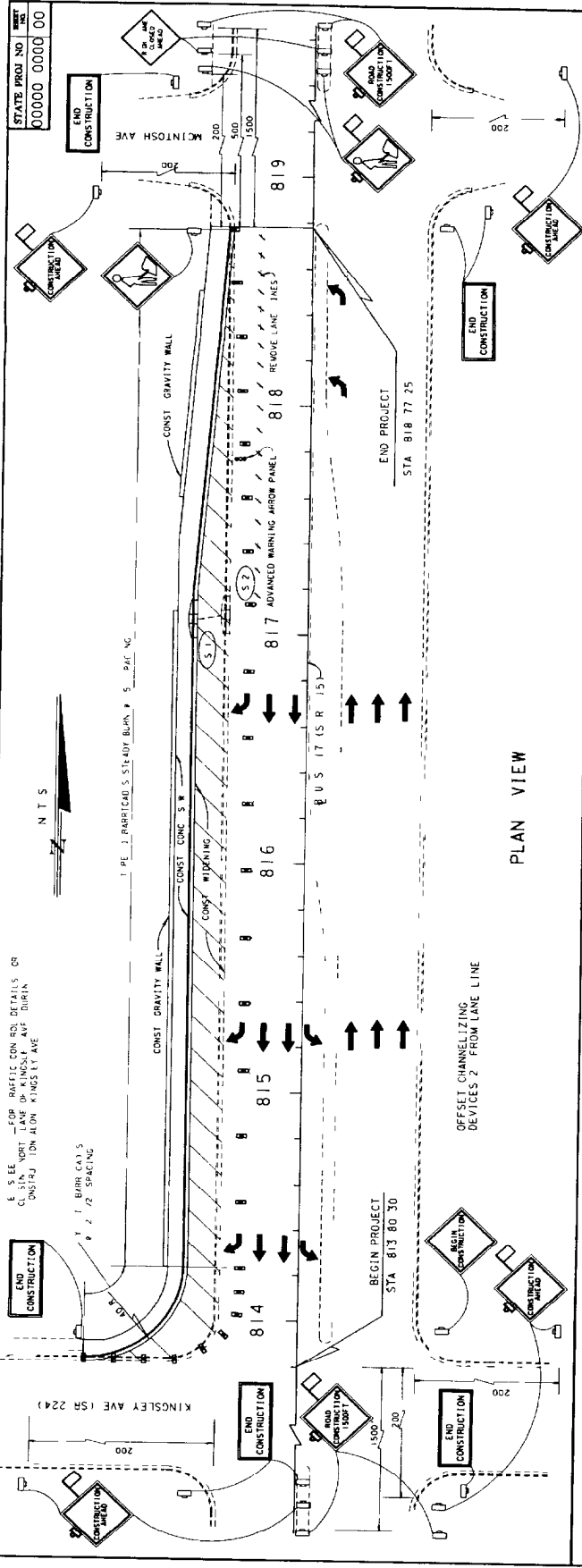

PLAN VIEW

PHASING

PHASE 1
 1. CURB AREA NECESSARY TO CONSTRUCT NEW CURB AND OUTER AND DRAINAGE STRUCTURES 2. LEAVE EXISTING CURB AND OUTER AREAS IN PLACE UNTIL PHASE 2 IS COMPLETE. 3. CLEARING AND GRUBBING OPERATIONS INCLUDING REMOVAL OF THE EXISTING SIDEWALK AND EXISTING SIDEWALK. 4. CONSTRUCT THE PIPE CONNECTING S. 1 AND S. 2 AND BEGIN BASE EXCAVATION. ONLY THAT EXCAVATION SHALL BE ALLOWED TO BE OPEN AT THE END OF THE WORK DAY. 5. EXCAVATION SHALL BE ALLOWED TO BE OPEN AT THE END OF THE WORK DAY. 6. SPEED THROUGH THE WORKZONE SHALL BE RESTRICTED TO 30 M.P.H.

PHASE 2
 1. COMPLETION OF THE BASE OPERATIONS STRUCTURAL COURSE WILL BE PLACED FOLLOWED BY THE UPPER COURSE AND THE STRIPING.

GENERAL NOTES

1. NO WORK SHALL BE DONE REQUIRING A LANE CLOSURE BETWEEN THE HOURS OF 6:00 A.M. THRU 9:00 A.M. AND 4:00 P.M. THRU 6:30 P.M.
 2. NO WORK WILL BE DONE DURING THE FOLLOWING PERIODS:
 - MONDAY, JULY 22 TO MONDAY, JULY 29
 - MONDAY, DECEMBER 20 TO MONDAY, JANUARY 3
 - MONDAY, NOVEMBER 20 TO MONDAY, JANUARY 3
 - MONDAY, NOVEMBER 20 TO MONDAY, JANUARY 3
- SPECIAL EVENTS SUCH AS:
 - 1. MONDAY, DECEMBER 20 TO MONDAY, JANUARY 3
 - 2. MONDAY, DECEMBER 20 TO MONDAY, JANUARY 3
 - 3. MONDAY, DECEMBER 20 TO MONDAY, JANUARY 3
 - 4. MONDAY, DECEMBER 20 TO MONDAY, JANUARY 3
 - 5. MONDAY, DECEMBER 20 TO MONDAY, JANUARY 3
 - 6. MONDAY, DECEMBER 20 TO MONDAY, JANUARY 3
 - 7. MONDAY, DECEMBER 20 TO MONDAY, JANUARY 3
 ETC. AND ANY EMERGENCIES DEEMED NECESSARY BY LOCAL LAW ENFORCEMENT AUTHORITIES OR RESIDENT ENGINEER.
 3. MAINTENANCE OF TRAFFIC SHALL BE IN ACCORDANCE WITH THE MANUAL ON UNIFORM TRAFFIC CONTROL DEVICES PART VI WORK ZONE TRAFFIC CONTROL.
 4. AN OFF DUTY LAW ENFORCEMENT OFFICER WITH A MARKED LAW ENFORCEMENT VEHICLE WILL BE REQUIRED FOR EACH LANE CLOSURE.
 5. DESIGN SPEED IS 30 M.P.H.
 6. ARROW DIRECTION OF TRAFFIC ONLY AND DO NOT REFLECT PAVEMENT MARKINGS.
 7. INFORMATION REFER TO INDEX NO. 600.

DATE	BY	DESCRIPTION	DATE	BY	DESCRIPTION	DATE	BY	DESCRIPTION

TRAFFIC CONTROL PLAN

CHAPTER 20

UTILITY ADJUSTMENT

20.1 General

The purpose of utility adjustment sheets is to provide coordination between the contractor and the affected utility companies. These sheets show the contractor the approximate locations of existing, proposed and relocated utilities, and thus aids the contractor in avoiding possible conflicts or damage to the utilities involved.

20.2 Required Information

Locations of all existing utilities within the project limits shall be shown on the plans prior to the Phase I submittal. Each of the utility companies shall be provided by DOT, a set of plans at the Phase II submittal. The utility companies shall verify or show by marking up the prints, the location of their respective utilities. Information shown on these marked up prints shall be used by the roadway design office to prepare utility adjustment sheets. All proposed and relocated utilities shall be clearly shown on the plan by a heavy solid line and standard utility symbol and labelled (see Standard Index #002). Disposition of all existing utilities shall be clearly indicated for example "To Be Removed", "To Be Adjusted", "To Be Relocated", etc. All proposed utilities shall be appropriately labelled. Applicable general notes shall also be shown on the first utility adjustment sheet.

20.3 Sheet Format and Scale

The utility adjustment sheets shall be prepared on the same format and base information as that of the plan - profile sheets. Levels, fonts and line weights shall be in accordance with CADD Roadway Standards and Guidelines. Scale shall be the same as that used for the plan - profile sheets.

The utility adjustment sheets shall show the following base information as a minimum

- (1) Baseline and/or Centerline of survey,
- (2) Curb and gutter or edge of pavement,
- (3) Drainage structures (existing and proposed),
- (4) Right-of-way lines,
- (5) Station numbers,
- (6) Street names,
- (7) Disposition of existing utilities, and
- (8) Location of proposed utilities

CHAPTER 21

SELECTIVE CLEARING AND GRUBBING

21.1 General

Selective clearing and grubbing plans show the extent and type of clearing operation required within the project right-of-way limits. This information may be shown on the plan - profile sheet, if no substantial clutter of the sheet results. Otherwise, selective clearing and grubbing shall be shown on a separate plan sheet.

21.2 Required Information and Sheet Set Up

When separate selective clearing and grubbing sheets are required, they shall be shown on a standard plan format. Complete existing topography shall be shown together with centerline of construction with stationing, R/W lines and limits of construction. The type of selective clearing and grubbing operation to be performed shall be clearly shown by symbol (refer to Section 21.3 for symbols and notes). A north arrow and graphic scale shall be placed at a point of maximum visibility on the sheet. Any convenient scale may be used provided clarity and legibility are preserved at half size reduction of plans. However, it is recommended that the selective clearing and grubbing plans be prepared at the same scale as the roadway plan - profile sheets.

Appropriate match lines shall be used when necessary.

For a complete illustration of a selective clearing and grubbing sheet, see Exhibit II-21-A.

21.3 Standard Symbols and Notes



Designates areas to remain natural. No clearing or grubbing in these areas. No equipment shall enter these areas.



Designates areas where trees and stumps over 3" caliper shall be cut flush with the ground or removed, and all undergrowth is to remain natural. No equipment shall enter these areas that would in any way damage the plant material to remain.



Designates areas where trees of 3" caliper or greater are to remain and all undergrowth is to be removed, only rubber tire equipment shall enter these areas, and remaining trees shall be protected from root and trunk damage.



Designates areas where the type and extent of clearing and grubbing shall be determined by the Engineer according to field conditions.



Designates areas that shall remain natural, when, in the opinion of the Engineer, adequate and desirable natural vegetation or grass exists. Where this type vegetation does not exist, only harrowing, disking, leveling, and/or clean-up shall be undertaken, to a degree sufficient to prepare the area for grassing operations.

All other areas not included in one of the above categories, or those designated by the Typical Sections, shall be "standard clearing and grubbing".

Where unforeseen site conditions exist, adjustments or exceptions may be made to the above procedure at the direction of the Engineer.

THIS EXHIBIT IS FOR EXAMPLE ONLY AND DOES NOT REFLECT THE DEPARTMENT'S DESIGN CRITERIA.

STATE PROJ NO. 00000 0000 00

TOPSOIL MUCK BLANKET GENERAL NOTES

SELECTIVE CLEARING GENERAL NOTES

STOCKPILING OF TOPSOIL AND/OR MUCK IS TO BE DONE ONLY IN AREAS DESIGNATED AS TYPE 5 (SEE SELECTIVE CLEARING GENERAL NOTES) WHERE SUCH AREAS HAVE BEEN CLEARED AT THE DIRECTION OF THE ENGINEER DURING CONSTRUCTION OPERATIONS. SUFFICIENT AREA HAS BEEN DESIGNATED SO THAT ALL STOCKPILING MAY BE DONE IN ACCORDANCE WITH THE REQUIREMENTS LISTED ABOVE.

DESIGNATES AREAS TO REMAIN NATURAL. NO CLEARING OR GRUBBING IN THESE AREAS. NO EQUIPMENT SHALL ENTER THESE AREAS.

DESIGNATES AREAS WHERE TREES AND STUMPS OVER 3 INCHES IN DBH SHALL BE CLOSURE CUT AND REMOVED. NO EQUIPMENT SHALL ENTER THESE AREAS THAT WOULD IN ANY WAY DAMAGE THE PLANT MATERIAL TO REMAIN.

DESIGNATES AREAS WHERE TREES OF 3 CALIBER OR GREATER ARE TO REMAIN AND ALL UNDERGROWTH IS TO BE REMOVED. ONLY RUBBER TIRE EQUIPMENT SHALL ENTER THESE AREAS. REMAINING TREES SHALL BE PROTECTED FROM ROOT AND TRUNK DAMAGE.

DESIGNATES AREAS WHERE THE TYPE AND EXTENT OF CLEARING AND GRUBBING TO BE PERFORMED BY THE ENGINEER ACCORDING TO FIELD CONDITIONS.

DESIGNATES AREAS THAT SHALL REMAIN NATURAL WHEN IN THE OPINION OF THE ENGINEER THE EXISTING DESIRABLE NATURAL VEGETATION OR GRASS EXISTING AND THE LEVELING AND/OR CLEAN UP SHALL BE UNDERTAKEN TO PREPARE THE AREA FOR GRASSING OPERATIONS.

ALL OTHER AREAS NOT INCLUDED IN ONE OF THE ABOVE CATEGORIES OR THOSE DESIGNATED BY THE TYPICAL SECTIONS SHALL BE STANDARD CLEARING AND GRUBBING.

WHERE UNFORSEEN SITE CONDITIONS EXIST ADJUSTMENTS OR EXCEPTIONS MAY BE MADE TO THE ABOVE PROCEDURE AT THE DIRECTION OF THE ENGINEER.

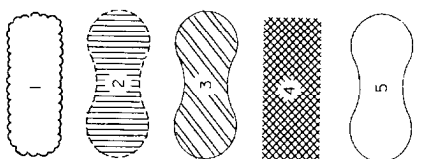

EXPLANATION OF SYMBOLS

SOIL INFORMATION DETAIL

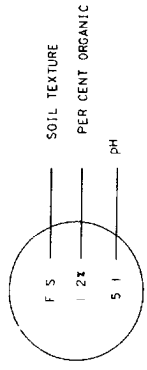

SOIL TEXTURE ABBREVIATIONS

DETAIL OF EXCEPTION

(APPLIES TO ALL TYPES OF SELECTIVE CLEARING)

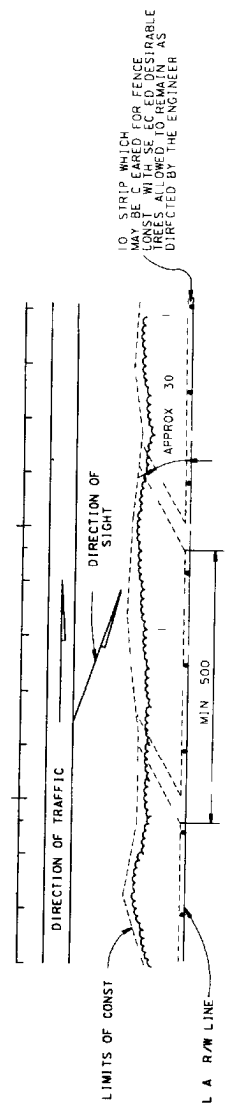

AT THE DIRECTION OF THE ENGINEER DIAGONAL P.A.S. MAY BE CUT IN AREAS TO REMAIN NATURAL AS SHOWN ABOVE FOR THE REMOVAL OF TIMBER AND STUMPS FROM THE AREA CLEARED FOR FENCE CONSTRUCTION.

SELECTIVE CLEARING AND GRUBBING EX 11-21-A

DATE	BY	REVISION	DATE	BY	REVISION	DATE	BY	REVISION	DATE	BY	REVISION

APPROVED BY: [Signature]

CHAPTER 22

APPROACH SLABS

22.1 General

The approach slab sheets are included in the plans set for projects involving bridges. These sheets shall be prepared in the responsible structural Design Engineer's office and shall be included in the roadway plans set. Approach slab sheets shall be the last sheets in the plans set, unless proprietary retaining walls are included in the package.

The Roadway Design Engineer must insure that the appropriate pay items are included in the CES.

CHAPTER 23

SIGNING AND PAVEMENT MARKING PLANS

23.1 General

Signing and pavement marking plans are usually a component set of plans. Projects with minor or typical signing and pavement markings may include these features on sheets in the roadway plan set or detailed on roadway sheets. When prepared as component plans they shall be assembled as a separate plans set complete with a key sheet, tabulation of quantities and all other signing and marking sheets. The sheets shall be numbered consecutively with the sheet numbers prefixed by the letter S.

23.2 Key Sheet

The key sheet is the first sheet in the set and shall be prepared on a standard key sheet format as mentioned in Chapter 3 of this volume. Contract plans set information shall not be required on this sheet when it is shown on the lead key sheet. A complete index of signing and pavement marking plans shall be shown on the left side of the sheet. Location map and length of project box need not be shown if this information is shown on the lead key sheet of the plans set. Other project data, approval signatures, consultant's name and DOT Project Manager/Coordinator's name shall be shown as described in Chapter 3 of this volume.

23.3 Tabulation of Quantities and Standard Notes

The tabulation of quantities sheet shall be prepared on the standard plan format and shall show quantities, standard sign numbers, pay item numbers and size of sign if not shown in plan for all bid items. The sheet shall be set up as shown in Exhibit II-23-A. Bid items shall be listed in numerical order and quantities shall be tabulated per sheet. Provision shall be made to show the original and final quantities. Standard notes referring to item numbers shall also be shown on this sheet.

On contracts with multiple project numbers or federal aid and non-federal aid quantities, provisions shall be made to tabulate and summarize their respective quantities.

23.4 General Notes

All general notes pertaining to signing and pavement marking may be shown on a separate plan format sheet, if necessary.

23.5 Plan Sheets

23.5.1 Format and Scale

The plan sheets shall be prepared on a standard plan format. The scale shall be such that all details are clear and legible at half size reduction of plans. The scale shall meet the requirements of Section 10.1 of this volume. For simple, uncomplicated projects, or sections of a project, it may be possible to "stack" two plans on one sheet, one below the other. Clarity and legibility shall be preserved in all cases. Refer to Exhibit EX-II-23-D for an example of signing and pavement marking plan.

A north arrow and graphic scale shall be shown at a point of maximum visibility on the sheet. If two plans are "stacked" on one sheet, then each plan portion shall contain a north arrow and graphic scale.

23.5 2 Required Information

The basic information pertaining to roadway geometrics and project limits required on the signing and pavement marking plan sheets is the same as that required on the plan portion of the plan - profile sheets (Chapter 10). Topography and construction details need not be shown. Utilities, drainage, lighting, sidewalks, driveways, etc shall be checked for conflicts. Only those that may may cause conflicts with sign placement shall be shown

All pavement markings shall be clearly shown and labelled with their widths, color and spacing specified. Either the begin and end pavement marking stations, with offset or the begin pavement marking station with offset and the total length of roadway for pavement marking shall be shown. The location of raised pavement markers and delineators shall be indicated by specifying the type, color, spacing, and limits of application by stations. All regulatory, warning and directional signs shall be shown at the proper locations. Each sign face shall be shown in close proximity to its respective sign with a leader line connecting the sign location and signface. Each sign face shall be oriented on the plan sheet to be read as viewed from the direction of travel along the roadway. The location of all signs shall be indicated by station or milepost. The Pay Item Number and standard sign designation, or assigned number if non-standard, shall be shown for each sign.

| Any signs to be mounted on signal span wires should be shown and listed
| on the signalization plan for illustration and placement purposes. Sign
| details should be included on the signing plans.

Begin and end stations shall be shown

23.6 Guide Sign Worksheet

The sign face, with the complete message layout with legend spacing (vertical and horizontal), margins, border widths and corner radii shall be shown on the guide sign worksheet. This sheet should be prepared on the standard plan sheet format to any convenient scale that will preserve clarity and legibility at half-size reduction of plans. For multi-support roadside signs, cross sections may not be included in the plans set, but the pole data shall be tabulated on the guide sign worksheet. Ex-II-23-F is an example of Guide Sign Work Sheet.

23.7 Overhead Sign Cross Section and Support Structure

The sign cross section sheet shows the location of overhead sign(s) in cross section. A standard profile format should be utilized. The cross section of the roadway at the sign location shall be shown and fully dimensioned. (See Exhibit II-23-E). The recommended scale for the cross section is 1" = 5' horizontally and vertically.

For overhead signs, the support truss and columns and foundations should be designed by the contractor from information shown on the sign cross section sheet.

23.8 Typical Pavement Marking Sheet

For simple, uncomplicated projects, or sections of a project, it may be possible to show signing and pavement marking plan details schematically using straight line diagrams and typical markings plan sheets. All regulatory, warning and directional signs shall be properly identified and shown at their graphic location on the straight line diagram. Pavement markings shall be shown and labelled on a typical marking plan. (see Exhibit II-23-C).

THIS EXHIBIT IS FOR EXAMPLE ONLY AND DOES NOT REFLECT THE DEPARTMENT S DESIGN CRITERIA

STATE PROJ NO. 00000_0000_S 0

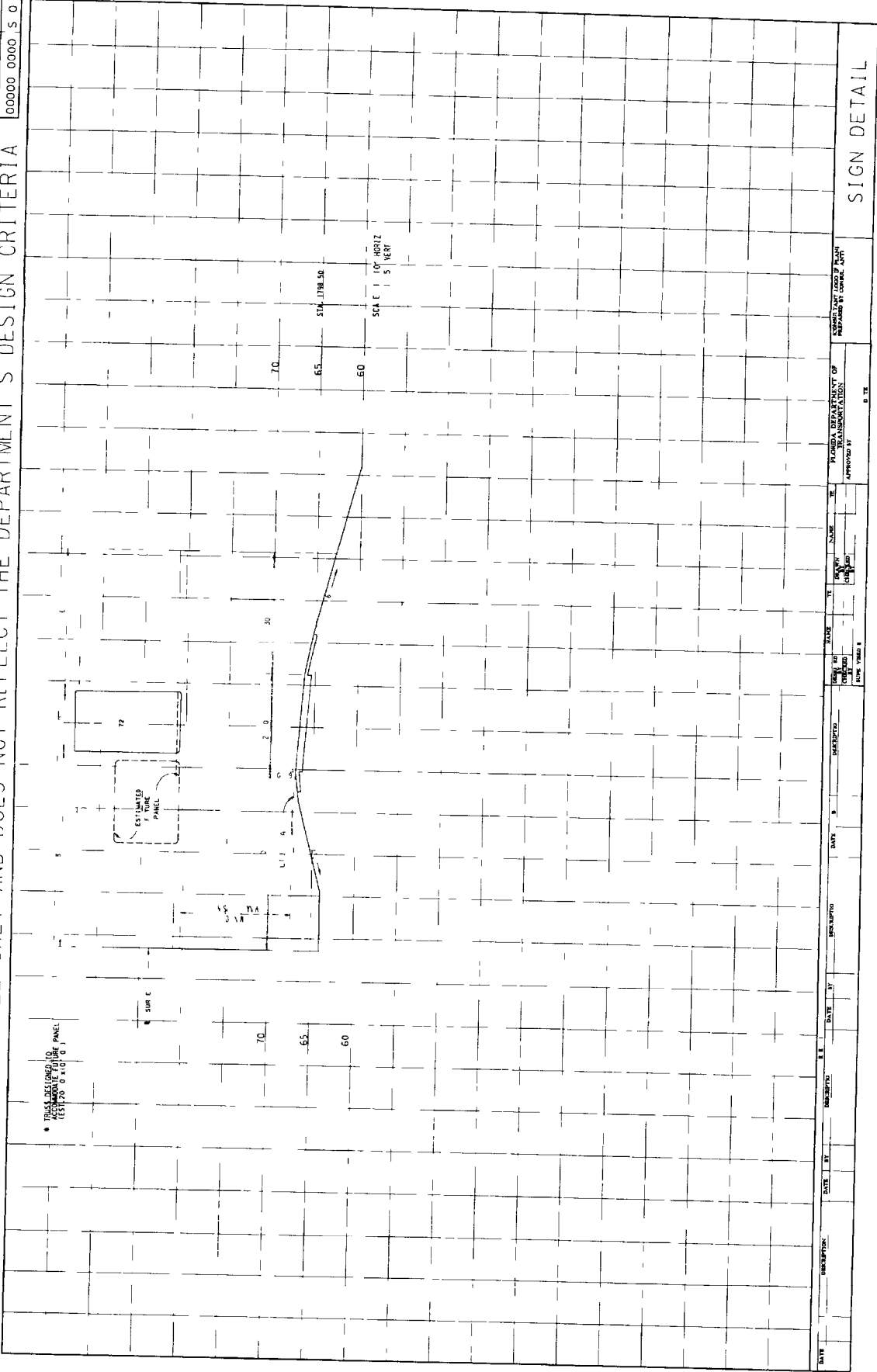

SIGN DETAIL

EX 111-23-E

DATE	DESCRIPTION	DATE	BY	REVISION	DATE	BY	REVISION	DATE	BY	REVISION	DATE	BY	REVISION
APPROVED BY _____ DATE _____													
PREPARED BY _____ DATE _____													

CHAPTER 24

SIGNALIZATION PLANS

24.1 General

Traffic Signal Plans are usually a component set of plans. Projects with minor or typical signalization may include these features on sheets in the roadway plan set or on the roadway sheets. When prepared as component plans they shall be assembled as a separate plans set complete with a key sheet, tabulation of quantities and all other relevant signal sheets. The sheets shall be numbered consecutively with the sheet numbers prefixed by the letter T.

The signalization plans show the complete construction details, electrical circuit, signal phasing and other relevant data.

24.2 Key Sheet

The key sheet is the first sheet in the component plans set and shall be prepared as described in Chapter 3 of this volume. However, the location map, length of project box and contract plans set information need not be shown if it is shown on the lead key sheet. The index of signal plans shall be shown on the left of the sheet. Other data shall be shown as described in Chapter 3 of this volume.

24.3 Tabulation of Quantities and Standard Notes

The tabulation of quantities sheet lists the item numbers, description and quantity of materials and type of work (i e , type signal equipment, and labor) This sheet shall be placed behind the key sheet in plans assembly

The tabulation of quantities sheet shall be set up as shown in Exhibit II-24-A Bid item numbers shall be listed in numerical order Provisions shall be made to show the original and final quantities per sheet Pay item footnotes and general notes that refer to item numbers, description of work to be performed and quantity estimates shall also be shown on this sheet

If space is limited, notes may be shown on the general notes sheet

On contracts with multiple project numbers, or federal-aid and non-federal-aid quantities, provisions shall be made to tabulate and summarize their respective quantities

24.4 General Notes

The general note sheet lists special signal design information such as controller operations, item number descriptions, loop installations, signal heads, signal poles, interconnect cable, maintenance of traffic and computer interface that is generally not covered in the FDOT Standard Specification Supplement or Special Provisions This sheet shall be placed behind the Tabulations of Quantities in the plans assembly On minor projects, general notes may be combined with the Tabulations of Quantities Sheet.

The general note sheet shall be set up as shown in Exhibit II-23-B. Bid number descriptions shall be listed in numerical order

24.5 Plan Sheets

24.5.1 Format and Scale

Signalization plans shall be prepared on standard plan format at a scale large enough to show all details clearly and legibly at half size reduction of plans. Usually, the complete intersection shall be shown on one plan sheet. However, for large intersections more sheets may be used with appropriate match lines. The standard scale is 1" = 20'. A north arrow and graphic scale shall be shown at a point of maximum visibility on the sheet. Refer to Exhibit Ex-II-24-B for an example of signalization plans.

24.5.2 Required Information

The basic information requirements include roadway geometrics, street names, construction stationing or mileposts curb-and-gutter, drainage inlets, sidewalks and right-of-way lines as similarly required on the plan portion of the roadway plan - profile sheets. Only those underground and overhead utilities, and roadway lighting structures that may cause construction conflicts with signal components shall be shown. All locations should be checked for potential conflicts.

The plan sheet shall also show:

- Signal head locations with directional arrows and movements (movements 2 and 6 shall be the major streets)
- Details of signal head in tabular form with pay item numbers
- Phasing diagram/signal operating plan
(NOTE: If the SOP conforms to the Standards Index #17870, then the reference to the index is all that is required. For all other operating plans, the plan shall be shown.)
- Signal controller timing chart
- Loop detectors
- Electrical service location
- Location of signal poles (ground elevation and elevation of roadway crown)
- Signal wire signs
- Pedestrian signals
- Turning radii
- Median nose locations
- Location of "stop bars" and pedestrian crosswalks
- Coordination unit-timing chart
- Lane lines with directional arrows

All equipment shown on the plan shall be clearly labelled and their respective item numbers and quantity indicated.

A separate signalization plan shall be prepared for each signalized intersection involved in the construction project

Any span wire mounted signs shall be shown for information purposes only and cross referenced to the appropriate signing and pavement marking plans

The sign details for signs must be included on the signalization plans, if signing and marking are not included in the plans package

24.6 Pole Schedule

The pole schedule sheet tabulates the pole design data. The pole schedule shall be prepared on standard plan format and shall be set up as shown in Exhibit II-24-B. This sheet shall be placed behind the signal plan sheets in the plans assembly.

This sheet shall provide a listing of each pole number. The following information shall be given for each pole:

- Location Number
- Pole Number
- Pole Type
- Pole Dimensions
- Item Number
- Quantity
- Joint Use Pole Details, if applicable

24.7 Interconnect/Communication Plan

The Interconnect/Communication plan is required when signal equipment is being coordinated with other signal installations or with a computerized system. The Interconnect/Communication plan shows pictorially the placement of interconnect/communication cable, either underground or aerial, and tabulates all related interconnect quantities. The Interconnect/Communication plan sheet shall indicate all signal poles, service poles, and/or joint-use poles to which interconnect/communication cable will be attached.

The interconnect/communication plan shall be prepared on standard plan format and shall be set up as shown in Exhibit II-24-C.

Unless otherwise approved, the preferred scale of the interconnect/communication plan shall be 1"=40' for underground cable and 1"=100' for aerial cable. For simple projects, or sections of a project, "stacking" two plans on one sheet is generally permitted if clarity and legibility are maintained.

A north arrow and graphic scale shall be shown at a point of maximum visibility on the sheet. If two plans are "stacked" on one sheet, then each plan portion shall contain a north arrow and graphic scale.

The basic plan information requirements include roadway schematic showing cross streets and driveways, cable information, pole location, pole number, utility pole identification number, bid item number and quantity.

THIS EXHIBIT IS FOR EXAMPLE ONLY AND DOES NOT REFLECT THE DEPARTMENT'S DESIGN CRITERIA

STATE PROJ. NO. 00000 00000 00
SHEET NO. 00

TABULATION OF QUANTITIES

BID ITEM NO	DESCRIPTION	UNIT	SHEET NUMBERS				TOTAL THIS SHEET	GRAND TOTAL	REFERENCE SHEET
			ORIG. F. FINAL	ORIG. F. FINAL	ORIG. F. FINAL	ORIG. F. FINAL			
620 1 1	GROUNDING ELECTRODE	LF	170				170		
630 1 12 4	CONDUIT UNDERGROUND	LF	200				200		
630 1 13 4	CONDUIT UNDER PAVEMENT	LF	328				328		
632 1 1	SIGNAL CABLE	PI							
634 4 112	SPAN WIRE ASSEMBLY	PI							
635 1 11	PULL BOXES	EA	5				5		
635 1 12	ELECTRIC POWER SERVICE ABOVE GROUND	AS	1				1		
641 16 448	CONCRETE STRAIN POLES (TYPE VIII)	EA	2				2		
650 1 131	TRAFFIC SIGNAL 12 (3 SECT 1 WAY)	AS	6				6		
650 1 132	TRAFFIC SIGNAL 12 (3 SECT 2 WAY)	AS	5				5		
653 1 11	PEDESTRIAN SIGNALS (12 INCANDESCENT) 1 WAY	AS	8				8		
659 101	SIGNAL HEAD AUXILIARIES (BACK PLATE 3 SECTION)	EA	10				10		
659 107	SIGNAL HEAD AUXILIARIES (ALUMINUM PEDESTAL)	EA	2				2		
660 1 101	VEHICLE DETECTOR (LOOP TYPE) AMPLIFIER WITH HARNESS	EA	8				8		
660 2 101	VEHICLE DETECTOR (LOOP TYPE) SAW CUTS AND LEAD INS	EA	20				20		
665 11	PEDESTRIAN DETECTOR POLE OR CABINET MOUNTED	EA	4				4		
670 113	CONTROLLED SOL ID STATE (ACTUATED) INCL CABINET	AS	1				1		
680 10	REMOVE TRAFFIC SIGNAL HEAD ASSEMBLY	EA	5				5		
680 30	REMOVE POLES	EA	2				2		
690 50	REMOVE CONTROLLER ASSEMBLY	EA	1				1		
690 60	REMOVE VEHICLE DETECTOR ASSEMBLY	EA	1				1		
690 80	REMOVE SPAN WIRE ASSEMBLY	EA	1				1		
690 90	REMOVE CABLE AND CONDUIT	PI	1				1		
690 100	REMOVE MISCELLANEOUS SIGNAL EQUIPMENT	PI	1				1		

* MEASURED AS LENGTH OF TRENCH FOR MULTIPLE RUNS

DATE OF PREPARATION: _____ DATE OF REVISION: _____ DATE OF APPROVAL: _____ DATE: _____

DESIGNED BY: _____ CHECKED BY: _____

APPROVED BY: _____

CONTRACT NO. _____

PROJECT NAME: _____

LOCATION: _____

DATE: _____

TABULATION OF QUANTITIES
TRAFFIC SIGNALS

EX 11 24 A

CHAPTER 25

HIGHWAY LIGHTING

25.1 General

Highway Lighting Plans are usually a component set of plans. Projects with minor or typical highway lighting may include these features on sheets in the roadway plan set or detailed on the roadway plans. When prepared as component plans they shall be assembled as a separate plans set complete with a key sheet, tabulation of quantities and all other relevant highway lighting sheets. The sheets shall be numbered consecutively with the sheet numbers prefixed by the letter L. The lighting plans shall show the complete construction details, electrical circuit, pole data, conduits, service points, luminaires, foundations, boring details and other relevant data.

A complete set of highway lighting plans shall include the following sheets:

- Key Sheet
- Tabulation of Quantities
- Pole Data and Legend Sheet
- Plans Sheet or Layout Sheet
- Foundation Details (High Mast)
- Boring Data Sheets (High Mast)

25.2 Key Sheet

The key sheet is the first sheet in the component plans set and shall be prepared as described in Chapter 3 of this manual. The location map, length of project box and contract plans set information need not be shown if it is shown on the lead (usually roadway) key sheet. Index of highway lighting plans shall be shown on the left of the sheet. Other data shall be shown as described in Chapter 3 of this volume.

25.3 Tabulation of Quantities and Standard Notes

The tabulation of quantities sheet lists the item numbers, description and quantity of materials and type of work (i.e., type, equipment, and labor). This sheet shall be placed behind the key sheet in plans assembly.

The tabulation of quantities sheet shall be set up as shown in Exhibit II-25-A. Bid item numbers shall be listed in numerical order. Provisions shall be made to show the original and final quantities per sheet. Pay item footnotes and standard notes that refer to item numbers, description of work to be performed and quantity estimates shall also be shown on this sheet. General notes shall be shown on a separate plan format sheet.

On contracts with multiple project numbers, or federal-aid and non-federal-aid quantities, provisions shall be made to tabulate and summarize their respective quantities.

25.4 Pole Data and Legend Sheet

The pole data sheet provides a great deal of information and shall be prepared on a standard plan format and shall be set up as shown in Exhibit II-25-B.

This sheet shall provide a listing of each pole by pole number. The following information shall also be given for each pole:

Circuit Number
Roadway Station and Offset
Arm Length
Luminaire Wattage
Mounting Height

The design values for light intensities and uniformity ratios shall be shown together with a legend and description of the symbols used on the plan sheets.

25.5 Plan Sheets

25.5.1 Format and Scale

The plan sheets shall be prepared on a standard plan format. The scale shall be such that all details are clear and legible at half-size reduction of plans. However, the scale shall not be smaller than 1" = 100'. For simple, uncomplicated projects, or for narrow sections of a project, it may be possible to "stack" two plans on one sheet, one below the other. Clarity and legibility shall be preserved in all cases.

A north arrow and graphic scale shall be shown at a point of maximum visibility on the sheet. If two plans are "stacked" on one sheet, then each plan portion shall contain a north arrow and graphic scale.

25.5.2 Required Information

The basic information pertaining to roadway geometrics and project limits required on the highway lighting plan sheets is the same as that required on the plan portion of the plan - profile sheets. Topography and construction details need not be shown. Utilities, drainage, signal structures, sidewalks, driveways, etc. shall be checked for conflicts. Only those that may cause conflicts shall be shown.

The lighting design or lighting layout shall be shown on the plan format. This shall be accomplished by symbols which represent poles, conduits and service points. The symbols used shall be unique for a particular item and shall be used throughout the plans. A flag or note shall be used to identify conduit runs with conductor size or numbers different than that shown on the pole data sheet legend.

The symbols for poles shall be shown at the correct baseline station and the approximate offset from the roadway noted.

The poles shall be flagged and specific information for each pole shall be shown. The pole number, baseline station, circuit number and offset from baseline (for high mast) shall be shown.

The service point locations shall be shown on the plan sheets as determined through utility negotiations. Design Standard 17504 provides details for the service point. The service point shall be shown at the location where it is to be installed. The following information is not covered on the standard and must be shown on the plan sheet:

Description—voltages, phases, etc.

example: 240/480 Volt, 3 wire, Overhead

Breaker sizes—The main breaker size and the number of branch circuits and the breaker size of each.

25.6 Foundations and Boring Detail Sheets

The foundation design and the details for the height of conventional poles are shown in the Roadway and Traffic Design Standards and need not be shown in the lighting plans. Foundations for high mast poles are designed by the responsible Structural Engineer's office.

Plans showing the foundation details and boring data for high mast poles shall be included in the lighting plans.

THIS EXHIBIT IS FOR EXAMPLE ONLY AND DOES NOT REFLECT THE DEPARTMENT'S DESIGN CRITERIA.

STATE PROJ. NO. 00000 0000L 0

TABULATION OF QUANTITIES

BID ITEM NO	DESCRIPTION	UNIT	SHEET NUMBERS																				TOTAL THIS SHEET			GRAND TOTAL			REF SHEET					
			L 4		L 5		L 6		L 7		L 8		L 9		L 10		L 11		L 12		L 13		L 14		L 15		TOTAL	THIS		SHEET	GRAND	TOTAL	REF	
			PLAN	FINAL	PLAN	FINAL	PLAN	FINAL	PLAN	FINAL	PLAN	FINAL	PLAN	FINAL	PLAN	FINAL	PLAN	FINAL	PLAN	FINAL	PLAN	FINAL	PLAN	FINAL	PLAN	FINAL	PLAN	FINAL		PLAN	FINAL	PLAN	FINAL	
620 1 1	GROUND ELECTRODE	LF	40		110		50		100		100		50		20		20		60		140		140		140		140		140		1040		1040	
715 1 113	CONDUCTOR (INSULATED) (NO. 6)	LF	2272		2716		2549		3156		3156		2373		1008		2961		3256		5240		5240		4288		39828		39828		39828		39828	
715 1 123	CONDUCTOR (BARE) (NO. 6)	LF	1136		1209		1275		1344		1187		504		1481		2386		2314		2431		1980		18563		18563		18563		18563		18563	
715 2 113	CONDUIT (UNDERGROUND) (PVC SCH. 40) (1 1/4")	LF	990		1151		1055		954		1022		480		1348		2112		2085		2108		1836		16394		16394		16394		16394		16394	
715 2 213	CONDUIT (UNDER PAVT.) (PVC SCH. 40) (1 1/4")	LF	92		0		159		376		108		0		62		160		119		207		50		1283		1283		1283		1283		1283	
715 2 435	CONDUIT (JACKETED) (RIGID GAL. STEEL) (2")	LF	0		114		0		132		0		0		0		154		219		120		104		843		843		843		843		843	
715 411 140	LIGHTING POLE COMPLETE (SINGLE ARM) (ALUM.)	EA	4		7		5		6		5		2		6		10		11		10		11		82		82		82		82		82	
715 414 140	LIGHTING POLE COMPLETE (DBL. ARM) (ALUM.)	EA	0		0		0		0		0		0		0		0		0		0		0		0		0		0		0		0	
715 7 12	LOAD CENTER (PRIMARY VOLTAGE)	EA	0		0		0		1		0		0		0		0		0		0		0		1		1		1		1		1	
715 14 11	PULL BOX (ROADSIDE)	EA	0		4		0		2		0		0		0		4		4		4		2		20		20		20		20		20	

DATE: _____ BY: _____

DESCRIPTION: _____ DATE: _____

REVISIONS: _____ DATE: _____

APPROVED BY: _____ DATE: _____

FLORIDA DEPARTMENT OF TRANSPORTATION

APPROVED BY: _____ DATE: _____

TABULATION OF QUANTITIES

EX 11-25-A

THIS EXHIBIT IS FOR EXAMPLE ONLY AND DOES NOT REFLECT THE DEPARTMENT'S DESIGN CRITERIA

STATE PROJ. NO. 00000 00000 L 0

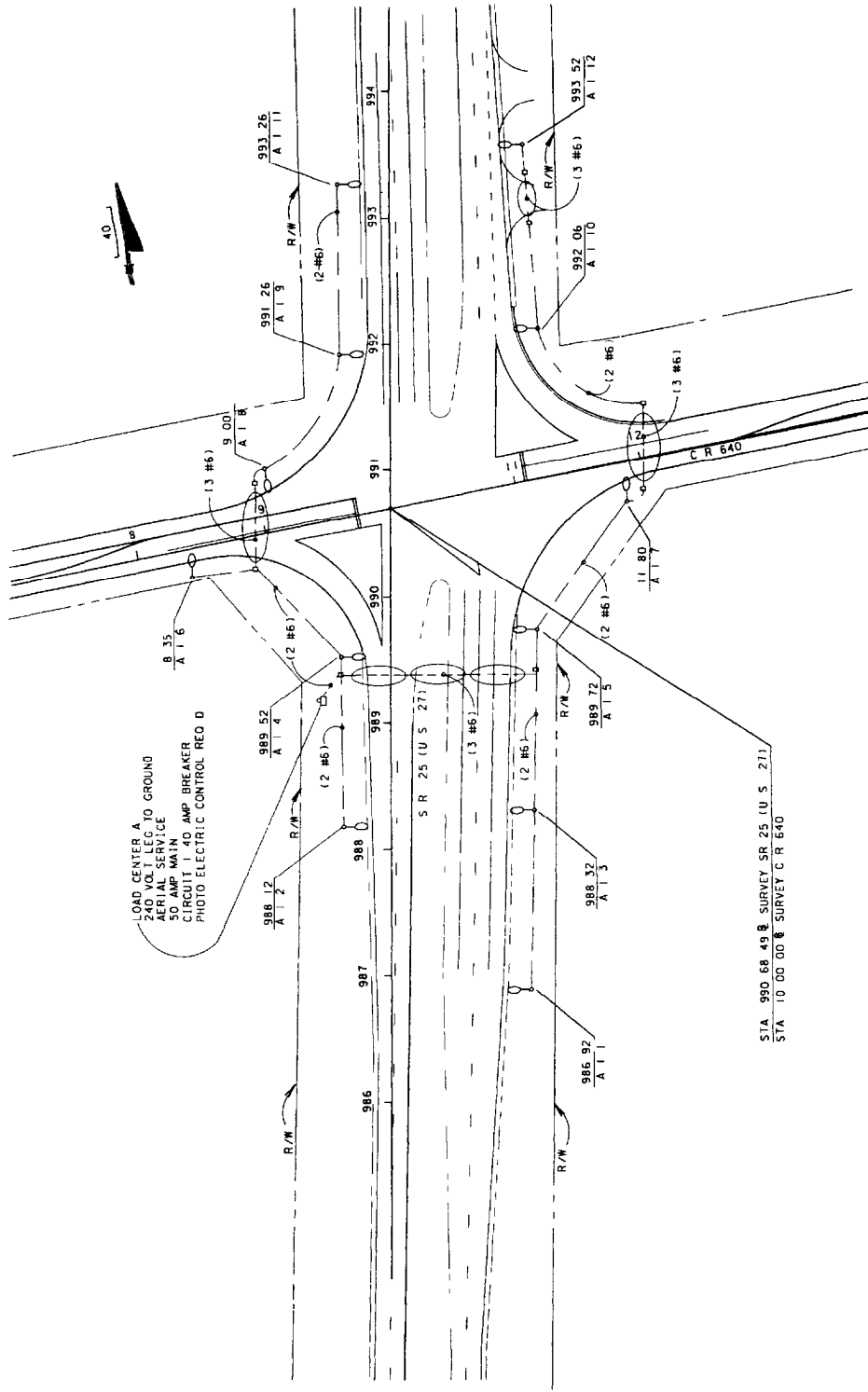

LOAD CENTER A
240 VOL. LCC TO GROUND
AERIAL SERVICE
CIRCUIT WITH 40 AMP BREAKER
PHOTO ELECTRIC CONTROL RED D

STA 990 68 49 8 SURVEY SR 25 (U.S. 271)
STA 10 00 00 8 SURVEY C R 640

DATE	BY	DESCRIPTION	DATE	BY	DESCRIPTION	DATE	BY	DESCRIPTION	DATE	BY	DESCRIPTION

PLANNED DEVELOPMENT OF
TRAIL DEVELOPMENT
APPROVED BY DATE

GENERAL CONTRACTOR'S PLAN
REVISIONS BY DATE

LIGHTING PLANS
EX 11 25 D

THIS EXHIBIT IS FOR EXAMPLE ONLY AND DOES NOT REFLECT THE DEPARTMENT'S DESIGN CRITERIA

REV.	DATE	BY	CHKD.	APP'D.
3	FLA	00000-0000		L-0

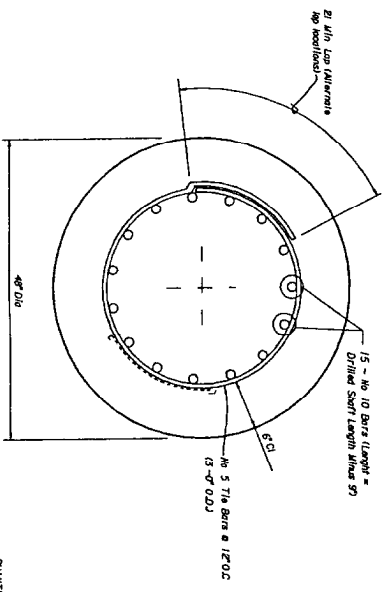
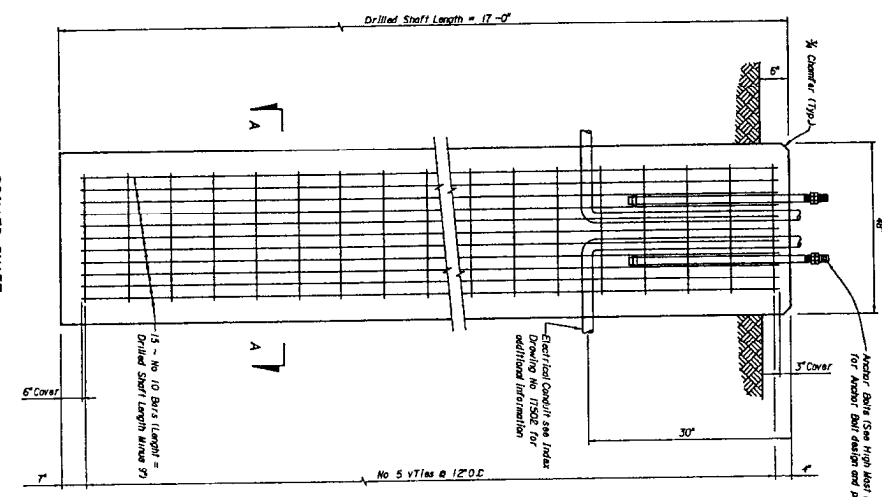

GENERAL SPECIFICATIONS

DESIGN SPECIFICATIONS

DESIGN LOADINGS

MATERIAL STRESSES

CONCRETE

REINFORCING STEEL

ANCHOR BOLTS

DESIGN REACTIONS

Florida Department of Transportation Standard Specifications for Road and Bridge Construction, dated 1985 and Supplements thereon if used in the Standard Specifications for 1985.

Design in accordance with the 1985 edition of the AASHTO Standard Specifications for Highway Structures, Part 1, Section 10.01, and Section 10.02, and the 1985 edition of the AASHTO Standard Specifications for Highway Signs, Luminaires and Traffic Signals (SSS) with approved Revisions.

Basic Wind Velocity of 80 M.P.H. on 120 Ft High Mast Luminaires.

Atmospheric Exposure of 4 in accordance with current AASHTO Standard Specifications for all the materials shown in the Plans.

Class III (0-35,000 p.s.f.) & B3 Dags

Reinforcing Steel shall be Grade 60

For member diameter length and bar strain placement of Anchor Bolts, See Approved Specifications and Drawings. Anchor Bolts shall be designed to resist the full design load. The design load shall be the maximum load governed in accordance with ASCE 41.5.3 except that anchor bolts fabricated of a material having a yield strength greater than 60,000 p.s.f. shall be designed on the basis of the design yield strength of the material.

The Contractor shall be responsible for Assuring that the Anchor Bolts fit within the Reinforcing Cage of the Drilled Shaft.

The Contractor may increase the Drilled Shaft Foundation Diameter and Anchor Bolt Size to the extent of a design change.

The Contractor shall be responsible for the design of the foundation. The Contractor shall be responsible for the design of the foundation. The Contractor shall be responsible for the design of the foundation.

The Contractor shall be responsible for the design of the foundation. The Contractor shall be responsible for the design of the foundation. The Contractor shall be responsible for the design of the foundation.

DRILLED SHAFT
10 - REQUIRED

QUANTITIES: Cast in-situ concrete = 4654 CF
Reinforcing Steel = 7810 Lbs
Per Lin Ft of Drilled Shaft Length

NO.	BY	DATE	DESCRIPTION	FORM NO.	SCALE	ENGINEER OF RECORD	LOCAL	STATE	PROJECT NO.	DATE	PROJECT TITLE	DATE
											HIGH MAST POLE FOUNDATIONS	

FV-11-95-F

THIS EXHIBIT IS FOR EXAMPLE ONLY AND DOES NOT REFLECT THE DEPARTMENT'S DESIGN CRITERIA.

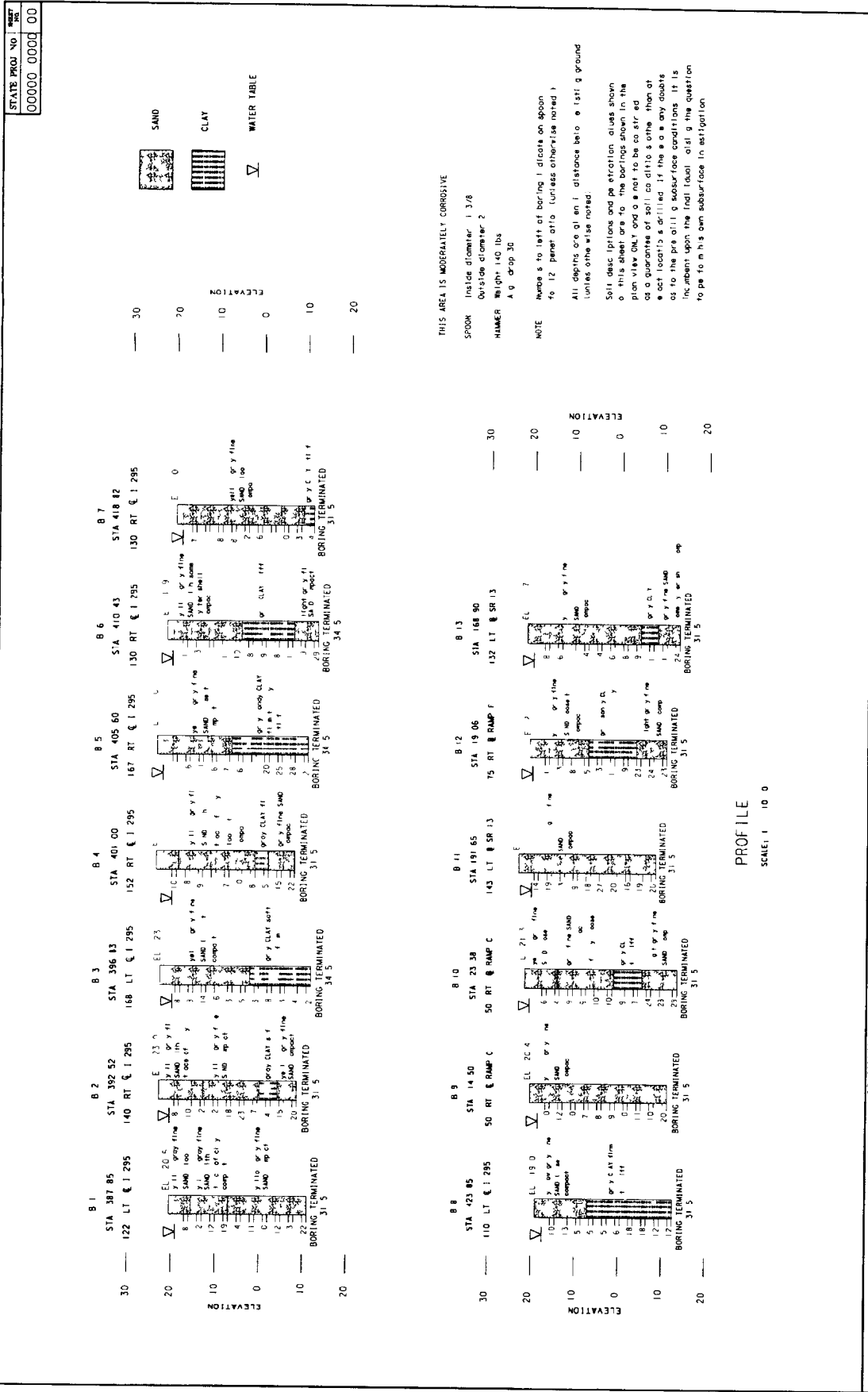

DATE	BY	DESCRIPTION	DATE	BY	DESCRIPTION	DATE	BY	DESCRIPTION

PROFILE
SCALE: 1" = 10' 0"

BORING DATA
HIGH MAST LIGHTING
EX-11 25-H

CHAPTER 26

HIGHWAY LANDSCAPE

26.1 General

Highway landscaping plans are usually a component set of plans. Projects with minor or typical landscaping may include these features on sheets in the roadway plans set or detailed on roadway plans. When prepared as a component set they shall include a key sheet, tabulation of quantities sheet, planting details and notes sheet, and other relevant plan sheets as outlined in this chapter. Sheets shall be numbered ~~consecutively~~ ^{consecutively} with the sheet number prefixed by the letters LD.

26.2 Key Sheet

The key sheet is the first sheet in the set and shall be prepared on a standard key sheet format as mentioned in Chapter 3 of this volume. Contract plans set information shall not be required on this sheet when it is shown on the lead key sheet (usually roadway). Location map and length of project box need not be shown if this information is shown on the lead key sheet of the plans set. Other project data, approval signatures and consultant names shall be shown as described in Chapter 3 of this volume.

Responsible Landscape Architect's approval signature and seal shall be included in appropriate locations on the landscaping plans.

26.3 Tabulation of Quantities

The tabulation of quantities sheet shall be prepared on a standard plan format and shall show all bid items, the breakdown of plants or materials within each bid item as applicable, the quantities of each, and the total quantities for all bid items. Bid items shall be listed in numerical order. Plant quantities may be tabulated by sheet either on this or on a separate sheet of "Quantities by Sheet". Notes referring to specific bid items or plant materials should be shown on this sheet. Notes of a more general nature may be shown on this sheet or on the Planting Details and Notes sheet. This sheet or a similar sheet should also be utilized to tabulate the materials required for the construction of sprinkler irrigation systems. This sheet should be set up similar to that shown in Exhibit II-26-A.

On contracts with multiple project numbers or federal aid and non-federal aid quantities, provisions shall be made to tabulate and summarize their respective quantities.

26.4 Standard Details and Notes

This sheet should be included in all landscape plan sets and show all standard details which are applicable to the project. General notes and additional landscaping and/or sprinkler irrigation detail drawings may also be shown on this sheet. The following note should appear on this or the tabulation of quantities sheet:

"The locations of plants, as shown in these plans, are approximate. The final locations may be adjusted to accommodate unforeseen field conditions, to comply with safety setback criteria, to avoid creating unsafe sight conditions, or as otherwise directed or approved by the Engineer."

26.5 Plan Sheets

26.5.1 Format and Scale

The various plan sheets shall be prepared on a standard plan format. The scale shall be such that all details are clear and legible at half-size reduction of plans. However, the scale shall not be smaller than 1" = 100'. For simple, uncomplicated projects, or narrow sections of a project, it may be possible to "stack" two plans on one sheet, one below the other. Clarity and legibility shall be preserved in all cases.

A north arrow and scale shall be shown, as applicable, at a point of maximum visibility on the sheet. If two plans are "stacked" on one sheet, then each plan portion shall contain a north arrow and scale.

26.5.2 Plan Sheets

Base information required on the plan sheets is as follows:

Project Centerline

Edge of Pavement (edge of driving lanes)

Drainage Structures

Guardrails

Right-of-way and/or Limited Access Fence Line

Sidewalks or other planned or existing structures

Overhead and Underground Utility Locations, if known

Limits of Clear Zone should be plotted or safety setback distances noted frequently on each plan sheet

Plants shall be identified by their common name and quantity, either individually or in groups. Abbreviations of plant names are acceptable, if properly identified on the tabulation of quantities sheet.

For an example of a landscaping plan sheet, see Exhibit II-26-C.

CHAPTER 27

UTILITY CONTRACT PLANS

27.1 General

Most utility adjustment work is performed by the utility owner. In some cases the highway contractor is required to construct or relocate utilities for the project. In such cases utility plans shall be prepared as a separate plan component, complete with key sheet and summary of pay items.

27.2 Key Sheet

The key sheet, which shall be the first sheet in the set, shall be prepared on a standard key sheet format as described in Chapter 3 of this volume. Contract plan set information, location map and length of project box shall not be required if it is shown on the lead key sheet (usually roadway). An index of plan sheets shall be shown on the left side of the sheet. The job number shown shall be the 6000 series to indicate utility work. All other data shall be as described in Chapter 3 of this volume.

27.3 Summary of Quantities, Standard Notes and Summary of Pay Items

The summary of quantities sheet shall be prepared on standard plan sheets and should show any quantities tabulated for location, size, etc. Standard notes referring to item numbers shall also be shown on this sheet or on plan sheets if no summary of quantities sheet is included.

Summary of pay item sheets are to be prepared the same as noted in Chapter 4.

27.4 Plan Sheets

Utility plans shall show full construction details for all utilities to be relocated or constructed by the contractor. Plan and profile sheet format should be utilized. Project information shown shall be similar to that described in Chapter 10. Utilities to be relocated or constructed shall be shown by a heavy solid line in plan and profile. The scale used should be the same as that used for the plan-profile sheets.

APPENDIX A

GLOSSARY OF TERMS

AADT	Average Annual Daily Traffic.
ADE	Area Design Engineer
ADT (two way)	Average Daily Traffic.
Approach Slab	A section of a roadway adjacent to, and at the end of a bridge, requiring special design and construction considerations.
Arterial	A general term denoting a highway primarily for through traffic, usually on a continuous route.
A-2 or A-3 Material	Materials consisting of sands deficient in coarse materials and soil binder.
A-8 Material	A national classification of a type of unsuitable material.
Base course	The layer or layers of specified or selected material of design thickness placed on a subbase or subgrade to support a structural course.
Baseline	An accurately measured line from which the position of other points may be determined, or on which a survey may be based.

Benchmark	A relatively permanent object, natural or artificial, bearing a marked point whose elevation above or below an adopted datum is known.
BHRS	Bridge Hydraulic Recommendation Sheet.
Bifurcated Section	A section of a divided roadway separated by a very wide area of natural ground.
Border Width	A term usually used in conjunction with urban roadway cross section denoting the width of cross section from the face of curb to the right-of-way.
Borrow or Borrow Material	Material excavated from designated areas for use as 'fill'.
Borrow Pit	An excavation site outside the limits of a roadway for producing material necessary for roadway construction.
Bridge Culvert	Culverts whose dimensions exceed a 20' distance measured along project centerline between the inside faces of exterior walls..
Bulkage	Increase in soil volume due to manipulation.
CADD	Computer Aided Design and Drafting.

Catagorical Exclusion:	Projects that may be excluded from the Environmental Impact Process due to the type of work involved - example resurfacing projects.
Centerline	The axis along the middle of a road or other facility from which features can be conveniently measured.
CES	Cost Estimating System - The Department's program for estimating construction costs for projects.
Channalization	Usage of traffic islands and other devices to direct traffic into definite paths.
Clear zone	A traversable and unobstructed roadside area available for errant vehicles to safely regain control.
Clearing and Grubbing	Process of clearing the roadway construction site of unwanted features.
Collector	A general term denoting a roadway that links neighborhoods or areas of homogeneous land use with arterial streets.
Compound Curve	A curve consisting of two or more arcs of different radii curving in the same direction and having a common point.

Contract	A legal document stating the terms and conditions of an agreement between the Department and a private company to provide a service.
Contract Time	Number of calendar days allowed for completion of the contract, including authorized time extensions.
Contractor	An individual or company that undertakes to provide service specified in contract documents.
Control Radius	Radius by which a turning vehicle can maneuver with the least amount of difficulty.
Crest Vertical Curve	A convex parabolic curve providing a smooth transition between two grades.
Cross Slopes	Lateral slope given to the pavement to provide adequate drainage.
Cross Drain	A drainage structure utilized to convey water from one side of the roadway to the other, including median drains and culverts under intersecting streets.
Crown Line	The inside top of a culvert.
Culverts	A round or special shaped pipe or box used to convey water, especially under roadways or other facilities.

Curb Returns	The curved portion of the curb at which driveways and cross roads intersect with a roadway.
Cut	That portion of a road site where the formation has been excavated below ground level.
Datum	A known or measured point, line or plane to which others may be referred for vertical or horizontal control.
Delineator	Reflector units capable of clearly reflecting light under normal atmospheric conditions from a distance of 1000 feet when illuminated by the upper beam of standard automobile lights.
Design Speed	A speed determined for design and correlation of the physical features of a highway that influence vehicle operation.
Design Exception	Approved deviation from AASHTO or Department criteria.
Detention Area, Basins, and Pond	Drainage basins specially constructed and used to retard stormwater, discharging at a controlled rate for a specific period of time.
DHV	Design Hourly Volume - the traffic volume on which the functional design of a highway is based.

DPI	Ditch Point of Intersection of ditch grades.
Drainage Areas	The portion of the land surface which drains to a specific point, including paved areas, roofs and unpaved land.
Drainage Divides	The area of higher ground separating drainage areas or basins.
Driver Expectancy	A condition whereby drivers are conditioned, by encounters with repetitive features, to expect a certain driving environment. When that environment is provided, driver reaction is very predictable. When expectancy is violated, drivers may react slowly or improperly.
DHW	Design High Water elevation.
Earthwork	The excavation and filling required to construct embankment.
EIS	Environmental Impact Statement
Embankment	The constructed earth fill and excavation built to carry a road.
ESAL	Equivalent single axle load.
Esthetics	Visual impact of the roadway environment on drivers and other vehicle occupants.

Excavation	Removal of all materials of whatever nature to complete earthen cuts, ditching, sub-excavation and borrow pits.
Exceptions	Those portions of the roadway within the project limits that are excluded.
Fill	A portion of the proposed cross section which falls above the existing groundline and indicating volume of fill.
Flow Line	The inside low point or lowest line of water flow in an open gutter, swale, ditch or other drainage element.
Freeway	An expressway with fully controlled access - the highest type of arterial highway.
Friction Course	The top layer of an asphalt pavement to provide resistance to skidding, traffic abrasions and the disintegrating effects of climate.
Functional Classification	Classification of highways by design types based on the major geometric features.
F.A.	Federal Aid - used in conjunction with projects having Federal Aid funds.
Geometrics	Visible elements of a roadway, such as alignment, grades, sight distances, widths, slopes, etc.

Grade	A rate of rise or fall on any length, with respect to horizontal.
G.M.	Gross Mile.
High mast	Free standing poles or towers of height 80' or more utilized for highway lighting to provide uniform, and glare free, light distribution over large areas of highway.
30th Highest Hourly Volume	The hourly volume that is exceeded by 29 hourly volumes during a designated year.
Imagery	Visible representation of characters, line drawings and symbols.
K, D and T Values	K: Ratio of DHV to ADT. D: Directional distribution of DHV expressed as a percentage. T: Percentage of trucks, inclusive of light delivery, expressed as percentage of DHV.
Lane Taper	Divergence of lane edge for the purpose of adding or dropping lanes.
Lane Transition	Lateral shift of a travel lane.
Lateral Ditch	A ditch which runs more or less perpendicular to the centerline of roadway.

LER	Limerock Bearing Ratio - specifies load bearing capacity of the material, as related to that of limerock.
Level of Service:	A qualitative rating of the effectiveness of a highway in serving traffic, measured in terms of operating conditions.
Leveling Course	One or more layers of asphalt mix used to restore a distorted existing pavement to a uniform cross section and an acceptable level of rideability.
Limited Access R/W	The Right-of-Way wherein the right of owners or occupants of abutting land, or other persons to access a highway facility is limited to designated points, such as interchanges.
May	Permissive condition.
MUTCD	Manual of Uniform Traffic Control Devices.
MUTS	Manual on Uniform Traffic Studies.
Mylar	Polyester film used as reproducible drafting media.
National Sign Code	Code numbers assigned to standard road signs.
N.M.	Net mile.

Overbuild	Multiple layers of asphalt mix used to build up one side of an existing crown to provide a uniform cross-slope.
Overland Flow	Diffused surface flow of water.
Overlay	The construction of a structural course and, if necessary, leveling course and overbuild course, to increase the source life and improve the rideability of an existing pavement.
Overtopping Elevation	Elevation at or above which water will flow over a structure, the highway grade or a drainage divide.
Pavement Design	Description of the types and thicknesses of various layers constituting a pavement structure.
Pay Item Number	Number assigned by the Department to construction components for pay purposes.
PC Station	Point of Curvature Station - The station at the beginning of a horizontal curve.
PD & E Study	Project Development and Environmental Study.

Photogrammetry	Photographic process of topographic mapping using stereographic plotters.
PID	Plans In District.
PI Station	Station of the Point of Intersection of two tangents.
Plans	The approved plans, including reproductions thereof, showing the location, character, dimensions and details of the work to be done.
Posted Speed	Regulatory speed limit established in accordance with department policy and posted on the roadway.
Profile Grade Line	A longitudinal line which controls the vertical geometry of the project, usually the inside edge of a divided highway or the centerline of an undivided highway.
Profile Grade Point	A specific point along the Profile Grade Line.
PS & E	Plans, Specifications and Estimate.
PT Station	Point of Tangent Station - station at the termination of a horizontal curve and at the beginning of the tangent.

Quality Assurance

Is all planned and systematic actions necessary to provide adequate direction so that all resulting design products can meet predetermined requirements. This includes the establishment of design policies, procedures, standards, guidelines, training and monitoring for compliance.

Quality Control

Following established design policies, procedures, standards and guidelines in the preparation of all design products. This includes the checking and review of individual designs for compliance and good engineering practice.

Ramp

That portion of the traveled way connecting two roadways at a grade separated intersection.

Range

An area of 36 square miles enclosed between nationally established survey lines running north-south, six miles apart, and township lines.

Recovery Area

See "Clear Zone".

Reference Points

One of several fixed objects for which measurements are made to enable a point to be accurately located.

Resurfacing	A supplemental or replacement surface placed on an existing pavement to improve its surface or increase its strength.
Retention Area, Basin or Pond	A drainage facility designed to retain runoff without a direct outlet discharge structure.
Returns	That extension of the roadway which allows entrance and exit to sidestreets, parking lots, etc.
Reverse Curve	A combination of two horizontal curves in opposite directions with a common tangent.
3R	Resurfacing, Restoration, Rehabilitation of a roadway.
R/W	The areas, existing or acquired by permanent easement, for highway purposes.
Sag Vertical Curve	A concave parabolic curve providing a smooth transition between two grades.
Section Lines	Established survey grid lines enclosing approximately a one mile square area of land.
Shall	Mandatory condition.
Shop Drawings	Detailed drawings of elements requiring special fabrication.

Should	Advisory condition.
Shoulder	The portion of the roadway contiguous with the traveled way and used for lateral support of base and surface courses, emergencies and safe recovery of errant vehicles.
Shrinkage	Reduction in volume of soil mass.
Sidedrain	A drainage structure placed more or less parallel to the centerline of a roadway for conveyance of water under driveways, and other such obstructions.
Soil Survey	The exploring and recording of soil types and conditions.
Special Ditch	Roadside ditch whose dimensions do not conform to those shown on the typical section.
Special Provisions	Special directions, provisions or requirements peculiar to the project under consideration and not otherwise thoroughly or satisfactorily detailed or set forth in the specifications.
Specifications	Document containing the directions, provisions, requirements and stipulations relating to the method and manner of performing the work.

Speed Change Lanes	Special lanes provided for the use of accelerating or decelerating vehicles.
Station Equations	Station along an alignment where the numerical continuity is broken.
Storm Sewer or Storm Drain	Pipe system or portion thereof used to collect or convey storm water runoff.
Stabilizing	Process by which the subbase is brought up to a bearing value sufficient to support the base.
Structural Course	One or more layers of asphalt mix placed to provide the major structural component of the pavement or to increase the service life of an existing pavement.
Subbase	The layer or layers of specified or selected material of designated thickness placed on a subgrade to support the basecourse.
Subgrade	The top surface of a roadbed upon which the pavement structure and shoulders are constructed.

Superelevation	A tilt given to a road at a horizontal curve to counteract the effect of centrifugal force.
Superelevation Transition	Transition of a cross section from normal cross slope to full superelevated cross slope, or vice versa.
Surface Course	One or more layers of a pavement structure designed to accommodate traffic load.
Survey Reference Points	Same as reference point.
Template	The sum of elements of widths, depths and cross slopes which define the roadway cross section.
Topography	Representation, on a plan, of the existing physical features in an area.
Township	An area of 36 square miles enclosed between nationally established survey lines running east-west, six miles apart, and range lines.
Travelway	The portion of the roadway for the movement of vehicles, exclusive of shoulders and auxiliary lanes.

Traversable	Crashworthy roadside conditions that would allow an errant vehicle to regain control without serious damage.
Turning Radius	Outside wheel path of a turning vehicle.
Typical Section	Shows the design elements for the cross section of a proposed roadway.
Underdrains	A subsurface drainage system.
Unsuitable Material	Types of dirt that are classified unsuitable for roadway construction.
Value Engineering	An analysis of materials, processes and products in which functions are related to costs and from which a selection may be made for the purpose of achieving the required function at the lowest overall cost consistent with the requirements for performance reliability and maintainability.
Vellum	Translucent paper used as reproducible drafting media.
Vertical Curve	A parabolic curve used to give smooth transition between tangent grade-change.

Weaving Movement

The crossing of traffic streams moving in the same general direction, accomplished by merging and diverging.

W.P.I. Number

Work Program Item number (assigned by the Department).

VOLUME II

PLANS PREPARATION AND ASSEMBLY

Abbreviations	1-1
Alignment Sheet Sequence	9-2
Alternative	14-4
Approach Slabs	2-26, 10-7, 22-1
Approval Signature	3-8
Back-of-Sidewalk Profile	2-12, 2-18, 12-1
Base Sheet Format	1-3
Bar Scale	3-6
Boring Data	17-2
Boring Detail	25-7
Borrow Pit Soil Survey	2-21, 17-3
Box Culvert Data Sheet	7-2
Bridge Hydraulic Recommendation Sheet	5-2
Bridge Hydraulics Report	5-2
Bridges	10-7
Centerline	10-2
Component Plan Sets	2-1
Component Set	23-1, 24-1, 25-1, 26-1
Construction Limits	10-6
Consultant's Name	3-8
Contract Plans Set	2-1, 3-6
Corner Monument	10-17
Cross Section	2-4, 2-13, 2-22, 18-1
Cross Section Pattern Sheet	2-21, 13-7
Cross Slopes	6-3
Curb Returns	11-3
Curve Data	10-3

Data Collection	2-2
Design Speed	6-3
Ditch Cross Sections	15-6
Drainage Elements	8-2
Drainage Features	10-12
Drainage Map	2-9, 2-16, 5-1
Drainage Structures	2-19, 10-7, 14-1
Drainage System	10-7
Earthwork	18-3
Engineer(s) of Record	3-9
Existing Groundline	10-10
Existing Topography	2-2, 10-4
Federal Project Numbers	3-2
Field Data	2-2
Fiscal Year	3-2
Flood Discharge	5-2
General Notes	9-3, 10-16, 23-2, 24-2
Governing Specifications	3-10
Grades	10-12
Guide Sign Worksheet	23-5
High Water Elevations	10-10
Highway Landscaping Plans	26-1
Highway Lighting	25-1
Highway Lighting Plans	2-25
Horizontal Curves	10-3
Horizontal Geometrics	2-3
Index of Sheets	3-6
Interchange Detail	2-12
Interchange Drainage Map	2-10, 2-16, 5-8
Interchanges	13-3
Interconnect/Communication Plan	24-7
Intersection & Interchange Details/Layouts	13-1
Intersection Layout	2-12, 2-19

Intersections	11-2, 13-2
Key Sheet	2-8, 2-15, 3-1
Landscape Plans	2-26
Landscaping	26-1
Lateral Ditch	15-1, 15-2, 15-3
Lateral Ditch Cross Sections	2-21, 15-1
Legibility Guidelines	1-1
Length of Project Box	3-3
Lighting Design	25-5
Lighting Plans	25-1
Location Map	3-2, 3-4
Loop Detectors	24-4
Mylar	1-3
North Arrow	3-6
Outfall	15-1, 15-2, 15-4
Outfall/Lateral Ditch System	2-20, 15-1
Overhead Sign Cross Section	23-5
Pavement Markings	23-4, 23-5
Pay Item Notes	7-5
Pay Items	2-15, 4-1
Pedestrian Signals	24-4
Phase Submittals	2-5
Phasing Diagram	24-4
Plan and Profile	2-11, 2-17
Plan Layout	10-8
Plan Revisions	3-11
Plan Sheet Format	1-5
Pole Data	25-3
Pole Schedule	24-6
Preliminary Geometrics	2-3
Profile Grade	10-11
Project Data	3-2
Project Layout	2-10, 2-17, 9-1
Project Limits	10-6

Project Location Map	3-4
Quality Control	2-5
Railroad Crossing	3-10
Ramp Terminal Details	2-18, 13-6
Ramps	11-4
Reference Data	10-5
Reference Points	9-3
Retention or Detention Pond	15-7
Revision Dates	3-10
Roadway Cross Sections	18-1
Roadway Plan and Profile	10-1
Roadway Soil Survey	2-21, 17-2
Roadway Template	18-2
Scales	3-6, 10-1, 11-4, 12-2, 18-1
Selective Clearing and Grubbing	2-26, 21-1
Signal Head	24-4
Signalization Plans	2-24, 24-1
Signing and Pavement Marking Plans	2-23, 23-1
Signs	23-4
Skewed Cross Drains	14-3
Soil Data	18-2
Soil Survey	17-1
Special Details	16-1
Special Profile	2-11, 2-18, 11-1
Spline Grade	11-5
Stage Values	5-2
Standard Index Reference	3-6
Standard Notes	6-5, 7-3, 23-2, 24-2, 25-2, 26-2
Standard Symbols	21-2
State Map	3-10
State Plane Coordinate System	3-4
State Project Number	3-2
Storm Sewer Systems	5-7, 10-7, 14-4

Summary of Drainage Structures	8-1
Summary of Quantities	7-1
Superelevation	10-12, 11-6
Support Truss	23-5
Survey Reference Points	9-3
Symbols	1-2
Title Block	1-3
Topographic Worksheet	13-5
Traffic Control Plan (TCP)	19-1
Traffic Control Sheets	2-13
Traffic Data	6-3
Traffic Signal Plans	24-1
Typical Section	2-10, 2-17, 2-22, 6-1
Typical Section Package	2-3
Utilities (Major)	10-15
Utility Adjustment	2-22, 10-16, 20-1, 27-1
Utility Conflicts	14-5
Utility Contract Plans	2-22, 27-1
Vellums	1-3
Vendors	1-7
Vertical Curves	10-11
Vertical Geometrics	2-3
Water Table	18-2
Work Program Item Number	3-2
Work Zone Traffic Control	19-2