

CONSTRUCTION PROJECT ADMINISTRATION MANUAL

Document updated frequently, check website for most recent version



Florida Department of Transportation
State Construction Office

INTRODUCTION

CONSTRUCTION PROJECT ADMINISTRATION MANUAL

I.1 PURPOSE

The **Construction Project Administration Manual (CPAM)** contains instructions for administering Florida Department of Transportation (Department) Construction contracts and describes requirements and procedures for Final Estimate preparation associated with those contracts. This **Manual** provides instructions to Department representatives for administering items mandated in **Florida Statutes (F.S.)**, rules and/or contract specifications and for the successful completion of construction contracts including instructions to assist those charged with the responsibility of documenting final quantities and preparing final estimates. This **Manual** ensures consistency in carrying out Department policies and helps ensure that all construction contracts are successfully administered on a fair and equal basis.

I.2 AUTHORITY

Sections 20.23(3)(a) and 334.048(3), F.S.

Additional references will be cited on a chapter-by-chapter basis.

I.3 REFERENCE

Sections 119.07 and 119.011, F.S.

I.4 SCOPE

This **Manual** is intended to be used by Department and Consultant Construction Inspectors, Project Engineers, Resident Engineers, and other Department and Consultant personnel involved in the administration of construction contracts. These instructions for the Final Estimates process are not to supersede or circumvent project specific documents such as: specifications, special provisions, plans, and/or plan notes or **F.S.** As the Department's evolution continues, these procedures will require updates and revisions.

I.5 DEFINITIONS

The following terms and their definitions are applicable to the Chapters and Sections of this *Manual* as appropriate:

Acceptance Letter: There are two versions of acceptance letter sent to the Contractor with the Offer Letter: the Regular and the Qualified. The regular acceptance letter is used when the Contractor accepts the amount in the offer letter in full (either positive or negative). The qualified acceptance letter is used when the Contractor does not accept the amount in the offer letter in full. In this case, the contractor must explain why some or all of the offer is not accepted. The Contractor is required to return one acceptance letter for each contract.

Acquisition Period or Procurement Time: A number of calendar days allowed prior to the first day that time is charged to a contract. This period is to allow time for acquisition of some materials on specialized contracts.

Allowed Contract Time: The number of days set forth in the contract plus any time extension granted by the Department under the contract specifications.

Assessment Category: One of the major categories of construction work within the overall project such as, roadway base construction, drainage construction or signal installation. Each category of construction or "Assessment Category" has a corresponding list of Inspection Requirements referred to as a **Statewide Inspection Quality Control Guidelist** and a corresponding list of Critical Requirements called a **Statewide Quality Assessment (QA) Critical Requirements List**. The latter is used in evaluating how well the Quality Assessment Critical Requirements are performed, by the CEI staff. Assessment categories are identified along with a district and central office contact for each category as shown on the **Staff Responsibilities for Quality Assessment/Quality Control (QA/QC) Categories Table**, published on the Department's State Construction Office (SCO) Internet website.

Baseline Schedule: The required schedule of work activities that is initiated by the Contractor. This schedule defines the Contractor's plan to complete the construction project within the allotted time consistent with the contract documents.

Basis for Estimate for a Contract Change Issue: This is a statement which is a required part of the **Engineer's Estimate**. This statement details the methods used to determine the costs and time impacts for those issues shown in the **Engineer's Estimate** (refer to **Guidance Document 7-3-A**).

Best Practices: An activity, step, or task that when completed, produces extraordinary and unique results; a demonstration of excellence.

Compliance: A satisfactory performance of critical requirements as determined by a Process Review.

Compressed Time or Time Priority: Compressed time is achieved by increasing the normal production rates. The Contractor will have to make corresponding increases in the hours worked as well as crew size and equipment to complete the project within the shortened time. Compressed time is used when projects must be completed by a certain date or there are special considerations relating to traffic congestion or high public visibility.

Construction Engineering and Inspection (CEI): In this *Manual* it refers to the Consultant personnel performing CEI services or Department personnel performing CEI services.

Construction Contract Claim (Claim): A written demand submitted to the Department by the Contractor, in compliance with *Specification 5-12*, seeking additional monetary compensation, time, or other adjustments to the contract, the entitlement or impact of which is disputed by the Department. Refer to the flow chart of the claims process published on the State Construction Office (SCO) website section for flowcharts.

Construction Project Manager: The Department employee in responsible charge of the construction project and responsible for administering and managing the CEI Consultant contract.

Consultant Project Manager: The Department's employee responsible for administering and managing the CEI Consultant contract.

Consultant CEI: A consulting engineering firm pre-qualified by the Department to perform Construction Engineering and Inspection (CEI) and under contract to perform such services on a project or series of projects.

Consultant Inspector: The Consultant's technical field personnel assigned to a particular aspect of the inspection process.

Consultant Principal-in-Charge: That person designated by the consulting firm under contract who, as a corporate officer or principal in that firm, serves as the person in responsible charge of the management of the contract on the firm's behalf.

Consultant Project Administrator: The Consultant's administrator in charge of more than one aspect of the construction or administration of the project CEI.

Consultant Senior Project Engineer: The Consultant's Leading Engineer assigned to a construction project. In some cases, the Senior Project Engineer may oversee more than one construction project.

Consultant Quality Control Plan: A monitoring plan that provides the means by which measures/data will be derived. This plan is developed and used by the District Final Estimates Office/Consultant Construction Engineering Inspection (CCEI) to determine the degree of performance to specified requirements.

Contract Documents: All the documents that constitute the contract between the Department and the Contractor for construction of a project and which are listed in **Section 3.2.6.3.** of this **Manual**.

Contract Duration: The number of calendar days allowed for the completion of a contract, including additional time granted for inclement weather or for holidays or special events.

Contract Funds Management System: A web based application which communicates with the Department mainframe computer via a web browser. Users may access the application Monday-Friday 7:00 am to 9:00 pm and Saturday, 7:00 am to 7:00 pm to manage the encumbrance of funds for a contract and/or purchase order. The system checks for available budget as well as financial project cost estimate and authorizations in the Department's Financial Management System. Once the encumbrance request has passed all system edits, it will be included in the daily batch processing through the **Florida Accounting Information Resource (FLAIR)** system.

Contract Information & Monitoring (CIM): The Department's project database used to monitor and track the performance dates of a Value Added Feature (VAF) during the warranty period.

Contract Time Extension: Contract time extensions are defined in **Section 8-7.3** of the **Standard Specifications**. **Section 7.2** of this **Manual** provides detailed instructions for granting contract time extensions.

Contractor Affidavit and Surety Consent (21-A): This document is in two parts: the first is the Contractor's Affidavit; the second is the surety's consent for the release of retainage. It is required to close out every construction contract.

Contractor Delinquency Report: A monthly computerized listing of projects and pertinent project data for all projects which are delinquent as of the last monthly estimate of completed work.

Contractor Suspension Report: A computerized listing of Contractors whose Certificates of Qualification to bid on Department projects are currently suspended or

have previously been suspended, and the number of projects/times such Contractors have had their certificate suspended either due to the delinquent condition of a project or for other reasons which constitute good cause as per **Section 337.16, F.S.**

Contractor Quality Control (CQC): A requirement of the contract documents that makes the Contractor responsible for gathering material samples; for acceptance testing of those samples; for performing quality control inspection of the work; and for generating and maintaining all mandatory records associated with these responsibilities.

Contractor Quality Control Plan: A written plan developed by the Contractor and approved by the Department that details the policies, methods and procedures that the Contractor intends to use to ensure that the level of quality required by the contract documents is achieved.

Contractual Lapse: The perceived or verified inability of the Consultant CEI to perform one or more aspects of its contractual obligations in any aspect or phase of the Contract.

Controlling Work Items: Refer to **Section 1** of the **Standard Specifications**. In a Critical Path Method Schedule, these work items or activities are on the critical path. A delay to a critical work item will cause an increase in the project duration unless corrective actions are implemented.

Cost Savings Initiative Proposal (CSIP): A type of Request for Modification (RFM) submitted by the Contractor that if approved, will initiate a change to the contract documents resulting in a reduction of project costs that are shared by the Department and the Contractor.

Critical Path Method (CPM) Schedule: A special provision for critical path scheduling is used for more complex projects. With large projects, compressed time, or incentive/disincentive projects the Department is looking for assurance that the Contractor will manage the project in a manner that will assure timely completion. Management at this level of complexity is very difficult without a tool like **CPM**. The **CPM** schedule will also provide additional documentation needed for negotiating contract changes and claims.

Critical Requirement: Activities/steps/tasks that are measurable and verifiable in a construction contract. Their intent is to outline vital requirements and identify problems that could potentially compromise the desired outcome. An essential construction inspection and/or administrative requirement that must be performed properly in order to ensure that a quality CEI process is achieved or that a customer satisfaction concern is addressed. Also, a non-critical requirement becomes critical because it is performed improperly on a frequent and widespread basis and is therefore a persistent problem. When Critical Requirement CEI activities are not done, they could compromise the

satisfaction of the customer, the quality of the product, use or the safety of the public. These Critical Requirements also serve as indicators of the quality of those items not being checked.

Daily Diary: Term used in AASHTOware Project Construction (PrC) to refer to a collection of all **Daily Work Reports** and presents information on contract activity for a given day. The diary should contain information on significant events, conditions or circumstances which immediately affect or have future impact on the project or contract.

Daily Work Report (DWR): This is the term used in PrC to refer to the **Daily Report of Construction Form No. 700-010-13** that was used by the Department before the implementation of PrC. Data is collected on every phase of work performed by a Contractor, subcontractor, subordinate subcontractor or utility company. Recorded information must be clear, detailed, accurate, complete and objective. This form is still used for contracts that are not tracked in PrC.

Delinquent Contract: The allowed contract time for performing the work has expired and the Contractor has not completed the contract work.

Delinquent Contractor: A Contractor with whom the Department has a contractual agreement for completion of the work on a delinquent contract.

Demonstration Pile: This is the pile which the Contractor is asked to construct to demonstrate the dependability of the equipment, techniques and source material prior to the start of production pile to the satisfaction of the Engineer (**Section 455-39.1**).

Department CEI: The Department employees who perform construction engineering and inspection services.

Department Prestressed Concrete Specialist (DPCS): The Department's local prestressed concrete quality assurance inspector or verification inspector who may be either a Department employee of the District or an employee of a Consultant CEI firm retained by the Department. In the context of this **Manual**, the DPCS is the Department's representative in charge at the prestressed concrete plant at which the component is being produced.

Dispute: A disagreement between the Department and the Contractor where the Contractor has submitted, in accordance with **Standard Specification 5-12**, a notice of intent to seek additional compensation but has not yet submitted a written claim in accordance with **Standard Specification 5-12**.

District Construction Engineer (DCE): The Engineer so appointed by the District Secretary to hold the title of DCE and who serves to manage all District functions

pertaining to construction of Department projects managed by either in-house CEI or Consultant CEI personnel.

District Construction Consultant Manager: The Department representative working for the DCE, who administers the Consultant CEI work program.

District Chief Counsel: The Department attorney supporting the District Secretary regarding legal matters of the District.

District Level Staff: The staff assigned to the district construction office, which includes the DCEs and their delegates. This may include other offices that perform independent quality assessments (i.e. Materials Office, District Bituminous Engineer's Office, acceptance/maintaining agencies, etc.).

District Process Review Representative: Each district may elect to have a representative selected by the DCE from the district office to participate in Central Office Process Reviews. This is to allow individuals to share training opportunities found during the review with other project staff and residencies or operation centers.

District Scheduling Engineer: The Department employee or Department representative identified by the DCE to be responsible for coordination of all scheduling activities related to construction projects in their District. This person establishes the contract time used for scheduling construction projects.

District Warranty Coordinator (DWC): Department employee designated by the DCE or Operations Engineer/Resident Engineer, responsible for the administration of VAF under the warranty provisions of a contract.

Engineer's Estimate: The estimate of the actual cost and time impacts to the Contractor caused by extra work without regard to fault or the percentage of those cost and time impacts the Contractor may be entitled to recover. For each extra work issue, the **Engineer's Estimate** will show the pay items involved along with quantities, unit prices, any time impacts, and the basis for the estimate (refer to **Guidance Document 7-3-A** for a description of the basis).

Engineer's Weekly Summary, Form No. 700-010-14: This document provides a summary that gives project status and documents significant events, conditions or circumstances, which immediately affect, or have future impact on, the project or contract. This is not required if **Daily Work Reports** and **Daily Diaries** are entered directly into PrC. This is only required for those projects or contracts that are being done manually but is recommended on all projects.

Entitlement Analysis: A document, signed and dated by the preparing Project Administrator or Engineer, containing statements relevant to each issue of extra work,

detailing the reason(s) each issue of extra work was needed. The **Entitlement Analysis** shall cite specific contract references which establish why the Contractor is, or is not, entitled to recover the time and cost impacts calculated for that contract change issue in the **Engineer's Estimate**. If some of the time or cost impacts determined in the **Engineer's Estimate** are the responsibility of the Contractor, the **Entitlement Analysis** for each issue should also include a numeric percentage of those cost and time impacts for which the reasons previously detailed justify the Contractor's entitlement. Each contract change issue should include all the pay items associated with that issue. A copy of relevant project correspondence may be attached to or referred to in the **Entitlement Analysis**.

Final Acceptance: Acceptance of a project by the Engineer after all items of work have been completed satisfactorily.

Errors and Omissions: A general term used to describe deficiencies in the performance of Consultant contractual obligations on a project.

Final Estimate: A final estimate is generated at the end of a contract to finalize payment of all work completed and accepted by the Engineer over the life of the contract. A final estimate is the first step in closing out a contract and, in most cases, should be zero dollars.

Final Inspection: An inspection conducted by the Engineer which finds that all work has been satisfactorily completed.

Flexitime: Flexitime allows a Contractor an additional amount of time after the notice to proceed to begin work. The day the project work starts is set by the Contractor within a window of time established in the special provisions. The extra time allowed the contractor is used for scheduling materials, equipment, subcontractors and acquiring materials. Flexitime may be granted where material procurement is needed for items such as mast arms, signalization equipment, etc. When this special provision is used, the Contractor is not given an additional material acquisition period before contract time begins. The Contractors are provided the additional flexibility, and flexitime jobs normally will have fewer overruns and time extensions. The negative side of flexitime is that it pushes out the calendar date for the completion of the project.

Geotechnical Engineer: In this **Manual**, the Geotechnical Engineer may be the District Geotechnical Engineer (DGE), any Department Engineer assigned for the project by the DGE, the Consultant Geotechnical Engineer working directly for the DGE, or the Geotechnical Engineer employed by the Department's Consultant CEI and performing under the direction of the DCE and DGE. The Geotechnical Engineer is engaged by the Department to review all foundation construction documents submitted by the Design-Build Firm and provide recommendations to the CEI on foundation issues. If the

Geotechnical Engineer is engaged by the Consultant CEI, the District Level Responsibilities in this **Manual** will also be the Resident Level Responsibilities. The CEI Geotechnical Engineer shall coordinate with the DGE in performing his/her responsibilities.

Guidelist: A list of major contract document requirements that inspectors are expected to verify without fail. A guidelist is not intended to be a comprehensive list of all contract document requirements since the contract documents and Department procedures contain many other requirements that are not major. To view the guidelists online, go to the website address in item 10, **Section 3.2.3** of this **Manual**.

Incentive/Disincentive: The total “incentive payment” or “disincentive deduction” is a dollar per day amount which the contractor will be entitled to or charged based upon the accrued amount multiplied by the time (calendar days) established in the contract for the contractor to complete a specified activity or to complete the project. The time begins with the first chargeable day and ends with the completion of the project or the specified activity or milestone.

Innovative Practice: A unique method for superior performance, or an innovative concept that has already produced excellent results, which the reviewer believes can be duplicated by using this practice on other Department construction contracts. These practices should be noted in the Process Reviews and passed along for future replication as best practices.

Lane Rental: The Contractor is permitted to “rent” travel lanes during construction in order to decrease the production duration and minimize the amount of time lanes are closed to traffic.

Liquidated Savings: A Savings intended to encourage the contractor to finish a project early by providing a financial incentive for each day the project is completed prior to the approved project duration.

Major Item of Work: Any item of work having an original contract value in excess of five (5) percent of the original total contract amount.

Minor Change: When the character of the work as altered is within the scope of the contract and such work is totally defined by existing items of work at previously established contract unit prices; and when no major item of work is increased in excess of one hundred twenty-five (125) percent or decreased below seventy-five (75) percent of the original total contract quantity; and when the Contractor’s work effort to perform the change does not exceed five (5) percent of the original total contract amount.

Minor Overrun: Overrun in the quantity of one or more previously established pay items at contract unit price the sum of which totals two and one-half (2.5) percent or less of the original total contract amount.

Monthly Schedule Update: A Critical Path Method schedule, for a contract that has not changed, is updated by the addition of actual start dates, actual finish dates, percent complete to activity data, added activities, changes in sequence, and project duration, so as reflecting the progress of work.

Negotiated Settlement: The Department recognizes that a contract change is not a claim if the most recently modified *Entitlement Analysis* and *Engineer's Estimate* does not completely justify the amount the Department is agreeing to pay for a contract change. In this case the contract change is defined as a Negotiated Settlement and the Department does not dispute the amount owed. This contract change will not be called a claim even though there may have been some initial disagreement on entitlement, contract time, unit prices, and quantities.

Net Overrun: Overrun's dollar value minus the underrun's dollar value.

No Excuse Bonus: A Bonus paid to the contractor as an incentive to complete a project within set number of calendar days or a specified time frame (calendar date) regardless of any problems or unforeseen conditions that may arise.

Non-Compliance: A Non-Satisfactory performance of a critical requirement as determined through the Process Review.

Non-complying Components: Non-complying components are components that have been damaged, that do not meet the specified tolerances, or that contain defects.

Nonconformance/Noncompliance Report (NCR): A Request for Correction (see the definition of Request for Correction) that requires the Contractor's submitted documents to include official Department *Form No. 675-010-10, Nonconforming Structural Steel and Miscellaneous Metal Component Data Sheet, or Form No. 700-030-10, Noncomplying Prestressed/Precast Concrete Component Data sheet*, when the correction involves a structural steel or miscellaneous metal product including mechanical and electrical components or a prestressed/precast product.

Other Warranty Items (OW): An item or segment of work, which by agreement of the contracting parties, will be warranted or guaranteed for a specific period of time.

Partial Acceptance: Acceptance of a portion of a project for which all contract work has been satisfactorily completed and inspected.

Pavement Condition Survey: A LOT-by-LOT in-depth evaluation of the pavement for the ride quality, rutting, and other performance thresholds associated with Value Added pavements. The evaluation is conducted by the Pavement Section of the District Materials office (DMO) or the State Materials Office (SMO) in Gainesville.

Phase III Review: One of the last technical reviews of a set of roadway plans prior to being let to bid. At this review, all plan sheets are complete with the exception of the quantities for maintenance of traffic pay items. The only work remaining will be to reply to comments that result from the Phase III review, which is also known as biddability review. All phases are described in the **FDOT Design Manual (FDM) Part 3, Chapter 301**. If the plans are available at Phase II for biddability review, those items may be reviewed during this period.

Post Preconstruction Conference: If there is a requirement for On-the-Job Training (OJT), a meeting will be held between all interested parties no more than thirty days prior to beginning any construction work on the project and no sooner than the Project's Work Schedule has been approved. The Contractor's representative, Department representatives and all other parties contractually obligated to or having an interest in Disadvantaged Business Enterprise (DBE), or Equal Employment Opportunity (EEO) requirements, and OJT will attend. If there is no OJT requirement the District may elect to schedule a separate meeting to discuss DBE/EEO requirements.

Preconstruction Conference: A meeting held between all interested parties prior to beginning any construction work on the project. The Contractor's representatives, Department representatives and all other parties having an interest in the project are expected to attend.

Premium Cost: The additional cost of a contract change that would not have been incurred if the work had been included in the original contract. More specifically, premium costs are dollar amounts paid for non-value added work. Delays, inefficiencies, rework, or extra work as shown below, other than those caused by the Contractor and/or his subcontractors or suppliers, will be considered as non-value added work. Non-value added work can occur in three distinct situations:

- (1) Work delays or inefficiencies - In this situation, the premium costs are the total delay/inefficiency damages paid to the Contractor.
- (2) Rework - The premium costs are the dollar amount of the original items of work that have to be removed and the costs to remove these items.
- (3) Extra Work - In this situation, the premium costs are computed as the net difference between the final agreed prices paid to the Contractor and what the cost would have been had the extra work been included in the original bid at letting.

Prime Contractor: One that enters into a contract with the Department.

Process Reviews: A review of project, resident and district compliance with **QA/QC Guidelists** and **Critical Requirements** published by the SCO will be included as part of SCO Specialty Engineers' reviews of their respective specialty areas. Additional to SCO is participation of SMO and Federal Highway Administration (FHWA) as needed and available. Upon discovery of any deficiencies, participants in the Process Review are tasked with educating the project personnel on the correct way to do the task. This information is reported to the residency and district so that the district can share the training opportunity with other residencies. Central Office Process Reviewers are tasked with looking for the same deficiency during their next Process Review to determine if the previously discovered deficiency was exclusive to a single district or if it is more widespread and requires statewide training. The emphasis of the reviews is to assure that CEI personnel are in compliance with procedures and policies and to assure that when errors or deficiencies are discovered that they are quickly corrected while those making the error are educated on the correct way to do the task.

Production Rates: A ratio of units of work to a period of time; (i.e., 1,500 square yards/day or X yards/hour.)

Progress or Monthly Estimate: A progress or monthly estimate is generated to pay the Contractor for the portion of work completed and accepted by the Engineer. A progress or monthly estimate is generated each month during the contract and may also be used to pay a Contractor for an Supplemental Agreement (SA) approved after final acceptance, release Retainage, or rectify a Notification of Findings issued after the offer of final payment.

Project Administrator (PA): The Administrator who shall be responsible for the everyday construction activity at the project under the direction of the Resident Engineer/Senior Project Engineer.

Project Diary: Refers to all documents that present a recorded collection of events, data, occurrences, instructions, situations, circumstances and work performed each day during a construction project. **Project Diary** includes, **Daily Work Reports, Daily Diaries, Work Plan Controlling items of work.**

Project Level Staff: The staff assigned to the project, which may include lead or senior level inspectors, project administrator and senior project administrators. This includes both in-house and Consultant staff.

Project Material Certification Letter (PMCL) - This document is a letter from the SMO attesting to the fact that all materials incorporated into projects constructed under the contract meet Department specifications. The letter may list exceptions identifying materials incorporated into the project that do not meet Department specifications and

explaining why the use of these non-specification materials is being allowed. NOTE: This letter is generated by the Materials Acceptance and Certification program.

Quality Assessment (QA): The process used by the Project, Resident, and District Level staff to monitor and ensure that CEI activities are in compliance with predetermined standards. Quality Assessment is not intended to be a project specific review but is instead a process-oriented review. SCO Process Reviews will review the project, resident, and district QA process.

Quality Assurance: The process for monitoring the Contractor's level of compliance with the Quality Control Plan as well as evaluating the effectiveness of the Plan.

Quality Assurance Review (QAR): Performed by the Resident Office to assure compliance with processes and procedures throughout the contract duration.

Quality Control (QC): The process of monitoring and documenting the Contractor's operations and performance as well as evaluating the acceptability of the Contractor's product and performance. Product acceptability is established by determining if the product complies with the Contract Documents. Performance is determined according to **CPAM Section 13.1**. In performing the monitoring process, an inspector is often in the position of affecting the Contractor's progress since in some instances construction should not proceed until the inspector is sure that the Contractor complies with the contract documents. It is because of this authority vested in the inspector that the process is referred to as Quality Control since the inspector can be in control of the Contractor's quality and progress. Project level activities performed daily by the Contractor's and the project level staff in monitoring established Department requirements, procedures, and standards to assure compliance with contract documents. Inspection and acceptance of the Contractor's work is Quality Control. Inspection of the Contractor's work by the Contractor's QC Manager and that of the QC Manager's inspection staff is also Quality Control.

Remedial Work (RW): Corrective measures performed by the Contractor on a current project in progress or by the Responsible Party on a Value Added Feature (VAF) to restore the feature to compliance with the specification.

Request for Correction (RFC): A document initiated by the Contractor entitled RFC, which has pertinent supporting documents and data attached, proposing a method for correction of work that is not in compliance with the contract documents that is submitted to the Project Administrator (PA) for coordination with the Department and others on a response to the proposal.

Request for Information (RFI): A written document initiated by the Contractor entitled RFI that is submitted to the PA for coordination with the Department and others on a response to any of the following issues:

- Interpretation of a contract document provision, the meaning of which, is not clear to the Contractor
- Errors, omissions or conflicts in the contract documents that are identified by the Contractor
- Pay adjustment or entitlement

Request for Modification (RFM): A document initiated by, and for the benefit of, the Contractor entitled RFM, requesting a modification to the contact documents that is submitted to the PA for coordination with the Department and others on a response to the request.

Resident Engineer: The Department's local area representative who reports directly to the DCE and may be either a Department employee of the District or an employee of an engineering firm which is serving as the Department's Consultant CEI representative. The Engineer supervising CEI personnel responsible for the construction activities in the residency. In this *Manual* this could be the Consultant Senior Project Engineer responsible for the construction activities of the project. For the purposes of this *Manual*, the Construction Engineer in responsible charge for all Construction Contracts managed by an Operations Center is considered equivalent to the Resident Engineer.

Resident Level Staff: The staff assigned to the resident construction offices or operations centers, which may include Consultant project managers, construction project managers or Consultant program managers and the resident engineers or their delegates.

Responsible Party (RP): The party contractually obligated to ensure that a VAF performs in full compliance with the contract requirements for the designated period of time following final acceptance.

Revised Project Schedule: A schedule required to be submitted when work has been added or deleted to a contract, either by Supplemental Agreement (SA) or a Unilateral Payment (UP).

Second Tier Subcontractors - a.k.a., Subordinate Subcontractor; any person who enters into a subordinate contract with a subcontractor for the performance of any part of such subcontractor's contract.

Second Tier Supplier: Any person who furnishes materials under subordinate contract to a subcontractor for direct delivery, specially fabricated materials or off-site improvement, and who performs no labor in the installation.

Semifinal Inspection: An inspection conducted by the Engineer within seven days after notice from the Contractor of presumptive completion of a unit of a project or the entire project.

Significant Change: When the character of the work as altered differs materially in kind or nature from that involved or included in the original proposed construction; or when a major item of work is increased in excess of one hundred twenty-five (125) percent or decreased below seventy-five (75) percent of the original contract quantity.

Special Working Hours: Certain hours of the day or limited days of the week when work can be performed. These limitations are usually site specific and can increase the duration of the construction contract.

Statement of Claim Settlement Cost: The claim settlement costs are those costs disputed by the Department but paid solely to avoid the risk of additional costs associated with resolving the claim by dispute review board, arbitration or litigation. Claim settlement costs are the sum calculated by subtracting from the Claim **SA** amount paid, that amount justified by the Engineer's Estimate and Entitlement Analysis percentages. Specifically, that amount justified by the Engineer's Estimate and Entitlement Analysis is the summation, for all claim issues, of the most recently amended Entitlement Analysis percentage for each claim issue, multiplied by the most recently amended Engineer's Estimate of cost impact for that issue. The **Statement of Claim Settlement Costs** is simply a page signed and dated by the Engineer preparing it that lists the claim issues, shows the calculation described above and includes the following: the relevant amounts for each issue, the total amount justified, the total amount paid and the resulting claim settlement cost. Even though a contract adjustment may settle several disputed issues for amounts greater than justified in the Entitlement Analysis and Engineers Estimate, the contract adjustment will have only one **Claim Settlement Cost** which is the sum of all such costs for the issues settled in the contract adjustment.

Statewide Critical Requirements List: For each assessment category, this is a minimum list of requirements which should be reviewed during Process Reviews. Note that where warranted, in the opinion of the Process Reviewer, additional items from the **Statewide Inspection Guidelist** may also be reviewed during any Process Review. These guidelists are worded in such a way as to focus the Reviewer's attention on the CEI staff's performance of inspection and management duties related to the critical requirements. The **Statewide Critical Requirements Lists** are available on the Department's SCO infonet and internet websites and may be downloaded for field use. Although these guidelists are to be updated annually; where warranted, they may be changed in midyear.

Statewide Inspection Guidelist: A list of major items that assists the CEI staff in their inspections of work related to each assessment category. These are principally to be used with **CPAM Section 3.2, Quality Assurance and Quality Control of Field Construction Operations** and are only applicable to this section to the extent described in the definition of **Statewide Critical Requirements Lists** shown above. The guidelists are worded in such a way as to focus the CEI staff's attention on ensuring the Contractor's performance. Each of the assessment categories has a guidelist that covers the significant inspection requirements corresponding to that category. The guidelists are not a comprehensive source for identifying everything, which an inspector or construction manager must know. Instead, they are intended to be a guide for identifying significant and critical areas of concern, the details of which are covered in the contract documents. The guidelists are available on the Department's SCO infonet and internet websites and may be downloaded for field use. These guidelists are also to be updated annually, but where warranted they may be changed in midyear. The SCO may also solicit participation of a specialist from one of the districts or other offices when the SCO reviewer does not have the level of expertise needed for the review. This person would participate in Process Reviews conducted in all of the Districts.

Streamline Projects: This alternative type was developed to simplify the administration of the contract by selecting minor projects that were less than \$2,000,000 dollars and less than 2,000 tons of asphalt. There are two types of Streamline projects: 1.) Streamline Plan Quantity and 2.) Streamline Lump Sum.

Subcontractor: One that enters into a contract with the prime Contractor; one who furnishes labor, materials or equipment and work by equipment rental under rental agreement with the prime Contractor.

Substantial Overrun: Overrun in the quantity of one or more pay items which totals more than two point five (2.5) percent of the original total contract amount.

Supplemental Agreement (SA): Written modifications to the contract scope to clarify plans and specifications, to provide for unforeseen work, grade changes, or alterations in plans, and other bases pursuant to Section 337.11(9)(a) – (d), F.S. Monies must be encumbered for payment of a supplemental agreement.

Supplier: Any person who furnishes materials under contract to the prime Contractor for direct delivery, specially fabricated materials or off-site improvement, and who performs no labor in the installation.

Tentative Acceptance Agreement (TAA): An agreement to partially refund a Utility Agency Owner for an over estimated deposit on a utility project.

Time plus Money Bidding: Shortens the contract time by allowing each Contractor to bid the number of days in which the work can be accomplished.

Training Opportunities: Deficient performance of a Critical Requirement or other area of CEI responsibility as determined through the Process Review.

Value Added Feature (VAF): A feature designated by the specifications that requires a Responsible Party to be contractually obligated for and warrant the performance of the feature as described by the contract.

Verification Testing Geotechnical Engineer (VTGE): The Engineer engaged by the Department to perform verification testing. Verification testing could be dynamic testing and integrity testing. It could be the same consultant geotechnical sub consultant working for the CEI, DGE, in-house Department personnel from the DGE, or a consultant working directly for the DGE.

Warranty Period: The period of time designated in the contract or by agreement for which the Responsible Party is contractually obligated for the performance of the VAF.

Work Plan - Controlling Item of Work, Form No. 700-010-15: This documents the Contractor's planned scheduled of work identifying those items of work that will control the over-all progress of the Contractor's work effort on projects without CPM Schedule.

I.6 DISTRIBUTION

CPAM Coordinator: Each DCE shall appoint a District CPAM Coordinator for the District. The DCE shall also notify the State Construction Engineer (SCE) whenever a new District CPAM coordinator is appointed. The SCO will publish the current list of CPAM coordinators, including their position, titles, postal addresses and email addresses at the end of this section (**See Attachment I-1**). The District CPAM Coordinator will act as a district contact for CPAM revision comments or suggestions. The SCO shall appoint a CPAM Coordinator. The SCE shall notify the DCEs and District CPAM Coordinators of any such appointments or changes in appointment thereof. The SCO-CPAM Coordinator is responsible for coordinating the review and publishing of the CPAM in accordance with this *Manual*.

Access: The *CPAM* and its associated *Construction Bulletins (CBs)* and *Guidance Documents* are public documents as defined in **Section 119.011(12), F.S.**, and must be made available to the public. The principal avenue of availability to all external customers, including the public, should be through the SCO website at <https://www.fdot.gov/construction>. All external customers and consultants should be advised of the opportunity to review and or print the *CPAM* free at the SCO website.

Department staff may also access the **CPAM** from the SCO website on the Infonet/Intranet. Although the document is intended for Department personnel and Consultant CEI personnel with active Consultant CEI contracts, other requests for paper copies are to be expected.

Access to Paper Copies for External Customers: When an external customer still wants a paper copy after being advised of the free availability on the SCO website, then that request within any District should be handled by the District Construction Office. **CPAM** distribution is now electronic and the Office of Maps and Publications no longer handles sales of the **CPAM**. Paper copies of individual pages or of whole sections may be requested from a District. A reproduction fee is specified in **Section 119.07, F.S.** Any monies received should be submitted to the Comptroller in accordance with the latest version of the **Receipt Processing, Procedure No. 350-080-300k**.

Notice of Changes: Each DCE and District CPAM Coordinator will receive an email notice when any portion of the **CPAM** published on the SCO website has changed. Such changes are posted on the Construction website under Manuals Online, or posted under Memos and Bulletins when implemented by a **Construction Bulletin**. The DCEs and District CPAM Coordinators shall be responsible for the distribution of that notice to all Resident Engineers and Project Engineers within their areas of responsibility. The SCO shall be responsible for notifying the Office of the General Counsel, Office of the Comptroller, the Director of Administration, DCEs, the Forms and Procedures Office, and the District CPAM Coordinators, and those individuals within the SCO of any updates/revisions to the **CPAM**.

Maintenance of Record Copies and Review Files: The SCO shall be responsible for maintaining the **CPAM** review files; original copies of **CBs**; original copies of **Guidance Documents**, and overseeing the timely incorporation of **CBs** into the correct section of the **CPAM**.

I.6.1 ELECTRONIC DOCUMENT DISTRIBUTION

The Department utilizes the Electronic Document Management System (EDMS) for the purpose of providing secure electronic storage, retrieval, and archiving of electronic documents. Construction is a Business area within the EDMS - Construction Document Management (CDMS) - which is utilized to store, retrieve, and archive all construction project records. CDMS is an electronic recordkeeping system containing all construction project documentation and correspondence generated or received by the Department throughout the construction phase including the final estimate and project completion. Records created and/or maintained within EDMS shall serve as the official record if the source record was created for or by the Department with CDMS serving as the central repository for official construction records. This process for electronic storage and

retrieval shall replace the requirements for paper copies as called for throughout this **Manual**.

(A) District Level Responsibilities

The DCE shall have a policy for electronic distribution and storage of documents in lieu of paper copies as called for throughout this **Manual**.

(B) Resident Level Responsibilities

Subject to the District's policy, documents shall be electronically distributed and stored in lieu of paper copies as called for throughout this **Manual**.

I.7 COMMENTS OR SUGGESTIONS FOR CPAM REVISIONS

Any comments or suggestions on the **CPAM** should be sent to the District CPAM Coordinator. Comments from District personnel will be routed through the DCE for concurrence/comments before forwarding to the SCO-CPAM coordinator in Tallahassee. Central Office employees may send their comments directly to the SCO-CPAM Coordinator. **Attachment I-2, Suggestions and Comments**, is provided at the end of this section to show users the minimum information required to submit comments/recommendations. Suggestions containing the same minimum information may also be emailed to the appropriate CPAM Coordinator or submitted directly to the comments section of the SCO Website. As comments and suggestions are received at the SCO, they will be assigned for action by the SCO-CPAM Coordinator to the appropriate staff person.

I.8 REVIEW

The **CPAM** is a dynamic document which will require periodic review. Each section of this **Manual** will be reviewed on a bi-yearly basis: even numbered chapters on even numbered years and odd numbered chapters on odd numbered years. This review will be conducted by the SCO staff person assigned to be the contact person for the section. The SCO-CPAM Coordinator will route any comments received during the 24 months to the appropriate section contact person for the bi-yearly section review. Separate files will be maintained on each section including original draft, final adopted copy, revisions, comments received, and history of any changes made to the section. The SCO staff person assigned as the section contact person will ensure that all comments received during the 24 months are reviewed, responded to and if appropriate, incorporated into any revision of the section. The SCO-CPAM Coordinator will also make sure that any revisions involving substantive content changes to an existing section are reviewed by all DCEs.

I.9 REVISIONS AND ADDITIONS

I.9.1 New Chapter/Section

When a new item appears which cannot be adequately addressed within the *Manual's* present chapters/sections, then a new section will be written by the SCO. New chapters or sections will be circulated for preliminary and executive review in accordance with **Section 5** of the Department's *Standard Operating System, Procedure No. 025-020-002*, and approved by the Executive Board. New sections of *CPAM* will be distributed in accordance with instructions in **Subsection I.6, Distribution**.

I.9.2 Revised Chapter/Section

The SCE will decide if revisions involve substantive content or minor and/or editorial revisions. Revised sections of the *CPAM* will be distributed in accordance with the instructions in **Subsection I.6, Distribution**.

I.9.2.1 Substantive Revisions

Adoption of revisions may begin by majority vote with each DCE having one vote (8 votes), and the Central Office having three votes, for a total of 11 votes.

Substantive revisions will be routed through the Forms and Procedures Office for Departmental review. After all comments are received and resolved, the draft revision shall be put on the Executive Board Agenda for approval.

After Executive Board approval, the SCO will prepare a summary of changes for the history section, update table of contents and forms section as needed, and coordinate with the Forms and Procedures Office for final publication.

I.9.2.2 Minor and/or Editorial Revisions

Minor and/or editorial revisions may be issued by the SCE, after coordination with the Forms and Procedures Office and the Director, SCO.

I.9.3 Construction Bulletins (CBs)

CBs may be issued by the SCE's Office. This action should only be used when immediate implementation is needed, such as to implement a mandatory legislative change, FHWA directive, judicial court ruling, new Department policy, or other time sensitive issue. **CBs** will be distributed in accord with the instructions in **Subsection I.6, Distribution**.

A **CB** shall have temporary authority. A **CB** shall expire once the requirements of the **CB** have been incorporated into the appropriate chapter/section of this **Manual** as part of the review process described in **Subsection 1.8, Review**.

CBs will be published on the SCO website. Prior to being placed on the DCEs' agenda, a **CB** must be put into the **Construction Manual** format. This can be a page revision/insertion, section revision/insertion, or chapter revision/insertion. They will also be distributed to all DCEs and District CPAM Coordinators. The DCEs shall be responsible to notify all Resident Engineers and Project Engineers within their district when a new **CB** is received. The DCE shall distribute the **CB** as needed in order to ensure that their areas of responsibility are in compliance. The SCO will distribute the **CB** to the SCO Specialty Engineers and other affected Central Office personnel.

I.10 GUIDANCE DOCUMENTS

In the event that the SCE determines that written advice should be provided to the Districts, a sequentially numbered "**Guidance Document**" may be issued. **Guidance Documents** will receive only the review determined by the SCE to be absolutely necessary prior to its issuance. While adherence to the procedure is mandatory, **Guidance Documents** are only advisory. Information included in the **Guidance Documents** is intended to convey "best practices", and is not considered mandatory.

The first page of any **Guidance Document** will show the **CPAM** section name and number that the document is intended to clarify. Such **Guidance Documents** will be maintained in the **CPAM** at the end of the section they are intended to clarify. **Guidance Documents** will be distributed in accord with the instructions in **Subsection I.6, Distribution**.

I.11 CONSTRUCTION MEMOS

Construction Memos will be issued by the SCO to provide interpretations of specifications, specification changes, information on policies and standards and construction related issues. All issues concerning standard specifications, policies, and procedures will subsequently be incorporated into those documents. Each **Construction Memo** will be identified with a number indicating its numerical sequence in the year of issue.

Construction Memos expire at the end of the calendar year in which they are issued and will be removed from the SCO Current Memos webpage. **Memos**, which must remain active through the next calendar year, will remain on the SCO Current Memos webpage as active memos with its original identification number. Expired **Construction Memos** will be marked "This Memo Has Expired."

I.12 TRAINING

Training in the use of this *Manual* is not required. Training is provided through the Construction Training and Qualification Program (CTQP). Courses are available within the Department of Transportation in individual subject areas such as aggregate, asphalt, concrete, earthwork, etc. For qualification requirements for each course, please see the Construction Training and Qualification Manual (CTQM) for more information.

I.13 FORMS

Forms will be listed on a chapter-by-chapter basis, with accessibility identified if not available from the Department's Forms Library.

Attachment I-1
CONTACT LIST FOR FDOT CPAM COORDINATORS

District 1

Marshall Douberley

P.O. Box 1249
Bartow, FL 33831-1249
marshall.douberley@dot.state.fl.us

District 3

Barbara Strickland
P.O. Box 607
Chipley, FL 32428
barbara.strickland@dot.state.fl.us

District 5

Jennifer Smith
719 So. Woodland Blvd.
Deland, FL 32720-6800
jennifer.smith2@dot.state.fl.us

District 7

Heward Humes
11201 N. McKinley Dr.
Tampa, FL 33612-6403
hewrald.humes@dot.state.fl.us

Materials Office

Cristina Croft
5007 N.E. 39th Avenue
Gainesville, FL 32609
cristina.croft@dot.state.fl.us

District 2

Michael Sandow
P.O. Box 1089
Lake City, FL 32056-1089
Michael.Sandow@dot.state.fl.us

District 4

Deborah Ihsan
3400 W. Commercial Blvd.
Ft. Lauderdale, FL 33309-3421
Deborah.Ihsan@dot.state.fl.us

District 6

Maria Kunhardt
1000 N.W. 111th Ave.
Miami, FL 33172-5802
Maria.Kunhardt@dot.state.fl.us

Turnpike

Rachel Panchookian
P.O. Box 9828
Ft. Lauderdale, FL 33310-9828
Rachel.Panchookian@dot.state.fl.us

Central Office

605 Suwannee St. MS 31
Tallahassee, FL 32399-0450

Attachment I-2
SUGGESTIONS AND COMMENTS
CONSTRUCTION PROJECT ADMINISTRATION MANUAL

Document Name and Number: _____

Suggestions or Comments: _____

Name: _____

Address: _____

City, State, Zip: _____

Phone No.: _____

Email: _____

Date: _____

Please save a clean and redline copy for your files, then send both versions through the appropriate District Construction Engineer to:

Department of Transportation
SCO-CPAM Coordinator
Construction Office, MS 31
605 Suwannee Street
Tallahassee, Florida 32399-0450

Section 1.1

Plans Review and Comments

1.1.1 Purpose

The Department provides opportunities for the District Construction Offices to become involved in the design element of the project development process. By taking advantage of this opportunity, the construction offices can provide comments that will improve the design of the transportation facility, decrease construction duration and address potential issues which may otherwise arise during the construction of the project. This procedure, *the FDOT Design Manual (FDM), Topic No. 625-000-002*, and the *Structures Manual, Topic No. 625-020-018* describe the responsibilities and duties of various offices in the Department to perform phase reviews.

1.1.2 Authority

Sections 20.23(3)(a) and 334.048(3), Florida Statutes (F.S.)

1.1.3 General

Any person performing reviews must be familiar with *the FDM*, the designer's *Scope of Services* and *Request for Proposal (RFP)* documents as applicable. The *FDM* describes the review phases and submittal requirements for each review stage.

This *Manual* adheres to the terminology used in the *FDOT Design Manual, Topic No. 625-000-002*.

For conventional design-bid-build projects, the Phase II review is referred to as the constructability review when performed by the District Construction Office. When the District Construction Office performs a Phase III review, it is referred to as a biddability review. Constructability and biddability should be addressed at each review.

For bridges, there are four stages of plan development on conventional design-bid-build projects. Stage 1 occurs during the Project Development & Environment (PD&E) process. Stage 2 consists of the Bridge Development Report (BDR) and Phase I plans. Construction and maintenance considerations should be addressed in the BDR. Stage 3 includes the Phase III plans and technical specification submittal. Stage 4 is the Phase IV plans and complete specifications. Only a foundation submittal is required for Phase II structure plans except for Category 2 bridges that require a full submittal.

The plan reviewer must look for potential issues that can or will cause increased project duration and cost when the project is being constructed, as applicable. A plan review may be an opportunity to provide suggestions to improve the end product.

The Designer must give the District Construction Offices a reasonable amount of time, in accordance with Department policy, to perform the reviews. The District Construction Office must assign knowledgeable personnel with adequate time to perform the reviews. Comments will be provided in a timely manner so as not to delay development of the project.

The District Construction Offices must involve the respective resident office in each review to the maximum extent possible.

Comments made should relate to the Department's ability to receive favorable bids, construct the project as designed, and to address issues that might occur during construction.

All plan reviews shall be facilitated using the Department's **Electronic Review Comment (ERC)** system. The designer must provide responses to each plan review comment submitted which indicates a response is required. The plan reviewer must review and either reject or accept each comment response. All comments related to any specific plan development phase shall be adequately addressed to the satisfaction of the plan reviewer before any subsequent phase review submittals may be entered into the **ERC** system.

The following direction applies to all discipline phase plan reviewers performing Component Plan Reviews on Design-Build and Public-Private-Partnership projects:

Separate component plan review comments into categories which consist of Response Required Comments and FYI Comments.

- Response Required Comments refer to direct violations of the Contract and require a written response by the Design-Build Firm or Concessionaire. Where possible, the plan reviewer is expected to include the specific contract reference or requirement that is being violated. Examples may include, but are not limited to:
 - an AASHTO provision being violated.
 - a Governing Regulation, e.g., **FDOT Design Manual (FDM)**, **Structures Design Guidelines (SDG)**, requirement being violated;
 - a **Technical Proposal** commitment not being met;
 - a **Request for Proposal** requirement being omitted or violated;
 - omission in the plans or calculations;

- inconsistencies between the plans and calculations;
 - an environmental commitment or permit commitment not being met.
- FYI Comments do not refer to direct violations of the Contract, so they do not require a written response by the Design-Build Firm or Concessionaire. At the end of each comment, the plan reviewer shall indicate that the comment is for information only and a written response is not required.

For additional requirements related to Component Plan Reviews on Design-Build and/or other non-conventional type projects, refer to the ***Request for Proposal*** document and ***FDM 131, 132, 133 and 301***.

During each phase of review, time charges should be made against the appropriate in-house support project corresponding to the construction project review.

1.1.4 Scope Development

District Level Responsibility

The Quality Control Plans for many districts require the participation of the District Construction Office in developing the scope of the project. The project scope shall be complete and anticipate future improvements if necessary.

1.1.5 Phase I Review (Roadway)

District Level Responsibility

At this review stage, no decisions have been finalized and there is an opportunity to change aspects of the project that may have serious consequences as the project progresses from concept to completion. The key to designing a successful project involves establishing all the restraints to constructing the project early in the design so that permits, Right of Way (R/W) easements, utility relocations, etc., will lead to a constructible project. The plan reviewer should concentrate on assisting the designer in determining these restraints. This provides an opportunity for the plan reviewer to provide input on how the project should be constructed.

1.1.5.1 Roadway Plans

District Level Responsibility

The plan reviewer should be familiar with the ***FDM, Topic No. 625-000-002***, and be familiar with the information that is required to be in the plans for a Phase I review. If any

of this information is missing, its absence should be noted and corrected. Particular attention should be placed on reviewing alignments, typical sections, topography, benchmarks, and geometry for layout, R/W requirements and the traffic control conceptual plan.

R/W at intersections should be checked to make sure there is sufficient room for sidewalks, drainage structure connections, and signal poles. R/W widths should be sufficient to provide for adequate front slopes and back slopes to ditches, transitions to driveways, and future drainage structures.

The traffic control conceptual plan will have a substantial impact on the project's duration. The number of phases should be minimized. Staged construction and sequence of operations should be reviewed to minimize the impact on business.

If possible, utilities should be identified that could or should be relocated before construction. If utilities cannot be relocated before construction, encourage the use of Joint Project Agreements for relocation during construction by the Department's Contractor.

1.1.5.2 Bridge Plans

District Level Responsibility

The development of bridge plans will trail behind roadway plans at this stage because the bridge plans require the vertical and horizontal geometry, approved typical section, and Traffic Control Plan developed in the roadway plans.

1.1.6 Phase II Reviews (Roadway) and Bridge Plan Reviews

District Level Responsibility

For projects that consist of roadway and structures, the Phase II reviews for roadway and the latest set of structures plans should be submitted as a unit. At this review, the project layout is complete. Most R/W requirements should be identified, and all phases of construction should be detailed on the plan set.

1.1.6.1 Roadway Plans

District Level Responsibility

The most important aspect of this review is the drainage structures, cross and side drains, and outfall locations and R/W requirements. The plan reviewer must assure that:

- (1) Pipe and drainage structure locations will not adversely affect the project duration by forcing an additional work phase.
- (2) Sufficient R/W has been allowed for trenching drainage structures and for outfall locations.
- (3) Apparent conflicts with utilities have been addressed.
- (4) Utility contract plans have been coordinated with phasing of the roadway.
- (5) Provisions have been made for positive drainage during each phase of construction.
- (6) All necessary pay items are included in pay item list.
- (7) Conflicts between light standards and utilities and drainage (especially where foundations are required) are resolved.

1.1.6.2 Bridge Plans

District Level Responsibility

At the BDR/Phase I bridge plan stage, the District Construction Office review should concentrate on the ability of the Contractor to get materials to the site and the ability to perform the work. Specific bridge details are not developed at this time. Some specific areas to be reviewed should include:

- (1) Beam length and weight for transportability either by road or barge.
- (2) R/W requirements especially for haul route, access, and staging areas.
- (3) Ability to locate appropriately sized equipment on the project (i.e., is there room between bridges? Will the soil beneath the bridge or on access roads support very heavy equipment? Is water depth sufficient for barges?).
- (4) Are the assumed construction methods appropriate for the site?
- (5) Are utilities properly located?
- (6) Will there be any difficulties encountered during installation of the foundations?
- (7) Can utilities be relocated before construction? (This is especially important when utilities are hung from bridges or utilities will be in the area where piles, drilled

shafts, or temporary sheeting will be installed.) And, has the designer made any decisions about project phasing that will increase the project duration by impacting phase transitions? Is there a viable alternative?

- (8) Does the design of the various bridge elements allow for reuse of formwork?
- (9) Is removal of lead-based paint involved on the project? Asbestos removal? Creosote materials? Excavation in contaminated areas?

1.1.7 Phase III Review and Stage 3

District Level Responsibility

The designer must submit roadway plans, specifications, structures plans (if any), and specifications for this review. Conflicts and ambiguities between or among these elements must be resolved. The District Construction Office conducts a biddability review to establish whether a Contractor can submit a competitive bid based on the information shown in the plans and specifications. At this stage, many decisions have been made that cannot be undone; but it is still an important review because it provides an opportunity to remove some of the more common problems. Since constructability and biddability should be addressed at each review, the constructability review at this Phase should concentrate on the ability of specific details to be constructed within the requirements of the plans and specifications and to propose better details if possible.

Other common problems are caused by plan notes. Plan notes should avoid directing means and methods to a Contractor. Plan notes should be clear and concise and relay important information without conflicting with plan details and specifications. Plan notes should never reiterate or circumvent the requirements of the specifications.

One of the most common problems relates to pay items. There must not be any missing or incorrect pay items (Refer to the Basis of Estimates Manual or specifications for the correct use of pay items). There must be a clear method of payment for all items of work. Also, there should not be double pay for the same work. The Summary of Pay Items in the Estimated Quantities Report and the plans must agree.

The biddability review should concentrate on quantities for each item of work called for in the plans and specifications. What is material used for? How much? Where does it go on the project? Are the quantities correct? Reasonable? Misleading? Duplicated? Unnecessary? Contingent?

The District Construction Office needs to identify the following needs:

- (1) Traffic Control Officers' hours and Speed and Law Enforcement Officers

- (2) Partnering
- (3) Disputes Review Board
- (4) Pre-Bid Meetings

1.1.8 Phase IV Plans Review

District Level Responsibility

This review is to assure that all previous comments are resolved and plans, and specifications are complete. There should not be conflicts between or among contract documents.

1.1.9 Checklist

District Level Responsibility

A sample checklist as shown in ***Guidance Document 1-1-A*** provides a guide for the phase reviews. Comments should not be limited to items on the checklist. Each plan reviewer is encouraged to expand on this checklist by adding other items.

Guidance Document 1-1-A

PHASE REVIEW CHECKLISTS

FINANCIAL PROJECT ID NO.: _____

Review Phase: I II III IV

NAME OF REVIEWER: _____

DATE:

1. CLEARING/GRUBBING/EXCAVATION

Item No.	Feature to be Checked	Ok	Not Ok	N/A
1-1.	Delineation of limits of grubbing, clearing and landscaping.			
1-2.	Sites for temporary fill and topsoil storage. Laydown area on same side of road as fill area. Room for storage of excavated muck to be used as muck blanket. Indication of dump sites.			
1-3.	Measurement of borrow. Percentage shrinkage used satisfactorily.			
1-4.	Underground obstructions clearly marked.			
1-5.	Stabilization limits clearly shown.			

Suggested Changes: (to be completed for items checked "NOT OK")

Item No.	Description of Change
Designer's Comments	
Designer's Comments	
Designer's Comments	
Designer's Comments	

2. SITE SURVEY/PLAN/PROFILE

Item No.	Feature to be Checked	Ok	Not Ok	N/A
2-1.	Right of Way and property line dimensions in the plan.			
2-2.	Site conditions conform to those represented in plan.			
2-3.	Existing topography accurate and up-to-date and the profile fits the terrain.			
2-4.	Work elements identified clearly, and all corresponding pay items are included with adequate quantities to construct project.			
2-5.	Plans clear and legible. Any apparent conflict between plans and specifications.			
2-6.	Existing drainage patterns shown. Its conflict with new work depicted.			
2-7.	Typical section against existing and proposed Right of Way.			
2-8.	Line and grade of ditches and fences for conflict with existing cross-section.			
2-9.	Benchmark data, needed elevations, curve data in the plan.			
2-10.	Water table elevations and requirement of dewatering.			
2-11.	Check cross-sections for grade changes at phase tie ins.			
2-12.	Appropriate general notes and special provisions required for construction.			
2-13.	Pavement design shown graphically matches with the verbal description on sections.			

Suggested Changes: (to be completed for items checked "NOT OK")

Item No.	Description of Change
Designer's Comments	
Designer's Comments	
Designer's Comments	

3. REMOVAL/DEMOLITION

Item No.	Feature to be Checked	Ok	Not Ok	N/A
3-1.	If structures to be removed or renovated, asbestos survey?			
3-2.	If asbestos or creosote timber is being removed, are special instructions and disposal defined? Who will handle?			
3-3.	Are there clear limits of removal? Horizontally and vertically?			
3-4.	Is there adequate construction access for demolition?			
3-5.	Is there a clear method of disposal?			
3-6.	Adequate provisions if signs or road markers to be removed.			
3-7.	Appropriate milling details (e.g., limits are identified; special treatment at bridge ends; bridge overpass, etc.).			
3-8.	Availability of demolition site.			
3-9.	Are there contamination sites delineated? Utility relocation in or near these sites?			
3-10.	Depth of embedment, required excavation and inside details of removable items.			
3-11.	Depiction of valve boxes, manholes, hydrants and provisions for relocation.			
3-12.	Disassembly and adequate specified protection requirements. Disassembly of plant, structure, utility or equipment and adequate specified protection requirements to existing utility or structure.			

Suggested Changes: (to be completed for items checked "NOT OK")

Item No.	Description of Change
Designer's Comments	
Designer's Comments	
Designer's Comments	
Designer's Comments	

4. STRUCTURES

Item No.	Feature to be Checked	Ok	Not Ok	N/A
4-1.	Does Corp. of Engineers or WMD permit require work not shown on plans?			
4-2.	Is TCP coordinated with roadwork phasing?			
4-3.	If battered pile used will leads be over moving traffic? Will they miss R.E. walls?			
4-4.	Do plans show all utilities, existing pile locations and existing foundations in temporary and permanent pile driving area?			
4-5.	Water depth sufficient to float barges? Will barges block boat traffic? prop wash?			
4-6.	If access not practical by barges, have temporary work bridges or fill been considered? Is method consistent with permits?			
4-7.	Have power service points for signing, lighting, signals been confirmed?			
4-8.	Is highway lighting properly detailed for bridge? pilaster detail?			
4-9.	Are there any problems with R/W, i.e., Reimbursement Agreements and easements?			
4-10.	Has TCP Plan addressed channeling traffic from under overhead work?			
4-11.	If Federal-Aid Project, is foreign steel required on the project? If so, has the EOR obtained a design variance and waiver of the Buy America requirements from FHWA?			

Suggested Changes: (to be completed for items checked "NOT OK")

Item No.	Description of Change
Designer's Comments	
Designer's Comments	
Designer's Comments	
Designer's Comments	

5. UTILITIES

Item No.	Feature to be Checked	Ok	Not Ok	N/A
5-1.	List of all utility owners and contact numbers.			
5-2.	Existing utility location marked in the plan.			
5-3.	Utility conflicts and their relocation indicated in design.			
5-4.	Disruptions of other utilities and provisions for restoration.			
5-5.	Responsibility to relocate utility and provisions.			
5-6.	Verification of new utilities connecting with existing.			
5-7.	Adequate description of connection and reconnection points.			
5-8.	Availability of indicated existing utility ducts and their proximity to highway facility and traffic.			
5-9.	Other utilities which new underground ducts intersect or traverse.			
5-10.	Utility crossings resolved via scheduling restrictions (i.e., weekends, after hours) or temporary structures.			
5-11.	Overhead utilities, guy wires for potential conflict with operations and access of large equipment.			
5-12.	Utilities required for construction operation and field offices.			
5-13.	Sewer lines below water mains and gas lines above other utilities.			
5-14.	Space between R/W line and drainage structure to allow for construction.			
5-15.	Utility conflicts with drainage.			

Suggested Changes: (to be completed for items checked "NOT OK")

Item No.	Description of Change
Designer's Comments	
Designer's Comments	
Designer's Comments	

6. DRAINAGE

Item No.	Feature to be Checked	Ok	Not Ok	N/A
6-1.	Existing drainage patterns, their continuity and high-water indications.			
6-2.	Drainage easement, if required, in the plan.			
6-3.	Identification and adequacy of all drainage items and quantities.			
6-4.	Ditches compatible with existing and proposed drainage structures.			
6-5.	Needed elevations shown in the plan and compatibility of location of design with existing conditions.			
6-6.	Drainage when FC-2 (open graded friction course) is specified.			
6-7.	Drainage of construction area during work.			
6-8.	Drainage facility provided with the lanes on which traffic is to be maintained during work.			
6-9.	Proposed method of connecting new and old drainage facility.			
6-10.	Effect of overlay on intersections, gutters, curbs as regards to drainage and their adjustment.			
6-11.	Outfall locations of temporary and permanent drainage facility, if any.			

Suggested Changes: (to be completed for items checked "NOT OK")

Item No.	Description of Change
Designer's Comments	
Designer's Comments	
Designer's Comments	

7. MAINTENANCE OF TRAFFIC

Item No.	Feature to be Checked	Ok	Not Ok	N/A
7-1.	TCP (Traffic Control Plan) clear, complete, approved and conform to FDOT Standard Index.			
7-2.	Temporary safety devices requirement and provision (i.e., guard rail, attenuators, earth mounds, etc.)			
7-3.	Location of traffic control signs, warning devices and barricades. Check if they are encroaching on lanes.			
7-4.	Detour facility, if any, and maintenance of traffic. Traffic addressed on side streets as per Index 600 of Standard Index.			
7-5.	Traffic operation requirements properly addressed (i.e., signing, pavement markings, signal, etc.).			
7-6.	Relocation item for barrier wall or fence.			
7-7.	Location of flashing arrow boards, if needed, at appropriate places.			
7-8.	Lanes on which traffic is to be maintained compatible to local conditions and intended to be paved.			
7-9.	Is there sufficient clearance within the work zone for the operation (such as crane swing room)?			
7-10.	Adequate accommodations for intersecting and crossing traffic.			
7-11.	Address pedestrian and bicycle accommodations.			
7-12.	Are exits and entrances to the work zone adequate and safe?			
7-13.	Method of containing bridge slopes during phased construction (at end bent) and approach grade separations.			
7-14.	Restrictions (e.g., lane closure, general construction or peak-hour restrictions in urban areas) indicated in plan.			
7-15.	Note covering traffic signal modifications for phased construction.			
7-16.	Note covering pay for traffic control items.			

Suggested Changes: (to be completed for items checked "NOT OK")

Item No.	Description of Change
Designer's Comments	
Designer's Comments	

8. SIGNALIZATION

Item No.	Feature to be Checked	Ok	Not Ok	N/A
8-1.	Pole locations and their conflict with utilities and drainage structures.			
8-2.	Controller, signal heads, pull boxes, pedestrian pole locations.			
8-3.	Vertical conduit.			
8-4.	Verification of conduit street crossing to become overhead.			
8-5.	Existing controller compatible to added items.			
8-6.	Fiberglass insulators needed for span wire due to power overhead lines and adequate provisions.			
8-7.	Number of detectors is right.			
8-8.	Any signs attached to the overhead span wire for the traffic signal.			
8-9.	Disposition of existing signal poles and other equipment if they are removed.			
8-10.	Signal arms far enough to provide sidewalk access.			
8-11.	Pole embedment conforms to proper depth criteria.			

Suggested Changes: (to be completed for items checked "NOT OK")

Item No.	Description of Change
Designer's Comments	
Designer's Comments	
Designer's Comments	
Designer's Comments	

9. SCHEDULE/PHASING/ACCESS

Item No.	Feature to be Checked	Ok	Not Ok	N/A
9-1.	Review of design and construction schedule for feasibility.			
9-2.	Scheduling and phasing with activity needs.			
9-3.	Access maintenance to all occupied spaces by reviewing scheduling restrictions, sequence of work restrictions, delineated work areas.			
9-4.	Type and limits of fence to be used for limited access highways.			
9-5.	Defined and designated lay down area and sufficient space for trailers, material storage and operations.			
9-6.	Requirements for local/state special permits.			
9-7.	Haul route different from most direct route and indicated in TCP.			
9-8.	Any walls or special access required to adjacent property.			
9-9.	Easement of available adjacent property for storage & construction.			
9-10.	Safe pedestrian access and access to business and residences provided.			

Suggested Changes: (to be completed for items checked "NOT OK")

Item No.	Description of Change
Designer's Comments	
Designer's Comments	
Designer's Comments	
Designer's Comments	

10. NATURE & ENVIRONMENT PROTECTION

Item No.	Feature to be Checked	Ok	Not Ok	N/A
10-1.	Erosion and pollution control items/measures.			
10-2.	Depiction of all existing trees and shrubs to remain and those to be removed.			
10-3.	Are the NPDES permit requirements addressed?			
10-4.	DEP and local agency requirements are clearly identified.			
10-5.	Provisions to prevent groundwater contamination/other environmental pollution.			
10-6.	Project's environmental protection safeguards with respect to dust control, erosion, and disposal of wastes.			
10-7.	Provisions for noise abatement (e.g., permanent noise walls)			
10-8.	Does the plan try to accommodate local noise ordinances?			
10-9.	Verification of landscaping and planting requirement and their conflicts with utilities (e.g., irrigation lines).			
10-10.	Where additional trees are planted, is there sufficient space (25-30') for power mowers?			
10-11.	Provisions for silt fences, turbidity barriers, etc.			

Suggested Changes: (to be completed for items checked "NOT OK")

Item No.	Description of Change
Designer's Comments	
Designer's Comments	
Designer's Comments	
Designer's Comments	

11. RECONSTRUCTIBILITY

When this project needs to be reconstructed, (i.e., repaving, widening, utility/drainage work, etc.) in the future, which of the following project components, as designed, will facilitate reconstruction?

Item No.	Feature to be Checked	Ok	Not Ok	N/A
11-1.	Earthwork design (e.g., "temporary" borrow, "additional excess," detour material, embankment, etc.).			
11-2.	Right of Way acquisition (e.g., for signal and lighting foundations, redesigned radii of drainage structures, utility relocation, construction easements, adequate workspace, desirable clear zone, etc.).			
11-3.	Geometrics and roadway alignment (e.g., curve data, sight distance, vertical datum, centerline, etc.).			
11-4.	Utilities (e.g., accuracy of location, proposed relocation, conflicts with other structures, future MOT impact, etc.).			
11-5.	Pavement (e.g., design criteria, flexibility to change, material alternatives, etc.).			
11-6.	Drainage structures (e.g., new and standardized structures, size of pipe, low head piping, interim drainage).			
11-7.	Lighting and signs (e.g., conduit size, service point locations, design of structures, compatibility, power source, etc.).			
11-8.	Other structures (e.g., mix design, strength, pile information, finishes, concrete, and steel requirements, etc.).			
Item No.	Comments			

Section 1.2

CONTRACT DURATION AND ALTERNATIVE CONTRACTING TECHNIQUES

1.2.1 Purpose

The purpose of this section is to provide a uniform methodology for establishing contract durations on construction contracts.

1.2.2 Authority

Section 20.23(3)(a) F.S. and Section 334.048(3) F.S.

1.2.3 References

FDOT Design Manual (FDM) Chapters 131 and 301, Guidelines for Establishing Contract Durations, Form No. 700-010-04, FDOT Standard Specifications for Road and Bridge Construction

1.2.4 Scope

This document was created to assist the District Scheduling Engineer and/or the Construction Consultant Engineering and Inspection services in establishing contract duration and to assist in determining which type of contract technique would be used on that project.

1.2.5 Background

Project duration is an integral part of every construction project let by the Florida Department of Transportation (Department). In the past, the time was set based on historical information of how long it took to complete similar projects. The methodology and forms used were rather rigid and implied that tasks followed one behind the other with no opportunity for two or more tasks to be performed concurrently.

The Department has instituted changes that affect the establishment of the contract duration. These changes place emphasis on decreased project duration and the overall time required from conception to completion of the construction improvement to decrease user costs and the cost of contract administration. The methods, outlined in this

procedure, allow the District Construction Offices more flexibility in establishing contract duration.

1.2.6 General Considerations

The Department establishes the contract duration on each construction contract. Several factors must be considered when establishing contract duration, such as:

1. Historical records of contractor performance on similar work.
2. Importance of the project to the implementation of Department Work Program.
3. Emergency conditions.
4. Annoyances in residential areas.
5. Traffic disruption and delay in high traffic areas and coordination with MOT plans.
6. Coordination with other activities, such as existing utilities and installation of new utilities.
7. Political sensitivity and public awareness.
8. Cost of Construction & Engineering Inspection (CEI) activities.

Many of these factors can conflict with others and not all of them will have the same importance for each project.

The contract duration shall be established in conjunction with design's Phase III review. If there are quantity changes following the Phase III review, the contract duration may require revision. It must, in any case, be firmly established in sufficient time for the Design Project Manager to calculate the quantities for the maintenance of traffic pay items before the Phase IV review. (see [Chapter 301](#) of the *FDM, Topic 625-000-002* for additional Plans Phase Reviews)

To assist the engineer establishing the contract duration, the Department has established guidelines for production rates. These guidelines will be periodically updated and are located on the State Construction Office website. Questions regarding the setting of contract duration should be directed to the District Scheduling Engineer.

Every effort should be made to involve the Resident Office in the Phase Review and in establishing the contract duration.

1.2.7 Initiating Specifications/Alternative Contracting Techniques

(A) District Level Responsibilities

The first step in setting duration for a contract is to determine if any special provisions apply. Establishing the contract duration requires familiarity with the project specifications and may require the addition of other specifications. Make sure these do not conflict with Department objectives or with local ordinances.

Any contract utilizing the special provision(s) shown below such as; Flextime, Incentive/Disincentive, No Excuse Bonus, A+B, Lane Rental, and Liquidated Savings shall be pre-approved by the appropriate authority as detailed in the Usage Notes on the applicable Specifications Workbook. Below is a description of the various alternative contracting methods and applicable usage requirements.

1. Flextime

Flextime start time is a contracting method intended to minimize disruption to the public. The contractor can use this additional time to mobilize sub-contractors, to coordinate with utilities, to submit shop drawings, to acquire material and equipment, and maximize all resources for the project. Flextime should also be used in cases where material procurement will dictate the start or finish of a project. Project duration for flextime projects can be minimized as a result of the opportunity for efficiency in building the project.

Flextime is meant to be used on minor projects where the extra time allowed to the contractor will result in reduced impact to the traveling public. If flextime is used, general time added to the contract duration should be eliminated, meaning that of normal schedules such as 8am-5pm, Monday – Friday (normal 5 (five) day work week). On a flextime job, contract time for utility conflicts should be included in the contract duration only if the utilities cannot relocate during the flextime period. The contractor must know by specification requirement what utility relocation must occur during flextime.

Flextime should not be used if its use will negatively affect the health, safety, or welfare of the public or an early completion date for a project critical to the Department's work program. Flextime should not be used if the physical condition or capacity problems that will be improved by the project need to be addressed immediately. On projects that would be inspected by consultant firms, consideration should be given to the impact of the flex- time on the consultant staffing and any price considerations.

The District Scheduling Engineer initiates the request to include a flextime contract provision with consultation with the Resident Engineer and the District Specifications Office.

The flextime period shall not exceed 120 days, unless otherwise approved by the Chief Engineer.

2. Special Working Hours & Periods

The District Scheduling Engineer shall coordinate the establishment of any restriction of working hours and periods of time with the District Traffic Operations Office and the Resident/Operations Office that will administer the construction contract. The District Scheduling Engineer will also coordinate with the District Specifications Office.

3. Special Events

The District Scheduling Engineer should seek the input of the Resident Office that will administer the construction contract and the Public Information Office regarding any special events that may impact the project. The District Scheduling Engineer should coordinate with Design Project Manager to identify Special Events which may restrict any or all contract operations and list such Special Events in the Contract Plans or in the Request for Proposal on Design-Build projects.

4. Schedule

The District Scheduling Engineer will determine the type of scheduling to be required for each specific project, e.g., bar charts, **CPM**, etc., and coordinate with the District Specifications Office to include the correct Special Provisions to require this type of schedule. A bar chart can be used only for the smallest projects (i.e., under \$10 million), however, **CPM** schedules are encouraged. **CPM** schedules are required for large and complex projects; e.g., those over \$10 million, urban projects with three (3) or more traffic phases or others deemed appropriate such as alternative contracting projects, buildings, Variable Message Sign(s), etc. **CPM** schedules are not required but are encouraged on simple projects such as 3R (Resurfacing, Rehabilitation, Restoration) or minor bridges, unless there are unusual conditions.

5. Compressed Time or Time Priority

The District Secretary or his delegate initiates and approves a list of time priority projects. This determination should be made early so that it will influence the design of the project and the times negotiated on the utility relocation agreements. Placement on the list of time priority projects will be considered in the establishment of the project duration and the coordination with the District Specifications Office.

6. Incentive/Disincentive

One of the most important considerations for justifying the use of an Incentive/Disincentive (I/D) provision is whether payment for early completion of the project or portion of the project is cost beneficial to the traveling public. This means that if the project is completed in a timely manner there will be limited disruptive effects, due to the construction project providing substantial safety, health and welfare to the traveling public. The I/D monetary amount set for a selected project shall be supported by an estimated cost of damages expected to be mitigated by early completion of the overall project or critical phase of work.

The amount of such I/D payment or such additional damages shall be established in the contract based on an analysis of the cost savings to the traveling public or revenue projections for a revenue-producing project. This determination of whether to use an I/D provision is made when developing the daily amount of I/D payment. This analysis may be done by using the Department's Road User Cost program and may be verified if there is a need by an approved process such as "QUEWZ-98", FHWA approved "Quickzone", ADOT model, software to calculate the daily I/D amount. The District level shall be responsible to determine if the use of these software packages or an equivalent process will be a reasonable representative cost analysis and shall be pre-approved by the State Construction Office. **Detailed calculations must be maintained and available for any further analysis.** Further guidelines for calculating the cost may be found in **AASHTO's (Red Book) "User and Non-User Benefit Analysis for Highways"**. If the per day amount exceeds \$50,000 then that amount will require approval by the Director, Office of Construction.

The beginning and ending dates (calendar day or contract date) for which the I/D applies must be clearly identified in the special provisions. The project schedule should clearly show the beginning and ending milestone dates for I/D work. If the I/D clause applies to the complete contract, then this should be stated in a special provision and shown on the contractor's schedule. Contract work items or any portion of the contract work items that are to be considered for I/D must be identified.

There are two other special provisions to consider for I/D provisions. Lane Rental and A + B Bidding allow for I/D payments or deductions. This incentive payment or disincentive deduction shall not exceed the dollar amount established in the provision. The total allowable number of Lane Rental Days is determined by the Engineer. If the Contractor uses less Lane Rental Days than allowed, the Department will pay an incentive at an established amount in the contract. If the

Contractor uses more Lane Rental Days than allowed, the Department will make a disincentive deduction established in the provision. A+B Bidding incentive payment or disincentive deduction shall be an established amount set in the provisions and will be based on original contract time.

There may be a re-evaluation of the incentive/disincentive amount if the contract amount changes from the original estimate or if the scope of work changes. Review the incentive/disincentive amounts and make the appropriate adjustments. Also retain any documentation created to reflect these changes.

Each "PS&E Submittal Package to Tallahassee" package for projects containing I/D provisions shall include a calculation sheet, attached to the District's recommendation for construction contract time, which documents the basis for the incentive/disincentive provisions. Impact cost estimates are to be included whenever it is feasible to calculate their value. In other words, the I/D and the monetary amount is set based on the Department's Road User Cost program to determine the damages or cost savings to the traveling public. This documentation shall be kept in the project file.

Projects containing the I/D Special Provision and which are Federal Aid participating shall have a copy of the justification sheet/s (back-up documentation) included with the contract documents for FHWA approval. The "justification sheet/s" should include several factors such as Daily Road User Cost, Accident Rates, CEI Cost, Maintenance Cost and other justifications such as impacts to community services or access to residential or business areas during construction.

When the Specifications Office preparing the project specifications reviews the project specification package, jobs with an I/D special provision must be identified. This will be detailed on the Transmittal of Plans, Specifications and Estimates Package sheet. (see [Chapter 131](#) of the *FDM, Topic 625-000-002*)

After the letting and the contract is being processed for award, the Contracts Administration Office shall make an I/D notation on the "Availability of Funds" memorandum, which is sent to the Office of Comptroller, Contract Funds Management Section. The I/D notation shall include the maximum number of allowable dollars (\$). The Office of Comptroller, Contract Funds Management Section will encumber an amount that includes the awarded construction cost and the maximum amount of the incentive cost that can be charged to the contract.

On Projects of Division Interest (PoDi) containing the I/D Special Provision, obtain

FHWA approval prior to issuing payments to the contractor for any portion or the full I/D amount.

Adjusting contract time during the I/D phase defeats the purpose of an I/D clause, and is not allowed.

7. No Excuse Bonus

No Excuse Bonuses should be used only on projects that have the highest levels of impact on abutting businesses and the traveling public. A designation of Level 4, as defined in the ***Guidelines for Community Awareness Process*** (see Appendix A), is a prerequisite. The No Excuse Bonus concept can be used to achieve particular milestones or for total project completion by a certain contract day or a specified date. The Scheduling Engineer must provide a maximum number of days and set the bonus date based on calendar date or an actual contract day.

Projects containing the No Excuse Special Provision, and which are Federal Aid participating shall have a copy of the justification sheet/s (back-up documentation) included with the contract documents for FHWA approval. The "justification sheet/s" should include several factors such as Daily Road User Cost, Accident Rates, CEI Cost, Maintenance Cost and other justifications such as impacts to community services or access to residential or business areas during construction.

On Projects of Division Interest (PoDi) containing the No Excuse Special Provision obtain FHWA approval prior to issuing payments to the contractor for any portion or the full I/D amount.

8. Time plus Money (A+B)

This provision is used on projects that may have a significant level of community impact and are a Level 3, as defined in the ***Guidelines for Community Awareness Process*** (see ***Appendix A***). Bidding Time plus Money provides the potential for decreasing contract time. A dollar per day figure must be calculated by the Department and included in the bid documents. A maximum number of days the contractor may bid must be provided.

9. Lane Rental

Use Lane Rental to minimize lane closures. Lane rental should be used where lane closures will severely inconvenience the traveling public, (for example, on Interstates, ramps, urban arterials, etc.). Maximum daily lane rental fee shall be established in the contract based on an analysis of the cost savings to the traveling public or revenue projections for a revenue-producing project. The dollar value of

each lane rental day is established by the Department using the Department's Road User Cost program and included in the bid documents. Since the intent is to reduce lane closures, project duration should be calculated normally.

Projects containing the Lane Rental Special Provision, and which are Federal Aid participating shall have a copy of the justification sheet/s (back-up documentation) included with the contract documents for FHWA approval. The "justification sheet/s" should include several factors such as Daily Road User Cost, Accident Rates, CEI Cost, Maintenance Cost and other justifications such as impacts to community services or access to residential or business areas during construction.

On those projects containing the Lane Rental Special Provision, which are Projects of Division Interest, prior to issuing payments to the contractor for any portion or the full I/D amount, FHWA approval must be obtained.

10. Liquidated Savings

The contractor will be rewarded for each calendar day the contract is completed and accepted prior to the expiration of the allowable contract time. The daily amount of liquidated savings should be equal to the liquidated damages.

Projects containing the Liquidated Savings Special Provision, and which are Federal Aid participating shall have a copy of the justification sheet/s (back-up documentation) included with the contract documents for FHWA approval. The "justification sheet/s" should include several factors such as Daily Road User Cost, Accident Rates, CEI Cost, Maintenance Cost and other justifications such as impacts to community services or access to residential or business areas during construction.

On those projects containing the Liquidated Savings Special Provision, which are Projects of Division Interest, prior to issuing payments to the contractor for any portion or the full I/D amount, FHWA approval must be obtained.

11. Damage Recovery

This provision is similar to Lane Rental provisions to assess a fee to the Contractor for not having all lanes open to traffic at a designated time as defined in the Traffic Control Plans. The dollar values are set for the first 30 minutes with proportional fees for each additional 30 minutes with a cap on the cost not to exceed a set amount within the 24-hour period. The dollar value of each assessment is established by the Department and included in the bid documents. These fees shall be calculated using the Department's Road User Cost program.

12. Special Notices/Directions to Contractor

- (A) Inform contractor if contract time is reduced from normal.
- (B) Inform contractor if additional contract time is supplied for anticipated utility conflicts.
- (C) Direct contractor to begin project by a specific day.
- (D) Inform contractor if work by others will be underway at either end or within the project limits, contractor will coordinate with other contractors. Include proper Special Provision with the contract.

1.2.8 Establishing Contract Durations

(A) District Level Responsibilities

The [Guidelines for Establishing Contract Duration](#) is published on the State Construction Office's web page under the title "Engineering Areas/Scheduling." This web page also contains an Excel spreadsheet with a set of production rates for many of the activities that occur in highway/bridge construction projects. Production rates for all possible activities are not included, nor are all production rates used in each construction job. The production rates may have to be supplemented with information from other sources and should be tempered with good engineering judgment and past experience with similar work. Other sources could be information provided from contractors and/or suppliers relating to unique activities or resources. Establishing a project's duration can be accomplished with the following steps:

1. Review the project plans with special emphasis on maintenance of traffic. Verify that the work to be performed in each phase of the projects Traffic Control Plan is constructible as shown. These phases should have been agreed upon at the production phase. If the project has more than one phase, determine what work can be done in each of the phases.
2. List the required activities for each phase. This list does not need to be exhaustive but does need to include all controlling items of work or activities on the critical path.
Most schedules are calculated using Primavera software and activities (items of work) are detailed in order to establish the critical path on a project. Some are very detailed, and others aren't, depending on the complexity of a project. These

controlling items determine the time which is the critical path. Some use a standard bar chart; others use more complex charts that tie dates and activities to drive the critical path.

3. List each quantity of the unit of work that will be used as a basis for estimating the duration of that activity, e.g., for storm sewers this would be the number of linear feet of pipe, etc.

On a project with more than one phase, use only that quantity associated with that phase. If the list of pay items show, for instance, 10,000 cubic yards of excavation for a project, that has two phases, that have approximately the same amount on each phase, put 5,000 cubic yards as the unit of work for excavation in Phase 1 and 5,000 cubic yards as the unit of work for excavation in Phase 2. Extreme accuracy is not required. It is only necessary that the parts of a quantity of a pay item sum to the whole, but a percent or two of error on any phase will not affect the results. For a project with two phases, this may be a 50%-50% split for a particular pay item. This is just as accurate as using a 45%-55% split.

4. Use the production rates and charts to convert the units of work into workdays. Do this for each activity in each phase. These rates and activities may be recorded on **Form No. 700-010-04, Estimate of Contract Time**.
5. Review the appropriate approved Utility Work Schedule and or Agreements to determine what part of the requested utility adjustment potentially impacts the Contractor's work. A delay occurs only if the prime contractor cannot work as a result of utility conflicts or due to other unforeseeable conditions as spelled out in [Standard Specifications 8-7.3.2](#). Assume good cooperation between the utility and the contractor during the actual construction of the project. Utility relocation duration should be handled as an activity if they will contribute to the project duration.
6. Multiply each of the workdays by a factor of 1.40 to convert them to contract days.
 - (1) The factor of 1.40 is based on 5 (five) working days per week. Implicit in this factor is the assumption that the contractor will use "normal" crews and equipment and will work a "normal" workday.
 - (2) If special provisions modify the time requirements of the project, then it may be appropriate to use another factor based on number of allowable working days and allowable working hours, either larger or smaller. For a project with incentive/disincentive, a factor of 1.0 or less could be used. This would

be based on the assumption that the contractor would work 7 (seven) days per week with extended work hours. On the other hand, if the special provisions curtail the number of hours per day the contractor may work, the factor used may be larger than 1.40.

On Compressed Time or Time Priority Projects, the Scheduling Engineer may assume longer working hours, multiple crews, and 6 (six) or 7 (seven) day work weeks to accomplish a decrease in the project duration. Projects containing a No Excuse Bonus provision should have reduced project durations. Projects with a Liquidated Savings provision should be calculated using a 6 (six) day work week.

On A+B projects, the maximum number of days is calculated using normal production rates and 5 (five) day work week.

When using a computerized scheduling software package, workdays will be converted to calendar days using the calendar function in the program.

The report(s) from the scheduling software and/or non-computerized form should show, as a minimum, for each activity: id, description, quantity (of work), unit (of work), duration, early start, early finish, and days of total float.

1.2.9 Documentation

(A) District Level Responsibilities

On each worksheet establishing Project Duration, add the Financial Project ID, county name, the contract time, and the name and phone number of the person who established the contract duration. Also provide backup documentation of how time was established. (**Form No. 700-010-04, Estimate of Contract Time**).

Schedules are considered a part of the "PS&E Submittal Package to Tallahassee". Instructions for submitting the complete "PS&E Submittal Package to Tallahassee" are included in [Part 1](#) of the **FDM, Topic No. 625-000-002**.

1.2.10 Prosecution

(A) District Level Responsibilities

The contract duration is not final until the project is bid. Up to this point in time, the project duration can be influenced by changes in design or by other external reasons. The designer (Project Manager) and the District Scheduling Engineer shall coordinate all changes that would affect the contract duration.

The Design Project Manager and or Utility Project Manager should notify the District Scheduling Engineer when revisions or changes are made, such as approved Utility Work Schedule changes. These revisions/changes could impact the contract duration that was established by the Scheduling Engineer.

1.2.11 Training

The training of staff for establishing Contract Duration will usually be the responsibility of each District. However, there are times when the State Construction Office may coordinate or suggest a particular course or class to attend in helping to calculate Contract Time.

1.2.12 Forms

To assist in calculating contract time on a project **Form No. 700-010-04, Estimate of Contract Time** may be used. See **Section 1.2.7(a) 4 & 6** above for detail in using this form.

APPENDIX A:

GUIDELINES FOR COMMUNITY AWARENESS PROCESS

This guideline is for the use of the District Construction Offices. Some, if not all districts have internal procedures for Community Awareness activities. These plans are not uniform from district to district. This guideline is meant to supplement and complement district procedures.

1. Definition

Community Awareness is a term used to describe both the minimization of negative impacts to the community and traveling public of a construction project and the Department activities that take place to keep the community informed.

2. Team Approach

Several districts have already developed quality control plans that require a multi-disciplinary team approach to plans development. In addition to this, various offices in the Central Office are recommending a team approach to solve specific deficiencies in our project development process. Community Awareness is one of those things for which a team is being recommended. It will be interesting to see how each district handles all of these recommendations to form teams. Instead of several teams, the District probably will identify some, but not all, of the projects that require a team to guide it along its way. There will be a core team that will continue during the duration of the project with additional people providing expertise as required.

The importance of this team approach is that it allows the district construction offices to have input to the project beginning with the definition of what the project will be until the project is let.

3. Involvement in Project Development

Scope Development and Definition: Several districts, as part of their District Quality Control Plans, have required the participation of the District Construction Office in establishing the scope of each project. Subsequent reviews have indicated that an incomplete scope at the very start as one of the Department's major problems. Projects with scopes that evolve as the project develops will contribute to extra cost, rework, and poor quality control on the plans. Worse, in terms of community involvement, they can create conditions that will be difficult to overcome during the construction process. The District Construction Office needs to take advantage of every opportunity offered to it to be on a team or otherwise prevent problems on our construction projects - beginning with scope development.

Define level of Community Awareness needed: The Department has developed a "Commitment Compliance Tracking System" to record commitments made during project

development. The District Construction Offices need to take advantage of this new system. At scope development, a level of public concern should be associated with the project from level 1, the least, to level 4, the most. The level definition is provided below to assist in this designation. The designation of a particular level of concern does not, however, designate or restrict required actions. This designation should be entered into the Commitment Compliance Tracking System.

- **Level 1:** Project is not controversial, causes negligible access impacts and traffic disruption. Examples are work outside the roadway, simple rural resurfacing, some signal work, pavement markings, bridge or other maintenance.
- **Level 2:** Project has general public acceptance, little impact on access and reasonable degree of traffic disruption. Examples are urban resurfacing, bridge repairs, and median revisions (not access control) that require lane closures.
- **Level 3:** Project is controversial, will significantly impact traffic flow or will adversely affect access to properties (temporarily or permanently). Examples are parking removal, median opening closures, traffic signal removal, roadway widening, major reconstruction, and projects with detours.
- **Level 4:** Project involves interstate work including maintenance work, road widening, temporary ramp closures, construction of new interchanges, and major reconstruction. Also included in Level 4 are all projects that require total closure, either temporary or permanent, of roadways, bridges, or railroad crossings.

Designate Time Critical Project: For numerous reasons, including minimizing community impact, there are projects that the districts desire to be performed in a period much less than that which would be normally established for a project duration. For this desire to be realistically attained the district should designate the project as “Time Critical” as early as practicable. This should also be recorded on the Commitment Compliance Tracking System. This should be a signal to the designer to give short project duration a priority consideration when designing the project. This should also be a signal for utility relocations to be started early and for utility relocation agreements to contain expedited times.

4. Design Phase

Plans Reviews: Access management driveways and median openings: Decisions on access management and median openings are made very early in the design process. These decisions cause some of the more contentious issues during construction, but there probably is not anything the construction personnel can do about them.

The Phase I Plans Review is the most important phase review for minimizing community impacts. Major decisions are made at this stage that cannot be ameliorated during construction. Decisions that affect MOT, access, and drainage are made and cannot be

undone in future phases.

This phase review package should contain a Conceptual Maintenance of Traffic Plan. This plan should be reviewed to assure minimum impact on abutting property owners. Any condition that would make it difficult to provide simple and direct access to property on both sides of the road should be avoided. The reviewer should make sure that the designer has attempted to strike some happy medium between a small number of MOT phases, of long length and duration, and a higher number of MOT phases of short length and duration. A smaller number is conducive to a shorter overall project duration. MOT phases of short duration cause less inconvenience to abutting businesses.

Another aspect of the plans that merits careful review is any change in vertical alignment. On an urban reconstruction or widening the designer should maintain the existing alignment to the extent possible. Changes in vertical alignment make it very difficult to maintain access on the main roadway and even on side streets. Lowering the alignment can also cause unforeseen utility relocations if there is not sufficient cover for mainline utilities and service connects after the grade is lowered. Access to property on side streets will also be affected when grades are changed on the main roadway.

The combination of MOT and vertical alignment will also impact drainage during the construction process. The reviewer should make sure that the designer does not set up a situation where water will pond on the project or where a heavy rain will cause delays. Additional guidance on plans phase reviews is in the Construction Project Administration Manual Chapter 1, Section 1, Plans Review and Comments.

Specifications: The District Construction Office can recommend that special provisions, that help minimize community impact, be included in the specification package for the project. Examples of this are restricted working hours, night work, contractor suspended operations on specific days, day certain starting and day certain project completion, restricted work length (train spec), and alternative contracting methods.

Project Duration: The District Construction Office establishes the project duration. They have the option of shortening this project duration if it will minimize the community impact of the project. Additional guidance for establishing project duration is included in the Construction Project Administration Manual Chapter 1, Section 2, Contract Duration and Alternative Contracting Techniques.

Alternative Contracting: The Department has developed a battery of innovative contracting schemes to minimize community impact. Examples are Incentive/Disincentive and no excuse bonuses. These schemes also require that special provisions are included in the specification package. Additional guidance is contained in the Alternative Contracting User's Guide.

5. Construction Phase Best Practices

The Project Engineer/ Project Manager must develop a Community Awareness Plan as early as practicable. If a Consultant CEI will be involved, community awareness activities must be included in the scope of services. The extent of activities is dependent on the Level of Concern. On Level of Concern 3 or 4 projects, the Project Engineer/Manager should consult with the District PIO or Community Awareness Coordinator when developing the plan or RFP and scope.

Listed below are the minimal elements for a Community Awareness Plan:

- Date of the plan and each revision
- Name of the person initiating the plan
- A brief, but detailed, description of the project and summary of traffic impact.
- Description of the community and properties affected by the project.
- Discussion of any removal of any off street parking (if any) and how it will affect adjacent properties and businesses.
- Special features/amenities that will be included in the project, including but not limited to, landscaping by whom and who will maintain it.
- A list of known community concerns and a strategy for addressing them. (*Where appropriate*)
- A list of all PD&E and Right of Way commitments made to the public and how they will be addressed. (*Where appropriate*)

An additional topic should be added to the pre-construction conference agenda. On projects where there are known community concerns, these should be addressed. The contractor should be requested to assist the Department to minimize public complaints by keeping access to business well maintained and to keep the stock piling of materials in front of businesses to a minimum. The contractor should also be requested to remove trash as soon as possible. (*All projects*)

1 month prior to construction start: "Dear Neighbor" flyer with construction dates and specific project impact to traffic information. This flyer should contain the name of the contractor, contractor's superintendent, and FDOT Project Engineer, with field office locations and the appropriate telephone numbers. The preferred method for distributing this flyer is for the Project Engineer to hand deliver door to door. (*All projects*)

1 week prior to construction start: News release of project start date, pertinent project information and specific traffic information. This is usually done working through the District PIO and the District Community Awareness Coordinator. *(All projects)*

Throughout construction: The project Engineer should keep the District Public Information Office (PIO) and the Public Information CEI, if there is one, informed of all issues affecting the public. Weekly news releases with specific traffic impact should be issued by the PIO and Public Information CEI. *(All Projects)*

Other elements that may be considered:

2 to 4 weeks prior to construction start: Pre-construction public information meeting/open house for all interested persons to review plans, construction schedule, and traffic impacts, particularly dates of total closure. Conducting additional meetings during the project as milestones are reached should also be considered. Meetings can be open house style, held at field office locations or locations close to the project. Project staff may also make presentations at local community or homeowner association meetings. *(Level of Concern 3 and 4)*

A newsletter may be used to keep those interested informed about the current project status and specific issues. *(Level of Concern 3 and 4)*

An internet site to supplement other forms of notification and to provide another means for input of questions and concerns. *(Level of Concern 3 and 4)*

Information kiosks can be used to provide information to the general public on projects of community wide interest. *(Level of Concern 4)*

Supplemental meetings with Homeowner Associations, the Chamber of Commerce, or other interested groups can be held upon request. *(Level of Concern 3 and 4)*.

6. Listen and Be Responsive:

On the construction project, it is important that every DOT/CEI employee be willing to listen to problems and complaints from property owners and the traveling public. When possible, try to do something about the problem the people are complaining about. When it is not possible to do something, such as median closings, limited driveways and loss of parking, be sympathetic and try to explain the reasons for these changes.

All communications with abutting businesses and residents should be recorded. When possible, all concerns should be responded to in writing.

Acknowledgements: This guideline was drafted using, to a large degree, the content of the Community Awareness guidelines from Districts 4 and 7.

Section 1.3

BID QUESTIONS AND ANSWERS

1.3.1 Purpose

To improve the quality and interpretation of the contract plans, the Department has developed a process to provide bidders the opportunity to ask questions or seek clarifications prior to submitting bids. As a result of this effort, the Department has established a website for bidders to submit questions and/or clarification requests to the Department. The Department will post responses to those questions and/or clarification requests to the same website.

This section describes the Department's process of listing advertised projects on a Bid Question and Answer website, receiving questions and/or clarification requests submitted by bidders and providing appropriate responses to those questions and/or clarification requests.

1.3.2 Authority

Sections 20.23(3)(a) and 334.048(3), Florida Statutes (F.S.)

1.3.3 Reference

Section 2, Standard Specifications for Road and Bridge Construction, Section 2-4, Special Provision (SP0020400), Examination of Contract Documents and Site of Work, applicable to all projects

1.3.4 General

Bidders may submit bid questions and/or clarification requests to the Department's website at: [Bid Questions & Answers](#) prior to bid in accordance with the dates and times shown in Special Provision Section 2-4 of the Contract Documents.

Bidders will review and be familiar with all questions and responses posted to this website prior to the bid opening and to make necessary adjustments to the bid proposal, accordingly.

The Department will utilize the same Pre-Bid Question and Answer website to post responses for questions and/or clarification requests submitted by bidders.

The Bid Question and Answer website shall not be used by the Department to correct errors in the Contract Documents identified by the Department or Contractors. Clarifications and/or corrections of errors identified by the Department shall be handled in accordance with current processes governing the issuance of Contract Addendums.

1.3.5 Operation and Maintenance of the Bid Question and Answer Website

District Responsibilities

The District Construction Office (DCO), with support from the Office of Information Technology (OIT), is responsible for administration of the Bid Question and Answer website on all projects in their respective District.

1.3.6 Listing Advertised Projects on the Bid Question and Answer Website

District Responsibilities

DCO staff shall ensure that all advertised Central and District Let projects in their District are listed on the Bid Question and Answer website. DCO staff shall ensure that the Bid Question and Answer website can receive questions and/or clarification requests from bidders as of the date the project advertisement appears on the Central and/or District Contracts Administration Office website.

1.3.7 Responding to Questions and/or Clarification Requests Submitted to the Bid Question and Answer website

District Responsibilities

The Department should not make modifications to questions and/or clarification requests submitted to the Bid Q&A website to the extent that such modifications would change the original intent of the question and/or clarification request as submitted by the bidder. In those situations where inappropriate content (i.e. derogatory comments, personal, proprietary or sensitive information, etc.) is included as part of a legitimate question and/or clarification request submitted to the site, the Department may modify the questions and/or clarification by removing the inappropriate content. Such modifications are not intended to be used to correct spelling, grammar, syntax, etc. errors and should be used in limited circumstances so as to avoid potentially changing the original intent of any question and/or clarification request submitted by the bidder. As bid questions and/or clarification requests are received, DCO staff shall review

each question and/or clarification request for the purpose of developing a response and posting the response to the Bid Question and Answer website. DCO staff assigned with this responsibility shall be familiar with the project and Contract Administration procedures. DCO staff assigned with this responsibility shall coordinate with Department personnel and/or Consultants involved in project development (i.e. Design Project Manager, Construction Project Manager, Utility Project Manager, Engineer of Record, etc.), when necessary for the purpose of developing a response to the question and/or clarification request.

The District Construction Engineer (DCE), or designee, shall review each question and/or clarification request submitted as well as each proposed response to questions and/or clarification requests and shall approve each response prior to posting the response to the website. In the event a previously posted response is to be revised, the DCE, or designee, shall review and approve each revised response prior to posting the revised response to the website. The DCE may delegate such review and approval authority, in writing, to an individual within the DCO staff, but not to a Consultant or Resident Engineer. Such delegation shall be maintained on file in the DCO. An email from the DCE, or designee, which signifies review and approval of the question and proposed response, will suffice as documentation of review and approval.

The DCE or designee shall respond to bid questions and/or clarification requests as described in Special Provision 2-4 of the Contract Documents.

Regardless of the bid opening month, the DCE, or designee, shall ensure responses are posted to the website by 8:00 AM (EST) the second (2nd) calendar day prior to the bid opening day.

In the event a previously posted response is to be revised, the DCE, or designee, shall ensure the original response (including the date and time the original response was posted to the website) and the revised response (including the date and time the revised response was posted to the website) are posted to the website.

The DCE, or designee, shall ensure that no responses (original and/or revised) are posted to the website and no modifications are made to previously posted responses after 8:00 AM (EST) the second (2nd) calendar day prior to the bid opening day.

1.3.8 Providing all Questions, Clarification Requests and Responses to the Contracts Administration Office

District Responsibilities

After the bid opening, DCO staff shall ensure that all questions and/or clarification

requests submitted by bidders and all responses posted by the Department are submitted to the Contracts Administration Office. This submission shall occur no later than 5:00 PM (EST) on the business day immediately following the bid opening. For Central Let projects, this submission shall be made to Central Office Contracts Administration. For District Let projects, this submission shall be made to District Office Contracts Administration.

1.3.9 Compliance with this Section

District Responsibilities

The District shall identify and maintain a list of the following in the DCO files:

- A. DCO staff responsible for administration of the Bid Question & Answer website on the District Level;
- B. DCO staff responsible for receiving bid questions and/or clarification requests;
- C. DCO staff responsible for coordinating and developing proposed Department responses;
- D. DCO staff, if other than the DCE, responsible for reviewing and approving all proposed responses and all subsequent revisions to previously posted responses;

Central Office Responsibilities

The State Construction Office will review a sampling of bid questions, clarification requests and Department developed responses and report significant findings to the DCE as necessary.

Section 2.1

PROJECT SCHEDULING

2.1.1 Purpose

To provide a uniform procedure for monitoring construction contract time and schedules.

2.1.2 Authority

Sections 20.23(3)(a) and 334.048(3), Florida Statutes (F.S.)

2.1.3 General

The project schedules required on each project should be working documents used by the Contractor to plan and direct the construction project. If the project schedule is not updated by the contractor in a timely manner, this could reflect on the CPPR (Contractor Past Performance Rating) grading as outlined in **Section 13.1** of the **CPAM (Construction Project Administration Manual)**. This would be evaluated in category 3 (Timely and Complete Submittal of Documents) within the **Contractor's Past Performance Report, Form No. 700-010-25**. The Contractor must coordinate their own work with that of the subcontractors and utilities. If used properly, the schedule is a management and communications tool that can be used to anticipate and prevent problems from occurring. These issues shall be discussed during weekly progress meetings.

2.1.4 Contract Schedule

(A) Resident Level Responsibilities

Once the project is awarded, the Contractor prepares a proposed Contract Schedule in accordance with contract documents which in turn is submitted to the Project Engineer. The Project Engineer, with the involvement of the District Scheduling Engineer, reviews the schedule, and if it meets contract requirements, submits it to the Resident Engineer for acceptance. If the district doesn't have a designated Scheduling Engineer, then the Resident Engineer would review the schedule. If the schedule does not reflect a reasonable or feasible plan to construct the project in the authorized contract time or the schedule is not prepared according to the specifications, the schedule will be rejected. Schedules should indicate the completion of the project within the allowable contract time.

The Department will accept Bar Charts for projects less than \$10million.

The following items should be checked for when a CPM Schedule is being utilized:

- (1) The schedule reflects the phases in the MOT plan.
- (1) Activities are broken-out by phase.
- (2) Phases are in correct sequence.
- (3) Order of the activities is logical.
- (4) The schedule contains all milestones specified.
- (5) Utility work is shown.
- (6) Activity durations appear reasonable.
- (7) Level of detail reflects the complexity of the project.
- (8) Complete and concise description of the Contractor's Construction Plan.
- (9) The submittal is complete as per the contract documents and contains preparation (Contractor's time) review and approval (Department's time), and fabrication and delivery (manufacturer's/supplier's time) activities for each category of submittal required.
- (10) Activities include procurement time for material including shop drawing submittal and approval process.
- (11) All non-workdays are shown.
- (12) Check constrained activities.
- (13) Any activity that applies cost loading (has a budgeted cost) should conform reasonably well within the amount bid for same type work.

If the schedule submitted by the Contractor shows an early completion date, the schedule shall be reviewed thoroughly. The early completion date shown on the schedule could be

attributable, in whole or in part, to errors in logic, unrealistic production rates, or the absence of critical activities. A schedule may not be rejected solely based on having a completion date earlier than that shown on the contract.

A Contract Schedule which is rejected should be done so in writing, detailing the reasons for the rejection. A Contract Schedule must also be accepted in writing. After acceptance, this Contract Schedule becomes the **Baseline Schedule**. This Contract Schedule is the schedule by which progress of the project is gauged.

2.1.5 Revised Schedules and Monthly Updates

(A) Resident Level Responsibilities

When the contract time is significantly altered by time extensions or supplemental agreements, the Department may request the Contractor to submit a revised **Bar Chart** or Critical Path Method (CPM) Schedule. Requests for **Revised Schedules** should be in writing. Revised Schedules must be accepted, accepted as noted or rejected in writing. Rejections must be done so detailing the reason for the rejection. When the contract specifies a **CPM Schedule**, the schedule should be updated on a monthly basis to coincide with the progress payment period. These updates should include all approved time extensions, and supplemental agreements. These **Monthly Updates** should be reviewed for accuracy and any significant revisions in logic or duration from the Contract Schedule and previously accepted Monthly Update must be addressed in writing when found to conflict with the contract. Monthly Updates must be accepted, accepted as noted or rejected in writing. Rejections must be done so detailing the reason for the rejection.

The following items should be considered when reviewing Monthly Updates:

- (1) Check to make sure that the actual dates (for activities either in-progress or completed) and the percentages complete/days remaining are historically accurate.
- (2) Run the scheduling calculation in the "log to file" mode and Primavera will itemize the "open ends." Check to make sure that all "open ends" are closed, so that all calculated float values are accurate and not inflated. All activities except the first one should have predecessors, and all activities except the last one should have successors.
- (3) Similarly, run the scheduling calculation in the "log to file" mode and Primavera will itemize the "out-of-sequence progress." Remedy the out-of-sequence progress by making logic changes that are agreed to between the Engineer and the contractor.

- (4) Ensure on a continuous basis that the Contractor is pursuing the critical path work activities. The "three-week schedule" and "controlling items of work" that the Contractor submits should indicate that he is primarily working on the critical or near critical activities, as a minimum.
- (5) Run a comparison using "Schedule Comparison" (i.e. "Claim Digger" for versions prior to P6 Version 16.1) between the Monthly Update and the previously accepted Monthly Update and the Contract Schedule to see if the Contractor made any unauthorized changes to either the original durations or logic or, if he added any unauthorized constraints. If he did, bring it to his attention and resolve it with the Contractor.
- (6) In addition, the "Schedule Comparison" will itemize the "activities that should have started this update but did not" and the "activities that should have finished this update, but did not". Bring these to the Contractor's attention, particularly the critical or near critical activities, to help get him back on track.
- (7) Lastly, check to make sure that all holidays, suspension days and weather days granted through the update are put into the schedule's calendar as "non-work" days, so that they are considered when the schedule is calculated."

2.1.6 Schedule Distribution

(A) Resident Level Responsibilities

Electronic files (XER and/or PDF) of all Contract Schedules, Revised Schedules and Monthly Updates will be kept in the Department provided web-based collaboration site.

2.1.7 Withholding Progress Payments

(A) Resident Level Responsibilities

Specifications for project schedules allow the withholding of progress payments to the Contractor if the Contractor fails to finalize either the Contract Schedule, Monthly Update, or Revised Schedule in the time specified in the specifications. If a Contractor is making a good faith effort at developing a schedule, withholding payments may not be appropriate. If a Contractor is not making a good faith effort, the project personnel can use withholding payment to convince a Contractor that the Department is serious in its desire to have an

acceptable schedule. An acceptable schedule implies good coordination and good communication.

If the Contractor submits a Contract Schedule, Monthly Update or Revised Schedule which indicates completion of the project after the expiration of allowable contract time, Resident staff shall consult with the District Construction Office, State Construction Office and the Office of General Counsel prior to notifying the Contractor of Schedule Revision acceptance.

Section 2.2 FINAL ESTIMATES PRE-PLANNING

2.2.1 PURPOSE

This section introduces procedures for the pre-planning of required ***Final Estimates Documentation*** to assist those charged with the responsibility of recording final quantities and preparing final estimates. It is intended to help construction personnel determine the pay item information that is to be documented, reviewed, and submitted with the ***Final Estimates Documentation*** to the District Final Estimates Office (DFEO).

2.2.2 CONSTRUCTION FIELD OPERATIONS

The Project Administrator (PA) and/or designee responsible for the final estimate must be familiar with the Specifications, method of measurement, and basis of payment for each pay item on the project. Accurate and up-to-date field records must be kept as the project progresses to ensure that final estimates are compiled in an efficient and timely manner.

The following guidelines must be observed:

- (A) Always check to ensure there is a pay item summary box/Estimated Quantities Report tables for each item in the Plans before construction begins. The summary boxes/tables will show the location, quantity, and applicable design notes. Coordinate with the Engineer of Record (EOR) per ***CPAM 5.13***.
- (B) Verify that the documentation to support each pay item quantity (i.e., electronic shape files, Area IDs, calculations, sketches, or spreadsheets) is included in the Plans Digital Delivery package. (See ***CPAM 5.14, 5.15, and 5.16*** and ***CADD Manual***.)
- (C) Verify the contract information is entered into AASHTOware Project Construction (PrC) correctly (i.e., pay items, quantities, unit prices, liquidated damages amount, and fuel flag selected when applicable).
- (D) Schedule a final estimates kick-off meeting with the DFEO to review ***Final Estimates Documentation*** requirements. Any question on pay item interpretation, adjustment, extra work, or documentation requirement for any item must be resolved with the District Final Estimates Manager (DFEM) as it occurs. Do not wait until the end of project.

- (E) Add the contract to the [Final Estimate Status \(FES\)](#) application. The fields on *Contract Information* tab, most importantly the *CEI Name* field, should be completed prior to construction beginning.
- (F) Open project-specific forms via the Construction Automated Reporting System (CARS), send to the Contractor via email or email directly to the collaboration site. Inform the Contractor that all other forms are located on the Construction website and on the Forms and Procedures Office website. Ensure the contractor is aware the latest form version must be utilized regardless of what is provided by email or in the collaboration site.
- (G) Errors in plan quantity items must be addressed per **CPAM Section 5.13**.
- (H) Final measured items must be reviewed to determine which type of measurements, sketches, and/or calculations are necessary to document final payment, as well as identify the appropriate site source record to be used. Field Records must be maintained per **CPAM Sections 5.14, 5.15 and 5.16**.
 - (1) Once a pay item is included in a progress estimate, supporting documentation for that quantity must be available electronically in the project files for review (i.e. the collaboration site and/or EDMS).
- (I) Removal items [i.e., existing pavement (if a separate pay item), existing concrete (excluding drainage structures), guardrail, pavement markings, etc.] must be measured and recorded before that item is removed.
- (J) Decisions regarding earthwork items' cross-sections must be made before clearing and grubbing work has started. Earthwork documentation must be maintained per **CPAM Section 5.16**.
 - (1) Verify (spot check) the accuracy of 3D files/models when used.
- (K) Designate the digital file(s) to be used for the Final As-Built Plans prior to the start of construction and update the Final As-Built Plans as the work progresses to support progress payments. Final As-Built Plans must be separated by component and maintained per **CPAM Section 5.12**.
- (L) Ensure any additional preferences or requirements from the District/DFEM are fulfilled.

NOTE: Only final measured pay items are final measured. Plan quantity items are not final measured. Only field changes and plan errors to plan quantity items are measured and documented for payment backup.

Section 3.1

PRECONSTRUCTION CONFERENCE

3.1.1 Purpose

This section details who should be included and the information to be covered and discussed in the **Preconstruction Conference**, as well as the meeting scheduling, notification, agenda, and minute requirements.

3.1.2 Authority

Sections 20.23(3)(a) and 334.048(3), Florida Statutes (F.S.)

3.1.3 References

Section 337.125, F.S.

3.1.4 Scheduling

(A) Resident Level Responsibilities

The Project Administrator (PA) will schedule and conduct a **Preconstruction Conference** after receipt of the **Notice of Award** and prior to any work beginning. The scheduled date of the **Preconstruction Conference** must be selected to accommodate the interests of all affected parties. Notice of the scheduled date must include a brief description of the project. The project description must be written in terms easily understood by the general public.

A **Utility Coordination Meeting** will also be held with the Contractor and all utility companies. This meeting should be held as soon as possible after the **Notice of Award**. The purpose of the meeting is to determine the utilities' progress/status of proposed relocation.

When the Contract requirements indicate that there is a need for a **Post-Preconstruction Conference** to discuss Disadvantaged Business Enterprise (DBE), Equal Employment Opportunity (EEO), and On the Job Training (OJT) requirements, the PA must notify all affected parties in writing and conduct said meeting prior to construction beginning.

3.1.5 Notices

(A) Resident Level Responsibilities

Prior to scheduling the **Preconstruction Conference**, the PA will request, in writing, that the Contractor submit a list of plan errors, omissions, or ambiguities and any other issues that need to be discussed at the **Preconstruction Conference** to clarify the **Contract Plans** and **Special Provisions**. If the project requires a Dispute Review Board, the PA will request the name of the Contractor's representative, so that the Department's member can meet with that representative and they can jointly name the third member of the board.

The **Preconstruction Conference Notice** must contain the date, time, and the location of the meeting. The **Preconstruction Conference Notice** will be sent to the parties known to have an interest in the proposed project including, but not limited to:

- (1) Utility Companies
- (2) City
- (3) County
- (4) Federal Highway Administration
- (5) Coast Guard
- (6) Police, Highway Patrol, Sheriff
- (7) Department of Environmental Protection
- (8) Department District Representatives
- (9) Contractor Representatives
- (10) Subcontractor Representatives, including DBE Subcontractor Representatives
- (11) Contractor Supplier Representatives
- (12) Special Interest Representatives
- (13) Engineer of Record
- (14) Department Design Project Manager
- (15) Any agency having permitting authority
- (16) State Toll Facilities Coordinator
- (17) Emergency Medical Personnel

- (18) Local Transit and/or Port Authority
- (19) Railroad Representatives
- (20) Florida Jobs and Benefits
- (21) District Public Relations Office
- (22) Dispute Review Board
- (23) U.S. Department of Labor
- (24) Army Corps of Engineers (ACOE)
- (25) Water Management District(s) (WMD)
- (26) District and Local Maintenance Offices (Resident Maintenance Engineer or Operations Engineer, as appropriate, and Asset Maintenance Contractor, if applicable)
- (27) District Environmental Management and Environmental Permitting Representatives
- (28) District Contamination Coordinator

The **Preconstruction Conference Notice** addressed to the Contractor will contain a list of items required to be submitted prior to the **Preconstruction Conference** such as: EEO documents, erosion control and storm water pollution prevention plan, maintenance of traffic (MOT) plan, channelizing device supplier (CDS), proposed work schedule, list of equipment (including the model number, serial number, and date of manufacture), MOT certificate of qualification for the Worksite Traffic Supervisor, vehicle registration affidavit, and Quality Control Plan. The above listed plans must have written approval before any construction activities begin per **Specifications** requirements.

A **Preconstruction Conference Notice** to the Florida Department of Environmental Protection (DEP) must contain the DEP file number assigned to the permit when work is covered under a DEP permit.

Pursuant to [Section 337.125\(2\), F.S.](#), the **Preconstruction Conference Notice** must be sent to each DBE subcontractor anticipated to perform work on the Contract.

3.1.6 Agenda

(A) Resident Level Responsibilities

The PA will prepare a **Preconstruction Conference Agenda** similar to one shown in [Guidance Document 3-1-A](#). The **Preconstruction Conference Agenda** should include the submittal requirements required by the Contract.

3.1.7 Minutes

(A) Resident Level Responsibilities

The **Preconstruction Conference Minutes** must be transcribed to typewritten form as soon as practical. The completed **Preconstruction Conference Minutes** will be sent to all attendees of the **Preconstruction Conference** and any other interested parties within fourteen (14) calendar days from the date of the meeting with a request that any errors and omissions in the **Preconstruction Conference Minutes** be returned to the writer within fourteen (14) calendar days. All preconstruction construction dialogue must be recorded by digital recorder or video. The recording will be retained as part of the project records in the **Electronic Document Management System (EDMS)**.

NOTE: Before the start of any project level meeting the following statement must be read: **“This meeting is being audio/video recorded and will become part of the construction project records.”** These recordings should be converted to a digital format (MPEG, AVI, FLV, or WMV) and uploaded into **EDMS** as part of the project files.

3.1.8 Attachments

[Guidance Document 3-1-A](#)Sample Preconstruction Conference Agenda

Guidance Document 3-1-A Sample Preconstruction Conference Agenda

ITEMS BELOW ARE MANDATORY FOR ALL CONTRACTS:

- (1) Project Description
- (2) Delineation of Lines of Authority: [Names and emergency telephone numbers for the Contractor, Department, Consultant, and others will be entered into the record and an Issues Escalation Matrix will be established. Contacts should also be entered into the Construction Information & Monitoring (CIM) application, including the Project Manager, Project Administrator, and Contract Support Specialist.]
 - (a) The Issues Escalation Matrix should generally follow the District hierarchy prior to shifting to Central Office: Project Administrator → Resident Engineer → District Construction Engineer → District Director of Operations → Director, Office of Construction → Chief Engineer
 - (b) Due to the specialized nature of matters related to EEO, OJT and Wage Compliance, alternative escalation steps may be implemented which route such requests to the DCCM and State Construction Compliance Specialist.
 - (c) The Issues Escalation Matrix may be modified as needed to meet the demands of the project. Once established, every effort should be made to address issues at the lowest level and to engage each level in turn as issues escalate.
- (3) e-Construction [Discuss all persons requiring access to the collaboration site, use of the collaboration site, digital signature requirements and use (including approved providers and digital signature verification), submittal of forms (including utilizing latest approved form without alteration or modification), and letters.]
- (4) Proposed Starting Dates [Record the anticipated start dates for all prime contractors and subcontractors, as well as flextime, lead-in time, and number of shifts or extra hours each contractor (prime and sub) propose to work.]
- (5) Errors and Omissions [Contractor to discuss errors, omissions, and ambiguities in the Contract Documents that are known to exist. Preconstruction Conference Minutes should document, in detail, the Contractor's knowledge of errors, omissions, and ambiguities.]
- (6) Maintenance of Traffic (MOT) Plans [Review and discuss the MOT Plan. Remind the Contractor that plans must have written approval before construction activities can begin. (Refer to **CPAM 9** for additional information.)]
 - (a) Americans with Disabilities Act (ADA) Compliance [Review requirements to maintain the same level of accessibility as the existing facility or greater.

Discuss the contractor's plan to ensure ADA compliance throughout all MOT phases. (Refer to **Specifications 102-3**.)

- (7) Construction Schedule/Work Progress Chart [Discuss schedule submittals. Establish meeting schedules (weekly-monthly) and locations to discuss job progress and to determine controlling work items for the next review period. Reiterate that schedule updates are required when there are significant changes to the planned order or duration of an activity. Also, updates should be submitted within 7 calendar days after the monthly estimate cut-off date for projects requiring a critical path method schedule (refer to project **Special Provisions**).]
- (8) Hurricane and Emergency Evacuation Plans [Project-specific evacuation plans (i.e., plan to secure the project and responsibilities) should be developed as soon as possible to provide details for phases or major activities that could possibly be affected.]
- (9) Dispute Review Board and Regional Disputes Review Board
- (10) Insurance policy requirements [Refer to **Specifications 7-13**.]
- (11) Contractor's Affidavit Vehicle Registration [The Contractor's affidavit is due on the first working day of the project.]
- (12) Erosion Control and Storm Water Pollution Prevention Plan [Discuss the Contractor's SWPP Plan, including review of the erosion and sediment control site map. Remind the Contractor that the site-specific plan must have the Engineer's written acknowledgement before any soil disturbing activities begin on the project.]
- (13) Environmental Permits [Review and discuss Contract Permits and National Pollutant Discharge Elimination System (NPDES) requirements]
- (14) Species related **Special Provisions** requirements
- (15) Project Commitments [Review and discuss project commitments made prior to construction (Refer to **CPAM 8.2.5**).]
- (16) Code of Federal Regulation Title 40 Part 112 (40 CFR 112 - Oil Pollution Prevention). [It is the Contractor's responsibility to become familiar with 40 CFR 112. (Refer to **CPAM 8.2.8**).]
- (17) Florida Statute Section 403.077 (Public Notification of Pollution). [It is the Contractor's responsibility to become familiar with Section 403.077, F.S. (Refer to **CPAM 8.2.9**).]
- (18) Consultant CEI and Materials Testing [Discuss procedures, relationships, and responsibilities of CEI and Contractor.]

District Contact for Materials Issues	
Earthwork	
Asphalt	
Concrete	
Materials Certification Manager	

- (19) Contractor Quality Control (QC) Plan [Discuss the following:
- (a) Identify key personnel from the Contractor, QC firm and the Department. The Contractor must name all CTQP qualified technicians that are to work on the project and will list each of their CTQP qualification categories along with the date that each qualification expires. If a named technician has a qualification that will expire during the project and if requalification training is not available before the qualification expires then the technician is not permitted to perform the duties of that qualification category until requalification is obtained. The PA must emphasize this concern during the Preconstruction Conference.
 - (b) Lines of Communication
 - (c) Discuss test result data entry into the Materials Acceptance and Certification (MAC) System and accessing reports and data from MAC.
 - (d) Discuss the Job Guide Schedule (JGS) in MAC (e.g., Standard vs. Non-Standard, initial submittal, monthly updates, and final submittal, monthly JGS review, project specific materials, etc.)
 - (e) Discuss pay items requiring materials from the Approved Products List (APL) and submittal of APL Product Information with APL Number prior to installation.
 - (f) Monthly/final certification, **Form 700-020-02, Construction Compliance with Specifications and Plans**. Provide the form to the Contractor.]
- (20) Cost Savings Initiative Proposals (CSIP) [Discuss potential CSIP and the need for a CSIP Workshop.]
- (21) Stockpiled Materials and Partial Payments [Discuss payment of stockpiled materials and **Form 700-010-42, Certification and Request for Payment for Stockpiled Materials**. Discuss partial payments (payment per completed operation) and provide the contractor with the contract specific Percentage Break Down Report from the PayItem Tracking System (PTS).]

- (22) Weather Letters [Discuss the preferred issuance of weather letters, either bimonthly (twice per month) or monthly, per **Specifications 8-7.3.2** and **CPAM 7.2**. Monthly issuance could be calendar month or at estimate cut-off period. This should be a conversation and open for negotiation. The District's decision will be final.]
- (23) Time Extension and Claims [Discuss submittal procedure for time extensions and claims. Discuss justifications for time extensions (controlling work items affected or conditions beyond Contractor's control) and provide the Contractor with **Form 700-010-56, Contractor's Time Extension Request**. (Refer to **CPAM 7.2** and **7.5**)]
- (24) Contractor's Past Performance Rating (CPPR) [The PA will provide the Contractor with **Form 700-010-25, Contractor's Past Performance Rating** at the Preconstruction Conference and explain the documentation of the CPPR and impact of the Contractor's performance on the ability to bid on future work. (Refer to **CPAM 13.1**)]
- (25) Warranties, Warranty/Maintenance Bond, Guaranteed Specifications.
- (26) The Contractor must provide certifications under oath made by an officer or director of the Contractor with authority to bind the Contractor for the following:
 - (a) A listing of on-site clerical staff, supervisory personnel and their pro-rated time assigned to the Contract
 - (b) Actual Rate for items listed in Table 4-3.2.1 in **Specifications 4-3.2.1**.
 - (c) Existence of employee benefit plan for holiday, sick, vacation benefits, and a retirement plan
 - (d) Payment of per diem is a company practice for instances when compensation for per diem is requested
- (27) Unpaid Bills [Discuss actions to be taken if an unpaid bill letter is received by the Department. (Refer to **CPAM 6.1**)]
- (28) Sublet Work and Rental Agreements [Discuss the requirements for submitting requests to sublet specialty work, **Form 700-010-36, Certification of Sublet Work**, and **Form 700-010-11, Notice of Rental Agreement**.]
- (29) Maintenance Responsibilities [Discuss and identify all maintenance related activities that will be the responsibility of the construction contractor and those that will remain the responsibility of the designated maintenance office.] Consideration should be given for the following:

- (a) Critical nature of activity and the entity that can provide the most efficient response and repair time based on the type of work (i.e., If existing guardrail is damaged and there is not guardrail work or associated pay items included in the construction contract may result in slower repair time than that of the designated maintenance office).
 - (b) Coordination efforts associated with emergency response and 3rd Party damages.
 - (c) Coordination efforts associated with non-emergency related activities and corresponding repair schedules to minimize impacts to construction.
- (30) DBE, EEO, and OJT [Discuss the following at the Post-Preconstruction Conference:
- (a) Establish lines of communications between the Department and the Contractor's Contract Compliance personnel.
 - (b) Proposed starting dates for Contractor and subcontractor
 - (c) EEO
 - (d) Affirmative Action
 - (e) OJT Training Goals
 - (f) OJT Banking Opportunities
 - (g) Utilization of Banking Credits
 - (h) OJT Proficiency Standards/Graduation Requirements
 - (i) Recruitment
 - (j) Contractor to address any Value Engineering Change Proposal (VECP) or Cost Savings Initiative (CSI) Proposal that may affect OJT achievement.
 - (k) DBE
 - (l) Payrolls
 - (m) Wage Rates
 - (n) Posters
 - (o) Field Interviews]

**ITEMS BELOW ARE MANDATORY
WHEN APPLICABLE TO THE SUBJECT CONTRACT:**

- (1) Utility Status [Each utility representative will provide an up-to-date report of the status of utility adjustments, relocations, removal, and new installation. In addition, the utility representative will furnish the names and phone numbers of contact persons who will be available on call. A Contractor/utility meeting schedule will also be established, if not held at the Preconstruction Conference.]
- (2) Lane Rental [Discuss the lane rental specification and establish the twenty-four (24) hour clock beginning and ending times to be used per **CPAM 6.2**]
- (3) Six-Month Statewide Pay Item Averages [Design Build Contracts: Ensure the six-month statewide pay item averages are downloaded from the Historical Items Average Cost website before the contract starts and provide report to contractor for use with Change Orders]
- (4) Business and Community Impact Plan
- (5) Partnering [Schedule the partnering session with approved facilitator.]
- (6) Global Navigation Satellite Systems (GNSS) [Discuss GNSS use and submittal of the GNSS Work Plan as required by **Specifications 5-7.6**]
- (7) Borrow Pits [Discuss special requirements when the Contractor is required to furnish borrow pits. It is the Contractor's responsibility to request an endangered species biological investigation.]
- (8) Truck Capacities [Request a list of certified truck capacities from the contractor if the Contract has truck measure pay items per **CPAM 5.11.**]
- (9) Mass Concrete [For Mass Concrete elements identified in the Plans, a Mass Concrete Temperature Control Plan will be submitted for review and acceptance by the Department at least ten working days prior to placement. Notify the Contractor that rejected Plans must be resubmitted after addressing the Department's comments. The revised Plan may require an additional ten working days for review and acceptance by the Department.]
- (10) Selective Clearing and Grubbing [Discuss extent and type of operation required, restrictions, preservation areas, tree protection, pruning, etc.]
- (11) Signalization and Lighting [Discuss the Contract Documents to ensure compliance with the requests of the maintaining agencies. Also discuss holding a pre-installation meeting with maintaining agency, the contractor/subcontractor, and supplier. Discuss the As-Built Documentation Requirements for Traffic Control Signals and Devices per **Specifications 611-2.3.**]

-
- (12) Shop Drawings [Explain the submittal procedure to the Contractor. Refer to **CPAM 8.4**]
- (13) Traffic Monitoring Sites (TMS) [Discuss required notification prior to beginning work and required TMS inspection per **Specifications 695**.] The TMS inspector must be onsite during equipment installation and will perform the final acceptance inspection.
- (a) For the Continuous Count Stations (CCS), previously known as TTMS, provide the following notification:
- i. Equipment Removal: notify the Traffic Data and Analytics Office at 1-800-399-5523 a minimum of 10 working days before beginning removal work
 - ii. Equipment Installation: notify the Traffic Data and Analytics Office at 1-800-399-5523 a minimum of 10 working days before beginning installation work
 - iii. Final Acceptance for Weigh-In-Motion (WIM) Equipment Installation: notify the Traffic Data and Analytics Office at 1-800-399-5523 a minimum of 30 days prior to final acceptance inspection
 - iv. Final Acceptance for non-WIM Equipment Installation: notify the Traffic Data and Analytics Office at 1-800-399-5523 a minimum of 14 days prior to final acceptance inspection
- (b) For the Short-Term Monitoring Site (STMS), previously known as PTMS, provide the following notification:
- i. Equipment Removal: notify the District Traffic Data Collection Coordinator a minimum of 10 working days before beginning removal work
 - ii. Equipment Installation: notify the District Traffic Data Collection Coordinator a minimum of 10 working days before beginning installation work
 - iii. Final Acceptance for STMS: notify the District Traffic Data Collection Coordinator a minimum of 14 days prior to final acceptance inspection
- (14) Bridge Construction and/or Drilled Shafts [Discuss the following:
- (a) Level II Concrete Plan
 - (b) Pile Installation Plan
 - (c) Drilled Shaft Installation Plan
 - (d) Auger Cast Pile Installation Plan

- (e) Opening Date [Provide the District Structures Maintenance Engineer with a tentative schedule showing when a bridge is scheduled to be opened to traffic at least 30 days before the scheduled opening date. This will provide the District Structures Maintenance Engineer an opportunity to inspect the bridge before it is scheduled to be opened to traffic. A minimum of 24 hours before the bridge is opened to traffic, notify the District Structures Maintenance Engineer.]
- (15) Lead-based Paint [Contractor needs to submit a written certification that is signed by an officer of the company, stating that the company will comply fully with all applicable Occupational Safety and Health Administration (OSHA) and Code of Federal Regulation (CFR) Worker Protection requirements for the duration of the contract. The QP-2 Certification for the Contractor (prime or sub-contractor) performing any lead-based painting work must be submitted prior to performing this work.]
- (16) Asphalt Operations [Discuss the importance of constant communication between the Quality Control Manager, the Department's Project Administrator and Verification Technician for quality reporting, placement, and payment. Review Automated Quality Control Roadway Report. Inform the Contractor that prior to any paving operation another meeting must be held. The QC Plan, QA/QC specifications, core frequency and handling of the cores, frequency for covering the milled surface, cross slope correction, and smoothness will be discussed.
 - (a) The Contractor will attend this meeting and present the following material:
 - i. The proposed starting date of the paving operations
 - ii. The location of the asphalt plant(s) to be used
 - iii. Contact List / Escalation Matrix: While a Project Contact List/Matrix may already be established, ensure a Contact List/Escalation Matrix are shared for all paving operations, as well as plant mix production, sampling, & testing.
 - (b) Discuss any project complexities, unique or challenging roadway geometry, MOT, or phasing, Non-Standard Milling, Non-Standard Paving, Cost Savings Initiative, any unique project conditions, etc.
 - (c) Discuss any Non-Standard Specifications, Developmental Standard Plans, etc. included in the contract and discuss any recent changes to the Standard Specifications
 - (d) Discuss Pilot Project Documents (ex. new materials, new testing/acceptance methods, new construction equipment/operations, etc.)

- (e) Open Forum: Discuss any current topics or areas of concern not listed above that are applicable (i.e. end-of-load segregation, safety)

NOTE: No paving operation will begin before a Pre-paving Conference is held to discuss the above items.]

Section 3.3

CONTRACTOR'S QUALITY CONTROL PLAN

3.3.1 Purpose

This section describes the review and approval process of the **Contractor's Quality Control Plan (QCP)** when required per **Contract Documents**. This section also describes the process of suspending Contractor's work due to inadequate Quality Control (QC) Operations.

3.3.2 Authority

Sections 20.23(3)(a) and 334.048(3), Florida Statutes (F.S.)

3.3.3 Reference

Federal-Aid Policy Guide, 23 CFR 637

Standard Specifications for Road and Bridge Construction

Materials Manual

3.3.4 General

In compliance with [FHWA 23 CFR 637](#), the Department chose to implement the "Contractor option". This option requires the Contractor to be responsible for QC on Department projects. **Specifications Section 105** details the requirements of a **Contractor's QCP**.

3.3.5 Contractor's QCP Review and Approval

The Contractor will submit the **Contractor's QCP**, in accordance with **Specifications Section 105**, to the Project Administrator (PA) for approval, seven (7) calendar days prior to beginning work on QC Program applicable material. The submittal provides the laboratories, technicians, production facilities, and structural concrete mix designs in the Department's Materials Acceptance and Certification system (MAC). MAC provides some feedback on the proposed data acceptability at the time of submittal.

NOTE: A QCP and QC Manager are required when a contract includes any quality control material identified in **Specifications 105-3**. If a contract does not have quality control

materials, then a QCP and QC Manager are not required. An example of a contract not requiring a QCP is a landscape only contract.

(A) Resident Level Responsibilities

The PA shall review the **Contractor's QCP** to ensure it is correct and complete using the checklist provided as a guide in [Attachment 3.3-1, Quality Control Plan Review Checklist](#). All QC Program materials on the contract must be included in the Contractor's QCP prior to material being produced for the contract. Each QC Program material must have at least one production facility listed as the source of the material. Each production facility must have a **Producer's QCP** in acceptable status prior to material being produced for the contract. MAC will update the information with any status change to a technician, laboratory, production facility, or concrete mix design and will notify the PA of any production facility status changes.

The following information on the MAC template must be reviewed by the PA to determine acceptability:

1. Laboratories – MAC provides a general laboratory status, but does not indicate if a laboratory is qualified in the specific test method(s) for the material. For example, if a laboratory is listed as an Earthwork Laboratory, the PA will review the test methods assigned on the laboratory profile to ensure the appropriate test methods for Soils/Earthwork Testing, such as FM 1-T180, are included. There is a report available in MAC to assist the PA with this review.
2. Qualifications – The QC Manager must provide backup documentation by attaching the qualification information to the template and the PA must review to ensure the proposed personnel meet requirements of **Specifications Section 105**. Examples include Grouting Technicians and Post Tensioning Technicians and bridge foremen .
3. Commercial Inspection – On contracts with Steel and Miscellaneous Metals materials that require commercial inspection, the PA must indicate in MAC if an optional inspection is being requested on any items or processes on the contract that do not typically require commercial inspection. The PA must also indicate if there are steel and miscellaneous metal items on the contract that will not be commercially inspected. The PA must ensure that the Contractor attaches the fabrication schedule for items that require commercial inspection and list the production facility or facilities that will be fabricating the items under the appropriate material type(s) 30 days before fabrication has begun per **Specifications Section 105-1.2.3**.
4. Structural Concrete Mix Designs – The PA must review the specific entries to ensure the project specific requirements, including **Special Provisions** and **Technical Special Provisions**, or plan notes are met.

The PA will ensure the QC Manager has included information on all QC Program materials in the contract, review any status indicators with the QC Manager, and determine if any status indicators will be a cause for concern at the time the phase of work will begin. If the status indicators can be resolved before the work begins, the PA shall accept that portion or portions of the **Contractor's QCP** in MAC.

The Department will accept or reject the proposed **Contractor's QCP** within ten (10) calendar days of submittal. No phase of work covered under the QC Program, as specified in **Specifications Section 105**, can begin until the PA has accepted the **Contractor's QCP** in MAC for that phase of work. If a portion of the **Contractor's QCP** is in compliance, the Contractor may begin work for that phase, but not for phases that are non-compliant.

(B) District Level Responsibilities

The District Materials and Research Office (DMRO) concrete personnel will review the concrete mix designs submitted in the structural concrete portion of the **Contractor's QCP** to ensure the proposed production facility or facilities have the component materials on hand to produce the concrete mix designs. The DMRO concrete personnel review does not include determining if the concrete mix designs meet the requirements of the **Contract Documents**. The DMRO will indicate the status of the material availability within the 5 calendar days after the data is input into MAC by the Contractor for original submittals.

3.3.6 Contractor's QCP Updates

The **Contractor's QCP** often needs revising due to changes in personnel, mix designs, or production facilities. The Contractor will submit the proper information required to fulfill the changes/modifications of the **Contractor's QCP** updates and additional information through MAC at least five (5) working days prior to the implementation of any changes per **Specifications Section 105-5.1**.

(A) Resident Office Responsibilities

Changes to the prior approved **Contractor's QCP** are accepted and approved by the PA in MAC. The Department will accept or reject the proposed QC Plan addendum within seven (7) calendar days after submittal.

(B) District Level Responsibilities

The DMRO concrete personnel will also review the concrete mix designs submitted for structural concrete as an addendum to the **Contractor's QCP** and make appropriate

recommendations in MAC to the PA within five (5) calendar days of submittal by the Contractor.

3.3.7 Producer QC Stamp

(A) Resident Office Responsibilities

When QC Program materials are delivered to the project site, project personnel shall inspect the products for **Specifications** compliance, including the product's QC stamp. Unstamped products must be rejected. Stamped products should be inspected to ensure that they are being produced by the production facility that is listed on the **Contractor QCP**. The State Materials Office publishes photos for each production facility QC stamp as a resource for the project personnel to confirm the QC stamp. A link to the production facility's QC stamp can be found on the **Contractor QCP**.

3.3.8 Resolution Test Fee Schedule

(A) Resident Office Responsibility

The PA shall furnish the Contractor with a fee schedule that will be used to establish a credit on the monthly estimate in the event that resolution tests performed by a Department compare favorably with the Verification Technician (VT) test results. The PA can obtain the fee schedule from the State Materials Office (SMO) website at:

www.fdot.gov/materials/navigation/documents.shtm

(B) State Materials Office Level Responsibilities

The Director, Office of Materials shall publish a fee schedule that will be used to establish a credit on the monthly estimate for resolution tests performed by a Department's laboratory that compare, in accordance with the **Specifications**, with the Department's Verification test results. Such fee schedule shall be published annually, at the beginning of the fiscal year, for contracts let that fiscal year.

3.3.9 Suspension of Work due to Inadequate QC Operations

The following conditions may result in the suspension of the QC operations, in part or all-inclusive:

1. Failure to comply with the requirements of **Specifications Section 105**, such as failure to timely supply information.
2. Repeated failure of materials to meet **Specifications** requirements.

3. Failure to take immediate corrective action relative to deficiencies in the performance of the QC program.
4. Notification from the State Materials and/or District Materials and Research Office in accordance with **Materials Manual 5.6**, such as certifying materials that are not produced under an approved Quality Control Program for use on Department projects.

(A) Resident Office Responsibilities

The RE or designee shall notify the Contractor within two (2) working days of finding a condition or conditions of inadequate QC Operations. Notification of such findings shall clearly state area(s) of concern and non-compliance with the **Specifications** and requirements of the **Contract Documents**.

Any verbal warning to the Contractor that all or part of the QC Operations is in non-conformance will be documented by the PA in the Daily Work Report and shown on the monthly Contractor's Past Performance Rating.

The PA shall issue a Deficiency Warning Letter (DWL) if the Contractor does not correct the finding(s) after receiving a verbal warning. The PA shall issue a DWL to notify the Contractor of shortcomings/non-compliances with QC Operations. Prior to issuing a DWL, the PA will discuss the performance concerns with the RE. A single DWL can be used to address concerns in more than one performance category.

Continued non-compliance after a verbal warning and DWL will require a Deficiency Letter (DL) to be issued. However, blatant violations or non-compliances may result in a DL being issued by the RE without a verbal warning or DWL.

Refer to **CPAM 13.1, Contractor's Past Performance Rating** for processing DWL and DL. Submit all DLs related to the QC Manager's failure to properly apply the **Contractor's QCP, Specifications** and/or quality control procedures to the QC Manager and the State Construction Office Training Coordinator.

The issuance of a DL by the RE could result in suspension of work due to QC Operations if the Contractor neglects to correct the QC Operations or continues to perform without sufficient QC Operations or **Specifications**. In the event the work is suspended due to inadequate QC Operations, such suspension must clearly state area(s) of concern and non-compliance with the **Specifications** and requirements of the **Contract Documents**. A sample letter for suspension of work for failure to provide adequate QC Operations is provided in the [Attachment 3.3-2, Suspension of Work Due to Inadequate Quality Control Operations](#).

(B) State Construction Office Responsibilities

Per **Construction Training Qualification Manual (CTQM) Chapter 7**, the QC Manager's qualification shall be suspended when three DLs are issued related to the QC Manager's failure to properly apply the **Contractor's QC Plan, Specifications** and/or quality control procedures within a twelve (12) month period regardless of the contract for which the notifications are issued. For example, notifications can be issued for the same contract or for different contracts.

3.3.10 Attachments

- [Attachment 3.3-1](#) Quality Control Plan Review Checklist
- [Attachment 3.3-2](#) Suspension of Work Due to Inadequate Quality Control Operations

Attachment 3.3-1 Quality Control Plan Review Checklist

QCP Item	Y	N	N/A
105-5.2 Personnel Qualifications			
Ensure all qualified personnel are listed with Technician Identification Number (TIN) for each qualification. The PA will review with the QC Manager any qualifications designated as anything other than qualified.			
Bridge Personnel			
The PA will confirm the bridge personnel qualifications, if applicable.			
Post Tensioning Level I			
Post Tensioning Level II			
Grouting Technician Level I			
Grouting Technician Level II			
Supervisory Personnel (Project Manager, Superintendent, Foreman, Surveyor)			
105-5.3 Production Facilities			
Are the production facilities listed?			
The PA will confirm that production facilities are included for all Quality Control Program materials that will be used on the project.			
The PA will review with the QC Manager production facilities designated as anything other than accepted/approved.			
105-5.3.1 Structural Concrete Mix Designs			
Are the concrete mix designs listed, if applicable?			
The PA will review the District Materials and Research Office (DMRO) Concrete personnel recommendations for use of structural concrete mix material availability. The PA will review the structural concrete mix designs for suitability related to project specific requirements. Do not accept or reject the concrete portion of the Contractor QC Plan until the DMRO concrete personnel complete the material availability review.			
105-5.4 Testing Laboratories			
Are the laboratories listed?			
The laboratory status provided by MAC is not sufficient to determine if the laboratory is approved for the designated material. The PA will review the laboratory test methods to ensure the laboratory is valid for the material designated.			

QCP Item	Y	N	N/A
The PA will review any concerns with the listed laboratories with the QC Manager.			
105-1.2.3 Notification of Placing Order			
The PA will ensure the Contractor has identified if there will be commercial inspection need on the project.			
The PA will provide additional information about optional inspection requested for items not normally covered by commercial inspection (per PA's request).			
The PA will indicate if there are other steel and miscellaneous items on the project that will not be commercially inspected.			
The PA will ensure that the Contractor attaches the fabrication schedule 30 days before the fabrication begins.			

Attachment 3.3-2 Suspension of Work Due to Inadequate Quality Control

Date

Contractor Name

Contractor Address

City, State Zip

RE: SUSPENSION OF WORK DUE TO INADEQUATE QUALITY CONTROL OPERATIONS

Dear Sir or Madam:

The Department has suspended operations due to Inadequate Quality Control Operations as defined below:

<Provide details - clearly state area(s) of concern and non-compliance with the Specifications and requirements of the Contract Documents>

The Department directs the Contractor to cease the phases of work deemed to be non-compliant. Resumption of such phases of work shall be dependent upon approval of the Engineer.

If you have any questions, please feel free to contact <Name of the Project Administrator> at <telephone number>.

Sincerely,

Resident Engineer

cc: District Materials and Research Engineer

Section 3.4

DISPUTE REVIEW BOARD

3.4.1 Purpose

The purpose of this procedure is to provide for uniformity in the use of Dispute Review Boards (DRB).

3.4.2 Initiating Specifications

(A) Resident Level Responsibilities

All contracts should contain a special provision for either a contract specific Dispute Review Board (DRB) or a Regional DRB (RDRB). Conventional contracts over \$20 million should contain a special provision for a contract specific Dispute Review Board (DRB). The Resident Engineer (RE) also has the option to add a contract specific DRB to projects less than \$20 million, for complex projects, or for projects with a higher than normal probability of issues. For capacity only projects, a RDRB can be deemed sufficient based on the complexity of the project or a decreased probability of issues. Complex Design-Build contracts over \$50 million should contain a contract specific DRB, while smaller and/or less complex Design-Build contracts can utilize a RDRB. If there is no special provision for a contract specific DRB, then there should be one for a Regional DRB (RDRB).

3.4.3 Contract Specific DRB

3.4.3.1 Member Selection

(A) Resident Level Responsibilities

Projects with contract specific DRBs require the appointment of the three members. The process of appointing the three members should be completed early enough that the members can attend the pre-construction meeting.

The RE will select an appointee from the Florida Department of Transportation's (Department's) list of candidate members. The name of the proposed DRB member selected by the RE should be reviewed by the District Construction Engineer (DCE) prior to submitting to the Contractor for review. In selecting a member, keep in mind, we

are not looking for someone who will take our side, but someone knowledgeable of the type of work that will understand the issues that may come up and who is able to knowledgeably evaluate a dispute. The RE should review the resume, disclosure statement, and availability of the members of the proposed Department selection, the Contractor selected member and the proposed chairperson. Copies of these resumes should also be forwarded to the DCE.

When the Contractor submits its appointee, the RE should seek the advice of the DCE before approving the appointment. The RE and the DCE should carefully review the resume of the appointee and solicit references if unknown.

3.4.3.2 Three Party Agreement

(A) Resident Level Responsibilities

A contract specific DRB requires a ***DRB Three Party Agreement, Form No. 700-011-02*** be executed before the pre-construction meeting. This document is not included in contracts but is to be downloaded off the Forms and Procedures website. The Project Administrator (PA) should take the lead in getting this agreement executed. The DRB and Contractor should execute 2 copies of the agreement. The copies should then be sent to the DCE for execution. The agreement will be returned to the PE for distribution, one original retained by the Department, the other original to the Contractor, and one copy each to the DRB members.

(B) District Level Responsibilities

The DCE is responsible for executing the Three Party Agreement, unless delegated. In the case of delegation, documentation of such delegation should be maintained in files.

3.4.3.3 Meeting

(A) Resident Level Responsibilities

Meeting frequency should be determined on a project-by-project basis. Meetings should generally be held monthly at least for the first six months to acclimate the DRB, as problems often become apparent in the early part of a project. If the project is behind schedule, or the Contractor is submitting numerous ***Notices of Intent to Claim***, a monthly meeting is necessary. Projects that are running smoothly with few claims and on schedule should evaluate the meeting frequency. The RE and the Contractor must agree to changes to the frequency of meetings. This is not meant to be a unilateral

decision by the Department.

When possible, DRB meetings should be scheduled to coincide with regular periodic progress meetings. DRB meetings are scheduled well in advance. The RE must assure that these meetings occur when scheduled. The RE should not cancel a meeting without adequate notice. DRB members should be paid for a meeting canceled with less than 5 working days advance notice unless the Board initiates such cancellation.

On a contract specific DRB, all three members should attend each scheduled periodic meeting. In the event that one member of the Board is unable to attend a regular scheduled meeting, the Chairman should attempt to reschedule the meeting. Should rescheduling not be possible, the other two members may attend the meeting without the third member. Only the members attending should be compensated. No hearing will be conducted without all three members present.

The Department project staff will take minutes of the regular periodic meetings, including that portion devoted to DRB discussion.

(B) District Level Responsibilities

The District Construction Office is responsible for initiating a request to include the DRB special provision for a contract and should provide a projected quantity for meetings. The quantity should allow for the life of the contract. Generally, one meeting per month for the first six months and a meeting once every other month should be followed, unless circumstance dictates otherwise.

3.4.3.4 Use of the DRB

(A) Resident Level Responsibilities

On all matters that relate to DRBs, communicate only with the Chairman. All personnel on the project should understand that there should be no communication with any DRB member outside of a meeting. The only exception is communication between the parties and the DRB Chairman relating to scheduling meetings or administrative matters relating to a hearing.

On rare occasions, the Department or the Contractor may bring an issue that is unusually complex or request that a detailed analysis be developed. In this instance it may be appropriate for the DRB to request additional compensation. It is important that there be agreement among all parties as to what the expectations and compensation will be as it relates to the number of days the DRB members are to be compensated

and level of detail of the recommendation, prior to presenting the issue to the DRB.

The default of a Contractor does not terminate the contract. The DRB is still in existence and all parties have the same responsibilities as existed prior to a default.

If a Contractor refuses to participate in a hearing, they should be reminded that the hearing is a condition precedent to any other forum of resolution. The hearing should then take place absent the Contractor. The Department will not refuse to participate in a hearing unless determined appropriate after consultation with the State Construction Office and the Central Office Civil Litigation Section. The only exception would be if all parties agree that the issue is one over which the Department has no jurisdiction or the issue involves a third party which cannot come before the DRB.

3.4.3.5 Payment

(A) Resident Level Responsibilities

Costs associated with a contract specific DRB are reimbursed to the Contractor through an established pay item. The Contractor pays the members of the DRB and the Department reimburses the Contractor using this pay item. Invoices must be prepared by the DRB Chairman and submitted to the Contractor, with a copy sent to the Project Engineer showing the date and nature of the services provided and support and document the quantity for the estimate, particularly when the services provided were not in attendance at a regularly scheduled meeting. Normally the pay quantity for a meeting is 1.0, however, the pay quantity can be a fractional quantity. No payment is made until the Three Party Agreement is executed.

It is possible that a DRB meeting could occur after the Contractor has submitted a qualified acceptance letter. In that case, the PE will process another estimate to reimburse the Contractor for payments to the individual members.

3.4.4 Regional DRB

3.4.4.1 Member Selection

(A) Central Office Level Responsibilities

There are three regular members and two alternates designated for each RDRB for a period of one calendar year. The list of the members is available on the State Construction Office's web site.

3.4.4.2 Three Party Agreement

(A) Central Office Level Responsibilities

The Three Party Agreement for RDRB has been executed and is maintained in the State Construction Office.

3.4.4.3 Meeting Frequency

A RDRB does not have regular periodic meetings unless requested by the DCE. When a hearing is requested by the RE or the Contractor, a pre-hearing (orientation) meeting may be appropriate to acquaint the RDRB with the project and any issue to be heard.

(A) Resident Level Responsibilities

The RE initiates a request to the DCE that the RE, or the Contractor, intends to present a dispute to the RDRB.

(B) District Level Responsibilities

The DCE or designee shall schedule the RDRB meeting to hear the dispute submitted by the RE.

3.4.4.4 Payment

(A) Resident Level Responsibilities

RDRB is paid using a work order against a contingency pay-item or Contingency Supplemental Agreement. If the RDRB meets to hear issues on more than one project, the meeting should be paid for using contingency funds from only one project.

It is possible that a RDRB meeting could occur after the Contractor has submitted a qualified acceptance letter. In that case, since the project is still open in Transport, another estimate will be processed to reimburse the Contractor for payments to the individual members.

If the project has been closed out, as may be the case on a project that contains a Warranty/Guarantee specification, the project will need to be re-opened in CFM (Contract Funds Management) and an Estimate will need to be generated to reimburse the Contractor for payments made to individual members. * Note * All efforts should be made to ensure all payments are received by the Contractor prior to closing the project.

3.4.5 Request for Hearing

(A) Resident Level Responsibilities

Exemplar Operating Guidelines are posted on the State Construction Office website. The Department and the Contractor have the responsibility to resolve issues in a timely manner. On Partnered projects, there is a clearly defined escalation process. On other projects, the escalation process may not be clearly defined.

The Department does not have to wait for the Contractor to bring an issue to the DRB or RDRB. It is important that issues be escalated soon enough to mitigate impacts to the project. Once the project personnel recognize that a resolution, that is mutually agreeable to the Contractor and the Department, will not come about, or that the partnering process dictates, then the issue should be brought to the DRB or RDRB. The PA and the RE should consult with the DCE prior to requesting a hearing.

If the Department requests a hearing, the initial request should be for entitlement only. A request by either the Department or the Contractor for a hearing on quantum should be made only after a finding or recommendation on entitlement was issued and the Department and Contractor have made a sincere effort to resolve the quantum issue, or such is not otherwise reasonably possible. The Department should resist any effort made by the Contractor to have the entitlement and quantum issues heard by the DRB at the same hearing because it deprives both sides of an opportunity to arrive at a mutually agreeable solution.

3.4.6 Preparation for the Hearing

(A) Resident Level Responsibilities

The Department's position must be based on facts, plans, specifications, and contract documents. Send copies of the Department's position papers and rebuttals to the DCE for review prior to submitting to the DRB or RDRB.

The person(s) who will be representing the Department at the hearing should be familiar with how a hearing is conducted. A "dry run" should be conducted to make sure the Department's position is presented clearly.

Send copies of Contractor's position papers and rebuttals to the DCE for review.

3.4.7 During the Hearing

(A) Resident Level Responsibilities

Prior to the start of the hearing, request the DRB or RDRB to go over the Operating Guidelines

Keep in mind that neither party is to be permitted to present information that hasn't been previously given to the other party prior to the hearing without the other party's consent.

3.4.8 Recommendation of the Board

(A) Resident Level Responsibilities

The RE should discuss the recommendation with the DCE to determine whether to accept or reject the recommendation. The RE should accept or reject the recommendation in writing within the time period stated in the Specification. If the RE wants to reject the recommendation, the rejection has to be based on the DRB or RDRB disregarding or failing to recognize specifications and contract documents. If the recommendation does not provide sufficient information to indicate which facts or contract provisions were used to support the decision, request further information. Consultation with the State Construction Office and Central Office Civil Litigation Section will be necessary before the RE decides to reject any recommendation.

A copy of the Board's recommendation shall be sent to the State Construction Office.

Section 3.5

FINAL ESTIMATES QUALITY REVIEWS

3.5.1 Purpose

The purpose of this chapter is to provide guidelines for checking and monitoring the Final Estimates Process from the initial phase of construction through the closeout phase. The goal of the State Final Estimates Office (SFEO) is to provide consistent and quality practices statewide.

3.5.2 Authority

Sections [20.23\(3\)\(a\)](#) and [334.048\(3\)](#), *Florida Statutes (F.S.)*

3.5.3 References

Construction Project Administration Manual (CPAM)

Basis of Estimates Manual

Review and Administration Manual

Final Estimates Guidelist

Final Estimate Status (FES) application– User Guide

3.5.4 General

This procedure explains what is required to perform effective **Quality Assurance Reviews (QAR)**, **Quality Control (QC) Reviews**, and **Process Reviews**.

QARs are performed by the Resident Office (RO) to assure compliance with processes and procedures throughout the contract duration.

QC Reviews are performed by the District Final Estimates Office (DFEO) to periodically monitor quantities, payments, procedures, and guidelines to assist in obtaining accurate and quality **Final Estimates Documentation**. **QC Reviews** also determine how effective the District's QC Plan is implemented.

Process Reviews are performed by the SFEO to facilitate the Final Estimate process by addressing findings during the progress of the project and by clarifying procedures when necessary.

For each review performed, the reviewer must print his/her name followed by the applicable review type, review date, and his/her agency/company name on **the Final As-Built Signature Sheet**. See **RAM 3.6** and **CPAM 5.12.8(B)(2)** for more information.

Records of all **QARs** will be scanned into the Electronic Document Management System (EDMS). **QC Review** information will be entered into the **Final Estimate Status (FES)** application. Records of **Process Reviews** will be stored on the State Construction SharePoint site.

3.5.5 Quality Assurance

The RO is responsible for the quality of the **Final Estimates Documentation**. Quality is achieved by checking Contractor certifications, pay quantities, contract and line item adjustments, estimate payments, and supporting backup documentation for accuracy and compliance with policies and procedures throughout the duration of the construction contract.

(A) QA Plan

The RO QA plan will detail the frequency and the manner in which QA reviews will be performed. The RO QA Plan will be submitted to the District Final Estimates Manager (DFEM) for review and approval prior to the beginning of construction. The DFEM will review, send for correction, and/or approve the RO QA Plan within 10 days of receipt.

(B) Frequency of QARs

For Consultant projects, **QARs** are required in the Consultant Construction Engineering and Inspection (CEI) Scope of Services to be performed, at minimum, semi-annually, unless otherwise indicated by contract duration and contract items.

For In-House projects, **QAR** frequency should, at minimum, mirror the Consultant requirements and be identified in the District QC Plan.

(C) QAR Findings

A report detailing the findings of each **QAR** will be submitted to the DFEM within 30 days of completion.

3.5.6 Quality Control

The DFEO is ultimately responsible for all **Final Estimates Documentation** within the District. The DFEO will monitor the estimate process and the quality of estimates on Consultant and In-House projects throughout the District.

(A) District QC Plan

The District QC Plan must outline how District **QC Reviews** will be performed and the frequency of the reviews by the District. Each DFEM must submit their current District QC Plan to the SFEO. See [Attachment 3.5-1](#) for a **Sample QC Plan**.

(B) Frequency of QC Reviews

A minimum of one **QC Review** must be completed for projects within each District at the frequency shown in the table below. The DFEOs will complete a **QC Review** at the following construction completion milestones: 30%, 60%, and/or 90%. If only one **QC Review** is conducted, it is recommended that the 60% milestone be given high priority due to the quantity of work completed and contract time remaining from completion of the project. Likewise, no review should be performed at a construction completion less than 30% due to minimal work completed.

Minimum Requirements for QC Review Frequencies

	Less than \$5M	\$5M or Greater
QC Review	15%	100%

(C) QC Review Findings

All Critical Requirements in Compliance and Noncompliance during each **QC Review** must be entered into the **FES** application's **District QC Tab**. The DFEO must enter all findings from **QC Reviews** along with the corresponding dollar amount. The application will automatically calculate the Overpayment, Underpayment, Net Value, and Absolute Value from the District QC Findings Entries. The **QC Review** must include findings, such as incomplete Summary of Quantity entries, **Final As-Built Plans** not updated, and adjustments not recorded, with steps to be taken to improve the Final Estimates process, as well as all Outstanding Areas or Best Practices to benefit the processes of the District and/or State. Significant findings will inform the DFEO as to what areas and what course of action is needed at the RO Level, specifically if supplementary training is required. The DFEM will conduct additional reviews when deemed necessary, until satisfactory

performance levels have been reached. Once the **QC Review** information has been input into the **FES** application, the DFEO must notify the Project Administrator (PA) and project staff that the **QC** results are available in the **FES** application for review. For more information, see the [Final Estimate Status – User Guide](#), on the **FES Help Tab**.

Form 700-050-36, Final Estimates Field Review Form can still be used by the DFEO for field notes during the review and any site source documentation, as needed. To avoid duplication, the **Form 700-050-36, Final Estimates Field Review Form** (when used) is not required to be inputted into EDMS.

3.5.7 Process Review

The SFEO is responsible for all quality reviews at the District and RO (In-House and Consultant CEI) levels. The purpose of the SFEO **Process Review** is to ensure efficient and effective delivery of the final estimates process and to determine whether the CCEI and In-House project processes are being conducted in accordance with the procedures and guidelines, as well as determine if any changes to the current procedures and guidelines are required. SFEO will determine which jobs to be reviewed in each District. Asphalt, Concrete, Earthwork, Bridge Quantities, and **Final As-Built Plans** are critical areas of high significance and relevance.

(A) Frequency of Process Reviews

At least one **Process Review** will be completed in each District annually. Depending on **Process Review** results, the frequency may be increased based on need.

(B) Process Review Findings

(1) Process Review Close-Out Process

(a) Informal Close-Out

The State Final Estimates Engineer (SFEE) or Designee(s) will conduct an Informal Close-out meeting with the Resident Engineer and/or Project Administrator after each individual Contract reviewed, to discuss any findings and what corrective actions, if any, must be taken to improve the estimate process. Non-Compliance along with Best Practices will be addressed in the Informal Close-out. If there is an issue, critical requirements should be the main topic of discussion.

(b) Formal Close-Out

The SFEE or Designee(s) will conduct a Formal Close-out meeting with the District Construction Engineer (DCE) and the DFEM to discuss any recommendations or findings from all Contracts reviewed. Topics identified for discussion or improvement include: additional training for personnel, practice improvements, or process improvements to ensure staff has resources to properly finalize each estimate. If **Process Review** findings have statewide significance, they will be communicated to all DFEMs.

(2) Process Review Report

A **Process Review Report** will be prepared by the SFEO and submitted to the following:

- Chief Engineer
- Director of Construction
- District Secretary
- Director of Transportation Operations
- DCE
- DFEM
- FHWA

The **Process Review Report** must contain data supported findings and recommendations. The District will submit a written response to the SFEE within 30 days after receipt of the **Process Review Report** addressing any findings, including a reasonable solution to the areas identified for improvement. Any comments and questions concerning the **Process Review Report** should be discussed with the SFEE or Designee(s) prior to submitting the written response to the SFEE.

3.5.8 Final Estimates Guidelist

The SFEO is responsible for publishing the **FE Guidelist**, which provides a list of major items to help the Construction project staff meet Final Estimate requirements. It also includes the Critical Requirements used for **Process Reviews**, **QC Reviews**, and **QARs**. The **FE Guidelist** is found on the Construction Website at [Final Estimates Guidelist](#).

3.5.9 List of Attachments Following this Section

[Attachment No. 3.5-1](#).....Sample QC Plan

Attachment 3.5-1 Sample QC Plan

Purpose and Scope

This document describes Quality Control (QC) procedures used in review of the final estimates process (QC Reviews) prior to submittal of Final Estimates Documentation. The Resident Office (RO) or designee is responsible for ensuring the Final Estimates Documentation is complete, accurate, adheres to Contract Documents and Contract Plans, is responsibly supported, and is promptly submitted to the District Final Estimates Office (DFEO) after the offer letter is sent to the Contractor. The goal of this approach is to expedite the review process and attain quality Final Estimates Documentation that is compiled throughout the life of the contract.

Reference Documents and Manuals

- (A) Contract Documents: The following documents are referenced within this document and are implicitly included in the term Contract:
- (1) Special Provisions
 - (2) Technical Special Provisions
 - (3) Contract Plans
 - (4) Design Standards
 - (5) Developmental Specifications
 - (6) Supplemental Specifications
 - (7) Standard Specifications
- (B) Department of Transportation Documents: The following procedures and guidelines are referenced in preparation for a review of the Final Estimates Documentation.
- (1) Construction Project Administration Manual (CPAM)
 - (2) Review and Administration Manual (RAM)
 - (3) Final Estimates Guidelist
 - (4) Basis of Estimates Manual (BOE)

Definitions

The following explanations define the intended use of the terms within and in conjunction with this document:

Acceptable: An area where evaluation of critical requirements indicates a process is in compliance with predetermined criteria.

Adequacy: The existence of sufficient coverage to support all tasks and functions at the prescribed level of competency as described in the reference manuals.

Critical Requirement: An essential and measurable activity in a Department process without which the process cannot be carried out.

Overview: Uses judgment in reviewing changes made by the Initial Reviewer, as well as in reviewing in-depth any other area deemed appropriate as outlined in Level of Assessment below.

Final Estimates Documentation: All documents necessary to provide a historical and legal record of the work performed on the project in accordance with the contract for final payment to the Contractor.

Initial Reviewer: Performs a thorough check of the Final Estimates Documentation.

Significant Finding: A monetary or procedural error showing neglect in producing and/or maintaining the necessary Final Estimates Documentation.

Unacceptable: An area where evaluation of the critical requirements indicates a process is **not** in compliance with predetermined criteria.

Level of Assessment

(A) DFEO Level

- (1) Final Estimate Kick-off Meeting - The DFEO will conduct a meeting with the assigned CEI staff on how to develop and manage the Final Estimates Documentation for all newly awarded contracts. An appropriate checklist and/or other material for the development of estimates documentation will be provided to the CEI staff at this meeting. The determination to conduct the meeting will be based on the complexity of the contract and the level of experience of the project staff and/or at the request of the RO staff per **CPAM 2.2**.

- (2) Optional: District Final Estimates Meeting - The DFEO will conduct a (quarterly or semi-annual) meeting with all final estimates personnel (In-house and Consultant) to distribute information and updates, as well as provide a forum for training and feedback, in an effort to continually improve the final estimates process.
- (3) Frequency of Review - The following intervals are minimums.
- (a) There will be (Number of Reviews) review(s) for conventional contracts with an original contract amount of less than (Dollar Amount).
- (b) There will be (Number of Reviews) review(s) for conventional contracts with an original contract amount of (Dollar Amount) to (Dollar Amount).
- (c) There will be (Number of Reviews) review(s) for conventional contracts with an original contract amount exceeding (Dollar Amount).
- (d) The reviews above will be performed as follows:
- If one (1) review is to be performed on a contract, the review will be performed at no less than 60% of project completion.
 - If two (2) reviews are to be performed on a contract, the reviews will be conducted at 60% and 90% of project completion.
 - If three (3) reviews are to be performed on a contract, the reviews will be conducted at 30%, 60%, and 90% of project completion.
- (e) Option 1: A minimum of (Number of Reviews) review(s) will be performed for Lump Sum and Design Build Contracts.
- Option 2: Lump Sum and Design Build contracts will also meet the criteria specified above.

- (4) Pay Item Review - The DFEM has the authority to exercise judgment in deciding which pay items are to be reviewed for a specific contract. This determination will be based on the following criteria:
 - (a) Size and complexity of project
 - (b) Pay item problem areas
 - (c) Statewide required pay items where these pay items are a major item of work as defined in Article 1-3 of the Standard Specifications:
 - Earthwork
 - Asphalt
 - Concrete
 - (d) Experience of project staff
- (5) Final As-Built Plans Review
 - (a) Ensure all reviewers are identified on the Final As-Built Signature Sheet
- (6) Review all material penalties and failures are included in the monthly estimates
- (7) Review contract and line item adjustments, work orders, and Supplemental Agreements to ensure they are included in the monthly estimates
- (8) Review the overrun and underrun explanations
- (9) Review the contract time documentation
- (10) Review the Offer Letter and final estimate prior to submittal to the Contractor

(B) In-house Resident Office (RO) Level

- (1) Final Estimate Preparation – The RO must review the appropriate Contract Documents, manuals, procedures, and checklists

- (a) Incomplete calculations or backup documentation, as well as errors are resolved with the assistance of the Engineer of Record
 - (b) Missing pay items are flagged and addressed on an early supplemental agreement
 - (c) Removal items are measured prior to removal and earthwork verification is completed
- (2) Frequency of Review - The following intervals are minimums.
- (a) Reviews will be conducted semi-annually
 - (a) For short duration contracts, an initial review will be conducted within the first two (2) months of the start of construction
 - (b) On asphalt contracts, an initial review will be conducted after the Contractor has completed ten (10) full workdays of mainline asphalt paving operations or 25% of the asphalt pay item amount (whichever is less)
 - (c) A final review must be conducted prior to submittal of the Offer Letter to the Contractor and Final Estimates Documentation to the DFEO
- (3) Documentation of Review
- (a) Within 30 days of review completion, the RO must submit a report to the DFEM with findings and corrective measures
- (4) Final As-Built Plans Review
- (a) Ensure all reviewers are identified on the Final As-Built Signature Sheet
- (5) Estimate and Pay Item Review
- (a) Method of Measurement
 - (b) Basis of Payment
 - (c) Applicable Field Record and/or back up documentation

- (d) Contract Adjustments (list is not all inclusive)
 - Incentive/Disincentive
 - Retainage
 - Damage Recovery/Lane Rental
 - Liquidated Damages
- (e) Line Item Adjustments (list is not all inclusive)
 - Fuel
 - Bituminous
 - Composite Pay Factor (CPF)
 - Thickness
- (f) Overrun and underrun explanations
- (6) Contract Time Documentation Review
- (7) Contract Changes Review (list is not all inclusive)
 - (a) Work Orders
 - (b) Supplemental Agreements
 - (c) Time Extensions
- (8) Offer Letter Review

Section 4.1

ADMINISTRATION OF CONSULTANT CEI CONTRACTS

4.1.1 Purpose

To set forth general instructions concerning the administration of Consultant Construction Engineering and Inspection (CCEI) contracts.

4.1.2 Authority

[Sections 20.23\(3\)\(a\), Florida Statutes](#)

[Section 334.048\(3\), Florida Statutes](#)

4.1.3 References

The following is a list of Professional Consultant Contract Administration Procedures and Guidelines pertinent to procurement and administration of Consultant CEI.

[350-020-200 Contract Funds Management Funds Approval](#)

[360-050-005 Project Cost Reporting](#)

[375-020-010 Errors, Omissions, and Contractual Breaches by Professional Engineers on Department Contracts](#)

[375-030-001 Professional Services Consultant Qualification](#)

[375-030-002 Acquisition of Professional Services](#)

[375-030-004 Audit Process for Professional Services Consultants and Contracts](#)

[375-030-006 Conflict of Interest Procedure for Department Contracts](#)

[375-030-007 Professional Services Consultant Work Performance Evaluation](#)

[375-030-010 Amendments and Task Work Orders for Professional Service Agreements](#)

[Disbursement Handbook for Employees and Managers](#)

4.1.4 Background

The Department must ensure the Consultant CEI (consultant) is performing services in accordance with the scope of services and the contract.

4.1.5 Role of Consultant CEI

The Department maintains representation in administering construction projects through Professional Services contracts. Hence, the authority of the CCEI firm's lead person, such as the Senior Project Engineer, and the CCEI Project Administrator shall be identical to the Department's Resident Engineer and Project Administrator respectively and shall be interpreted as such. The Consultant is required to exercise their professional judgment in performing their obligations and responsibilities under the contract. However, the Consultant must seek input from the Construction Project Manager, as necessary. Therefore, the Department entrusts the Consultant with the responsibility of administering the project(s) and to implement actions based on their authority, subject to the requirements of **Section 4.1.7**.

The Consultant shall render the services consistent with the standard of care, skill, and diligence exercised by members of the same profession providing similar services under similar conditions at the location of the project and at the time the services are to be performed. Consultants' standard of care shall not be altered by the application, interpretation, or construction of any other provision of the contract.

4.1.6 Pre-Service Phase

Resident Level Responsibilities

A pre-services meeting is required on all Consultant CEI (CCEI) contracts following execution of the contract and prior to the pre-construction conference. Generally, those in attendance will be representatives of the Department's Professional Services Unit, the Construction Project Manager, District Construction Consultant Manager or designee, and the Consultant to discuss administration of the CCEI contract. The Construction Project Manager will be responsible for coordinating the meeting. The pre-services meeting can be

optional if the Firm is already performing services in the District and the District Construction Consultant Manager does not believe the pre-services meeting is needed.

Subjects covered at the meeting will include, but not be limited to:

- (1) Department lines of authority concerning administration of the CCEI contract and the administration of the construction contract.
- (2) Consultant's schedule for identifying field offices, assigning personnel and equipment.
- (3) Terms of the CCEI contract (e.g., approval of Consultant's personnel qualifications, approval of personnel and equipment assignments, rates, etc.). Clarify any portions of the Consultant CEI Scope of Services that are unclear to any parties.
- (4) Invoice procedure as outlined in the ***Invoice Processing section of the [Disbursement Handbook](#)***.
- (5) The coordination between the Construction Project Manager, District Construction Consultant Manager, Professional Services Administrator, and Consultant CEI for processing CCEI supplemental amendments and CCEI invoices.
- (6) Review of the process for the CCEI to contact the Design Consultant for post design services and clarification or correction of plans and specifications.
- (7) Discuss Disadvantaged Business Enterprise (DBE), On-the-Job Training (O.J.T.), and Equal Employment Opportunity (EEO) monitoring and documentation submission requirements.
- (8) The ***Professional Services Consultant Work Performance Evaluation, [Procedure No. 375-030-007](#)***.
- (9) Action required by CCEI prior to start of construction.
- (10) Review of the critical items for successful administration of the construction contract.
- (11) Consultant CEI's Quality Control (Q.C.) Review process.

A complete and concise record (including the names, titles, addresses, and telephone numbers of all participants) of the proceedings of the meeting shall be prepared by the Consultant and approved by the Construction Project Manager. The approved record of the meeting shall be distributed to all participants and other interested parties within 2 weeks following adjournment of the meeting.

4.1.7 Service Phase

Resident Level Responsibilities

The Construction Project Manager, under direct supervision of the Department Resident Engineer or the District Construction Consultant Manager and in turn the District Construction Engineer, must administer the CCEI Contract(s) and monitor the activities of the Consultant(s) engaged in construction contract administration and is in responsible charge of the project(s) at all times. The Construction Project Manager will serve as the liaison to the FHWA and the Department as it relates to various contract administration issues. The areas of responsibility of the District Construction Consultant Manager and Construction Project Manager include:

4.1.7.1 Consultant Personnel

Resident Level Responsibilities

The Construction Project Manager or the District Construction Consultant Manager shall compare the personnel proposed by the Consultant with the Technical Proposal for any changes in personnel. Replacements for the original personnel must have equal or better qualifications than the personnel being replaced. The Construction Project Manager or Resident Engineer and the District Construction Consultant Manager shall jointly review and approve all subsequent additions and deletions to Consultant staffing of a project and all changes in salary. All overtime usage is subject to the terms of the CCEI contract. All salary and personnel approvals shall be in writing.

4.1.7.2 Office Space and Equipment

Shall be in accordance with the CCEI contract.

4.1.7.3 Travel

All travel expenses of the Consultant with reimbursement are not to exceed State of Florida rates, Department policies and limitations, and within the terms of the CCEI contract.

4.1.7.4 Training Courses

District Level Responsibilities

The District Construction Training Administrator or designee shall advise the Consultant, through the Construction Project Manager, of any construction training courses presented by the Department. The District Construction Engineer shall make space available to the Consultant for training that is normally available to Department field personnel. Training is an overhead expense in accordance with Federal Acquisition Regulations. Therefore, training costs are not to be charged directly to Department projects. However, the District Construction Engineer can authorize Consultants in that District to attend District specific informational sessions; in which case, the Consultants will be reimbursed for the hours spent in travel and in the session as part of their billable hours. No additional reimbursement will be made for travel, including but not limited to, mileage, lodging, meals, etc.

4.1.7.5 Consultant Billings

Resident Level Responsibilities

The Construction Project Manager shall review and process Consultant monthly and final invoices according to the ***Invoice Processing section of the [Disbursement Handbook](#)***.

4.1.7.6 Consultant Performance

Resident Level Responsibilities

The consultant CEI performance evaluation is a summary record of the Construction Project Manager's performance reviews of the CEI Consultant, the Quality Assurance Reviews prepared by the Specialty Engineer from the Office of Construction, and the Federal Highway Administration (FHWA) Monthly Field Reports. These source documents should be used as the basis for preparation of the performance evaluation and serve as the in-depth, back-up data needed to substantiate the numerical evaluation given. The Construction Project Manager shall maintain a continuing overview of Consultant performance of duties by 6-month interim reviews of records, inspection procedures, testing procedures, sampling procedures, etc. These performance reviews shall be conducted beginning with the first full 6-month period in accordance with ***Professional Services Consultant Work Performance Evaluation, Procedure No. [375-030-007](#)***.

The Construction Project Manager shall use the **Consultant Evaluation System (CE)** to record 6-month interim and final grades. CEI consultant evaluations shall be completed using either the project-specific CEI evaluation criteria or the CEI Hybrid criteria. If a particular performance item does not apply to a project, it should not be used in the calculation of the weighted average for the performance test area.

Additional interim reviews may be conducted and recorded in the **Consultant Evaluation System** if needed.

The Construction Project Manager may obtain comments from other appropriate District personnel on Consultant's performance.

The Department's PM may offer the consultant CEI the opportunity to request a meeting to discuss a grade with the DCE within ten calendar days of receipt of the evaluation. The DCE shall consider any information submitted by the consultant and decide whether the performance evaluation will be revised. The DCE's decision is final.

The evaluation of the overall performance for the entire contract period shall be the average of all evaluations (interim and final) for the contract and is automatically calculated in CE.

4.1.7.6.1 Initial In-Depth Review

Resident Level Responsibilities

During the early stages of the construction project, the Construction Project Manager must thoroughly evaluate the performance of the Consultant Firm to ensure the Consultant Firm is demonstrating the necessary knowledge, skills and experience to make decisions in accordance with the CCEI Contract. The Construction Project Manager shall conduct an Initial In-depth review for each CCEI contract.

The Initial In-depth review should be conducted within six (6) months of commencement of CCEI services and be documented on **Consultant CEI 6 Month In-Depth Review Report, [Form No. 700-010-03](#)**.

Written records of each review are to be maintained in a contract management file for each CCEI contract for the life of the contract.

The review areas of each CCEI contract shall consist of:

- (1) **Personnel** The Construction Project Manager shall review Consultant staffing to determine if the individuals assigned to

the project are those identified in the technical proposal, and that project staffing is in accordance with the approved staffing plan. All replacement personnel shall have been properly approved and be equally or better qualified to perform in their respective positions, and their rates of pay must be in accordance with the CCEI contract requirements.

- (2) **Equipment** The Construction Project Manager shall check to ensure all equipment as required in the CCEI contract has been provided, is in proper operating condition, is being maintained and calibrated, and is adequate for ongoing and projected construction activities.
- (3) **Construction Contract Administration** The Construction Project Manager shall determine if the Consultant staff has the appropriate construction contract, plans, specifications, design standards, Department procedures, and other pertinent documents available in the project office and that the Consultant is complying with material testing, inspection, documentation, and contract administration requirements.

4.1.7.6.2 Interim Evaluations

Resident Level Responsibilities

Interim performance evaluations shall be completed within 30 days after the end of 6-months.

Each interim performance evaluation should note whether the Consultant's Q.A. reviews were performed every six (6) months by the Consultant Firm. Provide written explanation with supporting backup documentation as necessary for areas identified as "unacceptable" performance to FHWA.

Commendatory or critical comments shall be included in the evaluation to fully explain the intent of the evaluation. The CPM shall provide as much documentation as deemed necessary to fully explain the conditions encountered in the field.

4.1.7.6.2.1 Initial Interim Evaluation

The Construction Project Manager shall prepare and submit the initial interim evaluation at the end of the first six-months of contract performance.

4.1.7.6.3 Final Evaluation

The Construction Project Manager shall prepare and submit a final evaluation on the Consultant's work performance within 30 days after completion and acceptance of basic services, in accordance with ***Professional Services Consultant Work Performance Evaluation, Procedure No. 375-030-007***. The Construction Project Manager shall conduct a performance review for the period from the previous evaluation to the end of the contract.

The final grade for the Consultant should be representative of the performance of the Consultant for the duration of the CCEI contract and will be determined by averaging all the interim grades including the grade for the partial period prior to acceptance.

The Construction Project Manager shall obtain written comments from the District Final Estimates Manager (DFEM) if the DFEM performed a review of the Consultant's final estimates.

If close out of the CCEI contract is requested in order to unencumber the remaining contract funds and a Final Consultant CEI work performance evaluation is required before the final estimate package has been completely checked by the District Final Estimates Office, then a Final Evaluation Grade can be given leaving the Final Estimate Package section blank. A second Final Evaluation Grade shall be given once the Consultant's final estimate package has been completely checked by the District Final Estimates Office, in order to determine an accurate performance grade.

4.1.8 Design-Build Contracts

Resident Level Responsibilities

On Design-Build contracts that include CEI services, the Construction Project Manager shall conduct an Initial In-Depth Review, 6-month Reviews, and Final Evaluation in accordance with this procedure for the Design-Build CEI.

Section 4.2

CONSULTANT CEI ACCOUNTABILITY

4.2.1 Purpose

To establish procedures for the assignment of responsibilities when a Consultant Construction Engineering and Inspection (CCEI) has been determined to have performed work for the Department that has been identified as having errors, omissions, or contractual breaches. This procedure is for use by the Department to document the deficiency and the additional costs and damages sustained and establish the requirement for a recommendation for action against the Consultant.

The identification of errors and/or omissions as a result of incorrect final estimate shall be in accordance with *the Review and Administration Manual*, [Procedure No. 700-050-005](#).

4.2.2 Authority

[Sections 334.048\(3\), Florida Statutes](#)
[Section 20.23\(3\)\(a\), Florida Statutes](#)

4.2.3 References

[Section 337.015, Florida Statutes](#)

4.2.4 Background

Throughout the construction phase of the Department's construction contract under the management of a Consultant CEI, quality assurance reviews are performed. Reviews performed by both the District Construction Engineer's staff and the State Construction Office staff, as well as reviews performed by the FHWA, are intended to determine whether the work performed on the project is of an acceptable level of quality as established in the contract documents for the project.

There have been instances in the past whereby Consultant CEI firms have not performed in full conformity with the Consultant Contract. These instances have at times cost the Department, either through additional work paid to the construction Contractor or through remedial costs to correct defective work in the contract administration or documentation.

This procedure outlines the assessment of responsibility that the Department's Construction Project Manager in charge of the Consultant CEI Contract must complete after reviewing the project performance.

4.2.5 Identification of Errors, Omissions, or Contractual Breaches

4.2.5.1 Resident Level Responsibilities

The initial identification of the errors, omissions, or contractual breaches is the responsibility of the Construction Project Manager. This is accomplished through routine project and quality assurance (Q.A.) reviews of the Consultant's work product, records, and performance grades. Reviews should be made on a continual basis and will be documented during the Consultant's quarterly performance evaluation.

If the Consultant CEI contractual performance, staffing, equipment, or contract administration is found unacceptable and not in agreement with historical Department decisions during a Department QA review, the deficiency shall be clearly defined in writing, and the authority (contract section, article, page, etc.) cited. The Construction Project Manager shall prepare appropriate correspondence for the District Construction Engineer's (or designee) signature outlining the deficiency and identifying a reasonable time frame for Consultant corrective action.

If the noted deficiencies are directly attributable to the Project Administrator or the inspectors, corrective action shall first be directed in writing to the Consultant Senior Project Engineer, and/or the Consultant Principal-in-Charge, with copies to the District Construction Consultant Manager, and the District General Counsel. If no apparent action is taken within 30 days, the concerns shall be clearly conveyed directly to the Consultant Principal-in-Charge, with a copy to the Consultant Senior Project Engineer, the District Construction Consultant Manager, and the District General Counsel.

If the issues are directly attributable to the Consultant Senior Project Engineer, the concerns shall be conveyed to the Consultant Principal-in-Charge and a copy to the District Construction Consultant Manager and the District General Counsel. During the period of correction, the Consultant's actions and progress shall be closely monitored. The relationship involved here is contractual, and the Department must allow the Consultant sufficient and reasonable time to correct noted deficiencies with their contract performance, as appropriate under the circumstances.

If appropriate action is not taken to correct the deficiencies, the District Construction Engineer (or designee) will direct the Consultant in writing to provide a written response to

the deficiencies addressing the reasons why the issues have not been addressed and a plan outlining the time frame within which all issues will be addressed. If the response is acceptable to the Department, corrective actions and a time frame for corrective action shall be approved in writing. Continued monitoring by District staff is required. A follow-up at the end of the specified correction period will be prepared based on the staff's investigation at that time. A copy of the report should be sent to the District General Counsel, the District Director of Transportation Operations, and the District Professional Services Administrator.

The District Construction Engineer, through his staff and with the advice of the District General Counsel, shall perform a comprehensive review after-the-fact to determine if the Department or the Contractor suffered any damages during this period. If damages were sustained, the recovery of any identified costs and damages shall be in accordance with the procedure for ***Errors, Omissions, and Contractual Breaches by Professional Engineers On Department Contracts***, [Procedure No. 375-020-010](#).

4.2.6 Consultant Contract Termination

If the Consultant CEI does not follow through with the corrective action or the action taken is unsuccessful, the District Construction Engineer will summarize the findings and provide a recommendation for termination to a committee comprised of the District Secretary, the District Director of Transportation Operations, and the State Construction Engineer (or designee). The Chief Construction Litigation Attorney (or designee) shall be a non-voting legal advisor to the committee. The FHWA shall be given a copy of the written findings from the committee on all Federal Aid projects.

If the committee concurs with the recommendation, the District Construction Engineer will forward a copy of the findings, with a recommendation for execution of a Termination Agreement (or, in the event the Consultant refuses to agree to termination, a unilateral termination) to the District Professional Services Administrator. The contract shall then be terminated for cause. The District will then be responsible for completing the CEI on the project, either through another CCEI Contract or with in-house personnel.

- (A) If this action is followed through to termination, the District Construction Engineer must ensure the following become the possession of the Department:
 - (1) All files, records, and documents given to the Consultant, or kept by the Consultant as part of his contractual obligation.
 - (2) All record books (piling, density log, etc.).

- (3) All equipment supplied by the Department.
 - (4) All files, records, and documents kept by subconsultants, as well as certification of payment.
 - (5) All personal logs or diaries pertaining to the construction or CEI contracts kept by the Senior Project Engineer, Project Administrator, or Inspectors.
- (B) The District Construction Engineer will immediately notify the construction Contractor that the termination of the Consultant CEI has taken place. The Contractor will then be notified who will be assigned the CEI responsibilities. As soon as possible, the District Construction Engineer shall arrange for a meeting between the Contractor and the newly appointed Resident Engineer or the Senior Project Engineer in case of a Consultant CEI.
- (C) The Construction Project Manager will notify the District Office of Information Technology of the termination. A list of all Consultant personnel associated with the project who have computer access authority will be provided so that the access privileges will be revoked immediately.
- (D) Upon securing the records and reassigning the responsibilities of the construction project management, the District Construction Engineer shall perform a comprehensive investigation of all costs incurred by the Department or its Contractor due to this termination and/or the actions (or inactions) of the Consultant leading up to the termination. This shall include all administrative, construction, or legal costs incurred. If damages were sustained, the recovery of any identified costs and damages shall be in accordance with the procedure for ***Errors, Omissions and Contractual Breaches by Professional Engineers on Department Contracts***, [Procedure No. 375-020-010](#) .
- (E) The District Professional Services Administrator will process a final ***Consultant CEI Work Performance Evaluation*** completed by the Construction Project Manager in accordance with ***Professional Services Consultant Work Performance Evaluation***, [Procedure No. 375-030-007](#). This information shall be considered in selection of future CEI Consultants throughout the State.

Section 5.1

PROJECT DIARY

5.1.1 Purpose

To provide a uniform standard for daily and weekly construction project reporting.

5.1.2 Authority

Section 334.048, Florida Statutes

Section 20.23(4)(a), Florida Statutes

5.1.3 Background

The ***Daily Report of Construction, Form No. 700-010-13*** was originally developed for completion by an inspector for each Contractor that was present on the jobsite each day. With the implementation of AASHTOWARE Project Construction (PrC), this form was changed to more logically resemble the order that a technician will need to enter data into AASHTOWARE Project Construction (PrC). The ***Daily Work Report*** in AASHTOWARE Project Construction (PrC) (SM) is to be completed by each technician doing construction inspection daily and covers all work of all Contractors, subcontractors, subordinate subcontractors and utility companies that the technician observes during that day's operations. One ***Daily Work Report*** per inspector, per day per contract, is required.

This procedure provides information on requirements for completing the ***Daily Work Report*** with the automated process contained in AASHTOWARE Project Construction (PrC).

5.1.4 Definitions

Daily Diary: Term used in AASHTOWARE Project Construction (PrC) to refer to a collection of all ***Daily Work Reports*** and presents information on contract activity for a given day. The diary should contain information on significant events, conditions or circumstances which immediately affect or have future impact on the project or contract.

Daily Work Report (DWR): This is the term used in AASHTOWARE Project Construction

(PrC) to refer to the **Daily Report of Construction Form No. 700-010-13** that was used by Florida Department of Transportation before the implementation of AASHTOWARE Project Construction (PrC). Data is collected on every phase of work performed by a Contractor, subcontractor, subordinate subcontractor or utility company. Recorded information must be clear, detailed, accurate, complete and objective.

Engineer's Weekly Summary, Form No. 700-010-14: This document provides a summary that gives project status and documents significant events, conditions or circumstances, which immediately affect, or have future impact on, the project or contract. This is not required if **Daily Work Reports** and **Daily Diaries** are entered directly into AASHTOWARE Project Construction (PrC). This is only required for those projects or contracts that are being done manually but is recommended on all projects.

Project Diary: Refers to all documents that present a recorded collection of events, data, occurrences, instructions, situations, circumstances and work performed each day during a construction project. **Project Diary** includes, **Daily Work Reports, Daily Diaries, Work Plan Controlling items of work.**

Work Plan - Controlling Item of Work, Form No. 700-010-15: This documents the Contractor's planned scheduled of work identifying those items of work that will control the over-all progress of the Contractor's work effort on projects without Critical Path Method (CPM) Schedule.

5.1.5 Responsibility

Completing the **DWR** in AASHTOWARE Project Construction (PrC):

(A) Resident Level Responsibilities

- (1) Each technician responsible for the inspection of work must report all work, events, etc, using the **DWR** function within AASHTOWARE Project Construction (PrC) (for detailed instructions on how to use this function in AASHTOWARE Project Construction (PrC), please refer to the [AASHTOWARE Project Construction \(PrC\) User Instruction Manual](#) posted on the State Construction Office InfoNet WEB page).
- (2) The Project Administrator (PA) is responsible for reviewing and approving each **DWR** using the **Daily Diary** functions within AASHTOWARE Project Construction (PrC). The PA shall complete a **Diary** for each Contract day so that time may be

charged correctly. The Project Administrator shall record all comments as necessary to provide information on events or circumstances that might impact the project or contract in the future. The Project Administrator may also complete a **DWR** for any work personally inspected.

- (3) The Project Administrator and the Contractor, in accordance with **Section 5.1.6.3(A)**, are responsible for completing the **Work Plan - Controlling Item of Work, Form No. 700-010-15**, for the controlling work items on projects without a CPM schedule on either a weekly or biweekly basis.

5.1.6 Information Collection

5.1.6.1 Daily Work Report

(A) Resident Level Responsibilities

- (1) A **DWR** is completed by each Department technician or Consultant Construction Engineering Inspection (CCEI) technician responsible for the inspection of work during each contract workday. The prime Contractor, subcontractor, or subordinate subcontractor may perform the work.
- (2) A **DWR** should be prepared for every contract day for the Prime Contractor, regardless whether the Prime is working on the project or not. This **DWR** should also reflect all subcontractors on the project for that day. In the event that the subcontractor leaves the project for a long period, the sub-contractor need not be shown on the **DWR** during a period of absence, provided, it is noted on the **DWR** for the day the subcontractor last worked that the subcontractor intended to leave the project and on the **DWR** for the day the subcontractor resumes work that the subcontractor did not perform any work for the period with specific dates. When utility companies are performing non-reimbursable work, the utility personnel and equipment should be tracked using the Utility remark in the **DWR** Information Tab.
- (3) A new week starts on a Monday and ends on a Sunday.
- (4) Electronic information to be collected includes but is not limited to the following:
- a. **DWR** Information Tab:
 1. Weather conditions (AM and PM)

2. Use terms such as: clear, partly cloudy, heavy clouds, light rain, heavy rain, intermittent showers, etc,
3. State length of time, i.e., all day, 4 hours, 8:00 - 10:00 A.M., etc.,
4. Report soil conditions: dry soil, wet soil, extremely wet soil.

b. Working Conditions

1. Effects of weather on major work items,
2. Remarks include anything pertinent to the progress of the projects such as:
 - (1) Instructions given to the Contractor or subcontractor or their representatives,
 - (2) Work or materials rejected and why,
 - (3) Any delays, including any items of work affected,
 - (4) Any extraordinary work being performed,
 - (5) Unusual or unexpected conditions such as flooding, sinkhole, etc,
 - (6) Any discussions with representatives of the Contractor, subcontractor or utility company,
 - (7) Observations by the technician of significant importance to the project progress,
 - (8) Lane closure, traffic disruption, etc.,
 - (9) Contacts with property owners, media, etc.,
 - (10) CPM activity ID number (when applicable),
 - (11) Observations by the technician of unacceptable Contractor quality control practices,
 - (12) Operation (work) being performed,
 - (13) Materials received (general description).

3. Date

(5) Contractor's Tab:

- a. Contractor's or subcontractor's name,

-
- b. Number of Contractor or subcontractor personnel,
 - c. Number of hours on the project for personnel.
- (6) Equipment Tab:
- a. Equipment idle or active,
 - 1. Contractor drop down,
 - 2. The "Equipment ID" space will be used to record a unique identifier for a single piece of equipment whenever necessary to track a specific piece of equipment or a unique group identifier when grouping several like pieces of equipment together.
 - 3. "number of Pieces" will be used to record the number of pieces of equipment present on or at the job site. If "Equipment ID" was for a unique piece of equipment then the quantity shown would be one, otherwise it would be the total number contained within the group identified by the "Equipment ID".
 - 4. "number Used" will be used to record the number of pieces on or at the job site that is being actively used that day.
 - 5. "Hours Used" is the total number of hours that the identified equipment is being used. If number hours used is zero, then equipment is considered inactive.
- (7) Work Items Tab:
- a. Financial Project number,
 - b. Pay Item Code,
 - c. Line Item Number,
 - d. Project location,
 - e. Quantities,
 - f. Contractor or Subcontractor performing the work.
- (8) Within AASHTOWARE Project Construction (PrC), each **DWR** is electronically marked by user ID, date and time stamp as belonging to that technician. When

the Project Administrator creates a **Diary** for that day, and approves the **DWR** for each technician, the **DWRs** are locked to any changes that can be made by the inspector until unlocked by the Project Administrator. After a AASHTOWARE Project Construction (PrC) Estimate has been paid, the **DWRs** are permanently locked where no changes can be made by anyone. This method assures accountability by the technician for the information that was included on each of the **DWRs**. The system also maintains an electronic stamp of the Project Administrator's user ID, time and date stamp when approvals were done.

5.6.1.2 Engineer's Weekly Summary

(A) Resident Level Responsibilities

- (1) The **Engineer's Weekly Summary**, [Form No. 700-010-14](#), is to be completed by each Project Administrator for each project or contract for which documentation is done manually on the **Daily Report of Construction**, [Form No. 700-010-13](#), and not using AASHTOWARE Project Construction (PrC) for contract documentation. A Summary is not required for contracts being managed through AASHTOWARE Project Construction (PrC) but is strongly recommended. The weekly period is from Monday through Sunday. A Summary is completed every week including periods of no work.
- (2) The Summary must give project status and document significant events, conditions or circumstances which immediately affect, or have future impact on, the project or contract. The Summary includes completion percentages for job progress and elapsed time. The Engineer must note items such as:
 - a. Contractor's or subcontractor's progress versus schedule or work plan,
 - b. The day of the week the Contractor or subcontractor stopped work or began work,
 - c. The day of the week the Contractor elected not to work or was unable to work at least 50% of the normal workday on a pre-determined controlling item of work item due to adverse weather conditions.
 - d. The items which change the plans, specifications or contract which could lead to:
 1. Contractor claim,

-
2. Request for a time extension,
 3. A supplemental agreement.
- e. For utility relocation construction, it is important to note the contract agreement number, the beginning date and the ending date of work.
 - f. Contractor made repairs to work damaged by weather.
 - g. State if a particular subcontractor finished all the contract work and has left the project for good. If the Prime or the Sub has not been on a project, state accordingly the last date they worked on the project.
 - h. Other items affecting the contract or project.

5.1.6.3 Work Plan

The objective of the "**Work Plan - Controlling Item of Work**", [Form No. 700-010-15](#) is to provide the Contractor a uniform method to communicate what work Items are considered to control the overall progress of the work on projects without a **CPM** schedule. In order for the Contractor to be eligible for weather related time extensions, "predetermined controlling items of work" must be impeded more than 50% of the normal work day.

"Controlling Items of Work" are defined in the **Standard Specifications for Road and Bridge Construction**. "Predetermined" means that the items are as defined in the Contractor's **CPM** schedule or on projects without a **CPM** schedule, the Contractor must tell the Project Administrator prior to beginning the work which items are "controlling items of work". The Project Administrator should give the Contractor the "**Work Plan - Controlling Item of Work**" form during the preconstruction meeting on projects without a **CPM** schedule specification. While the Contractor is not mandated to use **Form No. 700-010-15**, the information is required if the Contractor wants to receive consideration for weather related time extensions.

In addition to listing the controlling items of work on projects without a **CPM** schedule, this is the form for the Contractor to notify the Project Administrator of the planned work schedule. The planned work schedule is crucial documentation in determining any days that may be granted due to the effects of weather. Calculation of weather days is to be done in accordance with the **CPAM Chapter 7 Section 7, Time Extensions**. The work plan will be for either a one- or two-week period.

(A) Resident Level Responsibility

On projects with a **CPM** schedule, the accepted and updated CPM schedule defines the **Controlling Items of Work**. On projects without a **CPM** schedule, the Contractor is responsible for identifying and notifying the Project Administrator of Controlling Items of Work. The Project Administrator shall review the Contractor's list of **Controlling Items of Work** and comments. Both the Contractor and the Project Administrator have a place on the form for each other's comments. If the Project Administrator disagrees with items of work listed or disagrees with the Contractor's comments, this disagreement must be noted in the Project Administrator's comment section. The Project Administrator must ensure that the work proposed by the Contractor complies with any sequencing or other requirements established in the contract provisions, plans or the **Standard Specifications**.

Department approval of the work plan is by the Resident or designee.

5.1.6.3.1 Work Plan Meeting

(A) Resident Level Responsibility

The Contractor's superintendent and the Project Administrator will meet to discuss the contractor's proposed operations for the upcoming period. The Project Administrator will review the Contractor's planned operations to verify that listed **Controlling Items of Work** planned work activities are consistent with the accepted schedule. For projects without a **CPM** schedule, that plan identifies controlling work items expected to be underway during the upcoming weekly or biweekly period. The first **Work Plan - Controlling Item of Work** is to be submitted to the Resident Engineer or Project Administrator on the first Monday preceding the first chargeable contract day. Subsequent submittals will be on Mondays or as established by the Project Administrator at the preconstruction meeting. The submittal frequency will be based upon the size, complexity and duration of the project.

On projects without a **CPM** schedule, a work plan will become a part of the Project Diary and shall be included with the **Engineer's Weekly Summary**, [Form No. 700-010-14](#), each week.

The work plan is required during periods of no work. The Contractor should detail how the Maintenance of Traffic plan will be inspected and maintained during periods of no work.

Section 5.2

CONTRACTOR VEHICLE REGISTRATION

5.2.1 Purpose

The 1987 Florida Legislature enacted legislation requiring Florida registration of all motor vehicles operated or caused to be operated in Florida by Contractors.

5.2.2 Authority

Section 334.048(3), 20.23(3)(a), Florida Statutes (F.S.)

5.2.3 References

Section 337.11(13), Section 337.141(2), F.S., Section 7-23 Standard Specifications for Road and Bridge Construction

5.2.4 General

All Contractor vehicles used on Department construction or maintenance projects shall be registered in Florida. The Contractor is required to sign an affidavit ***Contractor's Affidavit Vehicle Registration, Form No. 700-010-52***, that all Contractor vehicles (owned or rented) to be operated on the project are registered in the State of Florida. Private vehicles and farm tractors do not have to be registered in Florida.

If the Contractor has registered their company vehicle through the International Registration Plan (IRP) or in a State that has an Interstate Reciprocal Agreement (IRA) with the State of Florida, the Contractor shall provide documentation from the Florida Department of Highway Safety and Motor Vehicles verifying this registration. This documentation shall be attached to the completed ***Contractor's Affidavit Vehicle Registration, Form No. 700-010-52***.

5.2.4 Preconstruction Conference

Resident Level Responsibilities

The Contractor should be reminded of the requirement to have motor vehicles registered in the State of Florida at the preconstruction conference.

The affidavit is due on the first working day of the project.

5.2.5 Affidavit

The digitally signed or notarized affidavit shall be retained by the Department and will be scanned into the Department's approved Electronic Document Management System.

5.2.6 Contractor Failure

Resident Level Responsibilities

- (1) If the Contractor fails to return the affidavit, progress payments are to be withheld. Failure to register motor vehicles may result in suspension or revocation of a Contractor's Certificate of Qualification.
- (2) If Department personnel or their representatives observe that a vehicle is being used on a project with an out-of-state license tag, the Contractor is to be immediately notified of this observation. Upon this notification, the Contractor will be required to correct this violation no later than the cutoff date of the second monthly pay estimate from such notification. Removal of the vehicle from the project or proof of Florida registration will correct this violation.
- (3) The Office of Construction is to be notified of willful violations on the part of any Contractor.

Section 5.3

SUBLETTING OF CONTRACT

5.3.1 Purpose

To provide uniform standards for subletting contracts.

5.3.2 Authority

Sections 20.23(3)(a) and 334.048(3) Florida Statutes (F.S.)

5.3.3 References

Section 337.137, F.S.
Federal Aid Policy Guide, 23 CFR 635.116(b)
Section 8-1, Standard Specifications for Road & Bridge Construction

5.3.4 General

The prime Contractor shall certify that each subcontract arrangement will be in the form of a written agreement containing all the requirements and pertinent provisions of the prime contract. Upon request, the prime shall furnish the Department with a copy of the subcontract or written agreement.

5.3.5 Certification of Sublet Work

(A) Resident Level Responsibilities

The prime Contractor will be required to submit **Form No. 700-010-36, Certification of Sublet Work**, and a schedule of values (“schedule” or “schedule A”) showing the appropriate pay items to be sublet. The Certification of Sublet Work and the schedule are to be submitted by the prime Contractor.

The schedule shall include pay item numbers, description, actual quantities to be sublet (partial, if appropriate), unit prices (price subcontractor is to receive) and the total dollar amount for each item (see Sections 5.3.9 and 5.3.10 for more details on Full/Partial unit

prices). For lump sum projects, the schedule shall show a breakdown of each item of work to a level of detail that the work can be clearly identified and a description of work, in lieu of pay item number and item description, and total dollar amount of sublet work. The prices shown on the schedule may not match the bid unit prices.

- (A) When a ***Certification of Sublet Work*** is submitted, a review to ensure item numbers are correct, legible, and work clearly identifiable, shall be performed in conjunction with the remaining review. If the Contractor sublets a portion of a contract item, the Department will use only the sublet proportional cost in determining the percentage of subcontracted work.
- (B) When a subcontractor (Firm "A") fails to complete work and another subcontractor (Firm "B") is authorized to complete the remaining portion of the work, a sublet certification identifying work actually performed by the subcontractor (Firm "A") shall be submitted to revise the first certification. This revision will replace/modify the original certification and should be so specified. A new certification shall be submitted by the replacement subcontractor (Firm "B") reflecting work to be performed, whether totally or partially.

5.3.6 Responsibilities

(A) Resident Level Responsibilities

- (1) Each certification of sublet work and schedule will be retained by the Department and will be scanned into the Department's approved Electronic Document Management System.
- (2) A copy of each certification of sublet shall be made available to the Resident Engineer/Operation Engineer.
- (3) The Resident Engineer/Operation Engineer shall review at least one (1) ***Certification of Sublet Work*** per contract to ensure that the Contractor has met all State and Federal requirements.

(B) District Level Responsibilities

- (1) The District office shall also make review part of their QA plan.

5.3.7 Form Processing

(A) Resident Level Responsibilities

- (1) The Resident Office will examine at least one (1) **Certification of Sublet Work** per project (more if non-compliance is found).
- (2) The percent of work sublet must be less than the percent (noted in the contract) of the total work in the contract, excluding the contingency pay items.
- (3) Unit prices on the certification shall be contract prices or designated with a "P" (partial) with appropriate explanation.
- (4) Any subcontractor whose name appears on the **Contractor's Suspension Report** shall not be considered for subcontract work. A copy of the **Contractor's Suspension Report** is available from the Office of Construction website. [View Suspension List](#).
- (5) Any subcontractor whose name appears on the Federal System for Award Management (SAM) website with an active exclusion shall not be considered for subcontract work as indicated in the exclusion. A hyperlink to the Federal SAM website is available from the Office of Construction website (same web page as the Suspension Report mentioned in item #4).
- (6) Upon completion of the review of a sublet certification, the document should be uploaded into EDMS and notification sent to the District Compliance Officer via email.

5.3.8 Documentation

(A) Resident Level Responsibilities

The Resident Office will incorporate a process to verify that subcontracts have met all State and Federal requirements, including the inclusion of FHWA Form 1273 for subcontracts on federal-aid jobs. This verification process will begin within the first 90 days after contract execution (or from work begin date on design-build contracts), and will include no less than 20% of all subcontracts and purchase orders (more if non-compliance is found).

Documentation of the review of the subcontract (including the attachments) must be kept by the Resident Office with the Resident's copy of **Form No. 700-010-36, Certification of Sublet Work**. Such documentation can be a signed memorandum to the file or a stamp on the office copy of the subcontract signed by the reviewer. A copy of any terms pertaining to labor, material, or equipment necessary to monitor and/or administer the contract will be made available to field staff.

5.3.9 Full Unit Prices

Regardless of the prices agreed upon with the subcontractor, the total amount shown on the **Certification of Sublet Work** shall be the same as those in the contract (bid unit prices) with the Department where it is proposed to sublet all work in a pay item. The Schedule A will show the price the subcontractor is to be paid.

5.3.10 Partial Unit Prices

If it is proposed to sublet only part of the work in a pay item, such item shall be designated with "P" and the unit price shown on the **Certification of Sublet Work** shall be the actual price agreed upon with the subcontractor.

On the certification forms for pay item with "P" designation, the Contractor will be required to include a brief description of that portion of the work in that pay item which is to be sublet. The description shall contain sufficient information for determination as to what work the subcontractor will perform. In his/her review, the Engineer shall make a determination as to whether the unit price shown for the "P" item appears reasonable for the partial work to be accomplished by the subcontractor. If the price for the "P" item appears too low, the prime Contractor shall be requested to provide further justification.

5.3.11 Subordinate Sublets

The same **Certification of Sublet Work** form including prices with subcontractor, as well as the procedure indicated above will be required for subordinate sublet certifications. Both the subcontractor's and the subordinate's names shall appear in the space provided.

Calculations determining Total Proportion of Work Certified to Sublet are to be excluded on Subordinate Requests.

Section 5.4

CONTRACT WAGE REQUIREMENTS

5.4.1 Purpose

To provide a uniform process for reviewing and processing Contractor payroll submittals, conducting labor interviews, issuing violations and adding wage classifications to the contract, that are requirements on all Federally-funded Construction Contracts over \$2,000.00.

5.4.2 Authority

Sections 20.23(3)(a) and 334.048 (3), Florida Statutes (F.S.)

5.4.3 Reference

Required Contract Provisions - Federal Aid Construction Contracts (Form FHWA-1273)
Note: FHWA -1273 was revised May 1, 2012 and this version applies to contracts let after August 10, 2012. Regulated under Title 23 CFR 633.102.

5.4.4 General

The Contractor is required to comply with the “government contract acts”, (***Davis Bacon Act, the Copeland Act and the Contract Work Hours and Safety Standards Act (CWHSSA)***), which are regulated by the ***U.S. Department of Labor***. The government contract acts regulate payment of wages, record keeping and reporting, and overtime pay respectively. Construction workers shall be paid at rates no less than those prescribed in the wage determinations of the contract. Payrolls and basic records relating thereto shall be maintained by the Contractor/subcontractor during the course of the work and preserved as required. All overtime hours (all those over 40 in a work week) shall be paid at rates no less than 1.5 times the employee's basic rate of pay. Coverage by these acts will be indicated in the contract by inclusion of ***Special Provision Sub-article 7-1.1*** which invokes the ***Form FHWA-1273***. Florida has a minimum wage law that applies to workers on all Florida Department of Transportation (FDOT) construction projects including those federally funded. On federally-funded construction projects, where the Florida minimum wage is higher than a required minimum rate on a Wage Determination, the Florida minimum wage must be paid. Compliance is enforced on a day-to-day basis by the FDOT, as the contracting agency.

5.4.5 Federal Wage Rate Determination(s) & Poster

(A) Resident Level Responsibilities

The wage determination (including any conformed additional classification(s) and wage rate(s)) and the ***Davis Bacon Poster (WH-1321)*** shall be posted at all times by the contractor, at the site of the work in a prominent and accessible place, where it can be easily seen by the workers. ***The Additional Federal Wage Rate Decision Form No. 700-010-67*** is provided to make posting, of conformances on the project bulletin board easier. A copy of the appropriate determination(s) is provided in the contract. The poster can be obtained from the Department's website. The poster is also available from the FDOT Equal Opportunity Office (EEO) website. And the wage determinations can be obtained from the USDOL "Wage Determinations OnLine.gov" site.

The prime Contractor is required to post the applicable wage determination(s) on the job site bulletin board. This is the wage determination(s) in the contract, unless an amendment has been made to the contract. Amendments are sometimes made because the award date exceeds 90 days past the letting.

5.4.6 Payroll Requirements

(A) Resident Level Responsibilities

Each Contractor shall furnish an original certified payroll in accordance with the specifications in 4-1 of the FDOT Standard Specifications for Road and Bridge Construction. Digital certificates used to sign payroll documents must be acquired from one of the approved digital certificate authorities approved by the Department and be of a National Institute of Standards and Technology (NIST) assurance level of three (3) or higher. The submittal will be digitally signed and submitted, to the Resident Engineer (or their designee) for wages paid each of its employees (including apprentices, trainees, watchmen and guards engaged in work during the preceding weekly payroll period), each week in which any contract work is performed. The Contractor is also responsible for submitting the payrolls for all subcontractors. The payrolls submitted shall state accurately and completely the information required. All payroll records submitted shall contain the employee's name, the employee's id number (applies to contracts let 2009 or later), correct work classification(s), and hourly rate(s) of wages paid including any fringe benefits (as set forth in ***Section 1(6)2(b)*** of the ***Davis-Bacon Act***), daily and weekly number of hours worked on the project, gross wages on the project and all projects, the amount and purpose of each deduction(s) made, and actual net wages paid. All

employee deductions must be shown on each payroll, or submitted on supplemental data attached to the payroll, specifying the purpose and amount of each deduction. The prime Contractor is responsible for the submission of certified payrolls by all subcontractors. The payrolls are due within seven (7) days of the regular payment date of the payroll. On contracts let before January 19, 2009, the employee's address should be reported and the employee's social security number would be used for the employee identification.

On all contracts, the contractor and subcontractor shall maintain records that document the full social security number, race, gender and current address of each covered worker and shall provide these records upon request to the Department. It is not a contract violation for the prime contractor to require the subcontractor to provide employee information such as race, gender, addresses and social security numbers to the prime for their records. (**See FHWA 1273 Section IV 3(b)**).

Payrolls shall be checked for completeness and accuracy. Whiteouts are not acceptable. Corrections may be struck through and initialed by the person authorized to make changes to the payroll. Though it is not possible to check every entry on every payroll, the following minimums shall be adhered to for guidelines; and additional checks may be required if deemed necessary. The first payroll each Contractor/subcontractor submits on the project shall be checked completely for, but not limited to, errors, omissions, misclassifications, unauthorized deductions, or inadequate pay. Thereafter, spot checks shall be made at no less than 1 in every 10 entries on payrolls. The entries checked will be checked off or initialed by the Resident Compliance Specialist (RCS) to signify and acknowledge the entry verification. Then either the first page or the Statement of Compliance of every payroll should be stamped or signed by the reviewer including the date of review. This process is done electronically. Upon satisfaction by the RCS, of the accuracy of payrolls submitted by an individual Contractor, and upon approval of the District Contract Compliance Manager (DCCM) or their designated representative, the minimum checking requirements may be lessened.

5.4.7 Statement of Compliance

(A) Resident Level Responsibilities

Each payroll submitted shall be accompanied by a **Payroll Form [WH-347 or Form No. 700-010-69](#)** (or an equivalent document containing all of the information required by the USDOL), digitally signed by the Contractor or subcontractor, or his/her agent who pays or supervises the payment of the persons employed under the contract, and must certify the following:

- (1) The payroll for the pay period contains the information required and that such

- information is correct and complete. That such laborer(s) or mechanic(s) (including apprentices and trainees) employed on the contract during the payroll period have been paid the full wages earned and that no deductions, directly or indirectly have been made other than those permissible.
- (2) All payrolls under this contract required to be submitted for the payroll period are correct and complete and that each laborer or mechanic has been paid no less than the applicable wage rates for the classification of work performed, as specified in the applicable wage rate determination incorporated into the contract.
 - (3) Apprentices employed in the pay period are registered in a bona fide apprenticeship program registered with the State. And in addition to the basic hourly wage, fringe benefits are either paid into approved plans, funds or programs or are paid in cash to the employee.

Payroll Forms shall be furnished by all Contractors/subcontractors working on Federal Aid Projects. This form must be furnished when the Contractor/subcontractor begins work and is required to be submitted to the Resident Engineer (or their designee) each week thereafter with respect to the wages paid to each employee.

Photocopies or “pdf” copies of the “Statement of Compliance”, faxed “Statements of Compliance”, or an electronically scanned “Statement of Compliance” e-mailed to an agency do not satisfy the requirement that each “Statement of Compliance” be: “signed by the contractor or subcontractor or his or her agent who pays or supervises the payment of the persons employed under the contract.”

However, WHD affirms that the use of digital signatures is sufficient for compliance purposes, and electronic submission of certified payrolls is required by the Department.

5.4.8 Notification of Payroll Violation

(A) Resident Level Responsibilities

A **Notification of Payroll Violation**, [Form No. 700-010-59](#), detailing the type of violation and requesting correction or clarification shall be issued by the Resident Engineer (or their designee) when it is determined that certified payrolls contain errors, or that required wage/payroll information is omitted or erroneous. Phone calls shall not be placed in lieu of issuance of this form; however, phone calls should be used to obtain clarification in making a determination on whether information is omitted or erroneous. The violation shall be recorded in the Construction Automated Reporting System (CARS) in the Classification Request Manager & Payroll Violations Module.

The prime contractor is responsible for obtaining and forwarding to the RCS all documentation and records required to satisfactorily resolve all notices of noncompliance and payroll violations issued for their own workforce, their subcontractors, temporary employment agencies, and rental agreements with operators.

See **Guidance document 5.4.C** for examples of payroll violations which may help you discern which code violation to use.

Payroll violations are identified by a code number. The codes range from 1-7 and some are considered more severe than others.

**Table 5.4.1
PAYROLL VIOLATION CODES**

CODE	DESCRIPTION
1	Time and one-half rates were not paid for work performed in excess of 40 hours.
3	Improper classification of employees.
4	Hourly rate paid is less than minimum authorized wage rate for classification of work shown and included in the construction contract.
5	Certified payroll contains mathematical errors that indicate payment made to the employee violated federal labor or contract provisions.
6	Unauthorized payroll deductions.
7	Other violation not listed above.

If the violation indicated is a Code 1, a violation penalty of \$10.00 per day is assessed plus additional gross wages due. The RCS will email copies of the **Notification of Payroll Violation, Form No. 700-010-59** as well as copies of the cited payroll as follows. The RCS will take the following action for Code 1 violations:

- (1) Review the violation(s) and prepare a letter for the Resident Engineer's signature and send a letter by Email, Return Receipt Requested, (See **Guidance Document 5-4-A** for this **section**), to the prime Contractor. The letter shall identify the violation(s) and dollar amount of wages owed, and requesting that supplemental payrolls, canceled payroll checks or some other proof or evidence that restitution has been made to the employee, and an explanation

regarding the cause for noncompliance be furnished to the RCS. The labor violation **Notification of Payroll Violation Form No 700-010-59** and the **Labor Overtime Violation Withholding/Release, Form No. 700-010-54** shall be attached thereto. Copies of these documents shall be distributed electronically to District Final Estimates Office, District Compliance Office, and District Construction Engineer.

- (2) Upon receipt and subsequent review of the certified supplemental payroll, and an approved method of evidence of payment and an explanation provided by the Contractor, the RCS will prepare a letter for the Resident Engineer's signature and send a letter electronically (**See Guidance Document 5-4-B** for this section) to District Final Estimates Office recommending a course of action for the disposition of the monies withheld. Copies of this distribution shall be made to the District Compliance Office and District Construction Engineer.
- (3) Following the District's recommendation for the final disposition of the Contractor's monies withheld, the RCS shall prepare a letter for the Resident Engineer's signature and send another **Labor Overtime Violation Withholding/Release letter** indicating the required action electronically to the District Compliance Office.
- (4) The Resident Engineer shall notify the prime Contractor electronically in writing of the final disposition of the violation monies withheld and a copy of this notification shall be forwarded to the District Construction Engineer's Office that issued the violation.

The prime Contractor is responsible for obtaining and forwarding to the RCS, all documentation and records required to satisfactorily resolve Code 1 violations issued for contract work performed by their subcontractors or under rental agreements. In the event that resolution could not be met between the Department and the Contractor the Payroll Violation will be forwarded to FHWA for a decision from the Division Administrator of FHWA or his designee. This decision is final and binding on the Department and the Contractor, subject to the contractor's appeal as set forth below. Therefore, the total amount of additional wages due and penalties have been withheld from progress or final payment on this contract pending final determination by the FHWA and or appeal by the Contractor.

Any appeal from the finding of fact and determinations of the FHWA must be filed within 60 days from the date of the withholding of funds on this contract. The 60 days begins with the date on which this formal notice of the withholding of funds is received by the

contractor by email (return receipt requested). The aggrieved Contractor or Sub-contractor shall have the right of appeal to the Federal Highway Administrator, the Secretary of Labor, and/or the Court of Claims. Such appeals must be submitted through the Department who will make proper distribution.

If the violation indicated is a Code 3, 4, or 5, the Contractor must furnish to the Resident Engineer's Office, within 20 days, a Certified Supplemental Payroll showing the payment(s) made as restitution along with proof of pay. Proof of pay can be in the form of either a copy of the pay warrant, canceled check(s), an electronic statement of deposit to the employee's account, pay stub or an affidavit stating payment by the contractor with the affected employee's signature, as evidence that the restitution has been made. The date the Payroll Violation is received by the prime contractor is counted as day one (1) of the twenty (20) calendar day resolution period.

If the review of the certified supplemental payroll by the RCS substantiates that the cited violation has been corrected, the Contractor will be considered to be in compliance and no further action is required. Comments shall be entered into the Payroll Violations Module reflecting that corrections have been satisfied.

If a certified supplemental payroll is required and is not received within the (20) twenty days allotted, or is received and does not satisfy the infraction, then a Performance Deficiency Letter is issued to the contractor and withholding of the progress pay as outlined in **Section 5.4.10(1)** shall be exercised.

If the violation identified is a Code 6, the Contractor must furnish a certified supplemental payroll to the RCS, within 20 days and the disposition of the violation will be the same as specified above for Code 3, 4, and 5.

If the violation identified is a Code 7, the corrective action, documentation and time restraints afforded for corrective action shall be specified in the comments section on the **Notification of Payroll Violation**.

If the corrective documentation received substantiates that the error cited has been corrected and this documentation was made available for review in the allotted time frame, the Payroll Violations Module shall be updated to reflect this and no further action is required.

If the corrective action does not satisfy the violation cited, then withholding of the progress payment as outlined in **Section 5.4.10(1)** shall be exercised.

The DCCM shall insure that all wage violations are entered into the Payroll Violations Module found in the **Construction Automated Reporting System (CARS)**.

All information entered into the **Payroll Violation Module** shall be input by personnel selected and assigned by the Resident Engineer or their designee. A current listing of these people shall be maintained by the DCE's Office. Access to this program is granted by the State Construction Office Systems Support.

The DCCM shall provide instructions for entering data into the **Payroll Violation Module** to all personnel assigned this task.

Violation Types are explained on the **Notification of Payroll Violation, [Form No. 700-010-59](#)**.

5.4.9 Additional Notes on Violations

(A) Resident Level Responsibilities

- (1) Violations requesting certified supplemental payrolls under violation Codes 3 through 7 will be forwarded electronically as indicated:
 - (A) Original - Sent to the prime Contractor
 - (B) Retain a copy in the project file with a copy of the cited payroll attached.
 - (C) Forward a copy of the violation to the DCCM
 - (D) Forward a copy of violation to the subcontractor if the violation is issued to subcontractor

- (2) When a violation is discovered in reviewing a payroll it is essential that a **Notification of Payroll Violation, [Form No. 700-010-59](#)**, be issued in each instance (Code 1 through 7) in order that frequency of violations can be monitored. Violations are monitored by the State Construction Office (SCO) as follows:
 - (A) Wage violations are monitored through the Payroll Violations Module. Contractors with excessive violations are required to submit a written plan that demonstrates how they intend to eliminate their payroll violations and those of their subcontractors.

The Contractor's wage violations are then monitored by the SCO for one (1) year.

Labor regulation compliance should be outlined at the preconstruction conference. The requirements as related to submittal of payroll and weekly statements, as well as withholding of progress estimate until cited infractions have been satisfied, shall be emphasized.

5.4.10 Request for Additional Wage Classifications

(A) Resident Level Responsibilities

The ***Additional Classification Request*** shall be submitted by the prime Contractor when a work craft is required but not included in the ***Federal Wage Rate Determination(s)*** that are prescribed in the contract. The request shall be submitted in the Classification Request Manager (WRD); which is the system for managing additional classification request. This application allows request to be submitted through an Internet Subscriber Account by the Prime Contractor. The system creates Form No. 700-010-07 (Additional Classification Request Form) and forwards the populated form to the Wage and Hour Division of USDOL electronically. If an additional classification request is made, the Contractor may pay the employee at least the minimum amount requested on the request document until a response is received from the USDOL. The contractor will then be given 20 days from the date of notification from FDOT to make retroactive pay adjustments if needed for the conformed classification.

To submit an additional classification request, the prime contractor should follow the directions in the Classification Request Manager User Guide found on the Construction Website. The DCCM or their designee in each district will evaluate the request and the system will issue the contractor a copy of the decision whether it is rejected and returned to the contractor for amendment or validated and sent to the USDOL for conformance. A wage determination may contain two separate requirements for any individual classification, an "hourly rate" and a "fringe benefit" the sum of which is the prevailing wage for the classification. A contractor is required to pay overtime (time and a half) on the hourly rate but is only required to pay straight time on fringes. This needs to be calculated when doing reimbursements for retroactive pay.

5.4.11 Failure to Submit Required Records

(A) Resident Level Responsibilities

If the Contractor or subcontractor fails to submit the required records or does not make the records available to the afore mentioned agencies, these agencies may, after written notice to the Contractor, take such actions as may be necessary to cause the suspension

of any further payment, advance or guarantee of funds. Furthermore, failure to submit the required records upon request or to make the records available may be grounds for debarment action.

When a Contractor/subcontractor fails to comply with contract requirements for submittal of payrolls, any required information or forms, corrected payrolls, etc., and continues to ignore requests for compliance, the District is authorized to take the following action:

- (1) With the authorization of the DCE, and consultation with the DCCM, the Resident Engineer may withhold payment of the monthly progress estimate. The Resident Engineer may withhold the subcontractor's pro-rate share of the monthly progress estimate in the event a subcontractor fails to comply with contract requirements. Subsequent noncompliance on the part of the subcontractor may result in withholding the entire payment to the Contractor of the monthly progress estimate.
- (2) The Resident Engineer shall notify the Contractor in writing of the intent to withhold payment in advance of this action. The notification shall include the following:
 - (a) Specific reasons for withholding payment.
 - (b) Specific actions required by the Contractor/subcontractor to gain release of payment.
- (3) The Resident Engineer shall provide copies of this notification to the Director, Office of Construction and the District Contract Compliance Office.
- (4) The Resident Engineer's Office shall prepare the work sheet for the progress estimate to be withheld along with other estimates, and forward it to the District Office for processing.
- (5) After processing, the DCE shall hold the progress estimate until notified by the Resident Engineer that the Contractor/subcontractor is back in compliance.

5.4.12 Employee Interview Report – Labor Compliance

(A) Resident Level Responsibilities

The Contractor shall allow authorized representatives of the Department, FHWA, and/or the Department of Labor access to their employees on the project, and shall permit such representatives to interview employees on the job during working hours. The Department has an ***Employee Interview Report – Labor Compliance***, [Form No. 700-010-63](#), which

is to be completed by the Resident Engineer's Office per the instructions on the form.

Note: This form shall be kept in a separate confidential file and not with the rest of the project files.

The number of required Labor/EEO interviews shall be based on the dollar amount of the contract. The RCS will ensure that the required minimum number of interviews, are completed each month as shown in the following **Table 5.4.2:**

Table 5.4.2
Monthly Labor/EEO Interview Schedule

Original Contract Amount	Minimum Number of Interviews
Under \$ 1,000,000	2
Over \$1,000,000 - \$3,000,000	3
Over \$3,000,000 - \$5,000,000	4
Over \$5,000,000 - \$10,000,000	5
Over \$10,000,000 - \$15,000,000	6
Over \$15,000,000 - \$20,000,000	7
Over \$20,000,000 - *	*

* For original contract dollars greater than \$20 million, the minimum number of interviews will be determined on the vertical axis of the graph. The number of interviews for each range is depicted below the range. Any contracts over \$500 million, the Director of Construction will determine the number of interviews to be conducted.

Monthly Labor Interview Schedule Chart

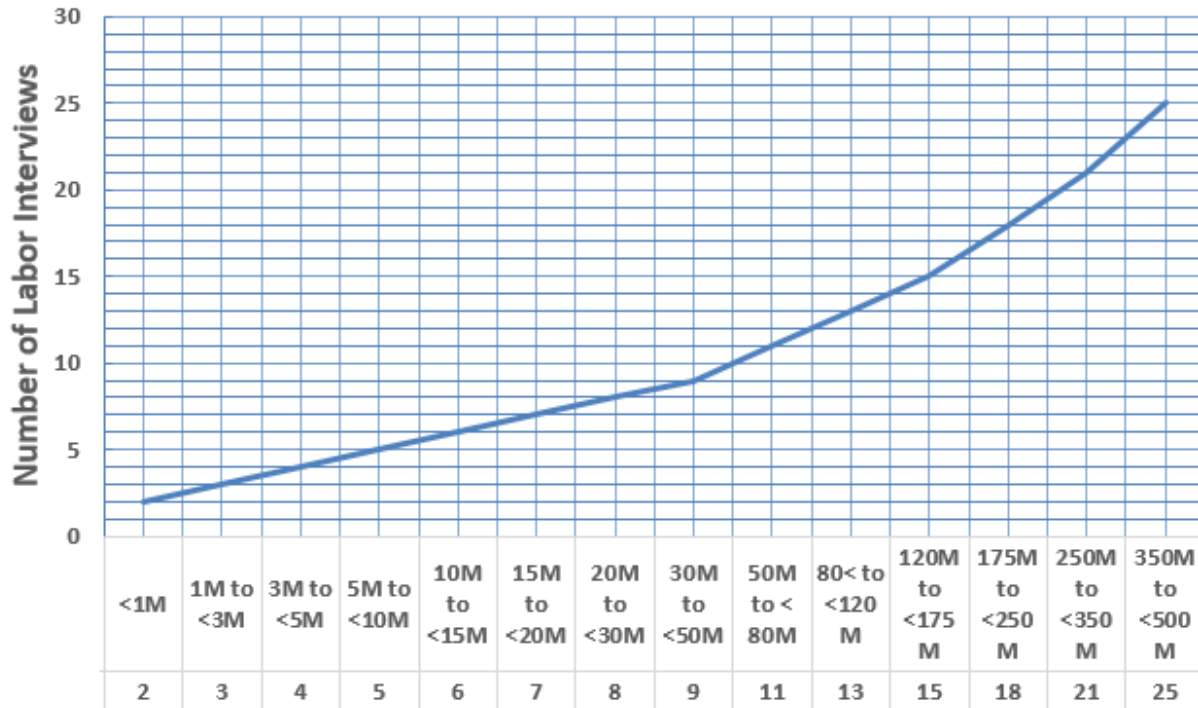

Contract Value (\$) Range/Number of Interviews for Range

- (1) When the interviewer has a reasonable basis to believe the Contractor and/or subcontractor may not be in compliance with the provisions of the **Davis-Bacon Act**, a copy of the employee's paycheck shall be secured and the pay rate checked against certified payroll.
- (2) The date and action(s) taken to resolve any discrepancies or violations, determined as a result of the interview, shall be indicated in the space provided on the report. The employee being interviewed must sign the report.
- (3) A cross section of employees shall be interviewed if possible. Examples of this would be minorities, non-minorities, skilled, unskilled, trainees and foremen.

5.4.13 Retention of Payroll Records

(A) Resident Level Responsibilities

Both FDOT and the Contractor have retention responsibilities for payroll records. Payrolls

and basic records, relating to payrolls shall be maintained by the prime contractor, during the course of the work, and preserved for a period of three (3) years from the date of completion of the project. These records are required to be available for inspection, copying, or transcription, by FDOT, FHWA, USDOL, or authorized representatives. These provisions are governed under **29 CFR part 5.5** and **FHWA 1273, section IV**.

Payrolls submitted by the Contractor to the Department and associated payroll records shall be maintained by the Department's representative during the duration of the contract. After final payment to the Contractor is made, the payroll records if they have not already been entered into the Electronic Data Management System (EDMS) will be entered and will remain there until all state and federal retention requirements have been met. . Any other records that must be boxed and submitted to FDOT Central Office Records Center will follow provisions governed under FDOT procedure, **Records Management Topic No. 050-020-025**.

5.4.14 Wage Surveys

(A) Resident Level Responsibilities

Wage surveys will be conducted when the US Department of Labor (USDOL) initiates them and commits to publishing new wage determinations from the surveys. USDOL will outline the time for which survey data will be collected, which is usually for a year's time period. The Prevailing Wage Rate Coordinator, along with the District Compliance personnel, will encourage Contractor participation by means of announcements and workshops in the districts and communication through the Contractor's associations. The points will be stressed that (1) the results of the survey's accuracy are determined by the amount of participation (poor participation creates erratic rates in the wage determinations) (2) once the survey is done, rates will be in effect for at least the next three years and (3) if voluntary participation is not successful the Department will have no choice but to return to a contract requirement method of collecting data. USDOL will provide the forms and assemble the data when collected. An instruction booklet will be created and distributed to help guide Contractors and Department personnel through the survey process.

**GUIDANCE DOCUMENT 5-4-A
(SAMPLE LETTER)**

Date

EMAIL
RETURN RECEIPT REQUESTED

RE: Financial Project ID: _____
FAP No.: _____
County: _____

Dear Mr./Ms. _____

Enclosed is a copy of Form No. 700-010-59 listing the payroll violation(s) of Section IV of the "Required Contract Provisions - Federal Aid Construction Contracts" (FHWA-1273) which is included in the contract for the above referenced project. The payroll violations involved were disclosed by examination of the payroll listing(s) for the payroll period ending _____.

A total of \$ _____ in additional wage is due, in accordance with Section IV of the aforementioned contract provisions, liquidated damages can be assessed if this noncompliance is not resolved by the close of business on _____. If liquidated damages are assessed, the appropriate amount will be withheld by the Department of Transportation and deducted from the payment due on the next Progress Estimate.

Please forward directly to this office, email a Certified Supplemental Payrolls and canceled payroll checks or some other proof or evidence that restitution has been made to the employee indicating that corrective action has been taken in regard to this citation.

In addition to the above, we ask that you furnish this office with an explanation of the facts surrounding this underpayment. This information will be utilized in preparing a recommendation as to whether the liquidated damages should be retained or remitted.

We urge you to re-examine your payroll procedures and take appropriate action to prevent recurrence of similar violations.

Sincerely,

Resident Engineer

cc: District Final Estimates Office
District Compliance Office
District Construction Engineer

GUIDANCE DOCUMENT 5-4-B

(SAMPLE LETTER)

Date

District Final Estimates Office

Attention: _____

RE: Financial Project ID: _____
FAP No.: _____
County: _____

Dear Mr./Ms. _____:

You received a copy of our letter, dated _____ to the Contractor for the above referenced project, whereby the Contractor was notified of a violation of Section IV of the "Required Contract Provisions - Federal Aid Construction Contracts" (FHWA -1273).

As a result of this violation, \$_____ in additional wages due and \$ _____ in assessed liquidated damages were withheld from payment due on the progress estimate.

In response to our notification, the Contractor submitted certified supplemental payrolls indicating that corrective action has been taken in regard to the violations. The Contractor also explained the circumstances surrounding the violations.

The District Construction Office has reviewed the supplemental payrolls and is of the opinion that the affected employees have been properly compensated. Therefore, by copy of this letter, we are requesting that you release the \$ _____ being withheld as unpaid wages.

The District Construction Office is also of the opinion that the violations were caused inadvertently. We therefore recommend that the \$ _____ being withheld as liquidated damages be released.

Sincerely,

Resident Engineer

cc:
District Compliance Office
District Construction Engineer

GUIDANCE DOCUMENT 5-4-C

(Examples of Code Violations)

Code 1

A code 1 violation is issued when the contractor paid the employee straight time for all time worked on the project. This would include all hours over 40 where the employee should have been paid time and one-half.

- For example: If an employee's base rate of pay is \$15/hour and he/she worked 50 hours, and the contractor paid them \$15/hour for the entire 50 hours, when payment should have been made at 40 hours @ \$15/hour and 10 hours @ \$22.50/hour for a total of \$825.

Code 3

A code 3 violation is issued when the contractor paid the employee under a classification which the employee did not work or paid him under a classification even when he worked under a different higher classification all or part of the time. If the contractor chooses to carry the employee in the highest classification that he/she works, for the entire pay period then that is OK, but if an employee works in a higher classification than what he is listed, then a payroll violation has occurred, regardless of whether the employee is paid enough to cover that classification or not.

Code 4

A code 4 violation is issued when the contractor is paying an employee less than the approved rate on the wage classification for the type of work the employee is doing. It could also result from using the wrong general wage decision. If the wrong numbers were inadvertently applied to the contract from a wrong general wage decision then wages would be off for certain classifications if not all.

Code 5

A code 5 violation is issued when mathematical errors on the certified payroll indicate that the payment made to an employee violated federal labor laws and/or contract provisions. This could be a simple mathematical error, applied by human input and resulted in the wage of an employee not being calculated properly. An example would be if the employee was inadvertently paid for 4 hours instead of 14 hours in a certain classification.

Code 6

A code 6 violation is issued when deductions made to an employee's paycheck were not previously approved, either by the USDOL if that applies or by the employee for deductions that are more personal in nature.

Code 7

An employee that was interviewed on the job does not show up on payroll for the date that he/she was interviewed. (A discrepancy has occurred with the Employee interview and the Payroll). Any violation that is not listed above.

Section 5.5

EQUIPMENT RENTAL

5.5.1 Purpose

This chapter is to be used for receiving and verifying the information on the ***Notice of Rental Agreement, Form No. 700-010-11.***

5.5.2 Authority

Section 334.048(3), 20.23(3)(a), Florida Statutes (F.S.)

5.5.3 References

Section 8-2, Standard Specifications for Road and Bridge Construction

5.5.4 Notice of Rental Agreement

Resident Level Responsibilities

When the Contractor proposes to accomplish any work on the project using rental equipment, he shall notify the Project Engineer in writing in accordance with **Section 8-2** of the ***Standard Specifications***. The exception to this requirement is when the Contractor rents a piece of equipment (without operators) from an equipment dealer or from a firm whose principal business is renting or leasing equipment. Under those circumstances, the notice provisions herein set forth need not be followed.

The Contractor may rent the equipment with or without an operator. When equipment is rented with an operator, it must be the type of equipment that substantially requires the constant attention of a trained operator. Renting of a crew, including non-operator personnel, is not permitted, with the exception of when a crew is required specifically for maintenance and operation of the equipment, and is in no way associated with the work being performed.

5.5.4.1 Notice of Rental Agreement Form

Resident Level Responsibilities

The Contractor may notify the Project Engineer using **Notice of Rental Agreement, Form No. 700-010-11**, or similar format as long as it contains all of the required information. The notice must contain a listing and description of the equipment, a description of the work to be performed with the equipment, an indication of whether the rental includes an operator, project information, the name of the prime Contractor and the name of the company from which the equipment is being rented.

5.5.4.2 Equipment Rented With An Operator

Resident Level Responsibilities

If the rental is to include an operator, the operator's wages become subject to all wage rate requirements applicable to the project.

- (A) When equipment is rented on a "with operator" basis, the Project Engineer shall request that the Contractor submit certified copies of the lessor's weekly payrolls listing the operator, on Federal Aid projects.
- (B) When rental of equipment on a "with operator" basis exceeds \$10,000, the lessor will be subject to all the AA/EEO provisions contained in the original contract.

5.5.4.3 Equipment Rented Without An Operator

Resident Level Responsibilities

When the rental of equipment does not include an operator, the operator will be shown on the Contractor's payroll. All operators are subject to applicable wage rate provisions included in the contract.

5.5.4.4 Delinquent, Debarred and/or Disqualified Contractors

Resident Level Responsibilities

If a Contractor is declared delinquent or becomes disqualified by the Department as per **Section 8-8** of the **Standard Specifications**, said delinquent and/or disqualified Contractor may supply or rent equipment without an operator on Department contracts.

If a Contractor had been found to be Non-Responsible as per **Chapter 14.22.0141** of the **Florida Administrative Code**, then they cannot supply or rent equipment on Department contracts.

A Contractor who has been debarred by the federal government cannot act as a Contractor or supplier of materials or rental equipment for Department contracts.

5.5.4.5 Delivery of Purchased Material

Resident Level Responsibilities

If a Contractor elects to purchase material and the price includes the delivery cost, **Notice of Rental Agreement, Form No. 700-010-11**, is not required. The project personnel should check the delivery ticket to insure that the hauler has been retained by the vendor.

5.5.4.6 Subcontractor or Supplier of Rental Equipment

Resident Level Responsibilities

A **Notice of Rental Agreement, Form No. 700-010-11**, should not be used as a substitute for a subcontractor agreement. When a task, or work item requires a supervised crew, (i.e., a crew with a supervisor, foreman, lead man or other work directing personnel) then a **Notice of Rental Agreement** does not apply. A **Certification of Sublet Work, Form No. 700-010-36**, is required

An equipment rental agreement is not required when MOT items are leased from a company whose principal business is renting or leasing MOT items. When MOT items are initially installed, maintained, moved, and retrieved by an independent company, then a **Certification of Sublet Work** is needed. If MOT items are initially delivered, maintained and retrieved by an independent company but placed and relocated by the prime Contractor's personnel then a **Certification of Sublet Work** is not required.

5.5.5 Verification of the Agreement

Resident Level Responsibilities

The Project Engineer is responsible for verifying the information contained on the **Notice of Rental Agreement, Form No. 700-010-11**. Both the physical equipment and the equipment operator shall be verified on a periodic basis.

5.5.5.1 Equipment and Operator Verification

Resident Level Responsibilities

The Project Engineer is responsible for seeing that the information contained in the "equipment and personnel" section of the ***Daily Report of Construction, Form No. 700-010-13***, is accurate and complete. By comparing the information contained on ***Daily Report of Construction*** and ***Notice of Rental Agreement, Form No. 700-010-11***, the type, location and status of the rental equipment and hours, wages and status of the equipment operator can be verified.

5.5.5.2 EEO Requirements

Requirements for EEO are contained in the latest version of ***Equal Opportunity Construction Contract Compliance, Procedure No. 275-020-005***.

5.5.5.3 Distribution of the Notice

Resident Level Responsibilities

When the ***Project/Resident Engineer receives the Notice of Rental Agreement, Form No. 700-010-11***, from the Contractor and is satisfied that it meets all the requirements, the document should be uploaded into the Department's approved Electronic Document Management System and notification sent to the District Compliance Officer or Resident Compliance Specialist.

Section 5.6

UTILITY WORK

5.6.1 Purpose

To provide a uniform standard for monitoring, documenting and managing the installation and/or adjustment of utilities within the Department's construction projects. Utilities are all active, deactivated, or out-of-service electric power lines, telephone lines, telegraph lines, other communication services lines, pole lines, ditches, sewers, water mains, heat mains, gas mains, pipelines, wireless facilities, gasoline tanks, pumps, and drainage pipes or structures that do not discharge storm water onto the FDOT R/W or into an FDOT storm water system which are owned by the Utility Agency/Owner (UAO). The term utility does not apply to property of the Department, or any drainage pipes or structures that discharge storm water onto the FDOT R/W or into an FDOT storm water system. Utilities are sometimes owned by utility agencies regulated by the Public Service Commission, but a utility can also be owned by a citizen, business, or government not regulated by the Public Service Commission.

5.6.2 Authority

Sections [20.23\(3\)\(a\)](#), [334.048\(3\)](#), and [337.401](#) through [337.404](#) Florida Statutes (F.S.)

5.6.3 References

References to sections within this manual start with "**CPAM Section**". References to other documents are highlighted in bold italic text. When any section is referenced, it is intended that all subsections and all other references contained within the referenced section and subsections are also included.

5.6.4 General

This procedure is designed to optimize the Department's ability to control utility work and/or recover losses from the UAOs.

(A) Resident Level Responsibilities

The Project Administrator is responsible for monitoring and documenting Contractor and UAO activities.

(B) District Level Responsibilities

Utilities occupy the Department's right of way in several ways and the Department's ability to exercise its authority over any UAO owning a utility in the Department's right of way can be a complicated and time-consuming process. Consequently, when utility work needs to be performed during a construction project, the District Utilities Office is required to execute utility agreements to ensure the UAO's work is scheduled, or the UAO's work is included in the construction contract for the Contractor to complete.

Pursuant to **Section 337.403 F.S.** the Department may be obligated to reimburse the UAO for all or part of its utility work. This determination is made by the District Utilities Office with consultation with the Office of General Counsel. In reimbursable cases, an estimate, fund approval, and reimbursement agreement are also needed. Once all agreements are executed, the District Utilities Office certifies all necessary utility agreements have been executed to ensure the construction project can be constructed in accordance with the construction plans as they existed at the time of execution. This certification is done prior to advertisement and the documents executed for these purposes are the **Utility Work Schedule (Form 710-010-05)**, **Utility Work by Highway Contractor Agreements (Forms 710-010-21 and 22)**, **Utility Master Agreement (Form 710-010-20)** with appropriate task work orders, and construction project specific utility agreements.

Utility Work Schedules (Form 710-010-05) are issued by the District Utilities Office for certification and are legal orders to the UAO. The UAO is obligated to operate in accordance with the **Utility Work Schedule (Form 710-010-05)**, **Utility Permit (Form 710-010-85)**, and other utility agreements as executed.

5.6.4.1 Utilities on Design-Build Projects

The Design-Build firm's Utility Coordinator is responsible for coordination with the UAOs where the construction operations impacts utilities. The Design-Build firm's Utility Coordinator also coordinates the execution of all necessary utility relocation agreements and schedules for needed utility work.

The Project Administrator monitors utility work on Design-Build projects to ensure utility agreements are executed and Department approved utility permits are obtained. The Project Administrator maintains regular communication with the Design-Build firm's Utility Coordinator throughout the life of the project. If utility conflicts arise during construction that cannot be resolved at the project level between the Design-Build firm and the impacted UAO, the Project Administrator should follow the issue escalation process outlined in the contract and contact the District Utility Office for assistance.

5.6.5 Preconstruction Conference

The Project Administrator will schedule and conduct a preconstruction conference that includes UAOs as described in **CPAM Section 3.1** where the Department, Contractor, and UAOs will discuss scheduling and methods to accomplish the construction project in an expeditious manner. All UAOs within the limits of construction, including UAOs with executed utility work schedules, will be invited.

5.6.6 Project Level Quality Assurance

The Project Administrator and (if applicable) the Design-Build firm's Utility Coordinator are responsible for ensuring that adequate documentation is included in the project file to confirm Utility Final Acceptance of a project. The following documentation must be included, if applicable, in the file for verification by the District Utilities Office:

- a) Red, Green, Browns
- b) Conflict Matrix and No-Conflict Letters
- c) Determination of Reimbursement
- d) NTPs
- e) Utility Agreements
- f) Utility Easements
- g) Utility Work by Highway Contractor Agreements
- h) Utility Work Schedules
- i) Utility Work Estimates
- j) Certification and Closeout Letters
- k) Permits and As-built Plans
Record the permit numbers for the project and the As-built drawings stored in OSP. For reimbursable projects, provide a screenshot of the permit(s) in OSP. For non-reimbursable projects, provide the utility permit numbers associated with the project (Word, PDF, OneNote).
- l) Notice of Utility Construction Work (Form #700-010-48)
- m) Daily Work Reports

5.6.7 Utility Work by the UAO

Utility work by the UAO within the limits of a construction project requires both an executed utility work schedule and a **Utility Permit** issued by the Department unless otherwise approved by the General Counsel's Office.

The Project Administrator and/or Construction Utility Coordinator is responsible for monitoring and documenting the UAO activities. In the **Daily Work Report**, under the remarks category for utilities in AASHTOware Project Construction (PrC), document the UAO's work within the construction project limits, and the Contractor's work within areas where there is scheduled utility work. The Project Administrator is to document where the work took place, what work was being accomplished, who was doing the work, any impacts or delays to either party, and if the work was done in accordance with the construction project schedule, utility work schedule, and **Utility Permit**. For utility conflicts

and damage, the Project Administrator is to complete the **Utility Conflict and Damage Report (Form 700-010-12)**. When requested by the District Utilities Office, the Project Administrator will verify completion of the utility work for partial and final reimbursement to the UAO.

5.6.8 Revised Utility Work Schedules Executed During Construction

Occasionally the Department makes a change that impacts the utility work and it cannot be accomplished in accordance with the executed **Utility Work Schedule**, therefore the **Utility Work Schedule** must be revised. When utility work is unforeseen, a new **Utility Work Schedule** must be executed. To expedite project construction, the Project Administrator may execute the **Utility Work Schedule** for the District Utilities Office, when all the following conditions exist:

- a) the UAO is not reimbursable,
- b) the UAO has no property rights, and
- c) the UAO is responsive and cooperative.

The District Utilities Office can confirm conditions a) and b) above. If the unforeseen utility work would normally require a permit, the UAO will submit a completed permit application, also known as an “after-the-fact” permit, and as-built plans within five (5) business days after the repairs are completed as required by **UAM Section 2.2**. The Project Administrator will request the UAO to provide the “after-the-fact” **Utility Permit** number obtained by the UAO for inclusion in the **Daily Work Report**.

The Project Administrator is responsible for monitoring and documenting impacts to the Contractor’s activities or other UAOs in the **Daily Work Report**. **Daily Work Reports** may be used to verify Contractor delay claims due to the work.

If the above conditions do not exist, the Project Administrator must immediately contact the District Utilities Office to execute a new **Utility Work Schedule** or other necessary utility agreements, notices, or orders.

Occasionally the UAO requests a change to the utility work that cannot be accomplished in accordance with the executed **Utility Work Schedule**. This will only be permissible if the revised **Utility Work Schedule** does not adversely impact the construction project.

5.6.9 Utility Work by Highway Contractor Agreements

The Department and UAO may agree to include the UAO’s utility work in the Department construction contract. The work is treated the same as any other work in the contract with the exception that the UAO is performing the inspection, testing, and monitoring of the

Contractor's work in accordance with the executed **Utility Work by Highway Contractor Agreement**. The Project Administrator is responsible for documenting any inspection concerns the UAO has in the **Daily Work Report**.

The Department will pay the Contractor for the utility work included in the contract using either Phase 52 or Phase 56 funds. See **CPAM Section 8.12** for more information.

5.6.10 Emergency Utility Work by the UAO

During the construction project, emergency utility work may arise for a variety of reasons. Pursuant to **UAM Section 3.1**, the UAO is obligated to respond to emergencies and the Contractor must allow this work to be done; and pursuant to **UAM Section 2.2**, advance permit application approvals or notifications are not required for emergency utility work. If the type of work would normally require a permit, the UAO will submit a completed permit application, also known as an "after-the-fact" permit, and as-built plans within five (5) business days after the repairs are completed as required by **UAM Section 2.2**. The Project Administrator will request the UAO to provide the "after-the-fact" **Utility Permit** number obtained by the UAO for inclusion in the **Daily Work Report**.

The Project Administrator is responsible for monitoring and documenting the UAO's emergency activities to determine impacts to the Contractor's activities or other UAOs in the **Daily Work Report**. **Daily Work Reports** may be used to verify Contractor delay claims due to the emergency work.

5.6.11 Utility Work on Existing Facilities by the UAO

The UAO may perform work on their existing permitted facilities in compliance with **UAM Section 2.3**. Since the UAO is operating under their previous permit, they do not need to obtain a new **Utility Permit** for these activities, but a utility work schedule is required. If the work will not interfere with the construction project, the Project Administrator may execute a utility work schedule as described in **CPAM Section 5.6.7**. If a utility work schedule is not executed, the UAO must perform the work after the construction project is completed.

5.6.12 Utility Permit Applications without Utility Work Schedules

Pursuant to **UAM Section 2.1(10)**, the UAO cannot work in the construction project limits without a utility work schedule. Consequently, the UAO is responsible for submitting a utility work schedule with their **Utility Permit** application in compliance with **Utilities Procedures Manual (UPM) Section 5.13.2**. The Project Administrator and/or Construction Utility Coordinator will determine if the proposed utility work can be accommodated during the construction project. If the proposed utility work can be accommodated, the Project Administrator will sign the utility work schedule for the District

Utilities Office and forward the signed utility work schedule back to the LPO. The EOR's approval is not required on the utility work schedule for the proposed utility work. If the utility work cannot be accommodated, the Project Administrator will notify the LPO that the proposed utility work cannot be accommodated during construction.

5.6.13 UAOs without Approved Utility Permits

If the Project Administrator discovers a UAO working within the construction project installing a new facility without an approved **Utility Permit** and **Utility Work Schedule**, and is not working on existing facilities as allowed by **UAM Section 2.3**, the Project Administrator will direct the UAO to stop work until they obtain a **Utility Permit** and **Utility Work Schedule** from the Local Permitting Office (LPO).

5.6.14 UAO Non-Compliance with Utility Work Schedules

If the UAO does not comply with the utility work schedule, the Project Administrator must coordinate with the District Utility Administrator and immediately notify the UAO of its non-compliance. This notification may be verbal, but must be immediately followed by written notification from the Resident Engineer, copying the Contractor, Project Administrator, and District Utility Administrator. The notification of non-compliance letter should include the following:

- a) The utility work schedule, **Utility Permit**, or other agreements that control the UAO's activities,
- b) The contractor's activities that are or may be impacted,
- c) The corrective actions needed.
- d) A time frame for the corrective action.
- e) A statement that the UAO may be liable for any added costs to the Department.

The Project Administrator must record the date the UAO received the verbal and written notification and monitor and document impacts to the Contractor's activities or other UAOs in the **Daily Work Reports**. This documentation will be used to seek recovery of construction delay costs and/or other related costs.

After the notice of non-compliance is given, the Project Administrator must determine if the utility work can be performed by the contractor. If the utility work can be performed by the contractor, the Project Administrator will request the District Utilities Office to issue a notice to the UAO stating the contractor will perform the utility work pursuant to **337.404 F.S.** If the utility work cannot be performed by the contractor, the Project Administrator will consult with the District Construction Engineer, General Counsel's Office, and the District Utilities Office about pursuing legal action to expedite the project.

5.6.15 Contributions-in-Aid-of-Construction

The contractor is responsible for establishing power service assemblies for signals, lighting, ITS, and other roadway applications. The cost for obtaining utility service drops to these assemblies are paid through contract pay items. When the contractor requests utility service where the UAO extends its utility lines or otherwise upgrades its utilities, the UAO may request a Contribution-in- Aid-of-Construction (CIAC) to be paid by the highway contractor. The CIAC costs are paid with the non-bid item for these costs.

If the CIAC was not anticipated, but the UAO is entitled to these costs, the CIAC costs will be paid to the contractor by Work Order or Supplemental Agreement. Do not use utility master agreements or relocation agreements to pay CIAC costs.

Since the Contractor is required to coordinate this work, a utility work schedule is not required. Service drops or other service connections are utility appurtenances to the existing utility line and do not need a **Utility Permit**. However, if the UAO extends its utility lines within the R/W, a **Utility Permit** is required. The Project Administrator will verify that the UAO has obtained a **Utility Permit** or direct the UAO to obtain a **Utility Permit** from the Local Permitting Office.

Section 5.7

FEDERAL-AID PROJECT REQUIREMENTS

5.7.1 Purpose

The purpose of this section is to provide a uniform process for compliance with Federal-Aid project requirements.

5.7.2 Authority

Sections 20.23(3)(a) and 334.048(3), Florida Statutes

5.7.3 Reference

Part 2, Section 184, Code of Federal Regulations (CFR); Part 2, Section 200.322, CFR; Part 23, Section 635, CFR, and Section 6, Standard Specifications for Road and Bridge Construction

5.7.4 Correspondence

On Federal-Aid Projects, all correspondence shall include the Federal-Aid Project Number, as well as the Financial Project Identification Number. All other appropriate project reference information shall be included in the subject heading, and the designation of FHWA Project of Division Involvement (PODI) shall be shown.

5.7.6 Federal-Aid Participating/Non-Participating

Certain work included in a Federal-Aid Project may be designated as Federal-Aid Participating or Federal-Aid Non-participating during the design phase, the Plans Specifications & Estimates Review phase, or when contract modifications are necessary during construction. The designer will document the appropriate breakdown in the plans. Examples of such work can be found in Section 7.3.10 of this Manual.

All project financial documents, such as **Supplemental Agreements**, **Monthly Progress Estimates**, monthly billing to the FHWA, **Final Estimates** and final billing to FHWA should accurately reflect all costs which have been determined to be Federal-Aid Participating and Federal-Aid Non-participating. In accordance with this requirement, plan preparation procedures and the integrated contract system have been modified to allow designation of those pay items which are Federal-Aid Non-participating and to split pay quantities for those items with partial Federal-Aid Participation.

The Project Administrator shall properly separate Federal-Aid Non-participating items and/or quantities from Federal-Aid Participating items and/or quantities when preparing a **Supplemental Agreement**, **Unilateral Payment**, or **Work Order**. Guidelines for determining Federal-Aid Participation of cost and time increases or decreases are contained in **Section 7.3.10** of this **Manual**.

On FHWA PODI projects, it is essential that the Resident Engineer on In-house Construction Engineering and Inspection administered projects and the Consultant Project Manager on Consultant Construction Engineering and Inspection administered projects make every effort to obtain from the FHWA Transportation Engineer a determination as to Federal-Aid Participating or Federal-Aid Non-participating for contract modifications, in accordance with **Section 7.3.10.2** of this **Manual**. On FHWA Delegated projects, the determination as to Federal-Aid Participating or Federal-Aid Non-participating shall be obtained from the District Construction Engineer in accordance with **Section 7.3.10.3** of this **Manual**.

5.7.7 Revised Plan Sheets

Resident Level Responsibilities

The Project Administrator shall furnish to the FHWA a copy, for written approval, of all plan revisions initiated during construction on Federal-Aid PODI projects. For major plan revisions, FHWA approval shall be obtained prior to issuing the **Notice to Proceed** to the contractor for work associated with the proposed plan revision. Copies of all revised plan sheets will be furnished to the FHWA along with a copy of the executed **Supplemental Agreement, Form No. 700-010-45**, **Unilateral Payment, Form No. 700-010-05** or **Work Order, Form No. 700-010-80** used for the purpose of incorporating the revised plan sheets into the contract.

5.7.8 Construction Zone Accident Reports

Engineer's Maintenance of Traffic Evaluation at Crash Site, Form No. 700-010-64, will be completed by the Project Administrator for each accident occurring within the limits of the Federal-Aid Project. Refer to the **Maintenance of Traffic** chapter of this **Manual** for further instructions.

5.7.9 Source of Supply

Specifications Section 6-5.2 requires the Contractor to use domestically sourced structural steel, iron and construction materials. These requirements pertain to non-ferrous metals, plastic and polymer-based products, glass, lumber, drywall articles, materials and supplies that are consumed in, incorporated into, or affixed to an infrastructure project. Temporary devices, equipment, and other items removed at or before the completion of the project are exempt. Temporary items determined to be left in place are not exempt and must be domestically sourced. Aggregates, cementitious materials, and aggregate binding agents or additives are also exempt..

For iron and steel, miscellaneous components including subcomponents and hardware necessary to encase, assemble, and construct the finished work are included. The **Specifications** require a **Certification of Compliance** from the manufacturer that states the steel or iron, and the products containing steel or iron were manufactured in the United States. Ensure the certification includes the Federal Aid Project Number, the Financial Project Number, and the applicable Pay Item Number(s). Certifications attesting to this must be submitted to the PA prior to incorporating the material into the project. PA will enter the certification into the Electronic Document Management System (EDMS). Non-domestically source materials must be tracked in the Foreign Steel Tracking agency view within AASHTOware Project Construction (PrC). For assistance with the PrC agency view, contact the co-systemssection@dot.state.fl.us

In accordance with Federal requirements (2 CFR 184, 2 CFR 200.322 and 23 CFR 635.410) and Department policy, all foreign steel or iron that is permanently incorporated into any FDOT project that will utilize Federal Funding in any phase of the project is required to be tracked in AASHTOware Project Construction (PrC) with the **Buy America Tracking Report**. Please contact the CO-SCO-SystemSection@dot.state.fl.us for assistance with Buy America Tracking.

5.7.9.1 Product Certification

Resident Level Responsibilities

Certification per product, per project will be required as shown in the **Section 5, Materials Manual, Topic No. 675-000-000**. The Project Administrator shall be responsible for obtaining the certification prior to permitting the incorporation of any products into the project.

5.7.9.2 Change of Source

Resident Level Responsibilities

If there is any indication or reason to believe that the producer may have switched sources of steel or iron during the life of the project, the Project Administrator will require an updated **Certification of Compliance** from the producer.

5.7.10 Retention of Salvageable Materials or Equipment Produced from a Federal-Aid Project and Retained by the Department

Consistent with **Office of Management and Budget (OMB) "Super Circular" 2 CFR Part 200**, the Florida Department of Transportation shall not require a credit or reimbursement to the project for the value of any salvageable materials or equipment removed from the project per the contract documents resulting from a Federal Aid project. Exempt from this requirement is all railroad work performed pursuant to **49 CFR 266 and 23 CFR 140**. If, on railroad projects, recovery, or reimbursement to the project of salvageable materials provides a net benefit, then the Department shall pursue. If there is no net benefit, the railroad will dispose of the material."

5.7.11 FHWA Final Inspection

Final inspection of a FHWA PODI project shall, whenever possible, include the FHWA Transportation Engineer for inspection conducted at the Department's semifinal inspection. It is imperative that sufficient notice of the date, time, etc., be given for this inspection to accommodate scheduling. By following this procedure, a determination can be made as to what corrective action or additional work is required by FHWA to be accomplished as a condition of accepting the project prior to the Department's acceptance from the Contractor. Refer to the **Project Closeout** chapters of this **Manual** for instructions on project acceptance.

5.7.12 Notice to FHWA prior to payment of Incentive, No Excuse Bonus, Lane Rental or Liquidated Savings Monies

On FHWA PODI projects containing Incentive/Disincentive, No Excuse Bonus, Lane Rental or Liquidated Savings Special Provisions, FHWA approval must be obtained prior to issuing payments to the contractor for any portion of or the full Incentive, No Excuse Bonus, Lane Rental or Liquidated Savings amount.

Section 5.8 CONTROL OF MATERIALS

5.8.1 Purpose

To establish a uniform standard for the control of materials on construction projects.

5.8.2 Authority

Sections 20.23(3)(a) and 334.048(3), [Florida Statutes](#)

5.8.3 References

[Standard Specifications for Road and Bridge Construction](#)

[Federal-Aid Policy Guide, 23 Code of Federal Regulations \(CFR\) 637](#)

[Procedure No. 675-000-000, Materials Manual](#)

5.8.4 General

The **Contract Documents** contain **Specifications** and guidance relevant to the acceptance of all materials incorporated into a project. The Job Guide Schedule (JGS), included in the Materials Acceptance and Certification system (MAC), indicates who samples and tests each of these materials and at what frequency. The Final Project Materials Certification Letter (PMCL) for materials used on a contract will be accomplished according to instructions from the State Materials Office (SMO) **Materials Manual Section 5.4, Final Project Material Certification**.

The **JGS** lists materials and designates the methods of acceptance normally required under each material. For all contract types, the **JGS** includes project specific MAC Specifications created for **Special Provisions, Technical Special Provisions, Developmental Specifications, Plan Notes** and **Change Orders** with requirements for material method of acceptance. The JGS is generated for contracts with conventional pay items from MAC based on the pay items on the contract and project specific assignments. For Lump Sum and Design-Build contracts, the Contractor will create a project specific JGS in MAC, in accordance with **Specifications Section 105**, known as a nonstandard JGS.

(A) Resident Level Responsibilities

The Project Administrator (PA) is responsible for reviewing the **Contract Documents** to ensure the JGS is correct and complete. If there are missing material assignments, the PA must contact the SMO technical unit to ensure the JGS is complete. Project specific materials are included in the **Special Provisions, Technical Special Provisions, Developmental Specifications, Plan Notes** and **Change Orders** that designate a method of acceptance. If any exist, the PA is responsible to ensure that the JGS includes these entries.

5.8.5 Source of Supply

Specifications Section 6-5.2 requires the Contractor to use domestically sourced structural steel, iron, and construction materials. These requirements pertain to non-ferrous metals, plastic and polymer-based products, glass, lumber, and drywall articles, materials, and supplies that are consumed in, incorporated into, or affixed to an infrastructure project. Temporary devices, equipment, and other items removed at or before the completion of the project are exempt. Temporary items determined to be left in place are not exempt and must be domestically sourced. Aggregates, cementitious materials, and aggregate binding agents or additives are also exempt.

For iron and steel, miscellaneous components including subcomponents and hardware necessary to encase, assemble, and construct the finished work are included. The **Specifications** require a **Certification of Compliance** from the manufacturer that states the steel or iron, and the products containing steel or iron were manufactured in the United States. Ensure the certification includes the Federal Aid Project Number, the Financial Project Number, and the applicable Pay Item Number(s). Certifications attesting to this must be submitted to the PA prior to incorporating the material into the project. PA will enter the certification into the Electronic Document Management System (EDMS). Non-domestically source materials must be tracked in the Foreign Steel Tracking agency view within AASHTOware Project Construction (PrC). For assistance with the PrC agency view, contact the [State Construction Office Systems Section](#).

5.8.6 Method of Acceptance

There are three methods of material acceptance: 1) certification; 2) visual inspection; and 3) sampling and testing.

(1) Certification

A contractor, manufacturer, or supplier provides a written certification stating the material supplied meets **Specifications** requirements at the time of delivery or prior to placement. The CEI Inspector shall verify that the certification is complete, correct, and meets **Specifications** requirements. The CEI Inspector shall visually inspect or verify that these products or materials meet all the **Specifications** and any other contract requirements, and that the delivered products or materials match the certification document descriptions in expected appearance and size, and are free from defects and contamination.

Product certification from an approved aggregate source should include the bill of lading/shipping ticket with the phrase “Certified for FDOT” or “Cert. for FDOT”, FDOT Source number, date, FDOT material code, aggregate description, and quantity in tons.

In some instances, the Department requires that manufacturers submit samples of certified materials for independent verification purposes. The CEI Inspector shall collect the sample or verify that the sample has been submitted for testing.

(a) Product Certification

Certification per product, per project is required in the **Specifications** and as shown in **Section 5, Materials Manual, Topic No. 675-000-000**. The PA shall be responsible for obtaining the certification prior to allowing the incorporation of any products into the project.

(b) Approved Products and Producers

The Department maintains a list of products and producers acceptable for use on construction projects. Products and producers will be included on Department lists when documentation (certification and periodic test results) is received assuring the material conforms to **Specifications** requirements. The CEI Inspector shall verify that such approved products and producers meet **Specifications** requirements. These lists are available at: [Approved Product List](#) and [Production Facility Listing](#).

(2) Visual Examination

The **Specifications** provide guidelines concerning material that may be accepted by visual examination, for example certain materials incorporated into Witness-and-Hold projects. Visual Inspection may also be an alternate method of acceptance for sampling and testing when the material quantity meets the definition of small quantities. The CEI Inspector should visually inspect or verify that the delivered products or materials match the expected appearance and size specified in the **Contract Documents**, and are free from defects and contamination.

(3) Sampling and Testing

(A) Resident Level Responsibilities

It is the PA's responsibility to ensure that only materials meeting the **Specifications**, or properly documented and approved exceptions, are incorporated into the project. MAC contains several reports and search screens that can be used to track the status of samples for each project. The PA will make sure the samples are current **at all times** by ensuring prompt entry of sample data and field test results into MAC. The PA will finalize all project samples and create comparison packages for materials that require comparison. When the samples do not meet the comparison criteria (i.e., "Does Not Compare" in MAC), the PA will ensure that Resolution sampling and testing is performed, that the Resolution samples and test results are entered in a timely manner, and are included in the comparison packages. When it is not possible to perform a required comparison and/or Resolution, the PA will denote it was not possible on the comparison package and include the reason for not performing the required testing.

5.8.7 Materials Acceptance Resolution

If a material is designated by the Materials Certification Review personnel to require resolution of the material acceptance, it will be promoted to the Materials Acceptance Resolution (MAR) process in MAC. All materials with acceptance issues will be promoted to MAR and final resolution determined. The life cycle of the issue will depend on the original issue and the nature of the material acceptance needing resolution. Some issues can be resolved directly by the PA without additional input. Some issues will require input from the District Materials and Research Engineer (DMRE), the District Construction Engineer (DCE), and the Directors, Office of Construction (DOC) and Office of Materials (DOM). This procedure is outlined in the **Material Acceptance Resolution Flow Chart**

(Attachment 5.8-1). Regardless of the final resolution, the PA must provide detailed descriptions of the issue including location information.

(1) Materials Acceptance Resolution by Specifications

For straightedge deficiencies, the procedures shall follow the requirements of **CPAM Section 11.5, Testing and Correcting Asphalt Pavement Surface Deficiencies**.

For other material acceptance within **Specifications**, the PA will document the final resolution on the MAR issue in MAC. These determinations are designated by selecting one of the following options:

- a) Asphalt Follow-up Sample Passed – The material is resampled and the results are acceptable in accordance with **Materials Manual Section 3.1 District Materials Activities for Asphalt Pavement Construction**.
- b) Complete Removal and Replacement – The Contractor chooses to remove the material and replace it without requesting an **Engineering Analysis Report (EAR)**.
- c) Material Rejected for Use – The material was sampled from a stockpile and the material is removed from use on the project before it is placed.
- d) Pay Reduction per Specifications – The **Specifications** allow a pay reduction to be assessed if a material falls within the pay reduction criteria.
- e) Reworked and Remixed – The material allows for rework, and sample is taken for the rework that designates that the reworked material is acceptable.

(A) Resident Level Responsibilities

If the material is accepted based on the **Contract Documents** (i.e., Leave in Place at No Pay or Pay Reduction per **Specifications**), the PA will document the final resolution on the MAR issue in MAC. Once the PA has recorded the final recommendation, the issue is considered resolved. The PA will enter additional payment information in MAC if the final resolution includes reduced payment. The payment information is not relevant to the final resolution but is recorded to assist Construction personnel with tracking the payment requirement.

(2) Determining the Use of an EAR

If the material is determined to be defective in accordance with **Specifications Section 6-4** and the Contractor requests the use of an EAR in accordance with the material specific **Specifications** to determine the materials acceptance resolution, the PA, DMRE, and DCE must determine if an EAR will be used. Material not meeting any of the method of acceptance requirements is considered to be defective. Defective material is limited to requirements related to material acceptance. For example, improper Maintenance of Traffic is not a valid reason for defective material. However, defective material is not exclusive of material failing acceptance limits. For example, material required to be tested by a qualified technician, but tested by someone not holding the appropriate qualification at the time of testing is considered defective, regardless of the whether or not the test results pass the acceptance limits. There must be an evaluation of the defective material to determine if the defect requires analysis by EAR or other means of addressing the defect to ascertain the final resolution. The decision will be made based on the nature, location, severity and/or frequency of the defect.

Table 5.1

EAR Decision Table

	Case 1	Case 2	Case 3	Case 4
PA Recommends	EAR	EAR	No EAR	No EAR
DMRE Recommends	No EAR	EAR	EAR	No EAR
DCE Recommends	EAR	No EAR	No EAR	EAR
Final Decision	EAR Required	DOC obtains final decision	DOC obtains final decision	EAR Required

*See escalation and concurrence required below

(A) Resident Level Responsibilities

The PA will document their recommendation for the use of an EAR on the MAR issue by selecting the option “EAR” or “No EAR” in MAC.

Once the determination for the use of an EAR is made, the PA will coordinate with the DMRE regarding the scope of the EAR. The PA will provide the EAR scope to the Contractor and the EAR will be performed. The PA will attach the EAR to the specific MAR issue under the documents tab in MAC.

(B) District Level Responsibilities

The DMRE will determine if an EAR is needed and document their recommendation on the MAR issue by selecting “EAR” or “No EAR” in MAC. Once the determination for an EAR has been made, the DMRE will recommend the EAR scope including types of testing needed to ensure the EAR will yield the necessary information to determine the resolution of the defective material.

The DCE will determine if an EAR is needed and document their recommendation on the MAR issue by selecting “EAR” or “No EAR” in MAC.

If the DCE and DMRE concur, the DCE’s determination is final.

If the DCE and DMRE do not concur, follow the direction provided in the appropriate column of **Table 5.1** based on the recommendations provided by DCE, DMRE and PA. For Cases 2 and 3, the MAR issue will be escalated to the DOC and DOM.

NOTE: This is not the final resolution of the material, but only addresses whether or not an EAR will be allowed to be used to determine the final material disposition.

(C) Central Office Responsibilities

For Cases 2 and 3, if the DCE and DMRE do not concur, the DOC and DOM will have the final decision.

If the DOC and DOM do not concur, the MAR issue will be escalated to the Chief Engineer (CE) for the final decision.

Upon notification in MAC of Case 2 or 3, the DOC will ensure concurrence is obtained at the appropriate level.

(3) Determining the Use of Delineation

Some materials are allowed by **Specifications** to use delineation as the method to determine the material acceptance resolution. If the MAC Spec Material Id allows for delineation, additional information must be provided. The Contractor must request the use of delineation from the PA.

(A) Resident Level Responsibilities

The PA will document their recommendation for the use of delineation on the MAR issue by selecting "No EAR – Delineation", "EAR", or "No EAR" in MAC. The "No EAR – Delineation" option is only available when **the MAC Spec Material Id** indicates delineation is allowed based on the **Specifications** requirements.

(B) District Level Responsibilities

The DMRE will review the PA's recommendation. The DMRE will provide a recommendation of "No EAR – Delineation", "EAR" or "No EAR" in MAC.

The DCE will review the PA and DMRE recommendation for the material resolution. The DCE will provide a recommendation of "No EAR – Delineation", "EAR" or "No EAR" in MAC.

If the DCE concurs with the DMRE, the DCE's recommendation is used as the final resolution.

If the DCE does not concur with the DMRE's recommendation, the issue is elevated to the DOC for final decision, when DMRE designates "EAR" and DCE designates "No EAR- Delineation" or "No EAR". Otherwise, EAR is required. (i.e. Direction for these cases follow **Table 5.1** as well.)

5.8.8 Attachments

[Attachment 5.8-1](#)Material Acceptance Resolution Flow Chart

Attachment 5.8-1 Material Acceptance Resolution Flow Chart

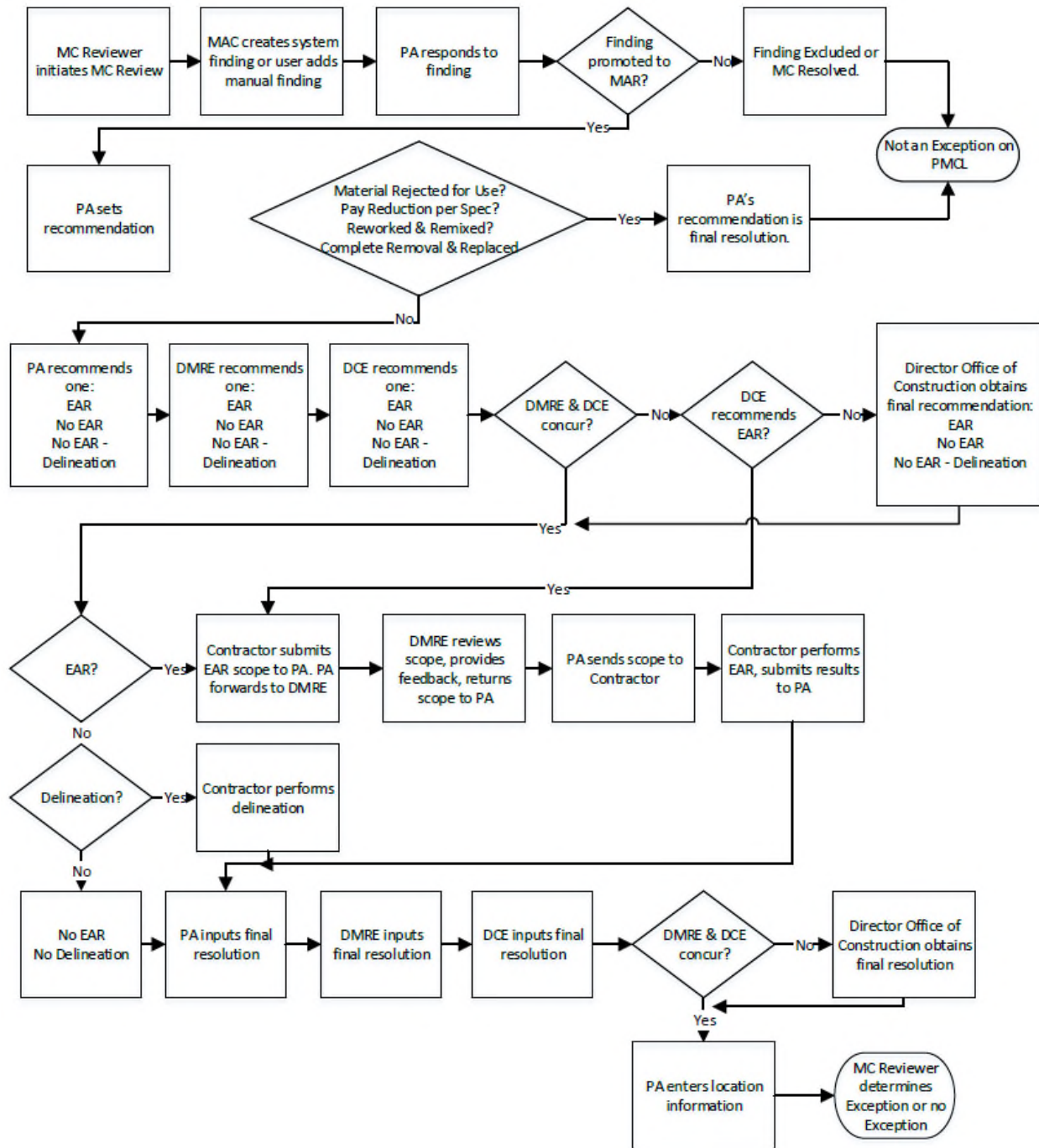

Section 5.9

STATE CONSTRUCTION OFFICE PROCESS REVIEW OF CONSTRUCTION ENGINEERING AND INSPECTION

5.9.1 Purpose

This section describes the State Construction Office (SCO) Process Review procedures for its Specialty Engineers and Specialists reviewing Construction Engineering and Inspection (CEI) processes in the Districts. The purpose of this Process Review procedure is to provide a uniform, statewide, documentable, management system to ensure CEI requirements are being met and include an emphasis on training and educating field staff when errors or deficiencies are found. The procedure applies to all construction personnel administering construction contracts of any type.

This chapter also addresses the Central Office role in assurance of the district's compliance with this chapter via Process Reviews. This process does not require mandatory process reviews to be conducted by the District, Resident or Project level staff, but this is optional to the Districts if they wish to develop such a review process.

5.9.2 Authority

Sections 20.23(4)(a) and 334.048(3), Florida Statutes

5.9.3 Definitions

Refer to the Introduction section of this *Manual*.

5.9.4 Overview

This Process Review procedure and guidance document explains what the Florida Department of Transportation's construction organization must do to conduct an effective Statewide Quality Assurance (QA) program. The goal of the Process Review program is to continually improve CEI performance.

To accomplish this goal, the procedure requires staff from the State Construction Office,

the State Materials Office, the Federal Highway Administration (optional) and the District Construction Office (optional) to review the performance of personnel charged with CEI duties.

Construction staff from the Central Office and the State Materials Office conduct Process Reviews to determine how well CEI personnel are performing the responsibilities they are assigned. These responsibilities are referred to as Critical Requirements and they are displayed on the SCO website under [Construction QA Critical Requirements Lists](#). The Process Review team will use the [QA Critical Requirements Lists](#) and [QC Guidelists](#) in their evaluation of field personnel performance. District personnel are encouraged to continue use of the QA/QC critical requirements and guidelists during their daily operations.

The results of Process Reviews are reported to the District Construction Engineer (DCE) with the District Process Review representative, where applicable, in a closeout meeting prior to the review team returning to the Central Office. Additionally, each review team will issue a PowerPoint report of their findings to the District Secretary, District Director of Transportation Operations, Chief Engineer, Director of Construction, and DCE. The report shall emphasize findings of areas where the District is performing well; cite the areas where improvements were needed and the steps taken during the review to correct those areas, and how well the QA/QC critical requirements and guidelists were being followed. Reviewers also record innovative CEI practices that are discovered during reviews so that these may be considered for implementation as improved ways of doing business in the future. The Reviewers should emphasize what is being done well and educate the correct method in areas found to be lacking.

The Process Review procedure also provides a process for reporting training needs and innovative practices to higher levels of management in order to ensure that this vital information is addressed properly and is communicated to everyone who might also benefit from it. When needs for improvements are found, the DCE or the District Process Review participant is tasked with evaluating the other Residencies or Operations Centers to determine if the same need exists in the other locations. Central Office Process Reviewers are tasked with the responsibility to determine in remaining reviews if similar training needs exist in other districts which would indicate a potential need for Statewide Training on the subject.

5.9.4.1 Review Frequency

Construction staff from the Central Office will perform Process Reviews of the CEI processes for which they are responsible. The Process Reviews on most categories will be done as a minimum once every two years per District.

The SCO lead reviewer should contact the DCE to find out who will be the District's contact person for Process Reviews. The lead reviewer will work with that person to schedule Process Review dates, the specific job sites to be reviewed, and a closeout meeting with the DCE.

5.9.4.2 Review Participation and District Response

District Level Responsibilities

The DCE is responsible for all QA activities at the District Level. The primary focus of the District Level activities will be to implement the actions and training recommended by QA Reviews. During the SCO Process Reviews, the District is encouraged to provide a knowledgeable staff member to participate in the review and escort the Process Review team during its visits to various district offices and jobsites. The DCE or delegate will participate in a brief kick off meeting at the beginning of the Process Review and will also participate in a closeout meeting at the conclusion of the Process Review.

5.9.4.3 Process Review Performance

Central Office Level Responsibilities

Process Reviews will be assigned by the Director, Office of Construction to various members of the Director's staff in accordance with the [QA Category Responsibility Table](#) published on the website of the SCO. The Assigned Staff will schedule the review with the DCE or delegate at least 30 days in advance. The assigned Reviewer will solicit the participation of the State Materials Office (where appropriate), the Federal Highway Administration (where appropriate), and may also wish to solicit the participation of a specialist from one of the districts or other offices when that specialist can bring a level of expertise to the review not available in the SCO. This person would participate in Process Reviews for that area of expertise conducted in all the districts.

If a Process Review results in finding an opportunity for improvement, those findings shall be discussed with the field staff involved in order to educate them regarding that area for improvement. Those opportunities for improvement shall also be discussed with the DCE at the closeout meeting. The DCE should ensure that the findings are discussed at the next Resident and District level staff meetings. Where findings have statewide significance, the Process Review team is tasked with communicating in writing to the SCO their findings for presentation at the next DCE Meeting or immediate distribution to all districts and for consideration of future statewide training opportunities.

A **Process Review Report (Report)** shall be made in a PowerPoint presentation format by the review team member from the SCO for every Process Review performed, within 14 days of the completion of the review. The **Report** will be uploaded to the SCO SharePoint Site and the review team member will notify the Director of Construction the Report is complete and ready for distribution. The Director shall email a link of the **Report** to the District Secretary, Chief Engineer, Director of Transportation Operations and DCE. The **Report** shall state the Process Review date, category reviewed, locations reviewed and personnel involved and describe the kickoff and closeout meetings held with the DCE or delegate. The **Report** shall comment on each of the **Construction QA Critical Requirements** to the effect that they are or are not being accomplished. The **Report** may, at the Reviewers discretion, also comment on any of the **QC Guidelist** items to the effect that they are or are not being accomplished. Where ever the **Report** notes that a **QA Critical Requirement** or **QC Guidelist** item is not being accomplished satisfactorily, this may be considered as an opportunity for improvement. The **Report** shall also recommend the appropriate corrective actions and or training required for the area of improvement so the Districts CEI Staff can start performing the critical requirement or guidelist task correctly.

When a response from the district is required, the **Report** should clearly state the District Action Items on which a response is required and the DCE should respond to the action items within 30 days of receiving the **Report**. Official responses shall be recorded on the response slides provided in the **Report** and those slides emailed to the Director of Construction, to be incorporated back into the official **Report**.

The findings and dispositions of each Process Review will be maintained on the SCO SharePoint site.

Guidance Document 5-9 Conducting a Process Review

I. OVERVIEW

This guidance document is intended to be used by a Process Reviewer. By fully using these **Guidelines**, a reviewer will be aware of important QA requirements that should be examined during a review. The review must cover the following major QA concerns: Verification that Critical Requirements are being met, verification that actions and training recommended in previous QA Reviews have been implemented.

II. VERIFICATION OF CRITICAL REQUIREMENTS

Guidelist Possession – This is strongly encouraged for all technicians but not mandatory. The **QC Guidelists** include critical requirements and many other requirements that QA and QC personnel must be familiar with, so it is important that those working for the Florida Department of Transportation have access to a current copy of the **QC Guidelists** readily available.

Critical Requirements Verification - The reviewer must conduct process reviews on Construction Engineering and Inspection (CEI) personnel as if they were, reviewing the field CEI effort. This means that the reviewer must check the QC performance of inspectors and other CEI staff for compliance with the requirements of a specific assessment category. If the reviewer finds Critical Requirements (CR) that have significant Opportunities for Improvement (OFIs), the reviewer should check non-critical requirements since OFIs on Critical Requirements may be an indication that non-critical requirements may also show opportunities for improvement.

QA Log - The DCE is encouraged to maintain a log containing a copy of all District QA Review Reports performed in the last four years. This Log should be made available upon request

Section 5.10

VERIFICATION INSPECTION AND TESTING

5.10.1 Purpose

This section provides minimum verification inspection and testing frequencies when they are not established in the **Specifications** or at the “Discretion of the Engineer.” The purpose is to monitor and verify the Contractor’s construction processes to ensure construction and material quality comply with **Specification** requirements.

5.10.2 Authority

Sections 20.23(3)(a) and 334.048(3), Florida Statutes (F.S.)

5.10.3 Scope

This document applies to project personnel, namely Verification Technicians, Project Administrators, and Project Managers, in establishing the minimum verification inspection and testing frequencies when they are not established in the **Specifications** or at the “Discretion of the Engineer.”

5.10.4 Inspection Frequency

5.10.4.1 Asphalt

(A) Resident Level Responsibilities

In addition to the frequency of verification, resolution, and independent verification of material properties and construction inspections required by the **Specifications**, Qualified Asphalt Technicians shall also perform inspection and verification activities randomly at the job site and asphalt plant to evaluate the reliability and uniformity requirements of Contractor’s Quality Control operations. The Quality Control (QC) and Verification (VT) Technicians shall document the findings and results in the **Asphalt Roadway – Daily Report of Quality Control – Automated Version, Form No. 675-030-20A** and the **Asphalt Roadway – Verification Report, Form No. 675-030-21**, respectively. Asphalt plant information shall be uploaded into the **Materials and**

Certification (MAC) database. Straightedge testing information shall be uploaded into MAC, however, other Roadway inspection information is not required to be entered into **MAC**. **Frequencies for various Inspection and Verification activities** are as follows:

Tack Coat Spread Rate	Once / Day
Asphalt Mix Spread Rate (Yield)	Once per layer / Day
Asphalt Mix Temperature	Twice / Day
<u>Depth and Cross Slope (Milling)</u>	
Tangent Sections:	10 / lane mile
Transition Sections:	At control points in plans.
Super-elevated Sections:	Minimum of 3 measurements.
Milled Surface Texture	Once / Day
<u>Cross Slope (Paving)</u>	
Tangent Sections:	10 / lane mile
Transition Sections:	At control points in plans.
Super-elevated Sections:	Minimum of 3 measurements.

Milling and paving cross slopes shall be documented in the **Cross Slope Measurement Data Form – Automated Version, Form No. 700-010-99** and the findings of milling surface texture shall be documented in the Remarks Section of the **Asphalt Roadway - Daily Report of Quality Control-Automated Version, Form No. 675-030-20A**.

In addition to the above verifications and inspections, the Roadway Verification Technician (VT) shall also monitor and inspect the Contractor's construction processes in accordance with the **Statewide Construction Inspection Guidelists (SCIG)** as specified in **CPAM Section 3.2** at a frequency of once per day during production. For example, the Asphalt Roadway VT shall use SCIG Category No. 7B to ensure asphalt pavement is being constructed consistently and accurately in accordance with Contract Documents.

The frequencies stated above are minimum frequencies. If visual inspection of the performance indicates the need, the frequency shall be increased to ensure a project's construction and material quality comply with the **Specifications**.

5.10.4.1.1 Corrective Action

(A) Resident Level Responsibilities

The inspector shall inform the Contractor's Quality Control (QC) Manager about any deficiencies and advise the QC Manager to take corrective action immediately. Once

the corrective action has been taken, the inspector shall perform a re-check. If the re-check indicates the construction is still not in compliance with the **Specifications**, the inspector shall advise the Project Administrator (PA) about all identified deficiencies. The PA shall take appropriate action to ensure the issues are resolved by the contractor.

Disposition of deficiencies shall be handled in accordance with the **Specifications**.

5.10.4.2 Density Cores

(A) Resident Level Responsibilities

The inspector shall mark the locations of QC and IV density cores, as well as, any cores cut for delineation testing or Engineering Analysis Report (EAR) testing purposes by spray painting each core location using a Florida Department of Transportation (FDOT) stencil. FDOT stencils can be obtained from the District Materials Offices (DMOs).

Section 5.11

FINAL ESTIMATES DOCUMENTS

5.11.1 Purpose

This procedure describes responsibilities of the Resident Office (RO), both Department and Consultant Construction Engineering and Inspection (CCEI) staff, and methods for processing monthly progress estimates and final estimates for payment in AASHTOWare Project Construction (PrC). After the final plans, quantities, required construction documentation, and final measurements are verified per the RO's Quality Assurance (QA) plan, the final estimate is submitted to the Contractor for acceptance with the **Offer Letter**, and the **Final Estimates Documents** are submitted to the District Final Estimate Office (DFEO).

5.11.2 Authority

[Sections 20.23\(3\) \(a\) and 334.048\(3\)](#), Florida Statutes (F.S.)

5.11.3 References

Sections [337.11](#), [337.16](#), [337.141\(4\)](#), [337.145](#), and [120.57](#), Florida Statutes (F.S.)

Rules [14-22.012](#), [14-22.0141](#), and [14-24.001](#), Florida Administrative Code (F.A.C.)

5.11.4 General

(A) Personnel Qualification

The person(s) responsible for preparing monthly and final estimates and submitting the **Final Estimates Documents** to the DFEO must be Construction Training Qualification Program (CTQP) Final Estimate Level 2 qualified. See the [State Construction Training website](#) for more information.

(B) Quality Assurance

The person(s) responsible for preparing and submitting the **Final Estimates Documents** must abide by the quality assurance requirements of **CPAM Section 3.5** and the Consultant Construction Engineering and Inspection Scope of Service requirements (when applicable).

(C) Document Submittal

Documents required to close out a contract will vary from project to project. It is the responsibility of the Project Administrator (PA) to check the Contract and **Specifications** requirements to ensure all the essential **Final Estimates Documents** are submitted and complete.

- (1) The initial notification and collection of required documents is the responsibility of the PA. Any outstanding Contractor documents must be requested from the Contractor with instructions to forward them to the Resident Office (see [Attachment 5-11-1](#) for **Notice of Outstanding Documents**) prior to submitting the **Offer Letter** to the Contractor.
- (2) Prompt review and approval of the documents submitted by the Contractor are crucial steps in contract closure. Ultimately, receipt of the required contract documents controls the payoff date for the contract. These documents are strictly under the control of the Contractor. When complete documents are received by the Department, the payment clock begins, and interest can be assessed on monies due if a delay is experienced in the final payment of the contract.
- (3) The Contractor must use the official forms provided by the Department for each required document. Return any unacceptable form(s) to the Contractor within twenty (20) days of receipt with a notification stating the submitted forms are unacceptable. Ask the Contractor to execute the documents on the Department's official forms, and provide copies of the official forms.
- (4) The time of receipt is the time the intended recipient received the document. If any e-mail or electronic document is received after 5:00 PM Eastern Standard Time (EST) [4:00 PM Central Standard Time (CST)], the document will be considered as received the next business day.

5.11.5 Progress Estimates

The RO must prepare and submit monthly progress estimates for each contract to the District Office no later than the first Tuesday following the Sunday cutoff each month. Exceptions to this include the conditions described in CPAM 5.11.5(E), periods where no work was performed, or during the period before work begins (i.e., stockpile material payments may be made during the procurement period, then monthly estimates skipped until work begins).

It is the responsibility of the District to ensure that all progress estimates are received in the Office of the Comptroller, Disbursement Operations, no later than 8:00 a.m. on the fifth working day (Friday) after the cutoff date. Cutoff estimate dates are located on the Construction website at the following link:

<http://www.fdot.gov/construction/CONSTADM/EstimatesCutOff.shtm>

The monthly progress estimate is prepared to show the quantity increases (sometimes decreases) for all items completed, underway, or stockpiled for use on the project. The RO will enter quantity changes into PrC.

For items underway, the estimate of work completed must be made in accordance with **Specifications Section 9-5** and by using the **Items Eligible for Partial Payment** report link below. Partial payment for stockpiled material, when requested by the Contractor, will be in accordance with Section **5.11.5(C)**.

PAY ITEMS ELIGIBLE FOR PARTIAL PAYMENT

Optional base pay items are the only pay items eligible for partial payments not included in the **Items Eligible for Partial Payment** report. Partial payment for optional base pay items is the area placed prorated by lift thickness. Asphalt base partial payments are calculated automatically in the **Quality Control Roadway Report (QCRR)**. Payments for non-asphalt base are calculated manually using the following method (see [Attachment 5-11-4](#) for examples):

$$\text{Partial Pay Area} = \text{Surface Area Placed} \times \frac{\text{Lift Thickness}}{\text{Plan Thickness}}$$

Partial Pay Areas are entered in PrC on the pay item (using Agency Views in PrC). The last Lift must be finished and primed before payment is made for the last Lift of non-asphalt base. Ensure the final pay area does not exceed 105% of the surface area.

The contractor is required to certify monthly that all applicable subcontractors and suppliers of material and equipment have been paid their proportionate share from the last progress estimate payment per **Specifications Section 9-5.6**.

It is important for subcontractors to be paid in a timely manner. Therefore, special effort must be made to ensure that all items requiring **Certification of Quantities** from the Contractor are paid on a progress estimate prior to the final estimate.

Any bonus or incentive payments should be paid as soon as practical and can be paid by a progress estimate up to and including the final estimate. It is incumbent on the

responsible RO personnel to notify the DFEO of any incentive payments due to the Contractor for the encumbrance process to be made.

After final acceptance of the work, progress estimates may be processed to pay any remaining work items and any bonus or incentive payments on the contract in accordance with the **Specifications**. This will help ensure the **Offer of Final Payment** will be a zero-amount due, when possible.

Once an estimate is generated in PrC, the RO must ensure the Estimate Discrepancy report shows “No Errors Found” prior to approval. The RO must also ensure funds are available in the appropriate accounting codes listed on the certification page of PrC Pay Estimate Report (previously known as the TSO estimate) – see Example 1 below.

Example 1

CNTR	FCT	TR	AP/BN	LINE	ORG-CODE	EO	OBJ	OCA	C	R	AMOUNT	QNTY	INV#	LINE	DESCRIPTION	OD	B	EGL	EOB	CNTR #
															COSEC	FIN.PROJ.#	DST	CB		
		203		EBR45	55083000834	A4	563000	00000			867,654.77			16	89470	43799215201	08	0	203	EBR45
		203		EBR45	55083000834	A4	563000	00000			21,284.15			16	89470	43799215201	08	1	203	EBR45
		209		EBR45	55083000834	A4	563000	00000	CR		37,550.94			16	89470	43799215201	08	0	209	EBR45
		202		EBR45	55083000834	A4	563000	00000			25,455.75			16	89470	43799215201	08	0	202	EBR45

If the estimate needs to be modified, changes can be made if the next approval level within PrC rejects the estimate.

A “Hold” or “Block” should only be used in the **Electronic Estimates Disbursement (EED)** payment system for negative estimates, when the Contractor owes the Department, or on positive estimates, when the Contractor does not submit contract required paperwork. Estimates must be processed through EED in numerical order. For more information and examples, see the [SharePoint FAQ](#) (Internal link).

(A) Contractor Certifications

(1) Form 700-010-52, Contractor’s Affidavit Vehicle Registration

The Contractor is required to furnish an affidavit, before any progress payments, are made stating that all motor vehicles operated or caused to be operated on the project are registered in Florida. Progress payments will be withheld if this document is not received. Only the

prime Contractor is required to provide this certification on a one-time basis at the beginning of the project.

(2) Form 700-020-02, Construction Compliance with Specifications and Plans

This form states that all Quality Control functions, and all Quality Control sampling and test results are in substantial compliance with the pertinent specification requirements. Any outstanding issues or exceptions are listed on this form. This form is required each month prior to estimate submittal and a final version documenting all exceptions is required before the final estimate can be processed.

If the PA has not received these certifications in time to send them with the estimate to the District Office, the estimate will not be forwarded. The certification is not required if a contract doesn't have materials that require Contractor Quality Control per **Specifications Section 105**.

NOTE: The Contractor must submit **Form 700-020-02** marked as Final to process the final estimate. It must indicate the entire contract duration and detail all exceptions to Contractor Quality Control sampling and testing as required by the Plans and **Specifications**.

(3) Form 700-010-38, Certification Disbursement of Previous Periodic Payment to Subcontractors

This form states that the subcontractors have been paid their proportionate share from the last progress payment. The Contractor is required to submit this form each month prior to estimate submittal; except for the first estimate since there is no previous payment to disburse. If this certification is routinely late, non-compliance letters should be issued by the PA and sent to the contractor.

No progress payment will be made after the initial payment until the Contractor provides this certification. For Unpaid Bill claims from a subcontractor/supplier or incomplete Certification, see guidance in CPAM Section 6.1 and [Attachment 5-11-2 Guidance Letters](#).

NOTE: The above form, is not needed to process the final estimate, since **Form 21-A** contains essentially the same certification and is required for contract closeout.

(4) Certifications of Quantities

See **CPAM Section 5.14** for more information.

(B) Roadway and Bridge Daily Work Report (DWR)

The **Daily Work Report (DWR)** within PrC is used on each contract for the recordation of events, data, occurrences, instructions, situations, circumstances, and work performed each day during a construction project. Data is collected on every phase of work performed by a Contractor, Subcontractor, or Utility Company. Recorded information must be clear, detailed, accurate, complete, and objective. Anyone reading the project DWR should be able to comprehend the project status and determine the work performed.

NOTE: Form 700-010-13, the **Daily Report of Construction**, also known as “the Diary” is still used for Construction Contracts which are not in PrC, such as Short Duration Emergency contracts (some of these are in PrC), and Local Agency Program (LAP) contracts.

It is mandatory that documentation be maintained to justify quantity increases (sometimes decreases) for the monthly progress estimates. The DWRs and Diary reports are helpful and may be considered adequate documentation; however, any method that provides complete and accurate records of pay quantity changes is acceptable.

The DWRs and Diary reports are not to be considered for final payment purposes when reflecting quantities. Quantities reflected on the DWR are typically not recorded with appropriate computations and measurements at the project site and are crudely done with no intent for final payment. Most often these entries will be duplications of past entries. Therefore, actual quantities for final payment purposes must be recorded on the appropriate **Field Records** or backup documentation (such as spreadsheets) with actual measurements, dimensions, and computations to substantiate the payments and entered in PrC.

NOTE: For detailed instructions on completing the DWR, see **CPAM Section 5.1** and the [PrC Handbook](#).

(C) Payment for Stockpile Material

Partial payments are allowed for new materials that will be permanently incorporated into the project and are stockpiled for the project, in approved locations in the project vicinity and Off Site per **Specification 9-5.5**. Explain this procedure and **Form 700-010-42, Certification and Request for Payment for Stockpiled Materials**, at all preconstruction

conferences. Partial payments will be controlled by the following provisions in addition to the **Specifications**:

(1) Certification and Request for Payment for Stockpiled Materials

Prior to any payment for materials being included in a progress estimate, **Form 700-010-42, Certification and Request for Payment for Stockpiled Materials**, must be executed by a person employed by the prime contractor in a supervisory capacity. All accompanying invoices must be in the project records.

All materials must be stockpiled in a manner such that it is readily discernible that such materials are being reserved for exclusive use of the contract under which payment is requested. An aggregate for use in asphalt mixes or Portland cement concrete pavement must be in a stockpile set aside for exclusive use in producing mix for Department contracts. If a stockpile contains material for more than one Department contract, a control procedure submitted by the Contractor and approved by the Engineer/Administrator must be established to properly allocate costs between contracts.

For steel material or manufactured items containing steel components, Buy America certifications must accompany the request. The request for partial payment for materials stockpiled off site must be submitted in a timely manner. Payment for such items is to be based on the invoice price including delivery charges for delivered materials. The certification/request form must contain verification from the vendor that the material has been fabricated for specific use on the project; the material meets all the contract requirements and is properly stored in a secured manner for the sole use of the prime contractor and the specified project.

No payment for Stockpiled Material will be made for incomplete requests, missing back up documentation (invoices, certifications, etc.), or material unable to be verified by the RO.

(2) Location of Stockpiled Materials

Most of the materials eligible for partial payment will be stockpiled "in the project vicinity." Some materials may be stockpiled and stored off site (ex. precast yard or fabricator facility), in accordance with **Specification 9-5.5.3**.

"The project vicinity" is defined as a location readily accessible to the PA or other designated Department representative for verification of quantities and periodic review to ascertain that materials are reserved for exclusive use on the contracts under which payment is made.

(3) **Verification of Stockpiled Materials**

Prior to entering payment for stockpiled material on a progress estimate, the PA must verify that the quantity of material for which the Contractor has requested payment is in fact stockpiled at the location designated. The PA must complete and sign the Verification section of **Form 700-010-42, Certification and Request for Payment for Stockpiled Materials** prior to payment as well.

For aggregates: measurements, calculations, or documented observations to approximate the quantity of material in each stockpile must be made.

If a material is stockpiled at a precast yard or structural steel fabrication plant, verification may be by a written statement from the Department's representative at that facility.

The PA, prior to submitting each progress estimate, must verify that materials for which payment has been made on earlier progress estimates remain stockpiled as designated and stored in a manner to prevent deterioration and damage or have been incorporated in the project. As stockpiled materials are incorporated into the project, the PA must adjust payments accordingly.

(4) **Materials Certification**

The PA must ascertain prior to payment that the materials for which payment is requested comply with applicable **Specifications**. Material invoices that are used to determine the amount of partial payment for fabricated structural steel materials must have attached with the invoice, test data showing approval and compliance with the **Specifications**. The test data and the invoice must contain identifying mark numbers and weights for each fabricated component as detailed on approved shop drawings together with the price per pound and the total amount of the invoice. Invoices that are submitted without the information described will not be used as a basis of partial payment.

(5) Proof of Payment

The Prime Contractor must provide proof that a payment has been made to its subcontractors and vendors before the next estimate after the partial payment is initially made.

A certification by the Contractor that it has paid its subcontractors their proportionate share from the last progress payment, as defined in **CPAM Section 5.11.5(A)(3), Form 700-010-38, Certification Disbursement of Previous Periodic Payment to Subcontractors**, is acceptable for this action.

(6) Documentation

The Electronic Document Management System (EDMS) must include all information on the material being stockpiled; i.e., name and address of supplier; how material was verified and eligible for payment including the place, date, and the individual who has examined the stockpiled materials; calculations on how payments for materials are determined, calculations should also indicate which is stockpiled and which is installed materials; all invoices (especially pre-stressed products and structural steel) must include the pay item numbers; and inspector's identification numbers or stamp; and paid invoices and other documents as may be required by this procedure.

NOTE: Stockpiled material payments may be made during the procurement period. Monthly estimates will be skipped until work begins.

(D) Retainage

Retainage will be withheld in accordance with **Specifications Section 9-5**. Some contracts may have special provision requirements, which change the standard schedule (10%). Retainage is released on the final estimate, which means the final estimate will not be zero. Retainage may be reduced to \$1,000, see [CPAM 5.11.6\(B\)](#).

(1) Calculating and Applying Retainage:

Apply all adjustments (Fuel & Bit, CPF, Liquidated Damages, etc.) except retainage to the estimate in PrC and run the PrC Pay Estimate Report (previously known as the TSO estimate). Take the Amount Payable under the "CHANGE THIS ESTIMATE" column, move the decimal point one (1) place to the left (10%), and round to the nearest

penny. This is the amount of retainage to withhold. Go back to any project with earnings and apply the Retainage as a Contract Adjustment and process the estimate again.

(E) Liquidated Damages

When the Contract time is exceeded, liquidated damages must be withheld from the contractor monthly. The contractor is charged for the defaulting days, which are the calendar days between expiration of the present contract time and the cut-off date of the estimate. The liquidated damages rate is established in **Specifications Section 8-10**. Upon approval of the District Construction Engineer, the Project Administrator may adjust the liquidated damages rate to the actual CEI cost for the contract during the damage period provided the following criteria have been met:

- (1) All Contract Work is complete (with exception of minor punch-list items which do not require a lane closure)
- (2) The only outstanding contract requirements are the submission of final documentation, such as certifications, affidavits, as-built drawings, etc.

Liquidated Damages are calculated by multiplying the daily rate by the number of default days and entered in PrC as a contract adjustment. For multi-FIN contracts, liquidated damages are pro-rated between projects based on the original contract amount. Only apply liquidated damages to projects with positive amount due. Do not apply liquidated damages to Phase 56 projects.

When **Supplemental Agreements** and time extensions are pending that would add sufficient days so the contract time is not exceeded, the Director, Office of Construction may approve to not assess liquidated damages or to bypass the requirement to process a monthly estimate pending execution of these instruments.

5.11.6 Final Estimate

After the final quantities are paid on the last progress estimate, the final estimate will be processed in PrC using a progress estimate with final approval level set as **PrPPrCService Account**. Confirm remaining approval levels with the District Final Estimates Office.

NOTE: Use the “*EED Final (Construction only)*” selection with “*Const Progress- Progress*” not “*Const Progress-Final*” estimate type option (pictured below) when processing all estimates in PrC. When the “*Const Final - Final*” type is used, the system will not allow additional changes and will close out the contract.

The screenshot shows a dropdown menu titled "Type *". The current selection is "Const Progress - Progress". The menu is open, showing the following options: "Const Final - Final", "Const Progress - Progress" (highlighted with a red box), "Const Semi Final - Semi-Final", and "Const Supplemental - Supplemental".

The screenshot shows a dropdown menu titled "EED Final (Construction Only)". The current selection is "Y". The menu is open, showing the following options: "Y" and "Draft".

The Final Estimate should be zero, when possible, except for the case of overpayment, it will be negative. The RO will include the Final Estimate PrC Pay Estimate Report (previously known as the TSO estimate) with the **Offer Letter**.

(A) Verification of the Final Estimate

The RO should verify that all entries in PrC for each pay item in the Contract are cross-referenced with back up documentation final quantities. The back up documentation will be referenced on the **Pay Item Summary & Certification Sheet** generated from PrC in Ad-Hoc after the final estimate is generated, per **CPAM 5.13**.

The final quantities and payment will include:

- (1) Arbitration rulings as they are approved.
- (2) Court orders or other legal actions received from the Department's Office of General Counsel (OGC).
- (3) Pay adjustments for bituminous materials and fuels, when applicable.

- (4) Adjustments for any failing materials including any quality assurance penalties. Each penalty should be shown separately.
- (5) Contract Time: The contract time overrun or underrun should be determined and the following applied when appropriate:
 - (a) The appropriate liquidated damage dollar amounts on federal aid and non-federal aid projects.
 - (b) Any incentive/disincentive amounts.
- (6) All other contract specific payments and adjustments.

The RO will review the total effect of claim settlements, liquidated damages, pay adjustments, penalties, and line item and contract adjustments to ensure that duplicate payments are not made.

NOTE: Items requiring a Certification of Quantities to be provided by the Contractor must be reviewed by the RO. The RO will use reasonable investigation during the estimate period, to ensure the quantities are correct to the best of his/her knowledge. If an error or omission is a result of erroneous information provided on these Certifications, the RO will not be held responsible for the quantities in the ***Certified Final Estimates Documents***.

(B) Retainage Reduction

Issuance of a progress estimate to reduce retainage to \$1,000 is subject to the following provisions:

- (7) The amount retained is sufficient to cover any possible decrease in the quantities shown on the last paid estimate tabulation, plus any amounts the Department elects to deduct for unsatisfied claims or defective work as provided in ***Specifications Section 9-5***.
- (8) All submittals required by the Contract, such as invoices, Equal Employment Opportunity reports, materials certifications, certification of materials procured (excluding Contractor's letter of acceptance of final amount due and ***Form 21-A*** release), have been received. When retainage is reduced, include the District Construction Engineer (DCE) and the District Final Estimate Manager (DFEM) on the correspondence.

5.11.7 Offer Letter

Within 30 days of Final Acceptance and upon completion of the review process and production of the final estimate, notify the Contractor of the results of that review and of any documents necessary to close out the contract (i.e., list pending Supplemental Agreement numbers, all items not within it, or list pay item numbers waiting for certification) with the **Offer Letter**.

There are two versions of the **Offer Letter**. An **Offer of Final Payment** or a **Request for Refund** letter (see [Attachment 5-11-02](#), **Letters 5-11-01** through **5-11-06**).

- (9) The **Offer of Final Payment** letter is issued when the Contractor is offered a positive, preferably zero, final payment amount due.
- (10) The **Request for Refund** letter is issued when the Contractor has been overpaid and is offered a negative amount due. The letter will request the Contractor to write the Department a check in the amount overpaid.

NOTE: Submittal of the **Offer Letter** will only be made once. Revised **Offer Letters** are **not allowed**. This is very important to avoid interest accrual due to delayed payment to the Contractor.

The following guidelines will be followed:

- (2) CCEI will follow procedures as outlined in the Scope of Services and will utilize its company letterhead for the **Offer Letter**.
- (3) All in-house personnel will use Department letterhead for the **Offer Letter**.
- (4) The **Offer Letter** should be submitted to the DFEO for review and approval prior to sending to the Contractor. The **Offer Letter** for Public Private Partnerships (P3) contracts will include the Final Payment Schedule (provided by the Office of Comptroller during DFEO review) and must be approved by State Final Estimates Engineer prior to submission to the Contractor.
- (5) The **Offer Letter** will be sent electronically to the Contractor with electronic read and delivery receipt requested, so that a record is made of the Contractor's receipt of the **Offer Letter**. The DFEO will be included on all correspondence regarding the **Offer Letter** and read/delivery receipts.

- (6) Notes will reflect that all further correspondence concerning submittal of required contract documents will be forwarded to the DFEO and the letter will include the appropriate email address and name of the DFEM.
- (7) Send the **Offer Letter** to the following interested parties:
 - (a) Surety Company (Surety)
 - (b) Accounts Receivable (AR) Administrator in the Office of Comptroller General Accounting Office (OOC-GAO) when the **Offer Letter** is a **Request for Refund**.
 - (c) SMO when the Materials Certification has not been received by the DFEO with all exceptions acceptably resolved.
- (8) The first section of the **Offer Letter** contains information as to the amount due or owed on the final estimate and includes any estimates issued before the final estimate that are “held” or “blocked” by the OOC or the District in EED.
- (9) The next section of the **Offer Letter** is the request for the documents necessary to close the contract that have not previously been submitted by the Contractor. The following is a list of the documents:
 - (a) **Acceptance Letter**. There are two types of acceptance letters: one for a **Regular Acceptance** and one for a **Qualified Acceptance**. The **Acceptance Letter** will be executed by the Contractor. (See [Attachment 5-11-2](#), **Letters 5-11-07** and **5-11-08**.)
 - (b) **Form 700-050-21, Contractor's Affidavit and Surety Consent (21-A)**.

Note: for contracts Let July 2016 and forward, the corporate and/or surety seal will not be required when digitally executed. The same document would require corporate and/or surety seal if executed by wet-ink signature (never mix wet ink and digital in same document). This also applies to **Form No. 700-050-22, Form 21-A (Modified) Surety Takeover**.
 - (c) **Form 700-020-02, Construction Compliance with Specifications and Plans**

- (d) Any wage rate requirements.
 - (e) Any mill tests and analysis reports needed to complete testing requirements on the contract.
 - (f) As-built drawings and certified surveys
 - (g) Any other contract specific documents, the Contractor is required to turn over to the Department prior to the conclusion of the contract, including material tickets needed to calculate final payment and warranty documents.
- (10) If there are estimates “held” or “blocked” in EED, the RO should notify the DFEO. These estimate amounts need to be reflected on the **Offer Letter** to the Contractor.
- (11) Attached to the **Offer Letter** will be the PrC Pay Estimate Report (previously known as the TSO estimate) final estimate, **Acceptance Letter**, contractor survey, and other contract appropriate documentation.

NOTE: On contracts using "No Excuse Bonuses", the Contractor must provide in writing a full and complete waiver of any and all claims against the Department to be eligible for the bonus payment provision, per **Special Provision Specifications Section 8-13.1**. Collection of this waiver letter is mandatory for the Contractor to be eligible for the bonus payment.

5.11.8 Certified Final Estimates Documents

(A) Final Plans and Estimate Transmittal Form

Upon completion of a contract, all **Final Estimates Documents** must be submitted by the RO to the DFEO within 30 days of Final Acceptance. **Form 700-050-20**, the **Final Plans and Estimate Transmittal**, is used to document the items submitted including, but not be limited to, the following: a tabulation of the **Final As-Built Plans, Field Records**, and other required documents showing the title and general description of the contents of each item, as well as:

- (1) Pending **Supplemental Agreements** which have not been submitted to the District Office (include information as to the scope, the approximate cost and the additional contract time involved and the **Agreement**.)

- (2) Any unresolved claims which may be pending at the time the estimate is submitted.
- (3) On contracts that include signalization, the following must be completed:
 - (a) **Final Acceptance of Traffic Signal Installation(s) and Transfer of Maintenance**, Form No. 700-010-22
 - (b) Finalized **Submittal Data – Traffic Control Equipment, Form No. 750-010-02**
 - (c) Digitally signed and sealed as-built plans from the Contractor – Also distribute to Traffic Operations, the maintaining agency, and input into the **Electronic Document Management System (EDMS)**.
 - (d) The As-Built Documentation required by **Specifications Section 611**, including the As-Built Drawings and the Feature Import Templates for the Department's ITS Facility Management (ITSFM) System, will be submitted by the Contractor, reviewed by the PA for accuracy, and submitted to the District Traffic Operations Office.

(B) Documentation of Contract Time

Maintain the documentation of all contract time changes occurring during the life of the contract in EDMS. The documentation will contain the following:

- (1) Notice to Proceed Letter (NTP)

The NTP is prepared in letter form and is sent via e-mail by the appropriate District Construction Office to the Contractor. The NTP notifies the Contractor to begin work on the contract in keeping with the time limitations stipulated in the Contract Documents. This letter is to be included as part of the Time Correspondence group (CONST17) in EDMS. (See [Attachment 5-11-2](#), **Letter 5-11-12**)
- (2) All letters granting an extension of contract time.
- (3) Any executed or pending **Supplemental Agreements, Work Orders, or Unilateral Payments** that affect contract time (Do not include backup documentation for these documents in the time file).

(4) Any other documents such as court orders, takeover agreements that affect contract time.

(5) Ensure the time summary included on **Form 700-050-28** shows the correct accounting of the contract time, both state and federal aid, including the original contract time, the time added by each supplemental agreement, time extension, and any other documents affecting contract time.

(6) Notice of Project Beginning Memo

This notice document is sent by the appropriate Resident Office as a memo to the DCE (copy contractor and the District's distribution list). It notes the first chargeable day, the first actual day of work, and the contract duration of the project. (See [Attachment 5-11-2](#), **Letter 5-11-11**.)

(7) Final Acceptance Letter

This Letter is sent by the appropriate Resident Office to the Contractor and should include the final acceptance date, actual contract time used, and any warranties and length of warranties associated with the contract.

NOTE: EACH DOCUMENT REQUIRED UNDER THIS SECTION SHOULD CONTAIN THE BREAKDOWN OF FEDERAL AID PARTICIPATION AND THE ACTION TAKEN BY THAT DOCUMENT. In the event that a response has not been received on projects wherein FHWA has retained responsibility for the determination of FHWA participation and certification acceptance projects, the District's request will be submitted and included in EDMS. These projects can include Projects of Corporate Interest (PoCI) and Projects of Division Involvement (PoDI). The DFEM will follow up on the status of the participation request.

On FHWA PoDIs which are not governed by a project specific PoDI plan wherein FHWA has retained responsibility for the determination of FHWA participation, the DCE has the responsibility of determining and approving federal aid participation in time changes, therefore all item-changing documents on this type of project must show the breakdown of federal aid participation.

(C) Explanations of Overruns and Underruns

An explanation of variations between the designer's original estimated quantities and the construction final quantities must be made. **This is a very important document. It is suggested the PA prepare it.** When these variations have been properly researched, accurate explanations can be made. These explanations are manually entered for items that have significant overruns or underruns and in the order the items are shown on the contract.

- (1) Items paid under Final Measure Quantity, Plan Quantity or Lump Sum Concept that have no change or have changes which are not significant need not be explained on the overruns and underruns document. A change is considered significant when its dollar value exceeds \$10,000.
- (2) Deviation of Plan Dimensions by the Contractor equaling the aggregate change of \$10,000.00 must be explained on the overruns and underruns document.

The PA will generate an **Over Runs - Under Run Report** located on the Reports Menu > Central Office (StateWide Reports) > Estimates Tab of the [State Construction Office Construction \(SCOC\)](#) application. Export the file to a Microsoft Excel or PDF and save this report to a hard drive. When the report is opened in Excel, the PA can edit the document to provide the justifications needed. The report will generate all pay items on a contract, but one cannot edit a report in the Construction Dashboard System. [Attachment 5-11-3](#) shows an example of an **Over Runs – Under Runs Report** exported to Excel and edited to comply with the current requirements below.

Guidelines for documenting and submitting explanations of overruns and underruns:

- (a) Each contract item's overrun/underrun will be summarized from the brief notes and remarks recorded in the Plan Summary Box at the time the final quantities are calculated.
- (b) Explanations for Federal Aid participating, and non-participating items must be shown separately.
- (c) Contracts that include more than one project will have the overrun and underrun explanations broken down for each project.
- (d) **Supplemental Agreements** that alter the original plan quantities more than \$10,000.00 should be tabulated as explanations of overruns and underruns for the appropriate items.

- (e) Initial Contingency Pay Items will be explained with the descriptions of each **Work Order** written against the initial Contingency Pay Item.
- (f) **Contingency Supplemental Agreements (CSA)** added to the contract to provide additional funding for unforeseen additional work will be explained with the descriptions of each **Work Order** written against each **CSA**.
- (g) These explanations are to be submitted with the **Final Estimates Documentation**. The DFEM will submit to the Federal Highway Administration (FHWA) on all FHWA Projects of Corporate Interest (PoCI) and on those FHWA Projects of Division Involvement (PoDI) when identified in the project specific PoDI plan.
- (h) Final quantities are subject to change during the checking of the final estimate. This may also necessitate a change or correction in the explanation of an overrun or underrun. Therefore, the original electronic version sent to the DFEM will be plainly marked as tentative.

NOTE: Requests for additional funding must be based on project reviews and overrun estimates. See **CPAM Section 7.3.6.4** that covers this process.

(D) Form 700-050-28, Final Estimates Office Record of Final Plans and Documents

This form was developed to aid in organizing and completing the transmittal packages. The RO's project personnel are responsible for initiating this form for all **Final Estimates Documents**. This form is generated by accessing the Department's **Final Estimate Status** application located on the **Construction Automated Reporting System (CARS)** menu, which is found on the Construction Office's internal website. The majority of items below will be populated automatically within the form (provided the information is input properly into PrC). If data is incorrect or errors are found, the PA can make corrections in PrC.

- (1) Financial Project ID, Contract ID, Contract Type, FDOT Specifications Year, Federal Aid Project Number(s), County(ies), Road Number(s), Name(s) of Contractor(s), Name of Surety, District Engineer, and RE/PA.

- (2) Contract Time shown in calendar days with Federal Aid Participation noted, including; Granted Days, Time Extensions, Calendar Days Allowed, Calendar Days Elapsed, Calendar Days Overrun or Underrun, and associated liquidated damages, penalties and/or incentive dollar amounts (if applicable).
- (3) Supplemental Agreements (SAs)/Work Orders, Contingency SAs and a statement of Contract Monies.
- (4) Other dates such as Plans Received date, Certification of Compliance with Specifications & Plans, Certification of Materials, Notification of Findings Letter(s), Acceptance Letter(s), Overpayment Letter, etc. will be automatically generated by PrC.

The RO will be responsible for inputting additional information that is not automatically generated by PrC including but not limited to the Resident Engineer, CCEI company name and any adjustments to the contract time. Once all information has been completed the DFEO will “validate” this form which then is automatically transferred to EDMS for retention.

(E) Form 700-050-38, Certification as to Accuracy of Final Payment

On CCEI contracts, the Resident Engineer must certify the accuracy of the final estimate amount submitted to the Department. This certification is for the contract as a whole (all FINs) and the amount certified should match the amount shown on the **Form 700-050-10, Pay Item Summary and Certification Sheet** as well as the final estimate.

(F) Job Correspondence

All correspondence related to final estimates and/or final pay quantities on each project and maintained by the RO must be submitted along with the **Final Estimates Documents**. Each document must be entered into EDMS. Documents used to substantiate a final pay quantity will be referenced by EDMS document number where appropriate (i.e., Pay Item Summaries, **Final As-Built Plans, Form 700-050-10, Pay Item Summary and Certification Sheet**, and Final Plans and Estimate Transmittal).

All pertinent correspondence that is received by the PA after the **Final Estimates Documents** are turned in must be forwarded to the DFEO for inclusion in with the Job Correspondence in EDMS.

5.11.9 Notification of Findings

If the DFEO finds discrepancies or errors in the final estimate during the Post Audit Review (PAR), the contractor will be sent a **Notification of Findings (NOF)** detailing the changes. The Contractor has a right to accept or reject any or all the changes listed in the NOF.

The Senior Project Engineer and PA will be contacted and given the chance to answer the PAR findings (monetary and/or procedural). The response will detail corrections to improve the Final Estimates Process in a positive manner.

NOTE: If an overpayment is found based on the PAR, the DFEO responsible for that contract is responsible for recovering the funds due the Department.

5.11.10 General Liability Claims: Processing Insurance Claims against the Contractor's General Liability Insurance

Insurance claims are covered under the Contractor's general liability insurance. Such claims include personal injury, damage to vehicles in an area under construction, over spray on a vehicle due to bridge painting, structural damage to a home due to pile driving, etc. These types of claims will be referred to the Contractor for attention. The particulars of the claim will be sent to the Investigations Supervisor of the Office of General Counsel at <mailto:dotclaims.review@dot.state.fl.us>. (See [Attachment 5-11-2](#) for Sample **Letters 5-11-9** and **5-11-10** following this Chapter). To assist Department employees in processing and forwarding such claims, the Office of the General Counsel has developed **General Liability Claim Procedure 225-085-001**. The guidelines and requirements established in this procedure become a basis for assessing accountability and to assist the Office of General Counsel and the Department of Insurance in processing these claims. This procedure may be obtained from the Office of General Counsel.

5.11.11 Attachments

- [Attachment 5-11-1](#) Notice of Outstanding Documents
- [Attachment 5-11-2](#) Final Estimates Boilerplate Letters
- [Attachment 5-11-3](#) Explanation of Overruns and Underruns
- [Attachment 5-11-4](#) Non-Asphalt Base Partial Payment Examples

Attachment 5-11-1 Notice of Outstanding Documents



Florida Department of Transportation
605 Suwannee Street
Tallahassee, FL 32399-0450

RON DESANTIS
GOVERNOR

KEVIN J. THIBAUT, P.E.
SECRETARY

January 1, 2021

Mr. Contractor, Inc.
2000 Sunshine Lane
Any Town, Florida 32308

RE:
Federal Aid Project Number: MY-M-6234(8)
Final Project ID: 1979341 52 02
Contract Number: T3103
County: Leon

Ladies and Gentlemen:

Before the final estimate can be finalized, and the offer made to you, the following information, as required in Section 9-8.1 of the Specifications, must be submitted to this office.

1. Mill Test and Analysis Report
2. Federal Wage Rate Affidavit
3. Construction Compliance with Specifications and Plans Certification Form

Your cooperation in quickly submitting any outstanding documents will expedite the processing of closing out this contract.

Very Truly Yours,
J.C. Long
J.C. Long
Resident Office

Attachment 5-11-2 Boilerplate Letters

Final Estimate Boilerplate Letters can be found on the [State Final Estimate SharePoint site](#) (Internal Use Only) in editable format.

NOTE: The letters are used to convey necessary information to concerned parties throughout the close out process. The letters and memos are templates containing common boilerplate language. The DFEO representative will choose the appropriate paragraphs for a specific contract and delete the paragraphs and instructions which do not apply. No boilerplate letter can cover all situations that might arise. Occasionally, it may be necessary to insert additional paragraphs drafted to fit the circumstances arising on a specific contract (such as addressing bonds or value-added items).

OFFER LETTERS:

Offers of Final Payment

- Letter 5-11-01** Offer of Final Payment (Single Project)
Letter 5-11-02 Offer of Final Payment
.....(Single Project - DB-Finance & Build Finance Projects ONLY)
Letter 5-11-03 Offer of Final Payment (Multiple Projects)
Letter 5-11-04 Offer of Final Payment
.....(Multiple Projects - DB-Finance & Build Finance Projects ONLY)

Requests for Refund

- Letter 5-11-05** Request for Refund (Single Project)
Letter 5-11-06 Request for Refund (Multiple Projects)

ACCEPTANCE LETTERS:

- Letter 5-11-07** Acceptance Letter for Offer of Final Payment
Letter 5-11-08 Acceptance Letter for Request for Refund

GENERAL LIABILITY CLAIM LETTERS:

- Letter 5-11-09** Property Damage Claim Acknowledgement
Letter 5-11-10 Notice of Property Damage Claim (to Contractor)

TIME NOTICE LETTERS:

- Letter 5-11-11** Notice of Project Beginning Memo
Letter 5-11-12 Notice to Proceed

CLOSEOUT LETTERS:

Letter 5-11-13 LFA/UWHCA Closeout

GUIDANCE LETTERS:

Letter 6-1-A Unpaid Bill to Suppliers and/or Subcontractors (1st Tier)

Letter 6-1-B Unpaid Bill to Suppliers and/or Subcontractors

Letter 6-1-C Unpaid Bill to Suppliers and/or Subcontractors (1st Tier)

Attachment 5-11-3 Explanation of Overruns and Underruns

											
Date: January 14, 2021											
Page: 1 of 1											
STATE CONSTRUCTION OFFICE											
Over/Under Runs											
Contract Details											
Contract: T2513 District: 02 Project: 42975125201 FAP: 29553071											
Pay Item	Description	Unit	Original Quantity	InstQty	Quantity Paid	Amount Paid	SA Amount	Unit Price	Change In Quantity	Quantity %	Change In Amount
0110 4	REMOVAL OF EXISTING CONCRETE PAVEMENT	SY	1391.000	802.000	802.000	\$19,248.00	\$.00	\$24.00	-589.00	-42.34	-\$14,136.00
Explanation: The underrun was a result of removing on ly the necessary amount of existing slope pavement to construct the concrete gravity wall. All removal areas were field measured and documented on lat/dat sheets.											
0334 1 13	SUPERPAVE ASPHALTIC CONC, TRAFFIC C	TN	4891.200	4217.800	4217.800	\$430,215.60	\$.00	\$102.00	-673.40	-13.77	-\$68,686.80
Explanation: The underrun was a result of placing the overbuild asphalt necessary to correct the cross slopes on SR 208 and the adjacent ramps as depicted in the Contract Plans.											
0337 7 43	ASPHALT CONCRETE FRICTION COURSE,TRAFFIC C, FC-12.5,	TN	2515.900	2637.000	2637.000	\$316,440.00	\$.00	\$120.00	121.10	4.81	\$14,532.00
Explanation: The overrun was a result of placing the friction course as depicted in the Contract Plans and within the allowable spread rate tolerances of up to 105% of the project average spread rate target.											

Attachment 5-11-4 Non-Asphalt Base Partial Payment Examples

(A) Example (1): Two Lifts (6" Lift and 6" Lift)

Given:

Non-asphalt Optional Base PQ Area = 1500 SY

Plan thickness = 12"

1st Lift:

$$\text{Partial Pay Area} = 1500 \text{ SY} \times \frac{6''}{12''} = 750 \text{ SY}$$

2nd Lift:

$$\text{Partial Pay Area} = 1500 \text{ SY} \times \frac{6''}{12''} = 750 \text{ SY (Paid when Finished and Primed)}$$

Check: 750 SY + 750 SY = 1500 SY is the total on the pay item, then apply the thickness adjustment from Specifications 285-8 as a line-item adjustment.

(B) Example (2): Three Lifts (5" Lift, 5" Lift, 4" Lift)

Given:

Non-asphalt Optional Base PQ Area = 2500 SY

Plan thickness = 14"

1st Lift:

$$\text{Partial Pay Area} = 2500 \text{ SY} \times \frac{5''}{14''} = 892.857 \text{ SY}$$

2nd Lift:

$$\text{Partial Pay Area} = 2500 \text{ SY} \times \frac{5''}{14''} = 892.857 \text{ SY}$$

3rd Lift:

$$\text{Partial Pay Area} = 2500 \text{ SY} \times \frac{4''}{14''} = 714.286 \text{ SY (Paid when Finished and Primed)}$$

Check: 892.857 SY + 892.857 SY + 714.286 SY = 2500 SY is the total on the pay item, then apply the thickness adjustment from Specifications 285-8 as a line-item adjustment.

Section 5.12

FINAL AS-BUILT PLANS PROCESS

5.12.1 Purpose

This procedure defines the process for the Resident Office (RO), both Department and Consultant Construction Engineering and Inspection (CCEI) staff, to use when preparing **Final As-Built Plans**. The standards provided are applicable to recording final quantities, revisions, and changes during construction in the **Final As-Built Plans**, as well as detailing the process to digitally sign and seal revisions and changes, where applicable.

5.12.2 Authority

Sections 20.23(3)(a) and 334.048(3), Florida Statutes (F.S.)

5.12.3 References

Section 337.015(3), 471.025, and 668.003(3), F.S.

Rule 61G15-23 and Rule 61G15-27.001, F.A.C.

Standard Specifications for Road & Bridge Construction

Review and Administration Manual, Topic No. 700-050-05

FDOT Design Manual, Topic 625-000-002

CADD Manual, Topic No. 625-050-001

Records Management Procedure, Topic No. 050-020-025

5.12.4 General

One complete set of the original Contract Plans, digitally signed and sealed by the Engineer of Record (EOR), will be saved in the Department's collaboration site. A separate, complete set of Contract Plans will be extracted (i.e. EOR digital signature removed) and maintained in the Department's collaboration site as the **Final As-Built Plans** for each construction project.

Contents of the **Final As-Built Plans** will vary, but will always contain those sheets necessary to completely record all work performed. The **Final As-Built Plans** must include all revisions and changes, in both design and construction, that indicate precisely how the project was constructed. At the conclusion of the project, the **Final As-Built Plans** will be made available for review to the District Final Estimates Office (DFEO).

5.12.5 Digital Signing, Sealing, and Certifying for As-Built Plans

The Department requires the use of digital certificates acquired from a Public Key Infrastructure (PKI) approved provider to digitally sign documents. The PKI approved provider must be on the **Business Identity and Credentials** section of the [GSA IDManagement.gov Trust Services List](https://www.gsa.gov/IDManagement.govTrustServicesList). The digital certificate contains a unique digital ID that can be validated for authenticity. **Section 668.003(3), F.S.** defines using a certificate as a digital signature. For more information on digital signatures:

<http://www.fdot.gov/Construction/eConstruction/DigitalSignatures.shtm>

Rule 61G15.23, F.A.C. states that affixing a digital signature constitutes the signing and sealing of engineering work as defined in **Section 471.025, F.S.** The pictorial representation of the seal is not required. Affixing a digital signature can be done in two ways:

- (1) **Digitally signed** means the document is locked to prevent any modifications to the document. Modifications to the document after the digital signature is applied will invalidate the digital signature. The document must be extracted to “break” the certificate and allow editing. Contract Plans and revisions from the EOR are digitally signed.
- (2) **Digitally certified** means the document is digitally signed but will allow markups and additional digital signatures to be added without breaking the original certificate. Markups are akin to “post its” in the paper world. Markups “float on top of” the signed document and are not bound by the digital signature. Digital signatures can still be validated after markups are added. The **Final As-Built Plans** must be **digitally certified** by the responsible Professional Engineer (PE) prior to submittal to DFEO.

5.12.6 Receiving the Set of Contract Plans

(A) District Level Responsibilities

The District Construction Office is responsible for providing the Contract Plans and back-up files to the Resident Office (RO) for use during construction.

(B) Resident Level Responsibilities

Upon receipt, save the original electronic Contract Plans set to the Original Plans folder within the Department’s collaboration site. Extract the Contract Plans, separate them into the different components (if not provided by component), and save all components to the As-Built Plans folder within the Department’s collaboration site. Electronically reflect all

changes made to the contract on the extracted set of plans within the Department's collaboration site. Add all revisions to the extracted set of plans, and do not discard any pages. This extracted set of plans is the ***Final As-Built Plans*** and will be part of the ***Final Estimates Documentation***.

5.12.7 Updating the Plans after Contract Award

(A) Revisions by EOR

There are situations when it is necessary or desirable to require the modification of the Contract Plans by the EOR after a project is awarded: the Contract Plans may have contained errors or omissions; field conditions may have changed; or the scope of the project may have been revised. Once the EOR has provided the electronically revised sheet(s) to the District, it is the responsibility of the Resident Engineer to ensure the sheet(s) are saved in the collaboration site. The revised sheets will be extracted from the signed and sealed file and inserted into the ***Final As-Built Plans*** file. The original sheet(s) will be voided. A Contract modification will be issued to incorporate revised plans into the contract per ***CPAM 7.3*** and ***7.4***.

(B) Changes by Resident Office

Once all changes are reflected on the ***Final As-Built Plans*** (the extracted set of plans from [CPAM Section 5.12.6\(B\)](#)), the responsible Engineer will "**flatten**" the changes to incorporate them into the document. The responsible PE will **digitally certify** the document to sign and seal the ***Final As-Built Plans***. By certifying the document, it allows the DFEO to apply markups during the Post Audit Review (PAR). The markups applied by the DFEO are not bound by the digital signature, but "**float on top**" of the ***Final As-Built Plans***.

When the responsible PE makes changes to the Contract Plans that reflect the as-built conditions of a project, the responsible PE is not considered a "successor engineer". There is no requirement that the same PE who designs the project must perform the as-built services, therefore, a PE who only prepares, and digitally signs and seals the as-built drawings is not a "successor engineer" as discussed in ***Rule 61G15-27.001, F.A.C.*** and need not follow the provisions of that Rule.

For changes not made by the EOR, the proper statement of disclaimer is required on the ***Final As-Built Plans***. The statement will be added to the ***Final As-Built Signature Sheet(s)***. This language should note that, by signing and sealing the disclaimer, the responsible PE is only taking responsibility: (1) for the changes in the plans and not the entire set of plans; (2) and for the specific change(s) only shown in redline, not for the entire page.

(1) Disclaimer to use when changes have been made:

"The above-named professional engineer shall be responsible for the following changes, indicated in redline revision, in accordance with Rule 61G15-23.004, F.A.C. This project was constructed in substantial compliance with these plans as provided by the Engineer of Record."

(2) If **Final As-Built Plan** sets have no changes, the responsible PE will digitally sign and seal the **Final As-Built Signature Sheet(s)** with a disclaimer that states:

"This project was constructed in substantial compliance with these plans as provided by the Engineer of Record. These plans reflect "as-built" conditions, and no changes were made to the plan sheets."

If the RO chooses to use CADD to make changes, the requirements in this chapter, and the **CADD Manual** must be met. Use the cloud revision utility from the Bar Menu in MicroStation or other mark-up tools in other software. The **CADD Manual, Section 5.7** describes the process of generating the proper naming convention and standards for updating the CADD files electronically. If changes are performed other than by cloud revision, such as completely manipulating the native CADD file, all changes must conform to the same procedures and requirements outlined in the **CADD Manual, Chapters 2, 4, and 5** and the **FDM Chapters 130, 131, and 132**. After the native CADD file has been revised to reflect as-built conditions, provide a PDF version for submittal with the **Final As-Built Plans**.

(C) As-Built Drawings by Contractor and Revisions by Contractor or Specialty Engineer

As-Built Drawings by Contractor required by the **Specifications** for miscellaneous items (such as Intelligent Transportation Systems (ITS), signals, conduit, and lighting) and revisions to the Contract Plans made by the Contractor's EOR or a Specialty Engineer must follow the criteria in the **Specifications** (including but not limited to **Section 611, 630, and 715**) and the **FDM**. Submit As-built Drawings and revisions in PDF format. It is recommended that As-built Drawings required by the **Specifications** be entered into EDMS and the EDMS document number be referenced on the **Final As-Built Plans** in the applicable location. Revisions to the Contract Plan sheets should be inserted in the **Final As-Built Plans** per [CPAM Section 5.12.8\(B\)](#).

5.12.8 Final As-Built Plans Process

Update the ***Final As-Built Plans*** with all additions, deletions, and changes clearly delineated to reflect the actual conditions of the project as the job progresses. Enter Quantities within 30 days of pay item closeout. Delaying updates to the ***Final As-Built Plans*** increases the risk of errors and omissions.

[Attachment 5.12-1A](#) and [Attachment 5.12-1B](#) are flow charts of the Final As-Built Plans Process.

The ***Final As-Built Plans*** will be **digitally certified**, per [CPAM Section 5.12.5](#), to allow the DFEO personnel to make comments where appropriate. No pages will be discarded from this set.

(A) Marking Conventions

Make changes electronically to the ***Final As-Built Plan*** set(s) using the following marking conventions:

(1) Resident Level Responsibilities

Project personnel use **red** line revisions. Cloud changes throughout the ***Final As-Built Plans***.

Quality Assurance project personnel use **orange** line revisions.

(2) District Level Responsibilities

Initial Reviewers during the District's Quality Control (QC) or Independent Assurance (IA) Review use **blue** line revisions.

Overviewers during the Post Audit Review (PAR) use **green** line revision.

Consultants hired, on behalf of the DFEO, use the appropriate marking conventions for the role they are supplementing. The function of the DFEO Initial Reviewer and Overviewer are detailed in the ***Review and Administration Manual, Section 3.5***.

NOTE 1: The use of layers to further differentiate markups/comments within the ***Final As-Built Plans*** PDF file(s) is encouraged, but not required. If layers are utilized, ensure layer names are appropriate for the type of mark up (i.e. position/name of personnel, such as Inspector, Contract Support Specialist, or PA) or type of review (IA, QA, QC, or PAR). (Also see requirement under [CPAM Section 5.12.8\(B\)\(2\)b](#).)

(B) Plan Set Sheets

If an entire plan sheet is revised, imprint **VOID** on the original plan sheet using **red** text and insert the new plan sheet behind the original, voided sheet in the set of **Final As-Built Plans**, with exception of the **Key Sheet**. Insert the revised **Key Sheet(s)** in front of the voided **Key Sheet(s)**. All revised sheets will be defined on the **Key Sheet(s)** of the appropriate component.

(1) The Key Sheet

The **Key Sheet** of each component of **Final As-Built Plans** must show the following data (see [Attachment 5.12-2](#) for example **Key Sheet**):

- (a) Line through or delete the “Contract Plans” preprinted line and imprint **Final As-Built Plans** prominently in **red** across the top of the sheet.
- (b) Display the following information on the right side and near the lower corner in red ink on the **Key Sheet**:
 - (i) Name of Prime Contractor
 - (ii) Name of Prime Consultant Construction Engineering Inspection (CCEI) (If In-House Project, so state)
 - (iii) Name of District Secretary (at time of final acceptance)
 - (iv) Name of Resident Engineer
 - (v) Name of FDOT Project Manager
 - (vi) Name of Project Administrator
 - (vii) Date Work Started
 - (viii) Date of Final Acceptance
- (c) Display a complete **Component Index** of the documents (with corresponding EDMS document numbers) related to the plan component on the left side of the **Key Sheet**, **not to exclude the following**:
 - (i) Additional plans, such as shop drawings, etc.
 - (ii) Other As-Built Drawings, such as Jack & Bore, Boring Path Reports, Bore Logs, Plowing, or Signalization will be listed as well.

- (iii) All project descriptions, Financial Project ID Numbers, length, etc., shown on the **Key Sheet** will be corrected to agree with the actual construction.

NOTE 2: It is the responsibility of the Resident Engineer to ensure Boring Path Reports meet the requirements of the **Specifications** prior to acceptance and payment.

(2) The Design and Final As-Built Signature Sheet

Insert **Final As-Built Signature Sheet(s)** in each plan component behind the respective **Key Sheet(s)**. [Attachment 5.12-3](#) is an example **Final As-Built Signature Sheet**. The **Final As-Built Signature Sheet** can be downloaded from the State Construction As-Built Plans website at:

<http://www.fdot.gov/construction/eConstruction/AsBuiltPlans.shtm>.

If a Design Signature Sheet(s) is included in a plan component from the EOR, do not void it when inserting the **Final As-Built Signature Sheet**. Index all changes made in the field, which do not require an engineering evaluation, on the **Final As-Built Signature Sheet(s)**. **Digitally certify** and have it signed and sealed by the responsible PE. **Rule 61G15.23, F.A.C.** requires text to be included with a digital signature to indicate a document has been digitally signed and sealed. Printed copies are not considered signed and sealed. The Department's recommended signature appearance to comply with this requirement is shown in [Attachment 5.12-3](#).

- (a) The responsible engineer must include the company name and address, for each component's **Final As-Built Signature Sheet(s)**.
- (b) Show all changes to the **Final As-Built Plans** during construction for each component on the **Final As-Built Signature Sheet(s)** to include:
 - (1) Sheet number on which the change is shown in the plans
 - (2) A brief description of the change

If more space than provided is needed, an additional page(s) can be added to the **Final As-Built Plans**.

- (c) Complete the review table on the **Final As-Built Signature Sheet** as the project progresses. Ensure each person applying markups or changes to the **Final As-Built Plans** and all reviewers enter his/her name followed by the applicable position/reviewer type, the change/review date, and his/her agency/company name on the **Final As-Built Signature Sheet**. This applies to all project personnel (SPE, PA, CSS, Inspectors), all QA/QC/IA

reviewers (internal company reviews and Department reviews), and DFEO staff after final acceptance. If more space than provided is needed, an additional page can be added to the ***Final As-Built Plans***.

(3) Typical Section Sheets

Mark authorized changes to the typical section appropriately. Include documentation for such changes as part of the ***Final Estimates Documentation***. Some typical examples include:

- (a) Increase or decrease in thickness
- (b) Change in type of material
- (c) Substitution of pay items
- (d) Change in limits of work
- (e) Addition/Deletion of items of work
- (f) Other Geometric designs (such as varied cross slope)

(4) Summary of Pay Items

- (a) The ***Plan Summary Sheets*** for each of the major groups of pay items are to be included in the ***Final As-Built Plans***. Update pay item quantities on the Summary of Pay Items in the appropriate ***Pay Item Summary Box*** as detailed in ***CPAM Section 5.13***.
- (b) The original ***Estimated Quantities Report (EQR)*** and all revisions must be entered into the Electronic Document Management System (EDMS). Reference all back up documentation on ***Form 700- 050-10, Pay Item Summary and Certification***. For more information, see ***CPAM 5.13***.

(5) Plan Sheets

The ***Plan Sheet*** details for all the major groups of plans become the permanent historical record of the construction project. Clearly delineate all changes in construction that would constitute a conflict in this record on the ***Final Plan Sheets***. Insert changes and cross out all incorrect data. The following changes must be noted:

- (a) Changes to the horizontal and vertical alignments as shown on the original Contract Plans
- (b) Stations or equations introduced or revised during construction

- (c) Intersection and crossover details been modified or relocated
- (d) Inlets, manholes, box culverts, and end walls added, relocated, revised, or deleted
- (e) All sidewalk modified in thickness or otherwise, and all curb and gutter, and shoulder gutter added, revised, or deleted
- (f) All driveways not shown on the original Contract Plans; driveways shown on the original Contract Plans but removed; or driveways modified in thickness or otherwise
- (g) All ditch locations and grades adjusted during construction
- (h) Changes in fencing items, including gate location
- (i) Sign locations changed and modified pavement markings
- (j) All signal details changed during construction
- (k) All Bridge, Approach Slab, and Lighting details different from the actual construction
- (l) Add Benchmarks (BMs) set during construction and their descriptions to the profile portion of the **Plan Sheets**
- (m) Reflect all Utility relocates and/or conflicts on the **Utility Adjustment Sheets**

(6) Summary of Drainage Structures, Optional Materials Tabulation and Drainage Structure Sheets

Reflect changes on the **Final As-Built Plans** set, to include:

- (a) Plan lengths changed to reflect the actual construction length when an authorized field change is made or a plan error is noted
- (b) Show changes in flow line elevations on the **Plan Profile Sheets**
- (c) Changes in stations or offset dimensions
- (d) Changes in size of structures
- (e) Added/Deleted structures

- (f) Show the type of pipe material and thickness used at each structure on the ***Drainage Structures Sheets*** and the ***Optional Materials Tabulation Sheets***. Check the as-built column to indicate what type of pipe material and thickness was used at each structure.
- (g) Types of inlets and manholes constructed must be indicated
- (h) When the method of measurement is plan quantity for cross drain and storm sewer pipes, distinguish plan errors from field changes due to different tolerances being applicable.
- (i) ***Lateral Ditch Sheets***: Delineate all adjustments in horizontal alignment of flow line grade on the ***Plan and Profile Sheets***. Adjust the cross-section to reflect the change if a pay quantity adjustment is required.

(7) Cross-Section Sheets

The disposition of the ***Cross-Section Sheets*** in relation to a set of ***Final As-Built Plans*** depends on the method of payment set up for the earthwork items (refer to the ***Special Provisions*** of each Contract).

- (a) **Excavation Borrow Pits, Excavation Subsoil, and Excavation Channel on Cubic Yard Basis**: Prepare and include final ***Cross-Section Sheets*** and volumetric computations in the ***Final As-Built Plans***. These sheets are required to reflect the actual work accomplished and are the basis of final pay quantities. The original plan cross-sections will remain a part of the ***Final As-Built Plans***.
- (b) **Embankment, Regular Excavation, and Lateral Ditch Excavation on Cubic Yard Plan Quantity Basis**: The original design cross-sections are used as the basis for both plan and final pay quantities and to control grading operations. Retain them as part of the ***Final As-Built Plans***. Prepare additional cross-sections to correct plan errors and/or to reflect field changes and add to the ***Final As-Built Plans***. Detailed instructions pertaining to earthwork are included in ***CPAM Section 5.16***.

(8) Final As-Built Bridge Plans

The Structures Designer and Facilities Engineers need accurate bridge records available for inspection, maintenance, rehabilitation, emergency repair operations, and any future widening operations. Record and/or reference the following information on the proper matrices, plans sheets, log books, and forms for bridge projects:

- (a) For each structure, a complete As-Built load rating, or a sealed load rating summary and a letter from EOR confirming the As-Bid load ratings represent the As-Built condition. Clearly list casting dates and stressing dates for all post-tensioned concrete components in the As-Built load rating calculations. Record Load Ratings based on As-Built condition on the appropriate forms and enter into EDMS in the appropriate group and document type with structure number identified.
- (b) Record Drill Shaft Inspection records , appropriately mark as permanent record, and enter into EDMS. Reference the EDMS number within the **Final As-Built Plans**.
- (c) Record Pile Driving Log Books/Pile Driving records, appropriately mark as permanent record, and entered into EDMS. Reference the EDMS number within the **Final As-Built Plans**.
- (d) Document all crack observations on the structures either through detailed sketches or "Crack Maps". It is the responsibility of the CCEI Inspector to perform this inspection (as outlined in the **CPAM Section 10.3.5**).
- (e) Enter Shop Drawings into EDMS, and reference the EDMS number within the **Final As-Built Plans**.
- (f) Engineer approved repairs due to Request for Corrections (RFC) are not included in the **Final As-Built Plans**. For further explanation see **CPAM Section 8.11**.

Enter the above items into EDMS in the appropriate directory, and reference the EDMS document number on the **Final As-Built Plans** in the applicable location. Original documents may be turned over to the District Structures and Maintenance Engineers for their use. Ensure all documents have been reviewed for Quality Control to ensure correctness and legibility.

Update the electronic design files for the Category II (see **FDM Chapter 121** for category definitions) bridge plans to reflect as-built conditions in the native CADD format. The Districts may opt to have the appropriate EOR or the CCEI consultant perform this CADD service. Submit the plans with the **Final Estimates Documentation**. The EOR must update the bridge load ratings based on the as-built bridge plans or review load ratings submitted by the Contractor's EOR for contractor-initiated revisions per **CPAM Section 10.11**.

The RE will markup sheets requiring minor (non-engineering evaluation) as-built changes and show those changes on the **Final As-Built Signature Sheet(s)**. For major changes, the RE will send revisions back to the appropriate EOR as outlined in **FDM Chapter 131**.

Any revisions made by value engineering decisions will be digitally signed and sealed by the Contractor's EOR. This may be a Cost Savings Initiative Proposal (CSIP) redesign or an original design of certain components including Shop Drawings. The Contractor's EOR will send the signed and sealed plan revisions back to the RE for inclusion into the **Final As-Built Plan** set.

Prior to submittal of the **Final Estimates Documentation**, the electronic as-built bridge plans will be secured with a digital certification.

(9) Final As-Built Lighting Plans

Lighting details may reside either throughout the roadway plan set or within a Lighting Plans component for more complex designs. These details include project-specific information for luminaires (i.e., light fixtures) that require revision if the original plans differ from the as-built condition. This information will assist maintenance personnel with replacing luminaires and matching the original installation's design properties.

Within the Lighting Data Table (defined in [Florida Design Manual](#), Chapter 943.4), the following information must be changed to match as-built condition:

- (a) Luminaire Make/Model
- (b) Lumen Output
- (c) IES Distribution Pattern (1 through 5)
- (d) Correlated Color Temperature
- (e) Input Wattage
- (f) Input Voltage

The above changes require approval of the lighting EOR per **Standard Specifications Section 715**. If approved, these changes must be included in the As-Built Plans.

5.12.9 Design-Build Final As-Built Plans

Provide Design-Build **Final As-Built Plans** meeting the requirements of the Request for Proposal (RFP) and Design-Build Specifications to the Department. It is not necessary to apply a digital signature to each page of the Release for Construction Plans; one signature will suffice for the entire document. Any required changes to the **Final As-Built Plans** by the Department must meet the requirements found within **this section of CPAM**. The responsible Engineer will also insert the **Final As-Built Signature Sheet**, apply the appropriate statement of disclaimer per [CPAM Section 5.12.7\(B\)](#), and sign and seal the **Final As-Built Plans**.

5.12.10 Changes after Submittal of Final Estimates Documentation

(A) Resident Level Responsibilities

It will be the ROs responsibility to make any changes, required due to findings by the DFEO during the Post Audit Review (PAR), that modify the **Final As-Built Plans**. All changes will be made in accordance with this Manual.

Exception to the above: Updates to an item's quantity by the DFEO after submittal of the **Final Estimates Documentation**, with no corresponding modifications to the Plans, will not require changes or new digital signature by the RO.

5.12.11 As-Built Data Collection

(A) Final Quality Control Roadway Report (QCRR)

Asphalt As-Built Pavement Data will be collected on **Form 675-030-20A, Contractor's Quality Control Roadway Report (QCRR) - Automated Version**. The Project Administrator (PA) is responsible for submitting the final QCRR in Excel to the State Materials Office by email to SM-MACQCRRUpload@dot.state.fl.us after Final Acceptance.

The PA is responsible for ensuring errors found on the **QCRR**, after final acceptance, are corrected by the Contractor. The final **QCRR** is to be replaced with the corrected version in EDMS and resubmitted to the State Materials Office explaining the form has been revised.

(B) Intelligent Transportation System Facility Management (ITSFM)

The PA is responsible for obtaining Feature Import Templates (as required in **Specifications 611-2.3**) from the Contractor for review, acceptance, and submittal to the District Traffic Operations with the As-Built Plans for entry into the Department's ITSFM system. Enter applicable correspondence in EDMS.

(C) Approved Product List (APL)

The PA is responsible for ensuring all APL data is entered into the Materials Acceptance and Certification (MAC) System and the information is complete and accurate. It is required that APL data be entered at the time of installation. APL data is required to be entered into the MAC prior to approval of each monthly estimate. Please contact the [Product Evaluation Office](#) for more information on required APL tracking.

5.12.12 Final As-Built Plans Handling Process

(A) District Level Responsibilities

After the final close-out/PARs, ensure all required documents are included in the electronic files in EDMS.

Keep projects pending litigation available until they are finalized.

Adhere to the Department’s procedure for Record Retention as outlined in the ***Records Management Procedure, Topic No. 050-020-025***.

5.12.13 Attachments

[Attachment 5.12-1A](#)Final As-Built Plans Process (Resident Office)
[Attachment 5.12-1B](#) Final As-Built Plans Process (District Final Estimates Office)
[Attachment 5.12-2](#)Key Sheet
[Attachment 5.12-3](#)Final As-Built Signature Sheet

Attachment 5.12-1A FINAL AS-BUILT PLANS PROCESS Resident Office

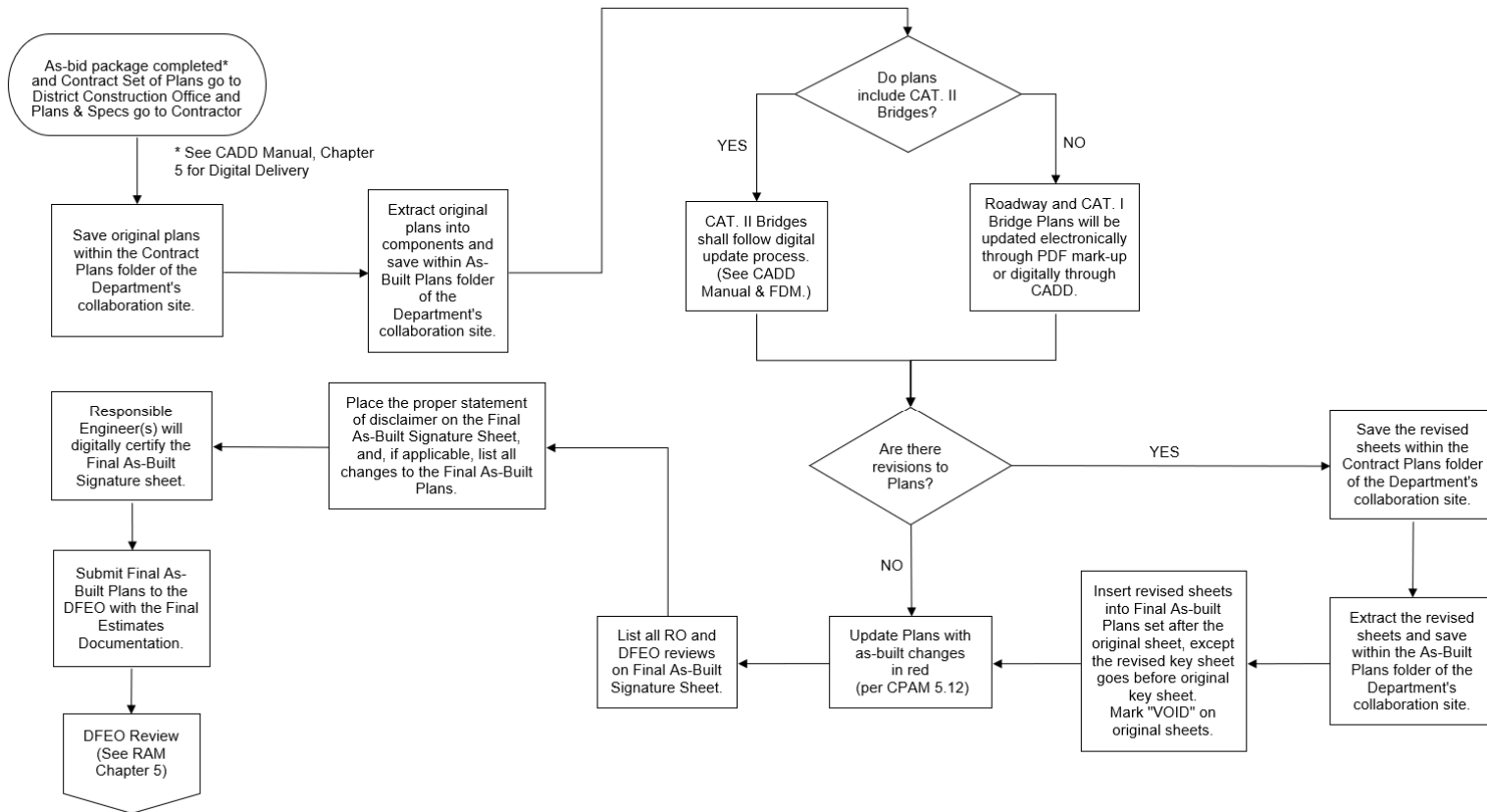

Attachment 5.12-1B FINAL AS-BUILT PLANS PROCESS District Final Estimate Office

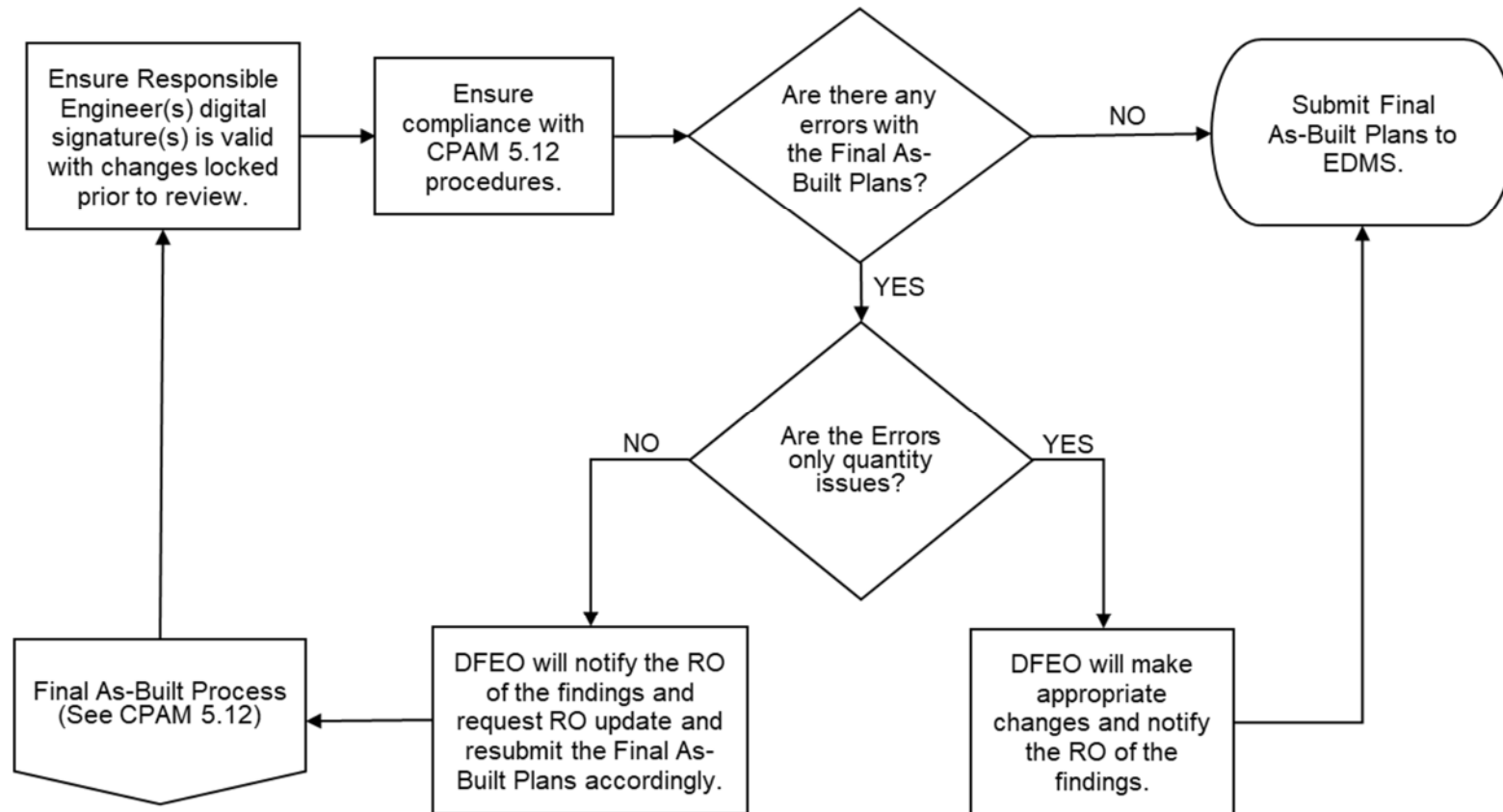

Attachment 5.12-2 KEY SHEET

STATE OF FLORIDA
 DEPARTMENT OF TRANSPORTATION

FINAL AS-BUILT PLANS
~~CONTRACT PLANS~~

FINANCIAL PROJECT ID 431278-1-52-01
 (FEDERAL FUNDS)
 POLK COUNTY (16030 AND 16030-301)
 STATE ROAD NO. 35/555

CONSTRUCTION CONTRACT NO. T1623

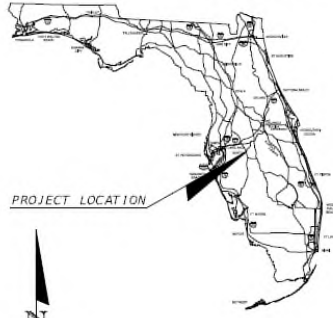

PROJECT LOCATION

COMPONENTS OF CONTRACT PLANS SET

ROADWAY PLANS
 SIGNING AND PAVEMENT MARKING PLANS
 SIGNALIZATION PLANS

A DETAILED INDEX APPEARS ON THE KEY SHEET OF EACH COMPONENT

INDEX OF ROADWAY PLANS

SHEET NO.	SHEET DESCRIPTION
1	KEY SHEET
2-3	SIGNATURE SHEET
4	SUMMARY OF PAY ITEMS
5	TYPICAL SECTION
6	TYPICAL SECTION DETAILS
50-1 - 50-47	SUMMARY OF QUANTITIES
7 - 8	SUMMARY OF DRAINAGE STRUCTURES
9	OPTIONAL MATERIALS TABULATION
10 - 11	BENCHMARKS
12 - 13	REFERENCE POINTS
14	PROJECT NOTES
15 - 40	ROADWAY PLAN
41 - 42	DRAINAGE STRUCTURES
43 - 44	DRAINAGE DETAILS
45 - 47	DRIVEWAY CROSS SECTIONS
48 - 50	STORMWATER POLLUTION PREVENTION PLAN
51 - 65	TEMPORARY TRAFFIC CONTROL PLAN
66 - 67	SUMMARY OF VERIFIED UTILITIES
68 - 71	POTENTIAL CONTAMINATION SITES

LIST OF REVISED INDEX DRAWINGS

INDEX NO.	SHEET NO.
600	1+2 OF 12
619	1+2 OF 2
11200	2 OF 3
11860	4 OF 8
17302	1 OF 1
17346	1+2 AND 13-14
17347	1+3 OF 5
17727	2 OF 2
17841	1 OF 1

RAILROAD CROSSING NO. 624492-H
 (SR 35/ SR 555)
 CSX TRANSPORTATION, INC.
 400P SV 451.17
 STA. 658+00.00 @ SURVEY SR 35/ SR 555

COMPONENT INDEX

JACK AND BORE AS-BUILT DRAWINGS EDMS DOC # _____
 SIGN SHOP DRAWINGS EDMS DOC # _____

GOVERNING STANDARDS AND SPECIFICATIONS:
 Florida Department of Transportation, 2013 Design Standards and revised Index Drawings as appended herein, and July 2015 Standard Specifications for Road and Bridge Construction, as amended by Contract Documents.
 For Design Standards click on the "Design Standards" link at the following web site:
<http://www.dot.state.fl.us/rddesign/>
 For the Standard Specifications for Road and Bridge Construction click on the "Specifications" link at the following web site:
<http://www.dot.state.fl.us/specificationsoffice/>

END EXCEPTION
 STA. 668+44.33
 MP 0.323

BEGIN EXCEPTION
 STA. 666+02.69
 MP 0.269

BEGIN PROJECT (16030000)
 STA. 548+37.23
 MP 15.959

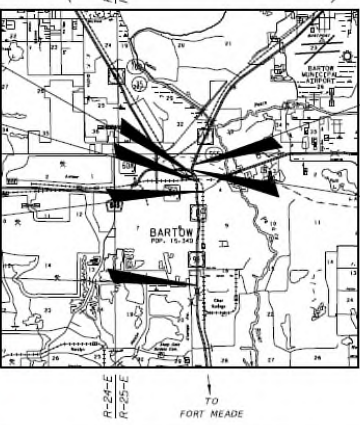

TO HIGHLAND CITY

TO EAGLE LAKE

TO LAKE WALES

TO FORT MEADE

TO MULBERRY

END PROJECT (16030000)
 STA. 684+38.74
 MP 18.532

BEGIN PROJECT (16030301)
 STA. 678+63.33 =
 STA. 98+16.05
 MP 0.508 END (16030301)
 MP 18.423 BEGIN (16030000)

ROADWAY SHOP DRAWINGS TO BE SUBMITTED TO:
 ANDRA G. DIGGS II, P.E.
 FLORIDA DEPARTMENT OF TRANSPORTATION
 DISTRICT ONE OFFICE
 801 N. BROADWAY AVENUE
 BARTON, FL 33830-3809

PLANS PREPARED BY:
 FLORIDA DEPARTMENT OF TRANSPORTATION
 DISTRICT ONE OFFICE
 801 N. BROADWAY AVENUE
 BARTON, FL 33830-3809
 (863) 519-2300

NOTE: THE SCALE OF THESE PLANS MAY HAVE CHANGED DUE TO REPRODUCTION.

NAME OF PRIME CONTRACTOR: _____
 NAME OF PRIME CONSULTANT: _____
 DISTRICT SECRETARY: _____
 RESIDENT ENGINEER: _____
 FDOT PROJECT MANAGER: _____
 PROJECT ADMINISTRATOR: _____
 DATE WORK STARTED: _____
 DATE WORK FINAL ACCEPTED: _____

ROADWAY PLANS
 ENGINEER OF RECORD: MELISSA W. GRIMES, P. E.
 P.E. NO.: 72156

LENGTH OF PROJECT		
	LINEAR FEET	MILES
ROADWAY	13,433.36	2.544
BRIDGES	0.000	0.000
NET LENGTH OF PROJECT	13,433.36	2.544
EXCEPTIONS	168.15	0.032
GROSS LENGTH OF PROJECT	13,601.51	2.576

KEY SHEET REVISIONS	
DATE	DESCRIPTION

FDOT PROJECT MANAGER: M. WAYNE SHELTON

NOTICE: THE OFFICIAL RECORD OF THIS SHEET IS THE ELECTRONIC FILE STORED AND SEALED UNDER RULE 6103-21-003, F.A.C.

Attachment 5.12-3 FINAL AS-BUILT SIGNATURE SHEET

Ashley W Anderson
Digitally signed by Ashley W Anderson
 Date: 2019.10.07 09:38:21 -04'00'

STATE OF FLORIDA, PROFESSIONAL ENGINEER, LICENSE NO. 123456

THIS ITEM HAS BEEN DIGITALLY SIGNED AND SEALED BY Ashley Anderson, PE ON THE DATE INDICATED HERE

PRINTED COPIES OF THIS DOCUMENT ARE NOT CONSIDERED SIGNED AND SEALED AND THE SIGNATURE MUST BE VERIFIED ON ANY ELECTRONIC COPIES.

FLORIDA DEPARTMENT OF TRANSPORTATION
 605 SUWANNEE STREET
 TALLAHASSEE, FL 32303
 ASHLEY ANDERSON, P. E. NO. 99999

This project was constructed in substantial compliance with these plans as provided by the Engineer of Record. These plans reflect "as-built" conditions and no changes were made to the plan sheets.

Digital Signature

**Signature Appearance
 (including Engineer Name and Address)**

Statement of Disclaimer

List of Responsible Sheets

Reviewer Information

Ashley W Anderson
Digitally signed by Ashley W Anderson
 Date: 2020.02.12 12:36:26 -05'00'

STATE OF FLORIDA, PROFESSIONAL ENGINEER, LICENSE NO. 99999

THIS ITEM HAS BEEN DIGITALLY SIGNED AND SEALED BY Ashley Anderson, PE ON THE DATE INDICATED HERE

PRINTED COPIES OF THE DOCUMENT ARE NOT CONSIDERED SIGNED AND SEALED AND THE SIGNATURE MUST BE VERIFIED ON ANY ELECTRONIC COPIES.

ROADWAY ENGINEERS, INC.
 123 MAIN STREET
 TALLAHASSEE, FL 32303
 ASHLEY ANDERSON, P. E. NO. 99999

The above named professional engineer shall be responsible for the following changes, indicated in redline revision, in accordance with Rule 61G15-23.004, F.A.C. This project was constructed in substantial compliance with these plans as provided by the Engineer of Record.

ROADWAY PLANS

SHEET NO.	DESCRIPTION OF CHANGE
1	PROJECT DETAILS
4-6	BASE THICKNESS CHANGED
SQ1-25	ADDED FINAL QUANTITIES
34	AS-BUILT OPTIONAL MATERIALS INDICATED
66	SIDEWALK REALIGNMENT

SIGNING & PAVEMENT MARKING PLANS

S2-S4 ADDED FINAL QUANTITIES

NO CHANGES

WITH CHANGES

Date	Name	Position (Title)	Review Type, If Applicable
RESIDENT OFFICE			
10/25/2017	Jane Doe	30% Review	QA
10/16/2018	John Doe	60% Review	QA
10/31/2019	Joe Smith	60% Review	QA
	Jimmy Smith	Inspector	
	Jill Brown	Contract Support Specialist	
	Ashley Anderson	Senior Project Engineer	
DISTRICT OFFICE			
11/06/2018	Peter Piper	IA Review (Jill Brown)	
11/06/2019	Peter Piper	60% Review	QC OTHER

REVISIONS				ROADWAY ENGINEERS, INC.	STATE OF FLORIDA DEPARTMENT OF TRANSPORTATION			SHEET NO.
DATE	DESCRIPTION	DATE	DESCRIPTION	123 MAIN STREET TALLAHASSEE, FL 32303	ROAD NO.	COUNTY	FINANCIAL PROJECT ID	
					999	LEON	123456-1-02-01	2A

Section 5.13

PLAN SUMMARY BOXES/ESTIMATED QUANTITIES REPORT

5.13.1 Purpose

This chapter provides instructions for the Department's Construction personnel in charge of compiling and documenting the information necessary to substantiate the final pay quantities as it relates to the **Plan Summary Boxes** and **Estimated Quantities Report (EQR)**, as well as **Form 700-050-10, Pay Item Summary and Certification**.

5.13.2 Authority

Sections 20.23(3) (a) and 334.048 (3), Florida Statutes (F.S.)

5.13.3 References

Sections 337.11(10), 337.145(1) (2) and 334.044(30), F.S.

FDOT Design Manual

Review & Administration Manual

Computer Aided Design and Drafting (CADD) Manual

Structures Manual

Basis of Estimates (BOE) Manual

5.13.4 General Information

The **Plan Summary Boxes** were created to replace the Computation Book and are located on the Summary of Quantity Sheets in the **Final As-Built Plans**. For Design requirements regarding the **Plan Summary Boxes**, please see the **FDOT Design Manual (FDM) Chapter 307** and **CADD Manual, Chapter 8**.

The **Estimated Quantities Report** was created to replace **Plan Summary Boxes** for NexGen Plans development. This is a standalone report that provides pay item information previously found in the **Plan Summary Boxes** and on plan sheets. For Design requirements regarding the **EQR**, please see the **FDM Chapter 902** and **CADD Manual Chapter 8**.

A list of all the **Plan Summary Boxes**, **EQR tables**, and their descriptions is available in the **Basis of Estimates (BOE) Manual, Chapter 8**. Design requirements for bridge projects can be found in the **Structures Manual**. Also see the **FDOT Design Manual** for further requirements.

5.13.5 Resident Office (RO) Responsibilities

The Resident Office will track quantities each month and reconcile quantities in AASHTOware Project Construction (PrC) within 30 days of pay item closeout. Document all changes in quantities and enter backup documentation into EDMS per **CPAM 5.14** and **CPAM 5.15**. Ensure supporting documentation for quantities is available once payment is made per **CPAM 2.2**.

(A) Quantity Verification

Spot check original quantities. If a dispute arises before or during the construction of a project involving quantities, address and correct the quantities in the following manner:

- (1) Errors of Minor Nature:
 - (a) Example: If the EOR reported 100 LF of curb and gutter rather than the actual quantity of 1,000 LF.
 - (b) In this case, a simple correction will suffice.
- (2) Errors of Major Nature:
 - (a) Example: If the EOR omitted the southwest quadrant of an intersection.
 - (b) Send a written request asking the EOR to submit detailed documentation or verification of the concern for the quantity in question, per the **BOE Manual, Chapter 8**. The EOR is required to submit the supporting documentation within five (5) business days of the request.

(B) Quantity Totals Precision and Rounding

A standard method of calculation has been established for all estimating functions to be consistent. When calculating final quantities, use the precision for each unit of measure and standard rounding rules identified in the **BOE Chapter 2.2**.

Use all decimals when calculations are generated automatically from a computer application, then use common rules to round to the appropriate precision for final payment. Manual calculations should be performed using one additional significant figure, then use common rules to round to the appropriate precision for final payment.

(C) Plan Summary Boxes

The Resident Office has the following responsibilities regarding **Plan Summary Boxes**:

- (1) Ensure all revised **Plan Summary Boxes** are included in the **Final As-Built Plans** per **CPAM 5.12**.
- (2) Ensure all **Plan Summary Boxes** are updated with all additions, deletions, and changes to reflect the actual conditions of the project within 30 days of pay item closeout per **CPAM 5.12.8**. Place a red check mark in the final quantities column when there are no changes to the contract quantity. Enter the final quantity when the contract quantity differs from the final quantity.
- (3) Use red font color for any markups.
- (4) Reference all backup documentation by EDMS number in the Remarks column.
- (5) Use the Excel spreadsheets included in the **CADD_[FPID].zip** or **BIM [FPID].zip file**, in the **Calculations** directory (see Figure 1) to add a new **Plan Summary Box** to the **Final As-Built Plans**. Refer to the CADD Manual. See [Attachment 5.13-1](#).

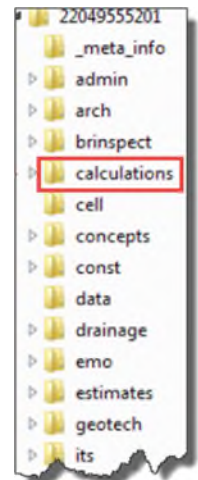

Figure 1 -
CADD_[FPID].zip

(D) EQR

The Resident Office has the following responsibilities regarding the **EQR**:

- (1) Ensure the original EQR and all revisions are uploaded into EDMS.

- (a) It is not required to update the EQR to create a “Final” Estimated Quantities Report.
 - (b) The Responsible Engineer is not required to sign and/or seal the EQR.
 - (c) An EQR Excel file is an optional tool for the RO to track all changes. When used, merge revised EQRs and add field changes to the spreadsheets. The EQR Excel file can be found within the **CADD_[FPID].zip** or **BIM [FPID].zip file**. See [Attachment 5.13-2](#). Enter the updated EQR Excel file(s) in EDMS and reference when used.
- (2) Reference all back up documentation by EDMS number on **Form 700-050-10, Pay Item Summary and Certification Sheet**. See **CPAM 5.13.7**.

5.13.6 Form 700-050-10, Pay Item Summary and Certification

(A) Resident Office Responsibility

Generate **Form 700-050-10, Pay Item Summary and Certification** at the end of the project to incorporate all the necessary data, such as pay items, quantities, adjustments, Supplemental Agreements (SAs), and Work Orders (WOs). Submit this document with the **Final Estimates Documentation**. The steps below explain how to locate this form:

- Access the [State Construction Office Construction application](#)
- Login
- Select Reports
- Select Central Office (Statewide Reports)
- Select the Estimates tab
- Select Pay Item Summary and Certification Report

To create the report, enter the contract number, select the desired output format (i.e., PDF or Excel) and select **Get. Form 700-050-10, Pay Item Summary and Certification** will be generated by obtaining data from PrC. Ensure all information is correct and reference all appropriate backup documentation in the **EDMS Doc/Page #** column.

The Final Estimates Level 2 qualified staff (typically the Project Administrator (PA) and/or Contract Support Specialist), the PA, and the Resident Engineer will sign to certify the accuracy of the final quantities. See [Attachment 5.13-3](#).

(B) District Office Responsibility

The District Final Estimates Office staff will sign **Form 700-050-10, Pay Item Summary and Certification** and upload into EDMS after reviewing the **Final Estimates Documentation**. See [Attachment 5.13-3](#).

5.13.7 Attachments

[Attachment 5.13-1](#) Updated Plan Summary Box
[Attachment 5.13-2](#) Estimated Quantities Report
[Attachment 5.13-3](#) Form 700-050-10, Pay Item Summary and Certification

ATTACHMENT 5.13-1 Updated Plan Summary Box

Any field changes should be noted in red. Reference backup documentation EDMS numbers in Construction Remarks columns.

SUMMARY OF EARTHWORK					
PAY ITEM NO.	PAY ITEM DESCRIPTION	CY		DESIGN NOTES	CONSTRUCTION REMARKS
		P	F		
0120 1	REGULAR EXCAVATION				
	SR 600	1668.00			
	TOTAL:	1668.00	1830.00		See EDMS # 1165422, pages 8 and 18. See plan sheet 27A for details on SQ-6A, Plan Quantity Analysis.
0120 5	CHANNEL EXCAVATION				
	LAKE PARKER DRAINAGE	507.00	864.00		
	SADDLE CREEK	1080.00	969.00		
	TOTAL:	1587.00	1833.00		EDMS # 1169176 for Lake Parker Drainage, and EDMS # 1169178 for Saddle Creek.
0120 6	EMBANKMENT				
	SR 600	3178.00			
	STA. 1231+99.10 to STA. 1232+48.38 (RT./LT.) BOX CULVERT	3364.00			
	STA. 1233+01.38 to STA. 1233+42.44 (RT./LT.) BOX CULVERT	2699.00			
	TOTAL:	9241.00	9381.00		See EDMS # 1165422, pages 8 and 18. See plan sheets 27A and 27B for details on SQ-6B. Plan Quantity Analysis.

Use a red checkmark to indicate quantities are unchanged. Use an arrow to indicate a range of unchanged quantities.

SUMMARY OF PERFORMANCE TURF-SOD								
CHAIN	SIDE	P			F			FIELD BOOK REFERENCE
		L	W	SY	L	W	SY	
△ CONST.-SR 10				119647.9				✓
△ DEMPSEY MAYO RD.				801.3				
△ CHURCH DRIVEWAY				158.1				
△ TAYLOR RD.				205.3				
△ HIGHLAND DR.				219.1				
△ EDENFIELD RD.				1093.5				
△ PEDRICK RD.				2146.5				
△ CHAMPAGNE DR.				585.5				
△ VINEYARD WAY				167.2				
△ ARENDELL WAY				139.1				
△ WINERY WAY				159.6				
△ THORNTON RD.				428.8				
△ POND 1				37768.7				
△ DRAINAGE STRUCTURES				550.0				
△ SUB TOTAL:				164070.6				✓
△ TEMP. EROSION CONTROL				12604.7				✓
△ TOTAL:				176676				✓

For lump sum projects, the tracking of pay item quantities is not required. However, it is recommended to insert a red check mark within the **Plan Summary Boxes** as the work is completed.

ATTACHMENT 5.13-2 Estimated Quantities Report

Example EQR Cover Sheet:

ESTIMATED QUANTITIES REPORT	
Financial Project ID: [REDACTED]	
Contract Number: [REDACTED]	
Project Description: [REDACTED]	
<i>This document has been digitally signed and sealed by:</i>	
	<i>on the date adjacent to the seal.</i>
	<i>Printed copies of this document are not considered signed and sealed and the signature must be verified on any electronic copies.</i>
	[REDACTED SIGNATURE]
<i>The estimated quantities contained in this document:</i>	
<i>1. Were developed in compliance with Florida Department of Transportation procedures, processes, and requirements.</i>	
<i>2. Contain no known errors or omissions.</i>	
<i>3. Match the pay item numbers and quantities in Designer Interface for AASHTOWare Project Preconstruction™.</i>	

11/18/2020 3:53:59 PM Page 1 of 54

Example EQR Table:

Summary of Pavement														
Pay Item Number	Pay Item Description	Units of Measure	Quantity		Total Quantity		Location						Design Notes	Construction Remarks
			P	F	P	F	Alignment	Begin Station	End Station	Location Description	Side	Element ID		
			437.86				BROADWAY							
							CL-BROADWAY	498+67.90	502+45.05			LT/RT	244540	
0337 7 82	Asphalt Concrete Friction Course, Traffic C, FC-9.5, PG 76-22	TN	48.71		707.19		SR972	207+21.07	210+40.49			RT	228781	
			20.39				SR972	207+21.07	209+37.04			RT	228418	
			14.7				SR972	207+21.07	210+40.49			RT	228816	
			101.39				SR972	207+21.07	210+40.49			RT	228612	
			12.84				SR972	208+18.04	210+40.49			RT	228811	
			47.46				SR972	208+99.08	210+40.49			LT	228607	
			22.26				SR972	208+99.08	210+40.49			LT	228776	
			4.94				SR972	210+11.11	210+40.49			RT	228854	
			0.03				SR972	210+38.33	210+40.49			RT	228358	
			0.06				SR972	210+38.33	210+40.49			RT	228348	
			30.03				CL-BROADWAY	495+16.15	495+97.56			LT/RT	287738	
			35.68				CL-BROADWAY	495+97.55	498+67.90			RT	291808	
			27				CL-BROADWAY	495+97.55	498+67.90			LT	291803	
			74.16				CL-BROADWAY	495+97.55	498+67.90			RT	291633	
			57.37				CL-BROADWAY	495+97.55	498+67.90			LT	291628	
			210.17				CL-BROADWAY	498+67.90	502+45.05			LT/RT	244534	
0350 30 13	Concrete Pavement For Roundabout Apron, 12 Depth	SY	245.54		245.54		CL-BROADWAY	499+63.98	500+47.29			RT	216161	
0526 1 1	Pavers, Architectural, Roadway	SY	245.54		245.54		CL-BROADWAY	499+63.98	500+47.29			RT	216161	
...														
...														
...														

ATTACHMENT 5.13-3 Form 700-050-10, Pay Item Summary and Certification

Example EDMS References:

STATE OF FLORIDA DEPARTMENT OF TRANSPORTATION PAY ITEM SUMMARY AND CERTIFICATION SHEET									
Contract Details									
Contract:	District:								
Quantity	Unit	Item Code	SA #	Item Description	EDMS Doc /Page #	Unit Price	Item Paid Amount	Line Item Adjustment Amount	Total Item Paid Amount
816.000	SY	0110 4 10		REMOVAL OF EXISTING CONCRETE	EDMS# 1471926	\$44.0000	\$35,904.00	\$0.00	\$35,904.00
793.000	SY	0522 1		CONCRETE SIDEWALK AND DRIVEWAYS, 4" THICK	EDMS# 1472699	\$60.0000	\$47,580.00	\$0.00	\$47,580.00
78.000	SY	0522 2		CONCRETE SIDEWALK AND DRIVEWAYS, 6" THICK	↓	\$90.0000	\$7,020.00	\$0.00	\$7,020.00
591.000	LF	0630 2 11		CONDUIT, FURNISH & INSTALL, OPEN TRENCH	EDMS# 1471857	\$19.5000	\$11,524.50	\$0.00	\$11,524.50
24,548.500	LF	0630 2 12		CONDUIT, FURNISH & INSTALL, DIRECTIONAL BORE	EDMS# 1471858	\$18.6000	\$456,602.10	\$0.00	\$456,602.10
64.000	LF	0630 2 14		CONDUIT, FURNISH & INSTALL, ABOVEGROUND	EDMS# 1471861	\$36.0000	\$2,304.00	\$0.00	\$2,304.00
282.000	LF	0630 2 15		CONDUIT, FURNISH & INSTALL, BRIDGE MOUNT	EDMS# 1471859	\$23.0000	\$6,486.00	\$0.00	\$6,486.00
160.000	LF	0630 2 65		CONDUIT, REMOVE, BRIDGE MOUNT	EDMS# 1471860	\$11.5000	\$1,840.00	\$0.00	\$1,840.00
6,100.000	LF	0633 1121		FIBER OPTIC CABLE, F&I, UNDERGROUND, 2-12 FIBERS	EDMS# 1471927	\$2.4000	\$14,640.00	\$0.00	\$14,640.00

* Highlighted rows signify adjustments.

Report: PayItemSummaryAndCertification

Example Signatures:

DFEO USE ONLY		Certification Statement	
Par Reviews		(This block shall be signed by the qualified person(s) responsible for the accuracy of the Final Estimates Package, as submitted, in accordance with CPAM 5.11.)	
I certify, based on my personal knowledge and well-founded belief, the quantities are accurate and conform to the contract plan dimensions and specification tolerances, manuals and that this final estimate, as submitted is true and correct.			
Signature: <u>ali rastagh</u>	Digitally signed by ali rastagh Date: 2021.06.04 08:20:33 -0400'	Title: <u>Contract Support Specialist</u>	Signature: _____
Date: _____		And/Or TIN# _____	Digitally signed Date: 2021.03.29 12:06:41 -0400'
	Digitally signed Date: 2021.03.29 14:15:32 -0400'	Title: _____	Signature: _____
Project Administrator Signed: _____		Resident Engineer Signed: _____	Digitally signed Date: 2021.03.29 14:23:01 -0400'
Printed: _____		Printed: _____	

Section 5.14

FIELD RECORDS AND CONTRACTOR'S CERTIFICATIONS

5.14.1 Purpose

This procedure describes the methods of maintaining the various field records required by the Department to substantiate final estimates quantities. The methods outlined are generally applicable to any field notes, but they are particularly pertinent to those used in the calculation or verification of final pay quantities.

The Contractor's Certification of Quantities forms are also described herein. These Certification forms are required by the Department for the Contractor to document and certify the quantities of specific installed items for which payment is included in a monthly estimate.

5.14.2 Authority

Sections [20.23\(3\)\(a\)](#) and [334.048\(3\)](#), Florida Statutes (F.S.)

5.14.3 References

Materials Acceptance Certification (MAC) System

National Institute of Standards and Technology (NIST) Handbook-44

5.14.4 Field Records

Field Records should be prepared assuming that the user has no familiarity with the work being recorded. The **Field Records** are important site source records for establishing pay quantities. They may be required as evidence in any arbitration or lawsuit. All **Field Records** must be submitted as part of the **Final Estimates Documentation**. Below are the allowed types of **Field Records**:

NOTE: Ensure that Plan Quantity Pay Items are not field measured. Only measure field changes or plan errors for Plan Quantity Pay Items.

(A) Types of Field Records

(1) Standard Bound Field Book

A Surveying/Engineering field book typically has a hard cover and is bright orange or yellow in color. Most have gridlines, tables, or graph paper, and its pages are waxed or specially coated to withstand moisture to protect its contents.

(2) Site Source Records/Forms/Electronic Output

Any supporting documentation (spreadsheet, electronic tabulation, etc.) or Department form used to substantiate final quantities.

Electronic output and reports from Global Navigation Satellite System (GNSS) rovers are also acceptable to document final measurement and quantities. GNSS output and reports must include accuracy and precision information.

(3) Form 700-050-61, Final Measurements “Miscellaneous”

This form simulates a **Field Book** page and is preferred over standard bound field books, since it can be maintained electronically therefore resulting in savings to the Department.

(B) General Instructions

- (1) Identify the front cover of each Standard Field Book used by including the Federal Aid Project Number, Financial Project Identification Number, Contract Number, Field Book Number, State Road Number, and the general contents of the book in bold letters. On the back binding (spine) of each Field Book, show the Field Book Number and the Financial Project Identification Number. (See Attachment 5.14-1 for Sample Field Book Identification.)
- (2) When the **Final Measurements “Miscellaneous” Form** is used, list the same project information required on the cover of the **Standard Field Book** at the top of each form used. It is recommended to maintain these forms electronically; therefore, it is unnecessary to bind these forms together or provide Field Book Numbers.
- (3) Each **Field Book** must be clearly indexed with a complete list of the contents beginning on the first lined page, and numbered page one. The following pages used to record notes must be numbered sequentially in the upper right corner of each page.

- (4) The date, weather conditions, and the name(s) of the field party must be shown on the **Field Records** and at the beginning of each day's notes. Well documented **Field Records** are indispensable in the event of litigation.
- (5) Corrections must be made by striking through the incorrect data and inserting the correct data. All corrections must be initialed and dated by the person making the correction.
- (6) Do not cut or otherwise remove pages from any **Field Book**. If an entire page is found in error, mark the original page as **VOID**, initial, date, and make a note referring to the page where that item of work was corrected.
- (7) Keeping notes on loose-leaf or scratch pads and transferring them to **Field Books** or **Final Measurements "Miscellaneous" Form** is prohibited. Field notes must be entered directly into the field book or a Department form as the site source document.
- (8) **Field Records** must be legible [especially when inputted into the Electronic Document Management System (EDMS)], and include sufficient sketches and explanatory notes to convey the intent to a person who is not familiar with the job. Pay item numbers, original/final cross-sections, and other relevant information must be included.
- (9) Good sketches are imperative when recording final measurements. The details of the sketches must be sufficient to clearly show the extent of the work as well as any exceptions.
- (10) Use standard symbols and abbreviations. Keep the notes simple and avoid making ambiguous statements.
- (11) Show all pertinent measurements and observations. Use a degree of accuracy consistent with operations. If there is any doubt about the need for data, record it. Review the data for accuracy and completeness before leaving the field.
- (12) A complete summary must be made for each item at the end of its field notes. The personnel compiling the final estimate will check the summary total for each item and ensure appropriate payment. The summary and the **Field Record** EDMS number(s) must be properly referenced in the **Final Estimates Documentation**.
- (13) Calculations and measurements for Federal Aid participating and non-participating items must be separated. This also applies to **Utility Work by Highway Contractor Agreements (UWHCA)** and **Locally Funded Agreements (LFAs)**.

- (14) When more than one project (state or federal) is constructed under the same Contract, **Field Records, measurements, and other data** must be kept separate for each project.
- (15) **Field Records** for projects let under separate contracts must never be recorded in the same **Final Measurements "Miscellaneous" Form** or **Field Book**.
- (16) All **Field Books** must be scanned into EDMS for submittal with the **Final Estimates Documentation**. The original **Field Book** may be destroyed.
- (17) When documenting any data on grid sheets, neatness and legibility give credence to the accuracy of field notes and the calculations which they support.
- (18) **Field Records** containing alignment data must contain all the necessary information for horizontal control for new construction projects and major widening projects.
- (19) **Form 700-010-60, Pile Driving Record**: Individual pile record data is entered on the **Pile Driving Record** forms by bent or pier numbers. Data for alignment and pile driving must be entered on the **Pile Driving Record** forms. These are permanent records and must be retained until the structure is removed.
- (20) **Form 700-050-53, Final Measurements Site Source Record**: This form is used to document quantities using the Latitude and Departure method. A Technician may use as many pages as needed for individual pay items.

5.14.5 Tabulation Forms

Tabulation Forms are site source records for establishing pay quantities.

(A) **Form 700-050-54, Daily Report of Truck-Measured Material Site Source Record**

This form is used to record truck quantities. When the final quantities are determined by certification/measurements of loose volume in truck bodies, the following procedures will satisfy the requirements for final pay records:

- (1) All trucks must have an assigned unique number, along with the manufacturer's certification, or permanent decal, showing the truck capacity rounded to the nearest tenth of a cubic yard and placed on both sides of the truck. This includes the truck body capacity only, and any

sideboards added will not be included in the certified truck body capacity provided by the contractor. The Project Administrator (PA) will randomly check the certified capacity on a selective number of trucks for accuracy by **using Form 700-050-54A, Truck Measured Sketch (Regular Bed)** and/or **Form 700-050-54B, Truck Measured Sketch (Irregular Shape Bed)**. This does not require the field personnel to climb into the body of the truck. When applicable, sideboard measurements will be transposed on these sheets and added to the certified capacity.

- (2) Using the trucks unique identification number and capacity, this form is used to record the quantity for each truck as it delivers a load of the material to the project.
- (3) The volume entered on this form for borrow material must reflect the struck-measured volume (the dry measure having the contents leveled off and not heaped). The use of the struck-measured capacity will apply to trucks, pans, or any other means of transport used. Documentation on loose volume bases, as measured in other hauling equipment, must be made at the point of dumping on the construction site.
- (4) The PA will request, at the **Preconstruction Conference**, that the Contractor provide a list of trucks to be used on Department's projects, along with their assigned numbers and their certified capacities. This list must be submitted with the **Final Estimates Documentation**.
- (5) A separate line on the form will be used for each truck showing:
 - (a) Hauling company
 - (b) Truck number
 - (c) Capacity certified
 - (d) Load count & time recorded
 - (e) Total volume for that truck that day
 - (f) Inspector's signature and title at the bottom of the page
- (6) Typical materials paid for by volume and recorded on the form include:
 - (a) Borrow material

- (b) Stabilizing material
- (c) Cover material for prime coat, asphalt membrane interlayer or spread footings

(B) Form 700-050-56(A), Daily Log Sheet - Miscellaneous Tabulation Form Weight Site Source Record and 700-050-56(B), Daily Log Sheet - Miscellaneous Tabulation Form Bag Count Site Source Record

These forms are provided in the *FDOT Excel Forms Manager* plugin which can be installed from the Department's [Construction Downloads](#) webpage. These forms are used when material is paid by weight. *Field Records* are also kept for each truckload of material hauled each day and signed by the Inspector. This form is only used for Riprap and Sand-Cement Riprap. The Department's Engineering Quantities Program is available to verify quantities for tracking documentation and payment.

- (1) Riprap: Quantities used and approved in each day's operation must be recorded on this form. In the Remarks column, include the station, offset, and structure number of the placement location.
 - (a) Measure in tons, in surface dry natural state, by railroad scales, truck scales, or barge displacement. See [Attachment 5.14-2](#) for Barge Displacement Calculation example. Provide weight certificates when weights are not measured by the Engineer as described in *Specification 530-4.2*.
 - (b) Ensure concrete removed from an existing structure and subsequently used as rip rap (per plans) is paid for as Removal of Existing Structures and not paid for again as Riprap.
 - (c) For a toe wall, only include the volume of sand-cement riprap, concrete blocks, or poured-in-place concrete placed within the neat lines shown in the plans in the volume calculation of the final toe-wall quantities. See [Attachment 5.14-3](#) for Toe Wall Calculations example.
- (2) Bulk-Weight Final Pay Records: Certified weight tickets for certain bulk weight shipments are acceptable as final payment records under the following conditions:
 - (a) All weighing is done on state certified scales. The ticket must indicate gross, tare, and net weight.

- (b) The State of Florida will recognize any scale that has been certified by a state agency outside Florida using traceable standards. All 50 states have adopted and use the same laws as [Florida NIST Handbook-44](#).
 - (c) Project personnel will record each truck number and time of loading, on **Form 700-050-56, Daily Log Sheet Miscellaneous Tabulation Form Site Source Record** at the rail head site.
 - (d) All rail cars are visually inspected to ensure all material has been unloaded.
 - (e) Material remaining in cars after job completion is to be hauled by truck to state certified scales and determine gross, tare, and net weights to make appropriate deductions from the car weights.
 - (f) Hauling will be done in covered trucks to minimize loss of material. The single car weight is more accurate than weighing numerous trucks (use the **Form 700-050-56, Miscellaneous Tabulation** system as outlined above).
- (3) Sand-Cement Riprap: Document the volume (in cubic yards) of sand-cement bags placed.
- (a) Calculate the total cubic yards of prepackaged Sand-Cement Bags by multiplying the bag quantity (total bags placed) by the cubic yards per bag.
 - (b) The volume in cubic yards placed and accepted within the minimum dimensions in the Plans or Standard Plans will be paid per **Specification 530-4.1**.
 - (c) Submit delivery tickets showing the batch weights of sand and cement used. (See [Attachment 5.14-4](#) for a Delivery Ticket sample.)
 - (d) When the pay quantity for sand cement is determined by the volume of sand, verify calculations from sketches and dimensions of the batch box capacity (or other approved measure).

Payment for riprap must not be made solely on the quantity delivered by truck and placed by the Contractor. For example, the quantity of riprap for an 84" diameter triple-concrete

pipe is 31.1 CY, and this is the maximum quantity applicable for payment. No compensation will be made for material placed beyond the neat lines shown in the plans. A sketch of the riprap structure must be submitted with authorized dimensions and volume calculations if not constructed according to Plans. This sketch must be included in the **Field Records**. (See [Attachments 5.14-5](#) and [5.14-6](#) for an example of a Riprap Sketch and Sand Cement Riprap Pay Analysis.)

If the PA determines the Contractor is placing the material too thick or beyond required limits, the PA must submit written notification to the Contractor. In addition, the Inspector must include the station, offset structure, and the words "**Partial Pay**" or "**No Pay**" on the form collected for materials which are either partially or completely placed outside the limits authorized by the PA.

NOTE: When box beam scales are used, and the net weight is given automatically, only the net weight is required to be recorded.

(C) Resident Office Responsibility

The material quantities represented on the forms must be reconciled. Multiple trucks may be recorded on one form if each individual truck is identified by number and company name.

Department forms must be cross-checked with the Contractor or subcontractor's records on a regular basis (daily or weekly). Any existing differences in pay quantities must be reconciled immediately. This systematic comparison of site source records will avoid misinterpretations concerning final pay quantities.

The form totals must be summarized and cross-referenced within the **Final Estimates Documentation**.

5.14.6 Contractor's Certification of Quantities

(A) Form 700-050-62, Contractor's Certification of Quantities - (MOT, Signs, etc.)

This form is provided in the **FDOT Excel Forms Manager** plugin which can be installed from the Department's [Construction Downloads](#) webpage. Once generated, the form will list all the MOT pay items within a contract. The Contractor will document and certify all 102 pay items. This form is not required on Lump Sum and Design Build contracts.

The form must be signed by both the Contractor's Authorized Agent and the Worksite Traffic Supervisor (WTS), then submitted monthly to the PA for payment. The Contractor's

Authorized Agent must be an employee of the Prime, and the WTS must be Advanced MOT Certified per **Specification Section 105-8.3**. The PA will submit these certifications with the **Final Estimates Documentation**.

NOTE 1: Cones are paid for under the MOT LS pay item 102-1.

NOTE 2: MOT LS pay item 102-1 is NOT adjusted by construction for overruns/underruns using the secondary units of days, see Item 102-1 of the [Basis of Estimates Manual Pay Item Database](#).

NOTE 3: MOT Certifications approved and paid on a previous progress estimate should not be retracted and revised if errors are discovered. Corrections may be made on the current/next progress estimate with a note in the remarks column explaining the correction. If backup documentation is available, submit it with the certification as well.

(B) Form 700-050-67/68, MOT – Traffic Stripes and Markings Daily Worksheet and Contractor's Monthly Certifications of Quantities

These forms are to be used by the Contractor for all the Traffic Striping and Marking pay items. These forms include the following pay items: 701, 705, 706, 709, 710, 711, 713, and 102 striping items. The 102 striping pay items are also listed in this worksheet to eliminate the need for filling out two different forms. For projects let July 2021 and after, pay items 701, 709, 711, and 713 will be paid as plan quantity, regardless of their inclusion on the Contractor's Certification. Raised Pavement Markers (RPMs) (706-1 pay item) are now final measure. Ensure the Contractor is aware of the appropriate basis of payment for striping items. This form is not used on Lump Sum and Design-Build contracts. See **CPAM Section 6.2** for more information.

The Contractor is responsible for the measurements/counts for these items, and payment for the certified quantities must be approved by the Engineer. If the Engineer disputes a quantity certified by the Contractor, the Engineer must request justification for the disputed quantity from the Contractor. The Engineer must provide detailed documentation for the unapproved quantity.

The form must be signed by both the Contractor's Authorized Agent and the Worksite Traffic Supervisor, then submitted monthly to the PA for payment. The intent is to have two different individuals sign this form for checks and balances. The Contractor's Authorized Agent must be an employee of the Prime, and the WTS must be Advanced MOT Certified per **Specification Section 105-8.3**. If the same individual signs for both the Contractor's Authorized Agent and the WTS, the PA must verify this individual holds both positions and is Advanced MOT Certified. The PA will submit these certifications with the **Final Estimates Documentation**.

NOTE 4: For the Lump Sum Pay Item 710-90, the Contractor should reflect the quantity as a percentage (in decimal form) on the daily worksheet, to report the cumulative quantity when the monthly certified sheet is tabulated. The total quantity should be 1 Lump Sum (LS) once the Contractor completes this pay item.

NOTE 5: Payment under the Lump Sum Pay Item 710-90 will only be made when the final lift of asphalt placement is complete. All intermediate stages of asphalt placement requiring striping are paid under the appropriate pay items.

NOTE 6: The Department's representative is not required to check or record MOT Signs and Striping quantities daily. During the estimate period, randomly spot check and document these quantities. These checks can be achieved in a combined effort with the Contractor to minimize disputed quantities. The Contractor is responsible for supplying the Department with accurate documentation of quantities.

NOTE 7: For RPMs (706-1 pay item), it is not intended for the Resident Offices to count individual RPMs. Using the Station-to-Station length divided by the RPM spacing will suffice.

(C) Form 700-050-70, Traffic Marking Certification (Worksheet)

This form is used for recording Initial Retroreflectivity Reading of White/Yellow Pavement Markings, Thickness, and Wet Weather in accordance with **Florida Method FM 5-541**, per **Specifications Section 710**. This form will also be utilized on Lump Sum and Design-Build Projects. See **CPAM Section 6.2** for more information.

It is the Contractor's responsibility to measure, record, and certify the Retroreflectivity on the Department's approved form and to submit it to the PA. This form is signed by both the Contractor's Authorized Agent and the Worksite Traffic Supervisor as stated in section [5.15.6\(B\)](#) above.

The Department reserves the right to test the markings after three (3) days of receipt of the **Contractor's Certification**. Failure to allow the Department to complete this task will result in non-payment to the Contractor.

5.14.7 Fuel Adjustments

Applicable Contracts with an original Contract Time exceeding 120 calendar days, will receive price adjustments on the portion of the Current Fuel Price (CFP) that varies by more than 5% of the Base Fuel Price (BFP). The adjustment will be made on each applicable progress estimate to reflect increases or decreases in the price of fuel from those in effect for the month in which bids were received (BFP) per **Specifications**

Section 9-2.1.1. When an estimate is generated, fuel adjustments automatically calculate per the Specifications using pre-determined fuel factors for applicable pay items and the Price Index Tables.

A complete list of items eligible for fuel adjustments, according to contract letting date, can be found on the Department's Construction Web site at [Fuel and Bituminous Forms \(fdot.gov\)](#). Fuel adjustments for this list of pay items will generate ***automatically*** in AASHTOWare Project Construction (PrC) for conventional Contracts.

Fuel adjustments for the following pay items will be calculated in the ***Fuel Adjustment Report*** and will need to be entered ***manually*** into PrC as a line item adjustment.

- Clearing and grubbing
- Structural Steel
- Black base option
- Composite base option

NOTE 1: To calculate manual fuel adjustments corresponding to thickness or 105%/110% pay quantity adjustments utilize the Contractor's Lump Sum & Design Build [Fuel Adjustment Certification](#). See ***CPAM 11.4*** for examples.

NOTE 2: Effective for contracts let January 2022 and forward, fuel adjustments will only be made on diesel fuel.

NOTE 3: Contracts let in April 2021 and after are not eligible to receive fuel adjustments for clearing and grubbing.

(A) Fuel Adjustment Report

To access the *Fuel Adjustment Report*, follow the steps below:

- (1) Access the [State Construction Office application](#)
- (2) Login
- (3) Select *Reports*, then select *Central Office (StateWide Reports)*
- (4) Select the *Estimate* tab, then click *Fuel Adjustment*

To create a *Fuel Adjustment Report*, follow the steps below:

- (1) Enter the Contract ID
- (2) Enter the estimate number the Adjustment Report is being created for. The estimate number is a four-digit field and only one estimate can be run at a time.
- (3) Click "Get" to generate the report (if there is no Black Base Option or Composite Base Option included in the Contract).

Get Fuel Adjustment report

Report File Name* Contract Id* Estimate #:(example: 0001)*

Fuel Adjustment T5686 0007

Other Adjustments Over ride Index Flag

Output Formats

PDF

*Denotes Required Fields [Reset] [Cancel] [Get]

(B) Fuel Adjustment Report (Black Base or Composite Base Option)

To create a *Fuel Adjustment Report* for Black Base or Composite Base, follow the steps below:

- (1) Enter the Contract ID and estimate number the Adjustment Report is being created for.
- (2) Select the “*Other Adjustments*” check box.
The FIN Project ID and the Base Items fields will populate with any associated pay items to the contract.
- (3) Select the Optional Base Item.
- (4) Select the FIN Project ID to calculate the fuel adjustment for the Optional Base quantity.
- (5) Only enter the quantity of Black Base (or Composite Base) and select “Add Selected” to add the quantities to the “Items” Field.
- (6) Repeat as needed, then select “Get” to generate the report.

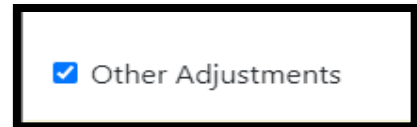

NOTE 4: If paying for a mixture of optional bases on this estimate, the Daily Work Report (DWR) quantity will be the total of Asphalt and Limerock pay areas.

(1) Fuel Adjustment Report for Asphalt Base Example

In this example, the DWR quantity is 192.24 SY, of which only 50.0 SY is Asphalt Base.

After adding the report parameters (shown above) and generating the report, the adjustment amount for diesel for the Asphalt Base will be shown. The adjustment amount generated in this report (\$38.38) will need to be added to PrC as a manual line item adjustment.

PrC Total:	\$165.30
Manual Total:	\$0.00
Total Amount:	\$165.30
**Adjusted Amount:	\$38.38
Adjusted Total:	\$203.68

However, if all the DWR quantity (192.24 SY) is Asphalt Base, enter this amount into the quantity field. This will make the adjustment on the entire DWR quantity and generate the adjustment amount (\$147.56) shown below.

Diesel Adjustment						
0105	0160	4	25.300	SY	.1196	.659
0110	0285715		192.240	SY	.4359	.659
Asphalt Base option for quantity			192.24 fuel adjustment of \$	147.56 **		
0120	0334	1.13	22.430	TN	4.6220	.659

(C) Fuel Adjustment Report for Clearing and Grubbing or Steel LS Overrun

To create a *Fuel Adjustment Report* for Clearing and Grubbing or Steel LS Overrun, follow the steps below:

- (1) Enter the Contract ID and estimate number the Adjustment Report is being created for.
- (2) Select the “Other Adjustments” check box.
- (3) Select the adjustment type.
- (4) The FIN Project ID list and pay item will automatically populate.
- (5) Select the FIN Project ID to calculate the fuel adjustment.
- (6) Enter the quantity of the overrun adjustment and select “Add Selected” to add the quantity to the “Items” Field.
- (7) Select “Get” to generate the report.

(1) Fuel Adjustment Report for Clearing & Grubbing or Steel LS overrun Example

In this example, the Clearing and Grubbing quantity being adjusted is 5 Acres (the acres this LS pay item is being adjusted by must be known). The overrun of Clearing and Grubbing can be found under the Diesel and Gasoline adjustment for this pay item.

The screenshot shows a software interface for creating a Fuel Adjustment Report. At the top, there are two checkboxes: "Other Adjustments" (checked) and "Over ride Index Flag" (unchecked). Below these are five main sections: "Types*", "Projects*", "Clearing & Grubbing*", "Qty*", and "Items".

- Types*:** A dropdown menu with options: Black Base, Clearing & Grubbing (selected), Composite Base, and Steel.
- Projects*:** A list of project IDs: 43667915201 (selected), 43667915203, 43667915204, and 43667915601.
- Clearing & Grubbing*:** A dropdown menu with the selected value: 0005:0110:1.
- Qty*:** A text input field containing the number 5. A red arrow points to this field.
- Items:** A text area containing the string CLRGR8;43667915201;0005.

Below the "Qty*" field, there are three buttons: "Add Selected" (highlighted with a red box), "Remove Selected", and "Remove All".

Project personnel will need to make individual line item adjustments for each dollar amount associated with Clearing and Grubbing in PrC, if applicable.

Ln #	Item Code	Est Qty	Unit	Qty	Unit	Adjustment Factor	Index Difference	Adjustment Amount
Diesel Adjustment								
0005	0110 1 1	.100	LS	12.470	AC	251.4787	.4355	\$136.57 **
	Item 0110 1 1 Over Run	5.000	AC adjustment of \$					\$547.59 **
0010	0120 1	5400.000	CY			.5512	.4355	\$1,296.22 *
0015	0160 4	2483.800	SY			.4727	.4355	\$511.29 *
0450	0120 6	1106.000	CY			.5172	.4355	\$249.10 *

The report will automatically add the total dollar amount for all Diesel adjustments.

Example:
 \$136.57
 + \$547.59

 684.16

PrC Total:	\$2,056.61
Manual Total:	\$136.57
Total Amount:	\$2,056.61
** Adjusted Amount:	\$684.16
Adjusted Total:	\$2,740.77

5.14.8 Bituminous Adjustment

Applicable contracts will receive monthly bituminous adjustments if the Contract has an original contract time of more than 365 calendar days or more than 5,000 tons of asphalt concrete. The Department will adjust the price for bituminous material, excluding cutback and emulsified asphalt, to reflect increases or decreases in the **Asphalt Price Index (API)** of bituminous material from that in effect during the month in which the bid was received. (See **Specifications Section 9-2.1.2.**) The Department will determine the API for each month and post it on the Construction website.

<http://www.fdot.gov/construction/fuel&bit/Fuel&Bit.shtm>

Bituminous adjustments will be made only when the current API (CAPI) varies by more than 5% of the base API (BAPI) and only on the portion that exceeds 5%. The Contractor will not be given the option to accept or reject the adjustment.

It is the Contractor's responsibility to provide a **Contractor's Certification of Quantities** to the PA, using the Department's current approved **Form 700-050-66**, which can be found at <https://www.fdot.gov/construction/fuel-bit/fuelforms.shtm>. The form will include the tonnage placed and accepted for the asphalt items applicable to receive a bituminous adjustment during the estimate **cutoff period**. Adjustments will only be made for work accepted by the Department. If an adjustment is made and the work is later determined to be unacceptable, a deduction to the adjustment will be made on the next

progress estimate. The asphalt items will be reported on the lead FIN Project ID to receive payment. (See [Attachment 5.14-7](#) for a sample Contractor's Certification of Quantities.)

NOTE 1: The Department will make a Bituminous Adjustment for Polymer PG76-22 Binder on all Contracts. The Criteria for Polymer PG76-22 will be as stated above. When a Composite Base item is specified in the Plans, a price adjustment for bituminous material will apply to the asphalt portion only per **Specifications Section 9-2.1.2**.

(A) Resident Office Responsibility

The Resident Office (RO) personnel will ensure the appropriate fuel and bituminous adjustments are applied to each monthly progress estimate. It is the RO's responsibility to obtain bituminous certifications from the Contractor monthly and spot check the forms for quantity errors, indexes, dates, etc. to ensure the criteria in **Specifications Section 9** is met. Fuel and bituminous adjustments will be based on the index of the estimate period the work was completed, not the estimate period of payment. This is particularly important for adjustments made after final acceptance.

When an estimate is generated, Bituminous Adjustments must be calculated per the **Specifications** using the **Asphalt Price Index** and the PA must add a manual line-item adjustment to the estimate. **Asphalt Price Indexes** can be found on the Department's Construction website at: <https://www.fdot.gov/construction/fuel-bit/fuel-bit.shtm>.

The PA will ensure the running total of each item's tonnage in the **QCRR** for the period represented and compare to the **Certification of Quantities** submitted. Any discrepancies must be resolved with the Quality Control (QC) Manager before authorizing payment on the progress estimate. If a **Certification of Quantities** has been determined to show tonnage that wasn't accepted on the project, the QC Manager must be notified for justification and/or correction. The Certification of Quantities must be inputted into EDMS for reference as **Final Estimates Documentation** backup.

NOTE 2: Bituminous Certifications that have been approved and paid on a previous progress estimate should not be retracted and revised if errors are discovered. Bituminous corrections must be completed on the current/next progress estimate and the correction documented on the current/next certification. For the removal and replacement asphalt adjustment process, see Example 2 above and **CPAM 11.4.**

NOTE 3: For Fuel and Bituminous Material Adjustments on Lump Sum, Design-Build, and other Alternative Contracts, refer to **CPAM Section 6.2**.

(1) Examples

Example 1: After final acceptance, the project personnel found that fuel adjustments for black base were not applied during the contract. The project personnel will manually calculate the fuel adjustments based on the index for each estimate period the asphalt was completed, not the fuel index for the month of the final estimate. The Lump Sum & Design Build [Fuel Adjustment Certification](#) can be used to generate the adjustment amount.

Example 2: Asphalt was placed on the mainline for payment during the May estimate period, but 50 feet required removal and replacement due to a material failure. The contractor performed the removal and replacement during the July estimate period. When the bituminous adjustment corrections are made, the removal correction will be made at the May index, and the placement will be at the July index. The Lump Sum & Design Build [Asphalt & Bituminous Adjustment Certification](#) can be used to generate the adjustment amount.

Example 3: Asphalt was incorrectly reported in the **QCRR** for an estimate period, and fuel & bituminous adjustments were paid on that amount. The following month the QCRR was corrected. Fuel and bit adjustments will be corrected for the corrected amounts. Adjustments will also be calculated for the amount placed in the new estimate period. The revised fuel and bit adjustments can be calculated using the Lump Sum & Design Build [Certifications](#), and the difference between the corrected adjustment and the current adjustment will be entered as a line item adjustment on the pay item.

5.14.9 Approved Products List (APL) Item Records

(A) Contractor Responsibilities

It is the Contractor's responsibility to provide APL numbers for pay items intended for use on the project. APL numbers are provided to the PA (or designee) for record and verification. This includes items incorporated in the project on a permanent basis and all MOT items.

On projects with a Non-Standard Job Guide Schedule (JGS), the Contractor must assign all MAC Materials for APL Tracking samples under the Materials tab in the Materials Acceptance and Certification system (MAC) for project personnel to enter the APL Tracking Samples. In addition, the Contractor must continue to include the APL Spec Categories used on the project under the APL Specs tab.

(B) Resident Office Responsibilities

The PA (or designee) will verify the APL information for specification conformance before the item is placed on the project. Verification is done by reviewing any comments, statuses, or limitations on the product in the Product Acceptance and Tracking History (PATH) application. The PA (or designee) will enter APL Tracking samples into MAC prior to payment on the monthly estimate. For instructions, see the [MAC website](#).

PAs must confirm that all APL method of acceptance requirements are listed on the JGS on projects with a Standard JGS in MAC. On projects with a Non-Standard JGS, the PA will ensure the Contractor has included all MAC Materials under the Materials tab and APL Spec Categories used on the project under the APL Specs tab. Material Certification (MC) Reviewers will review the JGS and confirm that product(s) are entered in MAC for each MAC Material as part of the MC Review in MAC and coordinate with the PA if there are any questions about the use of APL products.

5.14.10 Cutoff Period

All **Certifications of Quantities** worksheets submitted by the Contractor must represent the amount of material placed on the project and accepted by the Department for the estimate cutoff period. The estimates cutoff dates are provided on the State Construction Office website at:

<http://www.fdot.gov/construction/CONSTADM/EstimatesCutOff.shtm>

The Contractor must request payment by submitting a **Certification of Quantities** no later than twelve o'clock noon on Monday following the estimate cut-off or as directed by the PA. This is in accordance with **Specifications**. The Contractor's submitted quantities must be approved by the PA. Any disputed quantities must be reconciled as soon as possible.

All digital signatures must be verified prior to acceptance by the Department. The RO must ensure each digital signature is from an approved digital signature authority and valid at the time the document was signed. The RO must also verify the document was not altered after the digital signature was applied.

5.14.11 Forms

The forms referenced in this manual can be found on the Department’s website: <https://pdl.fdot.gov/>. Official forms provided by the Department will be used without alteration or modification.

5.14.12 Attachments

Attachment 5.14-1	Field Book Identification
Attachment 5.14-2	Barge Displacement Calculation
Attachment 5.14-3	Toe Wall Calculation
Attachment 5.14-4	Delivery Ticket
Attachment 5.14-5	Sketch of Riprap Structure
Attachment 5.14-6	Sand Cement Riprap Pay Analysis
Attachment 5.14-7	Contractor's Certification of Quantities

**Attachment 5.14-1
FIELD BOOK IDENTIFICATION**

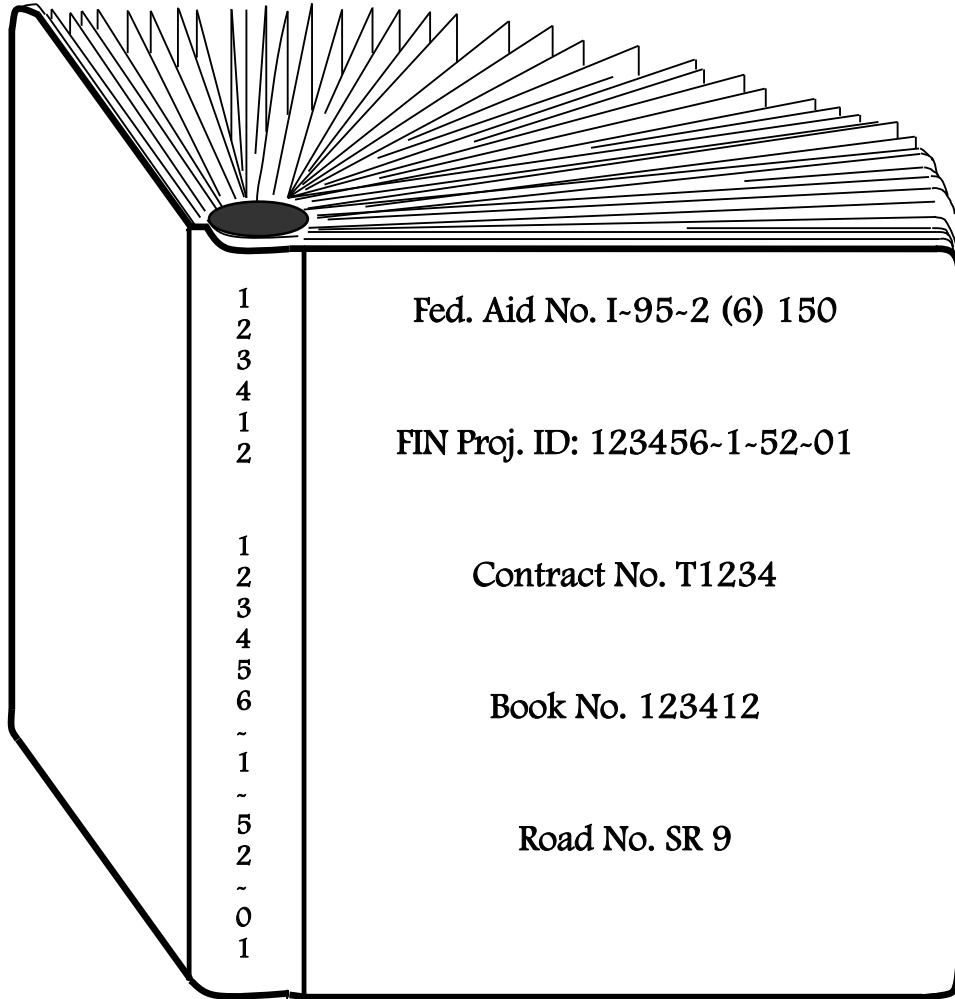

Attachment 5.14-2 BARGE DISPLACEMENT CALCULATION

BARGE WEIGHT CALCULATION EXAMPLE

Barge Material Delivery

	IN	Dec. 11, 1989
	OUT	Dec. 12, 1989

**MATERIAL 300 - 5000
 rubble rip rap**

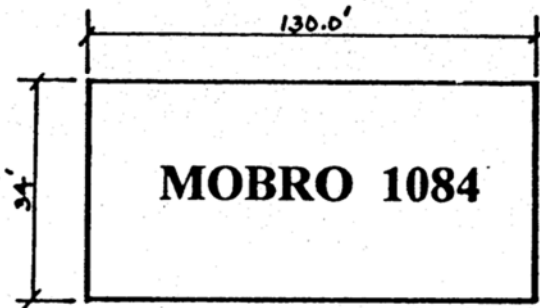
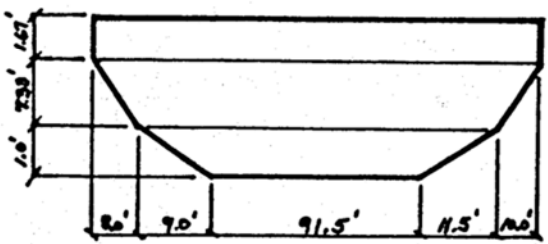
LOADED DRAFT

Port Forward	6.6
Port Aft	6.7
Starboard Forward	7.0
Starboard Aft	7.1
Average	6.85

LIGHT DRAFT

Port Forward	2.3
Port Aft	2.6
Starboard Forward	2.3
Starboard Aft	2.5
Average	2.43

Water line length at average loaded draft	126.36	
Water line length at average light draft	115.51	Bilge Correction
Net average water line length	120.94	-0-
Shape correction	-0-	Average
Average water line length	120.94	2.43

Average Difference
 in Light and Loaded
 Draft 4.42

Tonnage Computations: = 120.94' x 34' x 4.42' x [64(lb/cf)/2000(lb/ton)] =
 = 581.6 Tons

Note for unit weight of water: Sea Water = 64.0 lb/cf and Fresh Water = 62.4 lb/cf

Attachment 5.14-3 TOE WALL CALCULATION

SAMPLE:
 CONCRETE DITCH PAVTMENT FINAL MEASUREMENT
 STA. 105+62 RAMP 'A' =
 STA. 10+00. B DIT. PVT.

8 - 8 - 97 (FAIR & HO)
 TY KNOTTS
 TAPE ... MAC LOOPS
 TAPE ... CHIP RAVELS

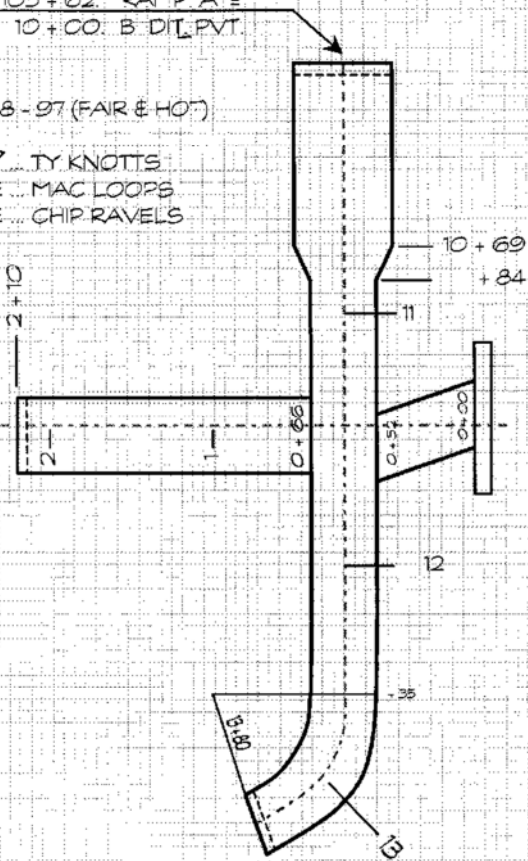

DITCH PAVT. LT. 105 + 62 DITCH PAVT. LT. RAMP 'A'

STA	MEAS. 'M'	STA	MEAS. 'M'
0+00	39.2	10+00	20.2 W=8.5
-20	39.4	+50	20.0
+40	42.3	+69	20.1
+52	42.2 BK	+84	16.3
EXCEPTION			
+66	42.5 AH	11+00	16.1
+80	40.8	+50	16.2
1+00	41.0	12+00	16.3
+50	41.0	+35	16.9
+75	40.7	+50	17.0
2+00	40.5	3+00	17.3
+10	40.3 W=38.7	+50	17.2
	8,001.35 S.F.	+80	17.4 W=16.7
3.5 x 38.7 =	+135.45 S.F.		6,612.4 S.F.
	8,136.80 S.F.		+123.2 S.F.
			6,735.6 S.F.
		18.5	
		+6.7	
		3.5 x 35.2 =	123.2 S.F. (Toewalls)

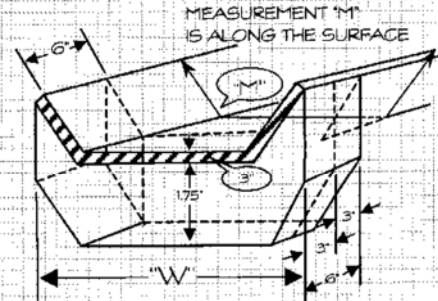

VOLUME OF CONCRETE IN TOEWALLS ARE COMPUTED AS EQUIVALENT SQUARE FEET. IE, 6" thick + 3' increments = 2 x Height of toewall. (2 x 1.75' = 3.5' x 'W') = Equivalent S. F.

Attachment 5.14-4 DELIVERY TICKET



FLORIDA MINING & MATERIALS
 CONCRETE PRODUCTS
 LEE DIVISION

P.O. BOX 2376, 2858 FORD STREET, FT. MYERS, FLORIDA 33902, PHONE (813)334-4521

Plant No. 03-004 Del. Ticket _____
 Serial No. _____
 Date: _____ 19 _____

Delivered To: _____
 Address _____

F.D.O.T. Fin. Proj. ID. _____

Truck No.	DOT Class	DOT Mix NO.	Cubic Yards This Load
Time Loaded	Arrived	Discharged	Cubic Yards Total Today
Allowable Jobsite Water Addition gals./cu. yd.		Mixing Revolutions:	At Plant: At Jobsite:
FILL OUT ON FIRST DELIVERY AND ON EACH CHANGE OF AGGREGATE WEIGHTS			
Cement _____ Brand _____ Amount _____	Air _____	MBVR _____	Amount _____ oz.
Course Agg. _____ % Moisture _____ Amount _____	Retarder _____	MBL-80 _____	Amount _____ oz.
Fine Agg. _____ % Moisture _____ Amount _____	Fly Ash _____ Source _____	Amount _____	
Batch Water (Gals.) _____ Amount _____	Coursr Agg. DOT Pit # _____	S.C. _____	
	Fine Agg. DOT Pit # _____	S.C. _____	

Issuance of this ticket constitutes certification to the accuracy of the above recorded information

 Signature of Plant Operator or Company Rep.

WATER ADDED ON JOBSITE _____ GALLONS

ADDITIONAL MIXING REVOLUTIONS _____

Attachment 5.14-5 SAMPLE SKETCH OF RIPRAP STRUCTURE

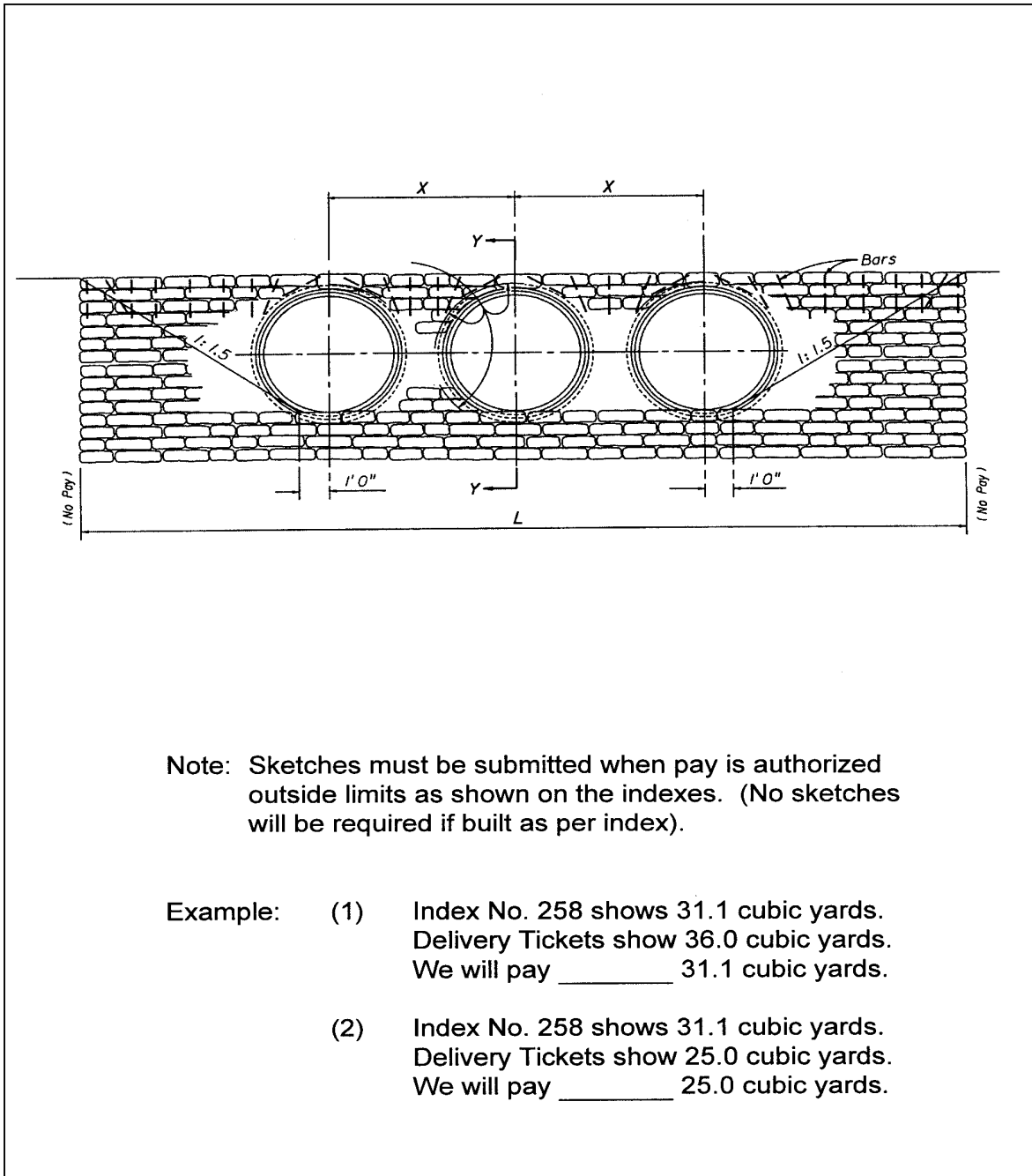

Attachment 5.14-6
SAND CEMENT RIPRAP PAY ANALYSIS

Step 1 STRUCTURE QUANTITY DETERMINATION	
Approved Quantity Dimension = 31.1 cu. yds.	
Step 2 DELIVERY QUANTITY DETERMINATION	
Prebag ticket Delivery tickets	<u>Example</u> <u>Tally Book Summary</u>
Delivery tickets must be submitted showing the weights of sand & cement actually used for each delivery Ticket.	Jan. 9, 1990 = 8 cy = sand = 18,360 lbs. = cement = 4,064 lbs. Jan. 10, 1990 = 8 cy = sand = 18,360 lbs. = cement = 4,064 lbs. Jan. 11, 1990 = 8 cy = sand = 18,360 lbs. = cement = 4,064 lbs. Jan. 12, 1990 = 8 cy = sand = 18,360 lbs. = cement = 4,064 lbs. <u>32 cu. yds.</u>
Note: Whichever is the lesser of Step 1 or Step 2 above, shall be paid. In the above example the structure quantity should be paid. If the delivery ticket quantity had been less than the structure quantity, the actual quantity delivered would have been paid.	
Step 3 5:1 DETERMINATION	
I. Computations to check for the actual ratio of the 5:1 mix : 18,360 lbs sand + 85 lbs/cf = 216 cf 4,064 lbs cement + 94 lbs/cf = 43.2 cf 216 ÷ 43.2 = <u>5.0</u> , therefore this is a 5:1 mix, as required.	
II. CONSIDER: If the 5:1 mix had not been achieved, and the mix was allowed to be placed on the project, the following documentation is required: A. C-165 with negotiated pay reduction. B. Supplemental Agreement revising the unit price.	

**Attachment 5.14-7
 CONTRACTOR'S CERTIFICATIONS OF QUANTITIES
 (FORM 700-050-66)**

Contractor's Certification of Quantities Asphalt Mixes with Modified and Unmodified Binders (Conventional Projects) Certification No. <u>9</u>			
Financial Project ID:	<u>654321-52-01</u>		
Contractor:	<u>We Got Asphalt, Inc.</u>		
Contract Number:	<u>X1234</u>		
From (Mo/Day/Yr):	<u>01/16/17</u>	To (Mo/Day/Yr):	<u>02/19/17</u>
Asphalt Mixes with Unmodified Binders (PG 67 & Lower)			
Pay Item Number:	<u>334-1-13</u>	Tonnage Placed:	<u>341.4</u>
Pay Item Number:	_____	Tonnage Placed:	_____
Pay Item Number:	_____	Tonnage Placed:	_____
Additional Gallons (ARMI*):			
Base Index Month:	<u>May-15</u>	Base Asphalt Price Index:	<u>1.9365</u>
Current Index Month:	<u>Feb-17</u>	Current Asphalt Price Index:	<u>1.8230</u>
		Asphalt Index Difference:	<u>-0.0167</u>
Asphalt Mixes with Modified Binders (PG 76 & Higher)			
Pay Item Number:	_____	Tonnage Placed:	<input style="border: 1px solid green;" type="text"/>
Pay Item Number:	_____	Tonnage Placed:	_____
Pay Item Number:	_____	Tonnage Placed:	_____
Base Index Month:	_____	Base Polymer Price Index:	_____
Current Index Month:	_____	Current Polymer Price Index:	_____
		Polymer Index Difference:	_____
Asphalt Material (ASPHALT TREATED PERMEABLE BASE)			
Pay Item Number:	_____	Tonnage Placed:	_____
Base Index Month:	_____	Base Asphalt Price Index:	_____
Current Index Month:	_____	Current Asphalt Price Index:	_____
		Asphalt Index Difference:	_____
Navigation and Printing Functions			
<input type="button" value="Go To Main Sheet"/>		<input type="button" value="Go To Last Month Sheet"/>	
<input type="button" value="Save As Month Sheet"/>		<input type="button" value="Remove Last Month Sheet"/>	
Effective January 2007 Letting FORM: 700-050-66 (7/21/2015)			

EXAMPLE OF A CONTRACTOR'S CERTIFICATION OF QUANTITIES (FORM 700-050-66) Continued

STATE OF FLORIDA, DEPARTMENT OF TRANSPORTATION		FORM 700-050-66 CONSTRUCTION 02/17	
CONTRACTOR'S CERTIFICATION OF QUANTITIES ASPHALT MIXES WITH MODIFIED AND UNMODIFIED BINDERS (CONVENTIONAL PROJECTS)			CERTIFICATION NO.
			<u>9</u>
FINANCIAL PROJECT ID:	<u>654321-52-01</u>		
CONTRACTOR	<u>We Got Asphalt, Inc.</u>		
CONTRACT NO.	<u>X1234</u>		
PERIOD REPRESENTED BY CERTIFICATION:			
FROM (MO/DAY/YR)	<u>01/16/17</u>	TO (MO/DAY/YR)	<u>02/19/17</u>
ASPHALT MIXES WITH UNMODIFIED BINDERS (PG 67 & LOWER)			
BASE PRICE INDEX:	<u>1.9385</u>	CURRENT PRICE INDEX:	<u>1.8230</u> INDEX DIFFERENCE: <u>-0.0167</u>
	TONNAGE	GALLONS	MONTHLY PAYMENT
PAY ITEM NUMBER:	<u>334-1-13</u>	<u>341.4</u>	<u>4,974</u>
PAY ITEM NUMBER:			
PAY ITEM NUMBER:			
GALLONS OF ASPHALT CEMENT USED IN MIX: *		<u>4,974</u>	<u>-\$83.07</u>
ADDITIONAL GALLONS (ARMI):			
TOTAL GALLONS:		<u>4,974</u>	
TOTAL MONTHLY PAYMENT:			<u>-\$83.07</u>
ASPHALT MIXES WITH MODIFIED BINDERS (PG 76 & HIGHER)			
BASE PRICE INDEX:		CURRENT PRICE INDEX:	
		INDEX DIFFERENCE:	
	TONNAGE	GALLONS	MONTHLY PAYMENT
PAY ITEM NUMBER:			
PAY ITEM NUMBER:			
PAY ITEM NUMBER:			
TOTAL GALLONS OF POLYMER USED IN MIX: *			
TOTAL MONTHLY PAYMENT:			
ASPHALT MATERIAL (ASPHALT TREATED PERMEABLE BASE)			
BASE PRICE INDEX:		CURRENT PRICE INDEX:	
		INDEX DIFFERENCE:	
	TONNAGE	GALLONS	MONTHLY PAYMENT
PAY ITEM NUMBER:			
TOTAL MONTHLY PAYMENT:			
I certify that, based on my personal knowledge and well-founded belief following my own reasonable investigation, the tons and gallons (metric tons and liters) represented by this Certification are true and correct.			
 _____ Contractor's Authorized Agent		_____ Name of Company and email address	

Section 5.15

FINAL MEASUREMENTS

5.15.1 Purpose

To provide requirements and techniques to ensure Final Measured, Plan Quantity, and Lump Sum Pay Items are accurately and efficiently prepared and documented.

Measurements for bituminous material, earthwork, loose volume material in trucks, and Contractor certified quantities are addressed in other sections of **CPAM**.

5.15.2 Authority

Sections 20.23(3)(a) and 334.048(3), Florida Statutes (F.S.)

5.15.3 Reference

Standard Specifications for Road and Bridge Construction

Basis of Estimates Manual (BOE)

5.15.4 Final Measured Pay Items

On many items, quantities for progress and final estimates must be documented by measurements in the field as the work is constructed. This type of measurement is considered Final Measured. Monthly progress estimates are generated to reflect the work completed during each estimate period by summarizing the final measured quantities recorded. When the project is completed, the **Final As-Built Plans**, **Field Records**, and other Department approved forms are submitted, along with the other final estimate data, to substantiate the final quantities. Final measurement of pay quantities generally fall into one of the following categories:

- (A) **Area Measurement Pay Items:** When items are paid for by the area of the finished work, the dimensions for calculating these areas must be documented in the **Field Records**. This will be done in accordance with one of the following methods:
 - (1) The length will be the dimension shown on the plans or the station-to-station dimension actually constructed within the project limits designated by the Engineer. The width will be the dimension actually

constructed within the neat lines shown in the plans or designated by the Engineer/Project Administrator (PA) within the project limits.

- (2) The length and width will be measured in place, usually with length measured along the centerline of the construction work, and width measured at a right angle to the tangent of the centerline.
- (3) Stations and offsets must be recorded and used as latitudes and departures to calculate area. Curve corrections to account for a curved baseline must be applied to area calculations. When the baseline used for measuring areas is neither the project's centerline of construction nor a baseline for stationing shown in the plans, the baseline must be straight lined with beginning and ending points referenced to the centerline of construction by station and offset. The Final Measurements option of the FDOT Engineering Quantities Programs can be used to verify quantities.
- (4) Global Navigation Satellite System (GNSS) rovers can be utilized in lieu of traditional methods for area verification. Submit GNSS output, and reports to document area measurements. Ensure GNSS output includes accuracy and precision information.

NOTE 1: When changes to area measurement pay items are encountered in the field, the changes must be incorporated in the **Final As-Built Plans**. Reference the appropriate supporting documents must be made in the Plan Summary Boxes located within the Summary of Quantity Sheets in the Plans or, for contracts using an Estimated Quantities Report (EQR), on the **Pay Item Summary and Certification** form, per **CPAM 5.13**.

NOTE 2: If computer programs are used, check the data input and calculations, and submit the site source measurements with the computer output.

NOTE 3: Pay item adjustments are added/subtracted as line item adjustments in PrC and are not included in the Pay Item Quantity on the estimate.

- (B) **Linear Measurement Pay Items:** The dimension documented for items paid for by linear feet will be the length shown on the plans and in the Plan Summary Box/EQR or the length measured along the finished surface of the item.

- (1) GNSS rovers can be utilized in lieu of traditional methods for linear verification. Submit GNSS output and reports to document linear measurement. Ensure GNSS output includes accuracy and precision information.
- (C) **Volumetric Measurements Pay Items:** Field quantities for items paid for by volume in cubic units, are usually determined by one of the following methods:
- (1) For final measure concrete pay items, the area and thickness installed per the Specifications are used to determine the final quantity.

NOTE 4: Per **Specifications 346**, concrete pay adjustments for low strength concrete are required when acceptance strength test results fall below the specified minimum strength. See [Attachment 5-15-1](#) for examples of pay adjustment calculations for low strength concrete.
 - (2) For Subsoil and Channel Excavation, cross-section notes (and sketches) are recorded along both the original surface and the surface of the completed work. The volumes are calculated by hand or by use of approved computer programs.
 - (3) Cross-sections with end area and volume computations can also be used advantageously in calculating buildup volumes of spalled concrete members.
 - (4) GNSS rovers can be utilized in lieu of traditional methods for volume verification. Submit GNSS output and reports to document volume measurement. Ensure GNSS output includes accuracy and precision information.
- (D) **Per Each Measurement Pay Items:** Items paid for as a unit (e.g., fence gates inlets, raised pavement markers, etc.) will be tabulated by location in the **Field Record**.
- (1) GNSS rovers can be utilized for per each items. Submit GNSS output and reports to document item locations. Ensure GNSS output includes accuracy and precision information.

5.15.4.1 Spalled Concrete

The Spalled Areas option of the FDOT Engineering Quantities Programs can be used to verify quantities. See [Attachment 5-15-2](#) for examples of spalled concrete sketches. For

more information on concrete pavement criteria, see [Standard Plans Index 353-001](#). Specifications Section 347 provides acceptance criteria for non-structural concrete. Specifications 450 provides acceptance criteria for precast prestressed concrete.

5.15.4.2 Prestressed Concrete and Steel Piling

The final quantity for prestressed concrete and steel piling will be based on the length of piling furnished, driven, and accepted, including any adjustments authorized and approved by the Engineer. Refer to [Attachment 5-15-3](#), Prestressed Concrete Piling Payment Table and [Attachment 5-15-4](#), Steel Piling Payment Table.

Pile Logs are permanent records and must be submitted with the **Final Estimates Documentation** to completely and clearly support the final pay quantity.

Ensure there is no duplication of payment when cutoffs are transported to another bridge under the same contract for use as buildups or permanent piles. Also ensure there is no duplication of payment if the pile is extracted and driven elsewhere (the pile will be paid for at 30% of the contract unit price). See **CPAM 10.1** for further information.

5.15.4.3 Concrete Sheet Piling

The final quantity for Concrete Sheet Piling is the length of piling completed and accepted. Verify the pay quantity is based on the actual width of piling used, per **Specifications Section 455-11.7**. Ensure **Field Records** clearly document the top of pile and bottom of pile elevations constructed in the field. Check for compliance with the plan elevations. See **CPAM 10.1** for more information.

5.15.4.4 Drilled Shaft

The final quantity for Drilled Shafts is the length, in feet, completed and accepted as determined by **Specifications Section 455-23.1**.

Drilled Shaft Logs are permanent records and must be submitted with the **Final Estimates Documentation** to completely and clearly support the final pay quantity.

The Contractor is allowed to supply a Drilled Shaft casing with an inside diameter smaller than the specified Drilled Shaft diameter. In this case, the Contractor is required to provide an additional length of drilled shaft at no cost to the Department. The additional length required is determined by the following relationship. See **CPAM 10.5** for more information.

$$\text{Additional Length} = \frac{(D_1 - D_2)L}{D_2}$$

where:

D_1 = casing inside diameter specified = shaft diameter specified

D_2 = casing inside diameter provided ($D_2 = D_1$ minus twice the wall thickness)

L = authorized shaft length below ground for temporary casing methods or below casing for permanent casing methods.

5.15.5 Lump Sum Pay Items

Where the pay quantity for an item is designated to be a Lump Sum (LS) and the plans show an estimated plan quantity (secondary units), compensation for that item will be adjusted proportionately when a plan change results in a significant increase or decrease in the quantity from the estimated plan quantity (see **Specifications Section 9-3.2**). For these items, 1 LS will be paid on the pay item and overruns will be made as a line item adjustment, using adjustment type *LSAD -- LS Pay item Adj for Overruns*. The most common pay items eligible for this type of adjustment are Clearing and Grubbing (110-1) and Structural Steel (460-2). This adjustment method also applies to the proration of actual costs for the Partnering (999-16) and Electrical Power Service – Contribution in Aid of Construction (639-8) pay items. See the example below and contact the State Final Estimates Office for more information.

NOTE 5: The MOT LS pay item 102-1 is NOT to be adjusted by construction for overruns/underruns using the secondary units of days.

When the plans do not provide secondary units, a new unit price may be established through a Supplemental Agreement (SA) to compensate the Contractor for changes in the cost of completing the item. Likewise, when it is apparent that miscellaneous items, such as maintenance of traffic or grading, have been included in the LS price for clearing and grubbing, any adjustment in the final LS price must be negotiated and documented by SA.

NOTE 6: For Lump Sum Projects, see **CPAM 6.2**.

5.15.5.1 Clearing and Grubbing

Example of adjustment to LS Clearing and Grubbing pay item:

Plan Quantity (PQ) = 1 LS (20 AC)
Change in Plan Quantity = 1.23 AC
LS Unit Price = \$13,290

Determine if the change in plan quantity meets **Specifications Section 9-3.2** criteria for Substantial Error using secondary units:

$$\text{Check 1 (exceeds 5\%): } \frac{1.23 \text{ AC}}{20 \text{ AC}} \times 100 = 6.15\% > 5\% \quad (\text{does qualify})$$

$$\text{Check 2 (exceeds \$5,000): } 1.23 \text{ AC} \times \frac{\$13,290}{20 \text{ AC}} = \$817.34 \quad (\text{does not qualify})$$

Since only one of the checks need to qualify to be considered a substantial error, a pay adjustment will be applied.

$$\begin{aligned} \text{Final Pay Quantity} &= \frac{\text{PQ (Secondary Units)} + \text{Change in PQ (Secondary Units)}}{\text{PQ (Secondary Units)}} \\ &= \frac{20 \text{ AC} + 1.23 \text{ AC}}{20 \text{ AC}} = \frac{21.23 \text{ AC}}{20 \text{ AC}} = 1.0615 \text{ LS} = 1.06 \text{ LS} \end{aligned}$$

The PA must verify the quantity change before any line item adjustment to the LS item is made. For this example, 1 LS will be paid on the pay item and 0.06 LS will be applied as a *LSAD -- LS Pay item Adj for Overruns* line item adjustment.

5.15.6 Plan Quantity Pay Items

Plan Quantity Items under **Specifications Section 9-3** are based on backup information and calculations by the Designer. Documentation requirements are as follows:

- (A) The Plan Summary Boxes/EQR will show the Pay Item, Pay Item Description, Unit of Measure, Quantity, Location, and Stationing.
- (B) Area ID numbers are listed in the Plan Summary Boxes/EQR to reference corresponding area shapes within the Design files. For more information on how to find these areas, use the resource called [MicroStation Basics for Construction](#) on the State Construction website.
- (C) Should a dispute arise involving quantities for one or more of the plan quantity items, the Construction Office will request in writing, that the Designer provide detailed documentation or verify the concern for the plan quantity item(s) in question. The backup documentation must be produced within five (5) working days of the request from Construction per [BOE Chapter 8](#).

- (D) Plan Quantity Items will not be final measured. Only changes in the field or plan errors, as set forth in **Specifications Section 9-3**, are required to be documented as final measurements (see **CPAM 5.15.4**). The Construction Office will not make detailed calculation entries when no changes are made.
- (E) When no changes are made and only Plan Quantity is paid, a simple red check (✓) should be shown under the "F" or "Final" column within the Plan Summary Box. If a change occurs, then the differing quantity should be shown in the "Final" column of the Plan Summary Box. Add reference under the "Remarks" column on where the backup documentation can be found and mark up the station columns to the correct information, if necessary.
- (F) Deviation from the Plan Dimensions: **Specifications Section 9-3.4** requires the aggregate change must exceed 5% or \$5,000 of the original plan quantity for earthwork and more than \$100 for other items.
- (G) When changes in limits are authorized, the PA must show the revised quantities by showing revisions alongside the original Designer's calculations. If an additional area is added, the PA should show the area under a new empty row within the same pay item in the Plan Summary Box, and reference to the appropriate supporting documents must be made under the "Remarks" column. Additional plan sheets with Plan Summary Boxes can be added to the **Final As-Built Plans**, if empty rows or extra space is not available.
- NOTE 7:** Do not remove Designer quantity and/or work. Strike through and notate corrections appropriately.
- (H) Some method must be employed by the PA to prove or revise the Plan Quantity. Some of the suggested methods are as follows:
- (1) Field measure
 - (2) Scale from plans
 - (3) Station to station calculations
- (I) Plan Quantity Items on multiple-financial projects under one contract (multi-FINs) are to be evaluated per contract total, not per project total. Evaluation for multi-FINs must employ a correction to the "contract total". See [Attachment 5-15-6](#) for examples of Plan Quantity analysis on multi-FINs.

NOTE 8: When two or more projects are on the same contract and the total combined change falls below the Plan Quantity parameters as outlined in **Specifications Section 9-3.2**, no change is made to the Plan Quantity.

- (J) The PA must make an analysis of the accuracy of plan quantity items. It is not the intent of the Plan Quantity concept to require laborious measurements, but rather to save man hours through less field survey work.

5.15.6.1 Type 'A' and Type 'B' Fencing

Type 'A' and Type 'B' Fencing are Plan Quantity pay items. The Payment for **Extra Length Posts** will require an invoice from the Contractor. Compensation will be at invoice price plus 10%, per **Specifications Section 550-6.2**. The invoice will be submitted with the **Final Estimates Documentation**.

Example: Contractor submits an invoice for 20 extra length posts at an invoice price of \$250.00.

$$10\% \text{ of Invoice} = \$250.00 \times 10\% = \$25.00$$

$$\text{Invoice} + 10\% = \$250.00 + \$25.00 = \$275.00$$

A positive line item adjustment will be made to compensate the Contractor in the amount of \$275.00. It is recommended to reference the Construction **Electronic Document Management System (EDMS)** document number for the invoice in AASHTOware Project Construction (PrC).

5.15.6.2 Steel Sheet Piling

The final quantity for Steel Sheet Piling is the plan quantity area, in square feet completed and accepted. Ensure **Field Records** clearly document the top of pile and bottom of pile elevations constructed in the field. Check for compliance with the plan elevations.

5.15.6.3 Concrete Structures

The final quantity for concrete is the plan quantity volume in cubic yards completed and accepted. Ensure deductions and allowances are made appropriately per **Specifications Section 400-22.2**.

NOTE 9: Transitional sections and end sections are included in plan quantity of traffic railing pay items. See **CPAM 10.2** and **CPAM 10.3** for more information.

5.15.6.4 Movable Bridges

Movable Bridges are project specific. See the **Technical Special Provision (TSP)** for method of measurement and basis of payment.

5.15.6.5 Timber Structures

The final quantity for Timber Structures is the plan quantity in feet, board-foot measure, completed and accepted. Ensure the nominal commercial sizes shown in the plans or specified by the Engineer were used to calculate quantities. The lengths will be the overall lengths of the pieces as shown in the plans or the lengths incorporated in the structure if less than those shown in the plans.

5.15.6.6 Steel Grid Floors

The final quantity for Steel Grid Floors is the plan quantity area in square feet, completed and accepted. Station to station lengths and widths may be used in the calculation of the dimensions actually constructed within the limits designated by the Engineer for changes to the plan quantity. Determine that the proper deduction has been made for open joints in the floor as required to calculate plan quantity. See **Specifications Section 504** for more information.

5.15.6.7 Reinforcing Steel

The final quantity for Reinforcing Steel is the plan quantity, in pounds, incorporated into the completed work and accepted as determined by **Specifications Sections 415-7 and 415-8**.

5.15.6.8 Mowing and Litter Removal

The final quantity for mowing will be the project area multiplied by the number of completed mowing cycles. The individual areas of mowing completed will not be final measured. See **Specifications Section 107**. No field adjustments will be made to the project area.

This same concept applies to litter removal as well. Do not final measure or adjust the project area. Multiply the project area by the number of completed litter removal cycles to determine the final quantity. The number of litter removal cycles may differ from the number of mowing cycles, depending on the frequency directed by the Engineer per **Specifications 107-2.1**.

It is recommended to document the cycle dates in the Daily Work Reports and on Plan Summary Boxes or **Form 700-050-61, Final Measurement Miscellaneous**.

5.15.7 Degree of Accuracy

Degree of Accuracy for recording pay item quantities will be as indicated in [BOE Chapter 2](#).

5.15.8 Attachments

- [Attachment 5-15-1](#) Examples of Pay Adjustments for Low Strength Concrete
- [Attachment 5-15-2](#) Examples of Spalled Area Sketches
- [Attachment 5-15-3](#) Prestressed Concrete Piling Payment Table
- [Attachment 5-15-4](#) Steel Piling Payment Table
- [Attachment 5-15-5](#) Example of Plan Quantity Analysis
- [Attachment 5-15-6](#) Examples of Multi-FIN Plan Quantity Analysis

Attachment 5-15-1 EXAMPLES OF PAY ADJUSTMENTS FOR LOW STRENGTH CONCRETE

NOTE 10: The following pay adjustment examples are based on 28-day compressive strengths. Use the concrete compressive strength data at 56 days in lieu of the 28 days when the acceptance of concrete is at 56 days.

(A) Linear Foot Pay Item Example:

Given Information:

- Item #521-5-5, Concrete Traffic Railing (42" Vertical Shape)
- One pour today was 14 CY and covered 98.7 LF = 99 LF of railing
- Certified Invoice Price = \$575.00/LF
- Quantity of Concrete within the LOT = 14 CY
- 3 Cylinders were taken for the LOT. After 28 days, all cylinders failed.
- Required Strength of Class II Concrete = 3,400 Pounds per Square Inch (psi)
- Average Actual Cylinder Strength (after 28 days) = 2,850 psi

Payment Reduction per **Specifications Section 346-11.3**

$$\begin{aligned} \text{Reduction in Percentage of Strength} &= \frac{\text{Specified Minimum Strength} - \text{Actual Strength}}{\text{Specified Minimum Strength}} \\ &= \frac{3,400 \text{ psi} - 2,850 \text{ psi}}{3,400 \text{ psi}} = \frac{550 \text{ psi}}{3,400 \text{ psi}} = 0.1618 = 16.18\% \end{aligned}$$

Multiply the certified invoice price by the reduction in percentage of strength by the quantity affected to determine the amount to deduct:

$$\text{Reduction in Pay} = \$575.00/\text{LF} \times 16.18\% \text{ (use all decimals)} \times 99 \text{ LF} = \$9,210.47$$

Apply the reduction as a negative line item adjustment of $-\$9,210.47$ with remarks of "Reduction in Pay is due to 16% Compressive Strength Failure".

(B) Cubic Yard Pay Item Example:

Given Information:

- Pay Item #400-4-2: Concrete Class IV Endwalls
- This LOT represents 3 failed cylinders and 25 CY.
- Certified Invoice Price = \$570.00/CY
- Pay Item is paid to the 10th of a CY
- Required Strength of Class IV Concrete = 5,500 psi
- Average Actual Cylinder Strength (after 28 days) = 5,000 psi

Payment Reduction per ***Specifications Section 346-11.3***:

$$\text{Reduction in Percentage of Strength} = \frac{\text{Specified Minimum Strength} - \text{Actual Strength}}{\text{Specified Minimum Strength}}$$

$$= \frac{5,500 \text{ psi} - 5,000 \text{ psi}}{5,500 \text{ psi}} = \frac{500 \text{ psi}}{5,500 \text{ psi}} = 0.0909 = 9.09\%$$

Multiply the certified invoice price by the reduction in percentage of strength by the quantity affected to determine the amount to deduct:

$$\text{Reduction in Pay} = \$570.00/\text{CY} \times 9.09\% \text{ (use all decimals)} \times 25 \text{ CY} = \$1,295.33$$

Apply the reduction as a negative line item adjustment of -\$1,295.33 with remarks of "Reduction in Pay is due to 9% Compressive Strength Failure".

(C) Cubic Yard Pay Item Example (Plastic Properties Pay Reduction)

Given Information:

- Pay Item #400-2-11: Class II Concrete, Retaining Wall
- Contract Plan Quantity = 7 CY
- Certified Invoice Price of Concrete = \$150.00/CY
- 8 CY was delivered in a single ready-mix truck
- Rejected load due to a failed plastic properties test - placement continued

Payment Reduction per **Specifications Section 346-12**:

Pay Reduction (cast-in-place) = $2 \times (\text{Certified Invoice Price per CY}) \times (\text{Concrete Quantity in Rejected Load})$

$$= 2 \times (\$150.00/\text{CY}) \times (8 \text{ CY}) = \$2400$$

Apply the reduction as a negative line item adjustment of -\$2400 with remarks of “Reduction in Pay is due to Plastic Properties Failure”.

NOTE 11: For placing a rejected load of concrete in a precast product, plastic pay reductions will be two times the certified invoice price of the precast product multiplied by a reduction factor (% of concrete in the precast product).

(D) Each Pay Item Example (with Partial Payment):

Given Information:

- Pay Item #425-1-351: Inlets, Curb, Type P-5, <10'
- Contract Plan Quantity = 7 EA
- Certified Invoice Price = \$3,300.00/EA
- Partial Pay: 65% paid for bottom and 35% for top
- 18 CY was placed for 7 inlet tops
- Required Strength of Class II Concrete = 3,400 psi
- Average Actual Cylinder Strength (after 28 days) = 3,275 psi

Payment Reduction per **Specifications Section 346-11.3:**

$$\text{Reduction in Percentage of Strength} = \frac{\text{Specified Minimum Strength} - \text{Actual Strength}}{\text{Specified Minimum Strength}}$$

$$= \frac{3,400 \text{ psi} - 3,275 \text{ psi}}{3,400 \text{ psi}} = \frac{125 \text{ psi}}{3,400 \text{ psi}} = 0.0368 = 3.68\%$$

$$\begin{aligned} \text{Equivalent quantity effected due to partial pay} &= \text{Quantity affected} \times \text{partial pay percentage} \\ &= 7 \text{ EA} \times 35\% = 2.45 \text{ EA} \end{aligned}$$

Multiply the certified invoice price by the reduction in percentage of strength by the equivalent quantity affected to determine the amount to deduct:

$$\text{Reduction in Pay} = \$3,300.00/\text{EA} \times 3.68\% \text{ (use all decimals)} \times 2.45 \text{ EA} = \$297.53$$

Apply the reduction as a negative line item adjustment of -\$297.53 with remarks of "Reduction in Pay is due to 4% Compressive Strength Failure".

Attachment 5-15-2 SPALLED AREAS SKETCHES

(A) Spalled Area Example 1

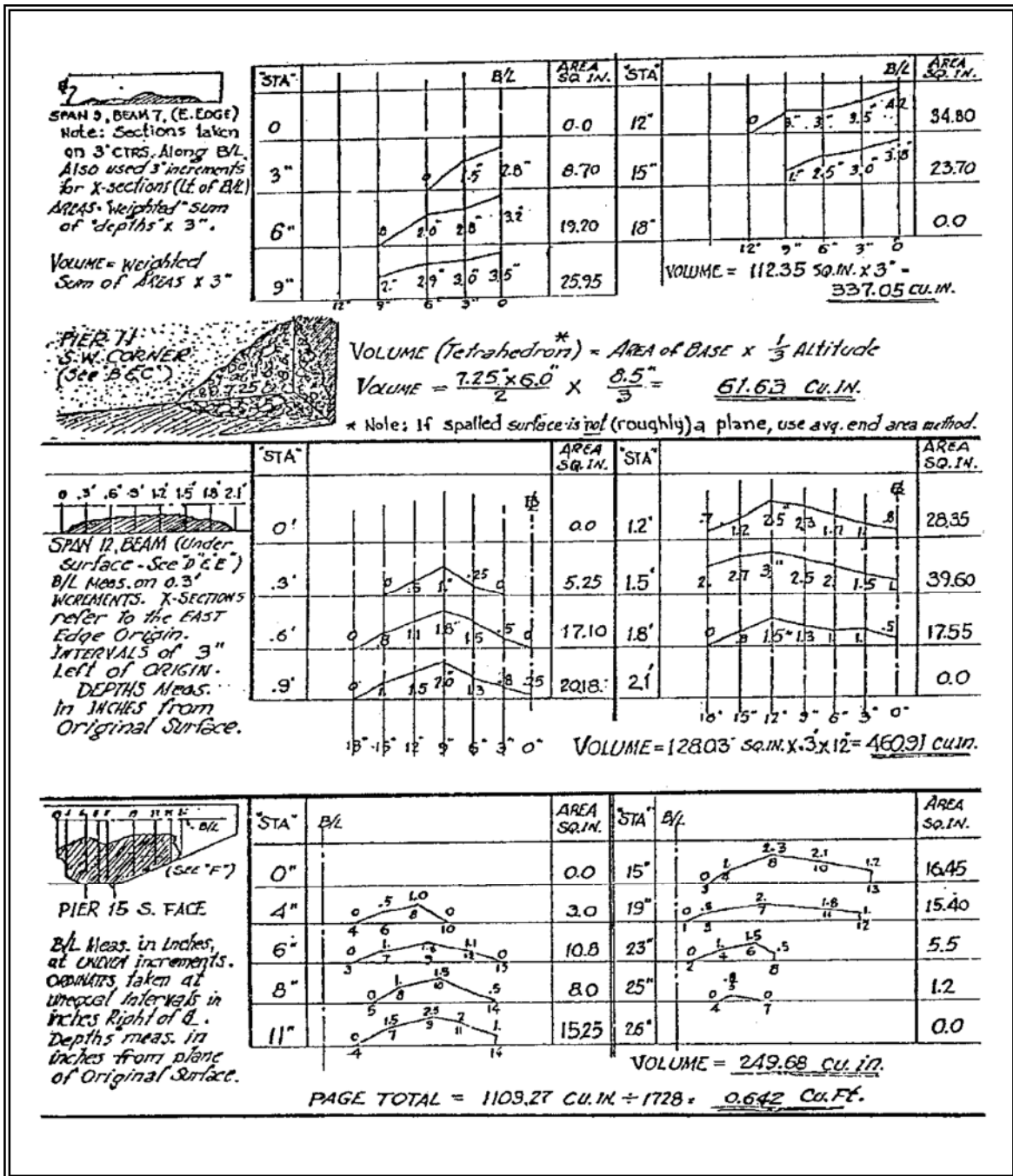

(B) Spalled Area Example 2

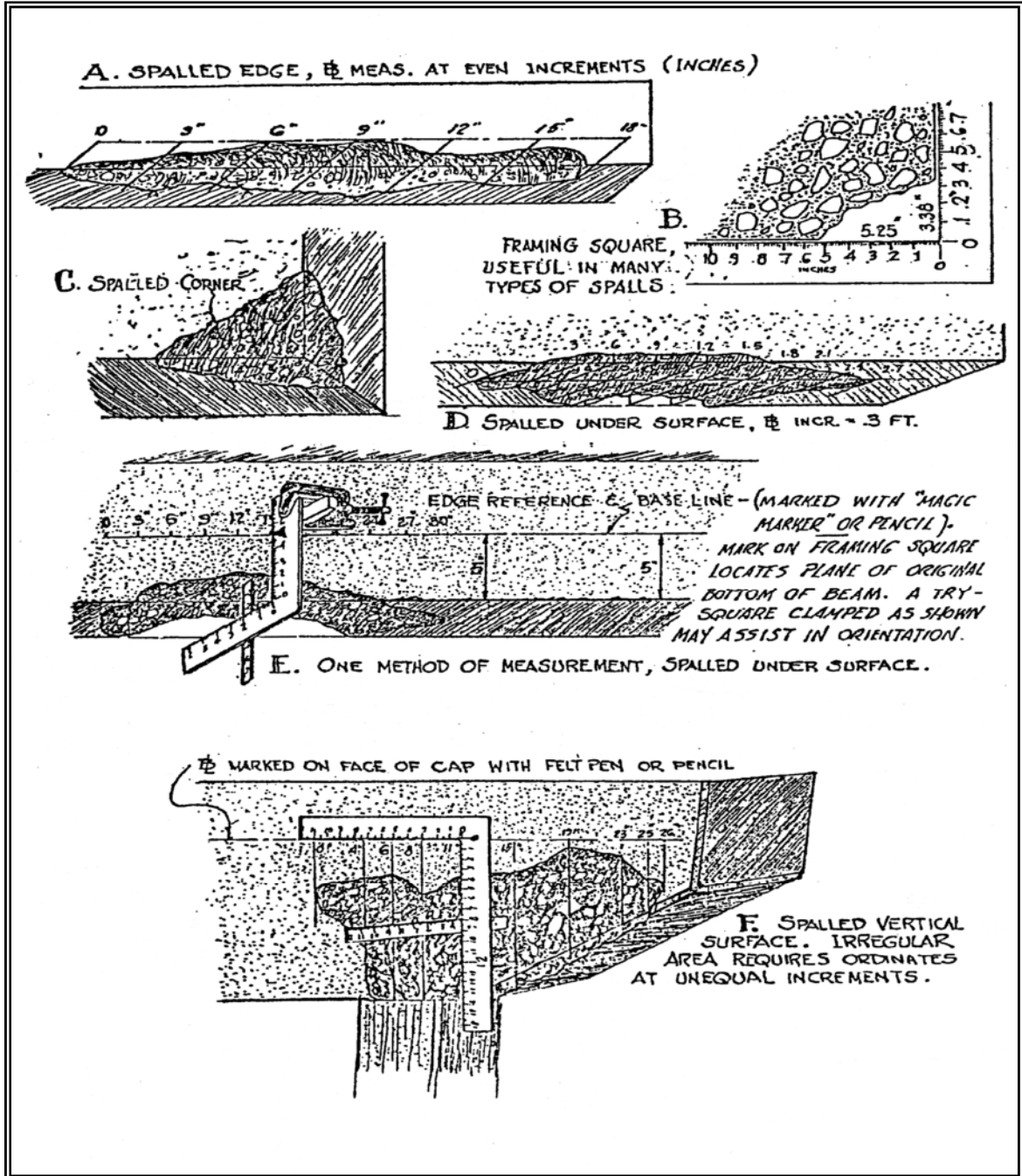

Attachment 5-15-3 PRECAST CONCRETE PAYMENT SUMMARY TABLE

ITEM	PAYMENT	455 SPEC.
Prestressed Concrete Piling	Authorized Pile Length – Casting length as authorized. Paid from head to tip (LF) at contract unit price	455-11.2.1
Prestressed Concrete Test Piling	Furnished, Driven, and Accepted (LF) at contract unit price	455-11.4
Cut-off (remaining piling)	No Payment (Cost included in the pay item for piling)	455-11.1
Driving of Test Pile Splice	No Payment	455-12.4
Static Load Tests	Number of static load tests, each, completed and accepted at contract unit price	455-11.11
Extracting and Replacing Piles		
(Contractor Responsible) Broken and irreparable piling, or mislocated piling	No payment for extraction or replacement	455-3 455-7.4
(Engineer elects) Piling driven below cut-off without achieving bearing and substituted with longer pile	Extraction paid as Unforeseeable Work	455-11.2.3
(Department Responsible) Broken and irreparable piling, or mislocated piling	Extraction paid as Unforeseeable Work	455-11.2.3
(Department Responsible) Replacement required for damaged or misplaced piling	Pay for both original and replacement piling under piling furnished	455-11.2.3
(Contractor elects) Piles without capacity - extracting of original pile to substitute for longer pile in lieu of splicing and build-up of original pile	Pay original authorized pile length + additional authorized length of buildup as piling + 30 ft of piling furnished for extracting original pile	455-11.2.3
Redriving of an extracted and "Undamaged" Pile	Paid at 30% of contract unit price for piling	455-11.2.3
Set-Checks & Redrives		
Test piles:		
4 initial set checks on each test pile performed the day of and working day following initial driving.	No Payment	455-11.9.1
Each additional set check (after the 4 mentioned above) ordered by the engineer and performed within the following working day of initial driving.	Pay 10 LF of piling furnished	455-11.9.1
Redrives ordered by the Engineer and performed after the following working day from initial driving	Pay 20 LF of piling furnished	455-11.9.3
Production piles:		
2 set-checks performed the day of initial driving and working day following the initial driving	No Payment	455-11.9.2
Each additional set check (after the 2 mentioned above) ordered by the Engineer and performed within the following working day of initial driving	Pay 10 LF of piling furnished	455-11.9.2
Redrives ordered by the Engineer and performed after the following working day from initial driving	Pay 20 LF of piling furnished	455-11.9.3
Dynamic Load Tests		
Test Piles:		
For instrumentation, materials, and labor	No Payment (included in the cost of test pile)	455-11.5
Production piles:		
For structures with 100% dynamic testing	No Payment (included in cost of production pile)	455-11.5
For structures without 100% dynamic testing	Pay 20 LF of additional pile	455-11.5

- For supplying and installing embedded gauges or attaching external gauges to each production pile for dynamic load testing prior to initial driving, authorized by the Engineer		
Other:		
Evaluating changes in Driving Equipment	No Payment	455-11.5
Evaluating integrity of pre-planned epoxy-bonded dowel splices	No Payment	455-11.5
Attaching dynamic testing equipment for set-checks or redrive	No Payment	455-11.5
Dynamic load testing when driving using followers	No Payment	455-11.5
Dynamic load testing on temporary piles	No Payment	455-11.5
Splices (Build-up) ≤ 5 feet below cut-off elevation		
Test Piles:		
Build-ups for test piles left in place as permanent production pile for drilling and grouting the dowels, etc.	9 LF of Production Pile	455-11.8
Pile Build-up length (left in place as permanent pile)	Additional LF at Production Pile unit price	455-11.4
Production Piles:		
Build-ups for production piles for drilling and grouting the dowels, etc.	9 LF of Production Pile	455-11.4 455-11.8
Pile Build-up length	Additional LF at Production pile unit price	455-11.2.1
Splices (Build-up) > 5 feet below cut-off elevation		
Test Piles:		
Splice Length Authorized – Non-driven	Additional LF of Production Pile as authorized for the additional test pile length	455-11.2.1 455-11.4
Splice Length Authorized – Driven for test purposes only	Additional LF of Test Pile as authorized for the additional test pile length	455-11.4
Splice (Material and Labor)	Pay 30 LF Production Pile	455-11.8
Driving of Unplanned Epoxy-bonded Dowel Splice	No payment	455-11.2.2
Production Pile:		
Splice Length Authorized	Additional LF of Production Pile as authorized for the additional piling length	455-11.2.1
Splice (Material and Labor)	Pay 30 LF Production Pile	455-11.8
Driving of Unplanned Epoxy-bonded Dowel Splice	Pay 10 LF of Production Pile	455-11.2.2
Preforming		
Test Pile and Production Pile:		
Once required penetration is achieved and authorized by the Engineer.	30% of the length of the preformed pile hole (test pile or production pile) from the existing surface or the bottom of any required excavation, whichever is lower, to the bottom of the preformed hole	455-11.12

Attachment 5-15-4 STEEL PILE PAYMENT SUMMARY TABLE

ITEM	PAYMENT	455 SPEC.
Steel Piling Length	Authorized Pile Length Paid from head to tip (LF) at contract unit price	455-11.3.1
Steel Test Piling	Furnished, Driven, and Accepted (LF) at contract unit price	455-11.4
Point Protectors	Per each authorized, furnished & installed	455-11.3.2
Cut-Off (remaining piling)	No Payment (Cost included in the pay item for piling)	455-11.1
Driving of Test Splice	No Payment	455-12.4
Static Load Tests	Number of static load tests, each, completed and accepted at contract unit price	455-11.11
Set-Checks & Redrives		
Test piles:		
4 initial set checks on each test pile performed the day of and working day following initial driving.	No Payment	455-11.9.1
Each additional set check (after the 4 mentioned above) ordered by the engineer and performed within the following working day of initial driving.	Pay 10 LF of piling furnished	455-11.9.1
Redrives ordered by the Engineer and performed after the following working day from initial driving	Pay 20 LF of piling furnished	455-11.9.3
Production piles:		
2 set-checks performed the day of initial driving and working day following the initial driving	No Payment	455-11.9.2
Each additional set check (after the 2 mentioned above) ordered by the Engineer and performed within the following working day of initial driving	Pay 10 LF of piling furnished	455-11.9.2
Redrives ordered by the Engineer and performed after the following working day from initial driving	Pay 20 LF of piling furnished	455-11.9.3
Dynamic Load Tests		
Test Piles:		
For instrumentation, materials, and labor	No Payment (included in cost of test pile)	455-11.5
Production piles:		
For structures with 100% dynamic testing	No Payment (included in cost of production pile)	455-11.5
For structures without 100% dynamic testing - For supplying and installing embedded gauges or attaching external gauges to each production pile for dynamic load testing prior to initial driving, authorized by the Engineer	Pay 20 LF of additional pile	455-11.5
Other:		
Evaluating changes in Driving Equipment	No Payment	455-11.5
Attaching dynamic testing equipment for set-checks or redrive	No Payment	455-11.5
Dynamic load testing when driving using followers	No Payment	455-11.5
Dynamic load testing on temporary piles	No Payment	455-11.5
Splices		

Test Piles:		
Splice Length Authorized – Non driven	Additional LF of Production Pile as authorized for the additional test pile length	455-11.8
Splice Length Authorized - Driven for test purposes only	Additional LF of Test Pile as authorized for the additional test pile length	455-11.8
Splice (Material and Labor)	Pay 20 LF of Production Pile	455-11.8
Driving of Splice for test purposes only	No Payment	455-11.8
Production Pile:		
Splice Length Authorized	Additional LF of Production Pile	455-11.8
Splice (Material and Labor)	Pay 20 LF of Production Pile	455-11.8
Driving of production pile splice	No Payment	455-11.8
Preforming		
Test Pile and Production Pile:		
Once required penetration is achieved and authorized by the Engineer.	30% of the length of the preformed pile hole (test pile or production pile) from the existing surface or the bottom of any required excavation, whichever is lower, to the bottom of the preformed hole	455-11.12

Attachment 5-15-5 PLAN QUANTITY ANALYSIS

STATE OF FLORIDA DEPARTMENT OF TRANSPORTATION
FINAL MEASUREMENTS "MISCELLANEOUS"

700-050-61
CONSTRUCTION
12/07
Page No. 1 of 1

Date: 12/29/2015

Pay item #: 520-17 CONCRETE CURB AND GUTTER, TYPE E

Plan ERROR; STA.436+36.88 SHOULD HAVE BEEN 436+26.88

Gross Length PQ from STA 436+36.88 to 436+77.27 =131.7 LF

Plan Error from STA 436+26.88 to 436+77.27 = 141.7 LF
Added additional of 10 LF

Unit Price = \$ 14.00 per LF

Total PQ = 963 LF

Plan Quantity Analysis:

10 LF X \$ 14.00 = \$ 140.00 < \$ 5,000

(10 ÷ 963) 100 = 1.03% < 5% both scenarios do not qualify to change PQ.

Therefore Pay PQ of 963 LF

65453

Attachment 5-15-6 MULTI-FIN PLAN QUANTITY ANALYSIS

(A) Plan Quantity Does Not Change

Given Information:

- Pay Item #160-4: Type B Stabilization
- Contract Plan Quantity = 70,000 SY
- Unit price = \$1.00/SY

Plan Quantity Analysis		
Contract T1234	Original Plan Quantity	Plan Errors
Project 1 of 2	50,000 SY	(-) 8,000 SY
Project 2 of 2	<u>20,000 SY</u>	<u>(+) 10,000 SY</u>
	70,000 SY	(+) 2,000 SY

What is the Final Pay Quantity for each job?

Step 1: Determine if the error exceeds 5%:

$$\frac{\text{Total Contract Plan Error}}{\text{Contract Plan Quantity}} = \left(\frac{2,000 \text{ SY}}{70,000 \text{ SY}} \right) \times 100 = 2.9\% < 5\%$$

Step 2: Determine if the error exceeds \$5,000:

$$\begin{aligned} &\text{Total Contract Plan Error} \times \text{Unit Price} \\ &= 2,000 \text{ SY} \times \$ 1.00/\text{SY} = \$2,000.00 < \$ 5,000.00 \end{aligned}$$

Both calculations in Step 1 and Step 2 do not qualify to change the original plan quantity for the contract; therefore, plan quantity for both projects will be paid due to final adjustment being less than 5% and less than \$5,000.00.

Final Type B Stabilization Quantity for Project 1 of 2 = 50,000 SY

Final Type B Stabilization Quantity for Project 2 of 2 = 20,000 SY

(B) Plan Quantity Does Change

Given Information:

- Pay Item #160-4: Type B Stabilization
- Contract Plan Quantity = 70,000 SY
- Unit Price = \$1.00/SY

Plan Quantity Analysis			
Contract T4321	Original Plan Quantity	Plan Errors	Field Changes
Project 1 of 2	50,000 SY	- 3,000 SY	- 320 SY
Project 2 of 2	20,000 SY	+ 8,000 SY	- 400 SY
	70,000 SY	+ 5,000 SY	- 720 SY

What is the Final Pay Quantity for each job?

Step 1: Determine if the error exceeds 5%:

$$\frac{\text{Total Contract Plan Error}}{\text{Contract Plan Quantity}} = \left(\frac{5,000 \text{ SY}}{70,000 \text{ SY}} \right) \times 100 = 7.1\% > 5\%$$

Step 2: Determine if the error exceeds \$5,000:

$$\begin{aligned} &\text{Total Contract Plan Error} \times \text{Unit Price} \\ &= 5,000 \text{ SY} \times \$1.00/\text{SY} = \$5,000 \quad (\text{Equal to } \$5,000) \end{aligned}$$

Only one of the criteria above must be met for plan errors to qualify for additional payment. Although the error did not exceed \$5,000, it did exceed 5% and qualifies for additional payment.

NOTE 12: All Field Changes will be added or subtracted under each job for final pay regardless of plan errors.

Project 1 of 2:

Original Plan Quantity = 50,000 SY
 Plan Error = -3,000 SY
 Field Change = -320 SY

Final Quantity = 46,680 SY

Project 2 of 2:

Original Plan Quantity = 20,000 SY
 Plan Error = +8,000 SY
 Field Change = -400 SY

Final Quantity = 27,600 SY

Section 5.16

EARTHWORK NOTES AND DOCUMENTATION

5.16.1 Purpose

This section includes the accepted methods for recording earthwork notes for final pay quantities and provides procedures for documenting various excavation items, such as channel, borrow, and subsoil excavation by the Resident Office (RO), both Department and Consultant Construction Engineering and Inspection (CCEI) staff. Guidelines for verifying earthwork items and FDOT survey requirements for construction surveys are also defined in this section. It is not the intent of these procedures to supersede the requirements in the *Surveying and Mapping Handbook*, but to enhance the process for documentation of quantities for the submittal of the *Final Estimates Documentation*.

5.16.2 Authority

[Section 20.23\(3\)\(a\)](#), and [Section 334.048\(3\)](#), Florida Statutes (F.S)

5.16.3 Reference

Chapter 472, Florida Statutes (F.S.)

[Rule 5J-17, Florida Administrative Code \(F.A.C.\)](#)

[Surveying and Mapping](#) (Procedure Topic 550-030-101)

5.16.4 General

Verify a project's existing and finished graded surfaces for conformity with the lines and grades shown in the plans through field survey and surface to surface comparison, or by an alternate method approved by the District Final Estimates Manager (DFEM) or the District Construction Engineer (DCE).

5.16.5 Bench Loop

A complete set of levels/bench loop run is required on all construction projects.

- (A) Check Levels: run a complete set of levels/bench loop from the first to the last Benchmark (BM) on the job, turning through all existing BMs, without adjusting the height of instruments (HI) or "correcting up" for any differences at individual

benches. If the Check Levels are within Third Order Accuracy, no additional check levels will need to be run. Third Order Accuracy requires the closure to be within:

$$0.05 \text{ ft.} \times \sqrt{(\text{distance in miles})}$$

5.16.6 Existing Surface Verification

Verify the method(s) used to derive the existing surface (i.e., location survey, aerial photos, old as-built, etc.) with the Engineer of Record. Also confirm the project's location and type (i.e., urban, rural, limited access, resurfacing, etc.).

Verify the existing surfaces and check for changed conditions, such as commercial development, city or county projects, excessive erosion, or work performed by FDOT Maintenance. Perform quick checks, such as spot elevation checks and slope stake verification, to establish if changed conditions exist.

If checks indicate the existing surface is unchanged, the Senior Project Engineer (SPE)/Resident Engineer (RE) may waive the pre-construction survey requirement. The SPE/RE will consider such things as type of work, monetary exposure, possible claims, and additional considerations before a waiver of survey is issued. **Form 700-050-35, Earthwork Survey Waiver** must be submitted to the District Final Estimates Manager before clearing and grubbing begins to justify and support waiving the pre-construction survey. The District Construction Engineer and/or District Final Estimates Managers must concur with the waiver. The **Earthwork Survey Waiver** must also be submitted with the **Final Estimates Documentation**. Listed below are some examples where surveys may be eliminated:

- (A) Small earthwork quantities
- (B) Minor milling and resurfacing projects
- (C) Minor widening projects

NOTE: An **Earthwork Survey Waiver** is not required on Design Build contracts.

Submit written notification to the Contractor of the Department's findings regarding acceptance or rejection of the existing surface as shown in the plans and obtain the Contractor's concurrence for actions taken. (See [Letter 5-16-1.](#)) Should the Contractor refuse to respond or reject the actions taken, a second notification will be submitted

advising the Contractor of the requirements as the Claimant per **Specifications Section 9-3**. (See [Letter 5-16-2](#).)

5.16.7 Pre-Construction Survey

Perform a pre-construction survey to verify the existing surface. This survey must be taken before the clearing and grubbing operation to adequately address existing surface conditions shown in the plans. The following conditions require a pre-construction survey:

- (A) New construction projects
- (B) Major widening projects
- (C) Construction of ponds
- (D) Subsoil Excavation
- (E) Channel Excavation

The pre-construction survey elevations are to be taken at break points shown in the plans and at other break points found to exist in the field within the Right-of-Way limits. See the **Surveying & Mapping Handbook** for further guidance.

Notify the Contractor in writing if there is a substantial change in areas where the Department is surveying. The survey notes along with any revisions to the existing surface resulting from the Department's survey will be provided to the Contractor. Should the Contractor wish to dispute the Department's survey, they must acquire their own survey of the disputed area, certified by a Professional Land Surveyor, and at no expense to the Department. The Contractor's field survey must be completed before any clearing and grubbing operations. (See **Specifications Section 9-3.2**.)

If a deviation exists between the existing surface and the preconstruction survey, the latter will replace the existing surface shown in the plans.

Annotate the **Final As-Built Plans** in red with corrections to plan quantity regarding erroneous surfaces discovered by the preconstruction survey. Calculate a new quantity by the approved method for the area surveyed using the existing surface and the pre-construction survey with the replacements mentioned earlier. Submit this information to the Contractor and the DFEM as soon as possible. A surface comparison can increase or decrease the quantities. Before allowing an adjustment, the difference in the increases and decreases (net result) must be checked against the limit set in the **Specifications**

Section 9-3.2. Verify the Contract's Special Provisions for changes on the amount of this limit.

5.16.8 As-Built Surfaces for Compliance

Document the project's as-built surfaces for compliance with plan dimensions and notify the Contractor of the Department's findings.

- (A) As soon as the finished graded surface in a section of the project is complete, perform quick checks, such as spot surveys, slope, or slope stake verification, at intervals or in areas deemed necessary by the SPE.
- (B) If quick checks indicate the as-built surface complies with the Plans, the SPE/RE may submit **Form 700-050-35, Earthwork Survey Waiver** to the District Final Estimates Manager with justification for waiving the as-built survey. The District Construction Engineer and/or District Final Estimates Managers must concur with the waiver.
- (C) If the quick checks of the as-built surfaces reveal any substantial differences from the finished graded surface shown in the plans, then perform a full as-built survey to determine areas not constructed to plan dimensions.
 - (1) It will be necessary to either re-grade such areas to bring them into conformance (this is done at the Contractor's expense) or reduce the pay quantities for the appropriate earthwork items within the areas not constructed to plan dimensions. Selection of which method to use is at the Department's discretion. The decision will be based on the circumstances which exist on the project.

5.16.9 Final Pay Quantities

Use surface to surface comparison to determine final earthwork volumes and adjustments to plan quantities. The Department encourages the use of **Trimble Business Center (Trimble)**; however, another approved software can be used or the PA and/or SPE may manually calculate these quantities/adjustments. If provided by the Engineer of Record, .GEN files can be used to generate earthwork quantities.

- (A) Approved software must have the capability to compare surfaces, calculate volumes, and produce reports that detail earthwork quantities within the proper limits.

- (B) Where any software has been used to calculate the earthwork volumes, the required compatible electronic files (e.g., Land XML and .csv) must be submitted with the ***Final Estimates Documentation*** so calculated quantities can be verified.
- (C) To determine the volume, each location must have an existing surface, finished graded surface, and as-built finished graded surface.
- (D) Any adjustment for finished graded surface revisions in earthwork items are limited to significant differences as defined in the ***Specifications Section 9-3.2***
- (E) The construction tolerance, as defined in ***Specifications Section 120-12***, will not be used or considered as a pay tolerance, nor will the tolerance be construed as defining a revised finished graded surface.
- (F) No adjustment will be made for the Contractor's failure to construct to plan dimensions, unless approved by the Engineer.

5.16.10 Minimum Requirements for Field Notes

Field notes are an important part of the ***Final Estimates Documentation*** for earthwork quantities. The following requirements are specifically written for earthwork pay items and are intended as minimum standards for any required note keeping. Ensure that minimum standard requirements are met, and additional details are added as needed to clearly document the field conditions.

- (A) Use the ***Form 700-050-61***, [Final Measurement Miscellaneous](#) or ***Field Books***. (See ***CPAM 5.14*** for requirements.) The use of the ***Final Measurement Miscellaneous Form*** is preferred since it results in savings to the Department.
- (B) Global Navigation Satellite System (GNSS) rovers can be utilized in lieu of traditional methods for surveying. Submit GNSS output, and reports to document data collection, surface verification and volume measurements. Ensure GNSS output includes accuracy and precision information, as well as pertinent field conditions and earthwork field note requirements indicated in these procedures.

- (C) Contractor's records/survey notes are not acceptable to meet these minimum requirements. As an exception, Contractor's survey notes may be used if obtained by a joint survey under the responsible charge by the Department or its representative.
- (D) Record the date, weather conditions, and the names of the individuals within the field crews on the page where each day's notes begin, or a record is stored within the data.
- (E) Identify Centerline or Baseline (CL/BL) shots, as well as their location in reference to the CL/BL (i.e., left, or right).
- (F) Ensure sketches are plain and legible, and spaced, so that figures are not written over one another. See the [Surveying and Mapping Handbook](#) for guidance.
- (G) Use a 2H or 3H pencil; never use a pencil soft enough to blur.
- (H) Record rod readings for earthwork notes (ground shots) to the nearest tenth (0.1) of a foot. Record rod readings on paved surfaces to the nearest hundredth (0.01) of a foot.
- (I) Only use Project BMs after a complete set of levels/bench loop has been run. The HI is established from shots made to the BM's. Record the HI to the nearest hundredth (0.01) of a foot (or better) above the field notes to which it applies and at the top of the following pages until a different HI is established. Underscore each HI with double lines.
- (J) Show BM location by description or station and offset in field notes and cross reference to the field record and page where BM elevations have been reestablished or verified. These level notes must carry the same closure tolerance as running check levels.
- (K) Only set Temporary Benchmarks (TBM) after the project check levels have been completed. Run a complete set of levels/bench loop from one of the project BMs to the TBM and back or to another established project BM.
- (L) When multiple HIs are required within only one cross-section, clearly indicate by brackets or other means to which HI the different shots are referenced.
- (M) Using Direct Rod Readings is not acceptable.

- (N) Use the same baseline and stationing for both the existing and finished graded surfaces. Exercise care where match lines are required to ensure that proper stationing on each baseline is reconciled, and that proper ties are made. Identify stations at which cut or fill begin (daylight lines) in the notes.
- (O) The maximum distance between cross-sections is 100 feet for flat terrain, and 50 feet for rolling terrain or closer where conditions warrant. In all cases, reflect the breaks in terrain that will substantially affect the final quantities in the notes.
- (P) Take full survey at all stations. Partial survey is not acceptable for earthwork purposes.

5.16.10.1 Plan Quantity Pay Items

Payment for Regular Excavation, Lateral Ditch Excavation, and Embankment made under the plan quantity concept are subject to the minimum standards as stated herein.

Pre-construction survey is required if the Department or the Contractor contends that there is a quantity error. If either party questions the plan quantity in accordance with **Specifications Section 9-3**, perform the data collection according to the methods outlined herein.

As-built survey is required to document engineer approved changes in earthwork limits. Pay quantity for the approved changes will be calculated as indicated for final measure pay items.

5.16.10.2 Final Measured Pay Items

Field records for final measured earthwork pay items are required.

(A) Borrow Excavation

As-built survey of the finished graded surfaces are required on all projects with Borrow Excavation if the shoulder elevations move out horizontally and/or vertically. A waiver of survey or alternate method may be approved by the SPE. Listed below are some examples where surveys may be eliminated:

- (A) Milling and resurfacing projects where shoulder elevation does not change
- (B) Projects that involve only earthwork around box culvert extensions

(C) Projects that involve restoring eroded sections

Project flushed slopes that are constructed of borrow material and proposed for final payment are to be surveyed. Any volume that is determined to be above the finished graded surface shown in the plans must be deducted.

Additional borrow material required to fill unauthorized excavation (beyond the lines and grades shown in the plans or authorized by the engineer) will not be paid.

NOTE: For truck measured borrow requirements, see **CPAM 5.14**.

(1) Fluff and Shrinkage

Consider fluff and shrinkage when vehicle load count is involved in reconciling quantities. A suggested formula for calculating **the Equivalent Truck Measured Volume** is:

$$\text{Compacted Fill Volume} \times (1 + \text{shrinkage factor}) \times (1 + \text{fluff factor})$$

NOTE: Shrinkage and fluff factors must be entered as a decimal.

EXAMPLE:

Compacted Fill Vol.:	1 CY
Shrink Factor:	20%
Fluff Factor:	20%

$$1.00 \text{ CY} \times 1.20 \times 1.20 = 1.44 \text{ CY}$$

(B) Subsoil Excavation

Provide detailed notes for subsoil excavation to explain the disposition of this material. Below are the minimum standards for these field notes: (See **Figures 5.16-1** through **5.16-4**).

(A) Record the authorized limits of muck excavation, as staked in the field in the earthwork notes for each pocket of muck excavation and should conform to control slopes set up by the **Standard Plans Index 120-001**, or as shown in the plans.

(B) The listing of the limits is generally generated from the plan depth and checked as they are staked in the field. If, during the excavation, the muck is found to be deeper than the plan depth, correct the **Final As-Built Plans** by striking

- through the original limit and recording the new authorized limit. As such, field records should be included, dated and initialed.
- (C) If subsoil excavation is required in an area where ditch excavation or the finished graded surface in the plans falls below the existing surface, the finished graded surface must be redeveloped to determine the authorized subsoil excavation. Identify this condition in the field notes.
 - (D) If extra depth muck excavation (depths greater than 5 feet) is encountered, record a list of the controlling elevations. (See **Figures 5.16-5** through **5.16-7**).
 - (E) The maximum interval for subsoil cross-sections is 50 feet. The beginning and ending of excavation must always have a full cross-section and be identified with a note (Begin Cut or End Cut), or designated as a zero area.
 - (F) Partial sections must be extended to the match line to produce a complete cross-section for each station.
 - (G) Earthwork notes for subsoil excavation must include a note for each pocket of excavation explaining the disposition of the unauthorized excavated material.
 - (H) Where subsoil excavation extends outside the plans lines or authorized by the PA (including allowable tolerances) and the space is backfilled with roadway or borrow excavation, ensure additional material is not included in payment.
 - (I) Original cross-sections for subsoil excavation are used as the basis for plan quantities of embankment and regular excavation. When changes to the area of subsoil excavation are made in the field, adjustments to embankment or regular excavation will be made to accommodate the subsoil change, per Spec 9-3.2.2.
 - (J) Station's pluses needed to obtain the maximum 50 feet interval or to obtain begin and end sections may be interpolated from the existing surface sections.
 - (K) The baseline (or centerline) used for location original cross-sections is the baseline of survey. When the centerline of construction, as used for final cross-sections and control slope limits, is different from the baseline of survey, some method must be employed to make the two surveys compatible with each other.

(C) Channel Excavation

Channel Excavation must be monitored closely since constant scouring and shoaling is normal in locations where this item is used.

- (A) Preconstruction survey is required prior to beginning of excavation.
- (B) As-Built survey of finished graded surfaces are required and must be compared with the finished graded surface shown in the plans to determine the limits of final pay quantity.
- (C) Re-survey if shoaling occurs after the as-built survey and prior to final acceptance of the job and the Engineer authorizes the shoaled material to remain in place. Deduct the volume of any such material remaining within the limits of channel excavation shown in the plans from the quantity of Channel Excavation.
- (G) Calculate an adjustment in quantity for the surveyed areas corresponding to the appropriate earthwork items using an approved method.

5.16.11 Electronic Data Collection on Construction Projects

(A) Requirements:

The methods described herein apply to surveys being performed on all Department contracts with automatic or semi-automatic total station equipment (radial survey).

NOTE: All survey data generated for construction must adhere to the Department's surveying standards.

In making the decision to use radial survey methods with total station equipment, the Consultant must assure the Department that the following field survey and data processing requirements can be met:

- (1) Confirm sufficient project control data (horizontal and vertical) exists or can be established to provide for all radial survey coverage.
- (2) Perform radial survey that meets the Triangulated Irregular Network (TIN) criteria for generating a Digital Terrain Model (DTM).

- (3) Provide software to compute an acceptable DTM from the radial survey data points and break line data point strings.
- (4) Field check the DTM surface, using cross-sections or profiles extracted from the DTM as compared to actual supplemental field survey.
- (5) Compute cross-sections from the DTM surfaces, perpendicular to defined alignments.
- (6) Compute earthwork volumes using Department approved surface to surface comparison software and methods.
- (7) Furnish all deliverables in a file format that is compatible with Department software, as defined in these procedures or in the contract scope of services.

(B) Project Control System:

Radial surveys must be referenced to the same project control system (baseline/centerline coordinates and benchmark datum) that was used for the Location and Design work. This basic requirement is to ensure that all survey information for the project can be related to the same reference system. This requirement can be met by occupying the existing control points that were established during the original ground survey. Or, if additional control is needed, the existing control system may be extended by:

- (1) Running a set of levels/bench loop through the required point or points.
- (2) Setting an unknown point, occupying it with the total station instrument and taking sufficient observations to define its position relative to the existing control system, as further described later.
- (3) Using technology, such as Global Navigational Satellite System (GNSS), and a set of levels/bench loop to supplement existing survey control.

(C) Calibration of Conventional Total Station equipment:

The Professional Surveyor and Mapper must take every precaution to ensure that the total station equipment is properly calibrated and is obtaining accurate field data. To

identify systematic errors inherent in any angle-measuring device, an axis test of the instrument will be performed on a regular interval, at least once weekly.

An acceptable axis test consists of pointing at a fixed target three or more times in the Face 1 (direct) telescope orientation and recording the horizontal direction (H) and vertical direction (V) readings for each pointing. Then, transiting or “flipping” the telescope and pointing at the same target an equal number of times in the Face 2 (reverse) telescope orientation and recording those values. The values of the horizontal and vertical angle for each pointing at the target are used to perform the computations to determine if the instrument is in need of adjustment.

Each year and whenever the difference between the mean of the direct and the mean of the reverse readings depart from 180 degrees by more than 30 seconds, the instrument must be taken out of service and be adjusted for collimation error.

Readjustment of the instrument’s crosshairs and the level bubbles will be done whenever their misadjustments affect the instrument reading by the amount of the least count, as specified for the Third Order Class II surveys. The total station instrument and retro-reflector prisms should be serviced on a regular basis and checked frequently on a calibration baseline of known distance.

(D) Establishing Position and Orientation of the Surveying Instrument:

When collecting field data by radial survey, there are two acceptable methods of establishing position and orientation of the instrument:

- (1) Setup Over Known Control Point: The instrument is setup over an existing control point, or one that can be related to the CL/BL of the project by the geometry and elevations furnished. The (XYZ) coordinate of the point setup over must be known. The height of the instrument above the control point must be measured and recorded. When the above is done, the position of the instrument has been established.
 - (a) To establish orientation of the instrument, a back sight will be made by pointing to a target of a known height on a second control point with a known (XYZ) coordinate. The instrument’s horizontal circle will be “zeroed” while pointing to the back sight control point. A back sight measurement of the horizontal direction, vertical direction, and distance (HVD) will be measured and recorded, including the target height. Position and orientation

is now completed. Radial measurements (HVD) may be made and recorded for new survey points. All horizontal angles will be expressed as angles measured in the direct (Face 1) position.

- (b) At the end of the field survey operations, the user will again sight the original back sight control point and record the measurements, to ensure that the instrument was not disturbed during survey operations.
- (2) Setup over an Unknown Point: When the instrument must be set-up in a location that does not have a prior known (XYZ) coordinate or is not tied to the control geometry and project benchmark datum, a semi-permanent monument should be set to perpetuate the location of the setup position. A bridge spike, hub and tack, iron rod, or equivalent marker, which will last throughout the data gathering operations, will serve this purpose. When the instrument is set-up, the height of the instrument above the set monument will be measured and recorded.
- (a) To establish the position of, and orient the instrument setup over the unknown point, the setup must be tied by field measurements to two points of known position. A back sight will be made to the first control point with a known (XYZ) coordinate. The horizontal measuring circle will be “zeroed” and HVD measurements will be made and recorded. A second control point with known coordinates will be selected and HVD measurements made and recorded. If available, a third control point with known coordinates may be selected and measured as a check on the position of the instrument. Target heights will also be recorded for all measurements.
 - (b) With the setup position properly established, radial measurements (HVD) to additional new survey points may then be made and recorded. All horizontal angular values will be expressed as angles measured in the direct (Face 1) position.
 - (c) At the end of the field measurements, the observer must always sight the original back sight and take check measurements and record them. Again, this is to ensure that the instrument has not been disturbed during survey operations.

(E) Field Observations (HVD) for DTM Surveys:

Radial survey procedures may be used to determine preconstruction surface elevations; and as the work of excavation or fill is accomplished, radial survey procedures may be used to determine final surface elevations. From DTM surfaces derived from radial survey methods, cross-sections can be generated as needed. This makes the DTM a valuable method for quantity surveys since cross-sections can be generated at any interval along an alignment on any of the DTM surfaces.

- (1) Collect data points that represent surface elevations on the ground at reasonable proximity to accurately represent the surface. It is also important to define breaklines along boundaries in the terrain where sharp or abrupt changes in surfaces occur. Break lines along the terrain “discontinuities” will be defined by the Professional Surveyor and Mapper, by indicating the connection of points representing the break line profiles.

Below is an example of a terrain surface defined by points and breaklines:

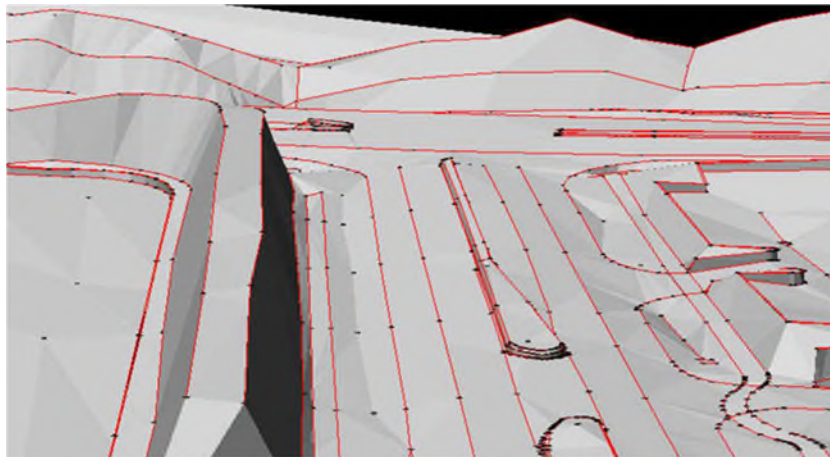

The Department requires that the field measurements (raw field data) be recorded and submitted in an acceptable format, as backup records for all DTM's.

- (2) Most electronic data collectors are capable of recording HVD data. If the Consultant elects to use a data collection system that only produces (XYZ) coordinates, the raw field data (HVD) must be recorded in the field records. Reduced data, (XYZ) coordinates, alone will not be acceptable.

- (3) To assist in verifying the field notes and as an aid in checking the reduced data, the survey party must prepare a sketch or layout of each setup and the area covered by observations. The sketch will show the setup point, the back sight point(s), and the identification data for the location of all field data taken from the setup position.
- (4) **Figures 5.16-8** through **5.16-11** provide examples of manual field records used in lieu of electronically collected data records.

(F) Generating the DTM Surfaces:

Surface-modeling techniques, such as using triangles to represent small continuous surface areas are known as the Triangulated Irregular Network (TIN). TIN has become the standard for terrain modeling for meeting engineering requirements. Each vertex of a triangle in the TIN is formed by a field measured data point, and is located by its (XYZ) coordinate. The TIN model is constructed by connecting these survey data points to their nearest neighboring points (in XY), forming a network (surface) of irregular triangles.

- (1) It is important that the survey crew understand the TIN methodology and the assumptions made by the software when they are taking the survey data points for a DTM using the TIN method.
- (2) Before the working cross-sections are generated for earthwork computations, the DTM surfaces must be field checked using randomly generated cross-sections or profiles extracted from the model. These cross-sections and profiles are then compared to actual ground shots taken to determine if the model matches the real-world terrain surface. This quality control check must be performed before TIN data is used in quantities calculations.

(G) Cross-Sections from DTM Surfaces:

Once the DTM surface has been computed and field checked, cross-sections may be computed at the specified interval along the CL/BL. If final quantities are to be compared to original plan quantities, the location of TIN extracted cross-sections must be the same as the cross-sections contained in the design plans.

- (1) Field measured quantities, such as subsoil excavation, may be referenced to a construction-established baseline, as long as the original and final measurements are from the same reference.

- (2) Design cross-sections, preconstruction cross-sections, and final cross-sections must all be compared in order to determine final pay quantities. It is absolutely essential that all field data be referenced to the same alignment and station values.

(H) Survey Deliverable Data:

Requirements necessitate the retention of surveying records and backup data to support the quantity computations. This requires that the RO personnel deliver certain data in a format that can be retained, verified, and, if necessary, be used to replicate the processed data at some future point in time. For products that need to be signed and sealed by a Professional Surveyor and Mapper, reference **Standards of Practice** as set forth in **Rule Chapter 5J-17 F.A.C.**

- (1) When radial survey is used, project personnel must use the approved survey data formats authorized for use on FDOT surveys. **Trimble** or any other FDOT approved software should be used to calculate final pay earthwork volumes. If a consultant or CEI prefers to use any other software for radial surveying than that authorized for use by FDOT, they must show the Department's District Location Surveyor (DLS) that an alternate system is able to produce the electronic files required for delivery to the Department as outlined in this section. Prior to the work commencing, the consultant must receive an approval letter signed by the DLS stating that a proposed alternate system is able to produce the electronic files required by the Department.
- (2) The RO personnel must submit:
 - (a) The pre-construction survey data files produced by the data collection system , regardless of format.
 - (b) The original field survey measurements in the approved file format for raw survey measurements (.XML format).
 - (c) Any changes not observed in the field must be annotated in redline markup on the **Final As-Built Plans** and include an explanation of each change.

- (d) The reduced and processed field survey data in the standard comma delimited text file format with labeled column header information.
- (e) The survey control used to reduce and process the original field survey data in the standard comma delimited text file format with labeled column header information.
- (f) All output reports generated by the programs used to reduce and process the field survey data.

NOTE: It is the responsibility of the DLS or the delegate to verify survey data processing results before being accepted by the Department.

- (3) At the completion of work, submit to the DLS or the delegate all files described herein, any additional reports and forms required by the DLS, such as a **DTM Certification Form** (if applicable), and a **Project Certification Letter**.
- (4) All reports related to the project.
- (5) All output files for interfacing to **Trimble**, including alignment and other geometric data (profiles) in .XML file format.
- (6) All graphics files of planimetric detail in both 2D and 3D MicroStation or AutoCAD file format.
- (7) All DTM TIN models represented as 3D MicroStation or AutoCAD files.
- (8) A project Journal file that describes:
 - (a) For each DTM, a description of the surfaces, DTM settings used, survey data used to define the surface(s). The Journal will include the alignment names and scan/pattern lines used to cut cross-sections, cross-section file names with their usage/application, and contour settings.
 - (b) For each output report generated, describe the purpose of the report and the information needed to re-generate the report.

- (c) For each output file, describe the purpose of the file and the information needed to re-generate the file.
- (9) All data submitted must be identified with the Financial Project Identification Number(s), State Roadway Number(s), Consultant Identification (names, addresses, etc.), and Contract number.
- (10) No project will be considered acceptable or complete until all deliverables are submitted and approved by the appropriate FDOT authority.

5.16.12 Boilerplate Letters

Final Estimate Boilerplate Letters can be found on the [State Final Estimate SharePoint site](#) (Internal Use Only) in editable format.

NOTE: The letters are used to convey necessary information to concerned parties throughout the close out process. The letters and memos are templates containing common boilerplate language. The DFEO representative will choose the appropriate paragraphs for a specific contract and delete the paragraphs and instructions which do not apply. No boilerplate letter can cover all situations that might arise. Occasionally, it may be necessary to insert additional paragraphs drafted to fit the circumstances arising on a specific contract (such as addressing bonds or value-added items).

Letter 5-16-1..... Preconstruction Survey Waiver Letter
Letter 5-16-2..... Follow-up Preconstruction Survey Waiver Letter

5.16.13 List of Figures Following This Chapter

Figure No. 5.16-1	Original Subsoil-Cross-section Notes
Figure No. 5.16-2	Final Subsoil-Cross-section Notes
Figure No. 5.16-3	Subsoil-Cross-section Limits Notes
Figure No. 5.16-4	Final Subsoil-Cross-section Notes
Figure No. 5.16-5	Control Elevations for Extra-Depth Muck
Figure No. 5.16-6	Extra-Depth Muck Case I
Figure No. 5.16-7	Extra-Depth Muck Case II
Figure No. 5.16-8	Manuscript Field Book Notes
Figure No. 5.16-9	Example Field Survey .TXT File
Figure No. 5.16-10	Manuscript Field Book Notes
Figure No. 5.16-11	Notes on Grid Paper

**Figure 5.16-1
 ORIGINAL SUBSOIL – CROSS-SECTION NOTES**

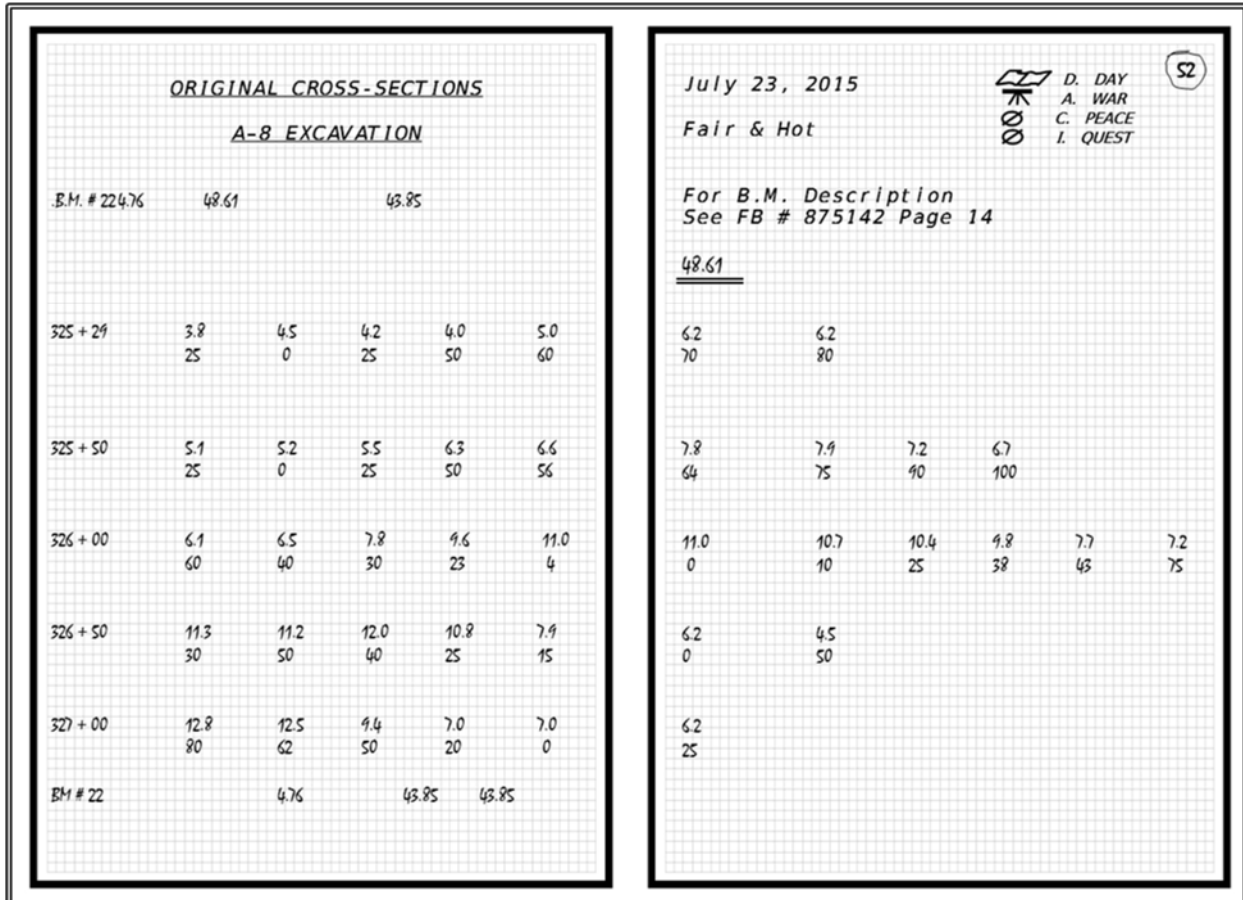

Figure 5.16-2
FINAL SUBSOIL – CROSS-SECTION NOTES

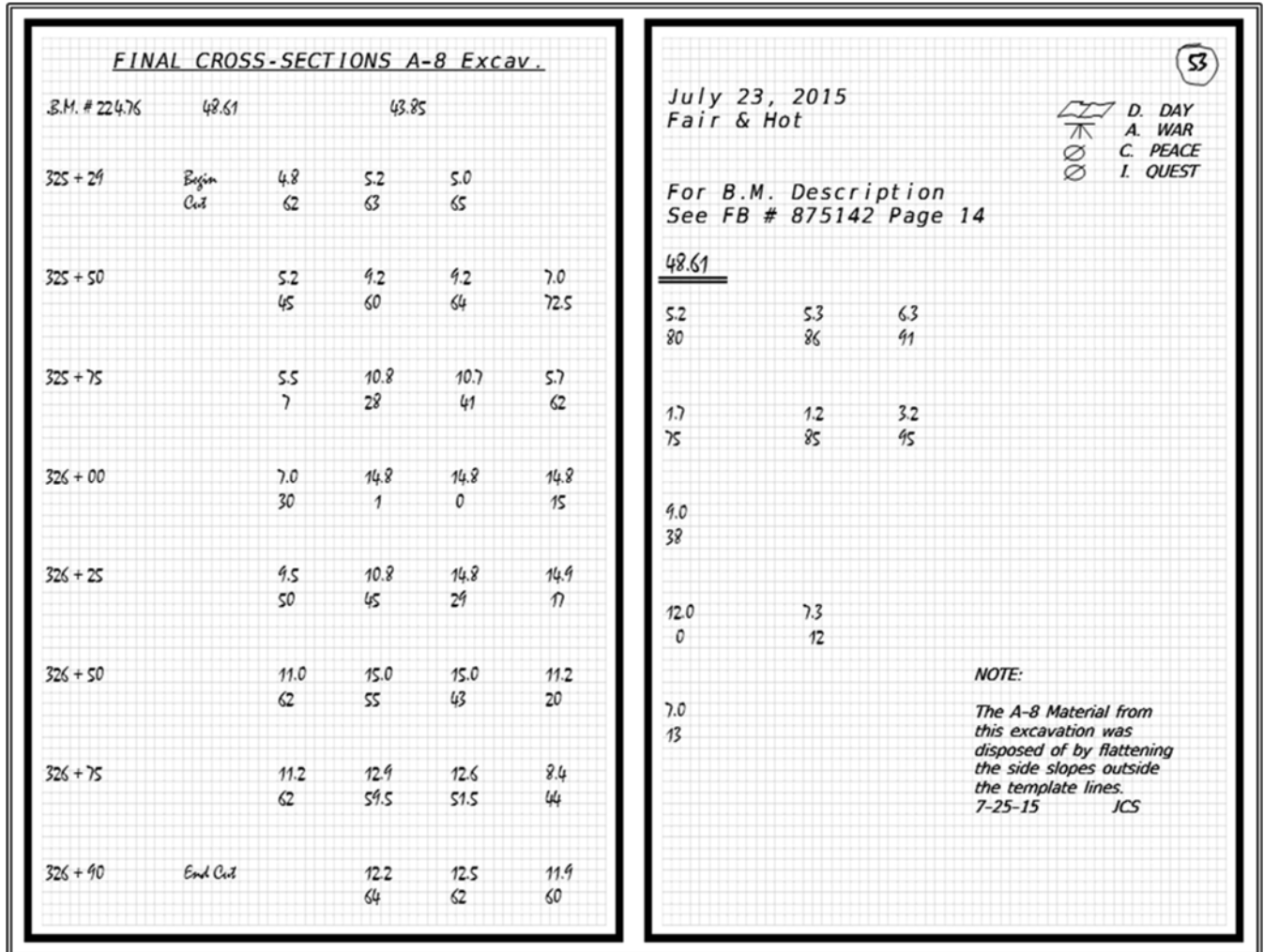

Figure 5.16-3
SUBSOIL – CROSS-SECTION LIMITS NOTES

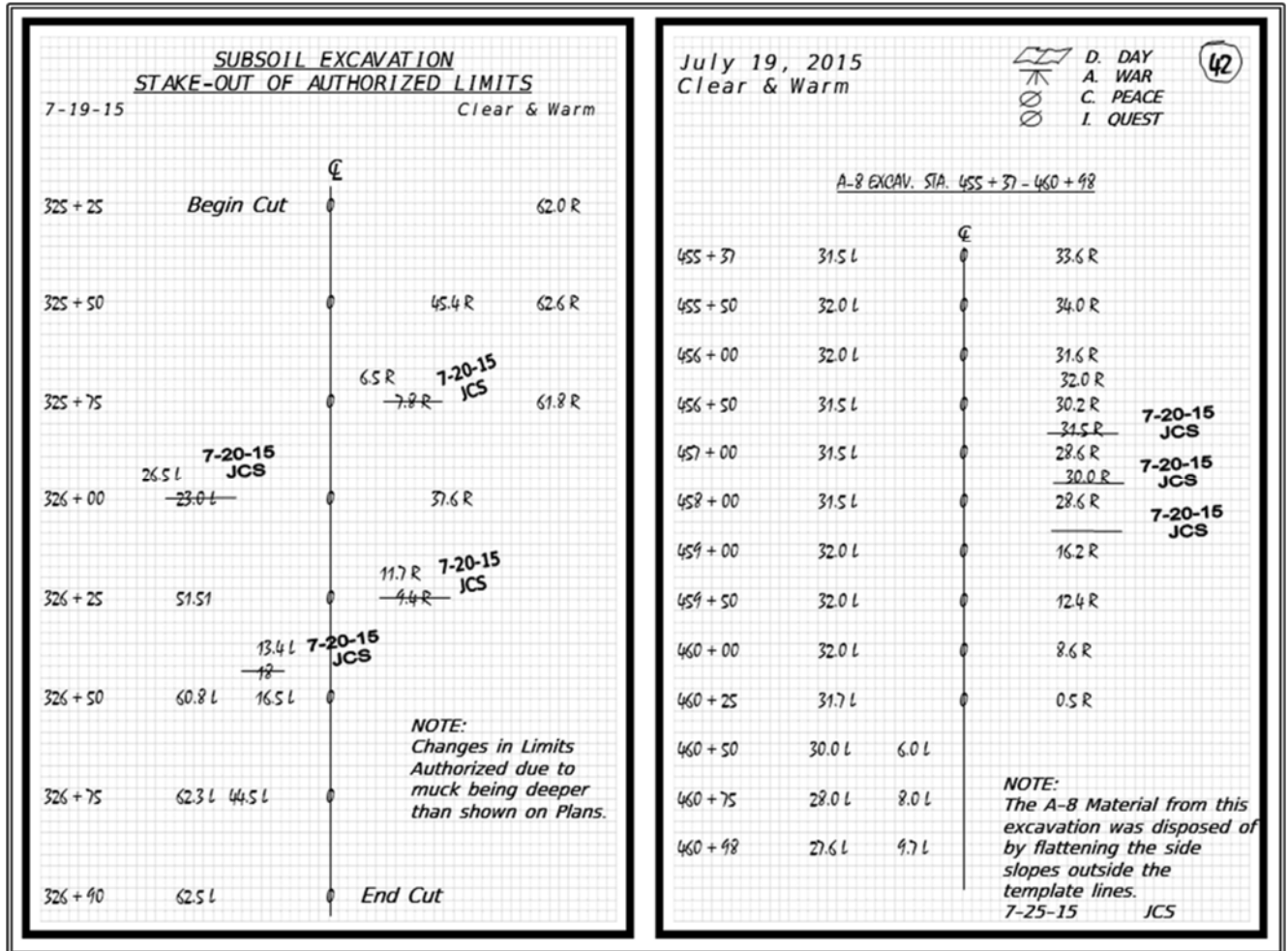
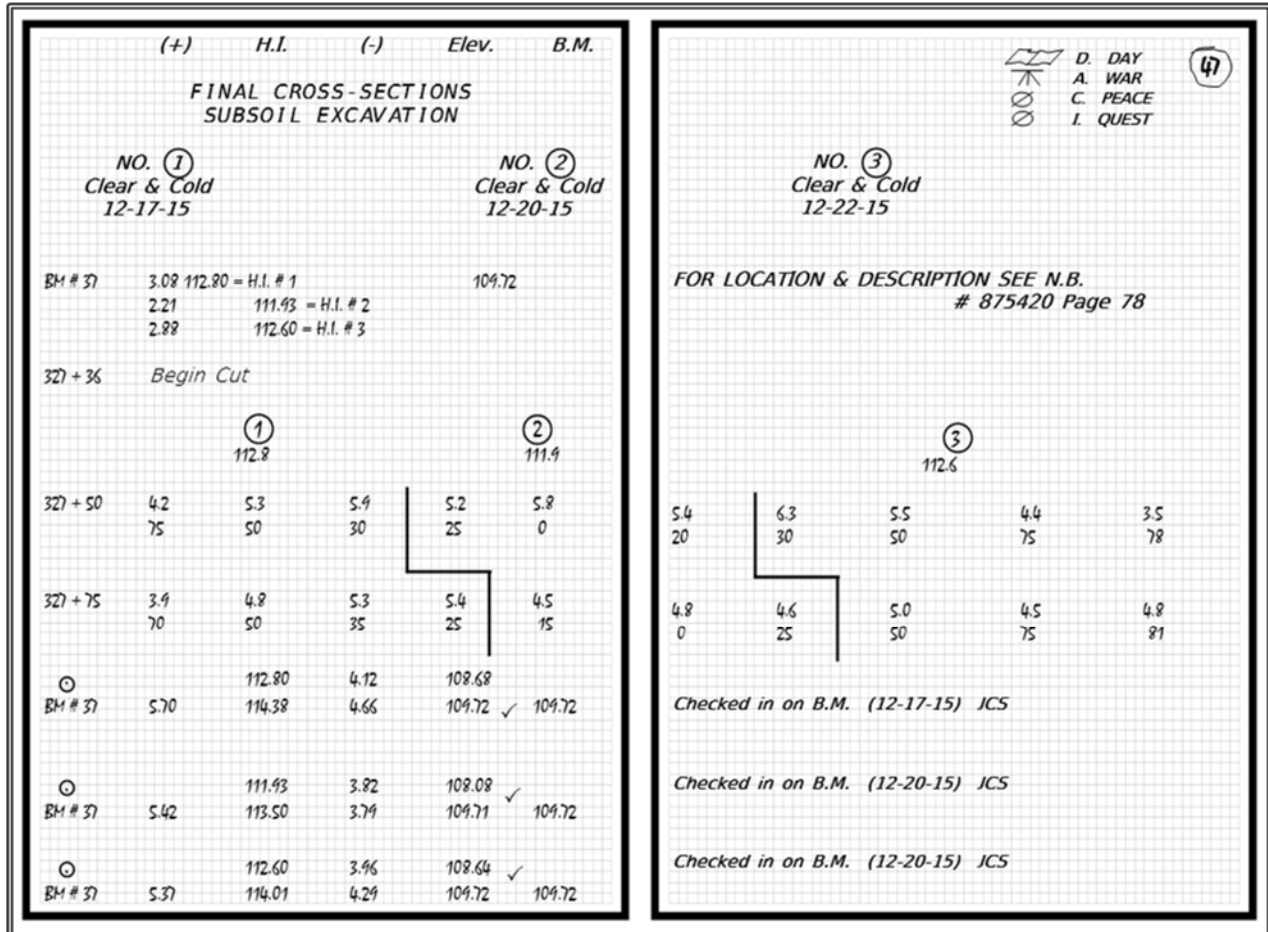

Figure 5.16-4
FINAL SUBSOIL – CROSS-SECTION NOTES



**Figure 5.16-5
 CONTROL ELEVATIONS FOR EXTRA-DEPTH MUCK**



<u>CONTROL ELEVATIONS FOR EXTRA DEPTH A-8 EXCAVATION</u> (Taken from Contract Plans)				<u>STAKE - OUT OF CONTROL ELEVATIONS</u>			
	Low Pt. Elev.	Low Pt. Dist.	Corr.	Control Elev.			
155 + 37	62.0	30.0 R	- 5.0	57.0	155 + 37	57.0 50	57.0 0 57.0 50
156 + 00	62.3	28.5 R	- 5.0	57.3	156 + 00	57.3 50	57.3 0 57.3 50
156 + 50	62.7	26.0 R	- 5.0	57.7	156 + 50	57.7 50	57.7 0 57.7 50
157 + 00	63.3	24.3 R	- 5.0	58.3	157 + 00	58.3 50	58.3 0 58.3 50
158 + 00	63.5	20.5 R	- 5.0	58.5	158 + 00	58.5 50	58.5 0 58.5 50
159 + 00	63.7	21.2 R	- 5.0	58.7	159 + 00	58.7 50	58.7 0 58.7 50
by JCS 7-18-15 ✓ H.I.R.				<div style="display: flex; justify-content: space-between;"> <div> <p>July 22, 2015 Clear & Hot</p> </div> <div style="text-align: right;"> <p> I. B. TIRRED</p> <p> I. SEAY</p> <p> Y. U. PROP</p> </div> </div>			

Figure 5.16-6 EXTRA-DEPTH MUCK CASE I

CASE I:

IN EVERY CASE, THE POINT OF REFERENCE FOR DETERMINING EXTRA DEPTH SUBSOIL EXCAVATION SHOULD BE THE LOWEST ELEVATION THAT MUCK IS SHOWN ON THE PLAN CROSS-SECTION AND THIS ELEVATION PROJECTED HORIZONTALLY ACROSS THEIR ENTIRE CROSS-SECTION IN MAKING THIS DETERMINATION. EACH CROSS-SECTION SHALL BE CONSIDERED SEPARATELY.

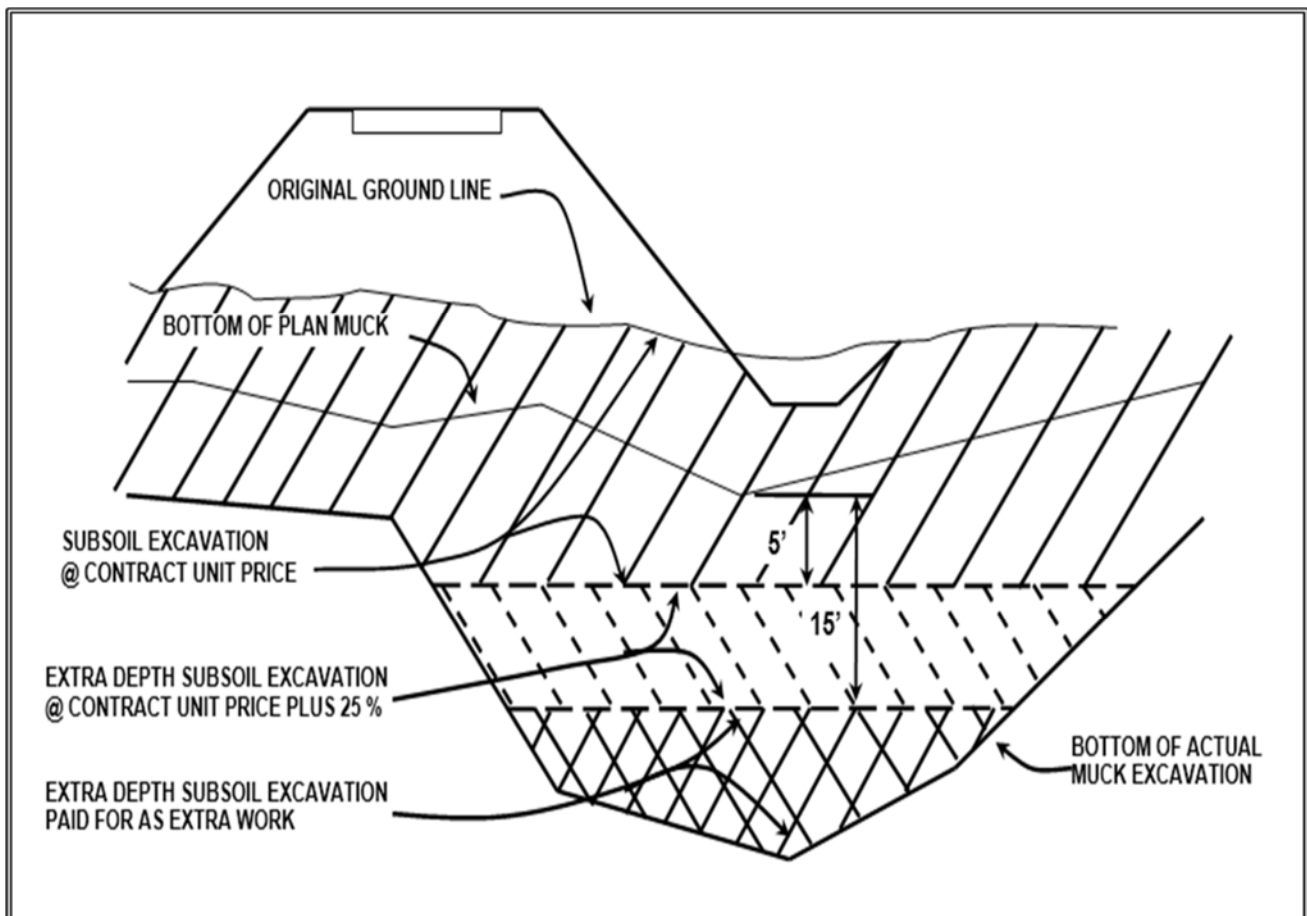

**Figure 5.16-7
EXTRA-DEPTH MUCK CASE II**

CASE II:

WHEN SUBSOIL EXCAVATION IS ENCOUNTERED WHERE NONE WAS SHOWN ON THE PLANS, EITHER IN SEPARATE AREAS OR AS AN EXTENSION TO AREAS THAT WERE SHOWN, THE POINT OF REFERENCE SHALL BE THE LOWEST ELEVATION ON THE GRADING TEMPLATE.

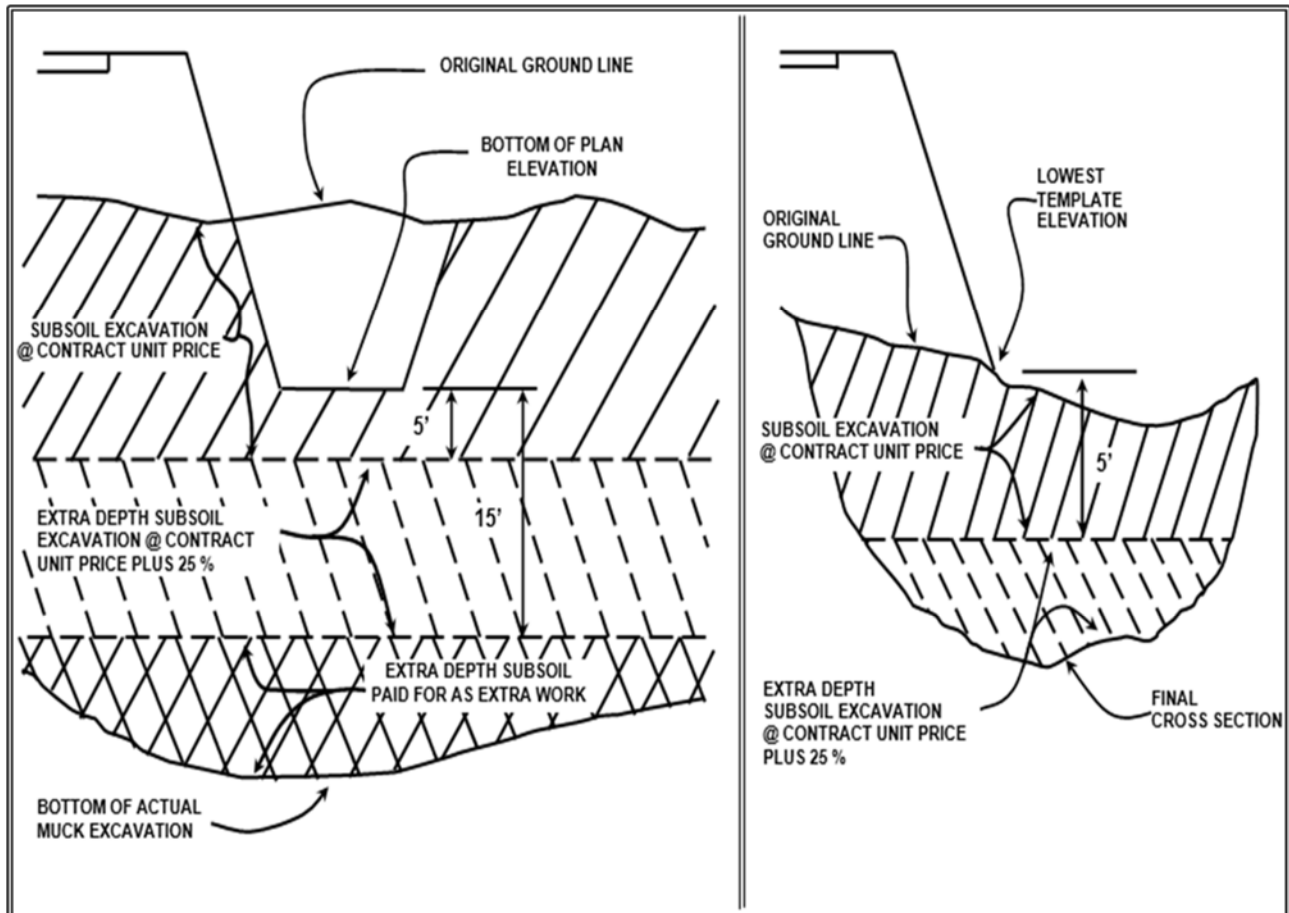

Figure 5.16-8 MANUSCRIPT FIELD BOOK NOTES

MANUSCRIPT FIELD BOOK NOTES-FDOT RADIAL & DTM FIELD SURVEYS			
READER INFORMATION:			
DATE: <u>05-26-15</u>	FIN PROJ. NO: <u>1979341-52-02</u>		
FIELD PARTY: <u>Arnold readman</u> <input checked="" type="checkbox"/> <u>Jerry Gypson</u> <input type="checkbox"/> <u>Jace Ketchum</u> <input checked="" type="checkbox"/>	DSECS: <u>Broward Blvd Connector</u>		
	S.P. ZONE: <u>E</u> (N/E/W) MAD: <u>23</u> (27/83)		
	UNITS: <input checked="" type="checkbox"/> ENGLISH: <input type="checkbox"/> METRIC		
INSTRUMENT NAME: <u>Top Con GTS-38</u>			
WEATHER DATA: <u>Warm, partly cloudy</u>			
AXIS TEST:	FACE 1 (direct)		FACE 2 (reversed)
1) H: <u>0 0 1</u> V: <u>105 0 10</u>	H: <u>180 0 1</u>	V: <u>254 54 66</u>	
2) H: <u>0 0 1</u> V: <u>105 0 12</u>	H: <u>179 59 57</u>	V: <u>254 54 68</u>	
3) H: <u>359 59 58</u> V: <u>105 0 10</u>	H: <u>179 59 54</u>	V: <u>254 54 65</u>	
4) H: <u>0 0 1</u> V: <u>105 0 12</u>	H: <u>180 0 2</u>	V: <u>254 54 65</u>	
COMMENTS: <u>See attached for instrument errors</u>			
INSTRUMENT SETUP INFORMATION:			
NAME OF POINT OCCUPIED: <u>A-1</u>			
STAMPING: <u>RLS # 4502</u>	(may be a known point or unknown point)		
FEATURE INFO: <u>5/8" Rod & Cap</u>	SURFACE: <u>Ground</u>	<input checked="" type="checkbox"/> ON <input type="checkbox"/> OFF	
MEASURED INSTRUMENT HEIGHT: <u>4.97'</u>			
X: _____	Y: _____	Z: _____	
COMMENTS: <u>Pt. in front of 7-11 store str 12+29.112.6' LI.</u>			
BACKSIGHT NO. 1			
NAME OF CONTROL POINT SIGHTED: <u>C-1</u>			
STAMPING: <u>Jones 1936</u>	(XY AND Z MUST BE KNOWN)		
FEATURE INFO: <u>Brass Disk</u>	SURFACE: <u>N/A</u>	<input type="checkbox"/> ON <input type="checkbox"/> OFF	
HORIZ ANGLE (DDMMSS) <u>129 41 10</u>	VERT ANGLE (DDMMSS) <u>89 59 58</u>		
DISTANCE: <u>268.91'</u>	SLOPE <input checked="" type="checkbox"/>	HORIZONTAL	
TARGET HEIGHT: <u>5.0'</u>			
X: <u>429 493.750</u>	Y: <u>667 143.749</u>	Z: <u>4.35</u>	
COMMENTS: _____			
BACKSIGHT NO. 2			
NAME OF CONTROL POINT SIGHTED: <u>C-2</u>			
STAMPING: <u>Jones 1936 AZMK</u>	(XY AND Z MUST BE KNOWN)		
FEATURE INFO: <u>Brass Disk</u>	SURFACE: <u>N/A</u>	<input type="checkbox"/> ON <input type="checkbox"/> OFF	
HORIZ ANGLE (DDMMSS) <u>65 28 44</u>	VERT ANGLE (DDMMSS) <u>90 0 1</u>		
DISTANCE: <u>428.15'</u>	SLOPE <input checked="" type="checkbox"/>	HORIZONTAL	
TARGET HEIGHT: <u>5.0'</u>			
X: <u>429 676.274</u>	Y: _____	Z: _____	
COMMENTS: _____			
BACKSIGHT NO. 3			
NAME OF CONTROL POINT SIGHTED: <u>SA 12+25</u>			
STAMPING: _____	(XY AND Z MUST BE KNOWN)		
FEATURE INFO: <u>Nail in cap</u>	SURFACE: <u>N/A</u>	<input type="checkbox"/> ON <input type="checkbox"/> OFF	
HORIZ ANGLE (DDMMSS) <u>69 59 58</u>	VERT ANGLE (DDMMSS) <u>90 0 2</u>		
DISTANCE: <u>121.63'</u>	SLOPE <input checked="" type="checkbox"/>	HORIZONTAL	
TARGET HEIGHT: <u>5.0'</u>			
X: _____	Y: _____	Z: _____	
COMMENTS: <u>PC of 3 26 30 curve on Broward Blvd Connector</u>			
(Note: Horiz. Angle mandatory. Vert. Angle & distance optional)			

Figure 5.16-9
EXAMPLE .TXT FILE

Subsoil ascii file AA.txt - Notepad

File Edit Format View Help

20001,441428.847434,1598240.583179,8.249073,1175+50
20002,441428.735092,1598238.125447,8.759081,1175+50
20003,441430.016701,1598238.125447,8.759081,1175+50
20004,441430.980975,1598238.125447,8.759081,1175+50
20007,441478.392998,1598238.125447,8.759081,1175+50
20008,441478.788013,1598238.125447,8.759081,1175+50
20009,441480.004532,1598234.409802,9.273326,1176+00
20010,441481.809240,1598224.130007,8.820207,1176+00
20011,441506.139922,1598254.445393,11.292853,1176+30
20012,441508.202508,1598248.278096,10.705003,1176+30
20013,441509.151515,1598248.278096,10.705003,1176+30
20014,441509.151515,1598248.278096,10.705003,1176+30

This is a comma separated file.

Point ID	Northing	Easting	Elevation	Description/Station
20051	441483.136559	1598216.145655	8.057369	1176+00
20052	441486.099941	1598199.454225	9.161593	1176+00
20053	441514.847077	1598211.743498	8.410498	1176+30
20054	441515.618231	1598209.130954	8.914729	1176+30
20055	441516.331134	1598205.386415	8.601282	1176+30
20056	441516.657049	1598204.563286	8.557148	1176+30
20057	441512.295753	1598226.418298	8.304605	1176+30
20058	441528.022172	1598254.575625	15.186740	1176+50
20059	441531.899772	1598232.963018	11.202229	1176+50
20060	441532.731438	1598226.274925	10.578486	1176+50
20061	441535.691727	1598207.626787	10.574499	1176+50
20062	441558.099890	1598211.361691	12.822520	1176+73
20063	441557.525541	1598220.416386	13.238780	1176+73
20301	441382.168281	1598214.959919	9.101032	1175+00
20302	441380.098529	1598224.907655	9.933760	1175+00
20303	441384.914575	1598197.140528	7.849892	1175+00

Figure 5.16-10 MANUSCRIPT FIELD BOOK NOTES

MANUSCRIPT FIELD BOOK NOTES – FDOT RADIAL & DTM FIELD SURVEYS	
<p>OBSERVATION:</p> <p>POINT NAME <u>EP-1</u></p> <p>FEATURE: <u>Ground</u> <input checked="" type="checkbox"/> ON <input type="checkbox"/> OFF</p> <p>GEOMETRY: <input checked="" type="checkbox"/> POINT <input type="checkbox"/> CURVE</p> <p>HORIZ. ANGLE (DDMMSS) <u>133 37 35</u></p> <p>VERT. ANGLE (DDMMSS) <u>89 59 59</u></p> <p>DISTANCE <u>110.45'</u> SLOPE <input checked="" type="checkbox"/> HORIZ</p> <p>TARGET HEIGHT: <u>5'</u></p> <p>ECCEN. DIST. <input type="checkbox"/> LT <input type="checkbox"/> RT <input type="checkbox"/> FR <input type="checkbox"/> BK</p> <p>COMMENTS: _____</p>	<p>OBSERVATION:</p> <p>POINT NAME <u>EP-2</u></p> <p>FEATURE: <u>Ground</u> <input checked="" type="checkbox"/> ON <input type="checkbox"/> OFF</p> <p>GEOMETRY: <input checked="" type="checkbox"/> POINT <input type="checkbox"/> CURVE</p> <p>HORIZ. ANGLE (DDMMSS) <u>86 53 39</u></p> <p>VERT. ANGLE (DDMMSS) <u>89 59 20</u></p> <p>DISTANCE <u>83.08'</u> SLOPE <input checked="" type="checkbox"/> HORIZ</p> <p>TARGET HEIGHT: <u>5'</u></p> <p>ECCEN. DIST. <input type="checkbox"/> LT <input type="checkbox"/> RT <input type="checkbox"/> FR <input type="checkbox"/> BK</p> <p>COMMENTS: _____</p>
<p>OBSERVATION:</p> <p>POINT NAME <u>EP-3</u></p> <p>FEATURE: <u>Ground</u> <input checked="" type="checkbox"/> ON <input type="checkbox"/> OFF</p> <p>GEOMETRY: <input checked="" type="checkbox"/> POINT <input type="checkbox"/> CURVE</p> <p>HORIZ. ANGLE (DDMMSS) <u>46 50 54</u></p> <p>VERT. ANGLE (DDMMSS) <u>89 59 59</u></p> <p>DISTANCE <u>123.96'</u> SLOPE <input checked="" type="checkbox"/> HORIZ</p> <p>TARGET HEIGHT: <u>5'</u></p> <p>ECCEN. DIST. <input type="checkbox"/> LT <input type="checkbox"/> RT <input type="checkbox"/> FR <input type="checkbox"/> BK</p> <p>COMMENTS: <u>point at PC STA on edge of pavement</u></p>	<p>OBSERVATION:</p> <p>POINT NAME <u>EP-4</u></p> <p>FEATURE: <u>Ground</u> <input checked="" type="checkbox"/> ON <input type="checkbox"/> OFF</p> <p>GEOMETRY: <input checked="" type="checkbox"/> POINT <input type="checkbox"/> CURVE</p> <p>HORIZ. ANGLE (DDMMSS) <u>32 30 6</u></p> <p>VERT. ANGLE (DDMMSS) <u>90 2 27</u></p> <p>DISTANCE <u>194.78'</u> SLOPE <input checked="" type="checkbox"/> HORIZ</p> <p>TARGET HEIGHT: <u>5'</u></p> <p>ECCEN. DIST. <input type="checkbox"/> LT <input type="checkbox"/> RT <input type="checkbox"/> FR <input type="checkbox"/> BK</p> <p>COMMENTS: _____</p>
<p>OBSERVATION:</p> <p>POINT NAME <u>EP-5</u></p> <p>FEATURE: <u>Ground</u> <input checked="" type="checkbox"/> ON <input type="checkbox"/> OFF</p> <p>GEOMETRY: <input type="checkbox"/> POINT <input checked="" type="checkbox"/> CURVE</p> <p>HORIZ. ANGLE (DDMMSS) <u>26 33 1</u></p> <p>VERT. ANGLE (DDMMSS) <u>90 0 10</u></p> <p>DISTANCE <u>271.92'</u> SLOPE <input checked="" type="checkbox"/> HORIZ</p> <p>TARGET HEIGHT: <u>5'</u></p> <p>ECCEN. DIST. <input type="checkbox"/> LT <input type="checkbox"/> RT <input type="checkbox"/> FR <input type="checkbox"/> BK</p> <p>COMMENTS: _____</p>	<p>OBSERVATION:</p> <p>POINT NAME _____</p> <p>FEATURE: _____ <input type="checkbox"/> ON <input type="checkbox"/> OFF</p> <p>GEOMETRY: <input type="checkbox"/> POINT <input type="checkbox"/> CURVE</p> <p>HORIZ. ANGLE (DDMMSS) _____</p> <p>VERT. ANGLE (DDMMSS) _____</p> <p>DISTANCE _____ SLOPE <input type="checkbox"/> HORIZ</p> <p>TARGET HEIGHT: _____</p> <p>ECCEN. DIST. <input type="checkbox"/> LT <input type="checkbox"/> RT <input type="checkbox"/> FR <input type="checkbox"/> BK</p> <p>COMMENTS: _____</p>
CHAIN FIELD NOTES	
<p>USER ASSIGNED CHAIN NAME: <u>EP</u></p> <p>FEATURE: <u>edge of pavement (AP)</u> SURFACE: _____ <input type="checkbox"/> ON <input type="checkbox"/> OFF</p> <p>STATIONING: _____</p> <p>LIST OF POINTS IN CHAIN: <u>EP-1 → 5</u></p> <p>COMMENTS: <u>EOP @ inlets & midway between inlets & shot at PC</u></p> <p>NOTE: A DETAILED SKETCH OF THE VICINITY MUST BE ATTACHED TO THESE NOTE FORMS.</p>	

Figure 5.16-11
NOTES ON GRID PAPER

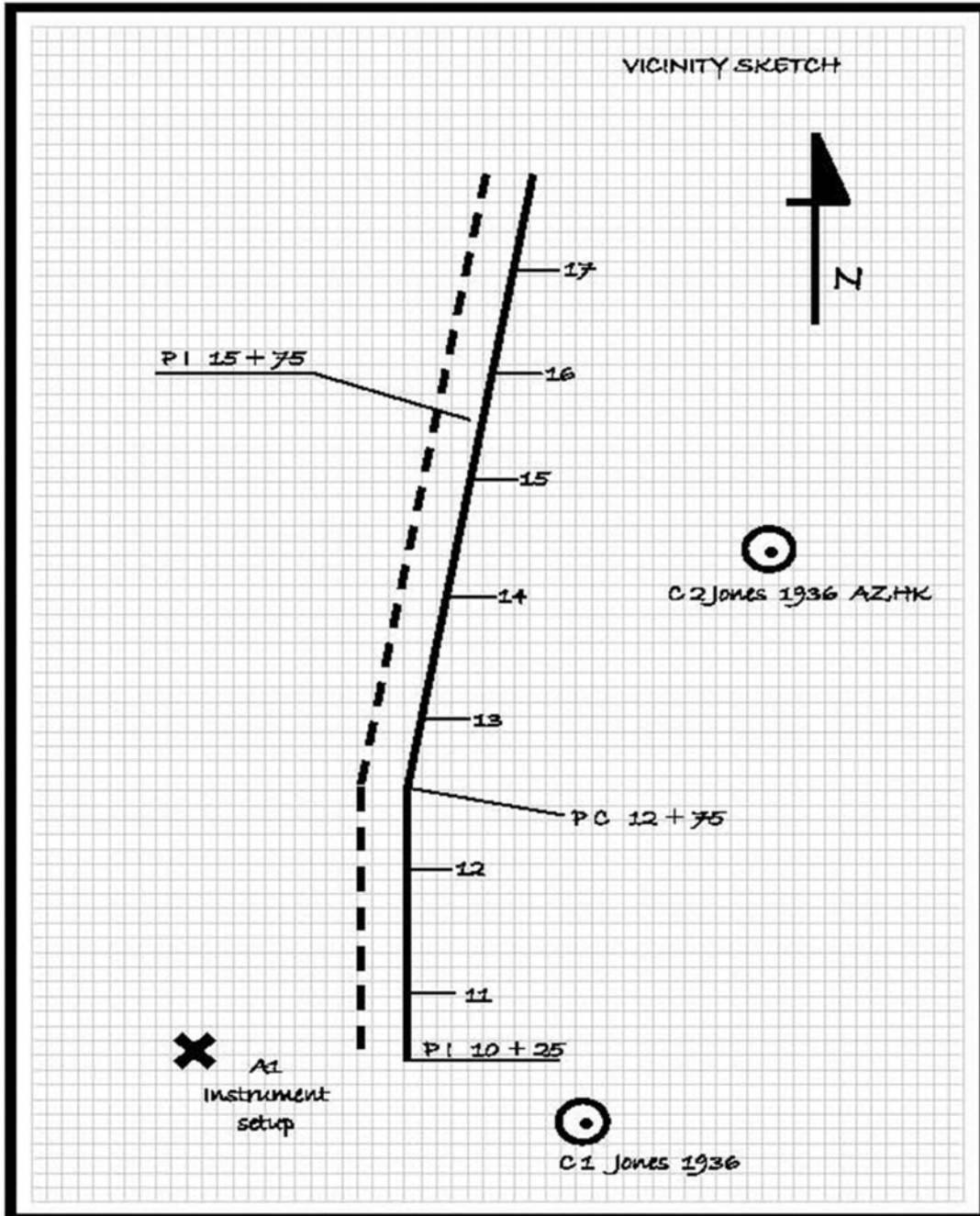

CHAPTER 6.1

UNPAID BILLS PROCESSING

6.1.1 Purpose

To provide a uniform standard for withholding progress payments due to nonpayment of bills by Contractors on all contracts (construction or maintenance).

6.1.2 Authority

Section 20.23(3)(a) and 334.048(3), Florida Statutes (F.S.)

6.1.3 References

Sections 337.11(11)(a)-(c) and 255.05, F.S.

Rule 14-22, Florida Administrative Code (F.A.C.)

Section 9-5.6 of Standard Specifications for Road and Bridge Construction

6.1.4 Definitions

Refer to the Introduction section of this *Manual*

6.1.5 General

There are two distinct cases in this procedure. One is for subcontractors and suppliers for which the prime Contractor is required to certify previous progress payment(s). The second is for sub-subcontractors or material suppliers to subcontractors for which the prime Contractor is not required to certify previous payments. These second or lower tier subcontractors/suppliers should seek the advice of legal counsel to protect their rights.

6.1.6 Certification Requirements

The prime Contractor shall certify that it has paid all subcontractors and suppliers their pro-rata share of previous progress payments. Any false certification submitted by the Contractor is grounds for denial or revocation of Certification of Qualification or determination of Contractor Non-Responsibility per ***Rule Chapter 14-22, F.A.C.***

Resident Level Responsibilities

No progress payment shall be made after the initial payment until the Contractor provides a completed certification (***Certification Disbursement of Previous Periodic Payments to Subcontractors***, [Form No. 700-010-38](#)). The certification applies to previous progress payments, less any agreed upon retainage between the Contractor and subcontractor.

The certification must be completed as per the instructions on the form or it will be deemed incomplete and non-responsive. If the Contractor's submittal is deemed non-responsive, a notice should be sent to the Contractor describing any deficiencies as shown in the guidance documents for this section and should be discussed with the Contractor. The progress estimate payment will not be made until a complete certification has been received.

An exception to the withholding of a progress estimate may be made if the Contractor:

- (1) Provides detailed reasons for not making payment of the pro-rata share of progress payment and;
- (2) Furnishes written notification of the same to the Department and affected subcontractor(s) and/or suppliers. Note: a copy of this documentation MUST be attached to the certification or it is incomplete.

6.1.7 Receipt of Unpaid Bill Notice from Subcontractor or Supplier

(A) Resident Level Responsibilities

Upon receipt of unpaid bill notice, the Resident Engineer will send a letter as shown in Guidance Documents ([Letter 6-1-A](#)) for this section, including a copy of the unpaid bill claim, to the prime Contractor, initiating an investigation into the claim. The Resident Engineer will send a copy of the letter and claim to the District Final Estimates Manager (DFEM). The Resident Engineer will investigate any good cause of nonpayment. During the investigation, progress payments will continue. If the Resident Engineer determines that good cause is demonstrated then progress payments will continue. A good cause is when the prime Contractor and the subcontractor/supplier have a legitimate dispute as to whether or not the money is due and the prime Contractor is only withholding the amount in dispute. The Resident Engineer is not to decide the dispute or determine who might win the dispute. The Resident Engineer must only determine whether a legitimate dispute exists. However, if the Resident Engineer determines that good cause is not

demonstrated then the next progress estimate may be withheld. The Resident Engineer shall coordinate the review with the DFEM and the Office of Construction throughout the duration of the investigation.

If a monthly certification is not received and good cause for the same is not demonstrated, the Resident Engineer will notify the District Construction Engineer who will then determine whether to withhold payment of the next progress estimate.

Should a notification of unpaid bills be received following Final Acceptance, the Resident Office will forward it to the DFEM.

(B) District Level Responsibilities

The DFEM will record any unpaid bill claim into the tracking system.

Should a notification of unpaid bills be received following Final Acceptance, the DFEM will follow instructions provided in the *Final Estimates Review and Administration Manual, Topic No. 700-050-005 (Section 5.5.5)*.

6.1.8 Receipt of Unpaid Bill Notice from Second Tier Subcontractors/Suppliers

(A) Resident Level Responsibilities

The Resident Engineer will send second tier (or lower) subcontractors/suppliers a letter as shown in Guidance Documents ([Letter 6-1-B](#)) for this section, stating they do not fall within the class of claimants entitled to protection under **Section 337.11, Florida Statutes**, and they should consult with their attorney on how to further protect their rights. A copy of the letter will be sent to the DFEM.

(B) District Level Responsibilities

The DFEM will input the claim into the tracking system.

6.1.9 Notice to Contractor of Withholding

Resident Level Responsibilities

The Resident Engineer must notify the Contractor in writing ([Letter 6-1-C](#)) of the Resident Engineer's intent to make a recommendation to withhold payment for the lack of certification or lack of demonstration of good cause. This written notification must

include the specific reasons for withholding payment and specific actions required of the Contractor to gain release of payment. A copy of this notification must be sent to the District Final Estimates Office and District Construction Office along with backup correspondence.

6.1.10 Withholding of Payments

Resident Level Responsibilities

The Resident Engineer will prepare the documentation for the disputed progress estimate and forward it to the District Construction Engineer.

After progress estimates have been processed, the District Construction Engineer will hold the disputed progress estimate until he receives notice of Contractor compliance from the Resident Engineer. At that time, the progress estimate for payment will be released. The Resident Office will inform the DFEM of Contractor compliance, so that the issue may be resolved in the tracking system.

6.1.11 Processing for Falsification of Payment Certification

(A) Resident Level Responsibilities

If the Resident Engineer discovers that the Contractor does not have good cause for withholding payment to the subcontractor and/or suppliers and/or withholding sums more than the amount in dispute and in his opinion the prime Contractor has submitted a false certification of payment, the Resident Engineer must submit to the Director, Office of Construction a memorandum or email transmitting, ***on a monthly basis starting from the month a false certification may have occurred until the unpaid bill is resolved***, all the appropriate documentation related to the non-payment, including copies of the unpaid bill notice and correspondence between the Department, the prime Contractor and the subcontractor/supplier, copies of monthly certifications, copies of sublet with the affected subcontractor/supplier and copies of monthly estimates highlighting payment to the prime Contractor for work performed by the subcontractor/supplier.

Guidance Letters

Unpaid Bill Guidance Letters can be found on the [State Final Estimates SharePoint site](#) (Internal Use Only) in editable format.

Guidance Letters:

Letter 6-1-A..... Unpaid Bill to Suppliers and/or Subcontractors (1st Tier)

Letter 6-1-B..... Unpaid Bill Notice from 2nd Tier Subcontractor/Supplier

Letter 6-1-C..... Incomplete Certification of Previous Payment to Subs

Guidance Document 6-1-A

SAMPLE LETTER #1

(Date)

(Prime Contractor)

SUBJECT: UNPAID BILLS TO SUPPLIERS AND/OR SUBCONTRACTORS

Financial Project ID: State Job No.: Federal Job Project ID: County/Section No.:
Contract No.:

Gentlemen:

Section 337.11(11)(a), Florida Statutes, requires that the Department not make any progress payments unless the Contractor submits a certification that it has paid its suppliers and subcontractors their pro rata shares of the payment out of previous progress payments from the Department. When the Department receives a notice from a subcontractor or a supplier that they have not received payment, we are required to monitor such claims.

We have received a notice of non-payment from _____. I have attached its letter of _____, for your review. In order to clear the issue, you are required to address the claim of non-payment by your next monthly certification. Please prepare a detailed response explaining the disposition of this claim. Your submittal shall include copies of all pertinent information (i.e. canceled checks, agreements, etc.).

Your explanation will be thoroughly reviewed to assure compliance with Section 337.11(11)(a)-(c), Florida Statutes. Non-compliance with Florida Statutes is sufficient reason for stopping future progress payments. If you, the Prime Contractor, state that subcontractors and/or suppliers have received their pro rata share and they did not, you have filed a false document.

If you have falsely certified payment to subcontractors and/or suppliers, you may be subject to the penalties described in the certification document (Certification Disbursement of Previous Periodic Payments to Subcontractors, Form No. 700-010-38).

In order to avoid withholding of your monthly estimate, please submit your response by (prior to next estimate cut-off date).

Sincerely,

Resident Engineer

initial/initial
Attachment

cc: _____, District Construction Engineer
_____, District Final Estimate Manager, w/ copy of claim
_____, Surety
_____, Claimant Sub/Supplier
_____, State Construction Engineer - Mail Station 31, w/ copy of claim
_____, District Compliance Officer (if DBE is involved)

Guidance Document 6-1-B

SAMPLE LETTER #2

(Date)

(Claimant)

**SUBJECT: UNPAID BILLS NOTICE FROM SECOND TIER
SUBCONTRACTORS/SUPPLIERS**

Financial Project ID:
State Job No.:
Federal Job Project ID:
County/Section No.:
Contract No.:

Gentlemen:

We have received your notice of nonpayment on the above referenced project.

You do not fall within the class of claimants entitled to protection under Section 337.11, Florida Statutes. Therefore, the Department cannot participate in the resolution of this matter.

Consult with your attorney on how to further protect your rights.

Sincerely,

Resident Engineer

initial/initial
Attachment

cc: _____, District Construction Engineer
_____, Prime Contractor
_____, Surety
_____, District Final Estimate Manager, w/ copy of claim
_____, State Construction Engineer - Mail Station 31, w/ copy of claim
_____, District Compliance Officer (if DBE is involved)

Guidance Document 6-1-C

SAMPLE LETTER #3

(Date)

(Prime Contractor)

SUBJECT: INCOMPLETE CERTIFICATION DISBURSEMENT OF PREVIOUS PERIODIC PAYMENT TO SUBCONTRACTORS

Financial Project ID:

State Job No.:

Federal Job Project ID:

County/Section No.:

Contract No.:

Gentlemen:

Per our conversation on ____, this letter confirms that we have received your Certification Disbursement of Previous Periodic Payment To Subcontractors and found it incomplete and/or the form instructions have not been followed. (List specific deficiencies with the submittal here). Subsequent to the receipt of a complete certification, progress payments may be processed in accordance with the contract.

Section 337.11(11)(a), Florida Statutes, requires that the Department not make any progress payments unless the Contractor submits a certification that they have paid their subcontractors and suppliers their pro rata shares of the payment out of previous progress payments from the Department.

Your certification will be thoroughly reviewed to assure compliance with Section 337.11(11)(a)-(c), Florida Statutes. Non-compliance with Florida Statutes is sufficient reason for stopping future progress payments. If you, the Prime Contractor, state that subcontractors and/or suppliers have received their pro rata share and they did not, you have filed a false document.

If you have falsely certified payment to subcontractors, you may be subject to the penalties described in the certification document.

In order to avoid delays in the processing of your monthly estimate, please submit your response as soon as possible.

Sincerely,

Resident Engineer

initial/initial
Attachment

cc: _____, District Construction Engineer
_____, District Final Estimate Manager
_____, State Construction Engineer - Mail Station 31, w/ copy of claim

Section 6.2 ALTERNATIVE CONTRACTS

6.2.1 Purpose

This section provides computation and documentation methods for Alternative Contracts, as well as establishes procedures and guidelines required by Alternative Contracts for the Project Administrator (PA) and staff to use in building and supporting the specific contract requirements. This section also summarizes the required records for processing the ***Final Estimates Documentation*** on Alternative Contracts. It is not the intent of these procedures to supersede the Contract Documents, but to enhance the process of the ***Final Estimates Documentation*** submittal. The documents required to close out a final estimate will vary from contract to contract. It is the responsibility of the Resident Office (RO) to ensure that the Contractor complies with the Contract Documents.

6.2.2 Authority

[Section 20.23\(3\)\(a\), Florida Statutes](#)
[Section 334.048\(3\), Florida Statutes](#)

6.2.3 Reference

[Section 337.11\(7\)\(a\), Florida Statutes](#)
[Section 337.11\(4\), Florida Statutes](#)
[Section 337.18\(4\)\(a\), Florida Statutes](#)
[Section 20.23\(4\)\(a\), Florida Statutes](#)
[Section 337.025, Florida Statutes](#)

Alternative Contracting website at:

<http://www.fdot.gov/construction/AltContract/AltContract.shtm>

[Construction Project Administration Manual \(CPAM\), Topic No. 700-000-000](#)

[FDOT Standard Specifications for Road and Bridge Construction](#)

[Design-Build Specifications Boilerplate](#)

[Special Provisions - Workbook](#)

[FDOT Design Manual](#)

[Attachment A – Florida Transportation Commission Report](#)

6.2.4 Types of Alternative Contracts

6.2.4.1 Contracts with Lane Rental Fees

The [Lane Rental](#) concept requires either the Contractors bidding on a project to determine a number of days that a lane will be closed during work or the engineer/designer to set the total allowable number of lane rental days in the contract. A fee is established during design and placed in the contract to be assessed for each day or half-day of lane closure(s), in excess of the number of total lane rental days originally bid by the Contractor (See Contract for the applicable days). Once the number of lane rental days used exceeds the total number of lane rental days bid, the predetermined lane rental fee will be multiplied by the excess time defined in the contract and the result will be deducted from the progress estimate payment.

All lane closures must be documented on **Form 700-050-57, Lane Rental Site Source Record**. Beginning and ending times, locations, and unit of measure (i.e., full, or half-days) will be tabulated for each lane rental to be charged. The actual full or half-day lane rental will be charged on the day in which the ending time falls. For example, if a lane closure begins at 8:00 p.m. on Monday and reopens at 6:00 a.m. the next day (Tuesday), a half-day lane rental will be reported for Tuesday on the **Lane Rental Site Source Record**. The Contractor and PA must mutually agree upon the twenty-four (24) hour clock beginning and ending times for lane rental purposes. Such agreements will be recorded in the Preconstruction Conference Minutes. (**Special Provision (SP) Section 2-5.1, SP0020501LR.**)

Both the Inspector and Contractor must sign the **Lane Rental Site Source Record** agreeing to the total days charged. The signed form will be submitted with the **Final Estimates Documentation**. The Final Lane Rental Incentive/Disincentive dollar amount will be shown as a contract adjustment to the progress estimate on which it is to be paid, using the AASHTOWare Project Construction (PrC) code, **Lane Rental Incentive-Disincentive (LRID)**. Appropriate adjustment comments must be included when the adjustment is created. See the [PrC User Handbook](#) for more information on adjusting an estimate.

In addition to the Daily Lane Rental Fee provided in **Special Provision Section 2-5.1, SP0020501LR**, a Damage Recovery/User Cost will be assessed against the Contractor if all lanes are not open to traffic during the times as shown in the Traffic Control Plans. (See **Special Provision Section 8-13.1, SP0081300IDLR.**) Costs will be assessed beginning at the appropriate time as shown in the Traffic Control Plans and continue until all lanes are open as recorded by the Engineer. The District Construction Office (DCO) will determine the dollar amounts for the assessment using the FDOT Road User Cost

(RUC) Software. The assessment will be included in **Special Provision Section 8-13.1 SP0081300IDLR**. (See example below.)

First 30 minutes and under: \$ _____
Each additional 30-minute period or portion thereof: \$ _____.
Such costs will not exceed \$ _____ over a 24-hour period.

At the discretion of the Engineer, damage recovery/user cost will not be assessed for failure to open traffic lanes if such cause is beyond the control of the Contractor, i.e., catastrophic events, accidents not related or caused by the Contractor's operations.

The Department will have the right to apply as payment on such damages to any money which is due to the Contractor by the Department.

6.2.4.2 Contracts with A + B Bidding

The **A+B bidding** concept is a cost-plus-time method of bidding, which enables each Contractor to bid the number of days in which the project can be completed, thus allowing the Contractor to control the important element of time.

In the A+B bidding method, a dollar value for each Contract Day is established by the Department prior to the project being advertised. The Contractor will receive an incentive payment for the Daily Value amount specified in **Special Provision Section 3-1, SP0030100AB** for each calendar day the work is completed ahead of the Original Contract Time bid. If the Contractor completes the project late, a disincentive and the appropriate liquidated damages will be assessed, per **Special Provision SP0081300AB**. For the calculation of the incentive, the Original Contract Time will not be adjusted for weather, unforeseen conditions, and extra work as approved. The number of days bid is multiplied by the daily road user cost to determine the value of the Contractor's time bid. The District Construction Office (DCO) will determine the daily road user cost using the FDOT Road User Cost (RUC) Software. (See **Special Provision Section 8-13.1, SP0081300AB**.)

The **Daily Work Report (DWR)** and **Diary** in **PrC** will serve as the supporting documentation for appropriate payment as outlined in **CPAM Section 5.1**. The following statements must be recorded in both reports:

1. Today is the first day or the beginning milestone day of the A+B bidding phase of this Contract.
2. Today is the last day of the A + B bidding phase of this Contract.

The final incentive/disincentive dollar amount of the A+B bidding concept will be shown as a Contract adjustment to the progress estimate on which it is to be paid, using the PrC code, **A+B Incentive-Disincentive (ABID)**. Supporting remarks must be included when the adjustment is created. See the [PrC User Handbook](#) for more information on adjusting an estimate.

6.2.4.3 Contracts with No Excuse Bonus

The [No Excuse Bonus](#) concept is intended to shorten the construction time that would normally be required to perform the work by providing the Contractor with a substantial bonus to complete a project (or phase of the project) within the timeframe specified in the Contract, regardless of any problems or unforeseen conditions that might arise. The bonus is tied to a "drop-dead" date (time frame) that is either met or not met. This date can be a milestone within the project or final completion. Time extensions are not allowed for the purpose of the bonus unless a catastrophic event has directly impacted the Contractor's performance.

The **Daily Work Report** and **Diary** in **PrC** will serve as the supporting documentation for payment as outlined in **CPAM Section 5.1**. The following statements must be recorded in both reports:

1. Today is the first day or the beginning milestone day of the No Excuse Bonus phase of this Contract.
2. Today is the last day of the No Excuse Bonus phase of this Contract.

The final dollar amount of the No Excuse Bonus will be shown as a Contract adjustment to the progress estimate on which it is to be paid, using the PrC code, **No Excuse Bonus (NEXB)**. Supporting remarks must be included when the adjustment is created. See the [PrC User Handbook](#) for more information on adjusting an estimate.

6.2.4.4 Liquidated Savings Contracts

The [Liquidated Savings](#) concept is used to reward the Contractor for each calendar day the Contract is completed and accepted prior to the expiration of allowable Contract Time. Contract Time is adjusted for time extensions under this concept.

The **Daily Work Report** and **Diary** in **PrC** will serve as the supporting documentation for payment as outlined in **CPAM Section 5.1**. The following statements must be recorded in both reports:

1. Today is the first day or the beginning milestone day of the Liquidated Savings phase of this Contract.

2. Today is the last day of the Liquidated Savings phase of this Contract.

The final dollar amount of the Liquidated Savings will be shown as a Contract adjustment to the progress estimate on which it is to be paid, using the PrC code, **Liquidated Savings (LSAV)**. Supporting remarks must be included when the adjustment is created. Payment will be made to the Contractor on a progress estimate after final acceptance in accordance with **Specifications Section 5**. See the [PrC User Handbook](#) for more information on adjusting an estimate.

EXAMPLE 1:

Contract days allowed = 200

Days used to complete project = 180

Days to receive an adjustment = 20

Amount Shown in Contract for early completion = \$2,000/day

Progress estimate reflects 20 days x \$2,000/day = \$40,000 in liquidated savings

If time negotiations for unforeseen conditions, extra work and weather days are in progress with the Contractor after project final acceptance, payment will be based on the PA's documented days until a settlement is agreed upon with the Contractor.

EXAMPLE 2:

Contract days allowed = 200

Days used to complete project = 200

Days to receive an adjustment = 0

Negotiation (time extension) for extra work

Project Administrator Records = 30 days

Contractor Claims = 60 days

Amount Shown in Contract for early completion = \$2,000/day

Progress estimate reflects 30 days x \$2,000/day = \$60,000 until an agreement is reached

6.2.4.5 Lump Sum (LS) Contracts

The Documents required to close out a final estimate on LS contracts will vary from contract to contract. It is the responsibility of the PA and the District Final Estimates Manager (DFEM) to determine that all required documents are complete and accompany the **Final Estimates Documentation** in accordance with the Contract and Specifications on Lump Sum Contracts.

Changed conditions, extra work and unforeseen work must be negotiated and resolved with the Contractor utilizing Supplemental Agreements (SA) and/or Work Orders (WO) on Contingency Supplemental Agreements. See [CPAM 7.4](#) for additional information on ***Contingency Supplemental Agreements and Work Orders***.

Since there is only one LS pay item on these contracts, other items included in payment such as adjustments will be discussed, as well as submittal documentation requirements.

All documents and records will be submitted and exchanged electronically using the Department's collaboration site and uploaded into the Department's Electronic Document Management System (EDMS).

(A) Adjustments Included in Payment

All tables listed in ***Special Provision SP0090103LS*** apply to Deficiencies, Asphalt Pay Adjustments, Asphalt Overbuild, Foundation, and Quality Adjustments. Those tables listed are to be completed with a predetermined unit price if these specific areas are included in the Contract. If no prices are shown in the Contract specifying that adjustment will be made, contact the District Specification Engineer to determine if this was an oversight. If so, the District Specification Engineer will supply this information. Otherwise, the unit price will be determined based on statewide averages. A Work Order (WO) will be required to amend the Contract.

(1) Adjusted Pay for Deficiencies

CPAM 5.8 describes the decision process for determining what deficient material will be left in place at no pay or removed and replaced. Documentation for these adjustments will be submitted with each monthly progress estimate and included in the ***Final Estimates Documentation***. (See the ***Special Provision Section 9-2.2, SP0090103LS***.)

(a) Leave in Place at No Pay

The PA will apply a reduction in the lump sum payment due to deficient material left in place at no pay. The negative pay adjustment will be based on the unit prices shown in ***Special Provision Section 9-2.2, SP0090103LS, Table 9-1***. The adjustment will be entered as a line-item adjustment in the progress estimate. Appropriate remarks will be included when the adjustments are created.

The PA will document that all adjustments are correct and have met the criteria as set forth in the Contract. Documentation of all failures will be submitted with the **Final Estimates Documentation**. (See **CPAM Section 6.2.5** for examples of deficiency area evaluation.)

Pay adjustment is calculated by using the following formula:

$$(\text{Quantity Reduced}) \times (\text{Unit Price from Table 9-1})$$

Example of Deficiency Adjustment Unit Prices
Table 9-1

Item Description	Unit	Unit Prices
Optional Base/Superpave	SY	\$8.78
Superpave (Traffic level B)	Ton	\$48.62
Superpave (Traffic level C)	Ton	\$52.99
Asph. Conc. Friction Course (FC-6)	Ton	\$56.79

Concrete failures will be adjusted in accordance with the current **Contract Document Specifications**.

(b) Remove and Replace

When it is determined that deficient material will be removed and replaced at no cost to the Department, this material will be identified as such in the Quality Control Roadway Report (QCRR). No other adjustments are necessary.

(2) Asphalt Pay Adjustments

Asphalt pay quantity adjustments apply to asphalt items listed in Contract **Sections 234, 334, 337 and 339**.

Adjustments in pay will only be made for asphalt accepted by the Department up to the adjusted quantity limits as defined in **Special Provision Section 9-2.2.2 SP0090103LS**. A negative adjustment in pay is made when the asphalt quantity placed is less than the adjusted quantity.

For contracts let prior to July 1, 2017, which are not utilizing adjusted quantity, adjustments will be based on the quantity placed, not to exceed the total design spread rate tonnage. Per **Special Provision Section 9-2.2.2 SP0090103LS**, any quantity exceeding the design spread rate specified in the Contract Documents will

not be paid. Therefore, tonnage exceeding the design spread rate, which are not Engineer directed, will not be eligible for payment, including bituminous adjustments.

(3) Asphalt Overbuild

An adjustment in payment will be made on asphalt overbuild used for cross-slope correction when called for in the plans.

- a) A negative adjustment will be made when the quantity of material placed is less than the adjusted quantity defined in **Special Provision Section 9-2.2.2, SP0090103LS**.
- b) A positive adjustment will be made if the material placed exceeds the adjusted quantity with no negative effect to the correction of the cross-slope.

Adjustment in pay for overbuild is calculated by using the formula below:

$$[(\text{Quantity Placed}) - (\text{Adjusted Quantity})] \times (\text{Unit Price from Table 9-2})$$

Example of Asphalt Overbuild Adjustment Unit Prices
Table 9-2

Item Description	Unit	Unit Prices
Superpave (Traffic level B)	Ton	\$48.62
Superpave (Traffic level C)	Ton	\$52.99

(4) Foundation Adjustments

Adjustment (additions or deletions) in the lump sum payment for the total project quantity will be made for quantities installed of piling and drilled shafts determined from the pile/drilled shaft elevations shown in the Contract Documents. (**See Special Provision Section 9-2.2.4, SP0090103LS**.) The PA will base the adjustments in payment on the unit prices as shown in **Table 9-3**.

Example of Piling and Drilled Shafts Adjustment Unit Prices
Table 9-3

Item Description	Unit	Unit Prices
Concrete Piling Prestressed (18")	LF	\$45.25
Concrete Drilled Shafts (30")	LF	\$80.33

Concrete Piling Prestressed (36")	LF	\$69.33
-----------------------------------	----	---------

(5) Quality Adjustment

Quality adjustments include CPF adjustments for asphalt, Smoothness (Straightedge and or Laser Profiler) adjustments for asphalt and concrete pavements, Concrete Pavement Strength of Material adjustments, and Plastic Properties adjustments.

Quality adjustments will be made based on the unit prices provided in **Special Provision Section 9-2.2.5, SP0090103LS, Table 9-4.**

**Example of Quality Adjustment Unit Prices
 Table 9-4**

Item Description	Unit	Unit Prices
Optional Base/Superpave	SY	\$8.78
Superpave (Traffic Level B)	Ton	\$48.62
Superpave (Traffic level C)	Ton	\$52.99
Friction Course (FC 6)	Ton	\$56.79

All adjustments will be shown on **Form 700-050-10, Pay Item Summary and Certification Sheet** as a line-item adjustment.

NOTE: The PA should emphasize the Contractor's responsibility to provide accurate reports (i.e., quantities (SY), overlapping joints, exact widths being placed, and correct tonnage).

An adjustment for smoothness will be made based on the criteria specified in the **Contract Specifications Section 330**, if applicable.

(6) Adjustment to the Lump Sum Payment for Increase or Decrease in Items of Work

If the PA determines that an item originally shown in the contract plans is not needed on a project, such as a pipe culvert, an inlet, a manhole, a mitered end section, etc., a negative adjustment will be made based on the actual cost of that item (minus any costs incurred prior to the date the Engineer determined the item was not needed) and the Contractor will retain ownership. (See **Special Provision Section 9-2.2.6**)

If it is determined that additional items or alterations in the character of work are needed, the Contractor will be paid in accordance with **Standard Specification Section 4-3.2**.

(7) Retainage

The Department will withhold 10% of the amount due on the current estimate as retainage when the percent of allowable Contract Time used exceeds the percent of the Contract amount earned by more than 15%. Retainage will not be withheld until 75% of the Contract Time has elapsed. This amount will not be released until payment of the Final Estimate (See **Specifications Section 9**).

After the PA approves the Contractor's certified monthly estimate, payment will be made based on the work the Contractor performs less any retainage amount withheld, per provisions in the Contract. The Contractor's Certified Monthly Estimate payments will be approximate only and will be subject to decrease (overpayments) or increase (underpayments).

(8) Fuel Adjustments

On Contracts with an original Contract Time in excess of 120 calendar days, the Department will make price adjustments on each applicable progress estimate to reflect increases and decreases in the price of gasoline and diesel from those in effect during the month in which bids were received. The Contractor will not be given the option of accepting or rejecting these adjustments. Price adjustments for these fuels will be made only when the current fuel price (CFP) varies by more than 5% from the price prevailing in the month when bids were received (Base Fuel Price - BFP), and then only on the portion that exceeds 5%. (See **Special Provision Section 9-2.1.1 SP0090103LS**.)

NOTE: Effective for contracts let January 2022 and forward, fuel adjustments will only be made on diesel fuel.

Fuel adjustments for asphalt quantities will only be made on work accepted by the Department, up to the adjusted quantity limits as defined in **Special Provision Section 9-2.2.2 SP0090103LS**. The adjusted quantity will include any Engineer approved changes. Any quantities exceeding the adjusted quantity limits, which are not Engineer directed, will not be subject to any payment.

Fuel adjustments for non-asphalt items, will only be made on the work accepted and eligible for payment, not to exceed the approved Schedule of Values. If an

adjustment is made and the work is later determined to be unacceptable, a deduction to the adjustment will be made on the next progress estimate.

The Contractor will certify the number of gallons of fuel (gasoline and diesel) used on the Contract during the period represented by each Contractor's Certified Monthly Estimate. The fuel adjustment to be paid is generated by the **Contractor's Certification of Fuel Adjustment** for each monthly estimate. The **Contractor's Certification of Fuel Adjustment** is an automated Excel worksheet provided by the Department to calculate gallons of gasoline and/or diesel for the different items that will receive a fuel adjustment. Gallons (gasoline or diesel) will be derived from the pre-determined **Standard Fuel Factors** for the items receiving a fuel adjustment. On the **Contractor's Certification of Fuel Adjustment**, the Contractor will enter the data as follows:

- 1) "Setup" tab (pictured below):
 - a) Contract and Contractor's information, worksheet number, and the dates of the period the certification covers.
 - b) The Base Fuel Price (index) for the month the Contract was bid (BFP) and the Current Fuel Price (index) for the month of the current estimate (CFP).
 - c) The Average Price Indexes are posted on the Construction Office website at:

<https://www.fdot.gov/construction/fuel-bit/fuel-bit.shtm>

Contractor's Certification of Fuel Adjustment (Design Build and Lump Sum Projects)																			
Worksheet No. <u>12</u>																			
Financial Project ID:	<u>123456-1-52-01</u>																		
Contractor:	<u>We Pave, Inc.</u>																		
Contract Number:	<u>T1234</u>																		
From (Mo/Day/Yr):	<u>11/09/19</u>	To (Mo/Day/Yr):	<u>12/15/19</u>																
<table border="1" style="width: 100%; border-collapse: collapse;"> <thead> <tr> <th style="width: 30%;"></th> <th style="width: 15%;">Month / Year</th> <th style="width: 15%;">Gasoline Index</th> <th style="width: 15%;">Diesel Index</th> </tr> </thead> <tbody> <tr> <td>Base Index:</td> <td><u>Dec-18</u></td> <td><u>1.4958</u></td> <td><u>1.8838</u></td> </tr> <tr> <td>Current Index:</td> <td><u>Dec-19</u></td> <td><u>1.7555</u></td> <td><u>2.0510</u></td> </tr> <tr> <td>Index Difference:</td> <td></td> <td><u>0.1849</u></td> <td><u>0.0730</u></td> </tr> </tbody> </table>					Month / Year	Gasoline Index	Diesel Index	Base Index:	<u>Dec-18</u>	<u>1.4958</u>	<u>1.8838</u>	Current Index:	<u>Dec-19</u>	<u>1.7555</u>	<u>2.0510</u>	Index Difference:		<u>0.1849</u>	<u>0.0730</u>
	Month / Year	Gasoline Index	Diesel Index																
Base Index:	<u>Dec-18</u>	<u>1.4958</u>	<u>1.8838</u>																
Current Index:	<u>Dec-19</u>	<u>1.7555</u>	<u>2.0510</u>																
Index Difference:		<u>0.1849</u>	<u>0.0730</u>																
<input type="button" value="Go To Main Sheet"/>																			
Effective January 2013 Letting (Revision 12/10/19)																			
Digital Signature-Instructions Setup FuelWS +																			

- 2) On the "Main Sheet" ("FuelWS" tab), enter the quantities that represent the work performed during the period included in the progress estimate (since the previous estimate cut-off date) based on the Schedule of Values (SOV). The PA will review and reconcile any differences on the certified monthly progress estimate before processing for payment.

NOTE: Lump Sum and Design-Build contracts have no pay items, only descriptions of pay items as noted in the SOV. Therefore, if the equivalent description of a pay item is not included in the **Contractor's Certification of Fuel Adjustment**, such item will not receive a fuel adjustment.

- a) Select "Hide Unused Items" (top left) to show only items with recorded quantities.

SIGNATURES This document needs to be signed. View Signatures...

Hide Unused Items

CONTRACTOR'S CERTIFICATION OF FUEL ADJUSTMENT
 (DESIGN BUILD AND LUMP SUM PROJECTS)

CONTRACTOR: We Pave, Inc. DATE FROM: 11/09/19 MONTH / YEAR GASOLINE INDEX DIESEL INDEX
 WORKSHEET NO.: 12 DATE TO: 12/15/19 BASE INDEX: Dec-18 1.4958 1.8838
 FINANCIAL PROJECT ID: 123456-1-52-01 CONTRACT NO.: T1234 CURRENT INDEX: Dec-19 1.7555 2.0510

ITEM NUMBER(S)	ITEM DESCRIPTION	UNIT	QUANTITY	GASOLINE (GALLONS)	DIESEL (GALLONS)	GASOLINE FACTOR	DIESEL FACTOR
010-1-1	Cleaning & Grubbing*	LS/JAC				25.272476	251.478708
010-2-1	Cleaning & Grubbing	AC				25.272476	251.478708
010-15	Abortis Work, Complete*	LS/JAC				25.272476	251.478708
010-20-1	Removal of Existing Wall/MSE Wall*	LS/SF				25.272476	251.478708
010-20-2	Removal of Existing Wall/Retaining Wall*	LS/SF				25.272476	251.478708
010-4	Removal of Concrete Pavement	SY		0.047100			2.340900
010-4-3	Removal of Existing Concrete, Concrete Sidewalk and Driveways	SY		0.047100			2.340900
010-4-4	Removal of Existing Concrete, Slope Pavement	SY		0.047100			2.340900
010-4-5	Removal of Existing Concrete, Curb Elements	SY		0.047100			2.340900
010-4-6	Removal of Existing Concrete, Ditch Pavement	SY		0.047100			2.340900
010-4-7	Removal of Existing Concrete, Rigid Concrete Pavement	SY		0.047100			2.340900
010-4-10	Removal of Existing Concrete	SY		0.047100			2.340900
010-4-11	Removal of Existing Concrete, Permanent Barrier Wall	SY		0.047100			2.340900
010-4-12	Removal of Existing Concrete, MSE Wall	SY		0.047100			2.340900
010-4-13	Removal of Existing Concrete, Retaining Wall	SY		0.047100			2.340900
010-4-15	Removal of Existing Concrete, Perimeter Wall	SY		0.047100			2.340900
010-4-16	Removal of Existing Concrete, Gravity Wall	SY		0.047100			2.340900
010-4-17	Removal of Existing Concrete, Architectural/Decorative Wall	SY		0.047100			2.340900
010-1	Regular Excavation	CY	225	2	124	0.010466	0.551228
010-1-900	Regular Excavation, Projects 405270-1,-3, and -4	CY				0.010466	0.237663
010-2-2	Borrow Excavation	CY	100	1	82	0.013083	0.823183
010-3	Lateral Ditch Excavation	CY				0.023027	0.546873

b) The calculated total gallons (gasoline and diesel), index difference and fuel adjustment for the month's certified progress estimate will be populated on the bottom of the worksheet. (See example below.)

MARKED AS FINAL An author has marked this workbook as final to discourage editing. Edit Anyway

Show All Items

CONTRACTOR'S CERTIFICATION OF FUEL ADJUSTMENT
 (DESIGN BUILD AND LUMP SUM PROJECTS)

CONTRACTOR: We Pave, Inc. DATE FROM: 11/09/19 MONTH / YEAR GASOLINE INDEX DIESEL INDEX
 WORKSHEET NO.: 12 DATE TO: 12/15/19 BASE INDEX: Dec-18 1.4958 1.8838
 FINANCIAL PROJECT ID: 123456-1-52-01 CONTRACT NO.: T1234 CURRENT INDEX: Dec-19 1.7555 2.0510

ITEM NUMBER(S)	ITEM DESCRIPTION	UNIT	QUANTITY	GASOLINE (GALLONS)	DIESEL (GALLONS)	GASOLINE FACTOR	DIESEL FACTOR
0120-1	Regular Excavation	CY	225	2	124	0.010466	0.551228
0120-2-2	Borrow Excavation	CY	100	1	82	0.013083	0.823183
Updated 12-10-2019 * Quantity for LS pay items = Total Quantity of Secondary unit X % of work completed				TOTAL (GALLONS)	3	206	MONTHLY MONETARY AMOUNT
				INDEX DIFFERENCE	0.1849	0.0730	\$0.55
							\$15.04

certify that, based on my personal knowledge and well-founded belief following my own reasonable investigation, the gallons (metric tons and liters) represented by this Certification are true and correct.
 * Calculations based on Specifications.

12/16/2019
 X Joe Doe
 Contractor's Authorized Agent

We Pave, Inc / email@pave.com
 (Name of Company and email address)

c) The Contractor or Contractor's authorized agent will sign and date the **Contractor's Certification of Fuel Adjustment**.

The RO personnel will spot check the base and monthly indexes, item quantities and adjustment amount, and ensure that the information recorded on the **Contractor's Certification of Fuel Adjustment** is true and correct. The RO personnel will enter the adjustment amount in PrC as a line adjustment.

NOTE: The RO personnel must ensure that the Contractor certifies the calculated gallons and submits the **Contractor's Certification of Fuel Adjustment** with the

Contractor's Certified Monthly Estimates, as required in the **LS** and **Design-Build Specifications Section 9-11**.

(9) Bituminous Adjustment

On Contracts with an original Contract Time of more than 365 calendar days, or more than 5,000 tons of asphalt concrete, the Department will adjust the bid unit price for bituminous material, excluding cutback and emulsified asphalt, to reflect increases or decreases in the Asphalt Price Index (API) of bituminous material from that in effect during the month in which bids were received. The Contractor will not be given the option of accepting or rejecting this adjustment. Bituminous adjustments will be made only when the current API (CAPI) varies by more than 5% of the base API (BAPI) prevailing in the month when bids were received, and then only on the portion that exceeds 5%. (See the **LS** and **Design-Build Specifications Section 9**.)

Bituminous adjustments will only be made for asphalt accepted by the Department up to the adjusted quantity limits as defined in **Special Provision Section 9-2.2.2 SP0090103LS**. The adjusted quantity will include any Engineer approved changes. Any quantities exceeding the adjusted quantity limits, which are not Engineer directed, will not be subject to any payment. If an adjustment is made and the work is later determined to be unacceptable, a deduction to the adjustment will be made on the next progress estimate.

NOTE: There will be no bituminous adjustments if Black Base is used when Optional Base is shown on the typical section in the plans.

The **Contractor's Certification of Quantities – Bituminous and Polymer Material (Design-Build and Lump Sum Projects)** is an automated Excel worksheet provided by the Department to calculate gallons of bituminous material and is available at the State Construction Office website below. The Contractor will enter the API for the month the contract was bid and the index for the month of the current progress estimate. These price indexes are posted on the Construction Office website at:

<https://www.fdot.gov/construction/fuel-bit/fuel-bit.shtm>

The Contractor will certify the number of gallons of bituminous material used on the Contract during the period represented by each Contractor's Certified Monthly Estimate. The bituminous adjustment to be paid is generated by the **Contractor's Certification of Quantities – Bituminous and Polymer Material (Design-Build and Lump Sum Projects)** for each monthly progress estimate.

On the **Contractor's Certification of Quantities**, the Contractor will enter the data as follows:

- 1) In the "Setup" tab, enter the following information:
 - a) Contract and Contractor's information, worksheet number and the dates of the period the worksheet covers.
 - b) The Base Average Price Index (BAPI) for the month the Contract was bid and the Current Average Price Index (CAPI) for the month of the current progress estimate.
 - c) The tonnage of asphalt and polymer material placed and accepted during the period included in the progress estimate. (See **Example: Contractor's Certification of Quantities – Setup.**)
- 2) On the "Main Sheet" (BituminousWS" tab), enter the tonnage that represents the bituminous and/or polymer material placed during the period included in the progress estimate (since the previous estimate cut-off date). (See **Example: Contractor's Certification of Quantities – Main Sheet.**)

The RO is responsible for spot checking the base and monthly indexes, tonnage quantities, and adjustment amount, and ensure that the information recorded on the **Contractor's Certification of Quantities** by the Contractor is true and correct. The RO will enter the adjustment amount in PrC as a line adjustment.

EXAMPLE: CONTRACTOR'S CERTIFICATION OF QUANTITIES – SETUP

SIGNATURES This document needs to be signed. View Signatures...																																																																	
CertificationNumber											:	X ✓ fx 8																																																					
AB	C	D	E	F	G	H	I	J	K	L	M	N	O	P	QR																																																		
Contractor's Certification of Quantities Worksheet Asphalt Mixes with Modified and Unmodified Binders (Design Build and Lump Sum Projects) Worksheet No. 8																																																																	
<table border="1" style="width: 100%; border-collapse: collapse;"> <tr> <td style="width: 30%;">Financial Project ID:</td> <td colspan="12">123456-1-52-01</td> </tr> <tr> <td>Contractor:</td> <td colspan="12">We Pave, Inc.</td> </tr> <tr> <td>Contract Number:</td> <td colspan="12">T1234</td> </tr> <tr> <td>From (Mo/Day/Yr):</td> <td colspan="6">03/21/20126</td> <td>To (Mo/Day/Yr):</td> <td colspan="6">04/17/16</td> </tr> </table>													Financial Project ID:	123456-1-52-01												Contractor:	We Pave, Inc.												Contract Number:	T1234												From (Mo/Day/Yr):	03/21/20126						To (Mo/Day/Yr):	04/17/16					
Financial Project ID:	123456-1-52-01																																																																
Contractor:	We Pave, Inc.																																																																
Contract Number:	T1234																																																																
From (Mo/Day/Yr):	03/21/20126						To (Mo/Day/Yr):	04/17/16																																																									
Asphalt Mixes with Unmodified Bonders (PG 67 & Lower)																																																																	
Asphalt Tonnage Placed: <u>638.90</u>																																																																	
Additional Gallons (ARMI*): _____																																																																	
<small>*Asphalt Rubber Membrane Interlayer</small>																																																																	
Base Index Month:			<u>Aug-15</u>			Base Asphalt Price Index:			<u>1.9241</u>																																																								
Current Index Month:			<u>Apr-16</u>			Current Asphalt Price Index:			<u>1.3943</u>																																																								
Asphalt Mixes with Modified Bonders (PG 67 & Higher)																																																																	
Polymer Tonnage Placed: <u>2510.1</u>																																																																	
Base Index Month:			<u>Aug-15</u>			Base Polymer Price Index:			<u>2.4110</u>																																																								
Current Index Month:			<u>Apr-16</u>			Current Polymer Price Index:			<u>1.9182</u>																																																								
Asphalt Material (ASPHALT TREATED PERMEABLE BASE)																																																																	
Asphalt Tonnage Placed: _____																																																																	
Base Index Month:			_____			Base Asphalt Price Index:			_____																																																								
Current Index Month:			_____			Current Asphalt Price Index:			_____																																																								
Navigation Functions																																																																	
<table border="1" style="width: 100%; border-collapse: collapse;"> <tr> <td style="width: 50%; text-align: center;">Go To Main Sheet</td> <td style="width: 50%; text-align: center;">Go To Last Month Sheet</td> </tr> <tr> <td style="text-align: center;">Save As Month Sheet</td> <td style="text-align: center;">Remove Last Month Sheet</td> </tr> </table>													Go To Main Sheet	Go To Last Month Sheet	Save As Month Sheet	Remove Last Month Sheet																																																	
Go To Main Sheet	Go To Last Month Sheet																																																																
Save As Month Sheet	Remove Last Month Sheet																																																																
Effective January 2007 Letting (Updated 11/07/2016)																																																																	

EXAMPLE: CONTRACTOR'S CERTIFICATION OF QUANTITIES – MAIN SHEET

MARKED AS FINAL An author has marked this workbook as final to discourage editing. Edit Anyway

CONTRACTOR'S CERTIFICATION OF QUANTITIES WORKSHEET
 ASPHALT MIXES WITH MODIFIED AND UNMODIFIED BONDERS
 (DESIGN BUILD AND LUMP SUM PROJECTS)

WORKSHEET NO. 8

FINANCIAL PROJECT ID. 123456-1-52-01
 CONTRACTOR We Pave, Inc.
 CONTRACT NO. T1234

PERIOD REPRESENTED:
 FROM (MO/DAY/YR) 03/21/20126 TO (MO/DAY/YR) 04/17/16

ASPHALT MIXES WITH UNMODIFIED BINDERS (PG 67 & LOWER)

ASPHALT TONNAGE PLACED	<u>638.9</u>	TN
GALLONS OF ASPHALT CEMENT USED IN MIX*	<u>9308</u>	GA
ADDITIONAL GALLONS (ARMI*)		
TOTAL GALLONS	<u>9308</u>	GA
BASE ASPHALT PRICE INDEX FOR (8/2015):	<u>1.9241</u>	
CURRENT ASPHALT PRICE INDEX FOR (4/2016):	<u>1.3943</u>	
ASPHALT PRICE INDEX DIFFERENCE:	<u>-0.4336</u>	
MONTHLY DOLLAR AMOUNT:	<u>-4,035.95</u>	

ASPHALT MIXES WITH MODIFIED BINDERS (PG 76 & HIGHER)

POLYMER TONNAGE PLACED	<u>2510.1</u>	TN
GALLONS OF POLYMER USED IN MIX*	<u>36569</u>	GA
TOTAL GALLONS	<u>36569</u>	GA
BASE POLYMER PRICE INDEX FOR (8/2015):	<u>2.4110</u>	
CURRENT POLYMER PRICE INDEX FOR (4/2016):	<u>1.9182</u>	
POLYMER PRICE INDEX DIFFERENCE:	<u>-0.3723</u>	
MONTHLY DOLLAR AMOUNT:	<u>-13,614.64</u>	

ASPHALT MATERIAL (ASPHALT TREATED PERMEABLE BASE)

ASPHALT TONNAGE PLACED		
GALLONS OF ASPHALT CEMENT USED IN MIX*		
BASE PRICE INDEX FOR (_____):		
CURRENT ASPHALT PRICE INDEX FOR (_____):		
ASPHALT PRICE INDEX DIFFERENCE:		
MONTHLY DOLLAR AMOUNT:		

I certify that, based on my personal knowledge and well-founded belief following my own reasonable investigation, the tons and gallons (metric tons and liters) represented by this Certification are true and correct.
 * Calculations based on Specifications.

3/8/2017

X Joe Doe
 Contractor's Authorized Agent

We Pave, Inc. / email@pave.com
 Name of Company and email address

Signed by: Joe Doe

On this application, the Contractor will enter quantities of asphalt placed and accepted that represents the work performed during the period of the

Contractor's Certified Monthly Estimate. The Contractor will record the gallons of bituminous material Asphalt Content or Polymer on the Contractor's Certified Monthly Estimate and submit with the worksheet attached. The PA will review and reconcile any differences on the monthly progress estimate before processing for payment.

NOTE: The RO must ensure that the Contractor records the calculated gallons and submits the **Contractor's Certification of Quantities** with the Contractor's Certified Monthly Progress Estimates, as required in the **LS** and **Design-Build Specifications Section 9-11**.

(B) Submittals

The following documentation items are required to be submitted per Specifications and Procedures:

(1) Job Guide Schedule (JGS)

Per **Specification Section 105-2**, the Contractor will prepare and submit to the PA a JGS using the Materials Acceptance and Certification (MAC) program, 21 calendar days, prior to commencement of construction. The Contractor will update the Job Guide Schedule in MAC to include the quantities and any additional material placed since the previous submittal and submit it to the PA prior to each monthly progress estimate. Payment of any progress estimate not accompanied by an up-to-date JGS may not be authorized. The Contractor will maintain the JGS in MAC throughout the project. The PA will review and accept the JGS before the Contractor can commence work activities that require testing. At final acceptance, the Contractor will submit a Final Job Guide Schedule that includes all materials used on the project. The Final JGS will be in the same format as the monthly reports. Materials not included on the Job Guide Schedule will be accepted in accordance with **Special Provision SP0060100LS** and/or other pertinent contract documents.

Instructions on how to create a Non-Standard JGS for non-conventional projects (i.e., Lump Sum, Design Build, etc.) can be found at:

<https://www.fdot.gov/materials/mac/default.shtm>

(2) Schedule of Values (SOV)

The Contractor is required to submit a SOV within 21 days after contract award or at the pre-construction conference, to the Engineer for approval prior to any work. The SOV is assigned to the work activities with quantities totaling up to the 1 Lump

Sum contract amount. The SOV is the basis for determining the monthly payments. The quantities are compared with project schedule to determine the percentage earned, which is the portion of the work completed each month.

(3) Pay Item Summary and Certification Sheet

The PA will create **Form 700-050-10, Pay Item Summary and Certification Sheet** which will show the original Lump Sum amount with each adjustment, additions or deletions identified on a separate line (i.e., SA numbers and any adjustments specified in **Special provision SP0090103LS** or **Design-Build Specification Section 9**). A Final Lump Sum amount with required signatures will be shown. **Form 700-050-10** can be generated using the [State Construction Office Construction \(SCOC\)](#) application.

(4) Federal Aid Pass Package

For all Federal-Aid Participation contracts, the District Final Estimates Office Manager (DFEM) will submit the **Federal Final Pass Package** documentation to the Federal Highway Administration (FHWA) Office. See the package checklist and required documentation Office of Construction (Final Estimates) [SharePoint site](#), and the [Review and Administration Manual](#) for closeout requirements.

(5) Certified Monthly Estimate and Payment

The Contractor will prepare and submit the Contractor's Certified Monthly Estimate to the PA for approval and processing according to the timeframe specified in the Contract Documents. (See **Special Provision SP0090103LS** or **Design-Build Specifications Section 9**.) The certified monthly estimate will be submitted by the Contractor based on the completion or percent completion of major, well-defined tasks as defined in the approved pay out Schedule of Values (SOV). Any applicable adjustments will be reflected on the current progress estimate.

The PA will not process any monthly estimate for payment until the Contractor's certified monthly estimate is received and approved. The Contractor's certified monthly estimate must include the required **Form 700-010-38, Certification of Previous Periodic Payment to Subcontractors** and the **Form 700-020-02, Construction Compliance with Specifications and Plans**, when applicable.

NOTE: Form 700-050-62, Contractors Certification of Quantities – MOT, Signs and **Form 700-050-67/68, MOT – Painted Pavement Markings Daily Worksheet & Certification of Quantities**, are not required on Lump Sum and Design Build Contracts.

However, the **Traffic Marking Certification Worksheet, Form 700-050-70** is required, see **CPAM Section 5.14.6(E)**.

(6) Shop Drawings

If applicable, the submittal of an approved set of shop drawings will be required by the Contractor.

(7) Final As-Built Plans

The PA will update the **Final As-Built Plans** as the project progresses. The complete **Final As-Built Plans** set, signed, and sealed by the Resident Engineer (RE), will be submitted with the **Final Estimates Documentation**. Refer to **CPAM Chapter 5.12** for **Final As-Built Plans** requirements.

NOTE: For Lump Sum Projects, the Designer is required to provide an estimated quantity in the Summary of Quantity Sheets in the plans by location but should not have totals. Construction Inspection personnel should not be required to document quantities except for asphalt and other items subject to pay adjustments as defined in the Lump Sum Guidelines. Final quantities will be documented on the appropriate forms (e.g., QCRR) but not entered in the summary boxes by the CEI (See **FDOT Design Manual, Chapter 140**.) An example of a Lump Sum Project Schedule of Values can be found at:

<https://www.fdot.gov/construction/altcontract/altcontract.shtm>

6.2.4.6 Design-Build Contract

This section summarizes the required records for processing the **Final Estimates Documentation** on a Design-Build Contract.

Design Build Contracts are Lump Sum Contracts; however, the Department assigns the design and construction to one firm, sometimes allowing construction to begin before plans are completed. Therefore, construction could begin before and during the design phase. This provides a single point of contact for quality, cost and schedule from design through construction thus reducing change orders and claims due to errors or omissions.

NOTE: Since Design Build contracts are LS contracts, many of the required pay adjustments and submittal documentation are the same. To avoid redundancy, references and/or links have been placed throughout this section for information that applies to both Lump Sum and Design Build contracts and the differences have been indicated below.

(A) Adjustments Included in Payment

Calculations for adjustments in payment for Design Build Contracts are the same as Lump Sum contracts, *except* the six-month Statewide pay item weighted averages (using the dates six months prior to the Contract letting date) are used in lieu of the unit prices from Tables 9-1 through 9-4 as shown in [Section 6.2.4.5\(A\)](#).

NOTE: If six-month Statewide pay item averages do not return a unit price for a specific pay item, it is recommended to process a change order with a negotiated unit price for that item.

(1) Asphalt Pay Adjustments

Asphalt pay quantity adjustments apply to asphalt items listed in Contract **Sections 234, 334, 337 and 339**.

Adjustments in pay will only be made for asphalt accepted by the Department up to the adjusted quantity limits as defined in ***Design Build Specification Section 9-2.3.2***. A negative adjustment in pay is made when the asphalt quantity placed is less than the adjusted quantity.

For contracts let prior to January 1, 2017, which are not utilizing adjusted quantity, adjustments will be based on the quantity placed and eligible for payment, not to exceed the total design spread rate tonnage. Per ***Design Build Specification 9-2.3.2***, any quantity exceeding the design spread rate specified in the Contract Documents will not be paid. Therefore, tonnage exceeding the design spread rate, which are not Engineer directed, will not be eligible for payment, including bituminous adjustments.

(2) Retainage

Retainage withheld must be in accordance with the ***Design-Build Specifications*** at the following link:

<http://www.fdot.gov/programmanagement/Implemented/DesignBuild/Default.shtm>

(3) Fuel Adjustment

Fuel Adjustments for asphalt quantities will only be made on work accepted by the Department, up to the adjusted quantity limits as defined in ***Design Build Specification Section 9-2.3.2***.

Fuel adjustments for non-asphalt items, will only be made on the quantity placed not to exceed the payout schedule provided in the Schedule of Values. If an adjustment is made and the work is later determined to be unacceptable, a deduction to the adjustment will be made on the next progress estimate.

Refer to [Section 6.2.4.5\(8\)](#) and *Design Build Specification Section 9-2.1.1* for more fuel adjustment information.

NOTE: Effective for contracts let January 2022 and forward, fuel adjustments will only be made on diesel fuel.

(4) Bituminous Adjustment

Refer to [Section 6.2.4.5\(A\)\(9\)](#) and *Design Build Specification Section 9-2.1.2* for bituminous adjustment information.

NOTE: There will be no bituminous adjustments if Black Base is used when Optional Base is shown on the typical section in the plans.

(B) Submittals

Refer to [Section 6.2.4.5 \(B\)](#) for all submittal information, with exception to the following requirements on Design Build contracts.

(1) Schedule of Values (SOV)

The Design-Build firm is required to submit a SOV to the Department for review and approval. The SOV approved by the Department will be the basis for determining each monthly progress estimate and the final estimate. The SOV is assigned to the work activities with quantities totaling up to the 1 Lump Sum contract amount. No estimates requesting payment will be submitted prior to the Department approval of the SOV.

The Resident Engineer will make partial payments on monthly estimates based on the estimated amount of work that the Contractor completes during the month (including delivery of certain materials) based on the Contractor approved payout schedule (as provided in the SOV). The quantities will be compared with the Project schedule to determine the percentage earned. The percentage will be that portion of the work completed as compared to the total work contracted.

(2) Final As-Built Plans

The Design-Build Firm will identify and update the As-Built Plans as the project progresses. All changes made after the "Released for Construction" Plans will be signed and sealed by the EOR. The Design-Build Firm will submit the As-Built Plans to the PA prior to project completion. The Resident Office responsible engineer will review the As-Built Plans and verify that all changes initiated by the Design-Build Firm or the Department are reflected in the form of revisions. The responsible engineer will review, accept, and sign and seal the **Final As-Built Plans**, according to **CPAM 5.12**, as a condition precedent to the issuance of Final Acceptance.

NOTE: For Design-Build Projects, the Designer is not required to provide quantities with matrixes in the plans, except for Asphalt. If the original quantities are provided with the matrix the final amount is not required to be entered.

6.2.4.7 Contracts with Incentive/Disincentive

The [Incentive/Disincentive](#) (I/D) concept is designed to reduce the overall Contract Time by giving the Contractor an incentive for every day that the Contract is completed early and a disincentive for everyday that the Contract is completed late.

The **Daily Work Report** and **Diary** in PrC are the supporting documentation for payment as outlined in **CPAM Section 5.1**. Each set of the above project forms will show the following statements:

1. Today is the first day or the beginning milestone day of the Incentive/Disincentive phase of this Contract.
2. Today is the last day of the incentive/disincentive phase of this Contract.

The final dollar amount of the incentive/disincentive will be shown as a Contract adjustment to the progress estimate on which it is to be paid, using the PrC code, **Incentive-Disincentive (INDI)**. Supporting remarks will be included when the adjustment is created. See the [PrC User Handbook](#) for more information on adjusting an estimate.

6.2.4.8 Push Button Contracts

This section is not intended for Fast Response nor Emergency Contracts.

This section summarizes the administration of Push Button contracts. It is not the intent of these procedures to supersede the Contract Documents, but to enhance and provide

clarification of the procedures. It is the responsibility of the Resident (RO) to ensure that the Contractor complies with the Contract Documents.

The Department executes Push Button contracts to expedite critical highway construction needs via a competitively bid indefinite quantity contract. The Push Button contract establishes a pre-determined list of pay items to assist in estimating and controlling the cost of the work and the contract is administered through the issuance of Work Documents.

NOTE 1: Requirements for Federally Funded Design-Build Push Button (DBPB) contracts can be found in the [Design Build Procurement and Administration Procedure](#) and the [DBPB Boilerplate RFP](#).

NOTE 2: All Push Button contracts should be recorded in PrC each month. Non-renewable contracts should be paid through the **Electronic Estimate Disbursement (EED) System**. This is accomplished by setting the last approval to **EED** for all estimates except those that are generated as part of the **Final Estimates** process. Those will be set to **EEDFINLS**. Renewable Push Button contracts should be paid through District Financial Services.

(A) Development of the Work Document

The Work Document is the method of conveying the scope and construction plans for Push Button Contracts. Once a request for specific work with preliminary plans is reviewed by the assigned Department office or section (i.e., Traffic Operations, Drainage, etc.), the preliminary plans are distributed for review. Plans are reviewed using the Electronic Review Comment (ERC) system, in accordance with **CPAM Section 1.1**.

Phase reviews can be combined at the discretion of the Design Project Manager and the District Construction Project Manager. Once all comments are addressed, the Draft Work Document is sent to the District Operations Center.

(1) Resident Office (RO) Responsibilities

Upon receipt of the Draft Work Document, the RO will review the plans using the sample checklist as shown in **Guidance Document 1-1-A** in **CPAM Section 1.1.9**. The RO personnel will ensure that:

1. The scope of work is constructible.
2. All proposed pay items are available in the Push Button Contract.
3. All new pay items are biddable.
4. Adequate right of way is present to complete the work as proposed.

5. Easements and license agreements have been executed for all work proposed outside of the right of way.
6. The Traffic Control Plan is feasible.
7. Local agency commitments have been identified.
8. Specified construction time is adequate, based on established production rates, anticipated procurement time of materials, anticipated holidays/special events, and utility relocation schedules.
9. All required permits have been obtained.
10. Ensure all Contractor Insurance Certificates required by the contract are current.
11. Potential environmental issues are identified.
12. Apparent conflicts with utilities have been addressed.
13. Necessary utility relocations have been identified.
14. Utility relocation schedules are achievable.

The Project Administrator (PA) will submit all issues and/or findings to the Design Project Manager for corrections. After the necessary corrections are made, the Design Project Manager will issue the corrected Work Document to the Operations Center for execution with a transmittal memorandum (see [Figure 6.2-3](#)).

Upon receipt of the transmittal memorandum and Work Document, the PA will submit the Work Document to the Contractor for review. The correspondence to the Contractor will include the following:

1. A deadline for the Contractor to submit any concerns about the scope of work. The deadline must be appropriate for the scope of work and not exceed 14 calendar days.
2. Formal cost proposal request from the Contractor for each proposed pay item that is not included in the original Push Button Contract.
3. Anticipated procurement times request from the Contractor for any materials that are not readily available.

(B) Inspection Staff

Each Work Document requires inspection staff. The PA must request the issuance of a Consultant Construction Engineering and Inspection (CCEI) Task Work Order through the Continuing Services Consultant Inspector contract from the CCEI Project Manager after receipt of the Draft Work Document.

(C) Supplemental Agreements (SA) – Form No. 700-010-45

(1) Project Administrator (PA) Responsibilities

Prior to execution of the Work Document, review and negotiate, if necessary, the cost proposal from the Contractor for any additional pay items or contract funds needed to complete the scope of work shown in the Work Document. Execute a SA, in accordance with the following guidance and in accordance with **CPAM Section 7.3**, for any pay items on the Work Document not included in the original Push Button contract or for additional funds required to complete the scope of work in the Work Document.

When processing a SA, include a tabulation of pay items that contains the pay item description, quantity, unit price, extended price, and total dollar amount for all pay items.

Due to the budgetary ceiling associated with Push Button contracts, a line item must be added with the description “Budgetary ceiling items – for accounting purposes only,” for a negative amount totaling the dollar amount of the added pay items. Use the Generic Contract Change Item 9999-3, with a quantity of 1.0 LS. The net amount of the SA must equal Zero Dollars (\$0.00). Do not report any work or adjustments against this negative pay item.

The budgetary ceiling for Push Button contracts is Two Million and 00/100 Dollars (\$2,000,000.00). (See [Topic No.: 350-020-200 - Contract Funds Management - Funds Approval](#) for additional information.) However, the Construction Project Manager has the authority to increase the contract amount by way of a SA. When adding work covered under Local Funds, a separate financial project number is needed to track the local agencies funds.

The use of Work Orders, Initial Contingency pay items, and Contingency Supplemental Agreements on Push Button contracts are **not allowed**. Funding for extra work required on Push Button contracts will be accomplished either by the issuance of subsequent Work Documents, when existing pay items in the contract are sufficient to address the required extra work, or SAs, when additional pay items are required.

(D) Contract and Work Document Administration

(1) Contract Notice to Proceed (NTP)

The District Construction Office will issue and submit the Contract NTP letter to the Contractor notifying the beginning of Contract time on the project documents. This NTP is for the overall contract. The charging of Contract Time will be in accordance with [Push Button Specification SP0050100PB – Control of the Work](#). This letter is to be included as part of the Contract Time documentation.

(2) Work Document NTP

After all the Contractor's concerns have been addressed and the Contractor's cost proposal is accepted, the PA will issue the Work Document NTP to the Contractor. (See [Figure 6-2.4](#).) The start times and allowable completion times on the Work Document NTP only apply to the Work Document, not to the overall contract. Ensure that the Work Document NTP addresses the following:

- a) Established Work Document begin and end construction dates.
- b) Allowable Work Document construction time in calendar days.
- c) The late penalty amount as established under **Supplemental Specification Section 5-1.7 "Work Documents/Liquidated Damages"** of the - contract.
- d) Requirement for the Contractor to provide written notification to the Department at least five (5) days before beginning any work. This notice must include the work activities and associated pay items, and hours of work. (This is especially critical for signing and pavement marking work, since the Contractor may be on site for only a few hours.)

After receipt of the initial Work Document, the Contractor will respond and begin work within fourteen (14) calendar days and within five (5) days of the receipt of any subsequent Work Document, in accordance with the Contract Specifications. (See **Section 5-1.7, SP0050100PB**.)

If the Contractor does not complete the work within the number of calendar days stipulated in the Work Document, the Department will assess the Contractor liquidated damages, per **Section 5-1.7 SP0050100PB** and **Specification Section 8-10.2**.

(3) Contract Time and Work Document Construction Time

Contract Time is the time stated for the overall - Contract. Work Document Construction Time is the time stated for the work included in each individual Work Document. The PA will distribute the Notice of Beginning Work and Completion of Construction Contracts.

(a) Weather/Holiday Time Extensions

Weather and holiday time **will not** be granted for the overall contract. A Weather/Holiday letter is issued for each Work Document (see [Figure 6.2-5](#)) when a controlling item of work is delayed by weather or holidays.

(b) Time Extensions

The PA may grant an extension to the allowable Work Document Construction Time when a controlling item of work is delayed by factors unforeseen, or factors not reasonably anticipated. Granting an extension of the allowable Work Document Construction Time does not extend the overall - contract time. The time extension to a Work Document is granted by a letter. (See [Figure 6.2-6](#).)

Contract time extensions can be issued at the discretion of the Construction Project Manager and District Construction Engineer. (See [Figure 6.2-7](#).) A contract time extension might be necessary when a Work Document is issued too close to the end of the original contract time.

(4) Pre-Work Conference

Upon execution of the contract and for each Work Document issued, the Department will determine if a Pre-Work Conference is warranted. If it is determined a Pre-Work Conference is needed, the PA will schedule it prior to commencement of work.

The Pre-Work Conference should include a representative from the Contractor, each proposed Subcontractor, affected Utility Agency Owners (UAO), affected municipalities, the Design Project Manager, the Engineer of Record, and the Department (See **CPAM Section 3.1**). At the Pre-Work Conference, the Contractor will submit the following (as appropriate for the specific Work Document):

- a) Work schedule.
- b) Contact persons, including after hours and emergency contacts
- c) Proposed subcontractors, material suppliers, submittals, and certifications
- d) Locations of staging areas

- e) Shop drawings (For Signalization projects, **Submittal Data – Traffic Control Equipment, Form No. 750-010-02**, must be submitted with the shop drawings.)
- f) Certificate of Maintenance of Traffic Supervisor
- g) Vehicle registration affidavit
- h) Erosion and Storm Water Pollution Prevention Plan
- i) Maintenance of Traffic Plan
- j) Quality Control Plan
- k) List of Traffic Signalization Material to be used on the project (the PA will send the list of materials to Traffic Operations)

Prior to the start of work, the PA will ensure the following are completed:

- a) Coordination of work with local municipalities. Ensure event coordination is done.
- b) Coordination of staging areas with the Construction Environmental Coordinator.
- c) Notification of local stakeholders of impending scope of work and work schedule.
- d) Lane closure notification to the Department's Public Information Office.

(5) Subcontracting Work

To determine if the Contractor has performed 40% or more of the work, in accordance with **Standard Specification 8-1, Subletting or Assigning of Contracts**, verify the amount subcontracted for each Work Document separately prior to entry into PrC. Since Push Button contracts are based on expended pay item quantities in accordance with the actual plans, the subcontract amount must be entered in PrC as a lump sum amount. The lump sum entry is required, because PrC does not allow subcontracts to overrun contract quantities. Therefore, the subcontracted amount cannot be tracked via PrC directly.

(6) Equal Opportunity Compliance

The Contractor is responsible for Disadvantage Business Enterprise/Minority Business Enterprise (DBE/MBE) data reporting in the **Equal Opportunity Compliance System (EOC)** on all Construction contracts, including - contracts. For more information see:

<http://www.fdot.gov/equalopportunity/eoc.shtm>

(7) Materials Acceptance and Certification

Entry into the **Materials Acceptance and Certification (MAC)** system is required on all materials samples in accordance with the contract documents. (See **CPAM Section 5.8**)

Follow all contract requirements for quality control, materials testing, and certification, unless no testing is required per contract. Contracts will follow the final materials certification process once work on the entire contract is completed.

- a. Each Work Document is regarded as a separate project for the purpose of determining testing requirements for Specifications containing minimum quantity thresholds. Materials with random number testing requirements must have testing performed on the first lot to ensure testing requirements are met.
- b. If each Work Document is submitted to MAC under one contract, the final material certification will encompass all Work Documents. If each Work Document is submitted into MAC as separate contracts, a final materials certification will be submitted for each Work Document (i.e., contract in MAC).

(8) Final Inspection

Conduct a Final Inspection for each Work Document. The Final Inspection should involve all stakeholders, including representatives from the District Maintenance Office, and, if applicable, any Maintaining Agencies.

(E) Monthly Estimate, Payment, and Submittals

1. Plan Quantity payment does not apply, since the contractor does not bid on the scope of contract plans, but on estimated requirements and historical needs. The actual payment under the awarded contract is based on actual quantities completed and accepted (**SP0030100PB - Award and Execution of Contract**).
2. Enter a **Daily Work Report** into PrC for each day of the contract, including days where there are no active work documents to ensure accurate accounting of total contract time. (See **CPAM Section 5.1**.)
3. Monthly Estimates are prepared and submitted following the first Tuesday following the Sunday cutoff each month. (See **CPAM Section 5.11**). Contractor's certifications are required to be submitted no later than twelve o'clock noon Monday following the Sunday cut-off each month (**CPAM Section 5.14**.)

4. Fuel adjustment (**Specification 9-2.1.1 Fuels**) applies to all Push Button contracts with a duration greater than 120 calendar days. (See **CPAM Section 5.14.**)
5. Bituminous adjustment (**Specification 9-2.1.2 Bituminous Material**) applies to Push Button and Renewable Push Button Contracts, when the estimated bid quantity for asphalt is greater than 5,000 tons or the contract duration is greater than 365 calendar days. (See **CPAM Sections 5.14** and **11.4.**)
6. Composite pay factors for asphalt quality apply to all Push Button contracts per the applicable Specifications. (See **CPAM Section 11.4**)
7. The Contractor must submit a completed **Construction Compliance with Specifications and Plans Form No. 700-020-02** when the Work Document includes Contractor Quality Control (CQC) materials as defined in **Specifications 105**. This form is required to process monthly estimates . This form is not required if no Work Document has been issued for the entirety of the contract to date or when there are no CQC materials. (See **CPAM Section 5.11.**)
8. The Contractor must submit a completed **Disbursement of Previous Payments to Subcontractors Form No. 700-010-38**. This form is not required for the first Monthly Estimate processed on a contract but is required for each successive Monthly Estimate. (See **CPAM Section 5.11.**)

(F) Contract and Work Document Final Estimates

Upon completion of all work related to a Work Document, the PA will complete the following:

1. Prepare the **Final Estimates Documentation**, including **Final As-Built Plans**, and submit to the District Final Estimate Manager within 30 days of Final Acceptance of each Work Document.
2. Obtain warranty documentation and submit to the Department's Warranty Coordinator. Enter all warranty information into the **Contract Information and Monitoring (CIM) System**.
3. Obtain acceptance documentation from the local maintaining agency for traffic signals, lighting, irrigation, and landscaping.
4. On Work Documents that include signalization, the following must be completed:
 - a. **Final Acceptance of Traffic Signal Installation(s) and Transfer of Maintenance, Form No. 700-010-22**
 - b. Finalized **Submittal Data – Traffic Control Equipment, Form No. 750-010-02**

- c. Digitally signed and sealed as-built plans from the Contractor – Also distribute to Traffic Operations, the maintaining agency, and input into the ***Electronic Document Management System (EDMS)***.
- d. The As-Built Documentation required by ***Specifications Section 611***, including the As-Built Drawings and the Feature Import Templates for the Department's ITS Facility Management (ITSFM) System, will be submitted by the Contractor, reviewed by the PA for accuracy, and submitted to the District Traffic Operations Office.

5. Resident Final Estimates Responsibilities

Upon completion of the contract time, the following must be prepared:

- a. Ensure the Final Estimates Documentation is complete and accurate according to CPAM. Conduct periodic quality assurance reviews on each Push Button Contract at the frequency determined by the Resident Office Final Estimate Quality Assurance Plan.
- b. Summarize each Work Document using an Excel spreadsheet. The summary must include descriptions, quantities and unit prices for each Pay Item that was installed.
- c. Make sure the cumulative amount from all Work Documents issued under this contract, matches the quantities for each pay item. Resolve all discrepancies and meet with contractor to resolve any outstanding issues (i.e., missing certifications, final quantities, or quality adjustments).
- d. Final Materials Certification is required for all Push Button Contracts.

6. District Final Estimates Responsibilities

Review the complete ***Final Estimates Documentation*** according to Final Estimates ***Review & Administration Manual***. Conduct periodic quality control reviews on active Push Button contracts at the frequency designated by the District Final Estimates Quality Control Plan.

6.2.5 List of Figures Following This Chapter

<u>Figure 6.2-1</u>	Example of Asphalt Adjustment in Design-Build / Lump Sum Projects	33
<u>Figure 6.2-2</u>	Example of Asphalt Adjustment in Design-Build / Lump Sum Projects	34-35
<u>Figure 6.2-3</u>	Example of Transmittal of Work Document.....	36
<u>Figure 6.2-4</u>	Example of Letter of Authorization / Notice to Proceed.....	37
<u>Figure 6.2-5</u>	Example of Letter for Time Extension (Holiday or Weather)	38-39
<u>Figure 6.2-6</u>	Example of Work Document Time Extension	40
<u>Figure 6.2-7</u>	Example of Contract Time Extension	41
<u>Attachment A</u>	Florida Transportation Commission Report.....	42-43

Figure 6.2-1 Example of Asphalt Adjustment in Design-Build / Lump Sum Projects

Quantity Placed > Max Pay Tonnage (105% for this example)

Original Quantities:	Plan	Quantities Placed:
Area 1:	2,516.7 TN	Area 1: 2,656.3 TN @ G_{mm_1} : 2.579
Area 2:	1,187.2 TN	Area 2: 1,264.6 TN @ G_{mm_2} : 2.562
Area 3:	286.1 TN	Area 3: 402.2 TN @ G_{mm_3} : 2.567
Total =	3,990.0 TN	Total = 4,323.1 TN

A. Calculate the Tonnage-Weighted Average G_{mm} :

$$\begin{aligned}
 &= \frac{\sum(\text{Tonnage}_n \times G_{mm_n})}{\text{Total Quantity Placed}} = \frac{(\text{Tonnage}_1 \times G_{mm_1}) + (\text{Tonnage}_2 \times G_{mm_2}) + (\text{Tonnage}_3 \times G_{mm_3})}{\text{Tonnage}_1 + \text{Tonnage}_2 + \text{Tonnage}_3} \\
 &= \frac{(2,656.3 \times 2.579) + (1,264.6 \times 2.562) + (402.2 \times 2.567)}{2,656.3 + 1,264.6 + 402.2} \\
 &= \frac{6,850.60 + 3,239.91 + 1,032.45}{4,323.1} = 2.573
 \end{aligned}$$

B. Calculate the Adjusted Quantity:

$$\begin{aligned}
 \text{Adjusted Quantity} &= \left(\frac{\text{Original Plan Quantity}}{\text{Design } G_{mm}} \right) \times (\text{Tonnage Weighted Average } G_{mm}) \\
 &= \frac{3,990}{2.540} \times (2.573) = 4,041.8 \text{ TN}
 \end{aligned}$$

C. Calculate the Max Pay Tonnage:

$$= 4,041.8 \times (1.05) = 4,243.9 \text{ TN}$$

D. Compare the Total Quantity Placed to the Adjusted Quantity:

$$4323.1 \text{ TN} > 4,041.8 \text{ TN}$$

➡ The 4323.1 Tons that was placed, accepted, and paid exceeds the Adjusted Quantity and the Max Pay Tonnage. Therefore, a negative line-item adjustment of (-79.2) Tons will be deducted for the excess tonnage placed.

Figure 6.2-2 Example of Asphalt Adjustment in Design-Build / Lump Sum Projects

Quantity Placed < Adjusted Quantity

Superpave (Traffic level C)

Original Plan Quantities:		Quantities Placed:	
Area 1:	2,787.5 TN	Area 1:	2,613.6 TN @ $G_{mm_1} = 2.579$
Area 2:	1,357.3 TN	Area 2:	1,394.4 TN @ $G_{mm_2} = 2.562$
Total	= 4,144.8 TN	Total	= 4,008.0 TN

A. Calculate the Tonnage-Weighted Average G_{mm} :

$$\begin{aligned}
 &= \frac{\sum(Tonnage_n \times G_{mm_n})}{Total\ Quantity\ Placed} = \frac{(Tonnage_1 \times G_{mm_1}) + (Tonnage_2 \times G_{mm_2})}{Tonnage_1 + Tonnage_2} \\
 &= \frac{(2,613.6 \times 2.579) + (1,394.4 \times 2.562)}{2,613.6 + 1,394.4} \\
 &= \frac{6,740.5 + 3,572.5}{4,008.0} \\
 &= 2.573
 \end{aligned}$$

B. Calculate the Adjusted Quantity:

$$\begin{aligned}
 Adjusted\ Quantity &= \left(\frac{Original\ Plan\ Quantity}{Design\ G_{mm}} \right) \times (Tonnage\ Weighted\ Average\ G_{mm}) \\
 &= \frac{4,144.8}{2.540} \times (2.573) = 4,198.6\ TN
 \end{aligned}$$

C. Compare the total quantity placed to the Adjusted Quantity:

Total Quantity Placed vs. Adjusted Quantity

$$4,008.0\ TN < 4,198.6\ TN$$

➡ The Total Quantity Placed is less than the Adjusted Quantity. Therefore, a reduction in payment for the amount not placed is needed (-190.6 TN).

D. Calculate the Reduction in Pay:

Table 9-1

Item Description	Unit	Unit Prices
Optional Base/Superpave	SY	\$8.78
Superpave (Traffic level B)	Ton	\$48.62
Superpave (Traffic level C)	Ton	\$52.99
Asph. Conc. Friction Course (FC-6)	Ton	\$56.79

$$\begin{aligned} \text{Pay Reduction} &= (\text{Total Qty. Placed} - \text{Adjusted Quantity}) \times (\text{Unit Price per Table 1}) \\ &= (4,008 - 4,198.6) \times (\$52.99) \\ &= - 190.6 \text{ TN} \times \$52.99 \\ &= - \$10,099.89 \end{aligned}$$

➡ A reduction of \$10,099.89 will be made as a line-item adjustment to the 1 LS item.

NOTES:

For Design-Build projects, use the 6-month Statewide pay item averages to calculate the adjustment in pay. For LS projects, use the unit prices in **Table 1, Section 9** of the Contract **Specifications** to calculate the adjustment in pay.

Enter a new Lump Sum Line-Item Adjustment in PrC.

NOTE: For LS projects with multiple Financial Identification Numbers (FIN), follow the criteria in **CPAM 11**

Figure 6.2-3 Example of Transmittal Memorandum

MEMORANDUM

Date: (DATE)

To: xxxx xxxx, xxxx Operations Engineer

From: xxxx xxxx. District Traffic Operations Engineer

Subject: **Transmittal of Work Document No. XXXX**

Financial Project ID:	xxxxxxx-x-xx-xx
Federal Project ID:	xxxx
Contract No.:	xxxxxxx
County:	xxxxxxx
Description:	xxxxxxx

The design for the referenced Work Document has been completed and is being transmitted for implementation. The summary of the work includes, xxxx xxx xx.

Please refer to the attached Work Document.

Attached are the following Items:

Yes No Approved Plans (X copies)

Yes No Department's Contract Time

Yes No Required Permits (if yes, list agencies and number of copies)

Yes No Utility Clearance Letter

Yes No Rail Clearance Letter

Yes No Cost Estimate

cc: _____ Construction/For Inspection
_____ Maintenance
_____ Design
_____ Prod. Mgmt.
_____ Drainage

Figure 6.2-4 Example of Work Document Notice to Proceed

(DATE)

(CONTACT PERSON)
(PRIME CONTRACTOR)
(ADDRESS)
(CITY, STATE ZIP CODE)

SUBJECT: Letter of Authorization / Notice to Proceed

Financial Project ID:
Federal Job Project ID:
Contract No.:
Work Document No.:
Description:

Dear Sir or Madam:

In accordance with the above referenced agreement between the (CONTRACTOR) and the Florida Department of Transportation, you are hereby authorized to begin work on Work Document (# #####), which is attached.

The allowable construction time for the subject Work Document commences on (DATE) and concludes on (DATE) (## CALENDAR DAYS ALLOWED). Failure to complete the work by (Completion Date) will result in the assessment of liquidated damages pursuant to Section 5-1.7 of the Contract.

Please notify me five (5) calendar days prior to beginning work.

Should you have any questions or concerns, please contact me at (###) ###-####.

Sincerely,

(SIGNATURE)
(NAME), (TITLE)
(LOCATION)

Initial/initial
Attachment
CC: (NAME OF CPM), Construction Project Manager
File

Figure 6.2-5 Example of Weather / Holiday Letter

(DATE)
(CONTACT PERSON)
(PRIME CONTRACTOR)
(ADDRESS)
(CITY, STATE ZIP CODE)

SUBJECT: **ADJUSTMENT TO WORK DOCUMENT TIME FOR THE EFFECTS OF
INCLEMENT WEATHER / HOLIDAYS ON PUSH BUTTON CONTRACT**

Financial Project ID:
Federal Project ID:
Contract No.:
County:
Description:

Dear Sir or Madam:

The daily reports documenting the effects of inclement weather have been evaluated for the period beginning (Month XX, Year through Month XX, Year). It has been determined **XX** calendar day(s) meet(s) the criteria established by the contract for granting additional Work Document time due to the effects of inclement weather.

Holidays have been evaluated for the period beginning (Month XX, Year through Month XX, Year). It has been determined **XX** calendar day(s) meet(s) the criteria established by the contract (***Standard Specifications Section 8-7.3.2***) for granting additional Work Document time due to Holidays.

Your company has ten (10) days from the receipt of this notice to appeal the number of days granted herein. Any such appeal must be accompanied by all available specific facts that support your position. Failure to make an appeal or to provide the specific facts supporting your position within ten (10) days from receipt of this notice shall constitute a waiver of any rights to appeal the Department's decision at a later date. Appeals should be made to the (The appropriate Operations Office and address).

Sincerely,

(NAME OF PE)
Project Engineer

Initial/initial
Attachment

cc: Appropriate Department Personnel, File

TIME EXTENSION – WEATHER/HOLIDAY
NOTIFICATION TO CONTRACTOR

1. DATE: (Month Day, Year)
2. CONTRACTOR: (Name)
3. FIN. NO.: (XXXXXX-XX-XXXX)
4. WORK DOCUMENT NO.: (XXXXX)
5. FOR PERIOD BEGINNING: (Month Day, Year)
6. THROUGH: (Month Day, Year)
7. NUMBER OF LOST DAYS: (XX)
8. ESTIMATE MONTH: (Month Year)
9. PROJECT ENGINEER: (First & Last Name)

Weather Days Granted + Holiday Days = Time this Period

(XX) + (XX) = (XX)

TOTAL GRANTED THIS PERIOD = (XX)

<u>DAY</u>	<u>DATE</u>	<u>CONTRACT DAY #</u>	<u>EXPLANATION OF CONDITION</u>
<u>(XXXX)</u>	<u>(XX/XX/XXXX)</u>	<u>(XXX)</u>	<u>(Designate Holiday or Weather Day)</u>
<u>(XXXX)</u>	<u>(XX/XX/XXXX)</u>	<u>(XXX)</u>	<u>(Designate Holiday or Weather Day)</u>
<u>(XXXX)</u>	<u>(XX/XX/XXXX)</u>	<u>(XXX)</u>	<u>(Designate Holiday or Weather Day)</u>

Figure 6.2-6 Example of Work Document Time Extension

(DATE)

(CONTACT PERSON)

(PRIME CONTRACTOR)

(ADDRESS)

(CITY, STATE ZIP CODE)

SUBJECT: **WORK DOCUMENT TIME EXTENSION**

Financial Project ID:

Federal Project ID:

Contract No.:

County:

Description:

The Department and (CONTRACTOR) have agreed to extend the Work Document allowable completion time by (NUMBER OF DAYS) non-compensable days. This extension is required for the capability of this Contractor to complete a Work Document consisting of (DESCRIPTION OF WORK DOCUMENT). The overall contract time remains the same.

If necessary, a separate Weather Letter will be used to grant additional time to this Work Document for any weather that has affected the controlling work activity.

By your acceptance of this extension of Work Document Allowable Time, you agree to pursue no further claim in connection with the above request. Please sign and return one copy of this letter to District (#) Construction at (EMAIL ADDRESS OF DISTRICT CONSTRUCTION OFFICE) to acknowledge your agreement with these terms and conditions.

Sincerely,

(NAME OF PA)

Project Administrator

Terms and Conditions Accepted:

(NAME OF CONTRACTOR)

By: _____

Date: _____

Initial/initial
Attachment

cc: (NAME OF CONSTRUCTION ENGINEER), Construction Engineer
(NAME OF CPM), Construction Project Manager
File

Figure 6.2-7 Example of Contract Time Extension

(DATE)

(CONTACT PERSON)
(PRIME CONTRACTOR)
(ADDRESS)
(CITY, STATE ZIP CODE)

SUBJECT: **CONTRACT TIME EXTENSION**
Financial Project ID:
Federal Project ID:
Contract No.:
County:
Description:

The Department and (CONTRACTOR) have agreed to extend this Contract by (NUMBER OF DAYS) non-compensable days. This extension is required for the capability of this Contractor to complete a Work Document consisting of (DESCRIPTION OF WORK DOCUMENT).

If necessary, a separate Weather Letter will be used to grant contract time for any weather that has affected the controlling work activity on this Work Document.

By your acceptance of this time extension, you agree to pursue no further claim in connection with the above request. Please sign and return one copy of this letter to **District (#) Construction at (EMAIL ADDRESS OF DISTRICT CONSTRUCTION OFFICE)** to acknowledge your agreement with these terms and conditions.

Sincerely,

(NAME OF DCE)
District Construction Engineer

Terms and Conditions Accepted:
(NAME OF CONTRACTOR)

By: _____

Date: _____

Initial/initial
Attachment

cc: (NAME OF CONSTRUCTION ENGINEER), Construction Engineer
(NAME OF CPM), Construction Project Manager
(NAME OF PA), Project Administrator
File

Attachment A: Florida Transportation Commission Report

(A) Florida Transportation Commission Report Values

- Report is run quarterly starting at the beginning of the fiscal year (July).
- Construction contract types pulled are “Construction Contract (CC)”, “Construction Design Build(CDB)”, “Construction Design Build Finance(CDBF)”, “Construction Design Build – Low Bid”, “Construction Design Build Finance Operate Maintain(CDBO)”, “Construction Lump Sum(CLS)”, “Construction Streamline(CSL)”, & “Construction Hold Witness(CHW)”.
- It is a cumulative report. It contains contracts that have reached “Passed” status within the fiscal year you are running the report for (July – June). This date is pulled from PrC.
- Excludes
 - Work Types Maintenance Other (I), and Traffic Operations (X7)
 - Letting Status of Rejected(R) and Canceled(C)
- Any charged day on a diary in PrC is considered a day used

(B) Time

Percent Time = (Days Used – Weather Days – Holiday Time Extension Days)/Original Days

Weather Days = All Change orders coded type WE

Holiday Time Extension Days = All change orders coded type HTEX

Note 1: Weather Days includes all weather related and recovery days.

Note 2: WEA1 and WEA2 and Hurricanes

(C) Money

Percent Money = Actual Expenditure/Adjusted Original Amount

Actual Expenditure = All Expenditures and revenue for Phase 52, 56, 57, and 58

Adjusted Original Amount = (Awarded Contract Amount – Contingency Amount)

Note 1: 5A = Construction Contract Bonus. See [5A Fund Types](#).

Note 2: Actual Expenditure Does Not Include Material Price Adjustments and 5A Fund Types (Innovative Contract Adjustments).

Note 3: Actual Expenditure Does Not Include Hurricanes.

(D) 5A Fund Types (Innovative contract adjustments):

- ABID A+B Incentive-Disincentive
- INDI Incentive-Disincentive
- LRID Lane Rental Incentive-Disincentive
- LSAV Liquidated Savings
- NEXB No Excuse Bonus

(E) Material Price Adjustments

Line-Item Adjustment types:

- MPAG Material Price Adjustment Guardrail
- MPAA Material Price Adjustment Aluminum
- MPAP Material Price Adjustment PVC
- MPAC Material Price Adjustment Copper
- MPAS Material Price Adjustment Steel

(F) Time Extensions

Change Order types:

- EA (Time Extension Agreement)
- SA (Supplemental Agreement)
- HTEX (Holiday Time Extension/Special Events)
- WE (Weather Days' Time Granted)

(G) SA Days

Approved SA Days: Change Order Types:

- SA (Supplemental Agreement)
- UN (Unilateral Payment)

Section 7.2

TIME EXTENSIONS

7.2.1 Purpose

To provide a uniform process for administering construction contract time extension requests and for documenting, executing and distributing time extensions.

7.2.2 Authority

Sections 20.23(3)(a), 334.048(3), Florida Statutes (F.S.)

7.2.3 Reference

337.015, Florida Statutes (F.S.)
Articles 8-6 and 8-7, Specifications for Road and Bridge Construction

FHWA Approved: February 6, 2015

7.2.4 General

This section will address the three specification conditions that will occur.

- (1) The granting of time extensions to account for effects of inclement weather: These contracts will contain specifications requiring an ongoing evaluation to occur and time adjustments, when justified, will be granted by the Districts. This condition is covered in detail under **Section 7.2.5**.
- (2) The granting of time extensions for reasons other than the effects of inclement weather, Holidays or Special Events. The contract specifications and operating procedures for these contracts will require early identification and resolution of time extension requests. This condition is covered in detail under **Section 7.2.6**.
- (3) The granting of time extensions to account for effects caused by the suspension of contractor's operations for Holiday(s) and Special Events as defined in **Specification 8-6**, contract plans or Request for Proposal. These contracts will contain specifications requiring an evaluation to occur and time adjustments, when justified, will be granted by the Districts. This condition is covered in detail under **Section 7.2.7**.

7.2.5 Time Extensions for Delays Caused by Weather

Resident Level Responsibilities

7.2.5.1 Weather Delays to Controlling Items of Work

Extensions of contract time for delays caused by the effects of inclement weather are justified only when rain or other inclement weather conditions or related adverse soil conditions prevent the Contractor from productively performing controlling items of work resulting in:

- (1) The Contractor being unable to work at least 50% of the normal work day on predetermined controlling work items; or
- (2) The Contractor must make major repairs to work damaged by weather, provided the damage was not attributable to a failure to perform or neglect by the Contractor.

7.2.5.2 Project Administrator's Weather Time Recommendations

The Project Administrator will continually monitor the effects of weather and when found justified, recommend to the Resident Engineer time extensions, on either a bimonthly or monthly basis. The Contractor will not be required to submit a request for additional time due to the effects of weather. The following procedures are to be followed in completing these time extensions.

- (1) The Project Administrator will be directly responsible for accurately documenting weather data for each assigned construction project and the extent that work is performed on a controlling item of work on the **Daily Work Report**.
- (2) The Project Administrator will make a recommendation to the Resident Engineer to grant time as a result of the effects of weather as defined. The recommendation will include a copy of the **Daily Work Report** and the **Work Plan - Controlling Item of Work, Form No. 700-010-15** as back-up if a Critical Path Method schedule is not a contract requirement. This recommendation may not be contingent on whether the Contractor appears at the project on any given day but had intentions of doing so. If it is reasonable to conclude, based on the weather forecast, that there is little likelihood of productive work being accomplished on a controlling work item for 50% of that day, a time extension should be granted and the Contractor should not be expected to mobilize labor and equipment that day. Such determinations can be made in advance for a period no greater than a week.

7.2.5.3 Weather Delays For Projects

Time extensions will be granted on a contract day per delayed day.

- (1) The contractor provides a schedule which identifies the intended work week, thus determining the scheduled work days and the controlling items of work. If inclement weather effects the contractor's ability to productively perform controlling items of work on one of the scheduled work days as allowed by **Specification 8-7**, a day is granted. Weekend days are eligible for weather days provided the weekend day is a scheduled workday and is shown as a scheduled workday on the accepted schedule or **Work Plan - Controlling Item of Work, Form No. 700-010-15**. The Project Administrator and the Contractor's representative must agree ahead of time as to the controlling items of work and the number of days of the week to be worked. No weather delays will be recognized before the Contractor begins work or attempts to begin work in accordance with the approved project work schedule. Weather days will be granted only during the authorized Contract Time Period.
- (2) The Resident Engineer will notify the Contractor of the number of weather days granted. This notice will be sent out either on a bimonthly or monthly basis. See **Guidance Document 7-2-A** for a sample letter.

7.2.6 Time Extensions Not Related to Weather Delays, Holidays or Special Events

Resident Level Responsibilities

Contract time extensions will be considered only for the reasons set forth under the terms of the contract. A time extension letter shall not be used to document a contract time reduction. A **Supplemental Agreement** or **Work Order** must be used for that purpose. Time extensions may be granted during the contract time period or authorized extensions of the contract time period. The time needed by a Contractor for permit applications and approval is not an allowable reason to grant additional contract time, except as may be allowable under the provisions of **Specification 120-6.2**. The following establishes the process for evaluating, documenting and making decisions to approve or deny time extensions.

- (1) The Contractor has access to all the required construction forms through the Department provided web-based collaboration site and is to electronically submit all written communication associated with the Contract through the site in accordance with **Specification 4-1**.

- (2) When the Contractor submits a request for a time extension after the commencement of a delay and in accordance with **Specification 5-12 and 8-7**, the standard time extension request form shall be used.
- (3) When the Contractor submits a time extension request after the elimination of the delay and in accordance with **Specification 5-12 and 8-7**, the standard time extension request form shall be used.
- (4) The Resident Engineer shall provide written acknowledgment of each Contractor's time extension request. If the information submitted on the standard form is determined to be incomplete or fails to meet the requirements of the contract for consideration as a time extension request, the Resident Engineer will reject it. See **Guidance Document 7-2-D** for a sample response for these actions.
- (5) The Resident Engineer has the authority to approve time extension requests up to a cumulative maximum of thirty (30) days or 5% of the original contract time, whichever is greater. The District Construction Engineer (DCE) shall approve all time extension requests in excess of thirty (30) days or 5% of the original contract time, whichever is greater. Documentation of the reasons for decisions on granting or denying time extension requests shall be maintained in the project file. When a decision on approval for a time extension is made by the DCE, the DCE will inform the Resident Engineer of that decision including the reasons for it. The Resident Engineer will send a letter to the Contractor granting the additional time or denying the request. The denial or approval should include a concise response explaining the findings and decision for each issue raised by the Contractor's request. Time granted as part of a work order does not require a separate letter to the contractor. All backup documentation would still be required in the project file.

Time extension approval letters not related to Weather, Holidays and Special Events shall include the following standard disclaimer statement:

"By your acceptance of this time extension, you agree to pursue no further claim in connection with the above request. Please sign and return one copy of this letter, to acknowledge your agreement with these terms and conditions."

*Terms and Conditions Accepted
(Contractor's corporate name)*

By: _____ Date: _____

7.2.7 Time Extensions for Delays Caused by Suspension of

Contractors Operations for Holidays and Special Events

Resident Level Responsibilities

7.2.7.1 Suspension of Contractors Operations – Holidays and Special Events Delays to Controlling Items of Work

Extensions of contract time caused by the suspension of contractor's operations for Holidays and Special Events as defined in **Specification 8-6** are justified only when said suspension prevents the Contractor from productively performing controlling items of work.

7.2.7.2 Project Administrator's Recommendation

The Project Administrator will monitor the effects that Holidays and Special Events as defined in **Specification 8-6** have on controlling items of work and recommend to the Resident Engineer Holiday and Special Event related time extensions. The Contractor is to submit a written request to work on a Holiday or Special Event at least ten (10) days in advance of the requested date and receive written approval from the Engineer. The Department will grant contract time for each day noted in the Specification or on the Plans, even if the Holiday or Special Event falls on a contract day shown in the contractor's schedule as a non-work day. An exception to this would be if the contractor requested and received approval from the Department to work on a holiday or special event day as allowed for in Specification 8-6.4. Holiday or Special Event time extensions do not require DCE approval and do not count toward the time extensions approval thresholds under **Section 7.2.5 (5)**. Holiday or Special Event days will be granted only during the authorized Contract Time Period.

The contractor provides a schedule which identifies the intended work week, thus determining the scheduled work days and the controlling items of work. If the contractor is unable to productively perform controlling items of work due to the suspension of operations for a defined Holiday or Special Event, the contractor would be granted time for the Holiday or Special Event suspension.

The Resident Engineer will notify the Contractor of the number of days granted related to the Holiday or Special Event suspension. See **Guidance Document 7-2-B** and **Guidance Document 7-2-C** for sample letters.

7.2.8 Appeals

District Level Responsibilities

In the event the Contractor appeals the Department's decision, the DCE will

evaluate any new facts. All needed coordination will be accomplished with the district's support staff, the district's legal counsel, the central office staff and the FHWA. The DCE will coordinate with the District Director of Operations and the District Secretary to notify the Contractor of the results of the Department's review of the appeal.

7.2.9 Federal-Aid Participation

7.2.9.1 FHWA Projects of Division Interest

Construction projects with Federal funding require that Department staff must have considered and decided on Federal-Aid participation or requested Federal-Aid participation in any time extension. The FHWA shall decide the amount, if any, of Federal-Aid participation time extensions granted for Projects of Division Interest (PODI). The District will determine the amount on Delegated Federal-Aid projects.

Resident Level Responsibilities

On PODIs, a letter shall be prepared by the Resident Engineer on In-House CEI projects and the Department's Construction Project Manager on Consultant CEI Projects, requesting FHWA for Federal Aid participation based on the facts stated in the letter. See **Guidance Document 7-2-E** for a sample letter.

When the copy of the request for a time extension indicating FHWA denial (partial or whole) is received, the Resident Engineer on In-House CEI projects and the Department's Construction Project Manager on Consultant CEI Projects, will decide whether or not to appeal the decision.

When the appeal of the FHWA's denial of a time extension receives another denial, such denial may be considered final FHWA determination, and their copy of the transmittal will be distributed as previously described.

7.2.9.2 Delegated State Oversight Projects

Neither FHWA approval nor State Construction Office concurrence in Federal Aid participation is required for time extensions granted on FHWA Delegated Projects.

(A) Resident Level Responsibilities

The Resident Engineer's staff shall develop the contract change document, submit the document to the DCE for review and solicit a determination of FHWA participation before any time extension is granted.

(B) District Level Responsibilities

The DCE shall determine the number of days eligible for Federal Aid participation. The guidelines contained in the latest version of the ***Florida Federal-Aid Partnership Agreement, Procedure No. 700-000-005, CPAM 7.3.11.1***, as well as past precedents, should be used in determining Federal Aid participation. The DCE shall approve, in writing, the number of days determined to be Federal-Aid Participating or Non-Participating. The approval from the DCE, identifying the number of days which are Federal-Aid Participating or Non-Participating, shall be maintained in the project file. An email from the DCE or delegate will suffice as documentation of approval. The DCE can delegate such approval authority to a person within District Construction Office staff, but not to a Resident Engineer. Such delegation shall be maintained on file in the District Construction Office.

7.2.10 Contract Change Tracking System

District Level Responsibilities

Within fifteen (15) calendar days after the date of a time extension letter, the DCE, or designee, shall decide upon the final contract change coding and enter the time extension information into AASHTOware Project Construction (PrC) and/or the Contract Change Tracking System. Time Extensions granted for Weather, Holidays and Special Events are to be entered into PrC only and are not to be entered into the Contract Change Tracking System. All other Time Extensions granted to the Contractor are to be entered into both systems. If the DCE's designee is not a member of the District Construction Office staff, the DCE's delegation shall be maintained on file in the District Construction Office. Further, if the DCE's designee is not a member of the District Construction Office staff, the DCE shall develop a quality assurance process to ensure accurate contract change coding and compliance with this section. Such process shall be documented and maintained on file in the District Construction office.

For an explanation of the codes involved, see the information published under "Coding Contract Changes" heading as an attachment to ***CPAM Section 7.3*** on the State Construction Office website at: <https://www.fdot.gov/construction/manuals/cpam/cpammanual.shtm>

7.2.11 Quality Control Process for Contract Changes

District Level Responsibilities

The DCE shall develop a process to annually review a representative sample of all time extensions to ensure such changes were necessary and comply with the

construction contract documents. Such process will be documented and maintained on file in the District Construction Office for State Construction Office and FHWA review

Guidance Document 7-2-A
SAMPLE WEATHER LETTER TO CONTRACTOR

Date:

Contractor's NAME
ADDRESS
CITY, STATE, ZIP CODE

Re: Adjustment to Contract Time for the Effects of Inclement Weather
Financial Project ID:
Project No.:
State Job No:
Contract No.:
F.A.P. No.:
County:

Dear Sir or Madam:

The daily reports documenting the effects of inclement weather have been evaluated for the period beginning (date) through (date). It has been determined (number) of calendar day(s) meet the criteria established by the contract for granting additional contract time due to the effects of inclement weather. It has been determined that (number) contract day(s) will be added to the total authorized contract time.

Your company has ten (10) days from receipt of this notice to appeal the number of days granted herein. Any such appeal must be accompanied by all available specific facts that support your position. Failure to make an appeal or to provide the specific facts supporting your positions within ten (10) days from receipt of this notice shall constitute a waiver of any rights to appeal the Department's decision at a later date.

Sincerely,

Resident Engineer

cc: District Construction Engineer

Guidance Document 7-2-B
SAMPLE HOLIDAY LETTER TO CONTRACTOR

Date:

Contractor's NAME
ADDRESS
CITY, STATE, ZIP CODE

Re: Adjustment to Contract Time for the Effects of Holiday Suspensions
Financial Project ID:
Project No.:
State Job No:
Contract No.:
F.A.P. No.:
County:

Dear Sir or Madam:

Since your firm did not request to work during the holiday period specified above, as outlined in **Specification 8-6.4**, the Daily Report documenting this holiday period have been evaluated. It has been determined (*number*) calendar day(s) meet(s) the criteria established by the Contract for granting additional time due to the suspension of operations for this holiday period. Pursuant to **Specification 8-7.3.2**, (*number*) contract day(s) will be added to the total authorized contract time.

Your company has ten (10) days from receipt of this notice to appeal the number of days granted herein. Any such appeal must be accompanied by all available specific facts supporting your position. Failure to make an appeal or to provide the specific facts within ten (10) days from receipt of this notice shall constitute a waiver of any rights to appeal the Department's decision at a later date.

Sincerely,

Resident Engineer

cc: District Construction Engineer

Guidance Document 7-2-C
SAMPLE SPECIAL EVENT LETTER TO CONTRACTOR

Date:

Contractor's NAME
ADDRESS
CITY, STATE, ZIP CODE

Re: Adjustment to Contract Time for the Effects of Special Event Suspensions
Financial Project ID:
Project No.:
State Job No:
Contract No.:
F.A.P. No.:
County:

Dear Sir or Madam:

Since your firm did not request to work during the Special Event period specified above, as outlined in **Specification 8-6.4**, the Daily Report documenting this Special Event period have been evaluated. It has been determined (*number*) calendar day(s) meet(s) the criteria established by the Contract for granting additional time due to the suspension of operations for this Special Event period. Pursuant to **Specification 8-7.3.2**, (*number*) contract day(s) will be added to the total authorized contract time.

Your company has ten (10) days from receipt of this notice to appeal the number of days granted herein. Any such appeal must be accompanied by all available specific facts supporting your position. Failure to make an appeal or to provide the specific facts within ten (10) days from receipt of this notice shall constitute a waiver of any rights to appeal the Department's decision at a later date.

Sincerely,

Resident Engineer

cc: District Construction Engineer

Guidance Document 7-2-D

**SAMPLE LETTER
RESIDENT ENGINEER TIME EXTENSION RESPONSE**

Date:

Contractor NAME/ADDRESS
TOWN, STATE, ZIP CODE

SUBJECT: Time Extension Request
Financial Project ID:
Project No.:
State Job No:
Contract No.:
F.A.P. No.:
County:

Dear Sir or Madam:

On ____ (date) ____, you submitted a request for an extension of the contract time for State Project No. _____.

(This request has been received by this office and is presently under review. Upon completion of the Department's review, you will be notified of the approval or denial of the time extension. It is anticipated that this notification will be given on or before (date)).

or

(This information you submitted is incomplete and is being returned. Upon receipt of complete information, we will continue to process your request.)

or

(Your request fails to meet the requirements of the contract for consideration as a time extension for the following reasons:)

(State Reasons)

Sincerely,

Resident Engineer

cc: District Construction Engineer

Guidance Document 7-2-E

**SAMPLE LETTER TO FHWA REQUESTING CONCURRENCE AND
PARTICIPATION OF AN APPROVED TIME EXTENSION
UNDER FHWA PROJECT OF DIVISION INTEREST**

Date:

Mr. (Division Administrator)
Division Administrator
Federal Highway Administration
545 John Knox Road, Suite 200
Tallahassee, Florida 32303

Attention: (Area Engineer)

Subject: Recommendation on Time Extension Request
Financial Project ID:

Contract No.:
Federal Aid Project No.:
Contractor's Request No.:

Enclosed is a copy of the District staff's evaluation of the subject time extension request. Our analysis concludes the following time extension item(s) is/are justified:

(List each item identified by the time extension, the number of days requested, and the number of days to be granted. Include a short summary of the basis for the decision to grant or not grant time.)

We respectfully request FHWA concurrence and participation.

Sincerely,

Resident Engineer or
Construction Project Manager

Section 7.3

SUPPLEMENTAL AGREEMENTS AND UNILATERAL PAYMENTS

7.3.1 Purpose

To provide a uniform procedure for District Construction Offices to initiate, document, execute and distribute construction contract changes by **Supplemental Agreements** and **Unilateral Payments**.

7.3.2 Authority

Sections 20.23(3)(a), 334.048(3) Florida Statutes (F.S.)

7.3.3 Reference

334.185, 337.11(9), 337.11(12), 337.185, 339.135(6)(a), Florida Statutes (F.S.)

Federal Aid Policy Guide (23 CFR 635)

FHWA Approved: February 26, 2015

Chapter 7, Section 4 - Contingency Supplemental Agreements

Procedure No. 375-020-010, Errors Omissions, and Contractual Breaches by Professional Engineers on Department Contracts

Procedure No. 700-000-005, Florida Federal-Aid Partnership Agreement

Section 4, Standard Specifications for Road and Bridge Construction

7.3.4 Identifying the need for a Supplemental Agreement or Unilateral Payment

7.3.4.1 Supplemental Agreements or Unilateral Payments shall be used to:

- (A) Clarify the plans and specifications of a contract.
- (B) Provide for unforeseen work, grade changes, or alterations in plans that could not reasonably have been contemplated or foreseen in the original plans and

specifications.

- (C) Change the limits of construction to meet field conditions. Change to the limits of construction on a Federal Aid contract will require a FMIS modification.
- (D) Provide a safe and functional connection to an existing pavement.
- (E) Settle contract claims (for **Supplemental Agreements** only).
- (F) Make the project functionally operational in accordance with the intent of the original contract.
- (G) Expand the physical limits of a project only to the extent necessary to make the project functionally operational in accordance with the intent of the original contract. The cost of any such additional work extending the physical limits of a project shall not exceed \$100,000.00 or ten (10) percent of the original contract price, whichever is greater. If the Director, Office of Construction determines that a fair bidding practice concern exists, a public interest finding will be included in the project file.
- (H) Give effect to the negotiated settlement of a dispute.

7.3.4.2 Unilateral Payments will be used to pay the Contractor for work performed on a project when:

- (A) The Contractor agrees to perform the work at an agreed upon cost but refuses to timely execute a **Supplemental Agreement** to allow timely payment for the work by the Department or,
- (B) The Department and the Contractor cannot agree on the cost of additional work, and the Contractor refuses to execute a **Supplemental Agreement** or,
- (C) The Department determines it is in its best interest to make a **Unilateral Payment** for work the Department directed to be performed in lieu of pursuing a **Supplemental Agreement**.
- (D) The Department and Contractor cannot agree on the value of work deleted from the Contract. All unilateral payments should be 1 lump sum using the 9999 5 UNILATERAL PAYMENTS (S/M ONLY) pay item, except as indicated lump sum contracts below. It is recommended that all unilateral payments have a positive unit price to ensure the 230 funds are allocated properly. If the circumstances require a negative unilateral payment, contact the State Final Estimates Office and/or State System Section for further direction.

When work is deleted from a Lump Sum or Design Build Contract, a Supplemental Agreement shall be used to reduce the contractual obligation. An encumbrance

shall be processed through the Contract Funds Management System after the Supplemental Agreement has been executed. The Unilateral Payment will include an AASHTOware Project Construction (PrC) coding sheet that does not include any pay items. The credit will be processed as a line item adjustment by selecting "Credit for Contract Changes". This ensures that funding is credited back to the proper function, not to the Unilateral Funds (230 funds). Unilateral Payments should not increase existing contract payment items. Contact the State Final Estimates Office and/or State System Section for further direction. The supporting documentation for the negative encumbrance should be included as documentation for the negative Unilateral Payment.

7.3.5 Initiating Supplemental Agreements and Unilateral Payments

The District Operations staff will ensure that the terms of all **Supplemental Agreements and Unilateral Payments** are in the best interest of the Department and comply with procedures, specifications, and statutory requirements governing construction contract administration.

Before a **Supplemental Agreements** or **Unilateral Payment** can be issued against any Non-State Highway System (Off-System), federally funded project being constructed by the Department for a Local Government, the Project Administrator shall ensure that the Design Project Manager has obtained a Maintenance Agreement (MOA) between the Department and the Local Government (Refer to **Financial Provisions for All Department Funded Agreements, Procedure 350-020-301**). The Maintenance Agreement shall establish that the Local Government is responsible for additional project costs determined to be Federal Aid Non-Participating.

All **Supplemental Agreements and Unilateral Payments**, including those initiated in response to contract claims, will be supported and documented by an **Engineer's Estimate** and an **Entitlement Analysis** (see **Guidance Document 7-3-A**). Lump sum items shall not be used without detailed itemization stating the quantities and unit prices the lump sum item was based on.

For Lump Sum contracts, including Design-Build contracts, supplemental agreements should be included within the lump sum line item for the entire contract amount. When work is either deleted or added, the SA will address the original LS bid item by deleting it. Then, the SA will address the addition or deletion of additional work by adding the LS pay item 0999 2 LUMP SUM CONTRACT, ALTERNATIVE BIDDING with the new unit price. The new unit price is calculated by either subtracting or adding the dollar change to the bid unit price to come up with the new unit price. There may be several instances of this happening on a single contract depending on how much work is added or deleted throughout the life of the contract. Do not overrun the 1 LS pay item. See **CPAM 7.3.4.2** for more information credits on projects.

When a **Supplemental Agreement or Unilateral Payment** must be initiated on a project with consultant-prepared plans and contract documents, refer to **Procedure No. 375-020-010, Errors, Omissions, and Contractual Breaches by Professional Engineers on Department Contracts**.

7.3.5.1 Significant Changes

All significant changes causing an increase or decrease in the unit cost of a pay item must be documented with a completely executed **Supplemental Agreement or Unilateral Payment**. Note that either of these types of contract changes will require an **Entitlement Analysis** and an **Engineer's Estimate**. Certification of availability of funds must be obtained from the Comptroller's Office prior to directing the Contractor to perform the work when the change results in an increase in the cost of the project.

7.3.5.2 Project Limit and Construction Limit Extensions

(A) Resident Level Responsibilities

Section 337.11(9)(b), F. S. states that **Supplemental Agreements** may only be used to expand the physical limits of a project only to the extent necessary to make the project functionally operational in accordance with the intent of the original contract. The cost of any such agreement extending the physical limits of a project shall not exceed \$100,000, or ten (10) percent of the original contract amount, whichever is greater. For this section, the term physical limits means the length or width of any project and specifically includes drainage facilities not running parallel to the project.

Authorization from the Director, Office of Construction is required before extending the project limits (as depicted on the contract plans) to perform work other than feathering (milling and resurfacing), friction course placement, guardrail, drainage, signing, pavement marking, sidewalk, and transitions for maintenance of traffic. Authorization from the District Construction Engineer (DCE) is required before extending the project limits (as depicted on the contract plans) to perform feathering (milling and resurfacing), friction course placement, guardrail, drainage, signing, pavement marking, sidewalk, and transitions for maintenance of traffic. Authorization from the Director, Office of Construction is required before extending the construction limits (as depicted on the contract plans) on any project. Any change to the project limits must also be approved by the District PLEMO for NEPA clearance as part of the authorization process.

On FHWA Projects of Division Involvement (PODI), FHWA concurrence for project limit and construction limit extensions must be obtained in accord with **CPAM Section 7.3.10.2**.

Prior to processing a project limit or construction limit extension, for Department-prepared plans, notify the Department's Engineer of Record. For consultant-prepared plans, notify the Department's Design Project Manager

(B) District Level Responsibilities

The DCE shall approve project limit (as depicted on the contract plans) extension requests to perform feathering (milling and resurfacing), friction course placement, guardrail, drainage, signing, pavement marking, sidewalk, and transitions for maintenance of traffic. The DCE recommendation must be included on all requests for extending project limits (as depicted on the contract plans) to perform work other than feathering (milling and resurfacing), friction course placement, guardrail, drainage, signing, pavement marking, sidewalk, and transitions for maintenance of traffic. The DCE recommendation must be included on all requests for extending construction limits (as depicted on the contract plans).

(C) Central Office Level Responsibilities

The Director, Office of Construction will review project limit (as depicted on the contract plans) extension requests to perform work other than feathering (milling and resurfacing), friction course placement, guardrail, drainage, signing, pavement marking, sidewalk, transitions for maintenance of traffic, and construction limit extension (as depicted on the contract plans) requests to assure they have received the recommendation of the District Construction Engineer and that they comply with **Section 337.11(9)(b), F.S.**

7.3.5.3 Plan or Specification Changes

(A) Resident Level Responsibilities

All changes to the contract plans or specifications must be documented with a completely executed **Supplemental Agreement or Unilateral Payment**, with prior certification of availability of funds from the Comptroller's Office required.

Prior to initiating a plan or specification change, for Department-prepared plans, notify the Department's Engineer of Record. For consultant-prepared plans, notify the Department's Design Project Manager.

Prior authorization from the Director, Office of Construction shall be obtained before implementing any changes to contract specifications on all contracts (including District let contracts).

On FHWA PODIs, FHWA concurrence for plan and or specification changes must be obtained in accordance with **CPAM Section 7.3.10.2**.

When a **Supplemental Agreement or Unilateral Payment** documents plan changes, the plan sheets being revised and the date of revision for each must be listed in the document.

(B) District Level Responsibilities

The District Construction Engineer's recommendation must be included on all requests for contract specification changes. The DCE may authorize a no-cost change which extends the material acquisition or flexible start time after issuance of the Notice To Proceed.

For projects on which the DCE has authorized the above change, the DCE also has the authority to revise, by no cost specification change, the submittal times for the Project Schedule and Quality Control Plan.

(C) Central Office Level Responsibilities

The Director, Office of Construction will review and approve any changes to contract specifications.

7.3.5.4 Quantity Overruns

The passage and signing into law of **HB 1681 (2005)** eliminated the requirement of a **Supplemental Agreement** for major quantity differences resulting in the Contractor's work effort exceeding the original contract amount by more than five (5) percent. Therefore, to manage the potential overrun of quantities on contracts the Department has implemented the following procedure.

(A) Resident Level Responsibilities

Without encumbering any additional funds, projects with an original contract amount of \$5 million or less, may incur overruns to the current contract amount up to the Allowable Unencumbered Overruns Amounts (AUOA) which is calculated as follows. To find the AUOA, the initial Contingency Pay Item amount is subtracted from the Original Contract amount and the result is multiplied by two and one-half (2.5) percent. Although overruns up to the AUOA may be paid as unencumbered disbursements, management encourages project managers to program and encumber additional funds for any outstanding unencumbered overrun amount prior to the expenditures exceeding the contract amount. Overruns in excess of the AUOA must have additional funds encumbered prior to the authorization of the work that will cause the contract (not pay item or project) to overrun.

Projects with an original contract amount more than \$5 million are required to have

additional funds encumbered to cover overruns to the contract (not pay item or project) on regular work prior to the authorization of the work that will cause the contract (not pay item or project) to overrun. Contingency funds may not be used for overruns.

In the interest of proper construction contract administration, it is essential that dollar amounts of overruns and underruns be tracked in an overrun/underrun log throughout the life of the project.

Construction Project Managers are encouraged to keep this log as a Microsoft Excel spreadsheet file, however, a hard copy will be acceptable. For each overrun or underrun, this log should include the pay item, the quantity, the location, the dollar amount involved and a brief explanation of the reason for the overrun or underrun. An immediate, comprehensive analysis of the impact on the final contract amount of any substantial overrun or underrun in one or more pay items should also be made as soon as the probability of such a substantial overrun or underrun becomes apparent. Reasons for all overruns or underruns should be documented in the overrun/underrun log mentioned above when those overruns or underruns occur. An accumulation of overruns could result in a net overrun requiring justification and documentation to be included with a funds encumbrance request approved by the Comptroller's Office.

If funds are not approved/encumbered prior to overrunning the current contract amount on contracts greater than \$5 million, or the net overruns exceed the AUOA on contracts for \$5 million or less, then an after the fact memo to the Department's Comptroller from the Turnpike Executive Director or District/Assistant Secretary, as appropriate, will be required. The letter should request authorization for an after-the-fact funds approval detailing the situation, the cause of non-compliance, and the measures put into place to prevent a repeat occurrence of non-compliance.

NOTE: Any price adjustment for a significant change involving an increase in quantity to a Major Item of Work will apply only to that portion of the work in excess of one hundred twenty-five (125) percent of the original contract quantity for that item. In case of a decrease in the original contract quantity below seventy-five (75) percent of the original contract quantity, the price adjustment will apply to the actual amount of work performed. Such adjustments must be documented on a fully executed **Supplemental Agreement**.

(B) District Level Responsibilities

The District Federal Aid Coordinator will request federal funds approval by initiating a federal authorization request through the Federal Aid Management Office in the Office of Work Program. The **Authorization Request** must be in one of the following status states: Reviewed, Certified, Transmitted or Approved in order to encumber the funds through the Contract Funds Management system (CFM). The

CFM system will check Financial Management system (FM) daily to see if the authorization has been approved and if so, CFM will change the encumbrance to Status 10 (available for payment). Payments for contract overruns will not be made until the **Authorization Request** is approved by the Federal Highway Administration (FHWA). In order to ensure prompt payment on these projects, the Federal Aid Coordinator must be informed of the expected payout date. Function (work activity) code 240 must be used for monitoring and tracking expenditures related to overruns. Requests for additional funding must be based on an analysis of the project and calculated estimated overruns.

NOTE: When projects are authorized with Federal Funds, the District Federal Aid Coordinator must submit an **Authorization Request** for changes to the project costs. A justification for these changes must be given to the Federal Aid Coordinator for all adjustments to the initial authorization. The justification does not need to be in detail but should include all major pay items that are overrun, such as asphalt, etc., (not 20 pcs of guardrail, 60 lag bolts, 30 posts). However, an analysis of the contract and an explanation of the work or material required shall be included for anticipated future overruns. In some cases, a FHWA PODI may require more detailed information in order for the **Authorization Request** to be approved by FHWA. Failure to comply with this will prolong the process for obtaining approval from FHWA, and reimbursement for costs could be jeopardized.

7.3.6 Establishing Fair and Equitable Value for Significant Change

Resident Level Responsibilities

Additional work of the type for which a contract unit price is provided shall be paid at such contract unit price unless the additional work constitutes a significant change.

Additional work of the type for which no contract unit price is provided will be paid at negotiated prices or pursuant to **Standard Specification 4-3.2**. After notification has been given by the Construction Project Manager to the Engineer of Record or to the Design Project Manager, the Engineer of Record should be invited to participate in negotiations/determinations of prices for the added work if the cost of the work involves potential premium costs. The Construction Project Manager should not delay the contract administration process with the Contractor waiting on the Engineer of Record to participate.

The Engineer will typically attempt to negotiate with the Contractor, as outlined below, to resolve all outstanding issues, including time adjustments and attempt to reach an agreement on fair and equitable prices for a significant change.

For any contract change involving monetary compensation:

- (1) As soon as a need for additional work is established, the Resident Engineer's

Project team should prepare an **Entitlement Analysis** and an **Engineer's Estimate** (Refer to **Guidance Document 7-3-A**).

(2) The Resident Engineer's Project team should then begin negotiations for the work. The Resident Engineer's Project team shall make an appropriate revision to the amount of the **Engineer's Estimate** if new information is recognized, supported, and documented during negotiations (See **Guidance Document 7-3-A** for revision details). **NOTE:** Where the dispute has been considered by a Disputes Review Board (DRB) acting in accord with procedures established under the contract, the recommendations of the DRB should be given consideration in negotiations. However, the DRB recommendations are not binding on the Department or the Contractor and should be considered important, but not controlling, factors in negotiating revisions to the amount of the Engineer's Estimate.

(3) For additional assistance in valuing contract changes, the Office of Construction may be contacted in accordance with the District's guidelines on such contacts. The District Construction Engineer shall approve any request for review by Central Office staff. The District Construction Engineer will set the District's guidelines which establish when such contacts are appropriate.

The assistance of the Office of Construction may be requested by email from the DCE to the Director, Office of Construction.

(4) If the negotiations have not resulted in an agreement and the Department may be liable for delays, the Resident Engineer's Project team should then immediately request an encumbrance for the part of the total contract change costs estimated to be due to the Contractor. Certification of availability of funds must be obtained from the Comptroller's Office prior to directing the Contractor to perform the work when the change results in an increase in the cost of the project. Once the Comptroller's Office certifies the funds availability, the Resident Engineer's Project team should then direct the contractor to proceed with the work while continuing to negotiate a **Supplemental Agreement** to cover it until the work is completed or negotiations are terminated.

(5) If the work has been completed and Contractor and the Department still cannot agree on the compensation owed to the Contractor, then:

a. Where the Resident Engineer's Project team (or higher District management personnel, as determined by the District) determines that no further upward revision of the **Engineer's Estimate** is justified, then the Resident Engineer's Project team will attempt to negotiate a settlement at or below an amount considered reasonable to avoid delay to the project due to continued escalation. If the Contractor accepts the Department's offer, the individual authorizing that decision for the District will attach a signed and dated cover sheet to a package containing the most recently amended **Engineer's Estimate**. This cover sheet will be labeled **Negotiated Settlement amount**. The sheet will show only the increase in the amount paid to settle that is justified solely to avoid delay to the project by continued escalation. A **Supplemental Agreement** to settle the issue will then be prepared; or,

b. If the Contractor refuses to accept the maximum amount developed in the previous scenario; the Resident Engineer's Project team will prepare a **Unilateral Payment** to pay the Contractor the amount of the justified costs. The method to calculate these costs is stated in **Standard Specification 4-3** and the **Engineer's Estimate** and **Entitlement Analysis** must be adjusted accordingly. The methods of calculating any claims settlement costs beyond those developed under **Standard Specification 4-3** are covered in **Standard Specification 5-12**; and, regarding such costs, it should be noted that only delay costs will be considered. The Contractor will then be required to handle any further request for compensation as a claim in accordance with **Specification 5-12.3**. Refer to **CPAM Section 7.5**.

(6) Idle asphalt plants should only be compensable for delays if the plant is dedicated to the project. If the asphalt plant provides asphalt to multiple projects or sells commercially and not dedicated to the project, it would not be compensable for delays.

If a claim includes costs for a non-dedicated idle asphalt plant, the costs should be removed from the subject claim.

7.3.7 Determining and Documenting the Basis for Contract Time Adjustments

Resident Level Responsibilities

When the value of a contract is increased or decreased due to work added, work deleted, or a significant change, a statement of adjustment of contract time shall be included in the negotiations between the Department and the Contractor, and included in the **Supplemental Agreement or Unilateral Payment** documenting work added, work deleted, or a significant change (Refer to the **Guidance Document 7-3-A and 7-3-D** regarding additional contract time). Additional time should be commensurate with the estimated effects the changes will have on the critical path of work shown on the approved work schedule except when the approved work schedule is clearly not representative of actual project performance. When additional time is granted because critical path of work is delayed, the supporting documentation for the contract change shall list the critical path work delayed and number of non-overlapping delay days attributable to each.

When a **Unilateral Payment** is executed in lieu of a **Supplemental Agreement**, additional contract time will be determined by the Engineer based on the impact to controlling items of work shown on the approved work schedule except when the approved work schedule is clearly not representative of actual project performance. Any additional contract time due the Contractor for work paid by **Unilateral Payment** will be granted on the **Unilateral Payment** document. The **Unilateral Payment** document will include the reasons for all time extensions.

7.3.8 Obtaining Department Legal Approval

Resident Level Responsibilities

Section 334.185, F. S., requires the Department's legal staff to review and comment on all contracts prior to award, and on all proposed contractual changes, to determine the legal responsibility for construction, material, or design failures, and to advise on ways to minimize responsibility for such failures.

It is also important that close coordination between the construction staff and legal staff be maintained during the **Supplemental Agreement** negotiations process to ensure all applicable legal requirements are fulfilled and to obtain legal advice on matters related to contract disputes.

Each District will obtain legal review for **Supplemental Agreements** to construction contracts and **Unilateral Payments** from its respective District General Counsel prior to forwarding these documents to the Contractor for execution or notice respectively.

Space has been provided on the **Supplemental Agreement, Form No. 700-010-45** and the **Unilateral Payment, Form No. 700-010-05**, to document Department legal review. The **Supplemental Agreement** document shall be reviewed by a Department attorney to document legal review prior to forwarding the **Supplemental Agreement** to the Contractor for execution. Evidence of the legal review shall be retained in the **Supplemental Agreement** file as part of the backup documentation. Each **Unilateral Payment** shall be reviewed and signed by a Department attorney. A copy of any contract change document sent to the Contractor for execution shall be maintained in the project files until and unless it is superseded by a copy of the same contract change executed by the Contractor without alteration. Note that in case of a **Supplemental Agreement**, the Contractor will receive a fully executed copy only at the conclusion of the process. If a Contractor modifies a **Supplemental Agreement**, the **Supplemental Agreement** is to be revised with the new language that both parties agree to and the revised document is to be resubmitted to the Contractor for execution. **NOTE:** No **Supplemental Agreement** altered unilaterally by the contractor shall be accepted by the Department without the review and approval of the District Chief Counsel. Where paragraph 4 of the **Supplemental Agreement** has been altered, the review and approval of the Director, Office of Construction and the Office of General Counsel is also required before accepting the altered **Supplemental Agreement**.

7.3.9 Requesting Certification of Funds from the Department's Comptroller's Office

District Level Responsibilities

(1) The District budget/work program staff will review all funds requested, to determine that the work program can support the expenditures prior to transmitting the funds request back to the District Construction Engineer or designee. The Contract Funds Management

(CFM) will check the Financial Management system to verify that sufficient remaining authorization has been pulled before certifying availability of funds. The District Work Program Office must ensure the authorization has been approved. The authorization must be approved before work begins.

(2) For a **Supplemental Agreement**, the District Construction Engineer or designee must obtain funds approval through the CFM system prior to obtaining approval of the Secretary or designee on a draft copy of the **Supplemental Agreement** and prior to transmitting the **Supplemental Agreement** to the Contractor or giving the Contractor written notice to proceed with the work. For a **Unilateral Payment**, the District Construction Engineer or designee must obtain funds approval through the CFM system prior to obtaining the approval of the Secretary or designee on a draft copy of the **Unilateral Payment** and prior to giving the Contractor notice to proceed with work which will be documented and paid with a **Unilateral Payment**.

(3) The CFM system is located on the Comptroller's website. To obtain access to the CFM system, the requestor must have completed the training course for the CFM system provided by District/Central Train the Trainer personnel.

(4) When funds are encumbered for construction contract changes on separate projects within the same contract with different fund categories, these changes must be documented separately for each fund category. The District Construction Engineer or designee will request funds approval for the project whose number is indicated in the request for certification of availability of funds as designated by the District Operations staff.

(5) Funds certified for **Contingency Supplemental Agreements** and funds made available for **Work Orders** by Contingency Pay Items may only be used temporarily for **Unilateral Payments** if the conditions for that use set forth in the **CPAM Section on Contingency Supplemental Agreements** are met. (See **CPAM Section 7.4**).

(6) For **Supplemental Agreements** issued for unforeseen utility work during construction, the District Construction Engineer or designee must notify the District Office of Work Program (immediately, but no later than the business day following the identified need for such a **Supplemental Agreement**) requesting Local Funds for Unforeseen Work (LFU) funds be programmed to the project commensurate to the value of the **Supplemental Agreement**. This notification shall be made via e-mail, with copies to the Comptroller, Financial Development Office and Central Office Work Program. The e-mail notification shall include: Contract Number, Financial Project Number, **Supplemental Agreement** Number, Utility Agency/Owner and the amount of the **Supplemental Agreement**.

7.3.10 Obtaining Federal Highway Administration Approval and Participation for Construction Contract Changes on Federal Aid Projects

7.3.10.1 General

Federal Aid participation in all changes to Department Construction Contracts shall be determined as required by ***Federal Aid Policy Guide 23, CFR Section 635.120.***

The following project changes are a representative sample of Federal Aid Non-Participating work:

- (A) Spare parts turned over to the maintaining agency and not incorporated into the construction.
- (B) Material or equipment called for in the plans but not used in the construction.
- (C) Closed drainage systems on structures not justified in the environmental process.
- (D) Fishing Piers.
- (E) Drainage items, including water retention ponds, not supported through the environmental process.
- (F) Premium costs due to design or CEI errors or omissions.
- (G) Sole source items unless specifically approved by the Federal Highway Administration.
- (H) Construction changes for items that were set up as alternate bid items.
- (I) Repairing items that had not been properly maintained through regular maintenance (cleaning/desilting pipe, etc.)
- (J) Additional contract time and/or costs for utility or right of way delays beyond what was identified in the contract documents.
- (K) Additional contract time and/or costs to attain greater vertical or horizontal bridge clearance than deemed necessary to fulfill the intent of the original project documents.
- (L) Additional contract time and/or costs due to arbitrary one foot or less backwater criteria in construction or reconstruction of Interstate Highway Bridges.
- (M) MOT items for Federal Aid Non-participating time extensions.
- (N) Work resulting from insufficient subsoil investigation.

- (O) Claim Settlement Costs paid solely to avoid the risk associated with failing to settle the claim as defined in **CPAM Section 7.3.4**.
- (P) Repair or replacing existing and installed items due to 3rd party damages or theft.
- (Q) Regular maintenance items such as mowing and litter removal
- (R) Adjustment of private facilities (ie: signs, fences, irrigation) unless covered as a part of a right-of-way agreement or permit
- (S) Material cost escalations due to tariffs or supply shortages not identified in the original contract
- (T) Impacts due to the improper storage of stockpiled materials
- (U) Use of state-furnished materials (unless approved by a public interest finding)
- (V) Theft of existing or installed materials or equipment.

7.3.10.2 FHWA Projects of Division Interest

Resident Level Responsibilities

The Resident Engineer on In-house CEI projects and the Department's Construction Project Manager on Consultant CEI projects shall solicit FHWA approval of and participation of construction contract changes as specifically identified for approval on FHWA Projects of Division Involvement (PODI). Federal-Aid participation shall be documented on the **FHWA Approval - Major and Minor Construction Changes, Form No. 700-010-47**, FHWA refusal to participate in any construction contract change should be followed-up with an additional attempt to obtain Federal Aid participation by supplying all necessary additional information or explanations. The Resident Engineer on In-house CEI projects and the Department's Construction Project Manager on Consultant CEI projects should solicit the reason for any FHWA refusal to participate in any construction contract change. Such reason for non-participation shall be noted in the **FHWA Approval - Major and Minor Construction Changes** form or attachment thereto. Should FHWA refuse to supply a reason, such refusal should also be noted in the document or on the attachment as part of the pertinent information included in the complete contract change package.

- (1) **Major Changes** - All major changes in the plans and specifications must be approved in writing by FHWA on the **FHWA Approval - Major and Minor Construction Changes** form prior to approval of the changes by the Secretary or

designee prior to giving the Contractor written notice to proceed with work. When emergency or unusual conditions exist, FHWA may give tentative prior approval verbally and ratify such approval in writing as soon thereafter as practical.

Major changes include the following:

- Revisions of geometric design (main roadway, ramps, frontage roads, or crossroads) including any project and construction limit extensions.

(NOTE: Project and Construction Limit Extension approval requests must be forwarded through the State Construction Office in accord with *CPAM Section 7.3.5.2*).

- Revisions of pavement structural sections.
- Revisions in conflict with standards.
- Revisions, additions, deletions, or relocation of structures.
- Any changes in the plan access control.
- Any changes that alter specifications, special provisions or other contract requirements, including previously approved provisions.
- Any changes in material type or quality.
- The grant of any additional contract time in a ***Supplemental Agreement***.
- Any time extensions.
- Any adjustments to the contract made by the engineer because of a significant change when acceptable prices cannot be obtained through negotiations.
- Contract claim settlements.
- ***Supplemental Agreements and Unilateral Payments*** that total \$50,000.00 or more, or five (5) percent or more of the original total contract amount, whichever is less.
- Substantial overruns or underruns.

FHWA prior written approval for all major changes in the plans and contract provisions shall be documented on the ***FHWA Approval - Major and Minor Construction Changes*** form. FHWA may give tentative prior verbal or emailed

approval for major changes, when justified by emergency or unusual conditions. When this occurs, it shall be documented on the ***FHWA Approval - Major and Minor Construction Changes*** form. The document should note who granted the verbal/emailed approval, the date granted, and who received the verbal/emailed approval before submitting that document for FHWA written approval. That document shall be submitted for FHWA written approval as soon as practical following receipt of verbal approval.

A copy of all pertinent information justifying the request for FHWA approval and participation must be included with the document prepared for FHWA approval. Such information shall include, but not be limited to:

- The reasons for quantity overruns and underruns.
- The ***Entitlement Analysis***, the ***Engineer's Estimate*** and, where claim settlement costs have been incurred, a ***Statement of Claim Settlement Cost*** (see ***CPAM Section 7.5.3*** for a description of that statement).
- Documentation of concurrence from the Director, Office of Construction for all changes to contract specifications and extensions of the project and construction limits.
- All related correspondence that may be pertinent to FHWA concerns.

- (2) **Minor Changes** - All minor changes in the plans and specifications shall be approved in writing by FHWA retroactively. All project changes other than major changes shall be classified as minor changes.

FHWA retroactive written approval for all minor changes shall be documented on ***FHWA Approval - Major and Minor Construction Changes, Form No. 700-010-47***. FHWA may elect to approve minor changes by having the document sent to them for signature or by signing the document at the time of a routine field visit.

A copy of all pertinent information justifying the request for FHWA approval and participation must be included with the document prepared for FHWA approval. Such information shall include, but not be limited to, the basis for determining the need for the changes, the ***Engineer's Estimate***, and the ***Entitlement Analysis***, the basis for determining changes to contract time, and all related correspondence which may be pertinent to FHWA concerns.

- (3) **Minor Overruns or Underruns** - Minor overruns or underruns will not require prior FHWA approval. Such overruns or underruns will be reviewed for approval by FHWA in its review of the project final estimate.

7.3.10.3 District Oversight (Delegated) Projects

(5) Neither FHWA approval nor Director, Office of Construction concurrence in Federal Aid participation is required on Delegated Projects. However, major changes may require additional reviews and approvals from FHWA, the Chief Engineer and the Office of Environmental Management based on the nature and scope of the change. Coordinate with the District PLEMO, District Interchange Review Coordinator and District Access Management Coordinator.

(A) Resident Level Responsibilities

The Resident Engineer's staff shall develop the contract change document, submit the document to the District Construction Engineer for review and solicit a determination of FHWA participation before any payment is made on the contract change or any item included in the contract change.

(B) District Level Responsibilities

The District Construction Engineer shall determine the Federal Aid participation in accordance with the guidelines shown in ***CPAM Section 7.3.10.1 or in consultation with the FHWA District Transportation Engineer (when necessary)***. The District Construction Engineer can delegate such approval authority, in writing, to a person within the District Construction Office staff, but not to a Resident Engineer. Such delegation shall be maintained on file in the District Construction Office. Approval shall be documented in writing showing the amount of federal aid participation for all pay items included in the contract change and must be signed and dated by the District Construction Engineer or delegate and included in the project file for that contract change. An email from the District Construction Engineer or delegate will suffice as documentation of approval.

7.3.11 Documenting and Approving the Work; Issuing the Notice to Proceed with the Work

Resident Level Responsibilities

The District Construction Engineer or designee must obtain funds approval through the Contract Funds Management System (CFM) prior to the Secretary or designee approving the work on ***Supplemental Agreement, Form No. 700-010-45***, and before giving the Contractor written notice to proceed with the work.

If the Department and the Contractor agree on the need for and cost of the work, the Engineer shall accomplish the following before authorizing the Contractor to proceed with the work:

(1) Prepare an ***Engineer's Estimate, Entitlement Analysis*** and a draft copy of the

Supplemental Agreement form used for approval of form and language.

(2) Ensure that the District Construction Engineer or designee has obtained a certification of the availability of the required funds from the CFM System (see **CPAM Section 7.3.10**).

If the Department and the Contractor cannot agree on the cost and or time allowed for some of the work, then the terms of the **Supplemental Agreement** may be changed by adding an exception to paragraph (4) of the document that reserves the right of the Contractor to dispute only that portion of the costs and or time on which the Department and the Contractor cannot agree. Such modifications shall only be made with the assistance and approval of the District Legal Counsel, the Director, Office of Construction and the Office of General Counsel. The District Construction Staff shall obtain the approval of the District Legal Counsel for such modifications before forwarding for the Director, Office of Construction's and the Office of General Counsel approval. When such modifications are initiated by the Department, the approval of the District Legal Counsel, the Director, Office of Construction and the Office of General Counsel shall be obtained before forwarding the **Supplemental Agreement** to the Contractor for signature. When such modifications are made unilaterally by the Contractor to the signed copy the Contractor returns to the Department, the approval of the District Legal Counsel and the Director, Office of Construction shall be obtained before returning a fully executed copy of the **Supplemental Agreement** to the Contractor.

If the Department and the Contractor cannot agree on the terms of a **Supplemental Agreement**, or the Contractor fails to timely execute **Supplemental Agreement, Form No. 700-010-45**, the Department has unilateral authority to pay the Contractor the sums the Department determines to be due the Contractor for work performed on a project. The Department shall make a **Unilateral Payment** considered fair and equitable by the Department for work ordered and documented by the Department on the **Entitlement Analysis** and **Engineer's Estimate**. Such payment shall be made by executing **Unilateral Payment, Form 700-010-05**, in lieu of the **Supplemental Agreement** document. All other requirements of this section will apply.

If the Department and the Contractor cannot agree on the cost of the work, and the Contractor has stated his refusal to execute any **Supplemental Agreement** for the issue, then a **Supplemental Agreement** need not be prepared. The Engineer will document the Contractor's refusal to execute a **Supplemental Agreement**. A **Unilateral Payment** may be used to pay the Contractor the sums the Department determines to be due the Contractor for work performed. For a **Unilateral Payment**, the District Construction Engineer or designee must obtain funds approval from the CFM System and the Secretary or designee must approve the work prior to giving the Contractor notice to proceed with work that will be documented and paid with a **Unilateral Payment**.

Such unilateral authority for the Department to pay the Contractor does not preclude or limit the rights of the Department or the Contractor to negotiate and agree on the cost of the work. By acceptance of any such **Unilateral Payment**, the Contractor does not waive

any rights for payment by the Department for additional sums that the Contractor claims are due for the work.

Notice to proceed with work to be documented with a **Supplemental Agreement** or **Unilateral Payment** may be issued by the Resident Engineer after sufficient funds have been encumbered and the work has been tentatively approved by the Secretary or designee.

After issuing the notice to proceed, the Engineer shall ensure timely preparation of the **Supplemental Agreement**, since the Contractor cannot be paid for the work until the **Supplemental Agreement** document has been completely executed.

A **Unilateral Payment** document shall be timely prepared and executed by the Department and presented to the Contractor when required. Payment will be made based on a **Unilateral Payment** document only after completion of the work described therein to the satisfaction of the Engineer.

7.3.12 Forms and Guidance Documents

The following forms are available on the Office of Forms and Procedures Web sites:

Contract Funds Management Access Request:
<http://fdotsp.dot.state.fl.us/sites/OOC/CFM/Shared Documents/CFM Access.docx>

Supplemental Agreement, Form No. 700-010-45. Execution of contract changes by both the Contractor and the Secretary or designee.

Unilateral Payment, Form No. 700-010-05. Unilateral execution of contract changes by the Secretary or designee.

FHWA Approval - Major and Minor Construction Changes, Form No. 700-010-47. FHWA approval of construction changes and approval for Federal Aid participation on FHWA Projects of Division Interest.

The following guidance documents are available at the end of this section:

Guidance Document 7-3-A Documenting the “Engineer’s Estimate”, the “Basis for Estimate”, and the “Entitlement Analysis” for a Contract Change Impacts.

Guidance Document 7-3-B Sample - Transmittal Letter for Unilateral Payment.
Guidance Document 7-3-C, Examples of Premium Cost Determinations.

7.3.13 Executing and Processing Supplemental Agreement and Unilateral Payment Documents

District Level Responsibilities

(1) A **Supplemental Agreement** or **Unilateral Payment** must not be dated prior to the date of certification of availability of funds by the Comptroller's office.

Supplemental Agreements and **Unilateral Payments** shall be dated and effective on the same date as the date of Execution by the Department.

Supplemental Agreements and **Unilateral Payments** will incorporate the same numbering system used for the PrC program contract modification number. No **Unilateral Payment** shall have the same number as a **Supplemental Agreement** or a **Contingency Supplemental Agreement** to that contract.

(2) Only the Secretary of Transportation can delegate authority for approval and execution of **Supplemental Agreements** and **Unilateral Payments**. That authority is delegated as follows:

a. For contract changes up to \$150,000, all **Supplemental Agreement** and **Unilateral Payment documents** shall be approved by the Resident Engineer and shall be executed by the District Construction Engineer;

b. For contract changes more than \$150,000 and up to \$500,000, all **Supplemental Agreement and Unilateral Payment** documents shall be approved and executed by the District Construction Engineer, (and include FHWA approval if identified as a PODI approval action) and a Special Counsel for Construction in Central Office; and

c. For contract changes more than \$500,000.00 and up to \$1,000,000, all **Supplemental Agreement** and **Unilateral Payment** documents shall be approved and executed by the District Director of Transportation Operations (and include FHWA approval if identified as a PODI approval action) except as follows, the District Construction Engineer may execute the **Supplemental Agreement** and **Unilateral Payment** documents after the District Director of Transportation Operations has approved a draft copy of that **Supplemental Agreement** or **Unilateral Payment** showing the language and terms being used. A copy of that **Supplemental Agreement** or **Unilateral Payment** shall be sent to the Director, Office of Construction; and

d. For contract changes more than \$1,000,000, all **Supplemental Agreement** and **Unilateral Payment** documents shall be approved and executed by the District Director of Transportation Operations (and include FHWA approval if identified as a PODI approval action), except as follows, the District Construction Engineer may execute these **Supplemental Agreement** and **Unilateral Payment** documents after the District Director

of Transportation Operations has approved a draft copy of that **Supplemental Agreement** or **Unilateral Payment** showing the language and terms to be used. For contract changes more than \$1,000,000.00, the District Construction Engineer or District Director of Transportation Operations, as appropriate, may execute these documents after the Director, Office of Construction has approved a draft copy of the document showing the language and terms to be used. Director, Office of Construction approval may be obtained via email provided all electronic correspondence documenting said approval is maintained in the contract change file.

In all cases of Supplemental Agreement and Unilateral Payment documents greater than \$150,000, review and execution by a Special Counsel for Construction in Central Office is required.

The above limits apply regardless of whether the amount is an increase or decrease to the contract.

Payment will be made on **Unilateral Payment** documents only after the work has been completed to the satisfaction of the Engineer.

In the event that an agreement with the Contractor is concluded after a **Unilateral Payment** has been executed and processed for that work, a standard **Supplemental Agreement** will be executed to document any additional reconciliation required. A **Work Order** shall not be used for this purpose.

NOTE: The **Unilateral Payment** document will not be rescinded.

- (3) All original **Supplemental Agreement** documents must be executed based on the appropriate organizational structure below.
 - a. Execution by the Contractor
 - Corporation

Must be executed by the President or Vice President or, if executed by another person, must include a certified copy of that person's authority to bind the Corporation. When the **Supplemental Agreement** is not executed by either the President or Vice President, then a Corporate Resolution which designates those individuals who have authority to legally bind the Corporation should be obtained.

The Seal of the Corporation must be affixed for a wet ink signature.

The above signature must be attested by the Secretary of the Corporation (or an Assistant Secretary) for a wet ink signature.

- Partnership

Must be executed by a person with authority to bind the company and must include a certified copy of that person's authority to bind the company. The signature must be witnessed by two persons for a wet ink signature.

- Joint Venture

Must be executed by the attorney-in-fact currently on file with the Department.

- Manager-Managed Limited Liability Company (LLC)

Must be executed by a managing member of the LLC or, if executed by another person, must include a certified copy of that person's authority to bind the Company.

The above signature must be attested by managing member of the LLC for a wet ink signature.

- Member-Managed Limited Liability Company

Must be executed by a majority-in-interest of the members of the LLC or, if executed by another person, must include a certified copy of that person's authority to bind the Company.

The above signature must be attested by managing member of the LLC for a wet ink signature.

b. Execution by the Surety (only required when the cumulative value of all contract changes on this contract will exceed 25% of the original contract amount as a result of this contract change.)

- The Seal of the Surety must be affixed.
- If the attorney-in-fact for the Surety is not a Florida Resident Agent, the document must be counter signed by a Florida Resident Agent.
- The Surety's attorney-in-fact and Florida Resident Agent must attach their **Power of Attorney**, which must be original, or be certified by manual signature, unless an original signature is on file with the Department, or unless evidence is furnished that the Surety has authorized the use of facsimile signatures.
- The **Power of Attorney** must not contain a limit less than the total contract amount including the amount increased by all contract changes. The **Power of Attorney** must be certified as valid as of the date the Agent

executes the **Supplemental Agreement**.

(4) All **Supplemental Agreement** documents are to be processed within the following timeframes:

- Thirty (30) days are allowed from the day the negotiations with the Contractor are finalized until the **Supplemental Agreement** is mailed to the Contractor for execution.
- Ten (10) days are allowed for the Contractor to receive, execute, and return the **Supplemental Agreement** to the Department.
- Five (5) days are allowed after receipt for the Department to execute the **Supplemental Agreement** and enter document information into the Contract Change Tracking System and CES/TRNS*PORT program.
- After entry of document information into the CES/TRNS*PORT program and receipt by the Comptroller's Office of a progress estimate showing completed work, the Comptroller's Office will make payment for that work on the progress estimate.

7.3.14 Obtaining a Revised Project Schedule

Resident Level Responsibilities

A revised project schedule should be requested at the time the Contractor executes a **Supplemental Agreement** or the Engineer grants additional contract time by **Unilateral Payment** if the contract has an original contract time of ninety (90) days or more, and the time granted is fifteen (15) days or more. The contract duration, the amount of time granted, the status of work progress, and any special circumstances that may exist will also indicate the appropriateness of requesting a revised schedule. When additional time is granted and a revised schedule is not requested, the basis for that decision must be documented in the project files by the Resident Engineer.

When additional time is granted, back-up documentation for the contract change shall list the controlling items of work delayed and number of non-overlapping delay days attributable to each item.

7.3.15 Distributing Executed Supplemental Agreement and Unilateral Payment Documents

District Level Responsibilities

After final execution, the District Construction staff will distribute copies of the **Supplemental Agreement, Form No. 700-010-45** or **Unilateral Payment, Form No.**

700-010-05 to:

- **Comptroller's Office *** - One copy.
- **District Construction Engineer *** - One original of each with all attachments including a copy of all plan sheets revised by the **Supplemental Agreement** or **Unilateral Payment** and, where applicable copies of the **FHWA Approval - Major and Minor Construction Changes, Form No. 700-010-47** and the **State Construction Concurrence, Form No. 700-010-43**.
- **Contractor** - One original of the **Supplemental Agreement or Unilateral Payment** and a copy of all plan sheets revised by the **Supplemental Agreement or Unilateral Payment**.
- **Director, Office of Construction *** - (ONLY on projects with an original contract amount exceeding \$10 million.) One copy of each with all attachments including, where applicable copies of the **FHWA Approval - Major and Minor Construction Changes, Form No. 700-010-47** and the Director, Office of Construction, **State Construction Concurrence, Form No. 700-010-43**. Distribution will be made to the Director, Office of Construction prior to submitting an estimate for payment of the work.
- **Resident Engineer *** - One copy of each with all attachments including a copy of all plan sheets revised by the **Supplemental Agreement** or **Unilateral Payment** and, where applicable, copies of the **FHWA Approval - Major and Minor Construction Changes Form** and the Director, Office of Construction, **State Construction Concurrence, Form No. 700-010-43**.
- **State Materials Office *** - One copy of the **Supplemental Agreement or Unilateral Payment** (Only on contracts where the State Materials Office is providing the materials certification).
- **District Materials Office *** - One copy of the **Supplemental Agreement** or **Unilateral Payment** (Only on contracts where the District Materials Office is providing the materials certification).
- **District Director for Production *** (at the discretion of the District) - One copy of the **Supplemental Agreement or Unilateral Payment**.
- **Design Project Manager *** - Responsible for managing the Design Consultant on contracts with consultant-prepared contract documents - One copy of the **Supplemental Agreement or Unilateral Payment** document.
- **Surety** - One copy of the Unilateral Payment document. (Only required

when the cumulative value of all contract changes on this contract will exceed twenty five (25) percent of the original contract amount as a result of this contract change.)

* **NOTE:** Distribution to this party should be made by either sending an electronic copy of the documentation or by sending the Electronic Document Management System Document Number via email.

A copy of all pertinent information must be attached to the **Supplemental Agreement or Unilateral Payment** documents distributed to the Director, Office of Construction, the District Construction Engineer and the Resident Engineer. The attachments mentioned in this section include but are not limited to:

- The **Entitlement Analysis**, the **Engineer's Estimate** and, if there are claim settlement costs paid solely to avoid the risk of failing to resolve the disputed issues, the **Statement of Claim Settlement Costs**.
- The reasons for any quantity overruns or underruns and extra work.
- Documentation of the Contractor's refusal to execute a **Supplemental Agreement** where this occurs.
- Documentation of concurrence from the Director, Office of Construction for all changes to contract specifications and extensions of the project and construction limits.

7.3.16 Contract Change Tracking

District Level Responsibilities

Within fifteen (15) calendar days after payment on an approved estimate of all or a portion of the work identified within the **Supplemental Agreement or Unilateral Payment**, the District Construction Engineer or designee shall decide upon the final contract change coding and enter the **Supplemental Agreement or Unilateral Payment** information into the **Contract Change Tracking System** and **PrC**. If the DCE's designee is not a member of the District Construction office staff, the DCE's delegation shall be maintained on file in the District Construction office. Further, if the DCE's designee is not a member of the District Construction office staff the DCE shall develop a quality assurance process to ensure accurate contract change coding and compliance with this section. Such process shall be documented and maintained on file in the District Construction office.

For an explanation of the codes involved, see the information published under "Coding Contract Changes" heading as an attachment to this section on the State Construction Office website at : cpam-7-3-attachment-coding-contract-changes-attach-for-sect-7-3-2022-prc.pdf (windows.net)

7.3.17 Quality Control Process for Contract Changes

District Level Responsibilities

The District Construction Engineer shall develop a process to annually review a representative sample of all contract changes to ensure such changes were necessary and comply with the construction contract documents. Such process and reviews will be documented and kept on file in each District for State Construction Office and FHWA review.

Guidance Document 7-3-A

Documenting the "Engineer's Estimate," the "Basis for Estimate," and the "Entitlement Analysis" for a Contract Change

Documenting the Engineer's Estimate:

The **Engineer's Estimate** serves two purposes. First it is an independent estimate of the additional cost and time prepared by the CEI staff for each contract change. Second, it documents the final disposition of each contract change after completion of any negotiations. The following documents should be included in the documentation:

- Basis for Estimate
- Engineer's Estimate
- Contractor's Quote
- Final Disposition

Basis for Estimate:

The Basis for Estimate is a statement explaining the methods used to compute estimated costs and time associated with a contract change.

A Basis for Estimate could be but is not limited to:

- Review of historical bid prices.
- Review of area and/or regional averages.
- Review of recent winning bids on a Department contract.
- Overrun at a unit price included in the original contract.
- The documented actual costs of the Contractor.
- Using the resource approach, a detailed estimate of the quantities and unit costs of the manpower, material and equipment resources required.

Estimate:

The estimate is the cost and time estimate as determined from the above method.

If the resource approach is used, the estimated cost impacts should be based on the costs of equipment, labor, material and supplies anticipated, as well as, General Liability Insurance and Bond, subcontracted work and mark-ups for each shown in **Standard**

Specifications, Section 4-3. Note that the work associated with contract changes is occasionally complete before settlement is reached. When this happens then no estimate is prepared.

If the estimate includes contract time impacts, the time estimate should be commensurate with the estimated effects the changes have on the controlling items of work shown on the approved work schedule except when the approved work schedule is clearly not representative of actual project performance.

The **Engineer's Estimate**, including the attached basis, should be labeled **Engineer's Estimate** and must be signed and dated by the Engineer producing the estimate. The **Engineer's Estimate** may subsequently be amended by adding a cover sheet to the original estimate. The cover sheet must state the new justifiable amount of contract days and/or dollars for one or more of the issues covered in the estimate and the reason for each such change. This amendment should be labeled Amendment to **Engineer's Estimate** and it should be signed and dated by the Department's Engineer producing the amended estimate. An **Engineer's Estimate** should be prepared prior to the Engineer receiving the contractor's price proposal for work.

Contractor's Quote:

This is the contractor's proposal of additional costs and time for the contract change.

Final Disposition:

Once the Estimate and Contractor's quote are compared by the CEI, and negotiations are completed, the CEI will prepare a listing of agreed costs/time and a statement to explain how the final costs and time due were determined.

Examples:

- Contractor agreed to costs/time proposed by the Department.
- After negotiations the Department agreed to accept the contractor's price/time OR agreed to accept a price/time above the Engineer Estimate in order avoid delay or further cost/time impact to the project.
- Department agreed to pay for change based on actual costs.

Documenting the Entitlement Analysis:

In the **Entitlement Analysis**, the preparer should mention each of the contract change issues as follows. For each issue, state description and reason for each change. A copy of project correspondence must be attached to and made a part of the **Entitlement Analysis**. This can be an email from the Engineer of Record as an example. The **Entitlement Analysis** should be signed and dated by the Engineer producing it.

Dispute Review Board Recommendations:

Where a Dispute Review Board (DRB) has considered a dispute and has made recommendations, the recommendations should ALWAYS be included in the required documentation for that contract change.

The impact of the DRB's recommendation on Entitlement should be discussed in and made a part of the **Entitlement Analysis** only when the Department's engineer feels the DRB recommendation contains sufficient new information to change his or her previous decision on the degree (percentage amount) of the Contractor's entitlement to recover the total reasonable quantity of additional compensation and contract time associated with the dispute.

The impact of the DRB's recommendation on Entitlement or Quantum should be discussed in and made a part of the Engineer's Estimate only when the Department's Engineer feels the DRB recommendation contain sufficient new information to change his or her previous decision on the total reasonable quantity of additional compensation and contract time associated with the dispute.

Where the Department accepts the DRB's ruling and the quantity of additional compensation and contract time associated with the dispute exceeds the amounts of the most recently updated **Engineer's Estimate** and **Entitlement Analysis**, then the DRB's recommendation should be used as justification for and made a part of the **Statement of Claim Settlement Costs** (see **CPAM Section 7.5.3**).

Guidance Document 7-3-B Sample - Transmittal Letter for Unilateral Payment

(Date)

(Contractor's Name)

(Contractor's Address)

Re: Fin. Proj. ID. _____
Contract No. _____
FAP No.: _____
County _____

UNILATERAL PAYMENT AMOUNT \$ _____

Enclosed please find a copy of a ***Unilateral Payment*** document which has been duly executed by the Department in accordance with ***Section 337.11(11), Florida Statutes***.

The Department has determined that you, as Contractor, are entitled to payment for the work described in that ***Unilateral Payment*** document in the amount set forth in that document.

The funds have been approved for payment and you, as Contractor, should expect to receive payment for the items described in that ***Unilateral Payment*** document in the near future.

By acceptance of the payment you, as Contractor, do not waive any rights you may have against the Department for payment of any additional sums you claim may be due for the work described in that ***Unilateral Payment*** document.

Sincerely,

(Engineer)

Guidance Document 7-3-C Premium Costs Determinations

Premium Costs are defined as dollar amounts paid to a Contractor for non-value added work. Delays, inefficiencies, rework, or extra work as shown below other than those caused by the Contractor and/or his subcontractors or suppliers will be considered as non-value added work. Non-value added work can occur in three distinct situations:

1. Work delays or inefficiencies. In this situation, premium costs are the total delay/inefficiency damages paid to the Contractor.
2. Rework. Premium costs are the dollar amount of the original items of work that have to be removed and the costs to remove these items.
3. Extra work. In this situation, premium costs are computed as the net difference between the final agreed prices paid to the Contractor and the ***Engineer's Estimate***.

NOTE:

- All extra work does not necessarily result in premium costs.
- All extra work that is determined to be the result of design errors or omissions does not necessarily result in premium costs.
- Contract increases due strictly to overruns of contract pay items are not premium costs, unless those contract pay item overruns are associated with re-work.
- Premium vs. Non-premium is not determined by whether the plans were designed by a production Consultant.
- Premium costs are strictly a numerical calculation: the difference between the amount paid vs. what we should have paid.

Premium Cost associated with issues determined to have the following Avoidability Codes shall also be coded with Cost Recovery Code R – Action Recommended:

- Avoidable: Production Consultant
- Avoidable: Consultant CEI
- Avoidable: 3rd Party

The following are examples of premium cost determinations.

Work Delay or inefficiency

Example 1:

During construction of a roadway widening project, it was discovered that the planned surcharge would affect an existing buried fiber optic line that was not scheduled to be relocated. The impact to the fiber optic line was that it would not be able to withstand the planned settlements due to the surcharge. The Department delayed the Contractor's work in this area to allow the utility owner to relocate its fiber optic cable. The Contractor was able to mitigate the majority of the delay by working in other areas and on other

phases of work. Submitted extra costs for delays and inefficiencies agreed to by the Department for this issue was 100% premium cost.

Example 2:

A Contractor submits a claim for delays and inefficiencies on a project. The Department disputes the claims entitlement but settles the issue to avoid future litigation. Settlement costs paid for this issued would be 100% premium cost.

Example 3:

A Contractor submits a claim for delays and inefficiencies on a project. The Department disputes the claims entitlement so the Contractor takes the matter to a DRB. The DRB rules entitlement and quantum for the issue. The Department accepts the ruling and pays the quantum. Quantum for this issue would be 100% premium cost.

Example 4:

A Contractor mobilized to a project to begin test pile driving. It was then discovered that an existing utility cable, that according to the Utility relocation schedule should have been relocated, was still active. The Contractor had to stop all work on this critical path activity in this area until the new line was installed and the old line abandoned. All costs associated with this delay (overhead, idled equipment and labor, any demobilization or remobilization) are premium costs. Cost recovery from the utility company should be recommended.

Rework

Example 1:

The Contractor built driveway as identified in plans. The Department directed the Contractor to remove that driveway and place it at a different location due to agreement with local owner. Payment was handled as an overrun to existing pay items. The cost of the original driveway and it's removal is 100% premium cost.

NOTE: Any time any existing pay item is paid as an overrun to compensate a Contractor for rework, the cost of the original work is now non-value added and must be accounted for as premium cost.

Example 2:

The Department directs the Contractor to remove some installed 30" RCP and replace it with 36" RCP. Since contract did not include pay item for 36" RCP, a **Supplemental Agreement** was required. The cost of removal of 30" RCP, the cost of the installed 30" RCP that was removed, and the cost difference of 36" RCP over what would have been considered a reasonable bid price are 100% premium costs.

Extra Work

EXAMPLE 1:

On a Lump Sum milling & resurfacing construction project let in January 2008, the Department discovers in January 2009 that an error has been made by the Engineer of Record. The EOR has omitted a turn lane from the construction plans which was identified as required when the project was in the early design stages. The Contractor has completed all paving operations except for the Friction Course. The District decides to proceed with adding that turn lane to the project. The Engineer has determined that this issue qualifies as a “significant change” as defined in Standard Specification 4-3.1 due to a change in the character of the work. The Contractor submits a price to the Department for mobilizing of grading equipment, excavation, stabilization, base, additional asphalt costs due to pricing increases above the 2008 bid prices, overhead and additional time to perform the work. The Contractor’s price is reviewed and accepted by the Department. The premium costs associated with this issue would be:

- Price difference between asphalt quoted in the 2008 bid vs. the pricing quoted when the work is added in 2009
- Mobilization of grading equipment
- Overhead costs associated with added time to complete turn lane

Example 2:

On a Pay Item reconstruction construction project let in January 2008, the Department elects to add a turn lane to the project in January 2009. The Contractor has completed all grading and paving operations except for Friction Course. The Engineer has determined that this issue does not qualify as a “significant change” as defined in Standard Specification 4-3.1 due to the fact that there is no change in the character of the work nor do any of the work items associated with this change meet the definition of a “Major Item of Work” which will be increased by 125% or decreased below 75% of the original Contract quantity. The Contractor submits a price to the Department for remobilizing of grading equipment, overrun of existing items for: excavation- stabilization-base, additional asphalt costs due to pricing increases above the 2007 bid prices, overhead and additional time to perform the work. The Contractor’s price is reviewed and accepted by the Department with the exception of the asphalt price increases. The premium costs associated with this issue would be:

- Remobilization of grading equipment
- Overhead costs associated with added time to complete turn lane

Example 3:

A utility conflict was discovered with a proposed drainage installation. The Contractor has

to stop, move to another location until further direction given. The direction given is to construct a conflict manhole. Premium will be the contractor's labor/equipment costs to stop and move, costs to move back to the original site, and the cost differential between conflict manhole as agreed to and the price if in the original contract.

Example 4:

After drainage work was completed, a low spot is discovered that requires another inlet and pipe to correct the situation. In discussing this with the Engineer of Record it's discovered that the Department furnished the survey for the project. The project included the inlet and pipe items needed to do the work, but the contractor would not accept these costs because the extra work was an isolated condition, the drainage was sub-contracted work and the subcontractor was off the project. Premium costs would be the costs for subcontractor to re-mobilize, demobilize, and the cost differential between the inlet and pipe prices agreed to and the bid unit prices. Note: In order for the Department to accept the contractor position, the Engineer must determine that this represents a significant change per Standard Specification 4-3.1 and there is justification for not overrunning the inlet and pipe pay items.

Guidance Document 7-3-D Contract Time Adjustments

The contractor is required to submit and maintain a project schedule that details the timing for controlling items of work or critical path activities from start to finish of the project. The schedule should depict the planned operation by day or week and the operation may take the form of a critical path. A review of the critical path activity can identify the impacts to controlling items of work or critical path activities.

If work covered by a contract change affects controlling items of work or critical path activities, a change in the contract time may be warranted. If the controlling items of work or critical path activities are unaffected, a change in contract time is not warranted.

Occasionally, there are events that are beyond the control of the contractor which affect either controlling items of work or critical path activities and are acceptable to support an extension of contract time (i.e. hurricanes). But there are events that are normally considered to be under control of the contractor which do not warrant a time extension (i.e. plant breakdown, suspensions for violation of safety or environmental regulations)

Contract time granted

The contractor encountered existing drainage structures during the removal of a 48" pipe across a road. Due to the nature of the work specified, this additional structure removal required the use of additional equipment not anticipated and additional man hours not originally accounted for. As a result, two additional days were granted due to the impact on production to this controlling work item or critical path activity. An Engineer's Estimate was prepared detailing the additional equipment and man hours required to complete this work and an analysis for additional granted time was attached to the Supplemental Agreement as back up showing the impacts to this controlling item of work or critical path activity.

Contract time not granted

The contractor submitted a request for time delays associated with a changed condition based on the soil that was available from the ponds. The type of soil material resulted in additional effort to dry the soil before use. The contractor contends this resulted in 17 delay days in drying the material thereby delaying completion of the project. The Department performed its own independent analysis and reviewed the delays requested during the time frame and the weather days granted to insure there was no overlap. The Department determined no controlling items of work or critical path activities were affected by this alleged delay and the end date of the project was not impacted. As a result, no time was granted to the contractor.

Concurrent delays resulting in contract time granted

The contractor submitted a request for time delays associated with paving the roadway due to the revisions needed to the maintenance of traffic contract plans. The contractor is requesting a 3 day time extension. The Department performed an independent evaluation of the impact and determined the controlling items of work or critical path activities were affected in waiting to obtain the revised maintenance of traffic plans. However, it was learned that contractor's asphalt plant was broke down for 5 days during this 3 day time extension request and the contractor was unable to produce asphalt during these 5 days. Per **Specification 4-3.2.1**, the contractor shall be entitled to a time extension for each day that a controlling work item is delayed by the Department, but shall have no right to nor receive any monetary compensation for any indirect costs for any days of concurrent delay. As a result, the contractor is entitled to three non-compensable days.

State Construction Office
Dan Hurtado, Director, Office of Construction
CODING CONTRACT CHANGES
Effective September 16, 2014

Including Root Cause Codes, Avoidability Codes, Cost Recovery Codes, Premium
Costs and Claim Settlement Costs with Examples

The last pages of this memo contain the list of the codes which must be used in the Contract Change Tracking Systems to classify the Root Cause, Avoidability, Cost Recovery or Claim/Extend Limits disposition of Contract Changes as documented in Supplemental Agreements, Unilateral Payment Documents, Work Orders and Time Extensions. Note that Premium Cost values must also be evaluated and properly assigned to all these items except Time Extensions. Following are examples resulting from discussions between Design and Construction. These examples are intended to clarify the definitions of the terms "Avoidable" and "Premium Cost." An **Avoidable contract change** is a contract change which requires modification to a project feature or delay to a contract which should have been foreseen using standard design practices and appropriate project management activities.

Note that Avoidability codes refer only to the need for a contract change. The Avoidability codes do not indicate that the work or the costs associated with that work were avoidable.

Examples of Avoidable vs. Unavoidable Contract Changes

(1) In house designer fails to include erosion control features at the end of a large drainage system outlet and severe erosion occurs. Stone is added by SA or by overrun of existing pay items in an amount large enough to trigger encumbrance of funds before all unfunded contract overruns exceed 2.5% of the original \$4M contract amount.

101 - Necessary pay item(s) not included in contract, 2 - Avoidable Production FDOT. When new pay items are required there will be some non-premium costs as the feature was needed to begin with and was merely added. If the resulting cost is much higher than a normal bid would have been, then the excess costs are premium and no recovery action should be recommended. . . . Or . . . **115 - Required Drainage Modification, 2 - Avoidable Production FDOT.** Here, existing pay items are used to address the work even though the designer did not anticipate it. The resulting overruns are large enough to trigger encumbrance of funds before all unfunded contract overruns exceed 2.5% of the original contract amount. There are some non-premium costs as a needed feature was added... if the resulting cost is much higher than a normal bid would have

been, then the excess costs are premium and no recovery action should be recommended.

(2) A consultant traffic engineer fails to include the proper wiring for power source connections. The contractor requests instruction on where to locate the power source for the signal. The FDOT project administrator documents that the contractor is delayed 18 days while awaiting a response from the designer. The Contractor files a claim for delay damages in accord with the specification 5-12.

118 – Improper or inadequate signing, signalization or pavement marking design or features, 1 -Avoidable Production Consultant. There are some non-premium costs as the feature was needed to begin with but the power source connection cost is much higher than a normal bid would have been. The excess costs are premium as are the delay claim costs. Recovery from the Production Consultant should be recommended.

(3) A utility company fails to identify a 10" sanitary sewer line on its relocation plans creating delays and forcing the use of additional conflict drainage structures.

106 Utility Owner/Agency caused Conflicts: wrong size, wrong location, not constructable as shown in plans, plan errors. No Utility Owner/Agency Agreement/Contract. The costs associated with the work and any delay costs classified as premium costs should be coded as recoverable from the utility agency/owner.

(4) A city or county government agency requests additional work after the contract is Let.

007 - Work added or deleted by a 3rd Party request or from a 3rd Party Agreement provided the city or county government agency **WAS** given a chance to review the plans and request the work prior to letting. No premium costs where full cost is paid by the city or county government agency and no recovery action should be recommended. Or; **007 - Work added to or deleted by a 3rd Party request or from a 3rd Party Agreement, 2 - Avoidable Production FDOT** provided the city or county government agency **WAS NOT** given a chance to review the plans and request the work prior to letting. No premium costs where full cost is paid by the city or county government agency and no recovery action should be recommended.

(5) A commitment for a driveway made by FDOT's right of way agent is not shown on the plans.

008 - Contract Changes at Right of Way Office's request (litigation, court orders, negotiations etc.), 2 - Avoidable Production FDOT. The excess costs associated with the construction of the driveway may be premium. Only the unit costs in excess of the unit costs for similar driveways shown in the plans will be considered premium.

(6) A commitment for a driveway made by a consultant right of way agent is not shown on the plans.

008 - Contract Changes at Right of Way Office's request (litigation, court orders, negotiations etc.), 1 - Avoidable Production Consultant. The excess costs associated with the construction of the driveway may be premium and recovery from the Production Consultant should be recommended. Only the unit costs in excess of the unit costs for similar driveways shown in the plans will be considered premium.

(7) The value of property acquired by an Imminent Domain case is contested, the court ordered settlement stipulates a driveway at a location not shown in the In house produced plans.

008 - Contract Changes at Right of Way Office's request (litigation, court orders, negotiations etc.), 2 - Avoidable Production FDOT. If the settlement order was available before final plans review. Only the unit costs in excess of the unit costs for similar driveways shown in the plans will be considered premium.
Or;

008 - Contract Changes at Right of Way Office's request (litigation, court orders, negotiations etc.), 0 – Unavoidable. If the settlement order was not available before final plans review. Only the unit costs in excess of the unit costs for similar driveways shown in the plans will be considered premium.

(8) The contractor requests clarification of an apparent stationing conflict between the side street curb and gutter and the planned width for side street turnouts. The FDOT project administrator does not respond until after curb and gutter for the turnouts is constructed at the stationing shown in the plans which is too wide to tie into the side street curb and gutter placed by the county 2 weeks earlier. The turnout must be reconstructed, and the project is delayed.

130 - Indecision or delayed response by or on behalf of FDOT causing contract delay, 4 Avoidable FDOT CEI. The costs and time associated with the reconstruction of the turnout are premium and no recovery action should be recommended.

(9) The contractor requests instruction from the Consultant CEI's Senior Inspector after encountering a telephone duct bank at a location not shown on the plans. The inspector mistakenly assumes the duct bank encountered is the duct bank shown as abandoned at a location close by on the plans. The inspector directs the contractor to remove a section of duct bank in conflict with a proposed drainage structure and the project is delayed while telephone cables within the damaged section of duct bank are spliced.

502 - Inaccurate directions given to contractor by or on behalf of FDOT during construction, 3 - Avoidable Consultant CEI. The delay costs associated with splicing the telephone cables and reconstructing the duct bank are premium and recovery from the Consultant CEI should be recommended.

Clarification on Premium Cost

Note that premium costs are commonly associated with avoidable work and the excess costs of unavoidable work. The term premium cost is defined in CPAM Section 7.3.4 as follows:

Premium Cost is the additional cost of a contract change that would not have been incurred if the work had been included in the original contract. More specifically, premium costs are dollar amounts paid for non-value added work. Delays, inefficiencies, rework, or extra work as shown below, other than those caused by the Contractor and/or his subcontractors or suppliers, will be considered as non-value added work. Non-value added work can occur in three distinct situations:

- a) Work delays or inefficiencies: In this situation, the premium costs are the total delay/inefficiency damages paid to the Contractor.
- b) Rework: The premium costs are the dollar amount of the original items of work that have to be removed and the costs to remove these items.
- c) Extra Work: In this situation, the premium costs are computed as the net difference between the final agreed prices paid to the Contractor and what the cost would have been had the extra work been included in the original bid at letting.

Premium costs associated with EOR and CCEI Errors and Omissions shall be Federal-Aid nonparticipating.

For example: The Project Administrator's Entitlement Analysis justifies the Engineer's Estimate for drainage changes requested by the Engineer of Record (EOR). These changes correct a drainage calculation error, made by the EOR's drainage sub consultant, which seriously underestimated the collection area and resulting runoff from

the design storm event. The correction lowers by 3' the bottom elevation shown in the plans for a detention pond and its associated outlet structure. The correction also increases the diameter from 24" to 36" on the run of pipe from the pond outlet to an existing adjacent storm water drainage canal. The original \$3,528,623 contract includes pipe pay items for 24" dia. at \$40/LF and 36" dia. at \$65/LF, neither is a major item of work amounting to 5% of the original contract. The original contract also includes a pay item for 23,700 CY of regular excavation at \$8.00/CY. The regular excavation is a major item of work. The existing outlet structure S-58 was bid at \$4,000. This contractor has removed, modified, and reset a similar structure on an adjacent job for \$5,000.

The Contractor responds within 48 hours to the Project Administrator's Wednesday morning request for a quote. By then the Project Administrator has worked up an Engineer's Estimate of \$81,350. The Contractor must remobilize the drainage subcontractor, which would not have been necessary if the work was included in the original contract, so the \$6,000 remobilization costs are shown in the Engineer's Estimate as justifiable premium costs. The \$2,000 cost of removal and disposal and the \$4,000 cost of furnishing and installing the original 100' run of 24" concrete pipe is shown as premium although the contractor has already been paid for the furnish and install. The \$5,000 cost to modify and reset outlet structure S-58 is shown in the Engineer's Estimate as 100% premium cost. The 6500 CY of regular excavation is shown as non premium costs valued at 6,500 CY times the contract unit price of \$8/CY = \$52,000 per Spec. 12-14.

The Contractor estimates the work will take 20 days. The contractor has been working a 5-day week so far. Based on production rates experienced on the job to date the Project Administrator estimates it will take 26 days. The contract is almost complete with 17 days left by the contractor estimate. When the Contractor's quote is delivered on Friday morning, the contract time has 77 days remaining and the contractor is on track to finish 60 days early collecting an incentive of \$3,000/day.

The contractor states the work can occur concurrently with the remaining critical path items of work, and that if we will agree to a fixed lump sum price based on his quote, then he will forgo any delay claims. The contractor is asking for \$9,000 in lost bonus compensation and 3 days extended overhead at \$1,200/day. By the formula in Spec 5-12, the contractor is due only \$850/day and only then when the cumulative delay extends beyond 10 days. Eight days of FDOT caused delay have occurred to date and the contractor has not been compensated for them. The contractor will accept the existing unit price for the 36" pipe and asks for \$5,000 to remove, modify and reset S-58. The contractor also asks for a 25% increase on the unit price of the regular excavation to \$10/CY. At 1:00 pm on Friday, the Resident Engineer phones the contractor. The

contractor refuses to settle for the Resident Engineer's offer of the \$83,150 Engineer's Estimate, which can be justified within the specifications and insists on the \$97,100 amount of his quote delivered that morning. The contractor reminds the Resident Engineer delay costs are already accruing and his offer of a lump sum price was prepared in haste to mitigate delay damages in a spirit of partnering which puts the contractor at considerable risk if he cannot complete the work in 20 days.

The Resident Engineer considers that they are only \$15,750 apart and the contractor will be claiming \$4,200/day in delay damages with a likely entitlement of \$3850/day, he'll lose 2 days over the weekend, and the contractor may be unwilling to settle for a lump sum fixed price on Monday. If not, additional resources may be required by the CCEI to survey and monitor the excavation quantities. Finally, the contractor may also be less than motivated to finish quickly where the sole remaining work and therefore any delay costs are on the Department. The Resident Engineer calls the District Construction Engineer and briefs him on the situation at 1:30 pm on Friday.

- 1) At 3:30 pm, the Department's Design, Construction and Legal staff agree it is in the Department's best interest to do the work for \$97,100 rather than drag out the negotiations or go to a Dispute Review Board even though this exceeds the Engineer's Estimate. The Project Administrator is informed and gives the Contractor a speed letter informing him that we have accepted his offered quote. The resulting Supplemental Agreement would be coded with 2 issues.
 - a) The first would be an \$83,150 issue with Root Cause Reason Code "**115 Required drainage modifications**", with Avoidability coded Avoidable Production Consultant, with Cost Recovery coded Action Recommended, with Claim Extended Limits coded as Claim, and premium cost shown as \$26,850. Note: the issue premium costs include \$4,000 for the unusable 24" pipe paid under the original contract and that fact should be noted in the space provided for comments or description.
 - b) The second issue would be the settlement costs. A \$15,750 issue with Root Cause Reason Code "**860 FDOT determined risk avoidance cost paid solely to avoid risk in failing to settle disputes**", with Avoidability coded Unavoidable, with Cost Recovery coded No Action Recommended, with Claim Extended Limits coded as Claim, and Premium cost shown as \$15,750 provided it is determined that all of the settlement cost meet either condition a (work delay or inefficiency), b (re-work) or c (extra work) as shown above.

- 2) If the Department's staff was unable to reach a settlement, the Contractor finished 57 days early and a DRB had resolved the issue for \$97,100, then the issues would be coded just as shown above except that the Root Cause Reason Code for the second issue would be "**861, DRB recommended cost in excess of Engineer's Estimate and Entitlement Analysis.**"
- 3) Similarly ... If the Department's staff was unable to reach a settlement and the State Arbitration Board had resolved the issue for \$97,100 based on the circumstances in (2) above, then the issues would be coded just as shown above except that the Root Cause Reason Code for the second issue would be "**862, Arbitration Board recommended cost in excess of Engineer's Estimate and Entitlement Analysis.**"
- 4) Finally... If the Department's staff was unable to reach a settlement and a judge had resolved the issue by Court Order for \$97,100, then the issues would be coded just as shown above except that the Root Cause Reason Code for the second issue would be "**863, Court ordered costs in excess of Engineer's Estimate and Entitlement Analysis.**" Note that this will be the case even if the payment is made by a Receiving Report and Invoice Transmittal (RRIT). RRIT's are tracked in the Contract Change Tracking System with all the same codes used for SA's.

Note that any pre or post judgment interest allowed the Contractor in cases (2) thru (4) above will be added to the Claim Settlement Costs reported in the second issue.

Single Digit Description Codes for Contract Changes

Shown below is a complete list of contract change description codes. The “Avoidable and Unavoidable” contract change codes in the examples above are drawn from this list.

Avoidability Codes

- 0 - Unavoidable: No Remedial Action Required
- 1 - Avoidable: Production* Consultant
- 2 - Avoidable: Production* FDOT
- 3 - Avoidable: Consultant CEI
- 4 - Avoidable: FDOT CEI
- 5 - Avoidable: 3rd Party

Cost Recovery Codes

- R - Action Recommended
- N - No Action Recommended

Claim/Extended Limits Codes

- C – Claim Settlement
- N – Neither
- E – Extend Project Limits

* Note: “Production” includes Design, Design Project Manager, Survey, R/W, and Environmental Office

CONTRACT CHANGE ROOT CAUSE REASON CODES WITH DESCRIPTIONS

- 001 Subsurface material or feature not shown in plan
- 003 Harmonize project with adjacent projects or right of way
- 004 Design Standards, Specification or Policy change after contract letting
- 005 Utility Owner/Agency caused Adjustment delays w/no Utility Owner/Agency Project Agreement/Contract (Premium Cost / Avoidable 3rd party)
- 007 Work added or deleted by a 3rd Party request or from a 3rd Party Agreement
- 008 Contract Changes at Right of Way Office's request (litigation, court orders, negotiations etc.)
- 009 Permit related issues
- 010 Weather Related new work, repairs, overruns or contract changes due to weather
- 012 Deterioration of, or damage to, project after design (not weather related)
- 013 Test features not included prior to letting
- 015 Utility Owner/Agency caused Changes to Utility Owner/Agency Project Agreement/Contract (No cost to FDOT) (Change to Phase 56 and associated Funds included in Original Contract)
- 016 Extend Material Acquisition Time, Flexible Start Time or Mandatory Start Date
- 017 Research Request (**this code may only be used with Change Order type Research Request**) – Research features not included prior to Contract Letting
- 018 Impacts from special events not shown in the Original Contract Plans or RFP (i.e. Delays & MOT for Super Bowl)
- 019 Conflicts between contractors, from overlapping project limits, pay items, schedules etc.
- 021 Damage to Existing Property caused by **known** 3rd Party (**This code may only be used on Projects Let in or after January 2014**)
- 022 Damage to installed Work caused by **known** 3rd Party (**This code may only be used on Projects Let in or after January 2014**)
- 023 Damage to Existing Property (no fault of Contractor) caused by **unknown** 3rd Party (**This code may only be used on Projects Let in or after January 2014**)
- 024 Damage to installed Work (no fault of Contractor) caused by **unknown** 3rd Party (**This code may only be used on Projects Let in or after January 2014**)
- 101 Necessary pay item(s) not included in contract
- 103 Incorrect or insufficient subsoil information included in plans but not accurate (not code 001)
- 104 Incorrect pay items for earthwork, embankment & excavation jobs on one contract
- 105 Discrepancies between plan notes, plan details, pay items, standard indexes and specifications
- 106 Utility Owner/Agency caused Conflicts: wrong size, wrong location, not constructable as shown in plans, plan errors. No Utility Owner/Agency Agreement/Contract
- 107 MOT: Modification of Maintenance of Traffic for pedestrians, boats, cars, bikes, etc.
- 108 Plans do not describe scope of work (use a more specific reason in lieu of this when possible)
- 112 Phasing or plan components not constructible as shown in plans
- 113 Modification to pavement design required
- 115 Required drainage modifications
- 116 Inadequate Right of Way to construct project as shown on plans
- 117 Access Management issues
- 118 Improper or inadequate signing, signalization or pavement marking design or features
- 119 Revisions required related to major structural component changes
- 120 Hazardous materials encountered requiring contract changes
- 122 Bike, pedestrian, ADA or other public transit requirement not properly addressed: not MOT related
- 123 Landscaping issues not adequately addressed
- 126 Computation errors in pay item work amounts
- 128 Inaccurate or inadequate survey information used in plans preparation
- 130 Indecision or delayed response by or on behalf of FDOT causing contract delay
- 131 Architectural feature related issue (generally for building modifications)
- 208 No specification provided for item of work
- 300 Value Engineering Change Proposal (should be a negative amount)
- 305 Cost Savings Initiative
- 325 Partnering (should be overrun only; if adding Partnering specification to contract use 004)
- 350 Dispute Review Board Member Fees (should be overrun only; if adding DRB specification to contract use 004)
- 401 Industry wide Material shortages, Concrete (**this code may only be used for non-compensable time extensions**)
- 402 Industry wide Material shortages, Aggregate (**this code may only be used for non-compensable time extensions**)
- 403 Industry wide Material shortages, Liquid AC (**this code may only be used for non-compensable time extensions**)

CONTRACT CHANGE ROOT CAUSE REASON CODES WITH DESCRIPTIONS, Cont.

- 404 Industry wide Material shortages, Steel (**this code may only be used for non-compensable time extensions**)
- 405 Industry wide Material shortages, Thermoplastic (**this code may only be used for non-compensable time extensions**)
- 450 Time Extensions for Holidays or Special Events shown in the Original Contract Plans or RFP (**this code may only be used for non-compensable time extensions**)
- 502 Inaccurate directions given to contractor by or on behalf of FDOT during construction
- 503 Change resulting from engineering decision (use specific reason in lieu of this when possible)
- 700 Overrun of pay items on all contracts >\$5M; or Overruns of pay items in excess of the AUOA on contracts ≤ \$5M
- 725 Defective materials (should be a negative SA or Work Order)
- 850 Secondary or Subsequent Contingency Supplemental Agreement (do not use this to code individual Work Orders)
- 860 FDOT determined risk avoidance cost paid solely to avoid risk in failing to settle disputes
- 861 DRB recommended cost in excess of Engineer's Estimate and Entitlement Analysis
- 862 Arbitration Board recommended costs in excess of Engineer's Estimate and Entitlement Analysis
- 863 Court ordered costs in excess of Engineer's Estimate and Entitlement Analysis
- 901 Weather related new work/repairs/overruns/contract changes due to Hurricane Charley 2004
- 902 Weather related new work/repairs/overruns/contract changes due to Hurricane Frances 2004
- 903 Weather related new work/repairs/overruns/contract changes due to Hurricane Ivan 2004
- 904 Weather related new work/repairs/overruns/contract changes due to Hurricane Jeanne 2004
- 905 Weather related new work/repairs/overruns/contract changes due to Hurricane Dennis 2005
- 906 Weather related new work/repairs/overruns/contract changes due to Hurricane Katrina 2005
- 907 Weather related new work/repairs/overruns/contract changes due to Hurricane Rita 2005
- 908 Weather related new work/repairs/overruns/contract changes due to Hurricane Wilma 2005
- 909 Weather related new work/repairs/overruns/contract changes due to Tropical Storm Ernesto 2006
- 910 Weather related new work/repairs/overruns/contract changes due to Tropical Storm Fay 2008
- 911 Weather related new work/repairs/overruns/contract changes due to Hurricane Ike 2008
- 912 Weather related new work/repairs/overruns/contract changes due to Tropical Storm Debby 2012
- 913 Weather related new work/repairs/overruns/contract changes due to Tropical Storm Isaac 2012
- 914 Weather related new work/repairs/overruns/contract changes due to Tropical Storm Erika 2015
- 915 Weather related new work/repairs/overruns/contract changes due to Tropical Storm Colin 2016
- 916 Weather related new work/repairs/overruns/contract changes due to Tropical Storm Hermine 2016
- 917 Weather related new work/repairs/overruns/contract changes due to Tropical Storm Matthew 2016
- 918 Weather related new work/repairs/overruns/contract changes due to Tropical Storm Emily 2017
- 919 Weather related new work/repairs/overruns/contract changes due to Hurricane Irma 2017
- 920 Weather related new work/repairs/overruns/contract changes due to Hurricane Nate 2017
- 921 Weather related new work/repairs/overruns/contract changes due to Sub Tropical Storm Alberto 2018
- 922 Weather related new work/repairs/overruns/contract changes due to Hurricane Michael 2018
- 923 Weather related new work/repairs/overruns/contract changes due to Hurricane Dorian 2019
- 924 Contract changes due to COVID-19
- 925 Contract changes due to Protests 2020
- 926 Weather related new work/repairs/overruns/contract changes due to Tropical Storm Isaias 2020
- 927 Weather related new work/repairs/overruns/contract changes due to Hurricane Sally 2020
- 928 Weather related new work/repairs/overruns/contract changes due to Hurricane Eta 2020
- 929 Weather related new work/repairs/overruns/contract changes due to Tropical Storm Elsa
- 930 Weather related new work/repairs/overruns/contract changes due to Tropical Storm Fred 2021
- 931 Weather related new work/repairs/overruns/contract changes due to Hurricane Ian 2022

For questions on these examples or the definition of avoidable contract changes, please contact:

Larry Ritchie - 850-414-4168 / email - larry.ritchie@dot.state.fl.us

**Contract Modification and Reason Type
Combinations**

Created 11/22/2010
Modified 11/30/2022

CO Type	CODEDESC	CO Reason	Possible Combinations
CN	Contingency Supplemental Agreement		
		CONT	Contingency SA
CO	Change Order -- NOT USED - this is a global term used to reference all changes made via SA, WO, or any other changes. The individual designations are as follows:		
EA	Time Extension Agreement		
		CEI	CEI action/inaction
		CHCO	Changed conditions
		DEFM	Defective materials
		IWMS	Industry-Wide Materials Shortage
		MINC	Minor changes
		PLMO	Plans modification
		SPMO	Specification modification
		UTIL	Utility
		CV19	COVID - 19 related
		PT20	Protest related
FA	Force Account -- NOT USED		
HTEX	Holiday Time Extension/Special Events		
		HEX	Time Extension For Holiday/Special Event
MPRT	Modifying Pay Item Participation		
		CEI	CEI action/inaction
		CHCO	Changed conditions
		CLAI	Claims
		MINC	Minor changes
		PLMO	Plans modification
		UTIL	Utility
SA	Supplemental Agreement		
		CEI	CEI action/inaction
		CHCO	Changed conditions
		CLAI	Claims
		CSI	Cost Savings Initiative
		DEFM	Defective materials
		IWMS	Industry-Wide Materials Shortage
		MINC	Minor changes
		PART	Partnering
		PLMO	Plans modification
		SPMO	Specification modification
		TWCH	Tropical Weather Related(Charley)
		TWDN	Tropical Weather Related(Dennis)
		TWEO	Tropical Weather Related(Ernesto)
		TWFA	Tropical Weather Related(Fayo8)
		TWFR	Tropical Weather Related(Frances)
		TWIK	Tropical Weather Related(Ike08)
		TWIV	Tropical Weather Related(Ivan)
		TWJN	Tropical Weather Related(Jeanne)
		TWKT	Tropical Weather Related(Katrina)
		TWRT	Tropical Weather Related(Rita)

**Contract Modification and Reason Type
Combinations**

Created 11/22/2010
Modified 11/30/2022

CO Type	CODEDESC	CO Reason	Possible Combinations
		TWWM	Tropical Weather Related(Wilma)
		TWAB	Tropical Weather Related(Alberto)
		TWCL	Tropical Weather Related(Colin)
		TWDB	Tropical Weather Related(Debby)
		TWDR	Tropical Weather Related(Dorian)
		TWEA	Tropical Weather Related(Erika)
		TWEM	Tropical Weather Related(Emily)
		TWHE	Tropical Weather Related(Hermine)
		TWIR	Tropical Weather Related(Irma)
		TWIS	Tropical Weather Related(Isaac12)
		TWMI	Tropical Weather Related(Michael)
		TWMT	Tropical Weather Related(Matthew16)
		TWNT	Tropical Weather Related(Nate)
		TWIA	Tropical Weather Related(Isaias)
		UTIL	Utility
		WEA1	Recovery due to weather
		CV19	COVID - 19 related
		PT20	Protest related
		TWSL	Tropical Weather Related(Sally)
		TWET	Tropical Weather Related(Eta)
		TWEL	Tropical Weather Related(Elsa)
		TWFD	Tropical Weather Related(Fred)
		TWIN	Tropical Weather Related(Ian)
SPAD	Movement of Items Within Contract		
		CHCO	Changed conditions
		MINC	Minor changes
		PLMO	Plans modification
		UTIL	Utility
SPEC	Work Order for Specification Change Only		
		CHCO	Changed conditions
		IWMS	Industry-Wide Materials Shortage
		PLMO	Plans modification
		SPMO	Specification modification
		UTIL	Utility
UN	Unilateral Payment		
		CEI	CEI action/inaction
		CHCO	Changed conditions
		CLAI	Claims
		MINC	Minor changes
		PLMO	Plans modification
		SPMO	Specification modification
		TWCH	Tropical Weather Related(Charley)
		TWDN	Tropical Weather Related(Dennis)
		TWEo	Tropical Weather Related(Ernesto)
		TWFA	Tropical Weather Related(Fayo8)
		TWFR	Tropical Weather Related(Frances)
		TWIK	Tropical Weather Related(Ikeo8)
		TWIV	Tropical Weather Related(Ivan)
		TWJN	Tropical Weather Related(Jeanne)
		TWKT	Tropical Weather Related(Katrina)
		TWRT	Tropical Weather Related(Rita)
		TWWM	Tropical Weather Related(Wilma)
		TWAB	Tropical Weather Related(Alberto)

**Contract Modification and Reason Type
Combinations**

Created 11/22/2010
Modified 11/30/2022

CO Type	CODEDESC	CO Reason	Possible Combinations
		TWCL	Tropical Weather Related(Colin)
		TWDB	Tropical Weather Related(Debby)
		TWDR	Tropical Weather Related(Dorian)
		TWEA	Tropical Weather Related(Erika)
		TWEM	Tropical Weather Related(Emily)
		TWHE	Tropical Weather Related(Hermine)
		TWIR	Tropical Weather Related(Irma)
		TWIS	Tropical Weather Related(Isaac12)
		TWMI	Tropical Weather Related(Michael)
		TWMT	Tropical Weather Related(Matthew16)
		TWNT	Tropical Weather Related(Nate)
		TWIA	Tropical Weather Related(Isaias)
		UTIL	Utility
		WEA1	Recovery due to weather
		CV19	COVID - 19 related
		PT20	Protest related
		TWSL	Tropical Weather Related(Sally)
		TWET	Tropical Weather Related(Eta)
		TWEL	Tropical Weather Related(Elsa)
		TWFD	Tropical Weather Related(Fred)
		TWIN	Tropical Weather Related(Ian)
WE	Weather Days Time Granted		
		TWCH	Tropical Weather Related(Charley)
		TWDN	Tropical Weather Related(Dennis)
		TWEo	Tropical Weather Related(Ernesto)
		TWFA	Tropical Weather Related(Fayo8)
		TWFR	Tropical Weather Related(Frances)
		TWIK	Tropical Weather Related(Ike08)
		TWIV	Tropical Weather Related(Ivan)
		TWJN	Tropical Weather Related(Jeanne)
		TWKT	Tropical Weather Related(Katrina)
		TWRT	Tropical Weather Related(Rita)
		TWWM	Tropical Weather Related(Wilma)
		TWAB	Tropical Weather Related(Alberto)
		TWCL	Tropical Weather Related(Colin)
		TWDB	Tropical Weather Related(Debby)
		TWDR	Tropical Weather Related(Dorian)
		TWEA	Tropical Weather Related(Erika)
		TWEM	Tropical Weather Related(Emily)
		TWHE	Tropical Weather Related(Hermine)
		TWIR	Tropical Weather Related(Irma)
		TWIS	Tropical Weather Related(Isaac12)
		TWMI	Tropical Weather Related(Michael)
		TWMT	Tropical Weather Related(Matthew16)
		TWNT	Tropical Weather Related(Nate)
		TWIA	Tropical Weather Related(Isaias)
		TWSL	Tropical Weather Related(Sally)
		TWET	Tropical Weather Related(Eta)
		WEA1	Recovery due to weather
		WEA2	Weather days - Weather letters only
		TWEL	Tropical Weather Related(Elsa)
		TWFD	Tropical Weather Related(Fred)
		TWIN	Tropical Weather Related(Ian)

**Contract Modification and Reason Type
Combinations**

Created 11/22/2010
Modified 11/30/2022

CO Type	CODEDESC	CO Reason	Possible Combinations
WOTA	Contingency Work Order Time Adj		
		CEI	CEI action/inaction
		CHCO	Changed conditions
		DEFM	Defective materials
		IWMS	Industry-Wide Materials Shortage
		PLMO	Plans modification
		SPMO	Specification modification
		UTIL	Utility
		CV19	COVID - 19 related
		PT20	Protest related

The preceding notations represent codes within PrC. All of the codes are static with the exception of Tropical Weather Related codes which are implemented upon Emergency Declaration by the Governor and created at that time. All weather related events are coded to weather a weather reason type. Time Extension (EA) are used for any event not related to weather or deferred to Supplemental Agreement (SA). This chart should be used as a reference regarding coding within PrC when clarification is required.

Section 7.4

CONTINGENCY SUPPLEMENTAL AGREEMENTS AND WORK ORDERS

7.4.1 Purpose

To establish a uniform procedure for initiation, execution, and distribution of **Contingency Supplemental Agreements** and **Work Orders**.

7.4.2 Authority

Sections 20.23(3)(a), 334.048(3) Florida Statutes (F.S.)

7.4.3 Reference

334.185, 337.11(1), 337.11(9), 339.135(6)(a), Florida Statutes (F.S.)

FHWA Approved: April 16, 2015

Construction Project Administration Manual
Chapter 7, Section 3 - Supplemental Agreements and Unilateral Payments

Section 4 of the Standard Specifications for Road and Bridge Construction

Procedure No. 375-020-010, Errors, Omissions, and Contractual Breaches by
Professional Engineers on Department Contracts

Procedure No. 350-020-200 Contract Funds Management Funds Approval

7.4.4 Definitions

Refer to the Introduction section of this **Manual**.

7.4.5 Identifying the Need for a Contingency Supplemental Agreement or Work Order

Resident Level Responsibilities

The Project Administrator shall initiate a request for a **Contingency Supplemental Agreement** when it is determined that additional work is necessary and the amount of such work exceeds the amount not committed against the **Initial Contingency Amount Pay Item**.

The Project Administrator shall initiate a request for subsequent **Contingency Supplemental Agreements** when it is determined that additional work is necessary and the amount of such work exceeds the amount not already committed against any previously executed **Contingency Supplemental Agreement**.

The Project Administrator shall initiate a request for a **Work Order** when it is determined that additional work is necessary and the amount of such work is less than the amount not committed against the **Initial Contingency Amount Pay Item** or a **Contingency Supplemental Agreement**.

7.4.6 Funding

Work Orders may be funded through an **Initial Contingency Amount Pay Item (999-25)**; or a **Contingency Supplemental Agreement**. These funds shall not be used for **SUPPLEMENTAL AGREEMENTS** or **UNILATERAL PAYMENTS** except as shown in **CPAM Section 7.4.6.2**. Function (work activity) codes established by the Office of Comptroller for monitoring Department expenditures require these costs be identified separately.

7.4.6.1 Maximum Funding Limits

District Level Responsibilities

The following funding limits have been established for all **Contingency Supplemental Agreements** and the **Initial Contingency Amount Pay Item**.

- (1) If the Proposal Budget Estimate* is \$5,000,000 or less, the amount authorized shall not exceed five percent (5%) of the Original Contract Amount or \$50,000, whichever is less.
- (2) If the Proposal Budget Estimate is more than \$5,000,000, the amount shall not exceed one percent (1%) of the Original Contract Amount or

\$150,000, whichever is less.

* The Proposal Budget Estimate should only include amounts programmed as Phases 52 and 56. Amounts programmed as other Phases (i.e. Phase 58) and amounts associated with DO NOT BID Items and Speed & Law Enforcement Officer items should not be considered as part of the Advertised Budget Amount for the purpose of establishing maximum funding limits for **Contingency Supplemental Agreements** or the **Initial Contingency Amount Pay Item**.

In the event multiple projects are included in the contract, the funding limits referenced above would apply to the contract as a whole: therefore, the prorated amount of the funds encumbered to the individual projects on the contract under a **Contingency Supplemental Agreement** or the **Initial Contingency Amount Pay Item** will not exceed the funding limits set forth above with the following exception. The District Secretary may request an exception to these funding limits for a specific **Contingency Supplemental Agreement** as stated in **CPAM Section 7.4.8.2**.

In the event the contract is locally funded or is associated with a **Locally Funded Agreement**, contingency fund amounts from the local entities are allowed on the contract to the extent money is on deposit with the Department and not subject to the thresholds set above. Contingency funds from local entities will have their own pay item to keep them separate from other contingency amounts.

7.4.6.2 Funds Used for Expediting Unilateral Payments

In order to make timely payment to the Contractor via a **Unilateral Payment** in accordance with **CPAM Chapter 7.3**, the District may temporarily borrow funds, which have already been encumbered for a **Contingency Supplemental Agreement** on the same project, and have not yet been used to fund a **Work Order**. The following process will be applied:

- (1) The District Construction Engineer (DCE) or designee must obtain funds approval through the Contract Funds Management (CFM) System for the required amount of funds for the **Unilateral Payment**.
- (2) The **Contingency Supplemental Agreement** to be used must be in an executed status.

(3) The DCE or designee will reduce the Florida Account Information Resource (FLAIR) "6"s line by the requested amount and re-encumber on a new FLAIR "6"s line with a Function Code/ Work Activity of 230 to indicate a **Unilateral Payment** through the Contract Funds Management (CFM) system.

(4) The FLAIR contract amendment file will be updated to indicate the change. The funds for the **Unilateral Payment** will be placed in a pending status (03).

(5) The DCE or designee's encumbrance request will be approved by the CFM system when the encumbrance is processed through FLAIR and then the **Unilateral Payment** can be executed.

The funds for the **Unilateral Payment** will remain in a pending status (03) (unable to pay) until an executed copy of the **Unilateral Payment** document is received by the appropriate Disbursement Operations Office/Financial Services Office (DOO/FSO) and the funds "borrowed" are re-encumbered against the original **Contingency Supplemental Agreement**. This re-encumbering of the "borrowed" funds is to be done through the standard encumbrance request process.

NOTE: The request to re-encumber the "borrowed" funds must explain that the funds being encumbered are to replace contingency funds that were used for an expedited **Unilateral Payment**. This information is to be in the brief description field and must reference the specific **Contingency Supplemental Agreement** number.

7.4.7 Initial Contingency Amount Pay Item

District Level Responsibilities

The Department has created an **Initial Contingency Amount Pay Item** that can be included in a contract prior to bid. The **Initial Contingency Amount Pay Item** has been established for funding additional work. The **Initial Contingency Amount Pay Item** is an alternate method of obtaining funds for performing additional work, as opposed to obtaining a funds approval from the Office of the Comptroller and executing a **Supplemental Agreement** or a **Contingency Supplemental Agreement**. The funds encumbered for this pay item will be available for **Work Orders** just as **Work Orders** are used on a **Contingency Supplemental Agreement**, but without the delay caused by

obtaining funds approval and preparing and executing a **Contingency Supplemental Agreement**. When the funds made available by the **Initial Contingency Amount Pay Item** are at least 50% authorized for payment and the Project Administrator has determined that additional work is necessary in accordance with **CPAM Section 7.4.5**, a funds approval for the additional funds must be received from the Office of Comptroller, and a **Contingency Supplemental Agreement** must be prepared and executed to provide additional contingency funds. An **Initial Contingency Amount Pay Item** quantity cannot overrun.

The **Initial Contingency Amount Pay Item** that has been established for use is 999-25. The **Initial Contingency Amount Pay Item** will be based on the Department's estimate for the construction contract subject to the limitations in **CPAM Section 7.4.6.1**.

Per the **Work Program Instructions**, the **Initial Contingency Amount Pay Item** shall be shown as Federal-Aid non-participating in the AASHTOWare Project Preconstruction (PrC) system. This pay item is to be used solely for **Work Orders** needed during project construction. The final FHWA participating or FHWA non-participating determination of funds associated with **Work Orders** issued against the **Initial Contingency Amount Pay Item** will be per **CPAM Section 7.4.9.7**. The designer must not associate any pay item notes or work items identified in the plans with this pay item.

The District Estimates Coordinator must enter an amount for this pay item in accordance with the limits established in **CPAM Section 7.4.6.1**. This pay item should be initiated at the same time that the contract duration is provided.

The **Initial Contingency Amount Pay Item** shall not be included in Fast Response and/or Push-button Contracts.

Before an **Initial Contingency Amount Pay Item** can be established on any Non-State Highway System, federally funded project to be constructed by the Department for a Local Government, the Design Project Manager shall obtain a Maintenance Agreement between the Department and the Local Government (Refer to **Financial Provisions For All Department Funded Agreements, Procedure 350-020-301**). The Maintenance Agreement shall establish that the Local Government is responsible for additional project costs determined to be Federal Aid Non-Participating.

7.4.8 Contingency Supplemental Agreement

7.4.8.1 General

A **Contingency Supplemental Agreement, Form No. 700-010-79**, authorizing commitment of funds for an amount not to exceed the limits defined above shall be executed for the encumbered funds designated for additional work after the funds approval has been received from the Office of Comptroller. Only the Secretary of Transportation can delegate authority for approval and execution of **Contingency Supplemental Agreements** by the Department. The Secretary delegates the authority for Department approval of **Contingency Supplemental Agreements** and the authority for Department execution of **Contingency Supplemental Agreements**, in accordance with the limitations described in **CPAM Chapter 7.3.14**. A **Contingency Supplemental Agreement** shall not be executed until the DCE or designee has obtained funds approval for that **Contingency Supplemental Agreement** through the CFM system. **Work Orders** shall not be executed against the **Contingency Supplemental Agreement** until the **Contingency Supplemental Agreement** authorizing commitment of the funds has been executed.

Contractor execution of **Contingency Supplemental Agreements** shall be in accordance with **CPAM Chapter 7.3.14**.

In order to ensure that funds are readily available for additional work, a **Contingency Supplemental Agreement** for an additional amount not to exceed the limits defined in **CPAM Section 7.4.6** may be executed prior to executing **Work Orders** that deplete all funds committed by a previous **Contingency Supplemental Agreement or Initial Contingency Amount Pay Item** for that project. See **Contract Funds Management Funds Approval, Procedure No. 350-020-200** for restrictions.

All terms specified on the **Contingency Supplemental Agreement** shall apply; no additional terms or disclaimers concerning costs of additional work shall be accepted. The terms of the **Contingency Supplemental Agreement** shall not be modified. If an agreement for performance of additional work or a contract change cannot be obtained between the Department and the Contractor within the terms of the **Contingency Supplemental Agreement** or **Supplemental Agreement** then a **Unilateral Payment** document shall be prepared and executed (refer to **CPAM Chapter 7.3**).

Contingency Supplemental Agreements shall not be issued against Fast Response and/or Push-button Contracts.

Before a **Contingency Supplemental Agreement** can be issued against the contract, 50% of the **Initial Contingency Amount Pay Item** must be authorized for payment. Include with the request for **Contingency Supplemental Agreement** an **Initial Contingency Amount Pay Item** funds authorization summary.

Before a second or subsequent **Contingency Supplemental Agreement** can be issued against the project, 50% of the previous **Contingency Supplemental Agreement** for the project must be authorized for payment. Include with each request for additional **Contingency Supplemental Agreement**, a commitment summary showing that a minimum of 50% of the funds associated with the previous **Contingency Supplemental Agreement** has been authorized for payment. As an exception; in the event a contract has local funds involved, and the local funding entity has placed the money on deposit with the Department, then the previous **Contingency Supplemental Agreement** must be in a status 10. However, the 50% authorization restriction for **Work Orders** issued against previous **Contingency Supplemental Agreements** will not apply to **Contingency Supplemental Agreements** funded solely by those local funds.

Before a **Contingency Supplemental Agreement** can be issued against any Non-State Highway System, federally funded project being constructed by the Department for a Local Government, the Project Administrator shall ensure that the Design Project Manager has obtained a Maintenance Agreement between the Department and the Local Government (Refer to **Financial Provisions For All Department Funded Agreements, Procedure 350-020-301**). The Maintenance Agreement shall establish that the Local Government is responsible for additional project costs determined to be Federal Aid Non-Participating.

7.4.8.2 Funds Approval from the Office of the Comptroller for a Contingency Supplemental Agreement

District Level Responsibilities

Funds approval from the Office of the Comptroller is required before executing a **Contingency Supplemental Agreement**. A funds approval from the Office of the Comptroller not to exceed the limits defined in **CPAM Section 7.4.6.1**, except as shown in this subsection, may be requested by the DCE or designee through the CFM system. Funds shall be encumbered using the project number for which the funds will be used. Funds may be encumbered separately and or concurrently for

more than one project included in the contract. Where funds are encumbered on multiple projects within one contract, the limits stated in **CPAM Section 7.4.6.1** apply to the contract as a whole; so that the pro-rated amount of funds encumbered to the individual projects on the contract under a **Contingency Supplemental Agreement** will not exceed the limits set forth in **CPAM Section 7.4.6.1**. Funds encumbered for one project number cannot be used on a different project number included in the same contract.

The District Secretary may request an exception to the above limits by providing the Comptroller with the reason(s) for the exception. The Comptroller must approve such exception prior to funds approval. The District Secretary may delegate authority to request an exception to the District Director of Operations.

A funds approval from the Office of the Comptroller not to exceed the limits defined in **CPAM Section 7.4.6.1** may be requested for not more than one additional **Contingency Supplemental Agreement** prior to the complete depletion of all previous encumbrances for **Contingency Supplemental Agreements** on that contract by executed **Work Orders**.

Uncommitted **Contingency Supplemental Agreement** funds and **Initial Contingency Amount Pay Item** funds should be unencumbered after Final Acceptance.

Upon Final Acceptance, the District Final Estimates Engineer (or delegate) shall submit a statement by e-mail to the Contract Funds Payment Section, with the following certification: "I certify that the contract is in Final Acceptance status; that the funds are not needed for the Regional Disputes Review Board, and that the uncommitted contingency amount is \$ _____."

7.4.8.3 Numbers, Dates, Codes

District Level Responsibilities

The first **Contingency Supplemental Agreement Item Number** on a contract shall be **Item No. 9999 21**; the second **Contingency Supplemental Agreement Item Number** on the contract shall be **Item No. 9999 22**; etc.

No two (2) **Contingency Supplemental Agreements** to any construction contract shall be dated with the same date. No **Contingency Supplemental Agreement**

shall be dated with the same date as a **Standard Supplemental Agreement or Unilateral Payment** to the contract. **Contingency Supplemental Agreements, Standard Supplemental Agreements** and **Unilateral Payments** will incorporate the same numbering system used for the PrC contract modification number.

No **Contingency Supplemental Agreement** can have the same number as a **Standard Supplemental Agreement** or **Unilateral Payment** to that contract. A **Contingency Supplemental Agreement** must not be dated prior to the date of funds approval from the Office of Comptroller.

All executed **Contingency Supplemental Agreements** shall be entered into the **Contract Change Tracking System** and into PrC per the requirements of **CPAM Section 7.3. Supplemental Agreement Description Code No. 850** shall identify all **Contingency Supplemental Agreements**.

7.4.8.4 Contract Time

No additional contract time shall be granted on a **Contingency Supplemental Agreement**.

7.4.8.5 Document Distribution

District Level Responsibilities

When a **Contingency Supplemental Agreement** has been executed authorizing funds for additional work, the executed document with all supporting documentation shall be immediately distributed as follows:

- (1) **Disbursement Operations Office /Financial Services Office*** – One (1) copy.
- (2) **DCE*** - One (1) original.
- (3) **Contractor** – One (1) original.
- (4) **Resident Engineer*** – One (1) copy.
- (5) **Director, Office of Construction*** - (ONLY projects with an original contract amount exceeding \$10 million.) One (1) copy.

***Note:** distribution should be made by either submitting an electronic copy of the documentation or by submitting the Electronic Document Management System Document Number via email.

7.4.9 Work Orders

7.4.9.1 General

A **Work Order** shall not be executed before the **Contingency Supplemental Agreement**, which that **Work Order** is a part of, has been executed.

The **Work Order for Unforeseen Additional Work** form (**No. 700-010-80**) shall be used to document additional work or contract changes in accordance with **CPAM Section 7.3.5.1** with the following restrictions:

- **Work Orders** shall not be written to include normal overruns of existing contract items for work at established contract unit prices shown in the contract documents.
- **Work Orders** shall not be used to settle certified claims or certified requests for equitable adjustment.
- **Work Orders** shall not be used to reconcile any agreement made with the Contractor subsequent to the completion of work related to a previously executed and processed **Unilateral Payment** document.
- **Work Orders** shall not be used to settle costs associated with unforeseen utility work during construction, unless the Utility Agency/Owner has funded the contingency item upon which the **Work Order** will be drawn.
- **Work Orders** should not include lump sum items without a detailed itemization stating the quantities and unit prices the lump sum item was based on.
- **Work Orders** should not be used to add pay items to a project.
- **Work Orders** may be used to document the Department's reimbursement to the Contractor for the Contractor's fee payments made to the individual board members of a Regional Disputes Review Board (RDRB) for those board members participation in RDRB meetings held to resolve disputes related to the contract.

- **Work Orders** may be used, along with the appropriate approvals from the Director, Office of Construction, and the FHWA as documentation to effect a specification change or extend the physical limits of a project (see **CPAM Section 7.4.9.6**).

The terms of the **Work Order** shall provide for full and complete settlement of all issues described therein.

Resident Level Responsibilities

Authority for Department execution of **Work Orders** is delegated to the Project Administrator provided the cost included as part of the **Work Order** is within the financial limitations of **CPAM Chapter 7.3.13** and the Project Administrator has obtained prior approval of the Resident Engineer or District Construction Engineer as appropriate.

Contractor execution of **Work Orders** may be performed at the project level (Project Superintendent, Project Manager, etc.). A Power of Attorney or Corporate Resolution for **Work Order** execution shall not be required.

A **Notice to Proceed** with work to be documented by a **Work Order** shall be issued to the contractor by the Resident Engineer after the Project Administrator has confirmed that sufficient funds are available in the **Initial Contingency Amount Pay Item or Contingency Supplemental Agreement** established for funding the additional work. The **Notice to Proceed** shall include sufficient detail to adequately describe the additional work.

When additional work or a contract change is identified, a **Work Order** shall be executed to document a complete DESCRIPTION of the additional work to be performed and the REASON why this work is necessary with references to the contract for entitlement.

The **Work Order** shall designate whether or not the work described results from a Design Error or Omission.

The Project Administrator shall comply with the requirements of **Procedure No. 375-020-010, Errors, Omissions, and Contractual Breaches by Professional Engineers on Department Contracts**, when a **Work Order** indicates the work

described is the result of a Design Error or Omission.

7.4.9.2 Numbers, Dates, and Codes

Resident Level Responsibilities

The first **Work Order** authorizing additional work to be performed, or a contract change, against an executed **Contingency Supplemental Agreement** or a **Contingency Pay Item** respectively shall be **Work Order No. 01**; the second **Work Order** authorizing additional work to be performed, or a contract change, against the same executed **Contingency Supplemental Agreement** or **Contingency Pay Item** shall be **Work Order No. 02**; etc. This numbering sequence shall be repeated with each **Contingency Supplemental Agreement** or **Contingency Pay Item**.

Example:

Contract Number	T1234				
Financial Project Number	123456-1-52-01			654321-1-52-01	
Pay Item Number	999-25-01 (Initial)	9999-21 (CSA 1)	9999-22 (CSA 2)	999-25-01 (Initial)	9999-21 (CSA 1)
	WO 01	WO 01	WO 01	WO 01	WO 01
	WO 02	WO 02	WO 02	WO 02	
	WO 03	WO 03			

A **Work Order** must not be dated or executed prior to the execution date of the **Contingency Supplemental Agreement** authorizing commitment of the funds.

All **Work Orders** shall be entered into the **Contract Change Tracking System** with description codes. For an explanation of the codes involved, see the

information published under "Coding Contract Changes" heading on the State Construction Office website.

7.4.9.3 Documentation & Costs

Resident Level Responsibilities

(1) **Work Order** documents and/or all supporting documents shall address the following in sufficient detail to adequately explain the additional work to anyone not familiar with details of the project. An **Entitlement Analysis** and **Engineers Estimate** shall be included in the supporting documentation for each **Work Order** which increases or decreases costs and/or time to the project or contract.

- (a) What work was done?
- (b) Why the work was necessary?
- (c) Cite references to the contract which establish contractor entitlement.
- (d) Why the costs and time extensions were considered reasonable?

All costs for additional work shall be:

- a) Negotiated and documented on the **Work Order** and attachments thereto, including the basis for all negotiated costs, or;
 - b) Justified through an analysis or comparison of reasonable costs, or;
 - c) Based on material invoice costs and labor payroll costs including mark-ups shown in **Sub-Article 4-3.2 of the Specifications**. Work Sheets itemizing the costs will be attached. No disclaimers or clauses allowing the Contractor to reserve its rights to request other costs shall be accepted. If an agreement on costs cannot be obtained as shown above, the additional work will be administered in accordance with **CPAM Section 7.3**.
- (2) The **Work Order** shall identify any Premium Cost associated with additional work. The supporting documentation for all **Work Orders** shall include a Premium Cost analysis and Premium Cost determination. When

Premium Cost is identified, reasons justifying FHWA participation shall be included in the supporting documentation for the **Work Order**.

The total cost documented in any **Work Order** shall not exceed the limits defined above. More than one **Work Order** can document additional work associated with any incident.

When the work associated with one incident is to be performed in phases, a separate **Work Order** may be executed to document the description, reason, and costs of each phase of the work, respectively.

When the work associated with one incident, or one phase of the work associated with one incident, is to be paid from funds committed in part by more than one **Contingency Supplemental Agreement**, or by a combination of the **Initial Contingency Amount Pay Item** and any subsequent **Contingency Supplemental Agreement**, a separate **Work Order** shall be executed to identify the **Contingency Pay Item** and each **Contingency Supplemental Agreement** committing each part of the funds, respectively. Each **Work Order** shall contain the same total work description, reason, and total negotiated cost for the work described, and the part of the total cost to be funded by the **Initial Contingency Amount Pay Item** or **Contingency Supplemental Agreement** identified in the **Work Order** respectively.

Work Orders shall be executed authorizing work committing all remaining funds available from an **Initial Contingency Amount Pay Item** or an executed **Contingency Supplemental Agreement** prior to executing a **Work Order** committing funds from any successive **Contingency Supplemental Agreement** for the project.

The total cost of all additional work associated with any incident shall not exceed the limits defined in **CPAM SECTION 7.4.6** regardless of the **Contingency Pay Item** or the number of **Contingency Supplemental Agreements** which authorize commitment of funds for the work or the number of **Work Orders** executed to authorize the work associated with that incident. The **Work Order** shall contain the same project number as the **Contingency Supplemental Agreement** authorizing commitment of the funds if funds are provided by a **Contingency Supplemental Agreement**. Adjustments may be necessary when the Department and the Contractor agree to pay for the cost of the work associated with a **Work Order** based on agreed upon unit prices and estimated quantities and must then execute a lump sum **Work Order** before the work is performed. When this occurs,

the agreed upon unit prices and estimated quantities should be stated in the description of work in the **Work Order**.

When the net cost for the actual quantities of additional work exceeds the estimated amount shown in the **Work Order**, another **Work Order** may be prepared and executed to pay for that portion of the actual quantities exceeding the estimated amounts. The description of work in this adjustment **Work Order** should reference the original **Work Order** and should state the additional quantities and agreed on unit prices upon which it is based.

When the net cost for the actual quantities of additional work are less than the estimated amount shown in the **Work Order**, another **Work Order** should be prepared and executed in a negative amount to reduce the Contractor's final pay for that portion of the actual quantities under running the estimated amounts. The description of work in this adjustment **Work Order** should reference the original **Work Order** and should state the reduction in the original quantities and unit prices agreed on, upon which it is based.

For **Work Orders** issued against the **Contingency Pay Item**, markups by the Contractor for contract bond are not allowed as this bond amount has been included as part of the bid. A Bond markup as allowed by the **Standard Specifications** is allowable for work paid from funds drawn against any **Contingency Supplemental Agreement**.

Note: When making payments on estimates, do not pay an aggregate percentage of the pay item for the **Work Order** resulting in a partial payment amount greater than is justified by the work completed. In this way, the **Work Order** for a negative amount and the balance of the original **Work Order** can be paid on the same estimate. This will avoid any adverse impact to the Contractor's cash flow from the **Work Order** for a negative amount.

7.4.9.4 Funds Used for Credits on Projects

A **Work Order** may be used for the purpose of documenting the deletion of work for Lump Sum projects (receiving credits from the contractor for deleted work). This will be accomplished by selecting the proper type "**Adj. for deleted work-LS jobs only**" in PrC while doing the Line Item Adjustment. This adjustment will be made to the Lump Sum Project Bid Item. This ensures that funding is credited back to the proper function (usually 200 or 203), and not to the contingency funds (202).

A **Work Order** may be used for the purpose of documenting the deletion of work for Bid Item projects (receiving credits from the contractor for deleted work). This will be accomplished by selecting the proper type “**Credit for contract change**” in PrC while doing the Line Item Adjustment. This adjustment will be made to the Bid Item projects. This ensures that funding is credited back to the proper function (usually 200 or 203), and not to the contingency funds (202).

7.4.9.5 Contract Time

Resident Level Responsibilities

Additional contract time required for performing additional work or a contract change may be granted on a **Work Order**. Time extensions will be determined based upon impacts caused by the additional work to controlling items of work as shown in the Contractor’s approved work progress schedule. The **Work Order** shall document the reasons for all time extensions. Approval authority for time extensions is outlined in **CPAM Section 7.2**. The Project Administrator shall obtain prior approval of either the Resident Engineer or DCE, as appropriate, for all **Work Orders** which include time extensions in accordance with **CPAM Chapter 7.2.5** and include such approval in the supporting documentation for the **Work Order**.

7.4.9.6 Director, Office of Construction Authorizations

(A) Resident Level Responsibilities

Prior authorization from the Director, Office of Construction shall be obtained before implementing project limit extensions, construction limit extensions, or changes to contract specifications on all contracts as required by **CPAM 7.3.5.3**

(B) District Level Responsibilities

The DCE shall recommend requests for extending project limits, extending construction limits, or contract specification changes as required by **CPAM 7.3.5.3**. The DCE may also authorize a no cost specification change which extends the material acquisition or flexible start time after issuance of the Notice to Proceed. These recommendations and authorizations shall be documented, attached to the contract change and placed in the contract **Work Order** file. Where the recommendation or authorization is transmitted by e-mail, a copy of that e-mail

originating from the DCE is acceptable. A copy of the notification letter to the contractor regarding the project limit extension, construction limit extension, or specification changes will also be placed with the contract change in the **Work Order** file.

7.4.9.7 FHWA Approval

District Level Responsibilities

FHWA concurrence will be obtained by the Project Administrator on in-house CEI projects and by the Department's Construction Project Manager on Consultant CEI projects for FHWA Project of Division Involvement (PODI) projects when required.

CPAM Section 7.3.10, Obtaining Federal Highway Administration Approval and Participation for Construction Contract Changes on Federal-Aid Projects, lists a representative sample of contract changes that are Federal-Aid non-participating.

FHWA written approval for additional work or contract changes shall be obtained retroactively and documented on the **Work Order**. FHWA may elect to approve additional work by having the **Work Order** sent to them for signature or by signing the **Work Order** at the time of a routine field visit.

The FHWA determines the participation on PODI projects; the DCE shall determine the Federal-Aid participation on Delegated Projects. The DCE can delegate such approval authority to a person within District Construction office staff, but not to a Resident Engineer. Such delegation shall be maintained on file in the District Construction Office.

Written documentation of the DCE's Federal-Aid participation decision on Delegated Projects shall be included in the **Work Order** back up documentation file. An e-mail from the DCE or delegate is an acceptable form of documentation approval.

7.4.9.8 Accounting

Resident Level Responsibilities

Requests for payment of work authorized by the **Initial Contingency Amount Pay**

Item or an executed **Contingency Supplemental Agreement** shall be made separately for each **Work Order** and in accordance with the Federal Participation/Non-Participation schedule for the **Work Order**. Any **Work Order** may be partially Federal participating. Two **Work Orders** need not be executed to separate Federal participating and Non-Federal participating work. If only a portion of the work authorized by a specific **Work Order** was completed during the payment period, then the quantity will be shown as a percentage of the lump sum.

Each successive **Work Order** authorized by an **Initial Contingency Amount Pay Item** or **Contingency Supplemental Agreement** will require additional adjustment or adjustments be added to the pay estimate.

The total of the unit prices of the added items shall not exceed the limits defined above.

Comments shall be added to the estimate on each adjustment to reflect the **Work Order** number or other pertinent information as deemed necessary.

Contact the District PrC Coordinator and / or refer to the **PrC User Handbook** regarding the pay item adjustment issues discussed in the previous paragraphs. The **PrC User Handbook** and contact information for District PrC Coordinators is available on the State Construction Office website under the heading PrC at the following URL. <https://www.fdot.gov/construction/trnsport>

7.4.9.9 Contract Change Tracking Systems

District Level Responsibilities

Within fifteen (15) calendar days after payment on an approved estimate for all or a portion of the work identified within the **Work Order** document, the DCE or designee shall decide upon the final contract change coding and enter the **Work Order** information into the **Contract Change Tracking System** and PrC. If the DCE's designee is not a member of the District Construction Office staff, the DCE's delegation shall be maintained on file in the District Construction Office. Further, if the DCE's designee is not a member of the District Construction Office staff, the DCE shall develop a quality assurance process to ensure accurate contract

change coding and compliance with this section. Such process shall be documented and maintained on file in the District Construction office.

For an explanation of the codes involved, see the information published under "Coding Contract Changes" heading as an attachment to **CPAM Section 7.3** on the State Construction Office website at: [Coding Contract Changes](#)

7.4.9.10 Document Distribution

Resident Level Responsibilities

- (1) When **Work Orders** have been executed the **Work Order** and all supporting documentation as designated below shall be immediately distributed as follows:
 - (a) **Disbursement Operations Office /Financial Services Office*** – one (1) copy when requested
 - (b) **DCE***- One (1) original of the **Work Order** with a copy of all attachments
 - (c) **Contractor** – One (1) original of the **Work Order** only.
 - (d) **Director, Office of Construction*** - (ONLY projects with an original contract amount exceeding \$10 million.) One (1) copy of the **Work Order** with a copy of all attachments. Distribution will be made to the Director, Office of Construction, prior to submitting an estimate for payment of the work.
 - (e) **Resident Engineer*** - One (1) copy of the **Work Order** with a copy of all attachments.
 - (f) **District Director for Production*** (at the discretion of the District) - One (1) copy of the **Work Order**.
 - (g) Design **Project Manager*** responsible for managing the Design Consultant on contracts with Consultant prepared contract documents - One (1) copy of the **Work Order**.

- (h) **State Materials Office*** – One (1) copy of the **Work Order**.

***Note:** distribution should be made by either submitting an electronic copy of the documentation or by submitting the Electronic Document Management System Document Number via email.

- (2) Attachments indicated below shall be distributed with the **Work Order**.
- (a) Documentation forming the basis for all costs.
- (b) Copies of all documentation forming the basis for all time extensions, including a statement of the critical work items delayed showing the non-overlapping delay days attributable to each critical item of work delayed.

7.4.10 Quality Control Process for Contract Changes

District Level Responsibilities

The DCE shall develop a process to review a representative sample of all contract changes to ensure such changes were necessary and comply with the construction contract documents. Such process and reviews will be documented and kept on file in each district for review by the State Construction Office and FHWA.

Section 7.5

CONSTRUCTION CONTRACT CLAIMS

7.5.1 Purpose

To describe the contract administration procedure to be followed for documenting and analyzing construction contract claims to ensure comprehensive and supportable recommendations are developed for use in the resolution of claims.

7.5.2 Authority

Sections 20.23(3)(a) and 334.048(3), Florida Statutes

7.5.3 References

337.11(9), 337.185 and 337.221, Florida Statutes

Federal Aid Policy Guide (23 CFR 635.124)

FHWA Approved: May 11, 2015

7.5.4 Definitions

Refer to the Introduction section of this *Manual*.

7.5.5 Notice

Project Level Responsibilities

Specifications 5-12 and 8-7.3.2 requires that the Contractor provide written notification to the Project Administrator (PA) when the Contractor intends to file a claim and documentation of the work effort resulting from such claims. Written notice must be given before the Contractor begins any extra work on which the claim is based. Notification by the Contractor is required, and enables the PA, to mitigate the impacts of a delay claim or begin documenting the impacts and actual costs associated with the claim. The Contractor's failure to notify the PA before beginning extra work on disputed items of work waives all rights to the Contractor's claim (refer to **Specifications 5-12 and 8-7.3.2**). If the Contractor has failed to afford the Engineer the opportunity to keep strict account of the actual labor, material, equipment and time used by failing to provide written notice of

intent to file claims before beginning the work on which the claim is based, the Contractor will be paid no claim settlement costs (see definition of **Statement of Claim Settlement Costs CPAM Introduction**). Specifically, the Contractor will be paid no more for each claim issue than the amount calculated by multiplying the amount of the most recent Engineer's Estimate for that issue multiplied by the percentage shown for that issue in the most recent Entitlement Analysis. Refer to **Guidance Document 7-3-A** for a description of an Engineer's Estimate and an Entitlement Analysis.

The Department shall enforce the written notice requirement which is important in effective management of claims. If the Contractor verbally indicates that added costs are being incurred during the prosecution of the work, or changes to the contract document are occurring, the PA shall inform the Contractor that written notification must be provided to preserve the claim for consideration by the Department. Written notification is essential to preserve the scope of the claim issues.

The PA can only accept a written notification of intent to file a claim from the prime Contractor. The notice of intent should contain the following information. If the Contractor's written notice does not contain this information, request the Contractor to clarify or expand upon its initial claim notification.

- (1) A statement as to what changed, including a description of the nature, specific location, and extent of the change.
- (2) An indication of who directed or what caused the change.
- (3) A description of how the change has or will impact the Contractor, including reference to any impacted critical activities on the Contractor's latest accepted schedule update.
- (4) A statement of damages, or an estimate of damages, if available, detailing the amount of compensation, time and/or other adjustment to the contract that is being requested.
- (5) Whether the claim is for delay, extra work or a combination of delay and extra work.

7.5.6 Claim Recognition

Project Level Responsibilities

The PA is responsible for recognizing a claim situation, and usually makes the initial determination whether an adjustment or a demand made by the Contractor is contested

and processed as a claim, or is resolved by a routine **Supplemental Agreement, Work Order**, or increased quantity where there is an existing pay item. The recognition of a claim or an adjustment with the potential to escalate to a claim is extremely important so that steps can be taken to resolve the claim in a timely manner. Although claims occur for many different reasons, they are usually based upon an adjustment or alleged adjustment in the Contractor's operation.

7.5.7 Coordination

Project Level Responsibilities

After receiving the Contractor's required written notice of intent to claim or becoming aware of a possible claim, the PA shall notify the Resident Engineer.

Resident Level Responsibilities

The Resident Engineer shall inform the District Construction Engineer (DCE) of the notice of intent to claim. When a written notice of intent to claim is received, a copy of the notice shall be sent to the DCE immediately.

When a written notice of an intent to claim is received, the Resident Engineer shall immediately send a copy of the notice to any Third Party involved (County, Utility owner or others).

District Level Responsibilities

The DCE shall inform the FHWA Transportation Engineer when a notice of intent to claim and/or when a written claim has been received from the Contractor on FHWA Project of Division Involvement (PODI) projects. A copy of the notice of intent to claim and/or a copy of the written claim received from the Contractor on FHWA PODI projects shall also be sent to the Director, Office of Construction.

The DCE shall inform the Director, Office of Construction, the Office of General Counsel (attention: Special Counsel for Construction), District Chief Counsel and the Office of Inspector General on all projects where the DCE has received the notice of intent to claim, and the amount of the claim is estimated to be \$150,000 or more.

7.5.8 Claims Involving a Utility

Project Level Responsibilities

If a claim involves a utility, the PA must also immediately notify the affected utility owner that the Contractor has notified the Department of its intention to file a claim. Notification to the utility may initially be verbal, but the verbal communication must be immediately followed by a letter signed by the Resident Engineer as described below.

Resident Level Responsibilities

The Resident Engineer must immediately notify by letter, the affected utility owner, that the Contractor has notified the Department of its intention to file a claim (refer to **Sample Letter No. 1, Utility Company Notification, Guidance Document 7-5-A**).

7.5.9 Assistance

(A) District Utilities Office

Resident Level Responsibilities

If a claim involves a utility, the District Utilities Office shall be asked to provide a review of all pertinent documents to assist with determining if the claimed changed condition was caused by the Utility's failure to perform work in accordance with the utility work schedules or other relocation agreements.

(B) Office of General Counsel

Resident Level Responsibilities

The Office of General Counsel shall be requested to provide legal review of all pertinent documents and to identify potential legal liabilities, rights, obligations and confidentiality. For additional assistance on difficult claims, the Office of the General Counsel may be contacted in accordance with the District's guidelines on such contacts. The DCE shall approve any request for review by the Central Office.

District Level Responsibilities

The DCE will set the District's guidelines on when such contacts are appropriate. The Office of the General Counsel can be contacted as follows:

Telephone: Voice: (850) 414-5265
Fax: (850) 414-5264
FDOT Office of the General Counsel

Attention: Special Counsel for Construction
605 Suwannee Street, Mail Station 58
Tallahassee, Florida 32399-0458

7.5.10 Coordinating Claim Response Development with FHWA and State Construction Office Staff on Federal Aid Participation (F.A.P.) Projects

Resident Level Responsibilities

On Federal Aid projects, the extent of Federal Aid participation is determined on a case-by-case basis. For this reason, it is important that early coordination be made with the FHWA. The Resident Engineer shall discuss the merits of the claim and the basis for the Department's position on the claim, with the FHWA Transportation Engineer and the State Construction Office. For more on F.A.P. dollar amount determinations see ***CPAM Claim Settlement, Section 7.5.21***.

7.5.11 Minimum Documentation

Justification for all contract claims for which payment includes Claim Settlement Costs, requires, at a minimum, three (3) pieces of written documentation. The first two are drafted by the project level staff while the last is drafted by the Resident Engineer's staff. Justification for contract claims for which payment does not include Claim Settlement Costs, requires at a minimum the Entitlement Analysis and Engineers Estimate.

Project Level Responsibilities

- 1) An Entitlement Analysis showing the percentage entitlement for each of the various claim issues and the reasons supporting the Contractor's entitlement (refer to ***CPAM Guidance Document 7-3-A***). For those claims in excess of \$150,000, draft Entitlement Analysis shall be prepared and submitted to the DCE for review prior to finalization of the claim documentation.
- 2) An Engineer's Estimate, which will be stated in dollars for extra work and days for any impacts to controlling items of work or critical path activities (see definitions in ***CPAM, Section 7.3.4 and CPAM Guidance Document 7-3-A***). For those claims in excess of \$150,000 a draft Engineer's Estimate shall be prepared and submitted to the DCE for review prior to finalization of the claim documentation.

Resident Level Responsibilities

- 3) A **Statement of Claim Settlement Cost**, identifying those costs the Department does not believe it owes the Contractor but is willing to pay to avoid the risks associated with not resolving the claim (see definitions in **CPAM, Section 7.5.4**).

For all claims, the Entitlement Analysis and the Engineer's Estimate shall be done before starting negotiations with the Contractor. It is mandatory, that the Entitlement Analysis and the Engineer's Estimate be committed to writing before starting negotiations with the Contractor. It is mandatory that the Entitlement Analysis, the Engineer's Estimate and a **Statement of Claim Settlement Cost** (if there are any) shall be committed to writing before sending the contract change document to the Contractor for signature.

District Level Responsibilities

For those claims in excess of \$150,000 the draft Entitlement Analysis and Engineer's Estimate will be prepared and submitted to the DCE by the Resident Engineer's staff and shall be submitted to the District Chief Counsel for review prior to finalization of the claim documentation.

7.5.12 Comprehensive Documentation

Project Level Responsibilities

Claim documentation must include all relevant facts and be objective in its coverage. Frequently the most valuable sources of information are the daily and weekly construction project reports of the **Project Diary** which are produced by the Department's CEI project staff. **CPAM Section 5.1** provides guidance for completing these reports and should be reviewed by the project CEI staff carefully when a claim situation arises to ensure that they are complete and factual.

Specifications 5-12, 8-7.3.2 and **100** require specific content in the Contractor's written notice of intent to claim including information on equipment, delays, and the reason for the claim. In addition to the normal, required daily documentation specified above, a claim file shall be established for every "Notice of Intent" filed by the Contractor. The PA shall review these notices along with **Specifications 5-12, 8-7.3.2** and **100**. Where the Contractor's notice of intent to claim is incomplete or untimely, the PA shall notify the Contractor in writing of the deficiency. Both the Contractor's notice of intent to claim and the PA's response shall be included in the claim file. The weekly statements of cost provided by the Contractor pursuant to **Specification 5-12** must also be reviewed as received, with notations indicating any conflicts or inconsistencies with the Department's

project records or observations of project personnel. The weekly statements of cost with appropriate notations must be placed in the claim file along with the independent records maintained by project personnel. If the Contractor fails to provide the weekly statements of cost, the PA or designee shall notify the Contractor in writing of their obligation under the contract documents to keep such records and provide them weekly to the Department. Copies of this correspondence shall be included in the claim file. The claim file must also include any notifications to utilities or property owners that are affected by the claim as well as any correspondence received from the Contractor relating to the identified claim issue(s).

Resident Level Responsibilities

The Resident Engineer shall also review the *Project Diary* documents for completeness when a claim or disputed work is involved. For a list of the *Project Diary* documents see the definition of *Project Diary* in *CPAM Section 5.1.4, Project Diary*.

7.5.13 Concurrent Documentation

Project Level Responsibilities

Concurrent documentation is often a major factor in determining the weight or impact of a given document during administrative and legal considerations. A brief note on the *Daily Work Report*, which was made at the time of a particular occurrence, will often have more validity than a carefully worded, memo to the file prepared weeks or months after the fact. Project personnel shall make notes and comments on the *Project Diary* reports and documents (see definition *CPAM Section 5.1.4*) to describe events or record their observations of the situation at the time of occurrence and take dated photographs or video records of the conditions. These notes should be objective, professional, relating to the facts, and without bias or opinions.

7.5.14 Record of Contractor's Equipment, Labor and Material

Project Level Responsibilities

When the PA receives a notice of intent to make a claim from the Contractor, the Contractor's equipment, labor and material used on the disputed work must be documented. The PA must keep an accurate record of the types of equipment, including equipment serial numbers, and lengths of time each piece of equipment is used in performing disputed work, required to be on standby, or idled because of the disputed work or impacts. The number of workers, their job classification and time spent in

performing the work related to the claim must be recorded as well as material types and quantities of each material type used. On larger projects, with multiple claims, location of crews by foreman and station number shall be recorded on the daily construction project report. Accurately tracking this information will allow the Contractor's statement of damages to be verified upon submittal.

7.5.15 Claim File

Project Level Responsibilities

Once a claim situation has been identified, by receipt of a written notice from the Contractor, of the Contractor's intention to pursue a claim, the PA must establish a separate file and keep copies of all documents related to the claim. Files must be created for each written notice from the Contractor of their intention to make a claim. Many Contractors provide a unique numerical identification number for each of their claims. If the Contractor is not providing such a unique identifier, provide one as part of the creation of the claim file.

Resident Level Responsibilities

The Resident Engineer and PA should share the same file if they work in the same office. These claim files will serve as the primary source of information relating to the claim. These files shall be kept current and orderly, such that a review of the files at any given time will provide a full understanding of the claim and a logical progression of events. Contact the District Chief Counsel or the Office of the General Counsel to determine if and how these claim files or other related files should be stamped or marked to be treated as "Attorney's Work Product." Such claim files are privileged information to assure the confidentiality of the Department's claim analysis and recommendations during certain claim settlement investigations undertaken with direction of legal counsel.

7.5.16 Sources of Documentation

Project Level Responsibilities

Good documentation comes from many sources and in various forms. Some of the most important types of documentation are excerpts from the contract documents specifically related to the claim issue. These will be made part of the supporting documentation in the claim file. When notice of intent to file a claim is given to the Department, the first thing that the PA must do is research the contract documents to determine exactly what the contract says with respect to the claim. All pertinent drawings, notes, specifications, and

special provisions shall be included or referenced in the claim file. Project personnel must remain aware of the many sources, which can provide information regarding a claim, and shall review those sources and document their findings. **Guidance Document 7-5-B** provides a listing of these sources.

7.5.17 Contractor's Submission of Claim

Project Level Responsibilities

The Contractor's notice requirements and the content of the Contractor's written claim submission, including the Contractor's certification of the truthfulness of that written claim submission, are stated in **Specification 5-12**. These requirements shall be enforced. Refer to **CPAM Section 7.5.11(3)** for a discussion of the calculation of compensation when the Contractor has failed to file a timely notice of intent to claim. At some point, either after completing the work or resolving the situation over which the Contractor has submitted a notice of intent to file a claim, the Contractor shall submit a claim package to the PA stating the amount of compensation and contract time or other adjustments to the contract that are being requested.

- (1) The PA should encourage the Contractor to submit the claim package for review as soon as possible. It is the prime Contractor's sole responsibility to submit claims. Claim packages will not be accepted from a subcontractor unless the Contractor includes a cover letter accepting the validity of the claim including, where applicable, the required written certificate of claim.
- (2) It is the Contractor's sole responsibility to provide a complete claim package. The claim package should state the Contractor's position and the alleged reasons for the claim. The claim package must specifically explain how the Contractor was impacted and what the monetary and time costs associated with the impacts were. The impacts and cost must be certified in accordance with **Specification 5-12.9** to be accurate and complete to the best of the Contractor's knowledge and stated in enough detail to support the resolution of any claim determined to have merit.
- (3) With the exception of claims certified in accordance with Specification 5-12.9, if adequate detail is not provided in the Contractor's submission of the claim package, the PA shall clearly specify the additional information needed, and return the claim package to the Contractor. If the PA finds the claim to be without merit, the reasoning for this determination shall also be clearly provided to the Contractor. The Contractor should determine the amount of damages claimed to be due in a claim and present those damages to the PA for review.

- (4) For claims against utilities, upon receipt of any written notice of intent to claim or any written claim package materials from the Contractor, the PA shall immediately discuss the merits of the claim with the Resident Engineer. A copy of the written notice of intent to claim and or any written claim package materials from the Contractor shall be sent to the Resident Engineer.

Resident Level Responsibilities

- (5) For claims against utilities, upon receipt of any written notice of intent to claim or any written claim package materials from the Contractor, the Resident Engineer shall forward a copy of the Contractor's intent to claim notice and any related claim materials received from the Contractor to the utility owner. Refer to **Sample Letter No. 1, Utility Company Notification, (Guidance Document 7-5-A)**. After discussing the merits of the claim with the PA, a copy shall also be sent to the DCE.
- (6) For claims against utilities, upon receipt of a complete claim package, the Resident Engineer shall consult with the District Utility Engineer and shall notify the utility owner in writing that the claim package has been received. The intent of this letter is to allow the utility owner the opportunity to investigate and negotiate a settlement directly with the Contractor if desired. Refer to **Sample Letter No. 2, Utility Company Notification, (Guidance Document 7-5-C)**. With that notification letter, the Resident Engineer shall also forward a copy of the Contractor's claim package to the utility owner.

7.5.18 Analysis of Claim Packages

Project Level Responsibilities

Upon receipt of a complete claim package, the PA will review the claim and compile any additional documents deemed relevant and forward to the Resident Engineer for review.

Resident Engineer Responsibilities

On claims of \$150,000 or more, informational copies of the complete claims package shall also be sent to the Office of the General Counsel, the Office of the Inspector General, and the State Construction Office. The reviewer shall first prepare a draft Entitlement Analysis to determine if the claim is valid, and then, if entitlement is recognized, prepare a draft Engineer's Estimate to determine the extent of compensation. To perform these two steps, the reviewer must have all necessary facts relating to the claim available. Refer to **Guidance Document 7-3-A** for a description of an Engineer's Estimate and an

Entitlement Analysis.

District Level Responsibilities

The DCE shall approve any request for review by the Central Office, in accordance with the guidelines of **CPAM 7.5.9(B)**, described herein.

(A) Establishing the Facts

Project Level Responsibilities

The availability of facts will vary depending on the level of review. As a claim is processed for higher level review, all pertinent facts must be provided to the next level. The first level of review for a claim will usually be at the PA's level. It is at this level that all facts are documented from project records and the original Entitlement Analysis and Engineer's Estimate are produced.

The initial source of information and facts are contained in the Contractor's claim package. The project records must be reviewed to determine if the facts presented by the Contractor can be verified, and to determine if the Contractor's information is incomplete or misleading. Relevant additional information and any conflicting information shall be identified. The reviewer should separate the facts into three categories: those the Department and the Contractor agree on; those which are unsubstantiated or incomplete; and those which are disputed by the Department.

For facts which are disputed, the reviewer shall identify and document, where possible, what the facts are believed to be, with references to other backup documentation.

Gathering and establishing of the facts shall be done before beginning the two-step review process. The facts will need to be available to adequately perform each step.

(B) Entitlement Analysis

Project Level Responsibilities

The reviewer must first determine whether the claim has any basic merit, or whether it should be denied because there is no basis for entitlement. Input from the Office of the General Counsel shall be obtained at this point to assess the potential legal liability. The reviewer shall make this determination on the individual merits and available facts pertaining to the claim situation. When determining claim entitlement, the reviewer shall

address the following questions for each claim issue.

- (1) Did the Contractor provide the required written notice of intent to claim?
- (2) Was there a change to the original contract requirement that led to the claim?
- (3) Who or what caused the identified change?
- (4) What were the impacts to the Contractor due to each identified change?
- (5) Were the impacts unexpected or unreasonable?
- (6) Could the Contractor have avoided any adverse impacts through proper action?
- (7) Was it reasonable to have anticipated the identified changes at the time of bid?
- (8) Did the Contractor attempt to mitigate the claim or its effects?
- (9) Was complete claim documentation provided in the timeframe outlined in the contract or in accord with ***Specifications 5-12 and 8-7.3.2?***
- (10) Are any aspects of the claim excluded pursuant to the terms of the contract? For example, current delay by the Contractor, anticipated contractor profits, acceleration not requested in writing by the Department.
- (11) Determine any percentage of entitlement on each claim issue as follows:

When the items above completely support the Contractor's position, percent entitlement would be one hundred percent. When the items above completely refute the Contractor's position, the percent entitlement would be zero percent. When items above support only a partial entitlement based on the fact that the Contractor was partially responsible for the claim issue state the partial percentage of the total cost and time impacts the Contractor is entitled to recover along with the reasons supporting the Contractor's entitlement.

(C) Extent of Compensation

Project Level Responsibilities

Determining the extent of compensation is the second step in the analysis of a claim package after it has been determined that the Contractor has some entitlement for the

claim. In this step, the reasonable costs the Contractor incurred must be determined.

The Contractor is solely responsible for providing a claim package, which must include a detailed breakdown of the costs incurred. These costs should relate to the impacts on the construction identified in step one which established the basis for eligibility. The State Construction Office's State Contract Administration Specialist may be contacted if the reviewer is unfamiliar with the Contractor's method of cost justification.

In determining the extent of compensation due in a claim situation, only the actual costs incurred by the Contractor are reimbursable, up to a reasonable amount. Compensation is not computed on a force account basis unless expressly provided for in the contract documents. The following costs are frequently included in claim submissions:

Operating Equipment Costs: Compensation must be based on a supportable length of time for the equipment operation cost. The Contractor must provide the basis for the ownership or rental costs, and the operating costs. Equipment costs are to be determined as per **Specification 4-3.2.1** of the applicable contract specifications.

Idle Equipment Costs: If idle equipment was identified as an impact in the eligibility step, then compensation must be based on a supportable length of time that required equipment was idle, and the actual ownership or rental costs incurred by the Contractor. Based upon the situation, it may be cheaper to keep idled equipment on the project site if demobilization and remobilization of that equipment will cost more than the idle equipment charges. Idle equipment charges must be determined in accordance with **Specification 4-3.2.1** of the applicable contract specifications. Idle asphalt plants will only be compensable for delays if the plant is dedicated to the project. If the asphalt plant provides asphalt to multiple projects or sells commercially and not dedicated to the project, it would not be compensable for delays. If a claim includes costs for a non-dedicated idle asphalt plant, the costs must be removed from the claim.

Labor Costs: Compensation will be paid for actual costs based on documented work hours and certified payroll statements. Lost labor efficiency based on work elements performed out of sequence or over longer time frames than originally scheduled may be considered with proper documentation. Labor costs are to be determined as shown in **Specification 4-3.2.1** of the contract specifications.

Material Costs: Compensation will be paid for the actual cost of materials being used, based on a supportable quantity of materials and invoices showing the materials costs. A markup may be allowed as shown in **Specification 4** of the contract specifications.

Unit Price Costs: Compensation may be based on a unit price including material, labor,

equipment overhead, and profit. If this method is used, the number of units involved must be verifiable and the unit price should be reasonable. The Contractor is required to provide a breakdown of the unit price. Items priced at a unit price must be separated from other items in the claim since overhead and profit cannot be included twice. Lump sum items shall not be accepted without detailed itemization stating the quantities and unit prices the lump sum item was based upon.

Delay Damages: If delay was identified as an impact in the eligibility step, then compensation will be paid in accord with **Specification 5-12.6.2** for the delay. The Contractor must separately identify all associated delay costs so they can be verified, and a determination made as to their reasonableness. The granting of additional contract time must be reasonable and supportable based on delays in the controlling items of work.

Indirect Costs, Expenses and Profit: Compensation for all indirect costs, expenses and profit of the Contractor, including but not limited to overhead of any kind, whether jobsite, field office, division office, regional office, home office, or otherwise will be paid in accord with **Specification 4-3.2.1**. Care should be used to ensure that profit is not allowed more than once, such as applying a profit markup to total cost which includes unit price items already allowing for profit. Anticipated profits will not be allowed due to the difficulty in verifying whether or not such profits are under the realm of Contractor risk. Profits or markups on the additional expenses Contractor's incur as a result of a disruption/delay claim are prohibited.

These costs are to be provided by the Contractor and may be subject to audit by the Department's Inspector General's staff.

Prime Contractor Markups on Subcontract Invoices: Markups are to be allowed as per **Specification 4-3.2.1(4)(a)**.

Interest: Compensation is not allowed for any interest added to a Contractor's claim except as provided in the **Specification 9-9** for interest payments after the settlement of the claim.

Insurance and Bond Premium: General Liability Insurance and Bond Premium will be allowed as per **Specification 4-3**.

7.5.19 Negotiations and Resolution Processing

For any contract change involving monetary compensation see **CPAM Section 7.3**.

7.5.20 Claims Against Utility Performance

Project Level Responsibilities

This section applies only to claims against the utility owner or its agents.

- (1) If the utility owner, having been notified under **CPAM Section 7.5.8** of this procedure, fails to reach an agreement with the Contractor by 60 days after receipt of such notice, the Resident Engineer shall schedule negotiations with the Contractor. Prior to negotiations the Resident Engineer shall notify the utility owner of time and location of the scheduled negotiations. Refer to **Sample Letter No. 3, Utility Company Notification, (Guidance Document 7-5-D)**. A copy of the **Utility Company Notification** letter shall be sent to the Office of Comptroller-General Accounting Office, Locally Funded Agreement Section.
- (2) Representatives of the utility owner who may be in attendance at the negotiations meeting may present facts relating to the conditions that existed.
- (3) If necessary following negotiations, the Resident Engineer will initiate a request for funds and a **Supplemental Agreement** as appropriate to settle the claim and, within 60 days, make any necessary demands against the utility owner for reimbursement of costs for which the Utility was found to be responsible. Refer to **Sample Letter No. 4, Utility Company Notification of Demand for Reimbursement, (Guidance Document 7-5-E)**. A copy of the **Supplemental Agreement** and **Utility Company Notification** letter shall be sent to the Office of Comptroller-General Accounting Office, Locally Funded Agreement Section.
- (4) If reimbursement for the claim is not settled with the utility within 60 days, the matter shall be referred to the Office of General Counsel for litigation. A copy of the referral notification to the Office of General Counsel shall also be sent to the Office of the Inspector General and to the Office of Comptroller-General Accounting Office, Locally Funded Agreement Section.
- (5) The collection of all funds due to the Department must be in accordance with the collection effort provisions outlined in **Procedure No. 350-060-303, Accounts Receivable**.

7.5.21 Claim Settlement

(A) Federal Aid Participation (F.A.P.) Projects With Claim

Settlements Less Than \$200,000

Claims on F.A.P. projects having claim settlements less than \$200,000, which do not involve claims for acceleration or delay, and are not the result of arbitration, court judgment or administrative review, shall be proposed for Federal Aid participation.

(1) FHWA Projects of Division Interest

District Level Responsibilities

The DCE shall prepare a letter asking for FHWA concurrence with the District's recommendations on PoDI projects. Refer to **Sample Letter** to FHWA Requesting Concurrence and Participation in a Claim Settlement, (**Guidance Document 7-5-F**).

The FHWA will sign the letter indicating their disposition of the Department's request. This will be expressed in days and dollars. The letter will be returned to the DCE with a copy to the State Construction Office. The DCE shall note reasons for non-concurrence and any appeal made on the District copy.

(2) Delegated Projects

District Level Responsibilities

The District Construction Engineer will determine FHWA participation on delegated projects. This will be done at the time of recommending approval for the Supplemental Agreement. The guidelines contained in the latest version of the **FHWA-FDOT Stewardship and Oversight Agreement, Procedure No. 700-000-005**, as well as past precedents and **CPAM Section 7.3.11** shall be used in determining Federal Aid participation.

(B) F.A.P. Projects with Claim Settlements of \$200,000 or More

For any F.A.P. projects that have delay and/or acceleration claims, claim settlements totaling \$200,000 or more and claims involving arbitration, court judgments, or administrative board review shall be submitted to the FHWA for concurrence.

Resident Level Responsibilities

For claims over \$200,000 and claims the District anticipates will be over \$200,000, the Resident Engineer will notify the Director, Office of Construction of the claim by memo as soon as the Resident Engineer becomes aware of it.

District Level Responsibilities

The DCE shall keep the Director, Office of Construction advised of the progress in resolving the claim by forwarding to the State Construction Office copies of the Contractor's correspondence on the claim and copies of all letters from District personnel to the Contractor, offering or confirming a resolution of the claim.

The DCE shall prepare a formal request for FHWA participation, setting forth in writing the legal and contractual basis for the claim, together with the cost data and other facts supporting the settlement. The request shall be sent to the Director, Office of Construction for concurrence. The Director shall either send the claim back to the District for further review/clarification or forward the claim package to the FHWA with a letter of concurrence.

(C) Claim Settlement Greater Than \$500,000

District Level Responsibilities

For each claim resolution resulting in a **Supplemental Agreement** or other contract modification that increases the value of the contract by more than \$500,000, the highest level of management involved in the negotiations, including and up to the Department Secretary shall certify in writing that there are no facts or circumstances relating to the settlement, **Supplemental Agreement**, or other contract modification that would indicate that such was affected by any improper influences or by any improper intervention on behalf of the Consultant or Contractor by any state officer, state employee or any other person outside the Department. A copy of this certification shall be placed in all the contract claim files mentioned in **CPAM 7.5.11** and a copy of it shall be attached to all copies of the contract changes used to pay the claim settlement which are distributed with back-up documentation in accord with **CPAM 7.3**. On Federal-Aid contracts only send a copy to the District Federal-Aid coordinator. Refer to **Sample Letter, Claims Settlement Certification, (Guidance Document 7-5-F)**.

If a claim settlement cannot be resolved at the District level, then the dispute shall be escalated to the Director, Office of Construction along with a written recommendation of action, prepared by the DCE, based on a review of the Engineer's Estimate and Entitlement Analysis. If the settlement is escalated beyond this point, it shall be accompanied by a similar recommendation prepared by the Director, Office of

Construction or subsequently, by the Chief Engineer.

If a written request is submitted to the Department's Inspector General by the District Secretary or the Director, Office of Construction, then the Inspector General shall review the request. The OIG may perform an independent audit on a claim which results in a settlement, **Supplemental Agreement** or other contract modification which increases the value of the contract by more than \$500,000 and shall determine whether the claim has been processed in accordance with all applicable laws, rules and procedures.

Claim Settlements greater than \$500,000 require the advance approval of the Chief Engineer.

7.5.22 Settlement Supplemental Agreement

Resident Level Responsibilities

Once the Department has agreed on a resolution, participation has been solicited from FHWA and the availability of funds has been certified by the Comptroller's Office, the Resident Engineer's staff shall process a **Supplemental Agreement** to pay the claim in accordance with **CPAM Section 7.3**.

If any issues contained in the Contractor's claim merit full or partial pay but the Contractor refuses to settle that portion of the claim with a supplemental agreement; then a unilateral payment may be used to make that payment as outlined in the discussion of unilateral payments in **CPAM 7.3**.

7.5.23 Court Ordered Claim Settlement

District Level Responsibilities

Upon receipt from the Department's attorney of a properly executed "Final Judgment" related to a court ordered payment, the DCE will produce a **Receiving Report and Invoice Transmittal (RRIT), Form No. 350-060-02**. The date of the Judge's signature of the "Final Judgment Against FDOT" must be placed on the line labeled "DATE SERVICES RECEIVED." The words "FINAL JUDGMENT MADE AGAINST FDOT" shall be typed in above the "DATE SERVICES RECEIVED" line. **Note:** the RRIT for a Claims Settlement must be properly coded for FHWA participation and non-participation by FHWA or the DCE's staff personnel. The RRIT will be executed by the DCE's staff personnel on the "SUBMITTED BY" line and by the DCE or his delegate on the "APPROVED FOR PAYMENT" line. The executed RRIT, the properly executed Final

Judgment, and a cover memorandum from the DCE to the Department's Comptroller stating that this is an "URGENT CLAIM SETTLEMENT RESULTING FROM A FINAL JUDGMENT AGAINST FDOT" will then be submitted. The DCE shall also send a copy of this package to the Department's attorney who had advised the District on this claim settlement.

Upon receipt of the package of documents from the DCE, the Department's Comptroller will calculate the amount of any post-judgment interest due and forward the package to the State Comptroller for payment with a letter stating the judgment amount and the amount of any post-judgment interest which may be due. If the Contract is still open, it may be possible to pay the Final Judgment by Supplemental Agreement if funds are available or can be made available. A copy of this cover letter shall also be sent to the Department's Attorney and the DCE.

7.5.24 Claim Denial

District Level Responsibilities

The DCE shall send a letter to the Contractor denying the claim after consulting with the Office of General Counsel.

If any issues contained in the Contractor's claim merit full or partial pay but the Contractor refuses to settle that portion of the claim; then a unilateral payment may be used to make that payment as outlined in the discussion of unilateral payments or supplemental agreements in **CPAM 7.3**.

7.5.25 Claim Appeal

District Level Responsibilities

When the Contractor will not accept the District's denial or settlement offer on a claim, then the appeal process will be governed by the contract.

Note: If the contract contains **Specification 8-3.7 Disputes Review Board**, then the appeal process must be handled by the Disputes Review Board before the Contractor can take the issue to arbitration or litigation as outlined in **Specification 8-3.7**.

7.5.26 Acknowledgement of Resolution/Rescission

The PA is responsible for ensuring all claims filed on a project have been resolved by supplemental agreement, rescinded by the Contractor, or any outstanding Notice of

Intent or claim submitted with the ***Final Estimates Documentation*** and marked as Pending on ***Form 700-050-20, Final Plans and Estimates Transmittal***.

For all claims that are resolved or rescinded by the Contractor before Final Acceptance, the PA shall send a letter (**Guidance Document 7-5-H**) to the Contractor acknowledging that the claim is resolved or has been rescinded and the Department considers that specific claim closed. After Final Acceptance, the District Final Estimates Manager will follow the procedures outlined in ***Review and Administration Manual Chapter 5*** to ensure any pending claims are qualified or regular acceptance is received to indicate full settlement of all issues and claims on the contract.

7.5.27 Claim Records Storage and Retention

Resident Level Responsibilities

All of the claim files mentioned in ***CPAM 7.5.11*** are to be combined into a single claim file and any of the following items not already included in that file are to be added to it including the claim package, the Entitlement Analysis, the Engineer's Estimate, the ***Statement of Claim Settlement Costs***, related supplemental documentation, related review analysis, related recommendations, related settlement or denial documentation, related letters, related certifications and other related correspondence. This claim file shall be stored with the other project records. If a Consultant CEI was used on the project, the file shall be given to the Construction Program Manager for storage. File retention, disclosure, exemptions, and privileges are subject to existing Florida law.

A flow chart of the claims process is shown on the State Construction Office website section for ***CPAM***.

Guidance Document 7-5-A

SAMPLE LETTER NO 1 UTILITY COMPANY NOTIFICATION

XYZ Utility Company

DATE:

Subject: Notification of Claim to Utility Company No. 1

Financial Project ID: XXXXXX-X-XX-XX
FAP No.: XXX-X (XX)
Contract No.: XXXXXXX
Local Description:
County: XXXXXXXXXXXXX

Dear Sir or Madam:

Please be advised that the Florida Department of Transportation has been notified by (Contractor's Name), the Contractor for the above referred project that they intend to submit a claim for additional compensation due to a changed condition caused by your company's alleged failure to perform work in accordance with the utility work schedules or other relocation agreements.

Pursuant to Florida Law your company may be responsible for these additional costs. This office will furnish you additional information in regard to the circumstances the Contractor is claiming. The Department will maintain records to document the conditions we observe during the period in question.

Sincerely,

Resident Engineer

cc: Contractor
Project Administrator
District Construction Engineer
District Utilities Engineer
Director, Office of Construction
Office of General Counsel
District Chief Counsel

Guidance Document 7-5-B

RESOURCES OF INFORMATION AND DOCUMENTATION

1. CONTRACT DOCUMENTS

1. Special Provisions
2. Plan Notes
3. Plan Drawings
4. Standard Plans
5. Developmental Specifications
6. Supplemental Specifications
7. Standard Specifications
8. Contract Bid Proposal and Bid Tabulations
9. Technical Special Provisions

2. PROJECT RECORDS

1. Daily and Weekly Reports of Construction
2. Test Reports
3. Progress Estimates
4. Daily Ledger
5. Weekly Estimate Worksheets
6. Utility Diaries
7. Record of Preconstruction Reports and Records
8. Various Construction Reports and Records for Items of Work
9. Time Extensions
10. Change Orders
11. Supplemental Agreements
12. Shop Drawings
13. Work Progress Schedules and Revisions
14. Records of Equipment, Labor and Material Used on Claim Related Work
15. Unilateral Payments

3. CONTRACTOR'S RECORDS

1. Time Sheets
2. Certified Payrolls
3. Material Invoices
4. Equipment Rental Invoices
5. Subcontracts
6. Prequalification Records

Guidance Document 7-5-B

4. CORRESPONDENCE

1. Contractor's Notice of Intent to File Claim
2. Correspondence to and from Contractor
3. Correspondence to and from Designer
4. Inter-Department Correspondence and Memos
5. Correspondence to and from FHWA
6. Inspection Reports

5. MISCELLANEOUS

1. Phone Records
2. Meeting Minutes
3. Photographs
4. Statements of Witnesses
5. Weather Data
6. As-Built Schedules
7. Estimates Desk Review
8. Designer's Files
9. Specifications and Estimates File
10. Utility Files
11. Video Recordings

Guidance Document 7-5-C

**SAMPLE LETTER NO. 2
UTILITY COMPANY NOTIFICATION**

XYZ Utility Company

DATE:

Subject: Notification of Claim to Utility Company No. 2

Financial Project ID: XXXXXX-X-XX-XX
FAP No.: XXX-X-(XX)
Contract No.: XXXXXXX
Local Description:
County: XXXXXXXXXXXXX

Dear Sir or Madam:

By letter dated _____ from _____, you were advised that (Contractor's Name), the Departments Contractor for the referenced project, had notified us of its intent to submit a claim for additional compensation due to a changed condition caused by your company's alleged failure to perform work in accordance with the utility work schedules or other relocation agreements. The Department has received a detailed statement of claim from the Contractor. We, request that you respond directly to the Contractor to settle the matter and notify this office within 15 days as to your position concerning this claim.

If both you and the Contractor agree that negotiations are progressing, but a final settlement has not been achieved within 60 days, then a time extension (up to 60 days, 120 days total) may be requested.

If you and the Contractor fail to reach a settlement within the aforementioned time period, the Department will negotiate a settlement with the Contractor and seek reimbursement from your company of any costs that you are responsible for.

Sincerely,

Resident Engineer

cc: Contractor
Project Administrator
District Construction Engineer
District Utility Engineer
Director, Office of Construction
Office of General Counsel
District Chief Counsel

Guidance Document 7-5-D

**(a) SAMPLE LETTER NO. 3
UTILITY COMPANY NOTIFICATION**

Date

XYZ Utility Company

Subject: Notification of Claim to Utility Company No. 3

Financial Project ID: XXXXXX-X-XX-XX
FAP No.: XXX-X-(XX)
Contract No.: XXXXXXXX
Local Description:
County: XXXXXXXXXXXXX

Dear Sir or Madam:

By letter dated _____ we advised your company that _____ (Contractor's Name), the Departments Contractor for the referenced project, has submitted a detailed statement of claim for additional compensation due to a changed condition caused by your company's alleged failure to perform work in accordance with the utility work schedules or other relocation agreements.

INSTRUCTION: **USE ONLY 1** OF THE 2 FOLLOWING PARAGRAPHS

Sixty days from the date of that letter have elapsed and we have not received any notification that your company has reached an agreement with the Contractor on a settlement of this claim. During this period, we have not received a time extension request from your Company, stating that your company and the Contractor agree that negotiations are progressing and that a settlement is expected within the next 60 days. Accordingly, The Department intends to proceed with the negotiation of a settlement with the Contractor on this claim.

- OR -

Since 120 days from the date of that letter have elapsed and we have not received any notification that your company has reached an agreement with the Contractor on a settlement, The Department intends to proceed with the negotiation of a settlement with the Contractor on this claim.

Please be advised that representatives of the Department and the Contractor will meet at (Time) on (Date) at (location of meeting) to negotiate a settlement with the Contractor. We urge your attendance since the Department will seek reimbursement from your company of any costs that you are responsible for.

Sincerely,

Resident Engineer

cc: Contractor
Project Administrator
District Utility Engineer
District Construction Engineer
Director, Office of Construction
Office of General Counsel

Office of Inspector General
District Chief Counsel
Office of Comptroller, Attention: General Accounting Office, LFA Section

Guidance Document 7-5-E

**SAMPLE LETTER NO. 4
UTILITY COMPANY NOTIFICATION OF DEMAND FOR REIMBURSEMENT**

XYZ Utility Company

DATE:

Subject: Demand for Reimbursement

Financial Project ID: XXXXXX-X-XX-XX
FAP No: XXX-X-(XX)
Contract No: XXXXXXXX
Local Description:
County: XXXXXXXXXXXXX

By letter dated (____) your company was advised that (Contractors Name), the Departments Contractor for the referenced project, has submitted a detailed statement of claim for additional compensation due to a changed condition caused by your company's alleged failure to perform work in accordance with the utility work schedules or other relocation agreements.

A settlement meeting was held on (Date) between representatives of your firm, the Contractor and the Department's representatives in an attempt to settle the claim. The meeting resulted in an impasse between your firm and the Contractor.

The Department has reviewed the claim from the Contractor and has determined that the Contractor's claim is justified. The Department has entered into an Agreement with the Contractor to provide additional compensation in the amount of (\$ AMOUNT) to resolve the Contractor's claim associated with the changed condition caused by your company's failure to perform work in accordance with the utility work schedules or other relocation agreements.

The Department has also determined that your company is liable for costs in the amount of (\$ AMOUNT) and hereby demands reimbursement to the Department.

Sincerely,

Resident Engineer

cc: Contractor
Project Administrator
District Utility Engineer
District Construction Engineer
Director, Office of Construction
Office of General Counsel
District Chief Counsel
Office of Comptroller, Attention: General Accounting Office, LFA Section

Guidance Document 7-5-F

SAMPLE LETTER TO FHWA REQUESTING CONCURRENCE AND PARTICIPATION IN A CLAIM SETTLEMENT

Date

FHWA Division Administrator
Federal Highway Administration
545 John Knox Road, Suite 200
Tallahassee, Florida 32303

Attention: _____ (Transportation Engineer)

Subject: Recommendation for FHWA participation in a claim settlement

Financial Project ID: XXXXXX-X-XX-XX
Contract No: XXXXXXXX
FAP No: XXXX-XXX-X
County:
Contractor's Request No: XXXXXXXXXXXXX

Enclosed is a copy of the Department's evaluation of the subject claim. Our analysis concludes that the Contractor's claim is justified in the amount of \$ _____.

The Department respectfully requests FHWA concurrence and participation.

Sincerely,

District Construction Engineer

cc: Director, Office of Construction
Resident Engineer
District Federal-Aid Coordinator

Guidance Document 7-5-G

**SAMPLE LETTER
CLAIMS SETTLEMENT CERTIFICATION**

Pursuant to Section 337.221, Florida Statutes, the following certification is made as to the terms of Supplemental Agreement No. _____, dated Month XX, 20XX, on Florida Department of Transportation Contract No. XXXXX:

I, _____ (NAME) _____, District Director of Operations, hereby acknowledge, attest and affirm that I have made reasonable inquiry and, based upon my personal knowledge as to the negotiations and circumstances; there are no facts or circumstances relating to Supplemental Agreement No. _____ that would indicate that the agreement was affected by any improper influences or by any improper intervention on behalf of the Contractor, by any state officer, state employee, or any other person outside the Department.

(NAME)
District Director of Operations

Sworn to and subscribed to me this _____ day of _____, 20XX.

Distribution: District Federal-Aid Coordinator (on Federal-Aid contracts only)
All contract claims files mentioned in CPAM Section 7.5.7.4
Attach this letter to all copies of the contract change used to pay the claim settlement which are distributed with back-up documentation

Guidance Document 7-5-H

SAMPLE LETTER RESIDENT ENGINEER CLAIM SETTLEMENT/RESCISSION RESPONSE

Date:

Contractor NAME/ADDRESS
TOWN, STATE, ZIP CODE

SUBJECT: Time Extension Request
Financial Project ID:
Project No.:
State Job No:
Contract No.:
F.A.P. No.:
County:

Dear Sir or Madam:

This letter is to acknowledge receipt of the rescission of the Notice of Intent to Claim submitted by XXX to the Department on (date) . (Copy attached) This rescission was received by the Department on (date).

or

This letter is to acknowledge receipt of your signed Supplemental Agreement (Number XXX) which settles your Claim in full (Insert all NOI numbers and corresponding claim descriptions settled by this Supplemental Agreement here). Your signed Supplemental Agreement was received by the Department on (date).

Sincerely,

Project Administrator

cc: District Construction Engineer

Section 7.6

CONTRACTING FOR GOVERNOR DECLARED EMERGENCIES

7.6.1 Purpose

To establish a uniform procedure for the initiation, execution and administration of emergency contracts and to standardize the Department's responses to contractors related to impacts to construction projects in advance of and following natural disasters covered by Governor declared emergencies.

7.6.2 Authority

Sections 20.23(3)(a) and 334.048(3), Florida Statutes (F.S.)

7.6.3 Reference

Title XVII, Chapter 252, F.S., Emergency Management
Sections 4-3, 7-14, 8-7 and 104-7, Standard Specifications for Road and Bridge Construction
Article IV, Section 1(a), Florida Constitution

7.6.4 Emergency Contracts

Form **375-040-61, Emergency Contract** (herein referenced as **H-Contract**), **Supplemental Agreement, Unilateral Payment, Work Order**, or one of the Departments Standard Form Contracts with an "H" contract number, may be used to facilitate the contracting process for Governor declared emergencies as outlined in **Emergency Procurement During Governor Declared Emergencies, Procedure No. 375-040-130**. These contract forms are available from the Department's Infonet forms site and include detailed instructions for preparation and execution.

An **H-Contract** can be used to provide for emergency and/or permanent restoration on existing construction contracts. The emergency and/or permanent restoration work is to be negotiated with the contractor who has the existing construction contract without the need for competitive bids. Some advantages of using **H-Contracts** are: facilitated tracking, reporting, records retention, and federal reimbursement from either the Federal Highway Administration (FHWA) or the Federal Emergency Management Agency (FEMA). It is important to note that on state funded contracts, the Department will have

to enter into a separate H contract with the Contractor to be eligible for federal reimbursement without federalizing the existing construction project. To avoid federalizing a state funded project, any emergency damage repair eligible for federal reimbursement should be performed under a separate H contract.

Emergency related contracts will need an **H-Contract** number, the appropriate emergency financial numbers for each activity, and are to include all the emergency and/or permanent restoration work. Obtain the **H-Contract** number from the District Procurement Office and the emergency financial number from the District Work Program Office. The **H-Contract** should be fully executed by both parties prior to the emergency work starting, but shall be executed prior to the expiration of the Governor's declaration. Funding for the emergency work should be encumbered by the next business day following the work beginning or execution of the contract whichever is first.

When seeking FHWA reimbursement, attach the following to the **H-contract Supplemental Agreements, Unilateral Payments, and/or Work Orders**:

- **Form 1273 – Required Contract Provisions Federal-Aid Construction Contracts** – This form shall be attached to the **H-Contract** for construction related services where there is, or there is potential for, federal reimbursement. See link below:

<https://www.fhwa.dot.gov/programadmin/contracts/index.cfm>

- **Wage Rate Tables** – The appropriate wage rate table shall be attached if the services being provided are subject to the U.S. Department of Labor, Davis Bacon Act. See link below:

<https://beta.sam.gov/search?index=wd&keywords=&sort=-modifiedDate&wdType=dbra&page=1>

A separate **H-Contract** may be issued with the Consultant Construction Engineering and Inspection (CCEI) managing the existing construction contract to oversee the emergency and/or permanent restoration work on existing construction contracts. Work is to be negotiated with the firm who has the existing CCEI contract. The contract must have the appropriate emergency financial number for each work activity to facilitate tracking, reporting, records retention and federal reimbursement (FHWA and FEMA). The appropriate emergency financial number should be obtained from the District Work Program Office. As with construction contracts, a separate H-Contract must be used on state funded projects seeking reimbursement to prevent federalizing the existing CCEI contract. Terms for Federal Aid contracts are found in Appendix I Form # 375-040-40. See link below.

Form [375-040-40](#)

H-Contracts related to reimbursement requests under the FHWA Emergency Relief (ER) program must be documented on a FHWA Detailed Damage Inspection Report (DDIR) to be completed by the Department and approved by FHWA. If practical, all DDIR's associated with the **H-Contract** should be referenced therein.

Supplemental Agreements, Unilateral Payments, and/or Work Orders can also be used for emergency and/or permanent restoration on existing construction contracts. Work is to be negotiated with the contractor who has the existing construction contract without the need for competitive bids. If these contract changes are used, they must have the appropriate emergency financial number for each work activity, and a contract change root cause reason code to facilitate tracking, reporting, records retention and federal reimbursement (FHWA and FEMA). The appropriate emergency financial number should be obtained from the District Work Program Office.

Do not use **H-Contracts, Supplemental Agreements, Unilateral Payments, or Work Orders** to contract with a local government for reimbursable FHWA funding. Form **350-000-15, Emergency Local Government Emergency Relief Reimbursement Agreement**, is to be used for this purpose. Emergency and permanent work to be performed by a Local Government shall be in accordance with **Emergency Procurement During Governor Declared Emergencies, Procedure No. 375-040-130**.

7.6.5 Governor Declared Emergencies

To account for the potential impacts natural disasters covered by Governor declared emergencies have on active construction projects, the following process will be utilized, pursuant to **Specifications 7-14 and 8-7.3.2**. Suspension and resumption of operations on projects shall be implemented by the Districts on a case by case basis. No statewide closures will be implemented in advance of a natural disaster covered by a Governor declared emergency unless directed by the Chief Engineer.

1. A State of Emergency must be declared by the Governor of the State of Florida.
2. During the period of the State of Emergency, the Department elects to compensate the Contractor for the following and/or grant time extensions for the following, where the Contractor has taken every reasonable precaution to prepare for the natural disaster covered by a Governor declared emergency:

- Damage to material that was incorporated into the projects and accepted by the Department prior to the natural disaster (Federal-aid participating*; FHWA Emergency Relief (ER) eligible);
- Damage to stored materials at the project site that would otherwise be permanently incorporated into the project (Federal-aid non-participating*; FHWA ER ineligible);
- Reconstruction of permanent or temporary erosion control features in accordance with **sub-article 104-7.1** (Federal-aid participating*; FHWA ER eligible);
- Taking down and replacing Maintenance of Traffic (MOT) devices as directed by the District Construction Office (Federal-aid participating*; FHWA ER ineligible);
- Repair of damaged post-mounted MOT signs, deemed to be essential by the Engineer and damaged where left in place; and repair of damaged Changeable (Variable) Message Signs that were specifically directed by the Department to be placed on projects during the storm (Federal-aid participating*; FHWA ER eligible);
- In the days immediately preceding a natural disaster covered by a Governor declared emergency, the Department may prohibit lane closures to allow departing travelers unrestricted egress from evacuation areas. These days, up to two (2) calendar days with prohibited lane closures, would not be eligible for compensation. For any days exceeding the two (2) calendar days, the Department will compensate idle equipment and labor per **sub-article 4-3.2** for the days on which the contractor could have prosecuted the work but for the District directed suspension of operations (Federal-aid participating*; FHWA ER ineligible);
- In the days immediately following a natural disaster covered by a Governor declared emergency, the Department may prohibit lane closures to allow returning travelers and assistance service vehicles unrestricted ingress to evacuation areas. These days, up to two (2) calendar days with prohibited lane closures, would not be eligible for compensation. For any days exceeding the two (2) calendar days, the Department will compensate idle equipment and labor per **sub-article 4-3.2** for the days on which the contractor could have prosecuted the work but for the District directed suspension of operations. Each contract will be evaluated on a case by case basis and factors such as adverse conditions at the job site, loss of power, etc. shall be considered in the determination of whether the contractor could have prosecuted work (Federal-aid participating*; FHWA ER ineligible).

* Reference to “*Federal-aid participating*” in this section refers to use of

regular Federal-aid funds.

The Project Administrator and the Contractor must establish the extent of damage. The Department will pay these costs no later than the second (2nd) estimate following submittal by the contractor provided that all information and documentation requirements have been met.

No compensation will be paid to the contractor for the following items:

- Per day MOT devices not in place on a project;
- Damage to MOT devices, whether in place or elsewhere, except under the exception provided above;
- Temporary works or material damage, except under the exception provided above;
- Idle labor except as stated above;
- Idle equipment except as stated above;
- Reduced production rates due to effects of inclement weather;
- Loss of Profits; and
- Home Office Overhead, Jobsite Overhead, and any other Overhead except as stated above.

3. Pursuant to **Specification 8-7.3.2**, the Department may grant a non-compensable time extension for the effects of the inclement weather related to the natural disaster covered by a Governor declared emergency.

If project resources (equipment and/or personnel) documented to be allocated to critical path or controlling items of work are diverted for emergency work for other governmental agencies or for restoring water, electricity service, and signalization, the Department will grant non-compensable weather days equal to the duration those resources were reasonably diverted. For project resources that are documented to initially not be allocated to critical path but due to their diversion from the project become critical, the Department may consider granting non-compensable weather days only to the duration equal to the time documented to be on the critical path.

For contracts with No-Excuse Completion/Milestone/Incentive dates the Chief Engineer delegates authority to the District Construction Engineers (DCE) to approve requests to modify No-Excuse Completion/Milestone/Incentive dates which are the result of natural disaster covered by a Governor declared emergency. The Director, Office of Construction shall be sent copies of all No-Excuse Completion/Milestone/Incentive dates approved by the DCE.

All requests for modification of a No-Excuse Completion/Milestone/Incentive date

which are the result of a natural disaster covered by a Governor declared emergency in excess of four (4) days must be submitted to the Director, Office of Construction for review and recommendation to the Chief Engineer for review and approval/disapproval.

Such No-Excuse Completion/Milestone/Incentive dates will only be adjusted by the Department in its sole and absolute discretion, by action of the DCE or Chief Engineer as appropriate, based on the following criterion, and then only to the extent of whichever time calculation is greater:

- a. The amount of time that serious adverse conditions existed on the project (i.e., flooding, substantial erosion, etc.); and
- b. The amount of time that the Department suspended the Contractor's operations during normal (scheduled) work days (i.e., If contractor had five-day work week scheduled or the contract prohibited work on Saturday and Sunday, then time will not be granted for such days).

There shall be no right of any kind on behalf of the contractor to challenge or otherwise seek review or appeal in any forum of any determination made by the Chief Engineer under this section.

4. The Contractor will be required to submit, at a minimum, the following below listed items, along with a certification under oath and in writing, in accordance with the formalities required by Florida law, that the request for compensation, time extension, or modification of a No-Excuse Completion/Milestone/Incentive date is made in good faith, that any supportive data provided are accurate and complete to the Contractor's best knowledge and belief, and that the amount of compensation or days requested accurately reflects what the Contractor in good faith believes to be well founded under the criteria provided above for consideration by the Department. Such certification must be made by an officer or director of the Contractor with the authority to bind the Contractor. Items required to be provided, and certified as to under oath and in writing, to the Department are:
 - a. A detailed description of the activities and justification, with associated dates.
 - b. A detailed cost estimate for work to be performed or actual costs for work already performed. Work should be priced based on bid items to the maximum extent possible or in accordance with **Specification 4-3.2**.
 - c. If applicable, listing of labor and idle equipment present at the job site the day prior to the suspension, (including its identification number with serial number, manufacturer, year manufactured, model and description), the

standby rate determined in accordance with **Specification 4-3.2** and the number of hours.

The above information shall be submitted no later than six weeks following the cessation of all natural disasters covered by a Governor declared emergency related impacts to the project or two weeks after Final Acceptance of the contract, whichever is sooner. A timely request is a condition precedent to any right for the Contractor to recover any time and/or compensation. Any request that fails to fully comply with the certification requirements will not be reviewed by the Department.

5. Incorporate the following into the terms of any **Supplemental Agreement** issued for the purpose of compensating the contractor for impacts caused by natural disasters covered by a Governor declared emergency:

*“Notwithstanding the provisions of paragraph 4, this **Supplemental Agreement** is entered into pursuant to applicable provisions of the contract including **Article 7-14** of the applicable **Standard Specifications**, and to the extent this Supplemental Agreement covers rebuild, repair, restore and make good costs under **Article 7-14** it is expressly accepted by the Contractor as being the result of the exercise of the Department’s discretion under **Article 7-14**. Further, it is expressly understood and agreed to by the Parties that any time adjustment or sum to be paid pursuant to this **Supplemental Agreement** shall have no precedential value for purposes of constituting a basis for determining any potential future grant of time or money on this or any other project, and the facts, basis for, and particulars underlying the granting of any time or money hereunder shall also be inadmissible in any administrative, arbitration or legal proceeding arising out of this project, or any other project, for purposes of or relating to a claim of entitlement to time or money, whether as a settlement document or otherwise. The Department and the Contractor agree that the contract time adjustment, if any, and the sum agreed to in this **Supplemental Agreement** constitute a full and complete settlement of any and all issues of entitlement to either time or money and the Contractor hereby accepts the terms of this **Supplemental Agreement** as full compensation for all costs of equipment, manpower, materials, overhead, profit and delay damages and for all their costs, whether direct or indirect, whether incurred now or in the future, related to any of the issues set forth in this **Supplemental Agreement**.”*

6. All time extensions and costs paid in relation to a natural disaster covered by a Governor declared emergency shall be coded as “weather related new work, repairs, overruns or contract changes due to declared emergency”. Refer to **Section 7.3** of this **Manual** for the specific reason code for each natural disaster covered by a Governor declared emergency. See link below:

https://fdotwww.blob.core.windows.net/sitefinity/docs/default-source/construction/manuals/cpam/newcleanchapters/cpam-7-3-attachment-coding-contract-changes-attach-for-sect-7-3-2022-prc.pdf?sfvrsn=7390a1a8_4

Pursuant to **Specification 8-7.3.2**, the Department's determination as to entitlement to time extensions related to natural disasters covered by a Governor declared emergency will be final, unless the Contractor can prove by clear and convincing evidence to a Disputes Review Board that the Department's determination was without any reasonable factual basis.

Pursuant to **Specification 7-14**, the Department's determination as to entitlement to compensation related to natural disasters covered by a Governor declared emergency will be final and there shall be no right of any kind on behalf of the contractor to challenge or otherwise seek review or appeal in any forum of any determination made by the Department under this provision.

Applicability of this section and/or specific inclusions and/or exclusions of items that are to be compensated which are related to natural disasters covered by a Governor declared emergency can only be appealed to the Director, Office of Construction.

7. FHWA ER on Active Construction Projects:

The primary intent of this section is to address the Department's and FHWA's position on reimbursing the contractor for damages on active construction projects as a result of natural disasters covered by a Governor declared emergency. It is FHWA's position that a roadway under construction should be treated the same as a roadway with an inherent deficient condition unless a roadway segment cross section has been completed in conformance with the project's contract requirements. Therefore, FHWA generally will NOT reimburse for fixing damages on active construction projects with ER funding unless damage occurs on a segment of the roadway in which the cross section has been completed. Regular federal aid funds may still be used for the repairs provided the repair work is determined to be outside the requirements of the construction contract, thus it is not the contractor's responsibility to make the repairs at no additional cost under the contract terms.

Below is the FHWA program position for reimbursement eligibility under the ER program:

- a. Only those project sites sustaining a minimum of \$5,000 in repair costs and located in counties covered by a declared State of Emergency are eligible for reimbursement.

b. In addition to FHWA making an ER eligibility determination, the FHWA District Transportation Engineer must also determine if the repair is an Emergency Repair or Permanent Repair. Emergency Repairs are reimbursed at 100% if completed within 180 days after the event. Permanent Repairs are reimbursed at the normal pro-rata share for that particular facility (Interstate 90%, other 80%). FHWA approval must be obtained prior to performing repairs classified as Permanent Repairs. Permanent restoration requires contract acquisition under routine process design, bid, build. Upon design completion, project is advertised, let and awarded as required by FHWA. Any reimbursement request under the FHWA ER program must be documented on a ***FHWA Detailed Damage Inspection Report*** to be completed by FHWA.

c. The following bulleted items may be eligible subject to review and approval by the FHWA District Transportation Engineer on a case by case basis:

- Damage to material that was incorporated into the projects.
- Reconstruction of permanent or temporary erosion control features in accordance with ***Specification 104-7.1***.
- Repair of damaged post-mounted MOT signs, deemed to be essential by the Engineer and damaged where left in place; and repair of damaged Changeable (Variable) Message Signs that were specifically directed by the Department to be placed on projects during the storms.

Section 7.7

Payment and Recovery of Property Damage Costs

7.7.1 Purpose

To establish a uniform procedure for the administration of property damage caused by a third-party occurring within construction projects.

7.7.2 Authority

Sections 20.23(3)(a) and 334.048 (3), Florida Statutes, F.S.

7.7.3 Reference

Standard Specifications for Road and Bridge Construction
Section 4, Article 4-4
Section 7, Articles 7-11 and 7-14

Construction Project Administration Manual
Chapter 7 Section 3
Chapter 7 Section 4

Procedure No. 225-085-002, Submission and Recovery of Property Damage Claims
Procedure No. 850-000-005, Maintenance Responsibilities on Construction Projects

7.7.4 Payment

Repair cost associated with damage to existing property and for damage to installed materials caused by known and/or unknown third parties will be determined in accordance with **Articles 4-4, 7-11, and 7-14** of the **Standard Specifications for Road and Bridge Construction**. Payment for eligible repairs will be made in accordance with **Chapter 7, Section 3** or **Chapter 7, Section 4** of this **Manual**. The Federal Highway Administration will not participate in the payment for third party damages. Payment must be coded as Federal Aid Nonparticipating.

7.7.5 Recovery of Property Damage Claims

Resident Level Responsibilities

The Resident Engineer will initiate recovery of Department incurred costs including the deductible amount associated with repairs to existing property and/or installed materials caused by known and/or unknown third parties in accordance with ***Procedure No. 225-085-002, Submission and Recovery of Property Damage Claims***. When submitting ***Property Damage Claims*** to the Office of General Counsel, the Resident Engineer shall provide contact information (i.e. Name, Address, Phone Number, Email Address) for the individual who can substantiate damages and costs and who may be contacted by the Office of General Counsel.

Upon notice of receipt and amount of recovery by the Office of General Counsel, the Resident Engineer shall coordinate an encumbrance of the necessary funds and make payment of the prorated portion of the recovery amount (as applicable) to the contractor on the next monthly estimate as a line item adjustment. Notice received after the contract is closed will require the contract to be reopened, funds encumbered, and payment of the prorated portion of the recovery amount (as applicable) made to the contractor as a line item adjustment.

Section 8.2

ENVIRONMENTAL COMPLIANCE

8.2.1 Purpose

To ensure effective compliance within all areas of environmental concern during construction projects.

8.2.2 Authority

Sections 20.23(3)(a) and 334.048(3), Florida Statutes (F.S.)

8.2.3 Reference

Form No. 650-040-01, Permit Transmittal Memorandum
Form No. 650-040-03, Stormwater Pollution Prevention Plan Construction Inspection Report
Form No. 650-040-07, Contractor Certification/NPDES Generic Permit for Storm Water Discharges from Construction Sites Form
Project Commitment Record
Section 403.077, F.S. Public Notice of Pollution

8.2.4 Review

The PA shall review and be familiar with all contract documents for the project and the project site, including all the natural features protected by federal and state regulations.

8.2.5 Preconstruction Conference

Project Administrator Responsibilities

The PA shall notify all Department offices and any regulatory agencies having jurisdiction or input in the construction activities covered by the project permits of the date and time of the Preconstruction Conference with the Contractor.

- (1) The PA must become familiar with the requirements of FDOT Procedure No. 650-000-003, Project Commitment Tracking, prior to the Preconstruction Conference. The PA may schedule an internal meeting with Department personnel, including the District Environmental Administrator, Permit Compliance Coordinator, District Permits Coordinator, and to the DCE or designee to discuss questions or concerns regarding permit requirements and/or the ***Project Commitments Record*** prior to the Preconstruction Conference.
- (2) The PA shall perform a comprehensive review of all permits and commitments to familiarize the Contractor with all permit and commitment requirements.
- (3) The Preconstruction Conference minutes shall reflect the details of the tasks, responsibilities, and discussions relating to environmental issues and copies should be furnished to all parties per ***Construction Project Administration Manual (CPAM) Chapter 3.1.7.***

8.2.6 Monitoring Regulated Activities

Project Administrator Responsibilities

The PA shall monitor all regulated activities to ensure that they are conducted in accordance with the permit(s) and all permit conditions are met.

- (1) The PA will verify that the Contractor posts and maintains a copy of all contract permits and any other applicable permit or contract documents, in a prominent location on the construction site that is accessible for public viewing in accordance with permit and contract requirements and conditions.
- (2) When required, the PA will provide notification, or verify Contractor notification, to the regulatory agencies as directed by the permit. A copy of the notification letter (e.g. commencement of permitted activity) will be sent to the District Permits Coordinator, the Permit Compliance Coordinator, and the DCE or designee.
- (3) When contamination notes, markings, or contamination related Modified Special Provisions (MSP) are included in the Contract Documents, the PA shall ensure the Contractor and their subcontractors coordinate construction efforts in the designated areas with the District Contamination Impact

Coordinator (DCIC) and District Contamination Assessment and Remediation (CAR) Contractor, as directed.

- (3) The PA shall monitor all permit expiration dates for projects under construction and will advise the District Permits Coordinator and the DCE or designee at least six (6) months prior to an applicable permit's expiration date, if the permit will expire before the permitted activity is expected to be complete, so a permit extension can be sought.
- (4) Prior to Final Acceptance, the PA will ensure that the Contractor has provided signed and sealed as-built drawings and certified surveys for surface water management systems, bridge clearances, and authorized work as directed by the permit conditions and the contract documents. The PA will ensure that the Operation Engineer or Consultant CEI Resident Engineer will sign and seal all completion/certification statements as required by the permit.
- (5) The PA will submit to, or notify the applicable regulatory agencies, the signed as built plans and the as built certifications of completion, with reference to the applicable permit(s), of the completion of permitted activities immediately after the permitted activity is completed or as directed by the permit. The uploaded plans manifest or confirmation will be sent to the District Permits Coordinator and the DCE or designee.
- (6) The PA will send a copy of the **Notice of Acceptance of Construction**, if applicable, and the **Notice of Completion of Construction** to the District Permits Coordinator and the DCE or designee.

8.2.7 Special Requirements of National Pollutant Discharge Elimination System (NPDES)

(A) Project Administrator Responsibilities

The State of Florida Department of Environmental Protection Generic Permit for Storm Water Discharge from Large and Small Construction Activities contains specific

management and reporting activities. The PA must ensure that all subcontractors that are conducting construction activities at the site, including but not limited to, installing, maintaining, and inspecting erosion control items, environmental sampling and testing activities, earthwork, dewatering, paving, etc. must sign the certification statement, **Contractor Certification - NPDES Generic Permit for Storm Water Discharges From Construction Sites, (Form No. 650-040-07)**. Under no circumstances shall any earth be disturbed until the contractor certification forms are signed. If the Contractor or any subcontractor refuses to comply with the requirements of the erosion and sediment control plan, the specifications, or to sign the required certification, the PA must notify the DCE or designee and document all deficiencies associated with environmental compliance as described in the Contractor's Past Performance Rating System described in **Chapter 13.1** of **CPAM**.

The PA shall request verification of and familiarize themselves with all documents associated with the Contractor's NPDES permit. Including the NPDES Generic Permit (CGP), the Contractor's Notice of Intent (NOI), the project specific Stormwater Pollution Prevention Plan (SWPPP), any updates to the SWPPP, the project specific Erosion and Sediment Control Plan, and the Notice of Termination (NOT). Additionally, the Project Administrator shall verify that the Responsible Authority, any Duly Authorized Representative designation letter(s), and all Qualified Stormwater Inspector(s) are submitted and obtained in accordance with the permit.

The PA will verify that the Contractor posts a copy of the NOI, and copies of other applicable permits, in a prominent location on the construction site that is accessible for public viewing in accordance with permit requirements and conditions.

The PA shall forward copies of the Contractor's NOI, the Florida Department of Environmental Protection's acknowledgement letter, the Notice of Termination (NOT), the qualified stormwater inspectors certifications, and the Delegation of Authority Letter and the SWPPP Sub-Contractor Certification Form (650-040-07), if applicable to the DCE or designee, the District Permits Coordinator, and the District NPDES Coordinator in accordance with Section 2.6 of the NPDES Generic Permit.

When contamination notes, markings, or MSP related to NPDES dewatering activities are presented in the Plans, the PA shall ensure the Contractor and their subcontractors coordinate construction and permitting efforts in the designated areas with the DCIC and CAR Contractor, as directed.

The PA is responsible for verifying that all identified deficiencies are documented in the **Daily Work Reports** and corrected by the Contractor in a timely manner, in accordance with the permit requirements, and the applicable specifications.

(B) Construction Engineer Responsibilities

The DCE or designee will furnish a copy of the Contractor's completed **Storm Water Pollution Prevention Plan (SWPPP)**, the required certification statements, and the site specific Erosion and Sediment Control Plan to the District Permits Coordinator.

The DCE or designee shall notify the District Permits Coordinator of any changes in the project that may affect the potential for discharges of pollutants to waters of the State. The following situations may require amendments to the SWPPP and notification to the District Permits Coordinator for possible permit modifications:

- 1) Changes in design, construction, operation, or maintenance activities; or
- 2) Addition of new discharge points (outfalls), changes in the location of the existing discharge points (outfalls), or when controls identified in the plan prove to be ineffective in preventing or controlling discharges of pollutants to the waters of the State;
- 3) Identification of a new Contractor or subcontractor(s) who will implement a part of the **SWPPP**.

Note: For projects not requiring a **Storm Water Pollution Prevention Plan (SWPPP)**, the DCE (or designee) will furnish a copy of the contractor's site specific Erosion and Sediment Control Plan to the District Permits Coordinator.

8.2.8 Special Requirements for the Code of Federal Regulation Title 40 Part 112 (Oil Pollution Prevention)

(A) Project Administrators Responsibility

Title 40 Code of Federal Regulations Part 112 (40 CFR 112) administered by the Environmental Protection Agency (EPA) entitled Oil Pollution Prevention, contains specific management and reporting activities for the above-ground, bulk storage of oil.

The PA must ensure that all Contractors are aware of this regulation. The Contractor and each subcontractor shall account for all regulated bulk oil containers within the project limits for the duration of the project. All above-ground oil storage containers with a capacity of 55 gallons or greater shall be accounted for and if at any time the aggregate capacity of the above-ground oil storage tanks exceeds the 1,320 gallon threshold, the Contractor must prepare and implement a Spill Prevention Control and Countermeasure (SPCC) Plan in accordance with 40 CFR 112 (This does not include “motive power” or “onboard” fuel containers used primarily to power the movement of equipment). The implementation of the SPCC Plan shall be documented including the required inspections and made available for review in accordance with 40 CFR 112. If at any time the above-ground oil storage containers capacity, within the project limits, exceed the 1,320 gallon threshold the PA shall request a copy of the SPCC Plan to ensure the plan requirements set forth in 40 CFR 112 are met.

If the Contractor or any subcontractor refuses to comply with the 40 CFR 112 or the required SPCC Plan, the PA must notify the DCE or designee and document all deficiencies associated with environmental compliance as described in the Contractor’s Past Performance Rating System defined in **Chapter 13.1** of **CPAM**.

8.2.9 Reporting Requirements under Section 403.077, Florida Statutes

(A) Project Administrators Responsibility

Section 403.077, F.S., entitled Public Notification of Pollution, contains specific management and reporting activities for the public notification of a reportable pollution release. During the project Preconstruction conference, the PA shall notify all Contractors of this regulation and the related reporting requirements to Florida Department of Environmental Protection and/or the Division of Emergency Management State Watch Office. Any Contractor or sub-contractor responsible for a reportable pollution release is required to notify the public in accordance with the above referenced statute. The Contractor must provide copies of any public notification documents to the PA.

If the Contractor or any subcontractor refuses to comply with section 403.077, F.S., the Project Administrator must notify the DCE or designee and document all deficiencies associated with environmental compliance as described in the Contractor’s Past Performance Rating System in **Chapter 13.1** of **CPAM**.

If the Contractor fails to report a qualifying spill, the PA shall ensure that the spill is reported to the DCE or designee and the District Contamination Coordinator for reporting in accordance with section 403.077, F.S.

8.2.10 REPORTING AND ENFORCEMENT

- (1) Environmental issues that arise or are discovered during construction, whether covered by the contract documents or not, require immediate attention and action.
 - a) If environmental noncompliance conditions are discovered (such as runoff causing siltation of environmentally sensitive or protected areas, or violations of permit conditions) and the Contractor does not immediately take action to correct the problem, a stop work order should be issued to the Contractor for those activities causing the problem. The PA should notify the DCE or designee, Operations Engineer, District Environmental Administrator, District Permits Coordinator, and the appropriate Regulatory Agency immediately upon discovery of the violation. After consulting with the DCE or designee, the Operations Engineer, and the District Environmental Administrator (if available), a stop work order should be issued no later than 48 hours after discovery of the violation if the Contractor fails to implement corrective actions.
 - b) The Project Administrator should seek an effective solution by requesting assistance from the DCE or designee, the District Permits Coordinator, the District Environmental Administrator, or other district unit. The District can seek additional assistance from the State Construction Office, Office of General Counsel, and/or the Office of Environmental Management.
- (2) If the Contractor fails to comply with any federal and state environmental regulations, including permits conditions, and does not promptly (within 24 hours) identify and initiate the corrective actions for all deficiencies on the project site, the PA will document all environmental noncompliance in the Contractor Past Performance Rating system described in **Chapter 13.1** of the **CPAM**.

Section 8.3

OPERATION WITHIN RAILROAD RIGHT OF WAY

8.3.1 Purpose

To describe requirements and procedures involving Department operations that take place within Railroad Company right-of-way and/or involve the construction or reconstruction of a rail or highway grade crossing and/or signals.

8.3.2 Authority

[Section 20.23\(3\)\(a\), Florida Statutes](#)

[Section 334.048\(3\), Florida Statutes](#)

8.3.3 References

Sections 7-11.4 and 7-13, Standard Specifications for Road and Bridge Construction

8.3.4 Plans for Track Embankment Protection

To obtain uniformity in administrative procedures for processing Contractor's detailed plans for track embankment protection within the railroad right of way, the following sequence must be followed.

(A) Resident Level Responsibilities

- (1) The Contractor submits required plans to the Project Administrator as a result of instructions defined in plan notes and preconstruction conference.
- (2) The Project Administrator submits the Contractor's plans directly to the District Structures Engineer (Design), District Geotechnical Engineer, and District Rail Office, with a copy of the transmittal letter to the District Construction Engineer.

(B) District Level Responsibilities

- (1) The District Structures Engineer (Design) approves or rejects the Contractor's plans based on the input from the District Geotechnical Engineer and the District Rail Office. If approved, the District Structures Engineer will distribute them according to

District requirements. If rejected, the plans will be returned to the Contractor for correction and reprocessing.

8.3.5 Advance Notification

Resident Level Responsibilities

The Contractor shall provide the Department's Project Administrator and the District Rail Office, and the authorized Rail Company representative at least 72 hours advance notice of his intent to do any work within the railroad right of way or of any operation requiring the movement of employees, trucks or other equipment across the tracks at other than a public crossing. The Project Administrator is responsible for ensuring that the Contractor adheres to the schedule established by the 72 hours advance notification.

In most cases, the Engineer and District Rail Office requires a notification of at least a 45-day advance notice for the flagging services and railroad right-of-way access. The notification should be given prior to the Contractor performing any work within the railroad right of way or the adjoining 15 feet due to the bidding process for flagman services.

Specific rail company requirements can be found in section 7-11.4.2 of the [Standard Specifications for Road and Bridge Construction](#).

8.3.6 Liability Insurance

Resident Level Responsibilities

At the preconstruction conference or prior to work within the railroad right-of-way, the Contractor shall provide one original and one copy of the following to the Project Administrator, the District Rail Office and the Railroad Company:

- Contractor's Railroad Protective Insurance policy
- Contractor's Certification of Public Liability and Property Damage Liability Insurance

No work which affects the railroad will be allowed until both the railroad policy and the certificate have been approved by the Railroad Company or Companies involved for the time specified. Railroad Company approval of the railroad policy and the certificate may take up to two weeks.

Section 7-13 of the **Standard Specifications** includes more information on insurance requirements that may apply.

8.3.7 Watchman or Flagman Services

Resident Level Responsibilities

When protective services, such as watchmen or flagmen, are needed to ensure the safety of the railroad operations during Contractor activities within the railroad right-of-way, the Railroad Company will furnish such services. The Department will reimburse the Railroad Company for all valid charges. Project personnel will record on the daily work report all times during which a flagman was needed and present and submit weekly to the District Rail Office.

The Contractor shall schedule work in an effort to minimize the need for protective services by the Railroad Company and as further noted in the plans. In addition, the Contractor shall submit construction schedules and schedule changes to the Engineer and District Rail Office which include an estimated start date, weekly construction schedule, daily hours of operation, and the calendar day duration for which flagging services will be necessary to perform work activities within railroad right-of-way in accordance with **Section 8-3** of the **Standard Specifications**

When a flagman is being used, the Contractor shall provide, through the Project Administrator and the District Rail Office, to the Railroad Company at least the minimum notice required by the Railroad Company when the flagman's services will no longer be needed. Railroad Company notification requirements for ending flagman services vary by Railroad Company. The railroad must be given the minimum required notice or the Department will pay for the railroad's flagman until appropriate notice is given.

8.3.8 Advance Warning Signs, Pavement Markings, and Traffic Control Devices

All traffic control devices shall conform to the Manual on Uniform Traffic Control Devices.

During the entire period of construction operations at railroad crossings, it shall be the Contractor's responsibility to maintain in a satisfactory and clearly legible condition, the advance warning signs that are normally installed by railroad or state forces (Sign No. W10-1). When such signs are not to be installed by railroad or state forces, the Contractor shall install and properly maintain adequate temporary advance warning signs furnished by the Department. Refer to Standard plans [Index 509-070 for Railroad Grade Crossing Traffic Control Devices](#).

8.3.9 Reporting Requirements

(A) District Level Responsibilities

The **Notice of Utility Construction Work, [Form No. 700-010-48](#)**, has been developed for giving notification of construction work accomplished by Railroad Companies under terms of a Reimbursable Agreement. It must be used on all projects involving work by Railroad Company forces and/or their contractor. This form will be completed by the District Rail Office and distributed at the beginning and completion of reimbursable work.

When the reimbursable work is being performed other than in conjunction with highway construction, the coordinate the placement of markings and signs through the maintaining agency. The District Rail Office may assist with obtaining locates from the Railroad Company for railroad signal cabling prior to sign placement or request additional signage be added, if needed.

Section 8.4

SHOP AND ERECTION DRAWINGS PROCESS

8.4.1 Purpose

To make Construction Engineering and Inspection (CEI) staff aware of their responsibilities with regard to administration of the construction project shop and erection drawing process.

8.4.2 Authority

Section 20.23(3)(a), Florida Statutes

Section 344.048(3), Florida Statutes

8.4.3 Reference

Section 5, Control of the Work, Standard Specifications for Road and Bridge Construction

8.4.4 Responsibilities

(A) Resident Level Responsibilities

This process primarily involves the Contractor, Engineer of Record (EOR), CEI staff as well as District Design and/or Central Office staff and is governed by **Standard Specification 5-1.4** and the **FDOT Design Manual, Number 625-000-002, Chapter 267, Shop Drawing Submittals**.

CEI staff ensure that the parties involved perform timely reviews as well as track submittals through each stage of review and approval. CEI staff should remind the Contractor that **Specification 5-1.4** requires the submittal of a schedule of shop drawing submittals within 60 days of the start of the contract. A standing agenda item for discussion of the status of shop and erection drawings should be part of weekly construction progress meetings. Also at the meeting, the priority of submittals should be reviewed and adjustments to priorities agreed upon with the Contractor.

CEI staff shall ensure that all approved shop and erection drawings are incorporated in the final As-Built drawings where appropriate.

8.4.5 Flow of the Process

(A) Resident Level Responsibilities

The *FDOT Design Manual, Number 625-000-002, Chapter 267, Shop Drawing Submittals, Figures 267.11.1 through 267.11.4* are process flow charts that start from the time submittals leave the originator to the time that approved submittals are sent to the parties that require copies. *Figure 267.11.1* charts the process for projects that require EOR review but do not require a review by the Department; *Figure 267.11.2* charts projects that require both EOR and Department review; and *Figure 267.11.3* charts projects that require only Department review. The Project Administrator shall consult the District Structures Design Office prior to the preconstruction conference to determine which process will apply to the project and the Contractor shall be informed of this at the preconstruction conference. For typical projects, the CEI staff receives copies of submittal transmittal letters from the groups involved in the process in order to track the progress of submittal reviews. With this arrangement, CEI staff does not receive the actual submittals until the process is complete but is aware of where they have been sent and who has possession. CEI staff shall confirm receipt of submittals by the various parties involved to track their location and review duration. The approving Engineer of Record or (when required), the Department Design Office (District or State), makes the final distribution of approved submittals.

For projects that are complex and/or have a large volume of shop drawings for which approval is on the critical path of the project, CEI staff should consider direct handling of all submittals to maintain control over the transmittal process. In this case, the Contractor would send submittals to the CEI staff and not to the Engineer of Record. The CEI staff would then transmit the submittals to the Engineer of Record and (when required) to the Department. Reviewed submittals are returned to the CEI for final distribution or returned to the originator to address review comments (see *FDM 267.11.4*).

8.4.6 Tracking Logs

(A) Resident Level Responsibilities

CEI staff shall maintain a current tracking log. The tracking log shall contain the following information. Other information may be added as necessary:

- 1) Submittal/Transmittal Number.
- 2) Submittal Description: Example - Seawall Layout Drawing Number 5.
- 3) Date the Contractor transmitted the submittal.
- 4) Engineer of Record review status: This is an indication of what the results of the review are, such as: Approved, Approved as Noted, Approved as Corrected, Revise and Resubmit, Not Approved.
- 5) Date the Engineer of Record submitted to the Department Design Office (when required).
- 6) Department Design Office review status (when required): This is an indication of what the results of the review are as listed in item 4 above.
- 7) Date the Engineer of Record or when required the Department Design Office, sent the submittal back to the Contractor.
- 8) Total duration of the review.
- 9) Comments: These may have to do with involvement of reviewers that are not usually part of the process, supplementary documents, final distribution of submittals to specific recipients, and any other information that warrants documentation due to some unique circumstance of the specific submittal being reviewed.

Section 8.5

CONTRACT DELINQUENCY

8.5.1 Purpose

To provide an efficient, uniform method for identifying, monitoring, and acting upon delinquent contracts to encourage Contractors to concentrate their manpower and equipment on their delinquent contracts.

8.5.2 Authority

Sections 20.23 and 334.048(3), Florida Statutes (F.S.)

8.5.3 References

Sections 120.57 and 337.16, F.S.

Rule 14-22.012, Florida Administrative Code (F.A.C.)

Standard Specifications, Section 8-8.2

8.5.4 Definition

Refer to the Introduction section of this *Manual*.

8.5.5 Contractor Delinquency Report

District Level Responsibilities

Delinquent contracts are identified on the **Contractor Delinquency Report**. A preliminary **Contractor Delinquency Report** is emailed to the District Construction Engineers (DCE) each month by the Systems Section of the Office of Construction.

- 1) Each DCE or a designee (Assistant DCE) will review the projects in their District appearing on the **Contractor Delinquency Report**, as well as any additional delinquent District contracts, within three (3) working days of receipt of the preliminary **Contractor Delinquency Report**.
- 2) The District Construction Engineer makes recommendations for agency actions in a memorandum or electronic mail message to the Director, Office of Construction. Recommendations for actions on delinquent District contracts will be included.

8.5.6 Delinquency Notices

Central Office Level Responsibilities

Delinquency Notices for all Department construction contracts, including District contracts, will be prepared by the Office of Construction to ensure uniform and consistent criteria for those actions, and signed by the Secretary of the Department of Transportation since they represent final agency actions. The Secretary of the Department has delegated to the Chief Engineer the authority to sign the **Delinquency Notice**. The **Delinquency Notice** will be sent via Express Mail, "next day delivery", and Email with *Delivery/Read Receipt Requested*.

Delinquency Notices may be issued by the Office of Construction when the allowable contract time for performing the work has expired and the contract work is not complete.

8.5.7 Suspension of Certificate of Qualification

Central Office Level Responsibilities

A **Delinquency Notice** shall inform the Contractor of the Department's intent to suspend the **Certificate of Qualification** of the Contractor and its affiliates to bid on Department projects.

- (1) The written notice shall contain:
 - a) The specific facts which show that the Contractor is delinquent and which justify the suspension.
 - b) A statement that within ten (10) days of receipt of the notice of intent to suspend, the Contractor has the right to request an Administrative Hearing pursuant to **Section 120.57, F.S.**, by filing a written request with the Clerk of Agency Proceedings. The Contractor's request for hearing shall be in writing

and shall be filed with the Clerk of Agency Proceedings, Mail Station 58, Haydon Burns Building, 605 Suwannee Street, Tallahassee, Florida 32399-0458 within ten (10) days of receipt of the notice of intent to suspend.

The request for hearing shall include:

- The name and address of the party making the request.
 - A statement that the party is requesting a formal hearing. **Florida Statutes** require a formal proceeding whenever the proceeding involves a disputed issue of material fact, unless waived by all parties. Department policy is not to waive a formal proceeding in any case involving a disputed issue of material fact.
 - All specific facts and circumstances that the Contractor believes legally excuse the unsatisfactory progress on the project.
- c) A statement that the suspension shall be conclusive and final agency action if no request for a hearing is filed with the Clerk of Agency Proceedings within ten (10) days of receipt of the notice of intent to suspend.

If the Contractor fails to file a request for hearing within ten (10) days of receipt of the notice of intent to suspend, the suspension shall become conclusive and final agency action, and the period of suspension of the **Certificates of Qualification** of the Contractor and its affiliates shall begin on the eleventh (11th) calendar day following the Contractor's receipt of the notice of intent to suspend, and shall continue as set forth in **Rule 14-22.012, (F.A.C.)**.

If the Contractor files a timely request for hearing, the hearing shall be held within thirty (30) days after receipt by the administrative law judge of the request for hearing. The recommended order shall be issued within fifteen (15) days after the hearing.

If the Contractor is determined to be administratively delinquent, the **Certificates of Qualification** of the Contractor and affiliates shall be suspended for a period as set forth in **Rule 14-22.012, F.A.C.**, even if the delinquency is cured during the pending administrative proceedings.

The suspension shall begin on the date of the final order and run continuously for the number of days the Contractor is determined to be delinquent as set forth in **Rule 14-22.012, F.A.C.**

8.5.8 Administrative Hearings

District Level Responsibilities

The District Construction Engineer and any necessary support staff will be required to defend the Department's position at any administrative proceeding pertinent to a declaration of delinquency by the Department.

8.5.9 Period of Suspension of Certificate of Qualification

When a Contractor is declared administratively delinquent, the period of suspension of the **Certificates of Qualification** of the Contractor and affiliates to bid on Department projects due to a final declaration of delinquency shall be for a period of time equal to the number of days between the calendar day that the allowed contract time expired and the calendar day of final acceptance of the work by the Department, plus additional days as may be required by **Section 337.16 (1)(c), F.S.**

8.5.10 Conditions of Suspension of Certificate of Qualification

During the period of suspension of the **Contractor's Certificate of Qualification**, the Contractor and affiliates may not bid on any Department contract, regardless of dollar amount, nor be a subcontractor on any Department contract.

8.5.11 Work Progress Schedule

Resident Level Responsibilities

The Project Administrator will ensure that each Contractor submits to the Department, on a prescribed form, an acceptable work progress schedule for the project, showing in detail the working days on which he expects to begin and complete each of the various major items of work.

It is also important that when a contract time extension is granted or a significant amount of time is authorized by Supplemental Agreement, the Contractor be required to submit a revised work progress schedule for acceptance by the District Scheduling Engineer or Resident Engineer.

8.5.12 Contractor Suspension Report

Central Office Level Responsibilities

The Office of Construction has developed and will maintain the Contractor Suspension Application and a copy of the **Contractor Suspension Report** will also be posted on the Office of Construction website. The Suspension Application identifies those Contractors whose Certificate of Qualification to bid on Department projects is currently or has previously been suspended, either due to the delinquent condition of a project or for other reasons which constitute good cause as per **Section 337.16, F.S.**

This historical record of certificate suspensions will be used by the Office of Construction in administering **Section 337.16(1)(c), F. S.**, which provides for an additional period of suspension of a **Contractor's Certificate of Qualification** to bid on Department projects as a result of repeated suspensions.

District and Resident Level

The Contractor Suspension Application allows all Districts to browse the entries and to request a printout of the current **Contractor Suspension Report**.

Section 8.6

CONTRACT DEFAULT

8.6.1 Purpose

To establish the definition of default and reasons for declaration of default as applied to all construction contracts entered into between the Department and Contractors; to establish remedies for completion of the defaulted contract; to establish cost liability and damage assessments; to establish details necessary for the pursuit of default proceedings.

8.6.2 Authority

Sections 20.23(43)(a) and 334.048(3), Florida Statutes (F.S.)

8.6.3 Reference

Sections 120.57, 337.16(2), 337.18, F.S.

Florida Administrative Code (F.A.C.) 14-22

Article 8-9, Standard Specifications for Road and Bridge Construction

8.6.4 Default Provision

The Department shall provide in its contracts for the determination of default on the part of any Contractor and on the part of any Surety for cause attributable to such Contractor or Surety.

8.6.5 Reasons for Default

The Department will give notice in writing to the Contractor and its Surety of delay, neglect, or default, due to reasons stated in ***Standard Specifications, Article 8-9***.

8.6.6 Recourse and Remedies

If the Contractor, within a period of ten (10) calendar days after receiving the notice described above, fails to correct the conditions of which complaint is made, the Department shall, upon written certification from the Engineer of the fact of such delay,

neglect or default, and the Contractor's failure to correct such conditions, have full power and authority, without violating the contract, to take the prosecution of the work out of the hands of the Contractor and to declare the contract in default.

Upon declaration of default, the Department shall look to the Surety to provide a completion Contractor to complete the work. If the Surety refuses to complete the work, becomes unacceptable or unreliable in satisfactory completion of the work, the Department will have full power to appropriate or use any and all materials and equipment on the site which are suitable and acceptable, and may enter into an agreement with others for the completion of the work under the contract, or may use other methods which in the opinion of the Engineer are required for the completion of the work in an acceptable manner.

If after the ten (10) day notice period, and prior to any action by the Department to otherwise complete the work under the contract, the Contractor should establish its intent to prosecute the work in accordance with the Department's requirements, the Department may elect to permit the Contractor to resume the work.

A Contractor declared in default by the Department does not have hearing rights pursuant to **Section 120.57, F. S.** for challenging the Department's declaration of default.

8.6.7 Cost Liability

All costs and charges incurred by the Department because of the Contractor's default, including the costs of completing the work under the contract, shall be charged against the Contractor and the Surety. In case the expense incurred by the Department is less than the sum which would have been payable under the contract if it had been completed by the defaulting Contractor or the Surety, the defaulting Contractor or the Surety shall be entitled to receive the difference. In case the expense exceeds the sum that would have been payable under the contract, then the Contractor and the Surety shall be liable for the amount of the excess.

In the event the Department elects to permit the defaulting Contractor to resume the work, any costs to the Department incurred by the delay, or for any reason attributable to the delay, will be deducted from any moneys owed the Contractor or which may become due under the contract.

The Department shall have no liability for anticipated profits for unfinished work on a contract that has been determined to be in default.

8.6.8 Determination of Number of Days of Default

For all contracts, regardless of whether the contract time is stipulated in calendar days or working days, default days shall be counted in calendar days.

8.6.9 Liquidated Damages During Default

Should the Contractor or, in case of its default, the Surety fail to complete the work within the time stipulated in the contract, or within such extra time as may have been granted by the Department, the Contractor or, in case of its default, the Surety shall pay to the Department, not as a penalty but as liquidated damages, the amount due as determined by ***Standard Specification, Article 8-10.2***.

In case of Contractor default and completion of the work by the Department, the Contractor and its Surety shall be liable for the liquidated damages under the contract, but no liquidated damages shall be chargeable for any delay in the final completion of the work by the Department due to any unreasonable action or delay on the part of the Department.

Permitting the Contractor to continue and to finish the work, or any part of it, after the expiration of the contract time allowed, including extensions of time granted the Contractor, shall in no way act as a waiver on the part of the Department of the liquidated damages due under the contract.

8.6.10 Termination of Contractor's and Surety's Responsibility

The contract will be considered complete when all work has been completed and has been accepted by the Department.

8.6.11 Default Proceedings

(A) District Level Responsibilities

Since the primary responsibility for the implementation of the Department's transportation programs has been delegated to the Districts, each District Construction Engineer will be responsible for identifying conditions of delay, neglect, or default on the projects in his/her district. After consulting with the District Director of Operations, the District Construction Engineer will recommend that the Director, Office of Construction sends a ***Notice of Default*** to the Contractor.

The District Construction Engineer will keep the Director, Office of Construction apprised of developments on such project during the ten-calendar day periods.

(B) Central Office Level Responsibilities

In conjunction with its monitoring function to ensure uniform compliance and quality performance by the Districts, the Office of Construction will review the Districts' recommendations in regard to declaration of default, consult with legal counsel, and issue the written notice of intent to default to the Contractor and its Surety.

If the Contractor, within ten (10) calendar days after receipt of the **Notice of Intent to Default**, does not correct the conditions of which complaint is made, final Agency action, in the form of a written **Notice of Default**, taking the prosecution of the work out of the hands of the Contractor and declaring the contract in default, will be issued by the Chief Engineer or designee.

If the Surety becomes unacceptable or unreliable in satisfactory completion of the work, the Director, Office of Construction will issue a written **Notice of Intent to Default** to the Surety. And if the Surety, within ten (10) calendar days after the Notice of Intent to Default, does not proceed to correct the conditions of which complaint is made, final Agency action, in the form of a written **Notice of Default**, taking the prosecution of the work out of the hands of the Surety and declaring the Surety as unacceptable and unreliable, will be issued by the Chief Engineer or designee.

The Department shall refuse to accept as a Surety on subsequently awarded contracts, to any company, that it deems to be unreliable or otherwise unsatisfactory as a result of its actions on a previously awarded contract.

8.6.12 Suspension of Certificate of Qualification

Department **Rule 14-22, Florida Administrative Code (F.A.C)** allows the Department to suspend, for a specified period of time, or revoke, or deny for good cause, any Contractor's qualification to bid. A suspension, revocation, or denial for good cause shall prohibit the Contractor from bidding on any Department contract regardless of the dollar amount of the bid, and from acting as a material supplier, subcontractor or a Consultant on any Department contract or project during the period of suspension, revocation, or denial. Good cause shall include if the Contractor defaults on any Department contract or the contract surety takes over any Department contract from the Contractor.

Central Office Level Responsibilities

A notice of the Department's intent to suspend, revoke, or deny any Contractor's qualification to bid on Department contracts as a result of default on a previously awarded contract is subject to the Contractor's right to request an Administrative Hearing pursuant to **Section 120.57, F.S.** and Department **Rule 14-22 F.A.C.**

- (1) The written notice shall contain:
 - (A) The specific facts relied upon to show that the Contractor has defaulted on a Department contract, justifying the suspension.
 - (B) A statement that within ten (10) days of receipt of the **Notice of Intent** to suspend, the Contractor has the right to request an Administrative Hearing pursuant to **Section 120.57, F.S.**, by filing a written request with the Clerk of Agency Proceedings. The Contractor's request for hearing shall be in writing and shall be filed with the Clerk of Agency Proceedings, 605 Suwannee Street, Tallahassee, Florida 32399-0458 within ten (10) days of receipt of the notice of intent to suspend.

The request for hearing shall include:

- The name and address of the party making the request.
 - A statement that the party is requesting a formal hearing. Florida Statutes require a formal proceeding whenever the proceeding involves a disputed issue of material fact, unless waived by all parties. Department policy is not to waive a formal proceeding in any case involving a disputed issue of material fact.
 - All specific facts and circumstances that the Contractor believes legally excuses him from the Department's determination of default.
- (C) A statement that the suspension shall be conclusive and final agency action if no request for a hearing is filed with the Clerk of Agency Proceedings within ten (10) days of receipt of the notice of intent to suspend.
 - (D) If the Contractor fails to file a request for hearing within ten (10) days of receipt of the notice of intent to suspend, the suspension shall become conclusive and final Agency action.

- (E) If the Contractor files a timely request for hearing, the hearing officer shall hold a hearing within thirty (30) days of receipt of the request for hearing. The officer shall complete and submit to the Agency and all parties a recommended order within fifteen (15) days after the hearing.

8.6.13 Contractor Suspension Report

A list of Defaulted Contractors whose Certificates of Qualification has been suspended or revoked, and unacceptable Sureties will be shown in the Contractor Suspension Application maintained by the Office of Construction, and made available on the Office of Construction website at the following hyperlink.

<https://www.fdot.gov/construction/legal/NewSuspension.shtm>

Section 8.7

CONTRACTOR NON-RESPONSIBILITY FOR CONSTRUCTION CONTRACT

8.7.1 Purpose

To provide guidance for complying with Florida Administrative Code Rule 14-22.0141, Contractor Non-responsibility.

8.7.2 Authority

Section 20.23(3)(a) and 334.048(3), Florida Statutes (F.S.)

8.7.3 References

Section 337.16(2), F.S.

Rule 14-22.0011 and 14-22.0141, Florida Administrative Code (F.A.C.)

8.7.4 General

The Department considers Contractor performance on construction contracts to be a critical issue. On construction contracts of \$250,000 or less, all Contractors are presumed to be responsible Contractors and allowed to bid if and only if they comply with requirements that are included in the bid package. Contractors who demonstrate an inability or unwillingness to comply with contract requirements in a timely and proficient manner on a project will be declared non-responsible, and their bidding privileges suspended. The Department will review the performance of each Contractor on construction contracts of \$250,000 or less and prepare a **Contractor Past Performance Report, Form No. 700-010-25**. If a Contractor is deemed deficient in performance, that Contractor will be suspended from bidding on all Department projects for a specified period of time.

8.7.5 Declaration of Contractor Non-Responsibility

The Contractor may be declared non-responsible and bidding privileges suspended and, if applicable, Certificate of Qualification revoked when, it is determined by the Department that one of the following applies:

- (a) The Contractor becomes insolvent or is the subject of a bankruptcy proceeding;
- (b) The Contractor defaults on any Department contract or the contract surety takes over any Department contract from the Contractor;
- (c) The Contractor is suspended for good cause from qualification to bid or denied qualification to bid by any public agency;
- (d) The Contractor or affiliate(s) has been convicted of a contract crime within the jurisdiction of any state or federal court within the previous three years;
- (e) The Contractor made or submitted to the Department false, or fraudulent statements, documents, or other submittals in any bid proposal to the Department, any application for a Certification of Qualification, any certification of payment pursuant to **337.11(11), F.S.**, or in any administrative or judicial proceeding;
- (f) The Contractor fails to comply with contract requirements, in terms of payment or performance record, or to timely furnish contract documents as required by the contract or by any state or federal statute or regulation;
- (g) The Contractor wrongfully employs or otherwise provides to any employee or officer of the Department compensation or any pecuniary or other benefit with the intent to influence the employee or officer's official action or judgment;
- (h) The Contractor is an affiliate of a Contractor whose certification of qualification has been suspended or revoked and the affiliate is dependent upon such Contractor for personnel, equipment, bonding capacity or finances;
- (i) The Contractor fails to register motor vehicles that he/she operates in this state pursuant to **Chapter 320, F.S.**; or
- (j) The Department documents instances of poor or unsatisfactory performance, deficient management resulting in project delay or poor quality workmanship as evidenced by a score of 69 or less on the Contractor Past Performance Report.

8.7.6 Determination

(A) Resident Level Responsibilities

If any of the conditions enumerated in 8.7.4 (a) through (j) occur, the Resident Engineer or his designee will review the project circumstances and facts and make a recommendation of non-responsibility to the District Construction Engineer.

(B) District Level Responsibilities

The District Construction Engineer shall review the recommendation made by the Resident Engineer and in the event of concurrence, shall make recommendations for non-responsibility actions to the Director, Office of Construction with all the project circumstances and facts included.

(C) Central Office Level Responsibilities

The Office of Construction shall review the project circumstances and facts and make a recommendation of non-responsibility. The suspension period for non-responsibility shall be determined in accordance with Rule **14-22.012, F.A.C.**

Non-Responsibility notices for all Department construction contracts, including District contracts, will be prepared by the Office of Construction to ensure uniform and consistent criteria for those actions, and signed by the Chief Engineer, or in his absence his delegate (Director, Office of Construction). Non-Responsibility notices will be sent via Express Mail, "next day delivery", and Email, Delivery/Read Receipt Requested.

During the period of suspension the Contractor and affiliates shall not bid on any Department contracts, regardless of dollar amount, nor be a subcontractor or a material supplier on any Department contract.

Any decision by the Department to suspend a Contractor(s) bidding privileges will be provided to the Contractor in accordance with **Rule 28-106.111, F.A.C.** The Department's action will become final unless a timely petition for a hearing is filed in accordance with Rules **28-106.104, 28-106.201, and 28-106.301, F.A.C.**

Section 8.8

STATE ARBITRATION BOARD

8.8.1 Purpose

To enable the personnel of the Florida Department of Transportation to effectively communicate with the State Arbitration Board. The Board was established by the Legislature to facilitate the prompt settlement of claims arising out of construction contracts.

8.8.2 Authority

Sections 334.048, 337.185, and 120.68, Florida Statutes

FHWA Approved: July 28, 2004

8.8.3 Definitions

Claim: For the purpose of this section, a claim is the aggregate of all outstanding claims.

8.8.4 General

The Board is a creation of the Florida Legislature. It is not part of the Department of Transportation and it has the authority to establish its own operating procedures. Therefore, this section includes only those activities required of Department personnel when interacting with the Board. Information and procedures are available on the Florida Transportation Builder's Association's web site, <http://www.ftba.com/>.

8.8.5 Consideration of a Claim

The Board will consider a claim only after the project is final accepted by the Department. The claim must deal only with disputed issues that have been submitted to the other party of the contract and could not be resolved by negotiation.

If a Dispute Review Board (DRB) was constituted for the project, only issues that were heard by the DRB may be submitted to the Board.

Statutory Law requires that the Board arbitrate every contractual claim in an amount up to \$250,000 per contract or, at the claimant's option, up to \$500,000 per contract or, upon agreement of the parties, up to \$1,000,000 per contract. As an exception, either party to the dispute may request binding private arbitration.

(A) District Level Responsibilities

If the Department is filing a claim against a Contractor, the District Construction Engineer will make a request to the Board for an informational package. The Board will then send the forms and a copy of the procedure for initiating arbitration to the District Construction Engineer.

The "Request for Arbitration of a Claim" must be accompanied by a warrant made payable to the Board for the administrative fee established by the Board. The fee schedule is included in the procedure provided by the Board in their informational package.

The Board will set a time and date for the evidentiary hearing and notify the parties at least twenty one (21) calendar days in advance. This notice is sent to the District Director of Operations.

The Board will send a copy of the "Request for Arbitration of a Claim" package to the respondent. Normally, the respondent is the Department. If so, the package is sent to the District Director of Operations. The respondent prepares a rebuttal to the claim package and furnishes a copy to the party requesting arbitration and to each of the members of the Board ten (10) calendar days prior to the date scheduled for the evidentiary hearing. The Director, Office of Construction will be responsible for assuring the Board has an up-to-date list of Directors of Operations and their addresses.

Ascertain from the Contractor if he is going to have a legal counsel present at these proceedings. If so, immediately notify the Chief Civil Litigation Counsel in Central Office, Office of the General Counsel or the District's General Counsel to obtain representation.

The materials provided to the Board must be complete, clear and include all pertinent information.

8.8.6 Evidentiary Hearing and Order

The Board will hold an evidentiary hearing and will meet within sixty (60) calendar days to issue its written Order. The Board will deliver a copy of the Order and a certified copy of the transcript to the District Director of Operations and to the Contractor.

The Board may also transmit an invoice for the Department's prorated share of the court reporting costs. The court reporting costs are to be paid using Receiving Report and Invoice Transmittal – Contracts (RRIT), Form No. 350-060-02.

The original Order of the Board and the certified transcript are to be stored in the project files in the Resident Office.

(A) District Level Responsibilities

If the Department does not plan to appeal the Order, the District must encumber the appropriate funds to comply with the Order and prepare a final estimate to pay the amount of the order, and also specify the appropriate amount of Federal-Aid Participation. The estimate is then sent to the Contractor with a proposed acceptance letter identifying the arbitration number and amount. The Contractor signs the acceptance letter, returns it to the District Final Estimates Office and the Department pays the firm.

8.8.7 Appeal

(A) District Level Responsibilities

There is a narrow basis for appeals as defined in **Section 120.68, Florida Statutes**. If the Department wishes to appeal the Order, the proper forum is through the District Court of Appeals. This must be initiated through your District General Counsel or the Chief Civil Litigation Counsel.

Section 8.9

CONTRACT TERMINATION

8.9.1 Purpose

To establish a uniform procedure for termination of construction contracts entered into between the Department of Transportation (Department) and Contractors.

8.9.2 Authority

Sections 20.23(3)(a), and 334.048(3), Florida Statutes (F.S.)

8.9.3 Reference

Article 8-9, Standard Specifications for Road and Bridge Construction

Sections 120.57, and 337.18, F.S.

8.9.4 Termination Provision

The Department shall provide in its contracts a provision for the determination of termination of any Contractor and unacceptability of any Surety for cause attributable to such Contractor or Surety.

8.9.5 Reasons for Termination

The Department will give notice in writing to the Contractor of termination, for reasons stated in ***Standard Specifications, Article 8-9***.

A Contractor whose contract is terminated by the Department does not have hearing rights pursuant to ***Section 120.57, Florida Statutes***.

8.9.6 Termination Proceedings

(A) District Level Responsibilities

Since the primary responsibility for the implementation of the Department's transportation programs has been delegated to the Districts, each District Construction Engineer will be

responsible for identifying conditions meriting termination on the projects in his/her District. After consulting with the District Director of Operations, the District Construction Engineer will recommend that the Director, Office of Construction send a Notice of Termination to the Contractor.

(B) Central Office Level Responsibilities

In conjunction with its monitoring function to ensure uniform compliance and quality performance by the Districts, the Director, Office of Construction will review the District's recommendations of termination, consult with legal counsel, and provide a recommendation to the Chief Engineer.

The Secretary of Transportation appoints the Chief Engineer as a designee to issue a Notice of Termination of contract.

The Chief Engineer, based on the recommendations of the Director, Office of Construction, will issue the written notice of termination of contract to the Contractor and its Surety.

After the issuance of the Notice of Termination of Contract, the Office of Construction will distribute copies of such notice to the District Construction Engineer, Comptroller, General Counsel, and other appropriate personnel.

Section 8.10

MONITORING EXISTING STRUCTURES AND NOISE ABATEMENT

8.10.1 Purpose

To set forth a procedure to ensure the contractor performs inspection, settlement, vibration, groundwater and noise monitoring in compliance with the Contract Documents and applicable Laws.

8.10.2 Authority

Sections 20.23(3)(a), and 334.048(3), Florida Statutes (F.S.)

8.10.3 References

Section 335.17 Florida Statutes (F.S.)
Title 23, Part 772, Code of Federal Regulation
Sections 108 and 455, Standard Specifications

8.10.4 Scope

The principal users of this document include the State Construction Office (SCO), District Construction Offices (DCO), District Operations Centers, District Materials and Research Offices (DMRO), District Geotechnical Engineer (DGE), the State Materials Office (SMO), and Construction Engineering and Inspection (CEI) firms working for the Department.

8.10.5 General

This chapter emphasizes the enforcement of contract provisions requiring Districts and the State Construction Office to conduct Quality Assurance (QA) reviews of the monitoring of existing structures procedure and noise issues during construction.

8.10.6 Definitions

For the purpose of this procedure, all references to the Project Administrator (PA), the Resident Engineer (RE) or the Project/Program Manager (PM) who oversee Consultant CEI shall be either Florida Department of Transportation (Department) or Consultant personnel, whichever is applicable.

8.10.7 Inspection and Monitoring Plans

(A) Resident Level Responsibilities

The RE (or PA) shall receive the inspection and monitoring plans from the Contractor as required by the Contract Documents. Within two (2) working days, the RE (or PA) shall forward the monitoring plans to the DGE for review and recommendations.

The RE (or PA) shall perform a concurrent separate review of the monitoring plans, incorporate their own comments to the ones received from the DGE, and forward them to the Contractor within two (2) working days of receipt of the DGE's comments.

The RE (or PA) shall upload monitoring plan submittals and DGE's recommendations and comments into the Department's electronic document management system (EDMS), including revisions and addenda within two (2) working days of acceptance of these documents.

At any time during construction, the DGE may recommend revisions to the monitoring plans. The RE (or PA) shall notify the Contractor of the requested revisions within one (1) working day of receiving the recommendation from the DGE. The notification shall contain the reason(s) for requesting revisions on the monitoring plan.

(B) District Materials and Research Office (DMRO) Level Responsibilities

The DGE shall make comments to the RE (or PA) on monitoring plans within five (5) working days of receiving the submittal. In addition, if during construction it is observed that the monitoring plan is not providing adequate information, the DGE may recommend revisions to the monitoring plan.

8.10.8 Inspection and Monitoring

(A) Resident Level Responsibilities

The RE (or PA) must ensure the Contractor performs the monitoring and inspection requirements indicated in the Contract Documents. In addition to the Monitoring of Existing Structures table in the plans, some Contracts include Special Provisions, Technical Special Provisions or Plan notes requiring special monitoring for noise, vibration, settlement, or groundwater monitoring as well as inspection and documentation of adjacent structures. The RE (or PA) must ensure the Contractor performs the settlement, vibration, and groundwater monitoring at the correct locations in accordance with the contract documents and the approved settlement and vibration monitoring plan. The RE (or PA) must ensure the Contractor submits to the CEI office records of settlement, vibration, and groundwater continuously during the monitoring period. When the Contract Documents specify a maximum noise threshold level, the RE (or PA) must ensure the Contractor submits to the CEI Office records of noise measurements on a weekly basis or as otherwise required by the Contract Documents, during the monitoring period. The RE (or PA) must upload the monitoring information into the EDMS within two (2) working days of receiving it from the Contractor.

The RE (or PA) must verify the settlement, vibration, groundwater fluctuation, or noise threshold limits are not exceeded. When any of these limits are exceeded or damage is detected, the RE (or PA) must ensure the Contractor performs a corrective action in accordance with Section 108 of the Standard Specifications. The RE (or PA) shall also notify the DGE and DCE and submit the monitoring records as soon as possible. If the DGE recommends to the RE (or PA) to revise the installation procedures associated with excessive settlement, vibration or damage, the RE (or PA) shall notify the Contractor of this required revision within one (1) working day of receiving the recommendation.

The RE (or PA) shall ensure that the Construction Inspection **QA Critical Requirements** are met. The **QA Critical Requirements** are located at the following web site:

<http://www.fdot.gov/construction/CONSTADM/Guidelist/GuideIndex.shtm>

(B) District Materials and Research Office (DMRO) Level Responsibilities

If after evaluating the data, it is established that the construction activities have produced

damage or movements or vibrations that exceed the thresholds established in the contract documents, the DGE shall issue a notification to the RE (or PA) recommending a revision to the applicable installation procedure. The RE (or PA) shall notify the Contractor of this required revision within one (1) working day of receiving the recommendation.

8.10.9 Noise, Settlement and Vibration Complaints

The RE (or PA) shall review the project construction schedule and the nature of the activities generating noise and/or vibration, which may disturb residents or businesses in the area. Also, there may be working time restrictions (for example, night or weekend work). The RE, PA, and the inspection staff should review and become familiar with these restrictions.

The RE (or PA) shall document any complaints received during construction. Documentation should include, at a minimum:

- a. The nature of the complaint.
- b. The name and address of the individual making the complaint.
- c. The area affected by the problem.
- d. The type of construction operation generating the noise and/or vibration.

Upon receiving any verbal or written complaints for noise, vibration, or settlement, the RE (or PA) shall promptly request the Contractor to address it. In addition, the RE (or PA) shall:

- a. Make sure the Contractor documents the alleged damage and addresses it.
- b. If necessary, request the Contractor to measure and record noise and/or vibration levels, and conduct settlement monitoring.
- c. Review and file any documentation and monitoring report submitted by the Contractor or Contractor's specialty consultant.
- d. Document any corrective action performed by the Contractor.

The RE (or PA) shall review any repeated noise or vibration complaints or any patterns of noise and vibration complaints including verbal complaints, particularly if the complaints are widespread or if a change of construction method is being proposed by the Contractor. The RE (or PA) shall also consider scheduling noise and/or vibration monitoring during construction operations utilizing a specialty consultant or the District Materials Office. Conduct the monitoring at noise and/or vibration sensitive sites or during specific operations for which complaints have been received. In addition, the RE (or PA) shall document any corrective action or modifications undertaken by the Contractor to its construction methods or schedule.

8.10.10 Property Access Requests

The RE (or PA) shall also contact property owners and arrange access to a property for inspection by the Contractor. The RE (or PA) shall prepare letters on behalf of the Department and deliver them to the property owners to allow inspection by personnel engaged by the Contractor. These letters shall be sent via Certified Mail. Property Inspection will be required in the following instances:

- To investigate a complaint by an owner that Contractor's activities have impacted or are impacting a property.
- To perform the inspections required in accordance with Section 108 of the Standard Specifications.

The RE (or PA) shall maintain, in the project files, the letters requesting access to properties and any responses received from the property owners in the project files. When an owner does not respond to a certified letter, the RE (or PA) shall document, in the project files, all attempts made to contact the owner to procure access to the property, including information showing whether the owner responded to the Department's requests.

8.10.11 District Construction Responsibilities

The District Construction Office (DCO) shall perform QA reviews of the Residencies to verify that the Contractor is in compliance with all Contract Documents and with all applicable laws and commitments relating to monitoring existing structures, noise (when applicable) and/or vibration mitigation. The DCO shall notify other appropriate State and Local Government Agencies in the event of complaints or non-compliance.

8.10.12 State Construction Responsibilities

State Construction Office shall perform Process Reviews of the Districts periodically.

8.10.13 Training

None.

8.10.14 Forms

None.

Section 8.11

CONTRACTOR INITIATED SUBMITTALS

8.11.1 Purpose

The purpose of this section is to provide a standard procedure for the processing of Contractor initiated submittals related to the following issues: interpretation of the Contract Documents, notification of Contract Document errors or omissions and pay adjustment or entitlement; modification of Contract Documents initiated by the Contractor; and correction of noncomplying work.

8.11.2 Authority

Section 20.23(3)(a), Florida Statutes

Section 334.048(3), Florida Statutes

8.11.3 References

Section 336.045, Florida Statutes

Procedure No. 375-020-010, Resolution of Errors, Omissions and Contractual Breaches by Professional Engineers on Department Contracts

8.11.4 General

Contractor initiated submittals are routinely received by the Florida Department of Transportation during a construction project and pertain to a variety of issues that fall into three general categories: (1) Request for Information (RFI), (2) Request for Modification (RFM), and (3) Request for Correction (RFC). Refer to **CPAM Introduction** for the definition of these categories. It is the responsibility of the Construction Engineering and Inspection (CEI) staff to process these submittals in a timely and efficient manner and to track the stages of the process through issuance of an official response. These submittals shall be labeled accordingly as RFI, RFM or RFC on correspondence and in tracking logs. A description of the process for each of the three categories follows as well as a description of how submittals shall be tracked. The steps of the submittal process from start to finish for all three categories may vary to a minor degree; however, the contents of a routine

tracking log presented in **CPAM Section 8.11.7** include items that are typical of the process and address most situations.

For an RFI, RFM, or RFC concerning bridge or structures construction issues consult **CPAM Section 10.10** and other relevant Sections in **CPAM Chapter 10** for resolution of such issues.

8.11.5 Request for Information (RFI)

RFI's pertain to issues that are not necessarily the responsibility of the Contractor to resolve such as errors or omissions in the contract documents caused by the Engineer of Record (EOR) or by the Department in preparing the contract documents. There are three general types of RFI's and a description of each follows. The PA may respond to the Contractor without consulting with others such as the EOR or Department staff if their assistance is not needed. However, in some cases, the PA shall consult with the EOR or Department personnel including but not limited to the Construction Project Manager, Resident Engineer/Operations Center Manager or experts in the following offices: District Construction, District Structures Design, District Roadway Design, District Materials, State Construction and State Materials. If the RFI has the potential to be categorized as Errors and Omissions by the Design EOR, the PA shall include the following language: "This issue may impact the overall project cost and contract time and has the potential to be classified as Errors and Omissions, therefore your immediate attention is required. Engineering/inspection services associated with this RFI shall be billable unless premium costs are incurred by the Department and the issue is subsequently determined to be the result of Errors and Omissions." Under certain circumstances, resolution of the RFI will require a Supplemental Agreement to formally revise the contract documents due to errors, omissions or conflicts.

- (1) Contract Document Interpretation:** When a provision, detail or drawing in the contract documents seems to have more than one meaning, have an unclear meaning or have conflicts between plans and specifications, in the opinion of the Contractor, the Contractor shall submit a request to the PA for interpretation of the issue by the Department. The PA may respond back to the Contractor without consulting with others such as the EOR or Department staff if their assistance is not needed; otherwise, the individuals or offices listed above shall be consulted.
- (2) Contractor Identified Errors, Omissions, or conflicts:** When the Contractor identifies errors, omissions or conflicts in the contract documents that may impact the project then they shall be identified in a Contractor submittal sent to the PA for resolution by the Department. This type RFI submittal by the Contractor will not be

considered "**Notice of Claim.**" A **Notice of Claim** must be submitted in accordance with **Specification 5-12.2.** The PA shall notify the Design Project Manager (DPM) and consult with the appropriate individuals or offices identified above in order to determine if there really is an error, omission or conflict and if there is, a Supplemental Agreement to officially revise the contract documents to correct the error, omission or conflict may be required. The Department may not agree that there is an error, omission or conflict which may lead to additional cycles of submittal and response, to DRB action or to a claim. As partners in the project, the CPM, DPM and EOR must work together to resolve these issues as quickly as possible in order to minimize construction interruptions.

- (3) Pay Adjustment or Entitlement:** The Contractor may be entitled to an adjustment of pay or be entitled to pay not previously authorized. When the Contractor identifies one of these cases, a request shall be submitted to the PA that identifies the pay issues in question. The PA may respond back to the Contractor without consulting with others, such as the District Final Estimates Office, if their assistance is not needed, otherwise the appropriate individuals or offices listed above shall be consulted. The Department may not agree that there is a pay issue which may lead to additional cycles of submittal and response, to DRB action or to a claim.

8.11.6 Request for Modification (RFM)

The Contractor may seek to modify the contract documents or certain aspects of it to benefit his or her accomplishing of the work **without diminishing the performance or durability of the finished work.** Such modifications are routine during construction and may be due to constructability issues not foreseen in the contract documents or other such changes that prevent the Contractor from either accomplishing the work or accomplishing it in a timely way. The PA shall consult with the EOR and the Department prior to issuing a response; depending on the nature of the RFM this may include the Construction Project Manager, Resident Engineer/Operations Center Manager, or experts in the following offices: District Construction, District Structures Design, District Roadway Design, District Materials, State Construction and State Materials.

8.11.6.1 Cost Savings Initiative Proposal (CSIP)

A Contractor may seek to significantly modify the contract documents and choose to initiate a formal CSIP to attain cost effectiveness or to enhance the quality of the work, per Section 4-3.9 of the Specifications. CSIPs are to be discussed prior to Contract Time beginning at a CSIP Workshop. CSIPs not identified at the time of the CSIP Workshop require a concept meeting between the Contractor and the Department. If possible, the Contractor

should discuss the proposal with the PA prior to a formal submittal of the CSIP and based on this discussion the PA shall consult with the appropriate experts to determine if the Department is receptive to the CSIP.

If the Department is receptive to the CSIP then the Contractor shall submit the modification proposal along with supporting documents to the PA for processing. The PA shall transmit the proposal package to the appropriate experts for review and response. Department experts involved with the review may request additional supporting information from the Contractor to make a final decision on the proposal and there may be multiple cycles of submittals as a result. The final decision about whether to approve or disapprove the CSIP rests with the District Construction Engineer or District Director of Transportation Operations. If the modification is approved, then a Supplemental Agreement must be processed to officially reflect the changes to the contract documents.

8.11.7 Request for Correction (RFC)

When either the Contractor or the Department identifies noncomplying work that is the fault of the Contractor and that is not an elemental material issue, the Contractor is to submit a request for correcting the noncomplying work. Noncomplying work can be caused by Contractor mistakes or by damage and include some of the following examples: lack of concrete consolidation; chipped, spalled, cracked, dented, or gouged components caused by mishandling; or electrical and mechanical devices that fail to function or perform as specified. The Contractor's correction request shall include supporting documents that may require the involvement of the Contractor's Engineer of Record or a Specialty Engineer and shall be submitted to the PA for processing. The PA will forward the RFC to Departmental personnel for response as appropriate or as dictated elsewhere in the CPAM.

Supplemental sampling, testing, surveying and data collection may be required by Department experts involved with the review and additional supporting information may be requested from the Contractor to make a final decision on the request; multiple cycles of submittals may result. The final decision about whether to approve or disapprove the request shall be made by the District Construction Engineer after considering the recommendations of the EOR and the various supporting offices.

8.11.8 Tracking Logs

The CEI staff shall monitor the progress of Contractor initiated requests by maintaining a continually updated tracking log using an electronic spreadsheet. The spreadsheet should have the appropriate project identification information at the top of the sheet and should be entitled ***Contractor Initiated Submittal Log***. The preferred practice is that each submittal

type (RFI, RFC, RFM) have an individual spreadsheet; however, all three types of submittals may be tracked on the same spreadsheet, but if so, there shall be a spreadsheet column entitled "Submittal Type." CSIPs shall be identified as such in the RFM log. The tracking information for each request received from the Contractor should be entered on the spreadsheet in an individual row: one request, one row. If the reviewers of the request require the submittal of a significant amount of additional information, then the resubmitted information should be treated as a new request with its own row. A spreadsheet shall contain the information that follows for the typical submittal process; however, depending on the project and submittal type, more or less information may be appropriate as determined by the CEI staff.

- 1) **Submittal Type:** Enter RFI, RFM or RFC – this column is not required if an individual spread sheet is used for each submittal type.
- 2) **Request (RFI, RFM or RFC) Number:** A unique sequential number assigned by the CEI staff that identifies the request for ease of tracking.
- 3) **RFI, RFM or RFC Number:** An identification number assigned by the Contractor for internal tracking purposes.
- 4) **Reason for the Request:** Provide a brief reason for the request.
- 5) **In Reference to What Contract Document?** If the request refers to a contract document then its type (standard specification, special provision, standard plans, plans sheet, shop drawing, etc.) and identifier (specification number, sheet number, etc.) shall be listed.
- 6) **Resulted in a plans revision?** If the resolution of the request results in a plans revision, then a YES or NO shall be entered along with the revision number which reminds CEI staff to verify that the revision has been reflected in the as-built plans.
- 7) **Date of Request:** The date on the request as entered by the Contractor and which will usually be the date transmittal by the Contractor to the CEI staff.
- 8) **Date Received:** The date that the CEI staff received the request from the Contractor.
- 9) **Reviewer Identification:** If the CEI staff consults with other reviewers then list reviewer names and, if they work for the Department, the name of the office they work in, or if they work for a consultant, the name of the firm for which they work.

- 10) Date to Reviewer:** The date that the CEI staff sent the request or other information to reviewers (EOR, Department Offices, special consultants, etc.).
- 11) Date from Reviewer:** The date that the CEI staff received responses from reviewers.
- 12) FDOT Approval Date and Name:** The date that a Department official (include the Official's name) approved the response to the Contractor's request as prepared by the CEI staff. This is required if CPAM dictates FDOT consultation or if the CEI opts to involve the Department.
- 13) Contractor Preferred Response Date:** A Contractor established date before which a response to the request is desired by the Contractor from the Department and which should be based on legitimate constraints in the approved schedule. The Contractor should not establish a date that requires a quick response if the decision will not impact an event that is scheduled months or years in advance of the request.

RFIs will be prioritized according to the following matrix:

RFI PRIORITY MATRIX		Complexity/Resolution Time (Determined by CEI & Design)		
		Minor (Review Contract & Answer)	Medium (Minor Research & Answer)	Major (Research & Plan Revision)
Urgency / Schedule Impact (Determined by CEI & Contractor)	Major (Critical Path Impact)	LEVEL 1	LEVEL 1	LEVEL 2
	Medium (Near Critical Path, Mitigating)	LEVEL 1	LEVEL 2	LEVEL 3
	Minor (Not Critical Path)	LEVEL 2	LEVEL 3	LEVEL 3

RFI response time will be based on Priority Level and issues will be escalated according to the following matrix:

Priority Level	Expected RFI Response Time (Working Days)	Issue Escalation Matrix	
		Max. Time (Working Days)	Per Level (Position)
1	2	2	Project (CPM/EOR)
		1	Resident Office (CE/SPE/DPM)
		1	District Office (DCE/DDE)
2	7	7	Project (CPM/EOR)
		3	Resident Office (CE/SPE/DPM)
		1	District Office (DCE/DDE)
3	15	15	Project (CPM/EOR)
		10	Resident Office (CE/SPE/DPM)
		5	District Office (DCE/DDE)

The expected response time for RFMs and RFCs will be the same as specified for shop drawings in Section 5-1 of the Standard Specifications, or as specified in the Request for Proposal for Design-Build projects.

- 14) Response Date:** The date the CEI staff sent the Department's response to the Contractor.
- 15) Elapsed Time:** Time in days from the "Date Received" to the "Response Date."
- 16) Response Description:** A brief description of the Department's response to the Contractor's request including the reasons for approving or disapproving the request.
- 17) Party in Control of the Response:** The name of the party (EOR, Department reviewer, Consultant reviewer, approving official) that is in control of the request because the CEI staff is awaiting their response and which includes CEI staff members. This field may change often during the response preparation period.

Section 8.12

LOCALLY FUNDED AGREEMENTS

8.12.1 Purpose

This procedure defines the Locally Funded Agreement (LFA) projects and outlines the Resident Office's responsibility on these projects.

8.12.2 Authority

[Section 20.23\(3\)\(a\)](#) and [334.048\(3\). Florida Statutes \(F.S\)](#)

8.12.3 References

Procedure No. 350-020-300 Locally Funded Agreements Financial Provisions and Processing

Procedure No. 700-050-005, Review & Administration Manual

Procedure No. 525-010-300, Local Agency Program Manual

8.12.4 General Information

Locally Funded Agreements (LFAs) are legally binding agreements, between the Department and one or more parties, which provide for the rendering of services and/or commodities, involving joint efforts and/or funding, and are mutually beneficial to all parties. The [LFA System - Main Project Search](#) (internal link) can be used to determine if a Financial Identification Number (FIN) contains an LFA. For more information and other requirements on LFAs see **Procedures 350-020-300**. An LFA is not to be confused with other types of contracts, such as:

1. Public Transportation Grant Agreement (PTGA) which used to be titled Public Transportation Joint Participation Agreement; See **PTGA Procedures No. 725-000-005-i**, for more information.
2. Utility Work (See **CPAM 5.6** and the **Utility Accommodation Manual (UAM)** for more information).
3. Local Agency Program (LAP) Projects (See the **LAP Manual Procedures 525-010-300** for more information.)

4. Temporary Signalization
5. Maintenance
6. Other Agreements (Lighting, Signals, Landscaping, etc.)

8.12.5 Resident Office Responsibility

Ensure that the LFA work is built per Plans and that the quantities are as listed on the LFA Plan Summary Sheets or Estimated Quantities Report. The Project Administrator (PA) will receive a monthly Contractor's Request for Payment. The PA is required to enter the quantities into AASHTOWare Project Construction (PrC) as part of the monthly estimate. Communicate with the LFA Agency when changes to work or money need to be made.

The Locally Funded Agreement/Utility Work by Highway Contractor (LFA/UWHC) Closeout Letter is signed by the LFA Agency, Contractor, Resident Office and the Department agreeing on all the final quantities. The Offer Letter is then sent to the Contractor with final quantities for all the projects under that contract. See **CPAM 5.11, Attachment 5-11-02, Letter 5-11-13, LFA/UWHCA Closeout Letter** and **Letter 5-11-02, Offer of Final Payment**

Contact the District LFA Coordinator or responsible party indicated on the completed **Form 350-020-03, Agreement Summary Sheet**, for any questions.

8.12.6 Project Administrator's (PA) Responsibility

The PA will have the Contractor and LFA Agency sign off on the quantities on the LFA/UWHCA Closeout Letter. This process is called the "Reconciliation of the LFA". The **LFA Reconciliation Package** will be included with the **Final Estimates Documentation**.

The **LFA Reconciliation Package** will include the final estimate with pay item numbers highlighted, or a cost breakdown should be prepared by the PA showing all applicable pay items. The pay item unit prices, quantities, pay item dollar totals, and the total dollar cost of the LFA will be shown. Include the Final As-Built Plans, when appropriate.

8.12.7 District Final Estimates Office (DFEO) Responsibility

The DFEO submits the **LFA Reconciliation Package** by email to the General Accounting Office, LFA Section. LFA Staff and their contact information can be found on the [LFA System](#) (internal link).

Section 8.13

PIPE INSPECTION, EVALUATION AND REPAIR

8.13.1 Purpose

To establish a standard procedure to ensure consistent review of all post installation pipe inspections associated with construction projects.

8.13.2 Authority

Sections 20.23(3)(a) and 334.048(3), Florida Statutes (F.S.)

8.13.3 Reference

Section 430 of the Standard Specifications for Road and Bridge Construction

Section 431 of the Standard Specifications for Road and Bridge Construction

Section 948 of the Standard Specifications for Road and Bridge Construction

8.13.4 Review

The Project Administrator (PA) will review all of the equipment, inspection, and reporting criteria for the post installation pipe inspection to ensure compliance with the Standard Specifications. Prior to final acceptance, the PA will evaluate the nature and severity of any observed defects and provide the Contractor with the Department's perspective on pipe repairs.

8.13.5 Preconstruction Conference

Project Administrator Responsibilities

The PA, or their delegate, shall provide a comprehensive review of the equipment, inspection, and reporting criteria found in Section 430 of the Standard Specifications to familiarize the Contractor with all the requirements for the post installation inspection. Discussion topics should include:

- (1) Providing certification statements to the Department from the Contractor doing the work that the laser profiling and measurement technology is in compliance with the calibration criteria found on the Department's website.

- (2) Discussion of all components of the pipe inspection report to be submitted to the Department.
- (3) Providing the Department with a video report in the correct format and resolution.
- (4) Providing the Department with a video recording schedule and ensuring the video images are clear, easy to review, and are correctly identified with their respective project number, structure number, pipe type, and size, and any notes associated with the inspection.
- (5) Ensuring that all pipe runs are dewatered, free of silt, debris, and other obstructions prior to inspection.
- (6) Ensuring the video camera moves through all pipe runs at the speed designated in the Standard Specifications and that all defects are documented in their entirety.

8.13.6 Report Review, Evaluation and Repair Guidance

Project Administrator Responsibilities

The PA, or their delegate, is responsible for reviewing and evaluating the laser profiling and video inspection reports and to ensure the pipe videos and supporting documentation are available electronically in the project files (i.e. Project Solve Sharepoint PSSP and/or EDMS). The PA must ensure that each component of the pipe inspection process is in compliance with the Standard Specifications and completed before the culvert installation can be accepted.

8.13.6.1 Report Review

The PA is responsible for ensuring that the reports submitted by the Contractor meet the criteria found in Section 430 of the Standard Specifications before any defects are evaluated. If the Contractor fails to submit the necessary certifications or reporting requirements, the PA is responsible for contacting the Contractor to inform them that the report submittal does not meet the Standard Specifications. The PA should provide a list of report deficiencies for the Contractor to review. Once the deficiencies have been resolved, the PA can evaluate the amended reports.

8.13.6.2 Report Evaluation

When evaluating defects found in pipe inspection reports, the PA must consider the following policy previously set forth by the Department:

- (1) **Cracking in concrete pipe:** The Department relies on both the American Society for Testing and Materials (ASTM) C 76 and the American Association of State Highway and Transportation Officials (AASHTO) Load and Resistance Factor Design (LRFD) Chapter 27 when evaluating cracks in concrete pipe. Cracks less than 0.01" in width and less than 12" in length should be recorded as an observation but are not candidates for repair unless there is evidence of active infiltration. Any crack exceeding the length and width tolerances must be evaluated by a Specialty Engineer as being acceptable or in need of repair.
- (2) **Stains in pipe:** Stains in concrete pipe are not considered a defect in need of repair unless the stain, is associated with a crack in excess of the tolerances referenced in ASTM C 76 and AASHTO LRFD Chp. 27, is associated with active infiltration regardless of its location or size of crack, or it's associated with any other defect eligible for repair. Stains in aluminized steel pipe shall be evaluated to determine the presence of damage to the aluminized coating. Stains in thermoplastic pipe shall be evaluated to determine the presence of cracking.
- (3) **Infiltration:** The Standard Specifications require that Storm, Cross, and Gutter drains be water tight to 5 psi. If the Contractor has a leaking pipe, and states that the infiltration does not need to be repaired, he must demonstrate that the head pressure generated by the height of the water table exceeds that 5 psi requirement found in the Standard Specifications. If the water table head pressure does not exceed 5 psi at the top of the pipe then all infiltration must be repaired.
- (4) **Joint gaps in optional pipe materials:** The Standard Specifications do not have joint gap tolerances for metal, PVC, Polypropylene, or HDPE pipes. Since there is no joint gap tolerance for these pipe types, the Contractor is not required to repair joints with gaps in them. Repair is limited to hanging gaskets, joint damage, separated joints, and infiltration.
- (5) **Deflection:** All optional pipe materials have a deflection tolerance of 5% or more of the certified actual mean diameter of the pipe. Any pipe with deflections greater than the 5% tolerance must be replaced or repaired at no

cost to the Department. The only repair accepted by the Department is to remove the deflected sections and replace them using field joints.

NOTE: The Department has not adopted ASTM C1840 for the inspection, evaluation, or repair of concrete pipe.

8.13.6.3 Repair Guidance

The Department maintains the expectation that all culvert installations will be defect free and installed in accordance with the Standard Specifications. In the event that a defect is found in a pipe run, the first option of the Department would be to remove and replace the defective pipe at no cost. In situations where this is not practical, then consideration should be given to different repair remedies.

Project Administrator Responsibilities: The PA is responsible for reviewing the proposed repair procedures submitted by the Contractor and coordinating the review of the proposed repairs with the District Drainage Office to ensure hydraulic capacity is maintained. Proposed repair procedures should correspond to the Pipe Repair Matrix as found on the Department's website and the policy previously set forth by the Department. Specifically:

- (1) **Use of Chemical Grout for repair:** The Department does not accept the hand application of grout for pipe repair. All proposed grout repairs must utilize pressurized injection to ensure that the grout completely fills the defect and any voids associated with it.
- (2) **Use of Cured in Place point repairs:** The Department does not accept cured in place point repairs due to quality assurance and maintenance concerns. All point repairs proposed by the Contractor must consist of steel, aluminum, or rubber per Section 948 of the Standard Specifications.

In the event that a Contractor proposes a repair method that is not found on the Pipe Repair Matrix, it must be evaluated and accepted by the State Construction Office prior to use.

Section 8.14

VALUE ADDED FEATURES

8.14.1 PURPOSE

To establish a standard administrative procedure for tracking and monitoring Value Added Features (VAF) for compliance with the contract specifications. The procedure sets forth the responsibilities for inspecting and accepting remedial work (RW) required to bring the features in compliance with the specifications. This procedure is primarily for the use of District Construction and Maintenance personnel responsible for monitoring and tracking VAF. In order to maximize the use of Department resources, the Department's routine Maintenance Inspection Program should be utilized as much as possible for inspections to evaluate projects with VAFs.

This procedure covers all VAF listed below. The VAF have certain procedural steps that are common to all, as well as steps that are unique to each. Therefore, the following includes one subsection for common procedural steps as well as individual subsections for each of the unique steps pertaining to the VAF.

8.14.2 AUTHORITY

Sections 334.048(3) and 20.23(3)(a), Florida Statutes

8.14.3 REFERENCES

The following contract specifications deal with Value Added Features (VAF):

- (1) Specification Section 338, Value Added Asphalt Pavement
- (2) Specification Section 338 B, Value Added Reworked Asphalt Concrete Pavement
- (3) Specification Section 338 C, Value Added Repaved Asphalt Concrete Pavement
- (4) Specification Section 355, Value Added Portland Cement Concrete Pavement
- (5) Specification Section 475, Value Added Bridge Components Design Build Only
- (6) Specification Section 570, Performance Turf
- (7) Specification Section 580, Landscape Installation
- (8) Specification Section 646, Aluminum Poles, pedestals, and Posts

- (9) Specifications Section 715, Highway Lighting Systems
- (10) Specification Section 649, Galvanized Steel Strain Poles, Mast Arms and Monotube Assemblies
- (11) Specification Sections 701, 702, 709, 711 and 713 Traffic Stripes and Markings
- (12) Other Warranty Items

8.14.4 GENERAL

The Districts will designate an individual or individuals from the Operations Center Offices/Residence Construction Offices (OCO/RCO) as the District Warranty Coordinator (DWC). This individual administers the warranty program for the District. The common procedural steps primarily cover the duties of the District Warranty Coordinator (DWC) that must take place prior to the steps unique to each feature.

8.14.5 COMMON PROCEDURE STEPS

(1) The DWC shall develop and maintain a list of projects that have VAFs. The list must be updated by adding projects after award and execution of a project with VAFs. The information gathered for each project must include, at a minimum, the identification of each VAF to be incorporated into the project and contact information for all individuals responsible for administration and performance of the feature. Once a VAF has been identified based on the contract, it can be selected from the pre-defined drop-down menu in the CIM system. The durations for the warranty period for a VAF are pre-loaded by the CIM system based on the warranty duration designated by the specifications.

(2) Project personnel responsible for the administration of the project shall identify and enter the required warranty begin date into the AASHTOware Project Construction (PrC) system prior to or at final acceptance of the project.

(3) Project personnel responsible for the administration of the project shall identify, collect, and enter the required warranty data, including non-VAF and/or manufacturer's warranties, into the CIM system prior to or at final acceptance of the project. Information pertaining to the VAF is identified in the applicable specifications for the contract. The appropriate contact information for each VAF should include the Responsible Party (RP) for the feature as well as the maintenance and construction personnel involved in the administration of the project. Project personnel responsible for entering the warranty information shall notify the appropriate DWC once the information has been entered into the system.

(4) The DWC shall review the VAF data entered into CIM by the project personnel for accuracy and completeness. The DWC shall ensure that any revisions are addressed. The DWC will be responsible for the administration of the warranty throughout the warranty period.

(5) The DWC will be responsible for coordinating with the District and SMO personnel responsible for performing inspections or evaluations of the VAFs. Warranty inspections for the VAF shall, at a minimum, be done at intervals as assigned in the CIM system. The CIM system will automatically notify the DWC of upcoming warranty inspection needs.

(6) The inspections results, for the interim and final inspections shall be input into the CIM system. All comments, reports, and inspection documentation generated during the inspection may be input in the CIM using the General tabs located in the upper right corner of the VAF page. Additional guidance on the use of the CIM system is provided by the "VAF User Guide" located in the upper left corner of the VAF page. Upon completion of the interim or final inspection of the VAF the status of the inspection shall be entered into the system as "COMPLETED" or "ONGOING." The warranty inspections status will be designated as "COMPLETED" when no deficiencies are found and "ONGOING" when deficiencies are detected. The "ONGOING" inspection status will remain until all deficiencies have been corrected.

(7) The DWC will be responsible for coordinating the required remedial work performed by the RP and District personnel responsible for oversight and acceptance of the remedial work.

(8) The DWC will coordinate a final inspection of the VAF to ensure that the final inspection occurs prior to the end of the warranty period. The final inspection is defined in the contract and is to occur in advance of the warranty end date to allow for any administrative actions required under the warranty provisions for the VAF. All notifications for required remedial actions shall be provided in writing to the RP prior to the end date of the warranty period. The DWC will document the RP's receipt of the notification. If corrections are needed for the project, the DWC will manage and coordinate the RW for the feature in accordance with the specifications and this procedure.

(9) For Design Build Projects, the Contractor or the designated RP shall be responsible for the RW for the duration specified in the VAF specifications. The DWC must review the **Request for Proposal (RFP)** and the Contractor's Technical Proposal to determine the actual items and durations covered by the warranty provisions of the contract.

Note: Issues involving concurrence between the District Materials & Research Engineer and District Construction Engineer regarding VAFs or Remedial Work, shall be resolved in accordance with CPAM 5.8.7.

8.14.6 DISPUTE RESOLUTION

The Statewide Disputes Review Board (SDRB), as provided in the appropriate specification, shall be used to resolve disputes that arise on contracts which contain VAFs. An SDRB will be used to resolve all disputes that may develop involving the administration and enforcement of the specifications. The determinations of the SDRB shall be binding on both the RP and the Department, with no right of appeal by either party. The RP will be responsible for requesting and scheduling the SDRB hearing. The DWC will coordinate all aspects of the hearing on behalf of the Department. SDRB decisions shall be sent to the Director, Office of Construction for review.

All correspondence and documentation pertaining to the SDRB proceedings shall be input into the CIM system.

8.14.7 FAILURE TO PERFORM

Should the RP fail to timely submit and schedule a hearing before the SDRB, fail to satisfactorily perform the remedial work, or fail to compensate the Department for any remedial work performed by the Department which is determined to be the responsibility of the RP, the DWC, with concurrence from the DCE, shall provide notification to the Statewide Warranty Coordinator in the State Construction Office (SCO) to initiate the appropriate action in accordance with the specifications.

Upon notification by the District, the SCO will review and initiate the appropriate action pursuant to the terms of the contract. The SCO will review the contract as well as the information provided by the DWC and determine the appropriate action(s) to be taken in accordance with the terms of the contract.

The SCO will initiate available administrative or contractual actions as a result of the RPs failure to perform the contract requirements for VAF.

8.14.8 VALUE ADDED ASPHALT PAVEMENT (Spec. Section 338)

8.14.8.1 Pavement Performance Monitoring Operations

(1) The DWC is responsible for coordinating inspections of the value-added asphalt pavement at intervals as prescribed by the specifications. The CIM system will

automatically notify the DWC of the need for inspections at pre-determined intervals. The CIM system allows additional interim inspections to be scheduled on an as needed basis. Any comments or notations pertaining to observations made during the inspections must be entered into the system using the notes tab on the VAF page. All pertinent documentation pertaining to the inspection/evaluation of VAF shall be entered into the CIM system under the “File” tab as attachments for the inspection.

(2) District inspection personnel must perform periodic inspections by driving through the project and randomly stopping at locations to visually inspect the pavement for any distresses. Pavement deficiencies shall be classified and documented in accordance with the “Category of Pavement” as defined by the Valued Added Asphalt Pavement specifications. The frequency of inspections shall be performed annually (as a minimum). Inspection personnel shall document the inspection results with photographs or video recordings and with sufficient detail to allow the DWC to determine whether further evaluation is required. The inspection results shall be sent to the DWC for review and disposition to the appropriate parties. The DWC will coordinate with the appropriate District Materials Office personnel and other Department personnel as required. All pertinent information and documentation shall be input into the CIM system. When possible, document the location where photographs were taken.

8.14.8.2 Assessment of Pavement Distresses

(1) The Department’s PCS Program, along with observations and inspections by Department personnel, will be used as the basis for determining the extent and magnitude of the pavement distresses that exceed the threshold values defined by the specification. The Department, as a function of Pavement Management Program, annually surveys all highways on the State Highway System. The survey is typically only conducted in the outside lane. The Pavement Management Office analyzes the Pavement Condition Survey information and develops a report annually, providing information for all asphalt warranty projects exceeding the rut threshold. The report is available at the following link:

<http://infonet.dot.state.fl.us/PavementManagement/OnlineReports/performanceInfo.htm>

The Department will perform, at a minimum, annual inspections to monitor the pavement performance throughout the warranty period. If deficiencies are observed during the inspections, the observations shall be documented with sufficient supporting documentation and must be forwarded to the DWC for review. The DWC will determine if further evaluation is required. The District may, based on the visual observations during the interim inspections or the analysis of the annual Pavement Condition Surveys, request a more detailed PCS by contacting the SMO or using the online request form at the following link:

<https://www.fdot.gov/materials/pavement/performance/pcs/index.shtm>

The DWC will be responsible for coordinating inspections during the warranty period. The DWC will notify the RP in writing when a PCS will be conducted.

(2) If the survey is conducted at or near the end of the warranty period, the SMO or DMO must be contacted sufficiently in advance of the expiration date to allow the survey to be conducted and notification (if required) to the RP within the timeframes established in the contract that remedial work will be required. The DWC (or other specific Department personnel) must provide the RP written notification of "Required Remedial Action" prior to the expiration of the warranty period. The DWC will document the RP's receipt of notification. If no deficiencies are observed during the inspections (interim or final) the inspection result must be entered into the CIM system as "COMPLETE" and no further action is required. All documentation produced as a result of the inspections shall be entered into the CIM system. If the inspection reveals pavement deficiencies, the DWC will send a copy of the inspection report and all other documentation to the DMO for review. The DWC shall request the District Materials & Research Engineer (DMRE) to provide an assessment of the pavement distresses and provide recommendations as to whether remedial work is required and whether the remedial work is the responsibility of the RP.

(3) The DWC will consult with the DMO and review the inspection information and the PCS (if performed) to determine whether immediate corrective work is required based on the type and severity of the pavement deficiencies. If the pavement distresses do not require immediate RW, the DWC will provide the RP with a copy of the results of the inspections (including the PCS if performed) for their review. The RP will be advised that the Department will monitor the pavement performance for the remainder of the warranty period and that RW will be required prior to the end date of the warranty period.

Note: The DWC must review the contract specifications carefully and adhere to the specified timeframes within the specifications.

8.14.8.3 Remedial Work Required

After review of the documentation and the recommendations of the DMO and DMRE, the DWC determines that RW is required, the DWC will immediately provide electronic notification (email) to the RP that RW will be required under the warranty provisions of the contract. The electronic notification shall, within five business days, be followed with written "Notice of Required Remedial Action" (Notice) to the RP by certified mail with the appropriate backup documentation including date of receipt of the Notice by the RP. The Notice shall be signed by the District Construction Engineer. The Statewide Warranty Coordinator in the SCO shall be copied on all correspondence pertaining to

the remedial work. It is important to note that under Section 338 of the Standard Specifications, the Contractor may designate an RP for maintaining the Value Added Asphalt Pavement by using form ***Value Added Assumptions of Obligations by a Subcontractor as the Responsible Party***, [# 700-010-53](#).

The Notice of Required Remedial Action shall request the RP provide the Department with its plan detailing how the RW will be accomplished and that repairs must begin within 45 calendar days of notification in accordance with the Value Added specifications. The RP will also be advised that, if they dispute the Departments findings, they must provide written notification to the Department within 30 calendar days of receipt of the notification and to request a hearing before the DRB. It will be the obligation of the RP to schedule and coordinate the hearing. A copy of the letter and accompanying documentation will be sent to the District Construction Office and the DWC will be responsible for coordination of the DRB hearing or the RP's performance of the required RW.

8.14.8.4 Responsible Party Not Responsible for Remedial Work

(1) If the RW is determined not to be the responsibility of the RP, the DWC will refer the issue to the DCE and the DME for a determination as to how the RW work will be accomplished. The DWC will notify the RP in writing that it is not responsible for the RW.

(2) When the Remedial Work is completed, the DWC will update the CIM system with all appropriate information.

(3) The DWC will send a copy of the updated records from the CIM system to the RP for information if requested.

8.14.8.5 Performance of the Remedial Work by the Responsible Party

(1) The DWC (or designee) will be responsible for coordinating the inspection and oversight on behalf of the Department to ensure that the construction operations of the RW are in compliance with all provisions of the contract specifications. The DWC (or designee) will arrange for a qualified inspector to monitor the construction activities of the RP for acceptance of the RW.

(2) If any RW is unacceptable, the RP shall be required to correct the deficiency to the satisfaction of the Engineer in accordance with the specifications.

(3) When the RW is completed and accepted, the DWC shall notify the RP in writing of acceptance of the work and update the information in the CIM system for the project.

8.14.9 VALUE ADDED REWORKED ASPHALT CONCRETE PAVEMENT (Spec. Section 338 B) and VALUE ADDED REPAVED ASPHALT PAVEMENT (Spec. Section 338 C)

The administration of the warranty for Value Added Reworked Asphalt Concrete Pavement and Value Added Repaved Asphalt Concrete Pavement are similar to the administration of the Value Added Asphalt Pavement (Section 338) above, except that the Reworked and Repaved Asphalt Concrete Pavements are subject to a warranty period, and a warranty/maintenance bond, warranting the asphalt pavement for the duration of the warranty period.

The DWC shall be responsible for the administration of the Warranty after final acceptance of the Contract. If during the warranty period, deficiencies are detected that require remedial repairs, the DWC will coordinate all such requests with the Statewide Warranty Coordinator in the State Construction Office.

Should any administrative actions become necessary under the Warranty/Bond provisions of the Contract, the DWC shall contact the Statewide Warranty Coordinator prior to notification of the Contractor.

8.14.10 VALUE ADDED PORTLAND CEMENT CONCRETE PAVEMENT (Spec. Section 355)

8.14.10.1 Pavement Performance Monitoring Operations

(1) District inspection personnel should perform periodic inspections by driving through the project and randomly stopping at locations to visually inspect the pavement for any distresses. Concrete Pavement deficiencies shall be classified and documented in the CIM system in accordance with the threshold values established in the specification. RW of deficient concrete pavement areas shall be accomplished as defined in the specification. The frequency of inspection shall be performed annually, at a minimum. The DWC has the option to schedule intermediate inspections as deemed necessary. Inspection personnel shall document the inspection results with sufficient detail to allow the DWC to determine whether further evaluation is required. The inspection results shall be sent to the DWC for review and disposition to the appropriate parties. The DWC will coordinate with the appropriate DMO personnel and other Department personnel as required.

8.14.10.2 Assessment of Pavement Distresses

(1) The Department's PCS Program along with observations and inspections by Department inspection personnel will be used as the basis for determining the extent and magnitude of the pavement distresses occurring on a project. The Department must perform annual inspections, at a minimum, to monitor the pavement performance throughout the warranty period. If deficiencies are observed during the inspections, the observations shall be documented with sufficient supporting documentation including photographs and video recordings and must be forwarded to the DWC for review. The DWC will determine if further evaluation is required. The District may, based on the visual observations during the interim inspections request a PCS by contacting the SMO or use the online request form at the following link:

<https://www.fdot.gov/materials/pavement/performance/pcs/index.shtm>

The DWC will be responsible for coordinating inspections during the warranty period. The DWC will notify the RP in writing when a PCS will be conducted.

(2) If the survey is conducted at or near the end of the warranty period, the SMO or DMO must be contacted sufficiently in advance of the expiration date (not less than 45 days) to allow the survey to be conducted and notification (if required) to the RP that remedial work will be required. The DWC (or other specific Department personnel) must provide the RP written notification of "Required Remedial Action" prior to the expiration of the warranty period. The DWC will document the RP's receipt of notification. The contract may contain more specific notice requirements. All documentation produced as a result of the inspections shall be entered into the CIM system.

(3) The DWC will consult with the DMO and review the inspection information and the PCS (if performed) to determine whether immediate RW is required based on the type and severity of the pavement deficiencies. If the pavement distresses do not require immediate RW, the DWC will provide the RP with a copy of the results of the inspections (including the PCS if performed) for their review. The RP will be advised that the Department will monitor the pavement performance for the remainder of the warranty period and the RP will be notified of any required RW prior to the end date of the warranty period. Upon completion of the interim or final inspection of the feature, the status of the inspection shall be entered into the system as "COMPLETED" or "ONGOING". The warranty inspections status will be designated as "COMPLETED" when no deficiencies are found and "ONGOING" when deficiencies are detected. The "ONGOING" inspection status will remain until all deficiencies have been corrected.

Note: The DWC must review the contract specifications carefully and adhere to the specified timeframes within the specifications.

8.14.11 VALUE ADDED BRIDGE COMPONENTS (Spec. Section 475) DESIGN BUILD PROJECTS ONLY

8.14.11.1 Bridge Components Covered By the VABC Specifications

The Value Added Bridge Components (VABC) specification provides a materials and workmanship warranty. For the purpose of this procedure, the prime contractor shall be the RP in accordance with the specifications. The components covered under the specifications are as follows:

- (1) Bridge Deck Expansion Joints Devices and Hardware
- (2) Coatings
- (3) Bearing Devices
- (4) Bridge Lighting/Electrical System
- (5) Drainage Systems

8.14.11.2 Determining the Category of Deficiency

(1) The District Structures Maintenance Office (DSMO) is responsible for inspection of bridges on the State Highway System (SHS). Conventional bridges are required to be inspected at a minimum of every two years and bascule (movable) bridges are required to be inspected once per year. Bridge inspections shall be done in accordance with approved Department procedures. The bridge inspection report will identify deficiencies discovered during the routine inspections. The DWC will coordinate with the DSMO to identify bridges which contain VABC. The DWC will coordinate with the DSMO to ensure the features covered by the Value Added specifications are given the appropriate attention and documentation during the inspection process. The DWC shall coordinate with the DSMO to ensure that all inspection reports and supporting documentation are entered into the CIM system.

(2) The DWC will review the inspection report in conjunction with the DSMO and determine if RW is required. If the DWC/DSMO determines that RW is required, the DWC shall provide written notification to the RP that RW is required under the materials and workmanship warranty provisions of the contract. A copy of the inspection report with supporting documentation shall be provided with the notification and the DWC will document the RP's receipt of notification. When deficiencies are identified, but immediate RW is not required, the "Element Inspection Notes" of the DSMO inspection report must be transmitted to the RP for information. The Element Inspection Notes provide the RP with information for making an informed decision about whether or not to perform preventive maintenance on a deficiency before it requires more expensive RW. On occasion, a deficiency will be reported by non-DSMO maintenance personnel, a local government or from the general public. The DSMO must be promptly notified of the deficiency.

Once the deficiencies are determined to require RW based on the Element Inspection Notes the DSMO will notify the DWC of the RW priority via email and will provide a description of the signing and traffic control required for the repairs. Emergency remedial work requires immediate verbal notification by the DSMO to the RP and the DWC. The verbal notification shall be followed-up with a DSMO Priority 1 Work Order; Non-emergency remedial work requires a Priority 2 or Priority 3 (routine priority) DSMO Work Order; and for deficiencies that do not require remedial work, Element Inspection Notes are required in lieu of a work order and these will be sent to the DWC with a copy to the SCO and the RCO.

8.14.11.3 Emergency Remedial Work-DSMO Work Order

(1) When the DWC receives verbal notification from the DSMO, the DWC will immediately provide written notification to the RP and to the RCO that will be performing inspection and acceptance of the RW. The DWC shall document the notification in the CIM system. The RCO shall document the RW operations in the CIM system. RW shall be accomplished in accordance with the timeframes established in the specifications and in accordance with the contract specifications. RW required under the materials and workmanship warranty provisions of the contract shall be done at no additional cost to the Department.

(2) The DWC must provide the RP with the details and location of the RW as well as the requirements for signing and maintenance of traffic. If the RP is unable to perform, or refuses to perform the RW, the DWC must refer the issue to the District Construction Engineer (DCE) and the District Maintenance Engineer (DME) for a determination as to how the RW work will be accomplished. If the RW requires immediate traffic control and the RP is unable to provide it, then the Department will arrange for traffic control and the RP will be required to reimburse the Department for the expenses.

8.14.11.4 Responsible Party Unable To Perform

(1) If the RP is unable to perform the RW, but acknowledges the responsibility, then the cost of performing the work with an alternative qualified contractor will be documented and reimbursed by the RP. The DWC will coordinate with the DCE or DME for the procurement of the alternative qualified contractor to perform the RW.

(2) If the RW is determined to be urgent, the Department will provide traffic control as required, at the time of discovery. The RP shall assume the responsibility of the traffic control as soon as possible. The RP shall provide a written request with a description of the traffic control plan which must be approved by the RCO.

(3) If the RW is of an immediate concern and the RP is unable or unwilling to perform the RW, the Department will provide the traffic control as necessary based on the severity of the deficiency. The DWC will coordinate with the RCO and the DSMO to develop a work plan to accomplish the RW. The Department shall document all cost associated with the RW with intent to recover from the RP.

8.14.11.5 Performing and Accepting Remedial Work

(1) Once the RP has an approved Work Plan and if applicable, a Traffic Control Plan, work may begin. The RCO in conjunction with the DSMO will inspect and document the RW for compliance with the contract specifications.

(2) The RCO and DSMO will perform a joint final acceptance inspection and any unacceptable work shall be corrected by the RP before final acceptance is issued.

8.14.12 PERFORMANCE TURF (Spec. Section 570)

8.14.12.1 Performance Monitoring

The administrative process for monitoring and tracking Performance Turf requires the establishment of a growing, healthy turf in accordance with the specification. The project personnel responsible for the administration of the contract shall be responsible for monitoring the turf installation and verifying establishment of the turf for the life of the contract. The project personnel shall document all inspection results into the CIM system and the DWC will document the RP's receipt of notification.

If the turf areas designated in the plans have not met the requirements as set forth in the contract for establishment at the time of Final Acceptance, the RP shall continuously maintain all turf areas until the requirements for established turf set forth in Section 570-4 of the specifications are met. Project personnel shall notify and coordinate with the DWC that the establishment period for a contract will continue after Final Acceptance of a contract. Upon notification by the contractor the DWC will schedule and coordinate inspections required by the contract.

(1) After Final Acceptance, the DWC must continue conducting turf inspections at 90-day intervals during the establishment period to determine establishment. The DWC must provide results of the inspection to the RP within seven days of the date of each inspection.

(2) The DWC will review the inspection report in conjunction with project personnel and determine if RW is required. If it is determined by the DWC/project personnel that RW is required, the DWC shall provide written notification to the RP that RW is required under the materials and workmanship warranty provisions of the contract. A copy of the inspection report with supporting documentation shall be provided with the notification and the DWC will document the RP's receipt of notification.

(3) Upon determination that the requirements of Section 570-4 have been met and an established turf has been achieved, ensure the RP has removed all erosion prevention and sediment control devices and release the RP, in writing, from any further responsibility.

8.14.12.2 Performance of the Remedial Work by the Responsible Party

(1) The DWC (or designee) will be responsible for coordinating the inspection and oversight on behalf of the Department to ensure that the operations of the RW are in compliance with all provisions of the contract specifications. The DWC (or designee) will arrange for a qualified inspector to monitor the construction activities of the RP for acceptance of the RW.

(2) If any RW is unacceptable, the RP shall be required to correct the deficiency to the satisfaction of the Engineer in accordance with the specifications.

(3) When the RW is completed and accepted, the DWC shall notify the RP in writing of acceptance of the work and update the information in the CIM system for the project.

8.14.13 PAINTED GALVANIZED STEEL AND ALUMINUM PRODUCTS (Spec. Section 646, 715, and 649)

8.14.13.1 Performance Monitoring

This section describes the administrative process for tracking and monitoring the performance of Painted Galvanized Steel and Aluminum Products, including painted galvanized steel mast arms, strain poles, monotube assemblies, and painted aluminum poles, pedestals, posts and painted conventional light pole assemblies, for compliance with the specification. The Painted Galvanized Steel and Aluminum Products are subject to a warranty, provided by the fabricator, for adhesion and color retention of the coating system. The contract specifications require all the fabricators of Painted Galvanized Steel and Aluminum Products be prequalified and on the Prequalified

Painted Galvanized Steel and Aluminum Products Fabricators Lists which is maintained by the State Construction Office. The list can be accessed by the following link:

<http://www.dot.state.fl.us/construction/ContractorIssues/PaintedPole/PaintedPoleSuppliers.shtm>

Project personnel responsible for the administration of the contract shall inspect and monitor the installation of the Painted Galvanized and Aluminum Products for compliance with the specifications. Any deficiencies or defects with the assemblies that require RW shall be coordinated with the Statewide Warranty Coordinator in the State Construction Office. Project personnel shall document all inspection and/or RW and enter the information into the CIM system. Project personnel shall notify the DWC upon Final Acceptance of a project containing Painted Galvanized Steel and Aluminum Products. All documentation required by the specifications shall be scanned into the CIM system.

Painted Galvanized Steel and Aluminum Products are subject to a five year warranty period. The DWC shall be responsible for the administration of the warranty after Final Acceptance of the contract. If during the warranty period, deficiencies are detected that require remedial repairs, the DWC will coordinate all such requests with the Statewide Warranty Coordinator in the State Construction Office.

8.14.13.2 Warranty Claim Instructions

Should the RP fail to satisfactorily perform the remedial work, which is determined to be the responsibility of the RP, the DWC, with concurrence from the DCE, shall provide notification to the Statewide Warranty Coordinator in the State Construction Office (SCO) to initiate the appropriate action in accordance with the specifications. The following instructions must be followed to ensure the Department's ability to make a claim.

The Florida Department of Transportation's List of Prequalified Fabricators of Painted Galvanized Steel and Aluminum Products requires the fabricator to provide the following information for each project:

- (1) All products must be listed in MAC for specific portions of Section 646, 649, and 715.
- (2) The Assumption of Obligations by the Fabricator as the Responsible Party for Color and Adhesion Warranties. (Form #700-010-20)
- (3) Warranty Bond against any color retention or adherence failures, as described in Section 975, which occur within five years from the date of final acceptance of the Contract under which the products were installed.

- (4) A written statement certifying the number of products that it sold for use on each Department Contract during the current bond cycle.

The term of the Bond for all prequalified fabricators is **five years** from the Department's final acceptance date and covers any and all coating system color retention and coating adhesion failures. The bond details can be obtained at the following link:

<https://www.fdot.gov/construction/contractorissues/paintedpole/paintedpolesuppliers.shm>

To initiate a Bond claim, the Department must notify the Surety in writing not more than five years from the final acceptance date of the Contract under which the products were installed. District warranty personnel must contact the Statewide Warranty Coordinator in advance of sending the notification to ensure the proper Surety and bond number are referenced in the correspondence.

The following information should be included in the notification to the Surety:

- (1) Final acceptance date for the Contract under which products were installed.
- (2) Executed Assumption of Obligations: Form #700-010-20
- (3) Inspection history, including dates and findings
- (4) Photos of deficiencies
- (5) Copy of the deficiency letter to the Fabricator
- (6) Copy of the bond and/or continuation certificate
- (7) Any correspondence with the Fabricator prior to color retention and adherence failures.

8.14.14 TRAFFIC STRIPES AND MARKINGS

This section defines the administrative process for monitoring and tracking the performance of traffic stripes and marking installations in accordance with the contract specifications. The specifications provide for a 180-day Observation Period after Final Acceptance of the contract. The following sections contain this requirement: Sections 701, 702 709, 711 and 713. The DWC shall coordinate the inspection with the appropriate RCO/ OCO. The results of the inspection shall be documented in the CIM system.

8.14.15 OTHER WARRANTY ITEMS

All warranties shall be documented. This section is provided to allow warranty tracking for non-VAF items of the work, including but not limited to manufacturer's warranties,

which by agreement of the contracting parties, will be warranted for a specific period. The documentation which formalizes the agreement will be provided by the State Construction Office or District Construction Office. All documentation pertaining to the warranty shall be scanned into the CIM system. The DWC will be responsible for the administration of the warranty during the warranty period.

Note: Any changes to a warranty required by the Specifications must be done in accordance with CPAM Chapter 7.3.5.3.

Section 9.1

MAINTENANCE OF TRAFFIC AND SAFETY

9.1.1 Purpose

To establish a uniform standard for inspection and review of Maintenance of Traffic (MOT) operations used in construction projects.

9.1.2 Authority

Section 20.23(3)(a) and 334.048(3), Florida Statutes (F.S.)

9.1.3 References

FDOT Specifications, [Section 8](#) and [Section 102](#)

[Manual on Uniform Traffic Control Devices \(MUTCD\), Part VI](#)

[FDOT Standard Plans, Topic No. 625-010-003](#)

9.1.4 General

The Department oftentimes uses consultants in administering construction projects through engineering contracts. The authority of the Senior Project Engineer on Consultant Construction Engineering Inspection (CCEI) projects is identical to the Department Resident Engineer and shall be interpreted as such. Likewise, the role of the Consultant's personnel is identical to the Department's project personnel.

9.1.5 Selection of Traffic Control Plan (TCP)

A Traffic Control Plan (TCP) is included with each Department construction contract. The Contractor will furnish a letter to the Resident Engineer stating whether they plan to use the Department designed TCP or will submit an alternate TCP for approval. The alternate TCP must be signed and sealed by a Professional Engineer licensed by the State of Florida and shall be reviewed, discussed, and approved by the Resident Engineer.

When the Contractor proposes a modification to the TCP, particular attention must be given to the utility adjustment plan of the project and Utility Work Schedules. If the proposed TCP modification affects the Utility Work Schedule or

the planned utility adjustments, the Contractor shall have a new Utility Work Schedule executed by the District Utilities Administrator.

The Resident Engineer shall coordinate with the District Design, District Traffic Operations, District Utilities, and the District Construction Offices before approving/disapproving the proposed alternate TCP. Emergency Services should be notified in advance of any major modifications affecting traffic flow or patterns.

The TCP approval letter must include a statement to the effect that any additional costs or delays, including any increase to the cost for the utility work will be borne by the Contractor. The change will be documented by a Supplemental Agreement or Work Order with the Contractor's revised plans.

The Contractor will not begin work using an alternate TCP until the Resident Engineer has approved such plan.

9.1.6 Discussion of Traffic Control Plan at Pre-Construction Conference

The TCP to be utilized on the project, as detailed within the Contract, will be reviewed and discussed at the pre-construction conference. The review of the TCP shall consist of reviewing the different phases of work and the provisions to maintain traffic during each phase. Any errors or omissions shall be noted for corrective action.

The discussion at the pre-construction conference shall include:

- (1) Inspections performed by the Contractor and corrective actions taken,
- (2) Responsibilities of the Worksite Traffic Supervisor (WTS),
- (3) The Contractor's work notification to the Engineer,
- (4) Traffic safety,
- (5) Changes to the TCP,
- (6) Independent Channelizing Device Supplier,
- (7) Sign installations and removal or covering of existing signs,
- (8) Installation and removal of pavement markings,
- (9) Crash reporting,

- (10) Night work,
- (11) Flaggers,
- (12) Automated Flagging Assistance Device (AFAD)
- (13) Motorist Awareness System (MAS),
- (14) Work zone clearances,
- (15) Inactive work zones,
- (16) Portable changeable message boards, etc.
- (17) Proper use of Traffic Control Law Enforcement Officers,
- (18) Proper use of Speed Control Law Enforcement Officers.
- (19) Pedestrian, bicycle, and ADA accommodations, including proper closure of sidewalks and bicycle lanes (including paved shoulders) in the construction area.
- (20) Impacts on utilities adjustments and/or schedule.
- (21) Access to the Department's Lane Closure Notification System

The Contractor's role in implementing any corrective actions must be clarified before the project begins. This will ensure that needed changes are performed with minimum disruption to work activities. A list of trained flaggers must be submitted to the Project Administrator before construction begins.

9.1.7 Department's Lane Closure Notification System

The Consultant CEI shall collect the names, email addresses, and certificates of training for the WTS (and alternates, if applicable) who will require access to the Department's Lane Closure Notification System at the pre-construction conference. Submit the information collected to the Construction Project Manager (CPM). The CPM will coordinate with the District Construction Office's Lane Closure Notification System User Administrator for WTS user account generation.

For changes to WTS user accounts, submit a request to the CPM at least 14 days prior to when the change is needed. The CPM will coordinate with the District Construction Office's Lane Closure Notification System User Administrator to update WTS user accounts.

The Consultant CEI shall verify that the WTS has entered the required lane closure information into the Department's Lane Closure Notification System at the start and end of each lane closure. The Consultant CEI may enter or update lane closure information on behalf of the Contractor in the event of an emergency or device failure.

The Department's Lane Closure Notification System may be accessed at <https://us.one.network/>. To obtain Consultant access to Department's Lane Closure Notification System, the requestor must complete the training course for Department's Lane Closure Notification System in Learning Curve and submit an Automated Access Request Form (AARF) for Read/Write access.

9.1.8 Work Zone Inspections

Project personnel shall perform work zone inspections. The Consultant CEI shall document any deficiencies in the weekly [MOT Review Report, Form No. 700-011-37](#). Discuss any deficiencies identified with the Contractor and issue verbal warnings, deficiency warning letters and deficiency letters, as appropriate. Also, as required by the Contract Documents, the Contractor's WTS will perform inspections of the project. When possible, project personnel should perform work zone inspections with the WTS. If deficiencies are not corrected, then the Department/Representative will use the [Contractor's Past Performance Rating, Section 2, Form No. 700-010-25](#) to enforce compliance.

9.1.9 Actions Due to MOT Deficiencies or Safety Concerns

- (1) Any MOT deficiency that is considered an immediate safety deficiency (i.e. severe and life-threatening hazard) will require immediate corrective action by the Contractor. Additionally, if the Consultant CEI determines that any activity of the Contractor poses an imminent hazard to the public, the Consultant CEI shall direct the Contractor to immediately cease the activity and to close the affected lanes of traffic until the deficiency is addressed.

When defects, including but not limited to, structural cracks, are initially detected during bridge construction, the Engineer of Record, construction engineering inspector, design-build firm, or local agency that owns or is responsible for the bridge construction has the authority to immediately close the bridge to construction personnel and close the road underneath.

Failure by the Contractor to correct the safety deficiency immediately is basis for the Consultant CEI to suspend project operations and obtain other means to correct the hazard. The Consultant CEI should document the deficiency with photographs sufficient to support the action.

- (2) If corrective action on the deficiencies of which the Contractor has been given written notification has not been corrected within the 24-hour time limit, the Project Administrator shall deduct payment for the uncorrected areas until corrective action is made and use the [Contractor's Past Performance Rating, Section 2, Form No. 700-010-25](#) to enforce compliance.

The WTS shall be disqualified if corrective action is not completed within the 24-hour time limit on three notifications to the Contractor within a twelve (12) months period.

The following shall apply to disqualification of WTS:

- [First Notification](#) - Verbal (documented) warning
If no other notifications are issued within one year (365 days) from the first notification, then the record of the first error shall be deleted from the WTS record.
- [Second Notification](#) - Written warning
If no other notifications are issued within one year (365 days) from the second notification, then the record of the first and second notifications shall be deleted.
- [Third Notification](#) - Suspension of qualification (all projects)

This decision may be appealed to the District Construction Engineer. The District Construction Engineer's decision is final. Submit all Notifications issued to the WTS to the State Construction Office.

Prior to having the qualification reinstated, the WTS must take the required training course and pass the examination.

9.1.10 Other Requirements

Department and Consultant CEI personnel will report crashes occurring within the project limits as described in [**CPAM Section 9.3.**](#)

Section 9.2 (Deleted)

Section 9.3

WORK ZONE TRAFFIC INCIDENT EVALUATION AND REPORTING

9.3.1 Purpose

To standardize a procedure for reporting traffic crashes that occur in construction work zones and to analyze construction work zone operations at crash sites.

9.3.2 Authority

[Section 334.048\(3\), Florida Statutes](#)

[Section 20.23\(3\)\(a\), Florida Statutes](#)

9.3.3 References

[Title 23 Code of Federal Regulations \(CFR\), Part 630, Subpart J](#)

9.3.4 Background

The Federal Highway Administration (FHWA) requires that each State develop a system to report traffic crashes in construction work zones. The crash reports are reviewed to locate and isolate problem areas to evaluate and enhance the safety measures in the work zone, if deemed necessary.

9.3.5 Identification of Traffic Crashes

Resident Level Responsibilities

- (1) When a traffic crash occurs within a work zone and is brought to the attention of the Project Administrator through actual observation, notification by others, or through signs of a crash aftermath (i.e. debris, extensive damage to work zone devices, etc.), contact state or local law enforcement agencies and/or county traffic engineering departments to obtain crash reports.
- (2) Upon identification of a crash, the Project Administrator will conduct an evaluation of

the maintenance of traffic features and devices in the immediate area of the crash site.

9.3.6 Reporting Traffic Crashes

Resident Level Responsibilities

- (1) Fill out the [Engineer's Maintenance of Traffic \(MOT\) Evaluation at Crash Site Form No. 700-010-64](#), along with detailed diagrams and narratives. Minor crashes are defined as skid marks, damaged barricades, etc., and crashes in which there are no injuries or fatalities and less than \$1,000 of property damage. Major crashes are defined as crashes in which there are injuries, fatalities, or result in more than \$1,000 of property damage. If a major crash occurs or multiple minor crashes occur in the same vicinity, then the traffic control plan and traffic movements should be analyzed to determine the cause and subsequent corrective action.
- (2) Attach digital photos and a copy of the Traffic Control Plan (TCP) of the immediate area of the crash to the [Engineer's Maintenance of Traffic \(MOT\) Evaluation at Crash Site Form No. 700-010-64](#). The photos should clearly portray the MOT setup and roadway conditions in the immediate vicinity of the crash site and any resulting property damage. Examples include but are not limited to impacts or damage to temporary barrier, crash cushions and other roadside safety hardware, traffic markings and signage, and vehicle damage.
- (3) Appropriate corrective action is to be taken immediately and noted on the form.
- (4) Attach any other supporting documentation, such as crash reports or driver information exchange reports, to the [Engineer's MOT Evaluation at Crash Site Form No. 700-010-64](#). Do not wait for such documentation, complete the report immediately.
- (5) When a crash report contains information contrary to the facts that project personnel are aware of, and the crash report is correct, be sure to amend the [Engineer's MOT Evaluation at Crash Site Form No. 700-010-64](#). If it is unclear if the crash report is correct, acknowledge the discrepancies on the [Engineer's MOT Evaluation at Crash Site Form No. 700-010-64](#).
- (6) Discuss crashes and subsequent corrective actions at the weekly Progress Meetings.

9.3.7 MOT Evaluation at Crash Site

Evaluate all possible factors to determine its cause and to make corrections that will reduce the probability of additional crashes. However, the occurrence of a crash does not automatically mean that a change in work zone traffic controls is required. Crashes usually are the result of a combination of factors.

Examine the relationship of the crash to the existing work zone traffic controls and evaluate signage, pavement markings, and all other temporary traffic control devices in the immediate vicinity of the crash site. A night inspection is required if the crash occurred at night. If any enhancements or corrective measures are to be taken, list them on the [Engineer's MOT Evaluation at Crash Site Form No. 700-010-64](#) and document the action on the Daily Work Report in Site Manager.

Do not make changes to the Traffic Control Plans which will change traffic patterns or movements without the approval of the Resident Engineer.

9.3.8 Other Actions

The [Engineer's MOT Evaluation at Crash Site Form No. 700-010-64](#) should be prepared with photos attached and distributed within two weeks of the incident.

Email a copy of the [Engineer's MOT Evaluation at Crash Site Form No. 700-010-64](#) and other supporting documentation to the State Construction Engineer and the State Construction Specialty Engineer.

Section 10.1

PILES

10.1.1 Purpose

To establish a procedure for obtaining production pile lengths and driving criteria to be used in structures. This chapter also provides the procedure for documentation of pile installation. This procedure applies to conventional projects; for Design Build projects refer to **Section 10.12**.

10.1.2 Authority

Sections 20.23(3)(a), and 334.048(3), Florida Statutes (F.S.)

10.1.3 References

Section 455, Standard Specifications for Road and Bridge Construction and any supplements thereto.

10.1.4 Scope

The principal users of this document include the State Construction Office District Materials and Research Offices (DMRO), District Construction Offices (DCO), District Operations Centers, the State Materials Office (SMO), and Construction Engineering and Inspection (CEI) firms working for the Department.

10.1.5 Definitions

District Construction Engineer (DCE): The authority on the entire construction activity in the District.

Construction Engineering and Inspection (CEI): In this procedure, it refers to the Consultant personnel performing CEI services or the Florida Department of Transportation (Department) personnel group performing CEI services.

Geotechnical Engineer: In this procedure, the Geotechnical Engineer may be the District Geotechnical Engineer (DGE), any Department Engineer assigned for the project by the DGE, the Consultant Geotechnical Engineer working directly for the DGE,

or the Geotechnical Engineer employed by the Department's Consultant CEI and performing under the direction of the DCE and DGE.

Project Administrator (PA): The Administrator who shall be responsible for the everyday construction activity at the project under the direction of the Resident Engineer/Senior Project Engineer.

Resident Engineer (RE): The Engineer supervising the CEI personnel and is responsible for the construction activities in the residency. In this procedure, this could be the Senior Project Engineer responsible for the construction activities of the project.

10.1.6 General

The steps to establish pile lengths and driving criteria consist of reviewing the Contractor's hammer system as detailed in the pile installation plan, recording test pile data, and setting of production pile lengths and driving criteria in accordance with **Section 455, Structures Foundations, Standard Specifications (Section 455)**. All documents referred in this section must be signed in accordance with section 4-1 of the Standard Specifications.

10.1.7 Pile Installation Plan

(A) Resident Level Responsibilities

The RE (or PA) shall receive from the Contractor at the preconstruction conference or at least thirty (30) days prior to the driving of the initial test pile a completed **Pile Driving Installation Plan Form, No. 700-020-01**. Within two (2) working days, the RE (or PA) shall forward the Pile Installation Plan (PIP), including the **Pile Driving Installation Plan Form** to the Geotechnical Engineer for review and recommendations.

The RE (or PA), within two (2) working days of receipt of the Geotechnical Engineer's comments shall forward them to the Contractor. The RE (or PA) shall perform a concurrent separate review of the PIP, incorporate their own comments to the ones received from the Geotechnical Engineer, and forward them to the Contractor.

The RE (or PA) shall contact as soon as possible the Geotechnical Engineer if the pile driving system does not appear to drive the piles satisfactorily. A satisfactory driving system means a system being able to drive the piles in compliance with all the requirements of **Section 455**.

If, after field observations and evaluation of dynamic test data and driving records, the Geotechnical Engineer recommends rejecting the PIP, the RE (or PA) shall notify the

Contractor of this rejection within one (1) working day of receiving the recommendation for rejection. The notification shall contain the reason(s) for rejection of the PIP plan.

The RE (or PA) shall upload PIP submittals and Geotechnical Engineer's recommendations and comments into the Department's electronic document management system, including revisions and addenda.

(B) District Materials and Research Office (DMRO) Level Responsibilities

The DGE shall make comments to the RE (or PA) on the driving system within five (5) working days of receiving the PIP.

If, after field observations, the pile driving system does not perform satisfactorily, the Geotechnical Engineer shall evaluate dynamic testing data, driving records, and other pertinent data. Additional dynamic testing may be required. If it is established that the driving system does not produce results within the specifications, the Geotechnical Engineer shall issue a notification to the RE (or PA) recommending the rejection of the PIP. The notification shall include the reasons for the rejection of the PIP. This notification shall be made immediately after evaluating the field and dynamic test data.

10.1.8 Test Pile Installation

(A) Resident Level Responsibilities

Test pile installation, whether it is for a permanent or temporary structure, shall be documented in the pile driving record. As soon as the Contractor's schedule for driving test piles is known, the RE (or PA) shall notify the Geotechnical Engineer of the schedule so the Geotechnical Engineer may observe the installation of the test piles to aid in setting production pile lengths.

Every test pile driven on the project shall be recorded electronically in the field in the ***Pile Driving Log, Form No. 700-010-60***. It shall contain all the data and observations pertaining to the driving of the test pile. The test pile lengths and any special requirements for piles can be found in the plans or specifications.

Two to four pages of the ***Pile Driving Log, Form No. 700-010-60*** are dedicated for recording information relating to each pile driven. Page 1 contains the general information about the project, driving criteria, and procedures. Page 2 (there could be up to Page 4 depending on the pile length) contains the ***driving log record*** and comments. Additional guidance is provided in the Pile Driving log instructions. The test pile information must be completed as soon as practical. Note that for projects let after

June 30, 2020, a pile inspection device must be used for the inspection of test piles and production piles that displays and stores electronically the stroke in open-ended Diesel hammers, blows per foot and blows per minute for all hammers, and exports the electronic data into a file that produces or replicate the Department's Pile Driving Record form.

Most of the items on Page 1 are self-explanatory. The subcontractor's name should be noted only if someone other than the prime Contractor drives the piling.

The notes section shall describe any occurrences during the driving of the pile or any information that the recorder feels may be beneficial to the Geotechnical Engineer or the PA.

Page 2 (there could be up to Page 4 depending on the pile length) describes the actual pile driving. All of the field information shall be completed for each foot of driving. The specifications require the Contractor to furnish high and low ground elevations at each pile group and bent. This elevation shall be of the ground line, not of the water line.

The measured hammer energy is the hammer energy determined during driving by observed stroke lengths, pressure gauges or hammer instrumentation (other methods may be used when proposed and approved). Stroke/pressure details must be documented.

The pile rebound shall be monitored and recorded accurately with the amount of rebound shown in inches and the elevation limits of rebound shown.

The notes column must describe, accurately and completely, the manner in which the pile driving proceeded noting any irregularities, unexpected occurrences, deviations from driving criteria or procedures, actual elevations where the jets were turned on and off, relationship between the pile tip and jet tip, depth to which the pile penetrated under its own weight, spalling, cracks, where and when cushions were changed, etc.

Upon completion of test pile driving documentation, the inspector must sign the form in the appropriate place. The original is retained in the project files. A completed form is to be sent to the Geotechnical Engineer within 24 hours of completion for review and use in setting the production pile lengths.

Additional information will need to be sent to the Geotechnical Engineer to aid in setting pile lengths. This information would include field data notes, including notes obtained for the monitoring of equipment, any dynamic load test information obtained, static/Statnamic load test results, and any other information that explains or records the events occurring during the driving of the piles.

This information shall be attached to the test pile record. Construction Training Qualification Program (**CTQP**) qualified inspectors shall be employed to document the pile driving logs for both permanent and temporary piles.

10.1.9 Production Pile Lengths and Driving Criteria

Production pile lengths for permanent structures are established utilizing the results of the test pile program and contract documents.

(A) DMRO Level Responsibilities

Within four (4) working days of the performance of the test pile dynamic and/or static load test data, the Geotechnical Engineer shall review and examine the test pile data and set up the production pile length. A Production Pile Lengths letter shall be sent to the RE recommending production pile lengths to be used on the project. Refer to **Guidance Documents 10-1-A** and **10-1-B** for **sample letters**. This letter is to be signed by the Geotechnical Engineer. When the Geotechnical Consultant generates the letter, the DGE shall review the letter and recommend acceptance or rejection to the RE (or PA). The final produced letter submitted to the Contractor will include the signature of the DGE recommending acceptance of the Consultant's recommendations. A letter of recommendation (Driving Criteria Letter) containing pile driving criteria shall be sent to the RE (or PA) recommending the blow count criteria vs. stroke (or chamber pressure) for acceptance, practical refusal criteria, minimum tip elevation or penetration requirements, the maximum allowable strokes to control installation stresses, special instructions to increase or reduce the stroke, the pile driving equipment for which the criteria is applicable, and any other special considerations that the inspector should follow during the installation of the piles. If using a diesel hammer, a table of blow count versus stroke (open-end diesel hammers) or blow count versus chamber pressure (closed-end diesel hammers) shall also be furnished and attached to the Driving Criteria letter. For air hammers, the blow count shall be given for a fixed stroke determined as appropriate to mobilize capacity within the specifications. For hydraulic hammers, the blow count shall be given for one or more equivalent strokes, or one or more energy levels (measured automatically by a sensor) determined as appropriate to mobilize capacity within the specifications. This Driving Criteria letter must be prepared and submitted within three (3) working days of furnishing the Production Pile Lengths letter to the RE (or PA). Refer to **Guidance Documents 10-1-C** and **10-1-D** for **sample letters**.

Production Pile Lengths and Driving Criteria letters shall include the dynamic load test data and wave equation analyses performed to establish authorized lengths and driving criteria.

(B) Resident Level Responsibilities

Upon receipt of the Production Pile Lengths letter from the Geotechnical Engineer, the RE shall approve the recommendation and send it to the Contractor within one (1) working day. Upon receipt of the Driving Criteria letter from the Geotechnical Engineer, the RE shall forward it to the Contractor within one (1) working day.

The RE (or PA) shall upload all test pile logs, the Production Pile Lengths letter and the Driving Criteria letter into the Department's electronic document management system, including the dynamic load test data and analyses data.

10.1.10 Production Pile Installation

Pile driving of every production pile (permanent or temporary) shall be inspected and documented on the ***Pile Driving Log*** in accordance with Section 10.1.8 of this procedure. The RE (or PA) shall review the logs for accuracy.

Instrumented piles and instrumented set-checks shall be certified by the Geotechnical Engineer performing the instrumentation in accordance with section 10.1.12.

(A) DMRO Level Responsibilities

Review instrumented Dynamic Load Test (DLT) information and make comments as required. Perform periodic review of all driving logs to verify compliance with specifications and driving criteria information.

(B) Resident Level Responsibilities

The RE (or PA) shall upload all production pile driving logs, DLT data for all instrumented DLT (full length monitoring and/or set-checks), analysis outputs, certification letter produced in accordance with 10.1.12, and the DGE concurrence, into the Department's electronic document management system.

10.1.11 Pile Lengths and Driving Criteria for Temporary Piles

(A) Resident Level Responsibilities

Upon receipt of the pile lengths and driving criteria packages from the Contractor, the RE (or PA) shall forward them to the DGE and the Geotechnical Engineer for review.

Upon receipt of comments from the Geotechnical Engineer, the RE (or PA), shall forward them to the Contractor.

The RE (or PA) shall coordinate the activities to make sure the review process of this submittal is performed within the deadlines set forth by the specifications.

The RE (or PA) shall upload all test pile logs, and Production Pile Lengths and Driving Criteria letters and comments of Geotechnical Engineer for temporary piles into the Department's electronic document management system, including the dynamic load test data and analyses data.

(B) DMRO Level Responsibilities

Within three (3) working days of receiving the Production Pile Lengths letter, the Geotechnical Engineer shall perform a review of the proposed lengths and submit comments in a notification to the RE (or PA).

Within three (3) working days of receiving the Driving Criteria letter, the Geotechnical Engineer shall perform a review of the analysis, proposed blow count, and driving directions, and shall submit a notification to the RE (or PA) recommending approval or rejection of the driving criteria. If the Contractor submits lengths and driving criteria in one package, pile lengths comments and driving criteria recommendation for approval or rejection shall be performed within three (3) working days. If the Driving Criteria letter is not approved, the notification must include the reasons for rejection. Review comments, approvals, or rejection performed by a consultant geotechnical engineer shall be discussed with and concurred by the DGE before submitting them to the RE (or PA).

10.1.12 Documentation for Instrumented Production Piles.

Any instrumented test and production pile (including temporary and permanent piles) shall be certified by the Dynamic Testing Engineer (DTE) performing the instrumentation regardless whether the DTE works for the CEI or for the DMRO. The DTE shall submit a signed and sealed letter per bent/pier with instrumented piles, certifying the capacity obtained in the instrumented piles to the RE (or PA) and the DGE, within two working days of finishing the pile installation in the bent/pier that is being certified. The letter shall include a table indicating the final capacity measured of every instrumented pile. When the capacity was measured during an instrumented set-check, the capacity shall be determined in accordance with the Soils and Foundation Handbook, Appendix F. The letter shall include the dynamic load test results along with any additional analysis performed to estimate capacity (CAPWAP for PDA or FDOT-EDC method for EDC). In 100% instrumented piles, the certification letter shall include

both production and test pile results. Acceptance of the piles shall not be contingent upon the submittal of this letter. The RE or PA shall work together with the DGE and the DTE to ensure the piles are accepted within the deadline set up by the specifications.

(A) Resident Level Responsibilities

When the DTE works for the CEI, the RE (or PA) shall coordinate the activities to make sure the certification letter is submitted within the deadline specified above and the comments issued by the DGE office are addressed.

(B) DMRO Level Responsibilities.

The DGE office shall review the certification letter. When the DTE works for the DMRO the DTE shall address all DGE's comments and the DGE shall submit a concurrence e-mail along with the revised certification letter to the RE (or PA) within four working days of finishing the pile installation of the particular bent/pier being certified. When the DTE works for the CEI the DGE shall submit comments or concurrence to the RE (or PA) within two working days of receiving the certified letter.

10.1.13 Training

All FDOT and CEI personnel performing inspections of pile installation must hold the Construction Training Qualification Program (CTQP) as Pile Driving Inspector.

10.1.14 Forms

The following forms are available from the Policy & Process Management Forms Library at [Procedural Document Library \(fdot.gov\)](https://www.fdot.gov/procedural-document-library):

700-010-60	Pile Driving Log
700-020-01	Pile Driving Installation Plan Form

Guidance Document 10-1-A

**SAMPLE LETTER No. 1
PRODUCTION PILE LENGTHS**

(Date)

(ADDRESSEE)

Re: PRODUCTION PILE LENGTHS
Financial Project ID:
FAP No.:
Contract No.:
County:
Structure #

Dear (_____):

The District (put in which District, 1-7, or Turnpike Enterprise) Geotechnical Office has completed its review of the dynamic test/test load/core boring data for the subject bridge. The recommended production pile lengths are as follows:

LOCATION	PILE SIZE	RECOMMENDED PILE LENGTH
<hr/>		

Recommended by:

District Geotechnical Engineer

Authorized for contract administration purpose by:

Resident Engineer

(Initials/Initials)

cc: State Construction Geotechnical Engineer
State Structures Engineer's Office (State Geotechnical Engineer)
FHWA (only if Federal Aid oversight project)

Guidance Document 10-1-B

SAMPLE LETTER No. 2 PRODUCTION PILE LENGTHS

(Date)

(ADDRESSEE)

Re: PRODUCTION PILE LENGTHS
Financial Project ID:
FAP No.:
Contract No.:
County:
Structure #

Dear (_____):

The (Geotechnical Consultant Firm name) has completed its review of the dynamic test/test load/core boring data for the subject bridge. The recommended production pile lengths are as follows:

LOCATION	PILE SIZE	RECOMMENDED PILE LENGTH
<hr/>		

Recommended by: _____
Consultant Geotechnical Engineer

Recommended for acceptance by: _____
District Geotechnical Engineer

Authorized for contract administration purpose by: _____
Resident Engineer

(INITIALS/INITIALS)

cc: State Construction Geotechnical Engineer
State Structures Engineer's Office (State Geotechnical Engineer)
FHWA (only if Federal Aid oversight project)

Guidance Document 10-1-C

SAMPLE LETTER No. 3 DRIVING CRITERIA LETTER (OPEN-END DIESEL HAMMER)

(Date)

(ADDRESSEE)

Re: DRIVING CRITERIA
Financial Project ID:
FAP No.:
Contract No.:
County:
Structure #

Dear (_____):

The District (put in which District, 1-8) Geotechnical Office (or Geotechnical Consultant Firm name) has completed its review of the dynamic load test data, pile driving records, and other information for the subject bridge. The recommended driving criteria are as follows:

BENT (OR PIER) #

Pile Driving for the _____ foot long, _____ tons (____ Kips) Nominal Bearing Capacity production piles may be accepted if one of the following conditions is achieved:

1. Practical refusal (20 blows per 1 inch or less with a hammer stroke of at least ____ ft and pile rebound less than 0.25 inch) is achieved during the driving and the minimum tip elevation presented in the plans is achieved. A minimum of ____ blows shall be required on a new cushion before practical refusal can be applied.
2. The required blow count at the respective stroke height presented in the following table is achieved for 2 consecutive feet with less than 0.25 inch rebound and the minimum tip elevation is achieved. The blow count over the last two feet must be increasing. A minimum of ____ blows shall be required on a new cushion before the criterion below can be applied.

<u>Stroke Height (ft)</u>	<u>Blows Per Foot</u>
(several rows of stroke vs. Blows per foot)	
XX.X	XX
XX.X	XX
XX.X	XX

Firm Material Definition: (Note: Include this paragraph if no minimum tip elevation is specified) For purposes of penetration, firm material is defined as the material that offers a driving resistance of at least ____ per foot, at a minimum stroke of ____ ft.

Driving Requirements: (Indicate here at what maximum stroke and/or setting to start the driving, and the instructions to gradually increase the stroke, or reduce the stroke if the blow count reduces significantly and may create tension stresses) (Indicate also the maximum stroke allowed at any time of driving to prevent excessive stresses)

(Indicate special instructions for predrilling and performing if applicable)

(Indicate instructions regarding pile cushions) (Indicate that a new pile cushion shall be used for every pile) (Indicate the thickness required for the cushion) (Include the expected number of blows a cushion will need to be replaced) (Include the required number of hammer blows a new cushion must be impacted before the blowcount and practical refusal criteria can be applied)

(Indicate the equipment to which the criteria applies) The above Driving Criteria are based on the (Hammer Type) , serial number _____, using a hammer cushion consisting of _____ inch thick of (Material) and _____ inch of (Material) as utilized during the test piles. If there is a change in the driving system please notify us immediately so that a new driving criteria can be determined.

Recommended by: _____
Geotechnical Engineer (If a Consultant generates the letter)

Recommended for acceptance by: _____
District Geotechnical Engineer

(Initials/Initials)

cc: State Construction Geotechnical Engineer
State Structures Engineer's Office (State Geotechnical Engineer)
FHWA (only if Federal Aid oversight project)

Guidance Document 10-1-D

SAMPLE LETTER No. 4 DRIVING CRITERIA LETTER (HYDRAULIC HAMMER)

(Date)

(ADDRESSEE)

Re: DRIVING CRITERIA
Financial Project ID:
FAP No.:
Contract No.:
County:
Structure #

Dear (_____):

The District (put in which District, 1-8) Geotechnical Office (or Geotechnical Consultant Firm name) has completed its review of the dynamic load test data, pile driving records, and other information for the subject bridge. The recommended driving criteria are as follows:

BENT (OR PIER) #

Pile Driving for the _____ foot long, _____ tons (____ Kips) Nominal Bearing Capacity production piles may be accepted if one of the following conditions is achieved:

1. Practical refusal (20 blows per 1 inch or less with a hammer equivalent stroke of at least ____ ft (or an energy of ____ K-ft) and pile rebound less than 0.25 inch) is achieved during the driving and the minimum tip elevation presented in the plans is achieved. A minimum of ____ blows shall be required on a new cushion before practical refusal can be applied.
2. The required blow count at the respective equivalent stroke height presented in the following table is achieved for 2 consecutive feet with less than 0.25 inch rebound and the minimum tip elevation is achieved. The blow count over the last two feet must be increasing. A minimum of ____ blows shall be required on a new cushion before the criterion below can be applied.

<u>Min. Equivalent Stroke Height (ft)</u> <u>(or Min. Energy (K-ft))</u>	<u>Blows</u> <u>Per Foot</u>	<u>Blows/minute</u> <u>Range (BPM)</u>
---	---------------------------------	---

(one to three rows of stroke or Energy vs. Blows per foot and BPM)

XX.X	XX	XX to XX
XX.X	XX	XX to XX
XX.X	XX	XX to XX

Note: Energy to be measured by a (name of the remote device measuring energy)

Firm Material Definition: (Note: Include this paragraph if no minimum tip elevation is specified. This step may be omitted if dynamic load test data and other field observations indicate that all production piles will not reach the required blow count criterion until a minimum penetration of 20 feet is exceeded.) For purposes of penetration, firm material is defined as the material that offers a driving resistance of at least ___ per foot, at a minimum equivalent stroke (or minimum energy) of ____ ft (or K-ft).

Driving Requirements: (Indicate here at what maximum equivalent stroke and/or energy to start the driving, and the instructions to gradually increase the equivalent stroke, or reduce the equivalent stroke if the blow count reduces significantly and may create tension stresses) (Indicate also the maximum equivalent stroke (or energy) allowed at any time of driving to prevent excessive stresses)

(Indicate special instructions for predrilling and performing if applicable)

(Indicate instructions regarding pile cushions) (Indicate that a new pile cushion shall be used for every pile) (Indicate the thickness required for the cushion) (Include the expected number of blows a cushion will need to be replaced) (Include the required number of hammer blows a new cushion must be impacted before the blowcount and practical refusal criteria can be applied)

(Indicate the equipment to which the criteria applies) The above Driving Criteria are based on the (Hammer Type) , serial number _____ , using a hammer cushion consisting of _____ inch thick of (Material) and _____ inch of (Material) as utilized during the test piles. If there is a change in the driving system please notify us immediately so that a new driving criteria can be determined.

Recommended by: _____
Geotechnical Engineer (If a Consultant generates the letter)

Recommended for acceptance by: _____
District Geotechnical Engineer

(Initials/Initials)

cc: State Construction Geotechnical Engineer
State Structures Engineer's Office (State Geotechnical Engineer)
FHWA (only if Federal Aid oversight project)

**Attachment 10-1
Flow Charts**

REVIEW OF PILE INSTALLATION PLAN

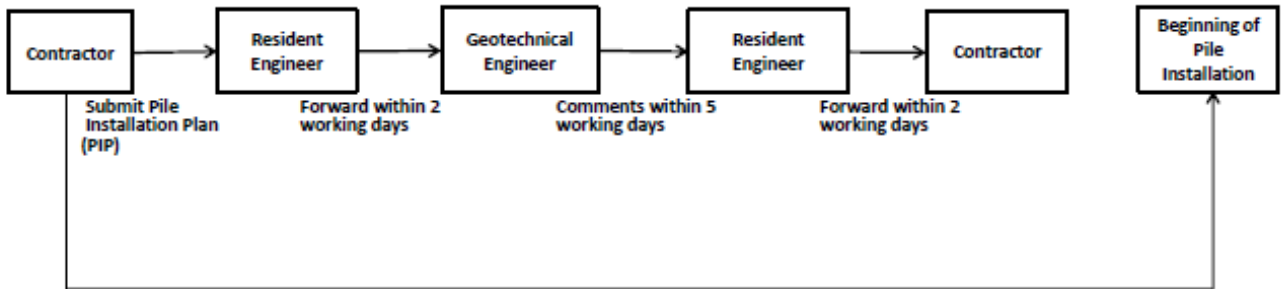

Contractor shall submit PIP at the preconstruction conference or 30 days prior to beginning of pile driving

PRODUCTION PILE LENGTHS-PERMANENT PILES

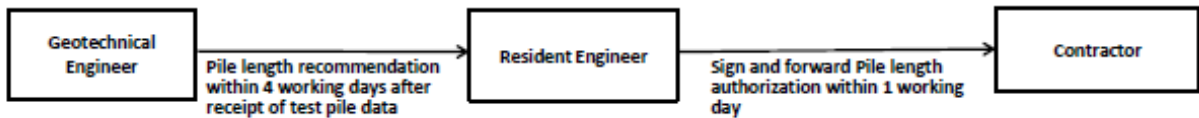

DRIVING CRITERIA-PERMANENT PILES

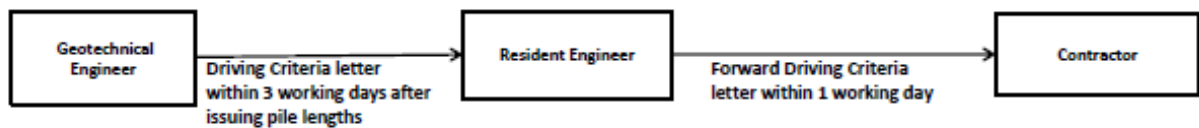

PILE LENGTHS AND DRIVING CRITERIA-TEMPORARY PILES

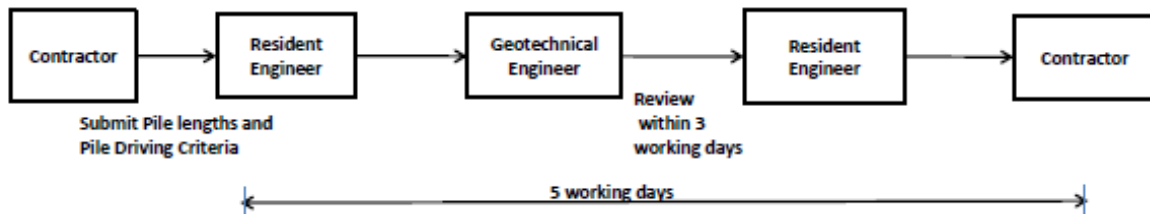

Section 10.2

PRECAST PRESTRESSED CONCRETE COMPONENTS

10.2.1 Purpose

To provide a process for the inspection, evaluation and disposition of prestressed concrete components including those not in compliance with the contract plans and specifications.

10.2.2 Authority

Sections 20.23(4)(a) and 334.048(3), Florida Statutes (F.S.)

10.2.3 Reference

Section 450, "Precast Prestressed Concrete Construction," Standard Specifications for Road and Bridge Construction

10.2.4 General

The responsibility of quality assurance (QA) during the production of prestressed concrete components is a primary function of verification inspection staff at the casting yard. The Construction Engineering Inspection (CEI) staff is primarily responsible for QA once components leave the casting yard and are shipped to the project site. Such efforts by CEI staff at the jobsite include inspections for damage during handling and erection, for defects discovered after delivery as well as overall compliance with the Contract Documents.

CEI staff must verify that prestressed products are stamped by the producer and that delivery tickets are signed and stamped and accompany all precast products that arrive at the jobsite in accordance with requirements of the **Materials Manual**. Delivery tickets must also be verified to contain certification of compliance with Buy America requirements.

10.2.5 Noncomplying Products

When major defects occur on prestressed products as defined in **Specification 450-12**, an Engineering Analysis Scope and ensuing Engineering Analysis Report (EAR) are required to be submitted to the Department, when required. The Producer may use a previously approved EAR with the permission and reevaluation of the deficiency by the original engineer for the disposition of an individual major defect. The Producer of a prestressed concrete product is the party expected to directly address the disposition of defects;

however, the Contractor always has the total and final responsibility for the quality of all products incorporated on a project and must concur with all Producer proposals prior to review by the Department.

Noncomplying components containing specific defects or damage which are classified as minor by **Specification 450-12** are not covered by this procedure and are not subject to the disposition requirements in this procedure but instead must be repaired in accordance with **Specification 450-13**. However, if for a minor defect, an alternate nonstandard repair method not covered by **Specification 450-13** is proposed by the Producer or if the defect will be encased within the diaphragm concrete, then the same procedure outlined for major defects applies.

Precast prestressed products which require repair shall not be shipped to the project site from the casting yard until such repairs are complete and the product has been accepted by the Department. If the product is repaired and determined to be acceptable to the Department, the product may be stamped by the Producer as approved. Producer-stamped prestressed products arriving at the job site shall not be rejected by project personnel for reasons other than obvious shipping damage or other incurred major defects which makes the product unacceptable. If the CEI personnel on the project site have questions about the acceptability of stamped components, these questions shall be resolved only after consulting with the District Materials Verification personnel at the shipping point.

Beam end defects that begin within the limits of the diaphragm and extend beyond the limits of the diaphragm must be repaired prior to diaphragm construction. Cleaning and preparation of all defects prior to diaphragm concrete placement shall be in accordance with the Specification or as approved by the Engineer.

10.2.6 Repair Proposal Requirements

The Contractor's proposal must be prepared in accordance with **Specification 6-4.1** and **450-12** and the following:

- (A) A completed **Noncomplying Prestressed/Precast Concrete Component Data Sheet (NCR)**, [Form No. 700-030-10](#), prepared by the Producer or Contractor and countersigned by the District Materials and Research Office (DMRO) or designee to indicate agreement with the described defect or noncompliance feature. If not in agreement with the information or description, the DMRO shall either reject the submittal indicating reason(s) for rejection or comment on the submittal as necessary. In the latter event, the preparer shall address any comments made. Supporting information may be attached including photos, sketches, crack maps or other records on the NCR.

- (B) An EAR Scope is prepared and submitted by the Contractor (when applicable).
- (C) The District Structural Materials Engineer (DSME) evaluates the EAR Scope, accepting and/or commenting as necessary.
- (D) An EAR signed and sealed by the Contractor's Engineer of Record is submitted to the DSME for disposition.

10.2.7 Review and Evaluation

(A) Resident Level Responsibilities

The PA will issue the official Department response to the Producer's EAR repair proposal upon consultation with the DSME for his or her recommendations on the disposition of the EAR. The Project Administrator must consult the Engineer of Record, and if necessary the District Construction Office and DMRO of the District in which the products are produced. For Category I structures, the Project Administrator must also receive concurrence from the District Structures Design Engineer. For Category II structures, the Project Administrator must receive concurrence from the State Construction Structures Engineer.

(B) District Level Responsibilities

The DSME will review the Contractor's Engineering Analysis Scope and either accept or reject/revise it. Upon acceptance of the Engineering Analysis Scope, the Contractor will submit a signed and sealed EAR or provide a previously used EAR repair method. When warranted the DSME will enlist the assistance of various offices within the Department (State Construction Office, District Structures Design Office, State Structures Design Office, State Materials Office) and the Engineer of Record, as deemed appropriate.

Upon completion of the evaluation, the DSME will make a recommendation to the Project Administrator of acceptance of the Contractor's EAR, recommend that a more satisfactory repair method be proposed or recommend rejection of the EAR. Department costs associated with proposal review shall be addressed per **Specification 450-12.2**.

10.2.8 Disposition and Distribution

(A) Resident Level Responsibilities

Upon acceptance of the Contractor's EAR, the Project Administrator shall enter the findings into MAC and grant the Producer permission to proceed with repairs and submit the proposal and the disposition to the appropriate District and State personnel in addition to the following:

1. Collaboration site and/or EDMS
2. State Materials Office
3. DSME

The Department's Official response as transmitted by the Project Administrator will require one of three actions by the Producer as follows:

Correct: The Producer will be permitted to correct the defect and the correction may be witnessed by the DMRO. A credit to the Department may be required since the defective component, even if satisfactorily repaired, is not considered by the Department to be fully equivalent to a component that has never had a defect.

Reject: The Producer will not be permitted to correct the defect and the component must not be used on any Department project.

Revise: The Producer's EAR proposal is such that the Department cannot make a final decision about the proposal due to incomplete or unclear information and therefore, the Producer has the option of revising the EAR proposal and then resubmitting it to the Department.

If the Producer disagrees with any of the three (3) actions above, the Producer may appeal to the DCE of the project District for a hearing. The DCE shall have the discretion to hear or not hear the appeal but if heard, will make the final decision on the disposition of the defect.

Section 10.3

CONCRETE CONSTRUCTION

10.3.1 Purpose

The purpose of this section is to ensure that CEI and Materials staff are aware of the inspection and monitoring responsibilities required to ensure quality cast-in-place concrete construction. This procedure is primarily intended to be used by CEI staff experienced in bridge construction.

10.3.2 Authority

Section 20.23(3)(a), Florida Statutes

Section 334.048(3), Florida Statutes

10.3.3 References

Section 336.045, Florida Statutes

Florida Department of Transportation, *Standard Specifications for Road and Bridge Construction*

10.3.4 Bridge Decks

10.3.4.1 General

To verify the total thickness and the thickness of the concrete cover over the top mat of reinforcing steel in bridge decks, thickness measurements shall be made in the plastic concrete directly behind the final pass of the screed. A minimum of two measurements - the first representing the concrete thickness over the top mat of reinforcing steel and the second representing the thickness of the deck concrete - shall be made for each five hundred square feet of bridge deck. Measurement locations shall be spaced randomly to represent all areas of the bridge deck.

10.3.4.2 Measurements - Total Deck Thickness

Measurements for deck thickness must be taken from the top of the deck to the top of forms in the portion of the deck between beam flanges or bays, in order to avoid including beam buildups in the measurement. For corrugated stay-in-place forms, total deck thickness measurements shall be taken from the upper surface of the corrugation. The use of aluminum probing/measuring devices is prohibited.

10.3.4.3 Measurements - Concrete Cover Thickness

Measure the thickness of the concrete cover over the top mat of reinforcing steel by inserting a metal plate edgewise into the plastic concrete to the top mat of reinforcing steel. Orient the plate so that it is transverse to the topmost reinforcing bars. The plate should be in contact with at least two transverse reinforcing bars to ensure an accurate measurement.

10.3.4.4 Documentation

Record thickness measurements in a permanent hardbound or electronic field notebook to be submitted with the final estimate records. The notebook shall contain the information that follows. Include in the notebook, all items necessary to provide clarity. Each bridge shall be listed separately. Information regarding the thickness measurements shall include the following under the appropriate span number:

- Financial identification number
- Contract number
- Bridge number and name (if applicable)
- Deck placement location (Station to Station)
- Offset distance right or left of centerline or profile grade line
- Date
- Time period (from AM/PM to AM/PM)
- Inspector's name
- The average thickness of concrete cover over the top mat of reinforcing steel with the average deck thickness computed for each deck concrete placement

District Construction Engineers or assigned designees are requested to monitor these records and assure compliance with specified plan dimensions. These measurements are made to provide the basis for making

corrections to deficient placements and corrections to construction techniques prior to subsequent deck placements.

10.3.5 Mass Concrete

10.3.5.1 Background

During the curing process mass concrete elements generate high temperatures at their cores relative to those at their exterior surfaces. The term mass concrete refers to a designation given to concrete elements wherein control of concrete temperatures during the curing process is vital to an element's strength and durability while in service. The classification of an element as "mass concrete" typically is thought of as being due solely to volumetric and dimensional aspects of the element. While it is true that mass concrete is most often a concern for larger concrete elements, to assume that only such elements require mass concrete control provisions is incorrect as there are other aspects to be considered beyond just an element's geometry.

Per the Specifications, concrete temperatures must not exceed 180°F at the core and temperature differentials between the core and exterior must be under 35°F. If these temperature limits are exceeded, there is the potential for crack formation or the development of delayed ettringite formation (DEF), a mineral byproduct of the curing process which can lead to reduced concrete strengths and/or cracking in the future.

To prevent temperature levels from exceeding the limits in the Specification, the Contractor must take action to utilize a suitable concrete mix design as well as properly insulate exterior surfaces of the concrete and where required, actively cool the core of the concrete component. These provisions must be detailed in the **Mass Concrete Control Plan (MCCP)**, a signed and sealed submittal developed by the Contractor's Specialty Engineer that also includes calculations of predicted temperatures during curing. The MCCP must be submitted and approved by the Department before construction of any mass concrete component can begin. The Contractor must demonstrate per the MCCP that temperature differentials and maximum core temperatures are being properly monitored by temperature monitoring devices within the concrete, to be read at 6-hour intervals or less.

10.3.5.2 Submittal and Acceptance of the Mass Concrete Control Plan

(A) Resident Level Responsibilities

The Contractor will be required to submit a **MCCP** to the Project Administrator at least 14 days prior to the first mass concrete placement.

The Project Administrator will review the Contractor's proposed **MCCP** for compliance with the requirements as set forth in the **Specifications**.

Within two working days of receipt of any **MCCP**, the Project Administrator will forward the **MCCP** along with his comments to the District Structural Materials Engineer or District Manager-Concrete Production and the State Structural Materials Engineer for their review.

The Project Administrator will notify the Contractor of either **MCCP** acceptance or rejection within ten working days of **MCCP** submittal by the Contractor. The Project Administrator may also request any additional information required and necessary **MCCP** re-submittals from the Contractor. Additional information required may extend the review and acceptance time. A **MCCP** re-submittal may require as much as an additional ten working days for review and acceptance which will be determined by the State Materials Office Reviewer.

Project Administrator: Mass concrete must not be placed before the Contractor has received the Department's full approval of the **MCCP**.

(B) District Level Responsibilities

The District Structural Materials Engineer or District Manager-Concrete Production will review all **MCCPs** upon notification from the Project Administrator. The District Structural Materials Engineer or District Manager-Concrete Production will transmit his comments to the State Structural Materials Engineer within five working days of receipt of the **MCCP**.

(C) Central Office Level Responsibilities

The State Structural Materials Engineer will timely review the **MCCP**, including comments from the Project Administrator and the District Structural Materials Engineer or District Manager-Concrete Production, documenting either **MCCP** acceptance or rejection with any qualifying notes or reasons for rejection, and notify the Project Administrator and the District Structural Materials Engineer or District Manager-Concrete Production accordingly. Reviews will be made so as to permit notification to the Contractor by the Project Administrator within ten working days from **MCCP** submittal. Any additional information required from the Contractor will be requested through the Project Administrator. Requirements for additional information may extend the time necessary for review. A **MCCP** re-submittal may require an additional ten working days for review and acceptance.

10.3.5.3 Implementation of Accepted Mass Concrete Control Plans

(A) Resident Level Responsibilities

The Project Administrator shall verify that the following Contractor actions are performed in compliance with the **Specifications** and the approved **MCCP**:

- (a) Mass concrete components are instrumented for measuring and recording temperature readings according to the approved **MCCP**.
- (b) The Mass Concrete Specialty Engineer, or his designee, has inspected the installation and has confirmed that it has been installed properly and functions according to the approved **MCCP** in accordance with the **Specifications**.
- (c) Temperature readings are obtained at intervals required by the **Specifications**. Temperature readings for a given element may be terminated only when all monitoring points within the element depict decreasing core temperatures and temperature differentials are in accordance with the **Specifications**. The Project Administrator shall verify that temperature readings are not discontinued until decreasing temperature differentials have been definitively confirmed. One or two temperature readings below the previous reading may not necessarily indicate that the maximum temperature differential has been reached. Temperature control mechanisms are to be left in place until core

temperatures are within 50°F of ambient temperature.

- (d) Temperature readings are analyzed in a timely manner. The Contractor takes immediate action as directed by the Specialty Engineer if mass components exceed either the allowable temperature differential or core temperature during the monitoring period.
- (e) The **MCCP** will be revoked when temperature control provisions have failed to prevent the temperature differential or the maximum core temperature from being exceeded. Revisions to the **MCCP** must be submitted to the Department for approval before any other mass placements can proceed.
- (f) In addition, for any noncompliant mass element an **Engineering Analysis Scope** must be submitted by the Contractor that describes the proposed approach in correcting the noncompliant element. If the **Scope** is approved, an **Engineering Analysis Report (EAR)** may be submitted by the Contractor's Engineer of Record containing the engineering analysis and recommended corrective actions to the noncompliant element.

Concrete temperatures and temperature differentials will vary with local ambient temperatures, heats of hydration produced by different cements, cement contents, cementitious material combinations, element geometry and other factors. The Contractor may request approval for reduced monitoring. The **Specifications** set forth the requirements necessary for reduced monitoring to be approved. The Project Administrator may allow reduced monitoring based on these requirements and previous successful implementations of the **MCCP** and compliance with the **Specifications**.

The Project Administrator will require all mass concrete temperature monitoring records for the project files within three days of the completion of temperature monitoring. The Project Administrator will forward all mass concrete temperature monitoring records to the District Structural Materials Engineer or District Manager-Concrete Production. The Project Administrator will review all mass concrete temperature monitoring records to ensure compliance with project **Specifications**.

Although established models are used to prepare **MCCPs**, maximum allowed temperature differentials may, at times, be exceeded when the Contractor

has an accepted **MCCP** and has adhered to the **MCCP** requirements. In such instances, the Project Administrator will ensure that:

- (a) The Contractor takes immediate action to limit further increase of temperature differentials or maximum core temperatures for that element.
- (b) The Contractor's submitted revisions to the **MCCP** address maintaining temperature differentials or core temperatures within the limit allowed by the specifications for future Mass Concrete placements.

When the maximum allowed mass concrete temperature and/or temperature differential is exceeded, the Project Administrator will transmit the Contractor's revised **MCCP** and the subsequent **Engineering Analysis Scope** to the District Structural Materials Engineer or District Manager-Concrete Production for review and acceptance.

(B) District Level Responsibilities

The District Structural Materials Engineer or District Manager-Concrete Production will review and keep all mass concrete temperature monitoring records so he may advise the Project Administrator on mass concrete temperature control. These records shall include all temperature readings taken during curing. These records shall be transmitted to the District Structural Materials Engineer or District Manager-Concrete Production as soon as possible after collection. The District Structural Materials Engineer or District Manager-Concrete Production monitors the readings in order to determine if a Quality Assurance review is needed or if modification to the **MCCP** is necessary.

When the Contractor has an accepted **MCCP** and mass concrete temperature differentials or core temperature limits are exceeded, the District Structural Materials Engineer or District Manager-Concrete Production will review the Contractor's proposed revisions to the **MCCP** and the **Engineering Analysis Scope** for the noncomplying element. If the **Scope** is approved, the Contractor's Engineer of Record may submit an **EAR**. The District Structural Materials Engineer or District Manager-Concrete Production will review the **EAR** and make a recommendation of acceptance

or rejection of the noncomplying mass element to the Project Administrator. The District Structural Materials Engineer or District Manager-Concrete Production will notify the Project Administrator of the Department's acceptance or rejection of the Contractor's proposed revisions to the **MCCP** with any qualifying requirements or reasons for rejection.

10.3.6 Crack Inspection

(A) Resident Level Responsibilities

10.3.6.1 Crack Inspection

Concrete components must have all visible surfaces inspected for cracks on the following three cycles:

- (1) As soon as concrete surfaces are fully visible after casting
- (2) Between 7 and 31 days after the component has been burdened with all dead loads, except for loads from components cast or mounted to the deck, and before Class 5 finish has been applied, if required in the Plans.
- (3) A minimum of 7 complete days after the bridge is fully open to the public for unrestricted use. Inspection of decks may be an exception to this cycle of inspection since close observation of all surfaces may not be justified if traffic disruption and/or maintenance of traffic costs are excessive as judged by the Project Administrator.

Unless there is a strong suspicion that cracks exist in the faces of buried components, inspection cycle 2 and 3 are not required for these components or for any other component faces that are permanently hidden from view. For underwater components per **CPAM 10.6**, inspection cycle 2 is not required unless there is strong suspicion of cracks whereas inspection cycle 3 is always required.

Concrete cracks are often only a few mils (1/1000 inch) wide and can be very hard to find. To aid in finding these cracks, use of the following equipment and methods should be considered:

- A magnifying glass
- Artificial light
- Spraying the concrete surface with water or observing it after it has

rained and is still damp

10.3.6.2 Documenting Observations

Document and maintain a record of each crack inspection indicating dates of inspection for all cast-in-place concrete elements, including those not exhibiting cracks at the time of inspection. Document all concrete cracks including width, length, depth (if possible), termination points, and location of cracks relative to a fixed reference point. A pocket microscope must be used to measure cracks 25 mils wide or less. Cracks that are less than 4 mils wide (hairline cracks) require less rigorous documentation as explained below. For bridge decks, perform all final deck crack measurements, after profile grinding and before transverse grooving. With concurrence of the District Materials Office, request that selected cracks be cored by the Contractor when an accurate measurement of crack depth cannot be determined by use of a mechanical probe. Consult with the District Materials Office and/or the State Materials Office for guidance and approval of location, depth and size of cores so that the most information will be gathered with the least effort and damage to the concrete. Documented cracks shall be monitored at an appropriate interval such as once a month as determined by the Project Administrator with input from the Engineer of Record (EOR) and State Construction Structures Engineer to determine if they are dormant or are active and continuing to grow. The date that cracks were first observed, and if known, what caused them shall be documented. Immediately report all cracks to the Project Administrator so that their status can be addressed appropriately.

Detailed sketches or "Crack Maps" shall be prepared to scale in order to document the width, length, depth and location of all cracks discovered as specified above, including the name of the Inspector, date, weather conditions and other pertinent circumstances under which the cracks were discovered. Hairline cracks may be drawn in their approximate location on the Crack Map with a reference dimension from the edge of a component face to one end of the crack. For hairline cracks, location of both termination points, crack length, and depth are not required. If cracks are found, the CEI Inspector must notify the Project Administrator and/or Senior Project Engineer to determine what action should be taken to address the cracking.

All crack maps, inspection documentation and related documents must be entered into the Electronic Document Management System (EDMS) before the project is complete.

10.3.6.3 Disposition of Cracks

Follow the correct crack disposition administrative process as described in the ***Crack Inspection and Repair Flow Chart, Attachment 10.3.6***, for structural and nonstructural cracks. The Senior Project Engineer or Project Administrator shall determine if the cracks are structural or nonstructural. See ***Specification 400-21*** for a definition of structural and nonstructural cracks. If technical assistance is needed to do this, consult the Construction Project Manager, EOR and District Structures Design Engineer for Category 1 bridges or the State Construction Structures Engineer for Complex Superstructure Members of Category 2 bridges. Cracks in the top slab of culverts that will be covered by embankment do not require repair as long as the EOR and District Structures Design Engineer agree that repair is unnecessary. For Category 2 bridges, the State Construction Structures Engineer will make the final determination of structural or nonstructural if the CEI staff is unable to do so.

If cracks are determined to be nonstructural, then the specific corrective action required of the Contractor is listed in Table 1 or 2 of ***Specification 400-21***. However, to select the correct table listing, ***Specification 400-21*** requires the Project Administrator to determine a number of parameters including a representative surface area that a group of cracks falls within for measuring the significance of the cracks. The ***Specification*** refers to this surface area, measured in square feet, as a LOT.

Within a LOT, the greater the surface area is of all the cracks added together, the greater is the significance of the cracking as well as the corresponding action required to repair the cracks. The Project Administrator will have to use judgment in determining the area of a LOT and ***Section 10.3.6.4*** provides guidance for how best to do this. However, when a crack is too isolated to be grouped with other cracks to form a LOT (see LOT definition in ***10.3.6.4***) then by using the respective table in ***Specification 400-21***, a repair can be determined by first computing the average crack width (see Key of Abbreviations and Footnotes, Footnote (1), in ***Specification 400-21*** for how to compute the average crack width).

Once the average crack width is known, then select the appropriate table row for Crack Width Range that the average crack width falls within. Where this range horizontally intersects the appropriate table column for the Cracking Significance Range that is labeled "Isolated," will be the table entry for the required repair. When a LOT consists of more than one crack, the Project Administrator will determine the cracking significance and required repair for each crack by using **Tables 1 or 2**. This shall be done by first selecting the applicable Elevation Range then select the applicable Crack Width Range that the crack width of each individual crack falls within. Next, using the selected Crack Width Range, select the corresponding Cracking Significance Range in accordance with **Specification 400-21.3.1**, to identify the required repair method.

For structural cracks, the Contractor must submit an Engineering Analysis Scope, signed and sealed by the Contractor's Engineer of Record, to determine the strength and durability of the Contractor's proposed repair. Once the Scope is approved an Engineering Analysis Report (EAR) may be submitted. If the project is a Category 1 bridge or a miscellaneous structure, the District Structures Design Office will review the Contractor's proposed repair as depicted in the EAR. If the project is a Category 2 bridge, the State Construction Office will review the Contractor's proposed repair as depicted in the EAR. The ultimate decision to accept or reject the Contractor's proposed repair rests with the District Construction Engineer who shall take into consideration the recommendations of the State Construction Structures Engineer or District Structures Design Engineer.

For all concrete cracking, it is the CEI's responsibility to utilize independent engineering judgment regarding LOT selection, significance and proposed disposition of all cracked concrete.

10.3.6.4 LOT Size Determination

- (a) **Deck Surfaces** - Determine LOT size as Follows (see **Attachment 10.3.6-1, LOT Size Determination Examples**, for example drawings):
- Measure the "Longitudinal Crack Range (L_{cr})" and the "Transverse Crack Range (T_{cr})" when two or more cracks exist.

Where: L_{cr} is the longitudinal distance from the first crack to the last crack in the LOT as measured by a tape in direct contact with the concrete surface and on an alignment parallel to the centerline of construction. Since cracks usually have an irregular alignment that is not a straight line, the distance from the first to last crack should start at the point on the first crack that represents the farthest possible point out and end at a point on the last crack that is the farthest out. This results in the maximum value of distance between the first and last crack.

T_{cr} is the transverse distance from first to last crack in the LOT as measured by a tape in direct contact with the concrete surface and on an alignment that is 90 degrees to the centerline of construction.

- Multiply L_{cr} times T_{cr} to get the "Preliminary Area" (A_p) of the LOT.
- If A_p is less than or equal to 100 square feet (ft^2) then use 100 ft^2 for the "Final Area" (A_L) of the LOT.
- If A_p is greater than 100 ft^2 but less than 400 ft^2 then use A_p for A_L .
- If A_p is greater than 400 ft^2 then create 2 LOTs.
- If A_p is greater than 800 ft^2 then create 3 LOT's and so on.

(b) Surfaces Other Than Decks (footings, columns, caps, walls, etc.)

– A LOT must be contained within a single concrete face of a member (side, top, or bottom). Determine LOT size as Follows (see **Attachment 10.3.6-1** for example drawings):

- For vertical or predominantly vertical faces (sides of footings, columns and caps, etc), measure the Crack Range of the height dimension (H_{cr}) and the Crack Range of the width dimension (W_{cr}) when two or more cracks exist.

Where: H_{cr} is the distance from the first crack to the last crack as measured by a tape in direct contact with the concrete

surface, including curved surfaces, and on an alignment that is vertical.

W_{cr} is the distance from the first crack to the last crack as measured by a tape in direct contact with the concrete surface, including curved surfaces, on a width alignment that is level.

- Multiply **H_{cr}** times **W_{cr}** to get the **A_p** of the LOT.
- If **A_p** is less than or equal to 25 ft² then use 25 ft² for the **A_L** of the LOT.
- If **A_p** is greater than 25 ft² but less than or equal to 100 ft² then use **A_p** for **A_L**.
- If **A_p** is greater than 100 ft² then create 2 LOTs.
- If **A_p** is greater than 200 ft² then create 3 LOTs and so on.
- For horizontal and predominately horizontal faces (tops and bottoms of footings and caps, etc.), measure the Crack Range of the longitudinal (parallel to the centerline of construction for the bridge) dimension (**L_{cr}**) and the Crack Range of the transverse (90 degrees to centerline of construction) dimension (**T_{cr}**) when two or more cracks exist.

Where: **L_{cr}** is distance from the first crack to the last crack as measured by a tape in direct contact with the concrete surface, including curved surfaces, and on an alignment that is longitudinal.

T_{cr} is the distance from the first crack to the last crack as measured by a tape in contact with the concrete surface, including curved surfaces, and on an alignment that is transverse.

Determine LOT size for horizontal surfaces as specified for vertical surfaces above, using **L_{cr}** and **T_{cr}** instead of **H_{cr}** and **W_{cr}**.

10.3.7 Notifying the District Materials Office of Concrete Placements, Pre-operations Meetings, Reduced Concrete Sampling Frequencies and the Occurrence of Lumps and Balls

(A) Resident Level Responsibilities

10.3.7.1 Concrete Placements

The Project Administrator shall notify the District Structural Materials Engineer or District Manager-Concrete Production of the anticipated date and time of a placement whenever there is a cast-in-place (CIP) concrete placement that requires Construction Training and Qualification Program (CTQP) Qualified Concrete Field Technicians to perform field sampling and testing of concrete. Provide notification at least 48 hours prior to the beginning of the concrete placement whenever possible. Include in the notification names of technicians performing Verification Testing (VT) on behalf of the Department and if possible names of technicians in the Contractor's Quality Control Plan (CQCP) as listed in the Departments Materials Acceptance and Certification System (MAC) that will be performing field sampling and testing of the concrete.

10.3.7.2 Pre-operations Meetings

The Project Administrator shall notify the District Structural Materials Engineer or District Manager-Concrete Production or designee at least 5 days prior to pre-operations meetings at which Department, CEI, Contractor, Concrete Producer and other involved personnel discuss a planned first-time placement of a significant CIP concrete component for any project (bridge, roadway, drainage, etc.). The Project Administrator should encourage the Contractor to invite a representative of the concrete producer to attend the pre-operations meeting.

10.3.7.3 Reduced Concrete Sampling Frequencies

Specification 346-9.2.1, allows the Contractor to reduce the frequency of concrete acceptance testing from every 50 cubic yards to every 100 cubic yards when a series of consecutive strength tests meet given criteria per the **Specifications**. The number of consecutive strength tests required for reduced frequency varies depending upon the class of concrete being used.

Requests for reduced sampling frequency must be approved by the Engineer and are allowed if mix designs are the same and produced at the same production facility on a given Contract.

Prior to the first concrete placement of the project, the Project Administrator shall make the Contractor aware of this specification provision. When the Contractor requests a reduced sampling frequency, the Project Administrator shall obtain District Materials Office approval of the request prior to responding to the Contractor.

Once approval is given and the Contractor commences sampling at the reduced frequency, the Project Administrator shall monitor the Contractor's sampling and testing performance in order to verify that the specification criteria are being consistently met. If specification criteria are not being met with reduced sampling frequency, a return to the 50 cubic yard frequency will be instituted.

10.3.7.4 Occurrence of Lumps and Balls

When concrete is delivered to the project containing lumps and balls, which require removal prior to placement, the Project Administrator shall notify the District Materials Office as soon as possible. Conveyance equipment used during concrete placements with slump targets of 6 inches or greater are required to have grates installed for capturing lumps and balls.

10.3.8 Observing Concrete Consistency

(A) Resident Level Responsibilities

A CTQP qualified Concrete Field Technician (CEI or Contractor) shall observe the consistency of the concrete as discharge begins for each truck arriving at the project site. The technician shall look for signs of excessive dryness or wetness and if in the technician's judgment, one of these conditions exists then discharge shall be stopped and a slump test shall be performed to verify that the concrete consistency is within the slump tolerance range. This shall also be done for loads that are scheduled for acceptance testing. If the slump test shows an out of tolerance condition then, per the specification, the load is considered as rejected. Placement of

concrete that has already commenced prior to a failing plastic properties test will be accepted at reduced pay.

Prior to the start of any concrete placement on the project, the PA shall consult with the Contractor as to which technicians (CEI, Contractor or both) will be assigned the responsibility for observing concrete consistency as required above. Once an agreement is reached, the PA shall verify that the assigned technician, whether CEI or Contractor, is present and observing the concrete consistency during the initial discharge of all concrete loads.

Section 10.4

COATINGS AND ASBESTOS REMOVAL, HANDLING AND DISPOSAL AND STRUCTURAL STEEL COATING ISSUES

10.4.1 Purpose

To ensure hazardous or potentially hazardous waste including toxic metal (lead, cadmium, zinc, chromium, etc.) based paint residue or other waste material removed from bridges during repair, painting, demolition or disposal projects is identified, handled, stored, transported and disposed of in accordance with applicable local, state and federal regulations.

To ensure that asbestos-containing materials (ACM) are removed, handled, stored, transported and disposed of in accordance with the applicable local, state and federal regulations and to ensure that the human and natural environment are protected from exposure to airborne asbestos fibers.

The purpose is to heighten the awareness of Construction Engineering and Inspection (CEI) personnel (in-house and consultant) with regard to critical responsibilities for managing steel structure coating projects.

10.4.2 Authority

Section 20.23(3)(a), and 334.048(3), Florida Statutes (F.S.)

10.4.3 Reference

29 CFR 1910

29 CFR 1926.62

29 CFR 1926.1101

40 CFR 61

40 CFR 261.24

40 CFR 763

Florida Department of Transportation Loss Prevention Manual (Topic No. 500-000-015)

Florida Department of Transportation Procedure Number 500-000-015, Loss Prevention Manual

Florida Department of Transportation, Standard Specifications for Road and Bridge Construction, Section 8-4, 110, 560 and 561

Florida Department of Transportation, Construction Training and Qualification Manual (CTQM), Chapter 8, Topic No. 700-000-001

10.4.4 Paint and Asbestos Removal, Handling and Disposal

10.4.4.1 General

Ensure that all painting, repainting, spot painting, removal or repairs that involve removal of materials that contain hazardous waste is done in conformance with this procedure and all local, state and federal regulations. The disposal of existing structures containing hazardous waste must also comply.

Ensure that the identification, abatement, handling and disposal of asbestos-containing materials are done in conformance with local, state and federal asbestos regulations and this procedure.

10.4.4.2 Construction Activities – Hazardous Coatings and Asbestos Removal

(A) Resident Level Responsibilities

- (1) The Project Administrator must ensure that the Contractor's work plan and schedule complies with requirements of the **Specifications**. For removal of coatings containing hazardous materials, the Contractor's Lead in Construction Compliance Program must also meet the requirements of the Specifications. Ensure that the Contractor doing the painting and/or removal holds a QP2 certification from the Society for Protective Coatings (SSPC), Painting Contractor's Certification Program and that the certification remains active for the duration of the project. The Contractor shall not begin construction involving hazardous materials and coatings until the work plan has been reviewed and approved.
- (2) CEI inspectors involved in the inspection of paint projects must have proof of

successful completion of a bridge coating inspection course accredited by the Florida Department of Transportation prior to the start of work. For projects that have significant amounts of hazardous waste removal, CEI staff must have a certificate for successful completion of the following SSPC course: C-3, Lead Paint Removal. For a determination of what is deemed significant hazardous waste removal versus what is incidental, contact the State Chemical Material Systems Engineer of the State Materials Office. The CEI staff must also ensure that the Contractor conforms to the site-specific specification.

Provide all inspection personnel with the safety and environmental considerations required in accordance with **29 CFR 1926.62**.

- (3) All removal and disposal of existing structures and related debris containing hazardous waste shall be performed in accordance with the specifications and all local, state and federal regulations.
- (4) If asbestos containing materials (ACM) are identified on a bridge, an Asbestos Abatement Plan to remove the ACM must be developed by a Licensed Asbestos Consultant (LAC). The Asbestos Abatement Plan must be included in the scope of work for bridge demolition/renovation. Any asbestos abatement activities must be completed prior to bridge demolition and prior to conducting renovations that may disturb ACM.

If ACM were not identified prior to the construction phase, the Project Administrator shall notify the District Contamination Assessment Coordinator who will obtain the services of the Department's Asbestos Contractor or Contamination Assessment/Remediation Contractor (CAR) or a LAC, as appropriate, to determine the existence, nature and quantities of any suspect ACM and if needed, develop an Asbestos Abatement Plan. All removal, handling, storage, staging, transportation and disposal of existing structures containing ACM shall be performed in accordance with the site-specific asbestos abatement plans and specifications. The Project Administrator shall submit a notification to the Department of Environmental Protection (DEP) or the appropriate delegated local government agency prior to any bridge demolition, even if ACM is not identified using **DEP Form 62-257.900(1) Notice of Asbestos Renovation or Demolition**. The Contractor shall coordinate the work with the Engineer and the Department's CAR Contractor for the safe removal, handling, transportation and disposal of ACM prior to the commencement of any renovation or demolition activities. A staging area for the handling of asbestos-containing materials may be required.

10.4.5 Structural Steel Coating Issues

10.4.5.1 General

(A) Resident Level Responsibilities

10.4.5.2 Monitoring for Compliance with Non-Department Documents

Obtain copies of all documents referenced in the **Specification 560 and 561** that are published by Non-Department sources for the duration of the work. Verify Contractor compliance with these documents in the **Daily Work Report** or other appropriate project record. If the Contractor is not in compliance then the Project Administrator shall take appropriate action to correct the noncompliance.

10.4.5.3 Coating Inspection

The following issues shall be given special attention and their importance shall be emphasized in meetings and discussions with the Contractor.

- 1) **Coating of bolts:** Verify that bolts are prepared properly before painting and that they meet the specification cleanliness requirements before any paint is applied. Surfaces and edges of bolt heads and nuts must have the specified coating thickness and coverage, gaps between nuts and washers and between washers and plates must be sealed. When the Contract Documents call for bolts to be stripe coated by brush, verify that no other application method except a brush is used. See **Specification 560-9.7, 560-10 and 561-9** for requirements related to coating of bolts.
- 2) **Surfaces that are visually difficult to inspect and access:** Pay particular attention to surfaces that are difficult to view and access and reinspect them as often as necessary to confirm that proper cleaning and coating has been performed. Particular attention should be given to areas where stripe coats are used.
- 3) **Caulking gaps and seams:** Verify that caulking of cracks, crevices and joints open less than ½ inch is performed in accordance with **Section 560-9.3** after intermediate coats have cured and prior to application of finish coats.
- 4) **Testing for chloride, sulfate and nitrate concentrations:** Testing for the presences of chlorides, sulfates and nitrates on surfaces to be painted is the responsibility of the

Contractor. The concentration of these contaminants is determined by using a Soluble Salts Test Kit. Testing is performed after washing and after the application of each coat of the coating system. Inspectors must be knowledgeable about this testing process in order to perform Contractor verification. See **Section 560-7.5 and 561-6.5**, for this testing.

- 5) **Stripe Coating:** *Specifications 560-9.7 and 561-8.7* require the stripe coating of welds, corners, crevices, sharp edges, bolts, nuts, rivets, and rough or pitted surfaces. Verify that two stripe coats are applied or that the correct number of coats are applied as specified by the Contract Documents.

Section 10.5

DRILLED SHAFTS

10.5.1 Purpose

To establish a procedure to monitor and document the installation of load test, methods and production drilled shafts for bridge and non-bridge structures and obtain drilled shaft lengths for bridges. This procedure applies to conventional projects; for Design Build projects refer to **Section 10.12**.

10.5.2 Authority

Sections 20.23(3)(a), and 334.048(3), Florida Statutes (F.S.)

10.5.3 References

Section 455, Standard Specifications for Road and Bridge Construction and any supplements thereto

10.5.4 Scope

The principal users of this document include the State Construction Office District Materials and Research Offices (DMRO), District Construction Offices (DCO), District Operations Centers, the State Materials Office (SMO), and Construction Engineering and Inspection (CEI) firms working for the Department.

10.5.5 Definitions

District Construction Engineer (DCE): The authority on the entire construction activity in the District.

Construction Engineering and Inspection (CEI): In this procedure, it refers to the Consultant personnel performing CEI services or the Department's personnel group performing CEI services.

Geotechnical Engineer: In this procedure, the Geotechnical Engineer may be the District Geotechnical Engineer (DGE), any Department Engineer assigned for the project by the DGE, the Consultant Geotechnical Engineer working directly for the DGE, or the Geotechnical Engineer employed by the Department's Consultant CEI performing under the direction of the DCE and DGE.

Project Administrator (PA): The Administrator who shall be responsible for the everyday construction activity at the project under the direction of the Resident Engineer/Senior Project Engineer.

Resident Engineer (RE): The Department's local area representative who reports directly to the DCE and may be either a Department employee of the District or an employee of an engineering firm which is serving as the Department's Consultant CEI representative.

10.5.6 General

The steps to establish shaft lengths consist of approval of the Contractor's drilled shaft installation plan, recording of method shaft installation, monitoring and analyzing load test data, data from the core borings and pilot holes performed at every shaft location, if available., in accordance with **Section 455, Standard Specifications for Road and Bridge Construction**, and any supplements thereto.

All documents requiring a signature must be executed electronically by both parties in accordance with article 4-1 of the Standard Specifications.

10.5.7 Drilled Shaft Installation Plan

(A) Resident Level Responsibilities

The RE (or PA) shall receive from the Contractor at the preconstruction conference a completed drilled shaft installation plan (DSIP). The plan shall provide detailed information about Contractor's equipment and methods suitable for the intended purpose and the materials encountered. The RE (or PA) shall submit this plan to the Geotechnical Engineer within two (2) working days for evaluation, review and recommendations.

The RE (or PA) shall perform a concurrent separate review of the DSIP and incorporate their own comments to the ones received from the Geotechnical Engineer. Within two (2) working days of the receipt of the Geotechnical Engineer's comments and/or recommendations, the RE (or PA) shall notify the Contractor of acceptance, rejection, or request additional information and/or changes that may be necessary to construct the drilled shafts. The letter of rejection shall contain the reason(s) for rejection of the plan.

All approvals given by the RE shall be subject to trial and satisfactory installation of the test hole, load test shafts, and production shafts.

(B) District Materials and Research Office (DMRO) Level Responsibilities

Within five (5) working days of receiving the drilled shaft installation plan, the DGE shall make comments and/or recommendation to the RE (or PA) of the acceptance or rejection of the drilling system.

10.5.8 Method Shaft, Load Test shaft and Pilot Holes

As soon as the Contractor's schedule for pilot holes and installation of method shafts and load test shafts is known, the PA shall notify the Geotechnical Engineer of the schedule so the Geotechnical Engineer can be present.

(A) Resident Level Responsibilities

A drilling log shall be maintained during pilot hole operations on *the Pilot Hole Log, Form No. 700-010-35* by the inspectors to record the soils and rocks encountered, and document rock core measurements during the drilling of the pilot hole. A drilling log shall be maintained during coring operations on the *Rock Core* page of the *Drilled Shaft for Major Structures, Form No. 700-010-85*, by the Department or by the CEI to document rock core measurements and rock description from cores taken at the base of the shaft.

Method shafts and load test shafts shall be documented as described in section 10.5.10.

Completed installation forms of the Pilot Holes, Method shaft and Load Test Shafts shall be sent to the Geotechnical Engineer within 24 hours of completion for review and use in the analysis and recommendations of the production shaft lengths.

(B) DMRO Level Responsibilities

A representative of the DGE office shall be available on site or over the phone to assist the CEI and resolve questions during these initial phases of the drilled shaft construction. The DGE office shall assist the inspectors to monitor the drilled shafts and fill the inspection logs properly.

10.5.9 Production Shaft Length

Production shaft lengths are established utilizing the results of the pilot holes, test hole installation, and load test/core boring program and contract documents. Actual shaft length of a particular shaft may vary from the Plans length depending on the subsurface soil conditions encountered during shaft installation. (If no new information is available since the plans were developed, plan shaft tip elevations are the authorized tip elevations and no shaft authorization letter is required).

(A) Resident Level Responsibilities

Upon receipt of the **Production Drilled Shaft Tip Elevations** letter from the Geotechnical Engineer, the RE shall approve the recommendation and send it to the Contractor within one (1) working day.

Completed forms shall be sent to the Geotechnical Engineer within twenty-four (24) hours of completion for review and use in recommending the production shaft lengths. All load test data, pilot hole logs and core boring reports, if any, shall also be sent to the Geotechnical Engineer within twenty-four (24) hours after being received from the Contractor. Installation of all drilled shafts including Test Holes, Load Test Shafts, major structure production drilled shafts, and drilled shafts for miscellaneous structures must be inspected by Construction Training Qualification Program (**CTQP**) Qualified Drilled Shaft Inspectors.

(B) DMRO Level Responsibilities

Within seven (7) working days of receipt of the completed **Test Hole Logs, Pilot Hole Logs**, and any **Load Test Reports**, the Geotechnical Engineer shall write a **Production Drilled Shaft Tip Elevations** letter to the RE or higher authority recommending the shaft tip elevations to be used on the project. The RE or higher authority shall send this letter to the prime Contractor authorizing production shaft lengths as indicated in section 10.5.9

(A). A sample letter is included in this chapter. Refer to **Guidance Document 10-5-A** for sample letter and distribution.

If requested, the Geotechnical Engineer may make a telephone call or send an electronic mail to notify the PA of the shaft lengths. The Drilled Shaft installation documents for the **Test Hole Log, Load Test Report, Pilot Hole Log**, and any attachments shall be included with the letter of authorization.

10.5.10 Drilled Shaft Installation

(A) Resident Level Responsibilities

Any Drilled Shaft installation shall be electronically documented in the field by the inspectors, on either **Drilled Shaft for Miscellaneous Structures, Form No. 700-010-84, or Drilled Shaft for Major Structures, Form No. 700-010-85 depending of the type of structure**. These forms contain several pages to document all the phases of the Drilled Shaft Installation. There are several areas on these forms to include notes and comments. These notes or comments may describe any relevant incidents that occurred during the shaft installation, or any information that the recorder feels may be beneficial to the Geotechnical Engineer/PA.

Completed installation forms for all production drilled shafts shall be sent to the Geotechnical Engineer within twenty-four (24) hours of completion of concrete placement for review.

(B) DMRO Level Responsibilities

During production shaft installation, the GE may decide to lengthen the shaft based on the cores taken from the shaft bottom. In these instances, the Geotechnical Engineer will confirm with an electronic mail to the CEI the additional length required.

The GE will perform a review of the drilled shaft logs to ensure the performed construction procedures and constructed shaft tip elevations are in accordance with the contract documents. Based on the logs review and field observations, the GE will decide whether any integrity testing is required to ensure the quality of the foundations. Within two (2) working days after receiving the production drilled shaft logs, the GE will send an e-mail to the PA/RE to inform about the acceptance of the drilled shafts or the need for integrity testing prior to final acceptance of the shaft.

10.5.11 Drilled Shafts for Non-Bridge Structures

To improve the quality of the installation of Drilled Shafts for non-bridge structures, DCEs shall obtain technical support from the District Geotechnical Office on drilled shaft projects involving mast arms, cantilever signs, overhead truss signs, high mast light poles, or other non-bridge structures shown in the **Contract Documents**. This process includes review of DSIP, conduct at the earliest pre-drill/pre-concrete pour meetings, quality assurance checks and inspector assistance, etc. The RE (or PA) shall notify the District Geotechnical Offices of the construction schedules of the drilled shafts for non-bridge structures for the projects so they can schedule time to assist.

Completed installation forms for all production drilled shafts shall be sent to the Geotechnical Engineer within twenty-four (24) hours of completion of concrete placement for review.

Completed installation forms for all production drilled shafts shall be sent to the Geotechnical Engineer within twenty-four (24) hours of completion of concrete placement for review. The GE will perform a review of the drilled shaft logs to ensure the performed construction procedures and constructed shaft tip elevations are in accordance with the contract documents. Within two (2) working days after receiving the production drilled shaft logs, the GE will send an e-mail to the PA/RE to inform about the acceptance of the drilled shafts or the need for integrity testing prior to final acceptance of the shaft.

10.5.12 Training

All FDOT and CEI personnel performing inspections of pile installation must hold a current Construction Training Qualification Program (CTQP) Drilled Shaft Inspector certification.

10.5.13 Forms

The following forms are available from the Policy & Process Management Forms Library at [Procedural Document Library \(fdot.gov\)](https://fdot.gov/procedural-document-library):

- 700-010-35 Pilot Hole Log
- 700-010-84 Drilled Shaft for Miscellaneous Structures Forms Workbook
- 700-020-85 Drilled Shaft for Major Structures Forms Workbook

Guidance Document 10-5-A

(DATE)
(ADDRESSEE)

Re:
Financial Project ID:
Contract No.:
County:
Structure #

Dear (_____):

This office (or the Geotechnical Engineering Form) has completed its review of the test load/core boring data for the subject bridge. Recommended Drilled Shaft Tip Elevations and rock socket lengths are as follows:

LOCATION	SHAFT SIZE	RECOMMENDED SHAFT TIP ELEVATION	MINIMUM SOCKET LENGTH
----------	---------------	---------------------------------------	-----------------------------

If you have any questions or require further information, please let us know.

Recommended by: _____
District Geotechnical Engineer/ Geotechnical Engineer

Recommended for acceptance by: (when consultant generates the letter)

District Geotechnical Engineer

Authorized for contract administration purpose by:

Resident Engineer

(INITIALS/INITIALS)

cc: State Construction Geotechnical Engineer
State Structures Design Engineer's Office (State Design Geotechnical Engineer)
FHWA (only if Federal Aid oversight project)

Section 10.6

UNDERWATER BRIDGE CONSTRUCTION INSPECTION

10.6.1 Purpose

The purpose of this section is to provide a standard procedure for conducting underwater bridge construction inspections on active bridge construction projects. The procedure specifies the type of bridge member that requires underwater inspection, the type of underwater inspection required and the frequency of inspections. The qualification requirements for firms and individuals performing underwater inspections are also specified.

10.6.2 Authority

Section 20.23(3)(a), Florida Statutes

Section 344.048(3), Florida Statutes

10.6.3 General

The contractual requirements for providing consultant CEI services for underwater inspections are specified in the Standard CEI Scope of Services **Section 9.3, On-Site Inspection**.

The individual responsible for scope of services development shall consult with the District Structures Maintenance Engineer and District Structures Design Engineer to determine if the project will utilize members with a history of underwater defects as described in **Section 10.6.4.1(a)**. If the project will utilize these type members then the CEI scope of services must include the higher level of underwater inspection effort required by **Sections 10.6.4.1(a) and 10.6.4.2(a)**. If the District chooses to have a comprehensive underwater debris survey done for the bed of the body of water on the alignment of the project prior to letting, then this should be added to the scope of services. These type surveys are not required by this procedure but they may be added at the discretion of the District.

Initial and progress inspections for projects must be performed by a commercial diving service or by a qualified bridge maintenance consultant. The diver/inspector in charge of the work in the field for the commercial diving service must have successfully completed

National Highway Institute (NHI) training course number 130091, Underwater Bridge Inspection, or an equivalent course as approved by the Project Administrator (PA). Assistant divers are not required to take the NHI course. In lieu of NHI course completion, the diver/inspector in charge may be a Certified Bridge Inspector (CBI). CBI certification is administered by the Department's Office of Maintenance, Structures Maintenance Section which issues inspector certificates as proof of certification. Inspectors/divers shall submit proof of successful NHI course completion or CBI certification to the PA prior to commencement of services.

Initial and progress inspections for projects managed by in-house CEI staff may be performed by a commercial dive service, bridge maintenance consultant or by Department inspector/divers as determined by the District Construction Engineer based on consultation with the District Structures Maintenance Engineer. Commercial or consultant inspectors/divers must meet the NHI or CBI requirements above and may be provided through a District Construction Office General Engineering Consultant (GEC) services contract or through a local CEI consultant residency contract.

Final inspections for projects managed by CEI Consultants shall be performed by the CEI consultant or by a subconsultant; however, the firm providing the service shall be prequalified to perform bridge maintenance inspections and related services as required by ***Florida Administrative Code (FAC) No. 14-75.003(5)(d)2, Qualification Requirements for Bridge Inspection Consultants***. Final inspections may also be performed by in-house Department CBIs. The decision to use Department inspectors will be determined by the District Construction Engineer based on consultation with the District Structures Maintenance Engineer.

Final inspections for projects managed by in-house CEI staff may be performed by Department CBIs or consultant inspectors. The decision to use Department or Consultant inspectors will be determined by the District Construction Engineer based on consultation with the District Structures Maintenance Engineer. If consultant inspectors/divers are used for in-house CEI projects then they must meet the requirements of ***FAC 14-75.003*** above and may be provided through a District Construction Office GEC services contract or through a local CEI consultant residency contract.

10.6.4 Underwater Inspection of Concrete Piles and Uncased Drilled Shafts

10.6.4.1 Initial Inspection

Initial inspections may include a search for prohibited underwater construction debris that may have been deposited by the Contractor during construction operations. The need for a debris inspection will be determined by the PA with concurrence of the Department's Construction Project Manager based on evidence that the Contractor's debris disposal practices are questionable.

(a) Voided piles, cylinder piles and uncased drilled shafts with concrete surfaces directly exposed to open water

The purpose of the initial inspection is to revise pile driving or drilled shaft installation procedures and/or designs if defects develop during installation of the first members of the project. An initial underwater inspection of members shall be performed after all foundation members of the first pier or bent have been installed and if possible, before member installation for the next pier or bent begins and before footing or cap formwork is placed. Inspection operations shall not delay or impact the Contractor's construction operations. In certain environments, marine growth on the surface of members can advance enough to obscure the view of that surface within 7 days. The PA must determine if the rate of marine growth will affect inspection of underwater surfaces. During initial inspections, inspectors shall inspect visible submerged surfaces of designated members. If marine growth has obscured the view of concrete surfaces by the time inspections take place then perform inspections as covered in ***FDOT Bridge Underwater Operations, Procedure No. 850-010-011***.

An initial inspection shall be performed for each member installation system defined herein as the combination of one type member with its corresponding installation equipment. Any significant change, as determined by the PA, of the installation system will require another initial inspection. The PA may also call for an initial inspection any time it is felt that member installation conditions (soil resistance, soil type, member depth, etc.) or procedures have changed enough to be considered a different installation system.

If the initial inspection reveals defects then the PA will take action as defined in applicable sections of the contract documents that may mandate repair, removal, etc. If action is not specifically covered by the contract documents then a written notice shall immediately be issued by the PA with a description of the defects and a request that the Contractor respond to the notice with a proposal for correcting current defects and for preventing future defects. The notice shall also recommend that the Contractor suspend the operation that is producing defects until an approved solution to the defect problem is agreed upon between the Department and Contractor. If the Contractor chooses not to suspend member installation operations after receipt of the defects notice, then the PA shall send a

letter to the Contractor advising that if member installation continues, it is at the Contractor's risk and the consequence could be mandatory removal of defective members. The PA shall consult with appropriate parties (Project and District Geotechnical Engineer, EOR, District Structures Design Engineer, State Construction Structures Engineer, etc.) to develop a response to the Contractor's proposal for preventing further defects and to determine what action will be required to correct existing defects in accordance with ***Specification 6-4, 400-21 and CPAM Section 5.8.7, Materials Acceptance Resolution.***

Once member installation operations resume, another initial inspection must be performed and if defects are not revealed then progress inspections as described herein shall be performed. When defects are not found during the initial inspection, then installation process and member design may continue contingent on the results of progress inspections.

(b) Other members

The PA will decide if an initial inspection is needed based on the effectiveness of the installation system's performance after the first pier or bent has been completed. If the PA is confident that members are not developing cracks, spalls or other defects during the first installation then an initial underwater inspection should not be needed. However, if the PA is uncertain about the development of defects then an initial inspection should be considered and the Construction Project Manager and project Geotechnical Engineer shall be consulted for concurrence prior to proceeding with an inspection.

10.6.4.2 Progress Inspection

Progress inspections may include a search for prohibited underwater construction debris that may have been deposited by the Contractor during operations. The need for a debris inspection will be determined by the PA with concurrence of the Department's Construction Project Manager based on evidence that the Contractor's debris disposal practices are questionable.

(a) Voided piles, cylinder piles and uncased drilled shafts with concrete surfaces directly exposed to open

The first and only progress inspection for bridges with 10 or less piers/bents having members exposed to open water (water piers/bents) shall be performed on all members in the pier/bent that contains the member closest to that representing 33% of all the members that will be installed in open water. An example is a bridge that has a total of 10 piers of

which 5 are water piers each with 10 piles which makes a total of 50 water pier piles. So, for this example the progress inspection will be performed on all piles in the second water pier because it contains pile 17 (33% of 50 = 17) of 50 or the pile that is closest to 33% of all water pier piles. For bridges with more than 10 water piers/bents, progress inspections shall be performed on all members in the water pier with the member closest to representing 25% of all water members installed and then again on all water members in the pier with the member closest to representing 65% of all water members installed. This selection criterion applies individually to each type member installation system that received an initial inspection. For example: if a bridge has 20 bents with solid 24 inch square piles and 10 piers with 30 inch square voided piles then one progress inspection would be performed at 25% and one at 65% for the 24 inch piles and one progress inspection would be performed at 25% and one at 65% for the 30 inch piles.

During progress inspections, inspectors shall inspect visible submerged surfaces of designated members. If possible, the members in the progress inspection pier/bent shall be inspected before member installation for the next pier/bent begins and before footing/cap forms are installed. However, inspection operations shall not delay or impact the Contractors construction operations. Also, comply with **Section 10.6.4.1(a)** for determining the significance of marine growth with regard to a time limit for inspections. If all members in the progress inspection pier have been inspected before the end of the routine inspection team day, then as directed by the PA, the inspection team shall also inspect as many members as possible in adjacent piers before the end of the routine inspection team day.

If a progress inspection reveals defects, the PA will take action as defined in applicable sections of the contract documents that may mandate repair, removal, etc. If action is not specifically covered by the contract documents then a notice shall immediately be issued by the PA with a description of the defects and a request that the Contractor respond to the notice with a proposal for correcting current defects and for preventing future defects. The notice shall also recommend that the Contractor suspend the operation that is producing defects until an approved solution to the defect problem is agreed upon between the Department and Contractor thus preventing additional defects. If the Contractor chooses not to suspend member installation operations after receipt of the defects notice, the PA shall send a letter to the Contractor advising that if member installation continues, it is at the Contractor's risk the consequence of which could be mandatory removal of defective members. The PA shall consult with appropriate parties (Project and District Geotechnical Engineer, EOR, District Structures Design Engineer, State Construction Structures Engineer, etc.) in order to develop a response to the Contractor's proposal for preventing further defects and to determine what action will be required to correct existing defects in

accordance with **Specification 6-4, 400-21** and **CPAM Section 5.8.7, Materials Acceptance Resolution**.

Once member installation operations resume, whether or not suspension has taken place, another initial inspection must be performed and if no defects are observed then progress inspections shall resume at a frequency determined by the PA with the concurrence of the Construction Project Manager. If defects are again observed, repeat this procedure.

(b) Other members

When the PA determines that an initial inspection is needed then depending on the results of that inspection, the PA may also consider requiring at least one progress inspection to confirm that defects are not developing as member installation progresses. Anytime defects are observed, comply with the procedure herein.

10.6.4.3 Final Inspection (applies to all members covered by 10.6.5)

A final underwater inspection of piles, including fender piles, and uncased drilled shafts shall be performed prior to final acceptance of the project but not before the bridge has been carrying full unrestricted public vehicular traffic for at least 7 days. The written record of the bridge inspection shall be signed and sealed by a Professional Engineer registered in the State of Florida. Inspections shall be conducted in accordance **FDOT Bridge Underwater Operations, Topic No. 850-010-011** and be in full compliance with FDOT District Structures Maintenance Office procedures for routine underwater maintenance inspections. Prior to the start of any final inspection, the District Structures Maintenance Engineer (DSME) shall be consulted and inspections shall be performed according to the DSME's direction with concurrence of the Construction Project Manager. A copy of the records that are produced as a result of inspections shall be transmitted to the District Structures Maintenance Office and will be incorporated into the permanent bridge maintenance record and may serve as the official initial underwater bridge maintenance inspection report.

Final inspections shall include a search for prohibited underwater construction debris that may have been deposited by the Contractor during construction operations.

10.6.5 Underwater Inspection of Footings, Columns, Piers and Walls

10.6.5.1 Initial Inspection

An initial inspection will be required for the first members (footings, columns, piers or walls) constructed on the project that will be fully submerged during their service life. Cracks or other defects must be corrected prior to flooding the cofferdam. The initial underwater inspection of the first fully submerged members of the project shall not take place until the superstructure load, with the exception of traffic and pedestrian barriers, lighting, signing, signals, etc., has been applied to the pier and which shall be referred to as the "Initial Inspection Load".

Footings that will be partially submerged (waterline footings) during their service life will receive a final underwater inspection only and will not receive an initial or progress inspection unless cracks above water are found during the routine inspection required by **CPAM 10.3.5**. If a crack starts above water and ends below the water then underwater inspection procedures herein for fully submerged components shall apply to that waterline footing.

A significant amount of time will pass between flooding of the cofferdam and completion of the deck so aquatic growth will have developed on submerged concrete surfaces to a degree that is governed by the aquatic environment. Because of the growth, both a level I and II underwater inspection shall be performed in accordance with **FDOT Bridge Underwater Operations, Topic No. 850-010-011**.

If defects are found during the initial inspection then the correction of defects, and prevention of further defects in members not yet built, shall be pursued by the PA in accordance with **Specification 6-4, Specification 400-21** and **CPAM Section 8.11**, with assistance from the following as needed: Construction Project Manager, District Materials Office, District Structures Design Office, State Materials Office, State Construction Office and State Structures Design Office. When defects are found in the first pier of the project, then an initial inspection shall be performed on the second pier of the project immediately or as soon as the Initial Inspection Load is applied. If defects are found in the second pier then the initial inspection process will continue to the third pier, and so on, until the PA has required initial inspection of all piers or until the PA is satisfied that the defects are unlikely to occur on subsequent piers due to a change in construction practice or other reason.

If no defects are found during the initial inspection of the first fully submerged members of the project then the PA has the option of either performing Progress Inspections as the project advances or to continue Initial Inspections due to existing defects of other members.

10.6.5.2 Progress Inspection

Progress inspections may include a search for prohibited underwater construction debris that may have been deposited by the Contractor during operations. The need for a debris inspection will be determined by the PA with concurrence of the Department's Construction Project Manager based on evidence that the Contractor's debris disposal practices are questionable.

Once all Initial Inspections are complete then Progress Inspections shall be performed according to the provisions herein and in accordance with ***FDOT Bridge Underwater Operations, Topic No. 850-010-011***. For bridges with 10 or less water piers, perform one progress inspection on the water pier closest to that representing 33% of all the water piers installed. For example, if the bridge has 12 total piers and 8 are water piers then 33% of 8 is 2.6 which rounded off is 3; therefore, the third water pier would receive the only progress inspection required if no defects are found. For bridges with more than 10 water piers, progress inspections shall be performed on the water pier closest to representing 25% of all water piers in the project and then again on the water pier closest to representing 65% of all water piers in the project. If the designated pier has been inspected before the end of the routine inspection team day, then as directed by the PA, the inspection team shall also inspect as many other piers as possible before the end of the routine inspection team day. If defects are found during a progress inspection, then the PA shall take action as described in ***Section 10.6.5.1*** for dealing with defects as well as with requiring inspection of other piers.

10.6.5.3 Final Inspection

A final underwater inspection of fully and partially submerged members including bulkheads, seawalls, etc. shall be performed prior to final acceptance of the project but not before the bridge has been carrying full unrestricted public vehicular traffic for at least 7 days. Perform final inspections of piers, footings, columns and walls in accordance with ***Section 10.6.4.3***.

Final inspections may include a search for prohibited underwater construction debris that may have been deposited by the Contractor during construction operations. The need for a debris inspection will be determined by the PA with concurrence of the Department's Construction Project Manager based on evidence that the Contractor's debris disposal practices are questionable.

Section 10.7

POST-TENSIONED BRIDGES

10.7.1 Purpose

The purpose of this procedure is to direct Construction Engineering and Inspection (CEI) personnel in the inspection, monitoring and engineering duties required to assure quality post-tensioned (PT) bridge construction in compliance with the Contract Documents. This procedure is intended to be used by CEI staff experienced with PT bridge construction. This procedure includes PT system installation, post-tensioning operations, segment casting and duct filler injection operations. Duct filler material can be one of two types: flexible filler (wax) or grout filler.

10.7.2 Authority

Section 334.048, Florida Statutes

Rule Chapter 5J-17, Florida Administrative Code

10.7.3 CEI Responsibility Categories

In Person Observations: The responsibilities of this category require CEI staff to be physically present when a construction activity is being performed by the Contractor or shortly before an operation is to be performed and to visually verify that the activity is being performed in accordance with the Contract Documents. Responsibilities of this category also include personally performing, while in the field, surveying, documenting, testing and measuring. At a minimum, conduct a pre-operation meeting with the Contractor prior to the first time a construction activity of a given type (control survey, casting, erection, stressing, filler injection) is to be performed.

Verification of Contractor's Procedures and Records: The responsibilities of this category require CEI staff to review Contractor procedures and records to verify their accuracy and compliance with the Contract Documents. These reviews may not require CEI staff to directly observe the specific construction operation performed by the Contractor. Responsibilities involve review of Contractor calculations including the Geometry Control Manual, Casting Manual and Erection Manual; observation of Contractor Quality Control (QC) test procedures and other QC procedures, review of contractor survey data, verification of data collection form accuracy and completeness as well as other required Contractor records.

Record Keeping: The responsibilities of this category require CEI staff to gather and record data for entry into various forms and records. These forms and records shall be kept electronically by the CEI. Other forms may be developed by the CEI as necessary. CEI staff may use versions of Contractor forms or records that have been verified to be accurate and complete but any copies must have a statement of verification and include the initials of the CEI staff that performed the verification. The CEI must maintain independent copy of all such verified records.

10.7.4 Additional Requirements

Verify that all Contractor operations are conducted in accordance with the following QC Guidelists:

8B Concrete Materials

10A Bridge Structures – General Concrete

10C Bridge Structures – Concrete Decks

10D Bridge Structures – Post-tensioning (PT)

10.7.5 Segmental Casting Yard Operations

A. Activities Required Prior to Casting a Segment

1. In Person Observations

- a. Survey tower and casting beds are rigidly constructed and will not deflect. Perform periodic independent surveys to verify tower position throughout the course of the project. Perform independent surveys to develop and maintain survey control data throughout the course of the project.
- b. Record independent horizontal and vertical measurements at formwork control points for each segment. Verification measurements may be taken at the same time that Contractor QC measurements are taken. If permitted by the Contractor, Contractor survey equipment may be used by the CEI for performing formwork surveys prior to casting a segment.
- c. FORMS – Observe and verify the following:
 - Forms are rigidly constructed and have sufficient strength to prevent deformation while supporting plastic concrete.
 - Form surfaces are in good condition.
 - Form and match-cast surfaces are coated with form release compound.
 - Mandrels or other devices used to secure duct openings and alignment at the bulkhead are rigid and properly positioned.
 - Form joints are sufficiently tight to prevent leakage of concrete paste.
- d. REINFORCEMENT – Observe and verify the following:
 - Size, spacing, position, grade and cover are correct. For segmental construction, extra attention should be paid to reinforcing in pier segments and deviator segments.
 - Spacers, chairs and bolsters have sufficient strength to prevent deformation during concrete placement and are listed on the Department's ***Approved Products List***.
 - Tie wires do not protrude into the concrete cover.

- Reinforcing and prestressing steel are free from loose rust, dirt, paint, etc.
 - Reinforcing is securely tied.
- e. DUCTS – Observe and verify the following:
- All PT system components must meet the requirements of Section 960 and be selected from the Structures Design Office (SDO) Approved PT Systems website. No substitutions, modifications, or deletions of any PT components are allowed without consent from the SDO and the SCSE, with the exception of mild reinforcing and prestressing steel.
 - Post-tensioning ducts are free from debris and are securely capped.
 - Pipe deviator position and rotation are correct.
 - Duct size, position, alignment and cover are correct. (For segmental construction, extra attention should be paid to ducts in pier segments and deviator segments.)
 - Ducts are properly sealed with no cuts, breaks, lips, kinks, dents, or unacceptable deviations.
 - Duct couplers are properly installed within the match-cast segment.
 - Diabolos are installed correctly per Plans and the approved Shop Drawings. Verify excess diablo material is trimmed flush with concrete surface.

2. Verification of Contractor's Procedures and Records

- a. Prior to commencement of field survey operations, verify that the segment geometry control/adjustment methodology in the approved **Casting Manual** and **Geometry Control Manual** provide the accuracy and precision required in the Contract Documents.
- b. Segment geometry measurements are accurate and have been correctly recorded.
- c. Check Contractor's calculations for revised segment geometry to correct segment alignment per the casting curve.

3. Record Keeping

- a. Generate and maintain independent records and geometry adjustment calculations for elevations and horizontal measurements at survey control points for comparison with the Contractor's records.
- b. Generate checklists to track the Observations and Verifications listed above. See **Attachments 10-7-1(a) and 10-7-1(b) "Sample Segment Casting Record"**.

B. Casting Activities

1. In Person Observations

- a. Concrete is placed according to the Contract Documents. Vibrators are only used in accordance with the **Specifications**. Areas prone to lack of concrete consolidation are adequately and thoroughly vibrated.
- b. Verify the Mass Concrete Control Plan (MCCP) has been approved by the Department (if applicable) and that monitoring of temperatures is being done per the **MCCP** and the **Specifications**. Consult **CPAM 10.3** for additional guidance for CEI requirements regarding mass concrete.

2. Verification of Contractor's Procedures and Records

- a. Contractor concrete QC test specimens are taken from the point of placement.
- b. Curing compound application rate is calculated by contractor, that there are records documenting this and that it meets the requirements of the Contract Documents.

3. Record Keeping

- a. Generate checklists to track the Observations and Verifications listed above.

C. Post-Casting Activities

1. In Person Observations

- a. Record independent horizontal and vertical measurements at segment control points for each segment. Verification measurements may be taken at the same time that QC measurements are taken. If permitted by the Contractor, Contractor survey equipment may be used by the CEI for performing segment surveys.

- b. Visually inspect segment surface per **CPAM 10.3**. Use a pocket microscope to accurately measure crack widths smaller than 25 mils.
 - c. Follow **CPAM 10.2** for the disposition of defects.
 - d. All duct end openings are capped such that water or other foreign material cannot enter duct.
 - e. Verify mass concrete temperature readings are within allowable Specification limits (if applicable).
 - f. Lifting, transportation, and storage of segments are per **Specification 452-7**.
 - g. If segment post-tensioning is required prior to removing the segment from the form, complete the procedures in **Section 10.7.5 (B)** of this chapter.
 - h. Mark segments which have passed all inspections and which are ready for delivery to erection site by means of a stamp applied with indelible ink. Record date that each segment is stamped.
2. Verification of Contractor's Procedures and Records
 - a. Elevations and horizontal measurements of as-cast segment are accurate and have been correctly recorded.
 - b. Concrete has reached strength required in the Contract Documents prior to tendon stressing, removal from formwork and lifting as applicable.
 - c. Segment dimensions agree with those required by **Contractor Casting Manual** and casting curve to within the tolerances specified in the Contract Documents.
3. Record Keeping
 - a. Develop and maintain forms to track the Observations and Verifications listed above.
 - b. Graphically depict crack maps, spalls, honeycombs, or other concrete surface flaws or repairs on an accurately scaled drawing of each segment (refer to **CPAM 10.3** for detailed requirements).

10.7.6 Field Construction Operations

A. Segmental Erection Activities

1. In Person Observations

- a. All erection operations are in accordance with the Contract Documents and approved **Erection Manual**. Verify forces in temporary erection PT components.
- b. Elevations and horizontal measurements at survey control points, and bearing seats are recorded before and after segment erection. Review QC survey information for compliance with theoretical alignment.
- c. Only approved shimming procedures and materials or other methods are used to correct vertical and/or horizontal misalignments. Notify the SCSE if shimming frequency exceeds every other segment for one full span or full cantilever.
- d. Duct couplers are correctly installed in all continuous ducts.
- e. Allowable mixing/application time of epoxy jointing material is not exceeded. Verify epoxy temperature limits are not exceeded.
- f. Epoxy jointing material between segments is uniformly applied immediately before segment erection. At closure pours, epoxy bonding compound, if used, has been uniformly applied on adjacent segments immediately before placing concrete.
- g. Contractor's method for preventing epoxy from falling beneath the bridge is effective.
- h. Verify PT ducts permit passage of a torpedo through duct immediately after initial stressing of bars or tendons.
- i. Epoxy "squeeze out" is visible along entire length of joint.

2. Verification of Contractor's Procedures and Records

- a. Check the Contractor's proposed Erection and/or Geometry Control Manual and method for calculating adjustments to elevations and horizontal measurements at survey control points.
- b. Contractor's Erection Manual and temporary loads are in accordance with the Contract Documents.
- c. Elevations and horizontal measurements at survey control points are accurate and have been correctly recorded.

- d. Check calculations to adjust elevations and horizontal measurements at survey control points.
 - e. Verify the Contractor's proposed methods to correct vertical and/or horizontal misalignment.
 - f. Proposed epoxy jointing material properties comply with the Contract Documents.
3. Record Keeping
- a. Generate independent records and geometry adjustment calculations for elevations and horizontal measurements at survey control points, for comparison with the Contractor's records.
 - b. If cracks or spalls occur during erection or stressing, graphically depict crack maps or spalls on an accurately scaled drawing of each segment (refer to **CPAM 10.3.5** for detailed requirements).
 - c. Develop and maintain epoxy jointing records of all epoxy jointing operations. **See Attachment 10-7-2 "Sample Epoxy Joint Record"**.

B. Stressing Operations for all PT Bridge Types

1. In Person Observations
- a. PT steel is properly stored and protected.
 - b. PT steel is placed into the ducts properly without damage to prestressing steel or ducts with a clean strand surface.
 - c. Concrete has reached strength required in the Contract Documents prior to erection and tendon stressing.
 - d. Witness and record all PT stressing operations, including hydraulic jack gauge pressure readings and tendon or PT bar elongation measurements.
 - e. Stressing equipment is furnished by the supplier of PT system.
2. Verification of Contractor's Procedures and Records
- a. Hydraulic jacks have been properly calibrated and certified calibration curves have been provided for each hydraulic jack, in compliance with the Specifications.

- b. In-Place Wobble and Friction Tests and/or Tendon Modulus of Elasticity Tests have been performed and obtain test reports.
 - c. Verify the Contractor's procedures, measurement, calculation and documentation of tendon elongations, and documentation of hydraulic jack gauge pressure readings and jacking forces.
 - d. The Project Administrator shall coordinate a resolution to all differences between the CEI and the Contractor in the measurement and/or documentation of tendon elongations. In the event that measured elongations do not match those predicted by the Specialty Engineer and/or differences exist between the CEI and the Contractor in the way hydraulic jack readings and/or elongations are measured and recorded, the Project Administrator shall contact the SCSE and notify the Contractor that his Specialty Engineer needs to be involved in resolving these differences. If approved by the SCSE, the stress in a tendon can be verified using lift-off tests at either the live or dead end of a tendon, if deemed appropriate, on a case-by-case basis.
3. Record Keeping

Develop and maintain independent stressing records of all PT stressing operations. See ***Attachment 10-7-3 "Sample Stressing Record"***.

C. Filler Injection Operations: Grout

1. In Person Observations
 - a. Air pressure tests are performed successfully.
 - b. Grouting equipment is tested for accuracy on each day of use before performing grouting operations.
 - c. Confirm location of all leaks and/or crossovers during the Duct Field Pressure Test for each tendon.
 - d. Field grout operations are performed as specified, within specified time, and in conjunction with specified tests. A minimum of two CEI Inspectors shall be present during field grouting operations, one to observe grout mixing and pumping operations, and one to observe grout discharge at outlet locations.
 - e. Confirm duct grout ports at high points and inlets and outlets located at anchorages have been drilled out, inspected for voids using a borescope, and vacuum grouted to fill voids where needed.

- f. Confirm anchorages are as shown on the Design Standards and that all levels of protection at anchorages are in compliance with Specification 462-7.3.3.
2. Verification of Contractor's Procedures and Records
 - a. Verify acceptance of the Contractor's Grouting Operations Plan.
 - b. Verify full-scale mockup was performed successfully.
 - c. Prepackaged grout is on the **Approved Products List**, and proposed equipment is in compliance with the Specifications.
 - d. Obtain grout manufacturer's Quality Control Data Sheets to obtain specific density and mixing parameters for each shipment of grout on the project. Verify time that grout has been stored on the project site does not exceed six months.
 - e. Verify submittal of the Contractor's Grouting Report after each grouting operation.
 - f. Verify the accuracy and completeness of the Contractor's Grouting Records after each grouting operation.
 - g. Confirm all required grout testing have been performed and documented on the grouting record sheet. See **Attachment 10-7-4(a)** for required testing information.
 3. Record Keeping
 - a. Develop and maintain Grouting Records, separate from the Contractor's records. See **Attachment 10-7-4(a) "Sample Grouting Record"**.
 - b. Document the results of the post grouting inspection. See **Attachment 10-7-5(a) "Sample Post-Grouting Inspection Record"**.

D. Filler Injection Operations: Wax

1. In Person Observations
 - a. Air pressure and vacuum tests (when using vacuum assistance) are performed successfully.
 - b. Confirm location of all leaks and/or crossovers during the Duct Field Pressure and Vacuum Tests (when using vacuum assistance) for each tendon.

- c. Confirm wax temperature is within 212°F and 240°F per the Specifications and that the entire mass of wax is liquefied prior to commencement of injection.
 - d. Wax injection operations are performed as specified. A minimum of two CEI Inspectors shall be present during wax injection operations, one to observe wax pumping operations, and one to observe wax vacuum (when using vacuum assistance) and /or discharge operations at outlet locations.
 - e. Confirm duct high points and anchorages have been visually inspected for voids, and address any voids using the methods described in the approved Wax Injection Operations Plan and Specification 462-7.4.2.1.
 - f. Confirm anchorages are as shown on the Design Standards and that all levels of protection at anchorages are in compliance with Specification 462-7.3.3.
2. Verification of Contractor's Procedures and Records
- a. Verify acceptance of the Contractor's Wax Injection Operations Plan.
 - b. Verify full-scale mockup test was performed successfully.
 - c. Microcrystalline wax is on **Approved Products List**, and proposed equipment is in compliance with the Specifications.
 - d. Obtain wax manufacturer's certification that the product meets the requirements of the Specifications. Obtain the manufacturer's Quality Control Data Sheets for each shipment of wax on the project.
 - e. Verify submittal of the Contractor's Wax Injection Operations Report after each wax injection operation.
 - f. Verify the accuracy and completeness of the Contractor's Wax Injection Records after each wax injection operation.
3. Record Keeping
- a. Obtain written certification from the PT system manufacturer installation technician that the installation process is in conformance with the approved Wax Injection Operations Plan for the first two days of wax injection.
 - b. Develop and maintain Wax Injection Records, separate from the Contractor's records. See **Attachment 10-7-4(b) "Sample Wax Injection Record"**.

- c. Document the results of the post wax injection inspection. See ***Attachment 10-7-5(b) "Sample Post Wax Injection Inspection Record"***.

E. Post Grouting Inspection of External Tendon Ducts and Couplers

1. In Person Observations

- a. Inspect external tendon ducts and couplers for grout voids, fractured grout, delamination, as well as duct and coupler material punctures, splits or other damage by sounding them and by visual inspection of all visible duct and coupler surfaces. Sound each duct and coupler a minimum of seven days after grouting is complete by tapping the surface using a 16 ounce steel hammer. Use a tapping force that will not cause the duct or coupler material to split, dent, crush or incur any other damage and that will not cause fracturing, chipping or damage to the grout within the duct or coupler. Sound each duct and coupler at one foot intervals along their length and at each interval, as a minimum, tap them on the top sides and bottom.
- b. Mark the limits of any defect on the surface of the duct or coupler with a high visibility permanent marker and when it can be determined for sounding or observation alone, label the defect type as one or more of the following: void, fracture, delamination, split, other.

2. Verification of Contractor's Procedures and Records

Verify that the Contractor repairs all defects. Before corrective action is taken, verify Contractor's proposed course of action in accordance with ***CPAM 10.10.6.3***. Prior to the any void investigation, the Project Administrator shall contact the State Materials Office Corrosion and Durability Lab for guidance regarding how fluid contained in a void is to be captured as well as to establish what the State Material Office role will be in the investigation of the fluid.

3. Record Keeping

- a. Document the location and type of all defects found.
- b. Document all corrective actions.

F. Post Wax Injection Inspection of External Tendon Ducts and Couplers

1. In Person Observations

- a. Inspect external tendon ducts and couplers for wax voids as well as duct and coupler material punctures, splits or other damage by sounding them and by visual inspection of all visible duct and coupler surfaces. For external tendons, note any spots along the length of accessible areas that are cool to the touch. Cool spots along ducts immediately after wax injection are indicative of voids present in the duct. Sound each duct and coupler between 24 and 48 hours after wax injection is complete by tapping the surface using a rubber mallet. Use a tapping force that will not cause the duct or coupler material to split, dent, crush or incur any other damage. Sound each duct and coupler at one foot intervals along their length and at each interval, as a minimum, tap them on the top sides and bottom.
 - b. Mark the limits of any defect on the surface of the duct or coupler with a high visibility permanent marker and when it can be determined for sounding or observation alone, label the defect type as one or more of the following: void, split, other.
2. Verification of Contractor's Procedures and Records

Verify that the Contractor repairs all defects. Before corrective action is taken, verify Contractor's proposed course of action in accordance with **CPAM 10.10.6.3**.
 3. Record Keeping
 - a. Document the location and type of all defects found.
 - b. Document all corrective actions.

ATTACHMENT 10-7-1(a) SAMPLE SEGMENT CASTING RECORD

FDOT Project No: _____ Bridge No: _____ CEI Inspectors: _____

Casting Date: _____ Segment Type: Pier / Typical / Deviator / Expansion Joint Drawings Used: _____

Form Removal Date: _____ Curing Method: _____

Formwork		
Item	Inspected & Date	Remarks
Form Dimensions		
Match Segment Aligned		
Form Clean / Oiled		
Joints Tight / Sealed		
Form Ties / Supports		
Match Cast Debonding Agent		
Core Form Setup		
Form Venting		
Blockouts Installed		
Drip Edge Installed		
Blister Dimensions		
Deviator Dimensions		
Shear Keys (at Bulkhead)		
Alignment Keys (at bulkhead)		
Chamfer Form		
Duct/Anchorage Position		

Embedded Items		
Item	Inspected & Date	Remarks
Access Openings		
Lifting holes / lugs		
All Debris Cleaned		
Embedded Bearing Plates		
Blockouts		
Geometry Control Insert		
PT Bar Sleeves		
Filler Vents		
Steel Pipe (at Deviator or Diaphragm)		
Drainage Opening		
Special Inserts for Erection Equipment		
Plumbing / Elec. Conduits		

Note: This standard data collection forms is provided as an example of minimum data collection requirements. Additional fields may be added by the Senior Project Engineer. All data fields on the attached forms shall be incorporated into the forms used for the project. If certain data fields are not applicable for a project, these fields may be omitted from project forms with written approval of the SCSE.

ATTACHMENT 10-7-1(b) SAMPLE SEGMENT CASTING RECORD

Reinforcing		
Item	Inspected & Date	Remarks
Bottom Slab, Web, Top Slab Rebar		
Blister Rebar		
Deviator Rebar		
Diaphragm Rebar – Position / Congestion		
Cathodic Protection (if applicable)		
Bar Spacing		
Clear Cover (including tie wire)		
Bar stability - % tied - Walls		
Bar stability - % tied – Slabs		
Bar stability - % tied – Diaphragm/ Deviator		
Embedded PT anchorages		
Splice Lengths		
Local Zone Anchorage Reinforcement		
PT Duct alignment		
Duct couplers		
Ducts secure?		
Transverse Tendons Inserted		

Post Tensioning		
Item	Inspected & Date	Remarks
Cantilever PT Ducts		
Cantilever PT Anchorages		
Transverse PT Ducts		
Transverse PT Anchorages		
Ducts Securely Tied		
Filler Outlets Plugged		
Ducts Capped		
Continuity PT Ducts		
Continuity PT Anchorages		
Filler Tubes		
Bulkhead Mandrels in Place		
Match Cast Duct Coupler		
Contingency Ducts		
Vertical PT in Diaphragm		
Horizontal PT in Diaphragm		
Vertical Web PT		
Deviator Pipe Orientation/ Rotation		
Temporary PT Ducts		

Note: This standard data collection form is provided as an example of minimum data collection requirements. Additional fields may be added by the Senior Project Engineer. All data fields on the attached forms shall be incorporated into the forms used for the project. If certain data fields are not applicable for a project, these fields may be omitted from project forms with written approval of the SCSE.

**ATTACHMENT 10-7-2
 SAMPLE EPOXY JOINT RECORD**

FDOT Project No: _____ CEI Inspectors: _____ Contractor Personnel _____

Bridge No: _____ Contractor: _____

Manufacturer & Epoxy Bonding Agent Components: _____

Joint Location	Date	Ambient Temp.	Concrete Temp.	Lot Nos. (for all Epoxy Bonding Agent Compounds)	Time Mixing Started	Time Applied	Time Stressed	Epoxy Volume	Weather Conditions	Shims – TBR (Top, Bottom, Right, etc)

Remarks:

Method of Application; Repairs (include locations and reason for repairs) _____

Note: This standard data collection form is provided as an example of minimum data collection requirements. Additional fields may be added by the Senior Project Engineer. All data fields on the attached forms shall be incorporated into the forms used for the project. If certain data fields are not applicable for a project, these fields may be omitted from project forms with written approval of the SCSE.

ATTACHMENT 10-7-3 SAMPLE STRESSING RECORD

FDOT Project No: _____	Tendon Position: _____	CEI Inspector(s): _____
Bridge No: _____	# of Strands/Diam: _____	Contractor: _____
Location: _____	Strand Area: _____	Contractor Personnel: _____
Jack No. End 1: _____	Elongation in Jack: _____ (d)	_____
Jack No. End 2: _____	Jacking Force: _____	Date Installed: _____
Gauge No. End 1: _____	Reel/Heat #: _____	Date Stressed: _____
Gauge No. End 2: _____	Pack #: _____	
Theoretical Dead End Anchor Set: _____	Theoretical Live End Anchor Set: _____	
Actual Dead End Anchor Set: _____	Actual Live End Anchor Set: _____	
Theoretical Dead End Anchor Set (100%-20%): _____ (c)	Theoretical Modulus of Elasticity: _____ (f)	
Actual Modulus of Elasticity: _____ (g)	Ratio (R=f/g): _____ (R)	

Sequence	Tendon Number	Stressing Mode: Single End or Double End	20% Stressing Force Gauge Pressure	100% Stressing Force Gauge Pressure	Elongation at 20% Stressing Force (b)	Elongation at 100% Stressing Force (a)	Theoretical Elongation Between Wedges (e)	Expected Elongation 100%-20% (0.8x(e+d)+c)xR	Actual Elongation (a-b)	Percent Elongation Actual vs. Expected	Elongation Pass (P) of Fail (F)

Notes:

1. 100% Elongation measurement is before lock-off.
2. The Contractor's Engineer of Record will determine whether Live End Anchor Set is to be measured separately and added to the Expected Elongations.

Remarks: _____

Note: This standard data collection form is provided as an example of minimum data collection requirements. Additional fields may be added by the Senior Project Engineer. All data fields on the attached forms shall be incorporated into the forms used for the project. If certain data fields are not applicable for a project, these fields may be omitted from project forms with written approval of the SCSE.

ATTACHMENT 10-7-4(a) SAMPLE GROUTING RECORD

FDOT Project No: _____ Grout Type: _____ Inspectors: _____
 Bridge No: _____ Grout Manufacturer: _____ Contractor: _____
 Location: _____ Lot Number: _____ Contractor Personnel: _____
 Bag Weight: _____ Bag Date: _____ Bags (Grout Batching): _____
 Bags (Grout Batching): _____ Water (Grout Batching): _____ Date: _____
 Water/Cement Ratio: _____ Grout Temperature: _____ Ambient Temperature: _____

Tendon No.	Tendon Length	Bleed Test	Efflux Time (Fluidity Test)			Maximum Pressure (psi)	Estimated Time (sec)	Actual Time (sec)	Theoretical Grout Volume	Measured Grout Volume	Discharged Grout Volume	Post Grout Inspection	Date Tendon Installed	Date Tendon Stressed
			Batch	High Point	Discharge									

Tendon #: _____ Wick Bleed Test Results: 15min: _____ 30min: _____ 45min: _____ 60min: _____ 120min: _____ 180min: _____ Air Test Pressure Loss: _____
 Tendon #: _____ Wick Bleed Test Results: 15min: _____ 30min: _____ 45min: _____ 60min: _____ 120min: _____ 180min: _____ Air Test Pressure Loss: _____
 Tendon #: _____ Wick Bleed Test Results: 15min: _____ 30min: _____ 45min: _____ 60min: _____ 120min: _____ 180min: _____ Air Test Pressure Loss: _____
 Tendon #: _____ Wick Bleed Test Results: 15min: _____ 30min: _____ 45min: _____ 60min: _____ 120min: _____ 180min: _____ Air Test Pressure Loss: _____
 Tendon #: _____ Wick Bleed Test Results: 15min: _____ 30min: _____ 45min: _____ 60min: _____ 120min: _____ 180min: _____ Air Test Pressure Loss: _____

Remarks:
 (Note whether Standard or Modified Fluidity test was used, problems encountered, variations to approved grouting plan, etc.) _____

Note: This standard data collection form is provided as an example of minimum data collection requirements. Additional fields may be added by the Senior Project Engineer. All data fields on the attached forms shall be incorporated into the forms used for the project. If certain data fields are not applicable for a project, these fields may be omitted from project forms with written approval of the SCSE.

**ATTACHMENT 10-7-4(b)
 SAMPLE WAX INJECTION RECORD**

FDOT Project No: _____
 Bridge No: _____
 Location: _____
 Ambient Temperature: _____

Wax Type: _____
 Wax Manufacturer: _____
 Lot Number: _____
 Date of Injection: _____

Inspectors: _____
 Contractor: _____
 Contractor Personnel: _____

Tendon No.	Tendon Length	Wax Locking Pressure (psi)	Vacuum Gauge Pressure (psi) / % Vacuum	Wax Temperature (°F)	Theoretical Wax Volume	Actual Wax Volume in Duct	Volume of Wax Discharged	Post Wax Injection Inspection	Date Tendon Installed	Date Tendon Stressed

Tendon #: _____ Air Test Pressure Loss: _____ Vacuum Loss (%) = $(P1-P2)/P1*100\%$: _____
 Tendon #: _____ Air Test Pressure Loss: _____ Vacuum Loss (%) = $(P1-P2)/P1*100\%$: _____
 Tendon #: _____ Air Test Pressure Loss: _____ Vacuum Loss (%) = $(P1-P2)/P1*100\%$: _____
 Tendon #: _____ Air Test Pressure Loss: _____ Vacuum Loss (%) = $(P1-P2)/P1*100\%$: _____
 Tendon #: _____ Air Test Pressure Loss: _____ Vacuum Loss (%) = $(P1-P2)/P1*100\%$: _____

Remarks:

(Note problems encountered, variations to approved wax injection plan, etc.) _____

Note: This standard data collection form is provided as an example of minimum data collection requirements. Additional fields may be added by the Senior Project Engineer. All data fields on the attached forms shall be incorporated into the forms used for the project. If certain data fields are not applicable for a project, these fields may be omitted from project forms with written approval of the SCSE.

**ATTACHMENT 10-7-5(a)
 SAMPLE POST GROUTING INSPECTION RECORD**

FDOT Project No: _____

Inspectors: _____

Bridge No: _____

Anchor Location	Span	Tendon Designation	Anchor Cap					Grout Tube				
			Location of Inspection	Void Found?	Estimate % of Void	Grout Condition (Solid/Wet/Soft)	Depth Probed with Wire	Void Found?	Depth of Borescope Inspection	Grout Condition (Solid/Wet/Soft)	Exposed Strands?	Free Water?

Anchor Location	Span	Tendon Designation	Anchor Cap					Grout Tube				
			Location of Inspection	Void Found?	Estimate % of Void	Grout Condition (Solid/Wet/Soft)	Depth Probed with Wire	Void Found?	Depth of Borescope Inspection	Grout Condition (Solid/Wet/Soft)	Exposed Strands?	Free Water?

Void in External Tendon Duct? _____
 If yes, indicate size and location below.

(Shade in voided area)



Notes: _____

Note: This standard data collection form is provided as an example of minimum data collection requirements. Additional fields may be added by the Senior Project Engineer. All data fields on the attached forms shall be incorporated into the forms used for the project. If certain data fields are not applicable for a project, these fields may be omitted from project forms with written approval of the SCSE.

ATTACHMENT 10-7-5(b)
SAMPLE POST WAX INJECTION INSPECTION RECORD

FDOT Project No: _____

Inspectors: _____

Bridge No: _____

Anchor Location	Span	Tendon Designation	Anchor Cap				Wax Tube		
			Location of Inspection	Void Found?	Estimate % of Void	Depth Probed with Wire	Void Found?	Depth of Borescope Inspection	Exposed Strands?

Anchor Location	Span	Tendon Designation	Anchor Cap				Wax Tube		
			Location of Inspection	Void Found?	Estimate % of Void	Depth Probed with Wire	Void Found?	Depth of Borescope Inspection	Exposed Strands?

Void in External Tendon Duct? _____
 If yes, indicate size and location below.

(Shade in voided area)



Notes: _____

Note: This standard data collection form is provided as an example of minimum data collection requirements. Additional fields may be added by the Senior Project Engineer. All data fields on the attached forms shall be incorporated into the forms used for the project. If certain data fields are not applicable for a project, these fields may be omitted from project forms with written approval of the SCSE.

ATTACHMENT 10-7-6 SAMPLE CASTING YARD SURVEY CONTROL POINTS FOR SEGMENTAL SUPERSTRUCTURES

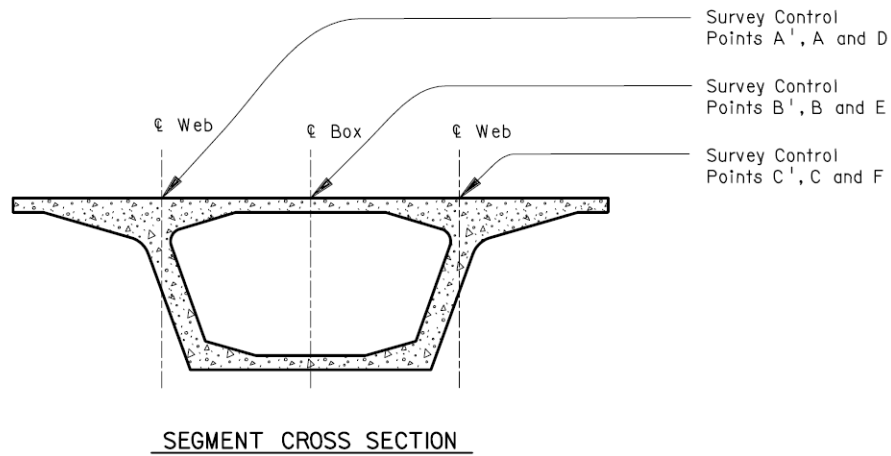
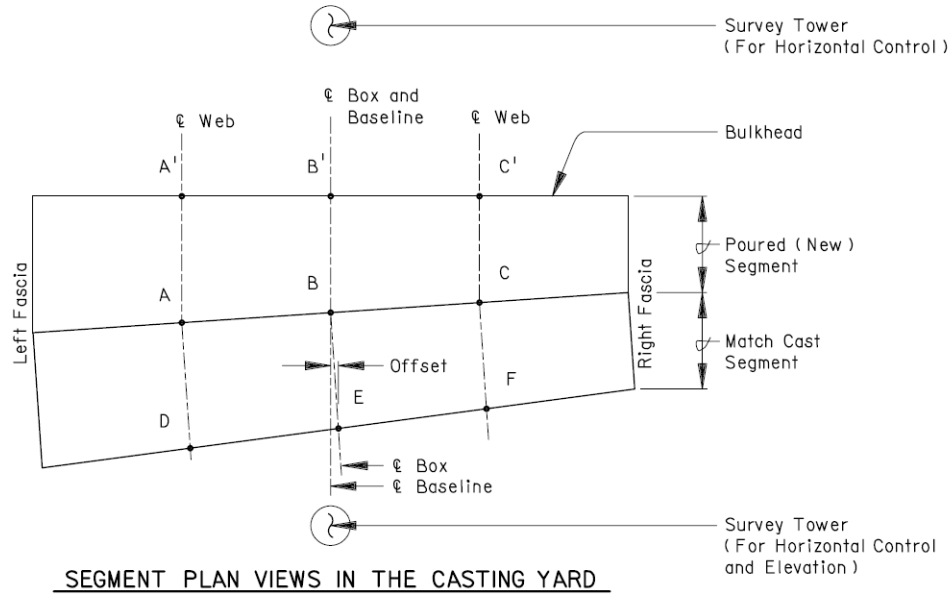

NOTES:

1. The horizontal Baseline is established between Survey Towers, and the bulkhead is set perpendicular to this Baseline.
2. Points B' and B are on the Baseline, and Point E is offset from the Baseline as shown.
3. Horizontal Measurements are taken between Control Points A-A', B-B' and C-C'.
4. Elevations are taken at Points A', C', A, C, D and F.
5. All elevations and measurements are taken before and after casting the Poured (New) Segment.

**ATTACHMENT 10-7-7
 ALTERNATE SAMPLE CASTING YARD SURVEY CONTROL POINTS
 FOR SEGMENTAL SUPERSTRUCTURES**

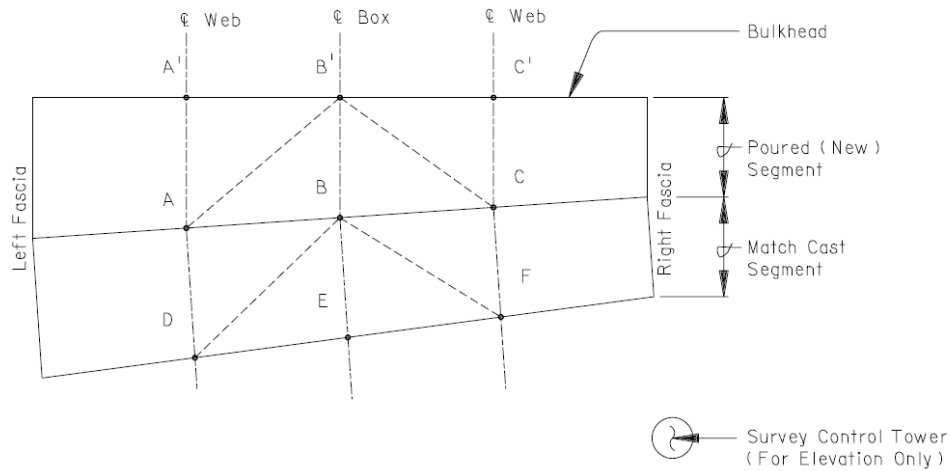

SEGMENT PLAN VIEWS IN THE CASTING YARD

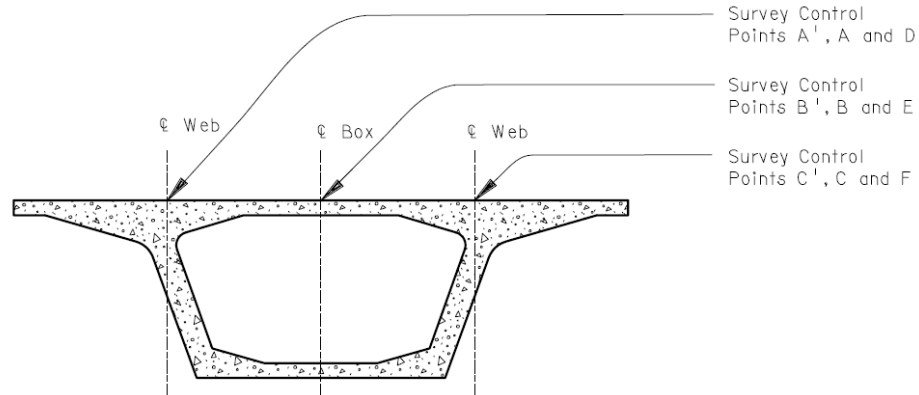

SEGMENT CROSS SECTION

NOTES:

1. Horizontal measurements are taken between Control Points A-A', C-C', A-B', C-B', A-D, C-F, B-D and B-F before casting the Poured (New) Segment.
2. Elevations are taken at Points A', C', A, C, D and F before and after casting the Poured (New) Segment.
3. Horizontal measurements are taken between Control Points A-A', C-C', A-B' and C-B' after casting the Poured (New) Segment.

ATTACHMENT 10-7-8 TENDON ELONGATION MEASUREMENT FOR A TYPICAL HYDRAULIC JACK

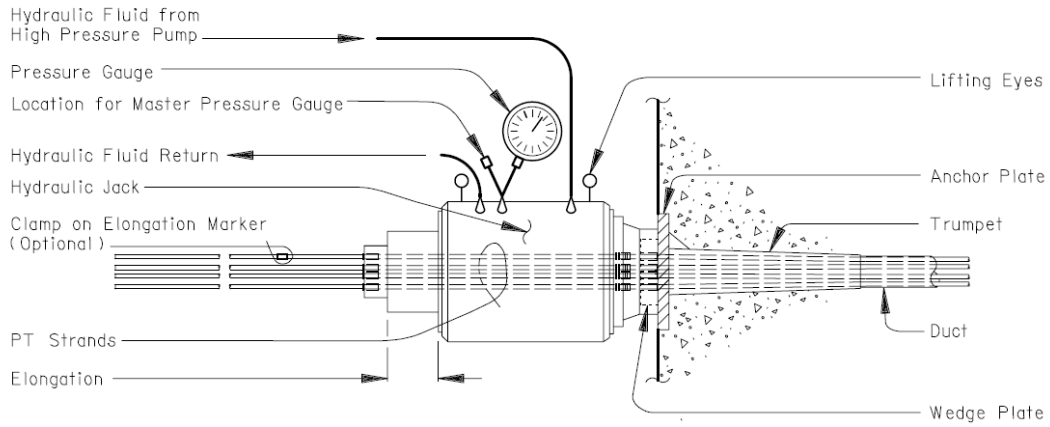

HYDRAULIC JACK DURING STRESSING

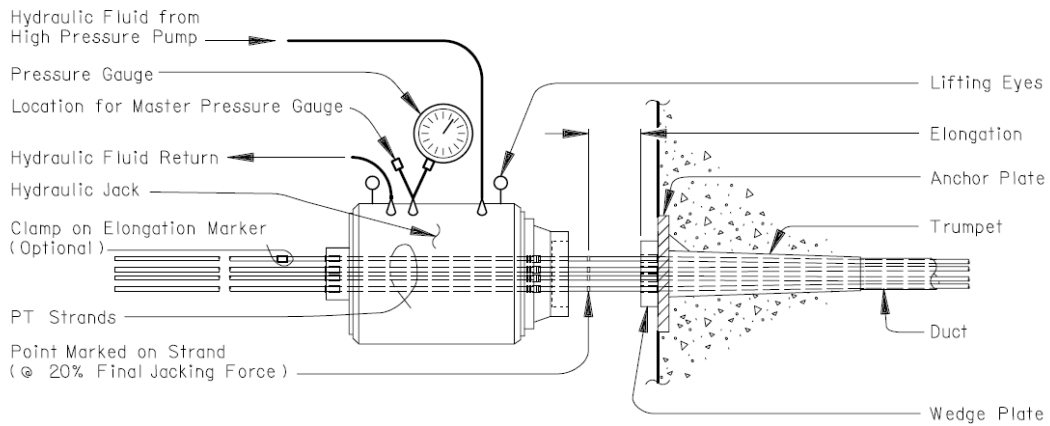

HYDRAULIC JACK AFTER STRESSING
(WHEN JACK IS PULLED BACK)

ATTACHMENT 10-7-9 CASTING YARD AND SEGMENT FABRICATION

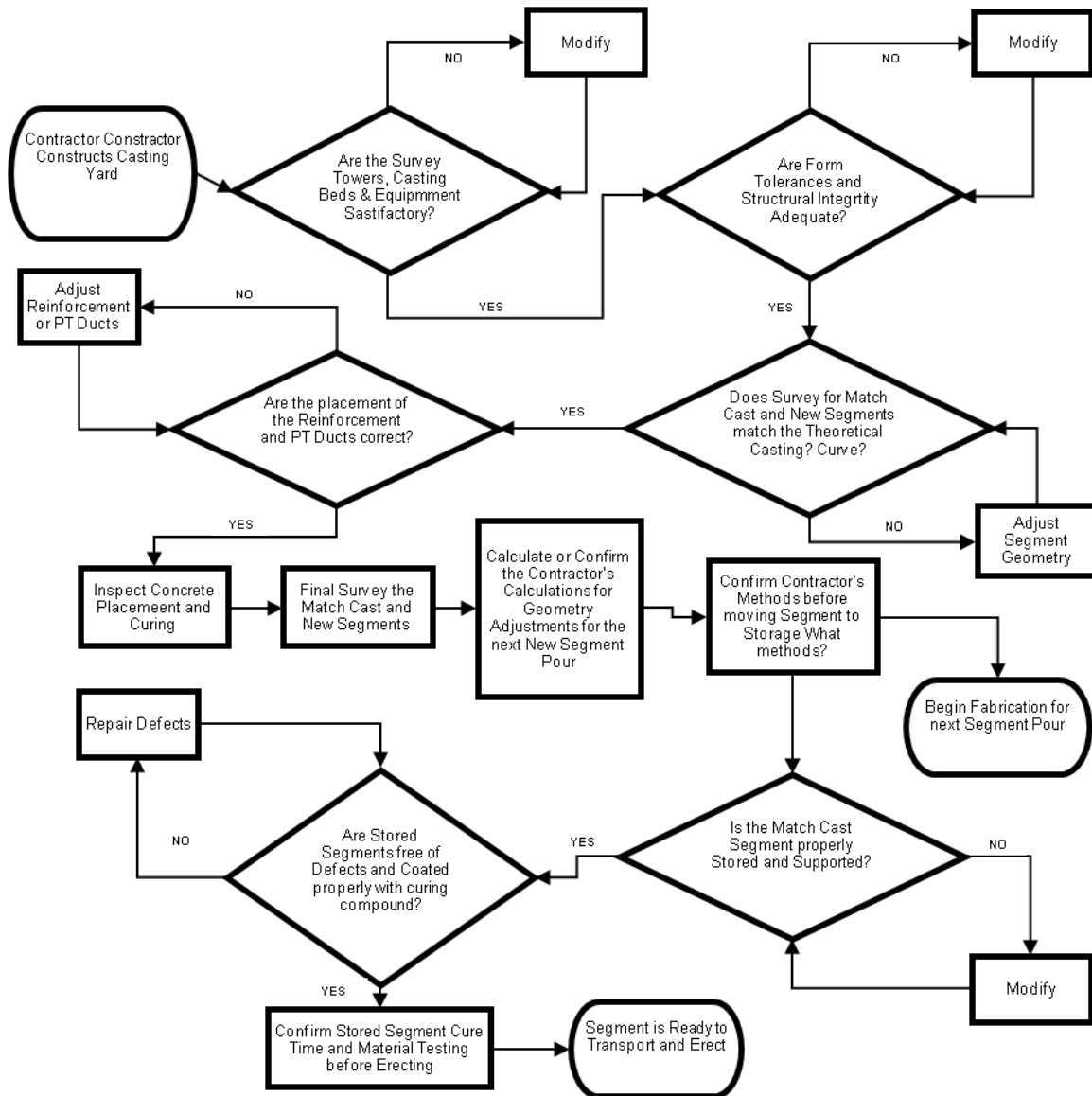

ATTACHMENT 10-7-10 SEGEMENT ERECTION AND JOINTING

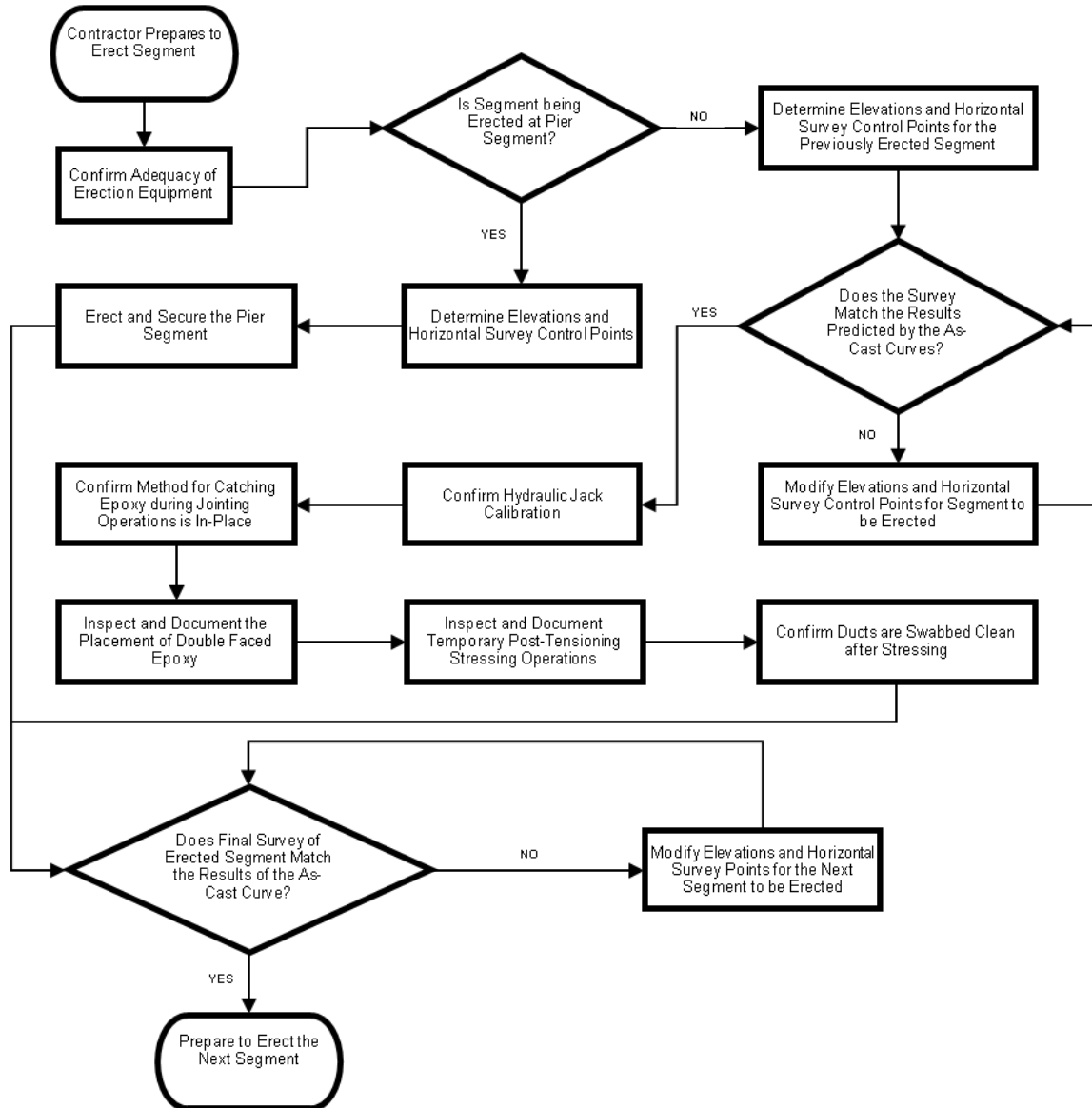

ATTACHMENT 10-7-11 POST TENSIONING

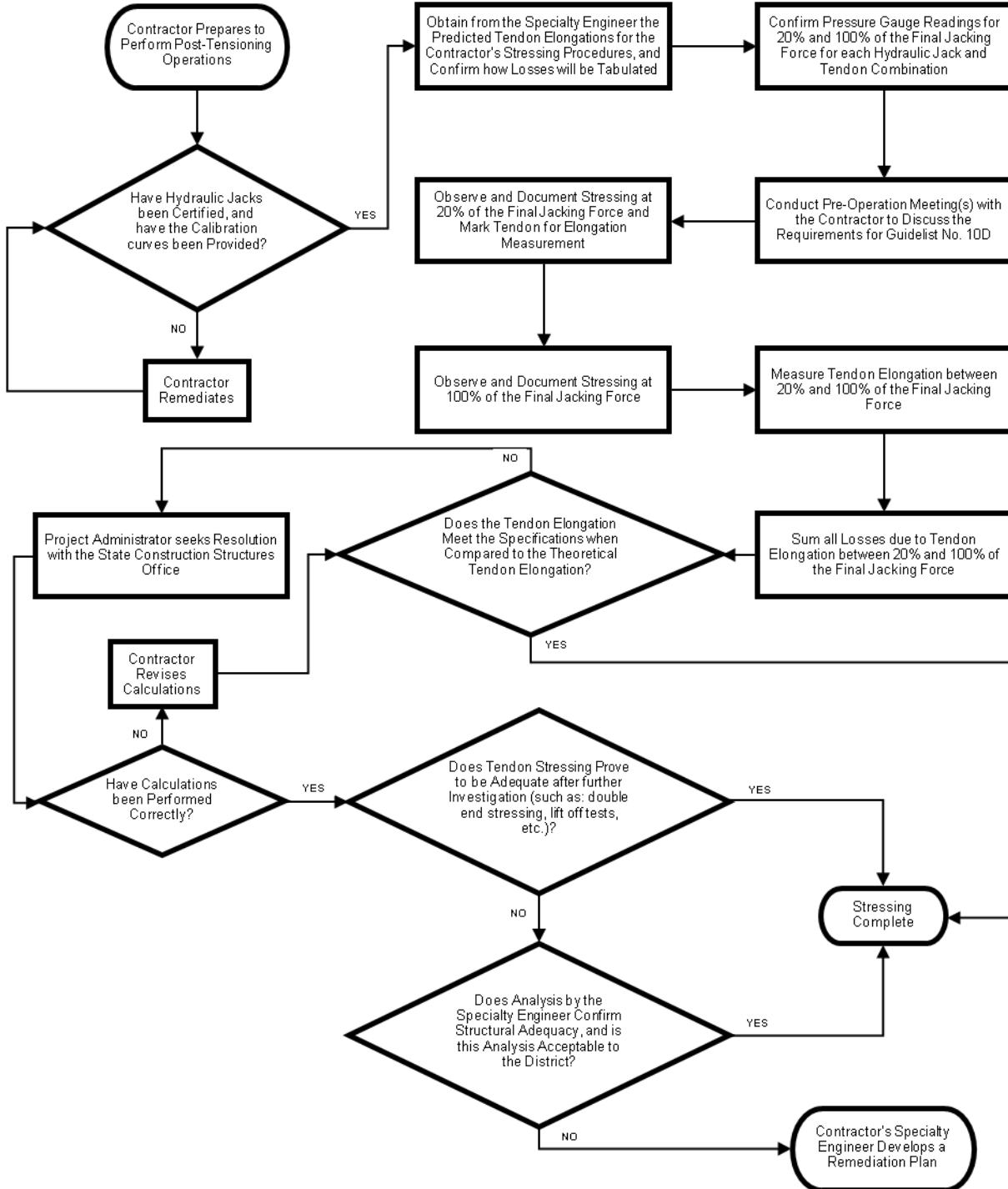

ATTACHMENT 10-7-12(a) GROUTING

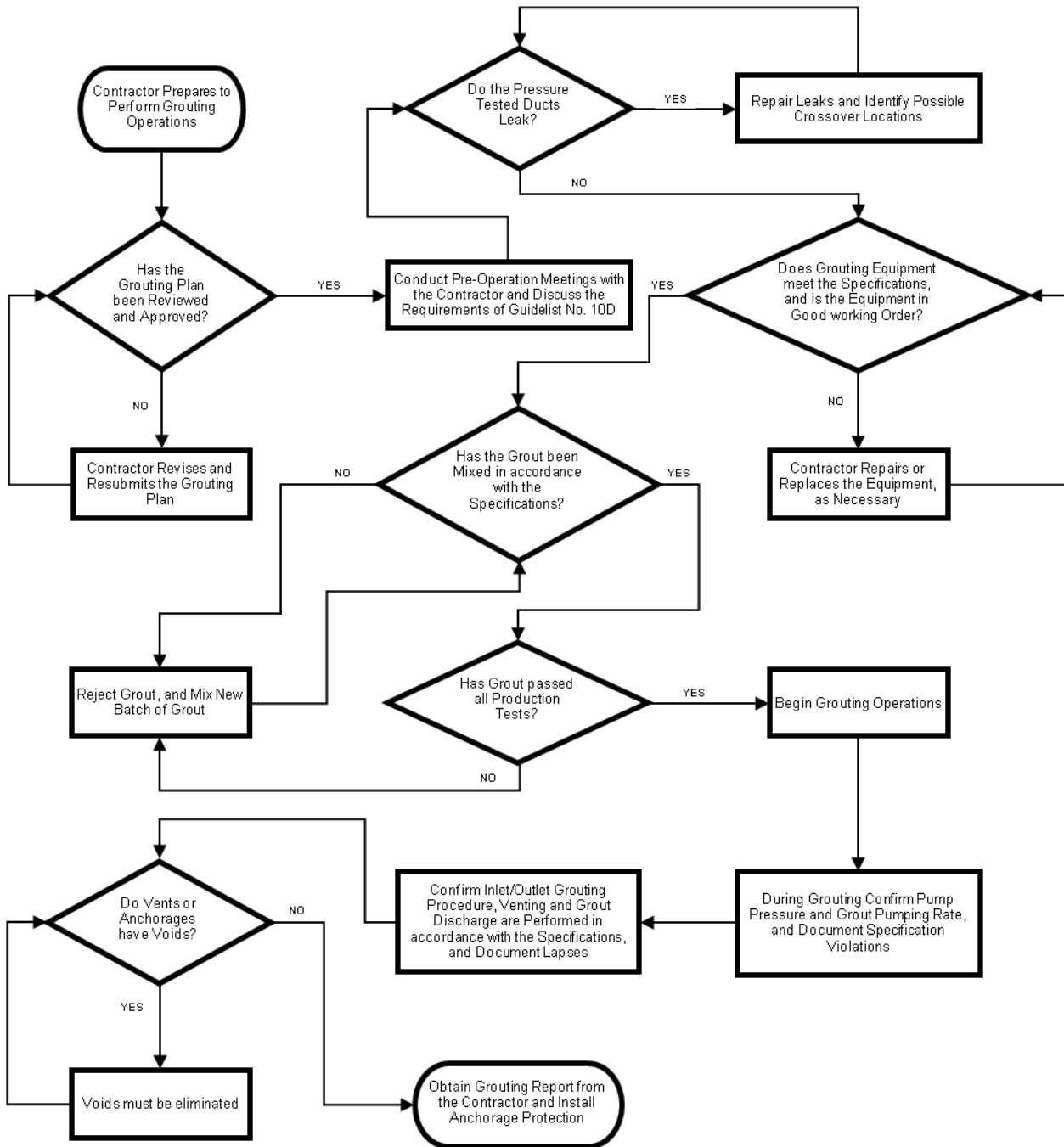

**ATTACHMENT 10-7-12(b)
 WAX INJECTION**

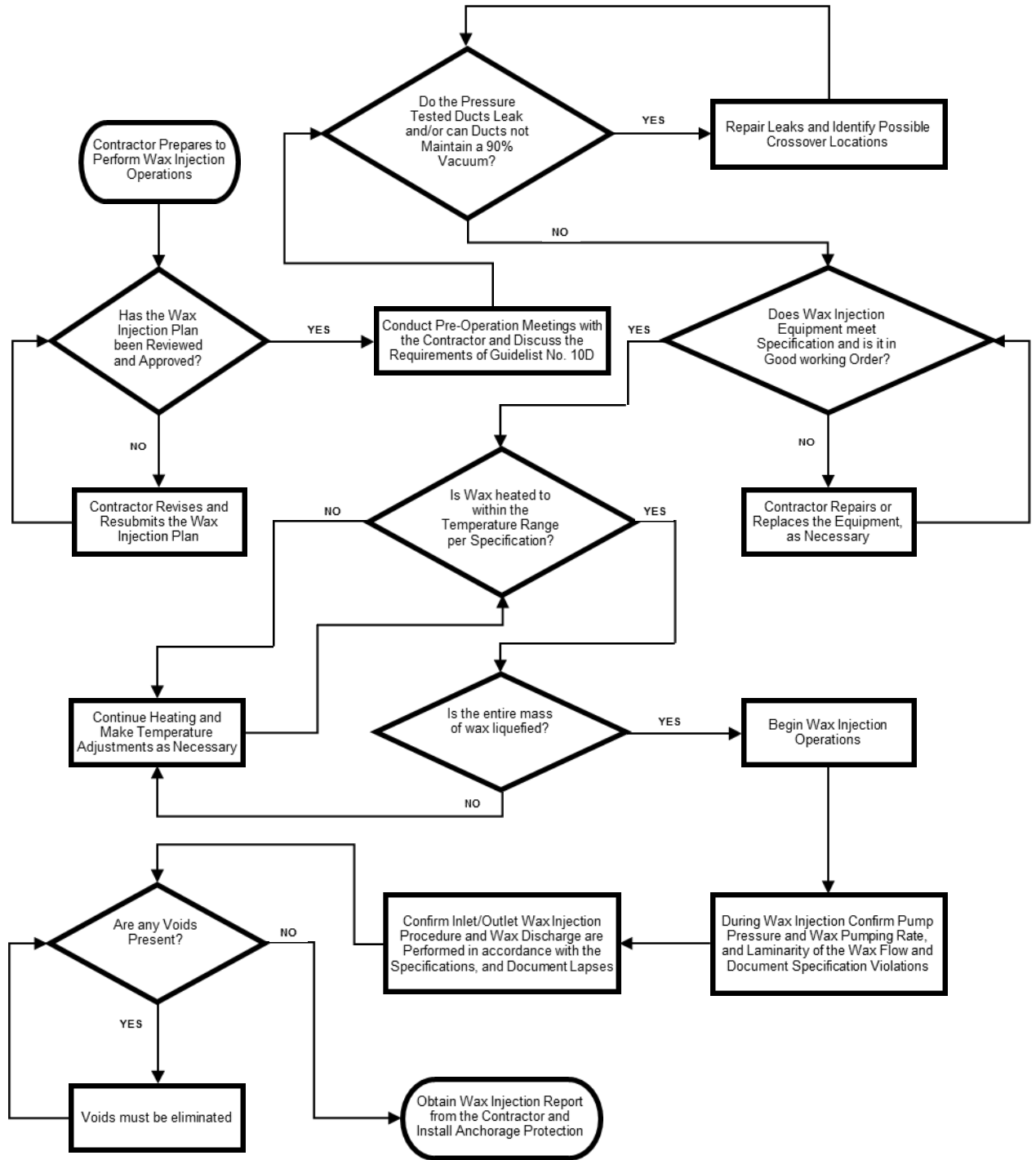

ATTACHMENT 10-7-13 CRACK INSPECTION AND REPAIR

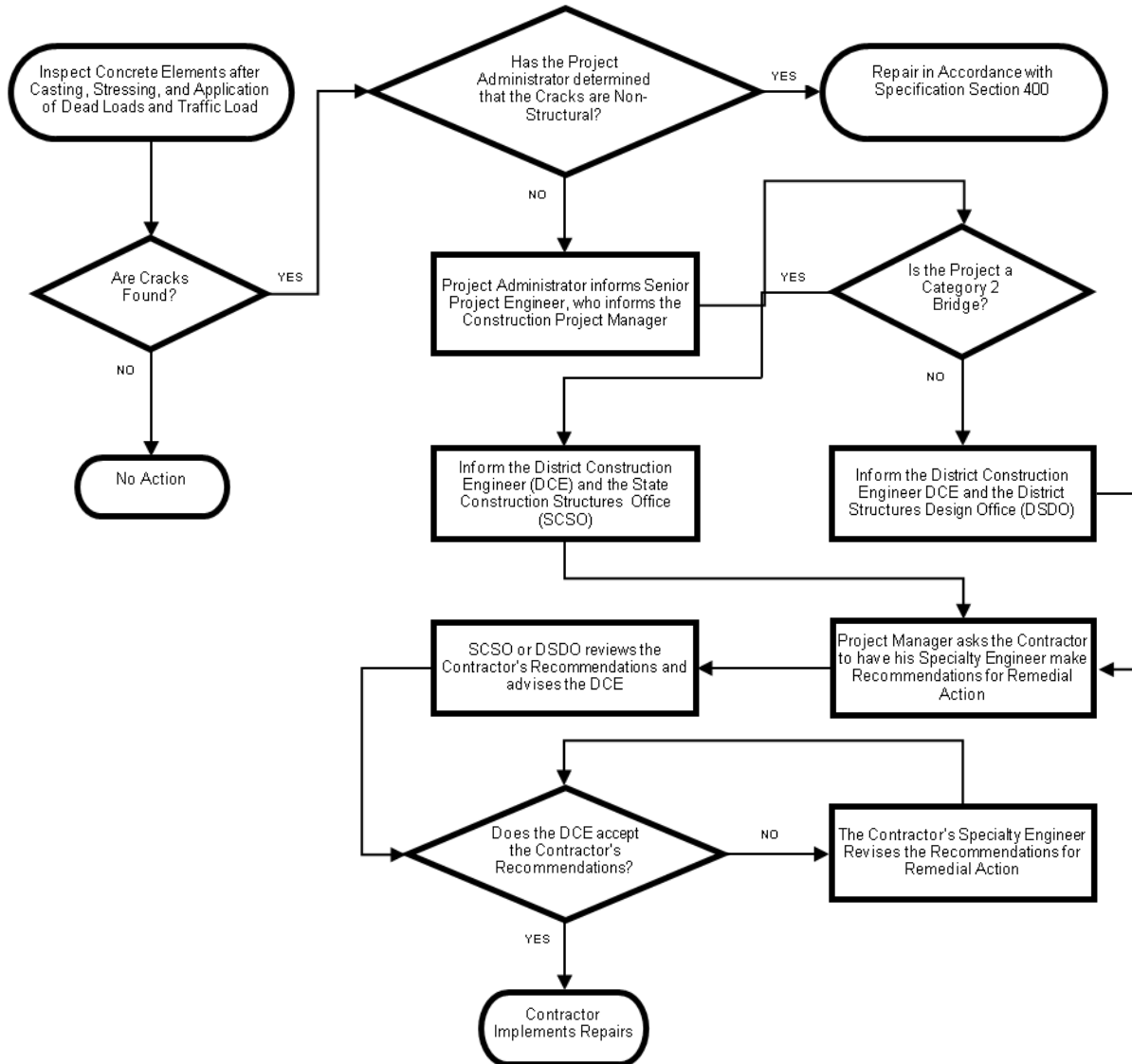

Section 10.8

AUGER CAST PILES

10.8.1 Purpose

To establish a procedure for the approval of the Contractor's Auger Cast Pile (ACP) Installation Plan, inspection and approval of mixing, pumping and demonstration of cement grout, and inspection and approval of piles installed in accordance with **Section 455, Structures Foundations, Standard Specifications** and any supplements thereto. This chapter also provides the procedure for the documentation of pile installation. This procedure applies to conventional projects; for Design Build projects refer to **Section 10.12**.

10.8.2 Authority

Sections 20.23(3)(a), and 334.048(3), Florida Statutes (F.S.)

10.8.3 References

Section 455, Standard Specifications for Road and Bridge Construction and Supplements thereto.

10.8.4 Scope

The principal users of this document include the State Construction Office District Materials and Research Offices (DMRO), District Construction Offices (DCO), District Operations Centers, the State Materials Office (SMO), and Construction Engineering and Inspection (CEI) firms working for the Department.

10.8.5 Definitions

District Construction Engineer (DCE): The authority for the entire construction activity in the District.

Construction Engineering and Inspection (CEI): In this procedure, it refers to the Consultant personnel performing CEI services or the Department's personnel group performing CEI services.

Geotechnical Engineer: In this procedure, the Geotechnical Engineer may be the District Geotechnical Engineer (DGE), any Department Engineer assigned to the project by the DGE, the Consultant Geotechnical Engineer working directly for the DGE, or the Geotechnical Engineer employed by the Department's Consultant CEI and performing under the direction of the DCE and DGE.

Resident Engineer (RE): The Engineer supervising the Project Administrator and is responsible for the construction activity in the residency.

Project Administrator (PA): The employee responsible for the everyday construction activity at the project under the direction of the Resident Engineer/Senior Project Engineer.

Demonstration Pile: The pile which the Contractor is asked to construct to demonstrate the dependability of the equipment, techniques, and source material prior to the start of production pile installation to the satisfaction of the Engineer (**Section 455-39.1**).

10.8.6 Approval of Pile Installation Plan- Non-Bridge Foundations

(A) Resident Level Responsibilities

The RE (or PA) shall receive from the Contractor at the preconstruction conference or at least 30 days prior to the construction of a demonstration pile a completed **Auger Cast Pile Installation Plan (ACPIP)**. Within one (1) working day, the RE (or PA) shall forward the ACPIP to the Geotechnical Engineer for review and recommendations. The RE (or PA) shall perform a concurrent separate review of the ACPIP and incorporate their own comments to the ones received from the Geotechnical Engineer. The ACPIP shall be evaluated and approved separately from other Quality Control Plans submitted by the Contractor. If the Contractor includes the ACPIP in the Quality Control Plan submittal, the PA shall detach the ACPIP from the Quality Control Plan submittal and notify the Contractor in writing of such action.

The RE (or PA), within one (1) working day of receipt of the Geotechnical Engineer's comments and/or recommendations shall notify the Contractor of acceptance/ rejection or request additional information and/or changes that may be necessary for pile construction in accordance with the contract documents. The letter of rejection shall contain the reason(s) for rejection of the ACPIP.

(B) District Materials and Research Office (DMRO) Level Responsibilities

The Geotechnical Engineer shall make comments and/or recommendations to the RE of the acceptance or rejection of the proposed pile installation equipment and techniques within five (5) working days of receiving the ACPIP.

10.8.7. Demonstration Pile Installation- Non-Bridge Foundations

(A) Resident Level Responsibilities

Demonstration pile installation shall be documented by the inspectors on the ***Auger Cast-in-Place Pile Installation Record, Form Number 700-011-03***. As soon as the Contractor's schedule for installation of the demonstration pile is known, the PA shall notify the Geotechnical Engineer of the schedule so the Geotechnical Engineer may observe the installation of the demonstration pile and approve the suitability of equipment, techniques, and source of materials.

The comments section of ***Form Number 700-011-03*** shall describe any occurrences during the installation of the pile or any information the recorder feels may be beneficial to the Geotechnical Engineer or the PA.

During the demonstration pile installation, the inspector and the PA must verify the equipment and techniques described in the approved ACPIP were used to install the demonstration pile and sign the form in the appropriate place documenting this. The original is retained in the project files. A completed form is to be sent to the Geotechnical Engineer within 24 hours of field work completion for review and acceptance.

Upon receipt of the letter from the Geotechnical Engineer recommending approval of the Contractor's means and methods of installation, the RE shall approve the recommendation and send it to the Contractor within one (1) working day.

(B) DMRO Level Responsibilities

Within two (2) working days of the receipt of the demonstration pile data, the Geotechnical Engineer shall review the demonstration pile data and give recommendations regarding the acceptance of the equipment, techniques and materials used during the demonstration pile installation. A letter, electronically signed, shall be

sent to the RE with the recommendations. Refer to **Guidance Documents 10-8-A, 10-8-B** for **Sample Letters**.

10.8.8 Production Pile Installation- Non-Bridge Foundations

Production pile installation shall be documented in the **Auger Cast-in-Place Pile Installation Record, Form Number 700-011-03**. Inspectors monitoring and documenting ACP installation, including demonstration and production piles, shall be **Construction Training & Qualification Program (CTQP)** qualified as **Auger Cast Pile Inspector**, or have taken and passed the Department's Computer Based Training (CBT) **Auger Cast Pile Inspector's Qualification Course**, before the beginning of the pile installation. The course is available at the following webpage:

<http://wbt.dot.state.fl.us/ois/AugerCastPileCBT/index.shtm>

10.8.9 Approval of Pile Installation Plan- Bridge Foundations

The Plans may include ACP for bridge foundations. In that situation, unless indicated otherwise in the Contract Documents, Developmental Specification Dev455ACP shall be followed for both bridge and non-bridge structures in the project.

A separate ACPIP must be submitted by the Contractor for bridge structures and non-bridge structures.

Approval, procedures and responsibilities shall be in accordance with section 10.8.5.

10.8.10 Demonstration Piles, Load Test Piles, and Pilot Holes- Bridge Foundations

As soon as the Contractor's schedule for pilot holes and installation of demonstration piles and load test piles is known, the PA shall notify the Geotechnical Engineer of the schedule so the Geotechnical Engineer can be present.

(A) Resident Level Responsibilities

A drilling log shall be maintained during pilot hole operations on the **Pilot Hole Log, Form No. 700-010-35** by the Contractor's Consultant performing the soil borings to record the soils and rocks encountered, and document rock core measurements during the drilling of the pilot hole.

Demonstration piles and load test piles shall be documented as described in section 10.8.6. Approval, procedures and responsibilities regarding the demonstration piles shall be in accordance with section 10.8.6.

Completed installation forms of the pilot holes, demonstration piles and load test piles shall be sent to the Geotechnical Engineer within 24 hours of field work completion for review and use in the analysis and recommendations of the authorized production tip elevations

(B) DMRO Level Responsibilities

A representative of the DGE office shall be available on site or over the phone to assist the CEI and resolve questions during these initial phases of the ACP construction. The DGE office shall assist the inspectors to monitor the ACP and fill the inspection logs properly.

10.8.11 Authorized Pile Tip Elevations- Bridge Foundations

Authorized production ACP tip elevations are established utilizing the results of the pilot holes, demonstration piles, load tests, rock core information and contract documents. Actual ACP depths may vary from those shown on the Plans depending on the subsurface soil/rock conditions encountered during ACP installation. If no new information is available since the Plans were developed, tip elevations on the Plans are the authorized tip elevations and no authorization letter is required.

(A) Resident Level Responsibilities

Upon receipt of the Authorized ACP Tip Elevations letter from the Geotechnical Engineer, the RE shall approve the recommendation and send it to the Contractor within one (1) working day.

Completed forms of demonstration piles, load test piles and pilot holes shall be sent to the Geotechnical Engineer within twenty-four (24) hours of field work completion for review and use in recommending the production ACP lengths. All load test data, pilot hole logs and core boring reports, if any, shall also be sent to the Geotechnical Engineer within twenty-four (24) hours after being received from the Contractor. Installation of all ACP including Demonstration Piles, Load Test Piles and production ACP for bridges must be inspected by personnel with **CTQP Qualification in Auger Cast Pile Inspector**.

(B) DMRO Level Responsibilities

Within four (4) working days of receipt of the completed Demonstration Logs, Pilot Hole Logs, rock core samples, and any Load Test Reports, the Geotechnical Engineer shall send an **Authorized Auger Cast Pile Tip Elevations** letter to the RE or higher authority recommending the ACP tip elevations to be used on the project. The RE or higher authority shall send this letter to the Prime Contractor authorizing production ACP tip elevations as indicated in section 10.8.10 (A). A sample letter is included in this chapter. Refer to Guidance Document 10-8-C for sample letter and distribution.

If requested by RE or PA, the Geotechnical Engineer may make a telephone call or send an electronic mail to notify the PA of the ACP tip elevations.

10.8.12 Training

All FDOT, CEI personnel performing inspections of auger cast pile installation for bridges must hold the Construction Training Qualification Program (CTQP) as Auger Cast Pile Inspector. All FDOT and CEI personnel performing inspections of auger cast pile installation for non-bridges must either hold the Construction Training Qualification Program (CTQP) as Auger Cast Pile Inspector, or have taken and passed the FDOT CBT class for Auger Cast Pile Inspector.

10.8.13 Forms

The following forms are available from the Policy & Process Management Forms Library at [Procedural Document Library \(fdot.gov\)](https://www.fdot.gov/procedural-document-library):

700-011-03, Auger Cast-in-Place Installation Record

Guidance Document 10-8-A

**SAMPLE LETTER NO. 1
PRODUCTION AUGER CAST PILE INSTALLATION**

(ADDRESSEE)

(DATE)

Financial Project ID:

FAP No.:

Contract No.:

County:

Dear (_____):

The District (put in which District, 1-7, Turnpike Enterprise) Geotechnical Office has completed its review of the demonstration pile data of the Auger Cast Piles and recommends acceptance of the installation of Production Piles with the equipment, techniques, and source of materials utilized during installation of the Demonstration Pile.

If you have any questions or require further information, please let us know.

Recommended for acceptance by:

District Geotechnical Engineer/Geotechnical Engineer

Authorized for contract administration purpose by:

Resident Engineer

Guidance Document 10-8-B

**SAMPLE LETTER No. 2
PRODUCTION AUGER CAST PILE INSTALLATION**

(ADDRESSEE)

(DATE)

Re: Financial Project ID:
FAP No.:
Contract No.:
County:

Dear (_____):

The District (put in which District, 1-7, Turnpike Enterprise) Geotechnical Office has completed its review of the demonstration pile data of the Auger Cast Piles and recommends acceptance of the installation of Production Piles with the equipment, techniques, and source of materials utilized during installation of the Demonstration Pile.

If you have any questions or require further information, please let us know.

Recommended for acceptance by:

Consultant Geotechnical Engineer

Concurrence by: _____
District Geotechnical Engineer (if required by District)

Authorized for contract administration purpose by:

Resident Engineer

Guidance Document 10-8-C

AUTHORIZED AUGER CAST PILE TIP ELEVATIONS

(ADDRESSEE)

(DATE)

Re:
Financial Project ID:
Contract No.:
County:
Structure #

Dear ()::

This office (or the Geotechnical Engineering Form) has completed its review of the test load/core boring data for the subject bridge. Recommended Auger Cast Pile Tip Elevations and rock socket lengths are as follows:

LOCATION	PILE SIZE	RECOMMENDED PILE TIP ELEVATION	MINIMUM SOCKET LENGTH
-----------------	----------------------	---	--------------------------------------

If you have any questions or require further information, please let us know.

Recommended by: _____
District Geotechnical Engineer/ Geotechnical Engineer

Recommended for acceptance by: (when consultant generates the letter)

District Geotechnical Engineer

Authorized for contract administration purpose by:

Resident Engineer

(INITIALS/INITIALS)
cc: State Construction Geotechnical Engineer
State Structures Design Engineer's Office (State Design Geotechnical Engineer)
FHWA (only if Federal Aid oversight project)

Section 10.9

STRUCTURAL STEEL AND MISCELLANEOUS METAL COMPONENTS

10.9.1 Purpose

The purpose of this procedure is to provide a process for the evaluation and acceptance of fabricated structural steel and miscellaneous metal components. This procedure addresses nonconforming components which are defective or damaged. Repeated production of nonconforming components is not acceptable, and the cause of such problems must be resolved.

10.9.2 Authority

Section 334.048(3) and 20.23(3)(a), Florida Statutes

10.9.3 Commercial Inspection of Fabricated Items

Specification 105-1.2.3 directs the Contractor to submit to the Engineer a fabrication schedule for all items requiring commercial inspection. The Project Administrator shall forward this schedule to the State Materials Office upon receipt from the Contractor. If the Contractor has not provided this list within 30 days prior to beginning fabrication of elements (such as mast arms, overhead signs, plate girders, etc.) to the job site, direct the Contractor to comply with this requirement. Fabricated products must be scheduled for inspection in sufficient time to allow State Materials Office inspection prior to delivery to the jobsite.

10.9.4 Evaluation and Disposition of Components not in Compliance with the Contract Documents

10.9.4.1 General

Components containing specific defects or damage covered by pre-established procedures in the Department approved Producer QC Plan shall be repaired in accordance with said procedures.

For defects or damage to components that do not conform with the Contract Documents, the Contractor must comply with **Specification 460-4.6**, which requires the submittal of a repair proposal to the Project Administrator and specifies what the contents of the proposal shall be. Components in the fabricating facility which

require repairs shall not be shipped to the project site until such repairs are complete and the member has been accepted by the Department. If the component is repaired and determined to be acceptable to the Department, the component shall be stamped or tagged by the fabricator indicating that it meets specification requirements. Producer-stamped members arriving at the job site shall not be rejected by project personnel for reasons other than obvious shipping damage which makes the member unacceptable. Questions of acceptability of stamped members, which have not incurred shipping damage, are to be resolved with proper input from the Quality Assurance Inspector (QAI) at the shipping point prior to rejection at the job site.

10.9.4.2 Proposal Format and Requirements

The Contractor's proposal shall be in writing and include the following:

- (A) A cover page describing the nonconforming component and the proposed credit to the contract proportionate to the defect or specification nonconformance.
- (B) A completed ***Nonconforming Structural Steel and Miscellaneous Metal Component Data Sheet (Data Sheet)***, [Form No. 675-010-10](#), prepared by the fabricator or Contractor and countersigned by the QAI to indicate agreement with the described defect or nonconformance feature. If not in agreement with the information or description, the QAI shall either reject the submittal indicating reason(s) for rejection or modify the submittal as necessary.
- (C) A list of supporting information such as sketches, documentation, calculations, etc., must be included in the appropriate space on the ***Data Sheet***. Additional sheets may be attached as needed. All the supporting information required for the form must be prepared by, or be under the supervision of, the Contractor's Specialty Engineer who shall sign and seal the supporting information.
- (D) A structural and durability evaluation when nonconforming components exhibit deficiencies that affect the strength and/or serviceability of the component in the completed structure. The Contractor's Specialty Engineer must submit a signed and sealed structural and durability evaluation of the proposed repair and/or remediation of such components.

10.9.4.3 Review and Evaluation

(A) Resident Level Responsibilities

The Project Administrator shall review the Contractor's proposal and enlist the assistance of the various offices within the Department, the Engineer of Record and the QAI as deemed appropriate. Upon completion of the evaluation, the Project Administrator may accept the Contractor's proposed repair method and cost reduction or reject the repair proposal.

The Project Administrator shall send the Contractor's proposal to the Engineer of Record (EOR), the State Construction Structures Engineer (SCSE) and the State Materials Office (SMO) regarding disposition of the Contractor's proposal. The PA shall base the disposition of the Contractor's proposal upon comments and recommendations by the EOR, the SCSE and the SMO.

10.9.4.4 Disposition and Distribution

(A) Resident Level Responsibilities

The Project Administrator shall indicate acceptance or rejection in the response and distribute and document the proposal and the disposition to appropriate District personnel in addition to the following:

1. Collaboration Site and/or EDMS
2. State Materials Office
3. Quality Assurance Inspector

10.9.5 Testing and Record Keeping for Structural Steel

10.9.5.1 Job Inspection Snug Tight Torque and Rotational Capacity Tests

Specification 460-5.4.8, Turn-of-Nut Tightening, requires a Job Inspection Snug Tight Torque (JIT) test be performed for each work shift. The test consists of determining a snug tight torque for a representative sample of 5 fastener assemblies of the type used on the day of the test. During the test, the assemblies are tightened to a snug tight condition after which a prescribed degree of nut turn is applied (Turn-of-Nut). The test is performed with the aid of a Skidmore-Wilhelm Calibrator device which measures the bolt tension in kips for a given fastener assembly tightness. The bolt assembly passes the test if the final tension after turning of the nut exceeds 1.05 times the minimum required fastener tension in **Specification Table 460-6**. For example, a 7/8-inch diameter bolt passes the test if the bolt tension after turn-of-nut is equal to or greater than 41 kips (1.05 times 39 kips from **Table 460-6**).

The Rotational Capacity (RC) Test required by **Specification 460-5.2.1** is performed according to **FM 5-581** or **5-582**, the Florida Methods of Test for Performing Rotational Capacity Test, Long Bolts and Short Bolts, respectively. The RC Test verifies that fastener assemblies can attain at least a 15% or greater increase in tension than the minimum required fastener tension. For example, the 15% minimum requirement of an ASTM F3125 A325 bolt is 45 kips for a 7/8-inch diameter (1.15 times 39 kips from Table 460-6). The RC test does not establish how much additional tension beyond the 15% minimum that the bolt can take before it fails. Results for Rotational Capacity Testing of Long Bolts can be documented using [Form 675-010-15a](#) and likewise for Short Bolts using [Form 675-010-15b](#).

In the past, there has been confusion about how to determine the starting tension and torque for the JIT test because some testers assume that the RC test snug tight torque should also apply to the JIT test. This makes the JIT test easier because it can be started basing a torque off of a predetermined tension. The starting tension in the RC test should not automatically be used for the JIT test as “snug-tight” and is different in the context of each test. Once the JIT test is begun and an initial trial torque is determined and applied, if the tension produced after the turn-of-nut is not 5% or greater than the minimum required fastener tension, then another trial with an increased initial torque must be performed and so on until the 5% is achieved. Once an acceptable trial torque has been determined for the first bolt assembly of the five tested for that LOT then the acceptable trial tension should also work for the remaining four assemblies.

All JIT and RC tests shall be observed in-person by a CEI inspector and all test data and results must be recorded either by the Contractor or by the CEI inspector and the test procedures shall be addressed in the Contractor’s Quality Control Plan. If test data and results are recorded by the Contractor, the CEI inspector shall verify that the data is accurate and complete. A copy shall be retained in the CEI files for the project.

10.9.5.2 Shear Connector Bend Tests

Specification 502-4.8, Testing, requires the Contractor to perform Shear Connector Bend Tests and the article specifies how the tests are to be performed. All Shear Connector Bend tests shall be observed in-person by a CEI inspector. The location of tested connectors and the results of the tests shall be recorded either by the Contractor or by the CEI inspector and the test procedure shall be addressed in the Contractor’s Quality Control Plan. If test data is recorded by the Contractor, the CEI inspector shall verify that the data is accurate and complete. A copy shall be retained in the CEI files for the project.

Section 10.10

RESOLUTION OF BRIDGE CONSTRUCTION ISSUES

10.10.1 Purpose

The purpose of this section is to make Construction Engineering and Inspection (CEI) personnel aware of the procedural requirements for resolving bridge construction project issues of varying complexity. Primarily this section addresses procedures of involvement by the State Construction Office (SCO) State Construction Structures Engineer (SCSE) but also details the involvement of District-level staff in bridge-related issues during construction.

10.10.2 Authority

Section 20.23(3)(a), Florida Statutes

Section 344.048(3), Florida Statutes

10.10.3 Reference

Section 336.045, Florida Statutes

10.10.4 General

To ensure proper resolution of bridge construction issues so as to maintain quality bridge construction, this section provides CEI Staff proper guidance for Departmental involvement on such issues. Such issues are typically submitted to the CEI in the form of one of the following Contractor initiated submittal types, guidance for which can be found in **CPAM Chapter 8.11**:

- Request for Information (RFI)
- Request for Modification (RFM)
- Request for Correction (RFC)

In general, the SCO is required to be involved with resolving all complex bridge construction issues but may be consulted on an as-needed basis for other issues. The District is to be involved with non-complex bridges and other issues needing resolution.

This procedure describes the categories of bridges requiring either SCO or District involvement as well as how that involvement shall take place.

10.10.5 Design Category 1 Members

Construction issues related to Category 1 (C1) Structures, as defined in the ***FDOT Design Manual, Number 625-000-002, Chapter 121 Bridge Project Development***, do not typically require involvement by the SCSE. When these issues arise on a project, the CEI staff shall consult with the Engineer of Record (EOR) for design issues and bridge engineers in the following District offices, whether design or construction issues, as appropriate: District Construction, District Structures Design, District Materials and District Structures Maintenance. The District Structures Design Engineer must be given the option of reviewing any EOR recommendation, by an EOR established deadline, prior to finalizing any response back to the Contractor and CEI staff must verify that this takes place. The District Structures Design Engineer's failure to concur on or before the deadline, unless an extension is requested, shall signify that the District Structures Design Engineer chooses not to review. If engineers in these District offices are unable to address or resolve an issue then CEI staff should contact the SCSE for assistance and the procedures that prescribe SCSE involvement shall be the same as for members as set forth in ***CPAM Section 10.10.6***. Issues related to bridge members with exceeding complexity of the C1 designation must be resolved with ***CPAM 10.10.6***. For example, if issues arise on a bridge with long span curved steel box girders and the substructure has cast-in-place concrete columns, ***CPAM 10.10.5*** shall be used for issues related to the column, with the stated exceptions, and ***CPAM 10.10.6*** shall be used for issues related to the steel girders.

10.10.6 Design Category 2 Members

Construction issues related to Category 2 (C2) Structures, as defined in the ***FDOT Design Manual, Number 625-000-002, Chapter 121 Bridge Project Development*** shall be resolved within the respective section of ***CPAM Sections 10.10.6.1*** through ***10.10.6.3*** by CEI staff with coordination from the EOR and SCSE. The SCSE will address complex construction issues directly and make recommendations back to the CEI staff for resolution. Obtain EOR input on complex issues either prior to or concurrently with SCSE input.

10.10.6.1 Contractor Initiated Changes for Complex Superstructure Members and Complex Issues

When a Contractor proposes a change to the plans, shop drawings, specifications or means and approved methods plans (segment erection plans, post-tensioning plan, grouting plans, etc.) that are related to complex superstructure members or complex

issues, the SCSE and the EOR, shall be informed of the Contractor's intent. If possible, this should be done prior to a formal submittal from the Contractor to allow the Department to provide a preliminary response regarding acceptability of the proposal. For design related proposals, the EOR shall be the initial point of contact with confirmation to be provided from the SCSE. CEI staff shall inform the EOR of this concurrence requirement. For proposals that are not design related, the initial point of contact shall be the SCSE who shall provide a response. This preliminary process will eliminate unnecessary submittals by the Contractor along with the corresponding effort. Questions regarding the acceptability of a Contractor Initiated change shall be directed to the SCSE.

If the Department agrees to consider the proposal then the Contractor shall formally submit the proposal to the CEI staff with appropriate supporting documents. CEI staff shall inform the Contractor that the Department's agreement to consider the proposal in no way obligates the Department to approve the proposal or to reimburse the Contractor for any costs that the Contractor may incur to prepare the proposal. CEI staff shall transmit the proposal to the EOR for design related proposals for review and comment, concurrently to the SCSE, along with the desired response time. The EOR will prepare a response to the proposal after consultation with the SCSE, making every effort to stay within the desired response time, and submit it to CEI staff and the District Structures Design Engineer. Disposition and approval of the proposal will be at the discretion of the District Construction Engineer (DCE) or a designee prior to notification of the Contractor. For proposals that are not design related, the formal proposal shall be transmitted to the SCSE who shall provide a recommendation response within the requested time. The DCE or a designee must approve the SCSE recommendation prior to notification of the Contractor. The SCSE and/or EOR may also request additional supporting documents via the CEI staff after reviewing the initial proposal; the final response may be delayed pending their receipt. On occasion, more than one cycle of submittal of additional supporting documents by the Contractor may be required before a final response can be issued. The State Structures Design Office will work through, and be coordinated by, the SCSE if their involvement is required.

10.10.6.2 Contractor Noncompliance with Contract Documents for Complex Superstructure Members and Complex Issues

Following are examples of how a Contractor can be out of compliance with contract documents for complex superstructure members or complex issues:

- Structural components (rebars, tendons, ducts, bearings, etc.) are out of tolerance
- Post-tensioning strand elongation that is above or below the required value
- The misalignment of beams in relation to their bearings

- Beam cambers that exceed specification tolerance
- Bolts are not installed and/or tightened according to specified procedures
- Grout or wax injection procedures are not in accordance with the approved injection plan

Unless the DCE directs the Contractor to remove and replace the member or component in question, when the forgoing examples or other complex noncompliance issues arise, notify the SCSE and EOR as soon as the issue is identified in order to assist in developing the Department response. Any documents submitted by the Contractor for disposition of the issue shall be forwarded to the SCSE, and the EOR for review. The SCSE and EOR may also request additional supporting documents after reviewing the initial information and final recommendations may be delayed pending their receipt.

Recommendations may include requiring compliance regardless of impact, waiver of the noncompliance, or acceptance of the noncompliance with modifications that make it the equivalent of being compliant. On-site meetings with the Contractor may be required to resolve the issue. The SCSE or EOR will make a recommendation to the CEI staff, copying the District Structures Design Engineer, about how to resolve the issue in question. However, the final resolution shall be approved by the District Construction Engineer prior to notification of the Contractor.

Resolutions that result in a change to the As-Bid plans or drawings must be reflected in the final As-Built plans and drawings in accordance with **CPAM Section 5.12**.

10.10.6.3 Resolution of Damage or Defects of Complex Superstructure Members and Complex Issues

Bridge members may be damaged during handling or placement. Examples include denting, kinking or buckling of steel girders during fabrication or erection; chipping, spalling or cracking of concrete beams during and after installation; or the damaging of concrete bridge segments during handling and erection. Some examples of typical bridge member defects include cracked concrete due to uncontrolled shrinkage; overstress or improper placement procedures; coating systems that do not adhere properly; secondary components such as bearings that are unacceptable for incorporation into the project; or machinery or electrical components that do not perform as intended. As soon as damage or a defect is discovered, the SCSE shall be notified in order to assist in developing proper disposition by the Department unless the DCE directs the Contractor to remove and replace the member, in which case notification of the SCSE is not required. If the damage or defect is design related, then the initial point of contact shall be the EOR who shall consult with the SCSE for concurrence of the Department prior to making a final disposition

recommendation on the issue. CEI staff shall inform the EOR of this concurrence requirement. Disposition may include acceptance as-is, rejection of a member or component, or acceptance with corrective action and/or credit. The SCSE may also choose to attend on-site meetings with the Contractor or with experts involved with resolution of the issue and may choose to personally inspect the damaged or defective work in place. The SCSE or EOR will make a recommendation to the CEI staff about what action to take; however, final action shall be approved by the District Construction Engineer or a designee. Actions that result in a change to the As-Bid plans or drawings must be reflected in the final As-Built plans and drawings in accordance with **CPAM Section 5.12**.

10.10.6.4 Provision of On-Site CEI Training

At the option of project CEI staff, the SCSE is available to perform on-site training in complex bridge construction and inspection topics for inspectors and other staff. The following training topics are offered:

- High strength bolt installation and inspection
- Stressing and inspection of Post-tensioning tendons
- Filler injection and inspection of Post-tensioning tendons

This training shall be requested by the Construction Project Manager or Resident Engineer. A minimum of four week's notice is preferred.

Section 10.11

GENERAL STRUCTURES CONSTRUCTION ISSUES

10.11.1 Purpose

The purpose of this section is to establish procedures that are required for use on most or all structures projects and that cover a variety of issues as follows:

- 10.11.3 - Notifying the District Structures Maintenance Engineer (DSME) of In-Service Dates and Acceptance Inspections
- 10.11.4 - Notification and Monitoring of Load Rating Requirements
- 10.11.5 - Electronic Filing of Bridge Construction Documents
- 10.11.6 - Contractor Applied Overloads on Department-Owned Temporary Bridges
- 10.11.7 - Temporary Bridge Activities

10.11.2 Authority

Sections 20.23 (4)(a) and 334.048(3), Florida Statutes (F.S.)

10.11.3 Notifying the District Structures Maintenance Engineer of In-Service Dates and Acceptance Inspections

Within sixty (60) days of the start of work on the project and based on the Contractor's Accepted Work Progress Schedule, the Project Administrator (PA) will provide the DSME with the tentative date that each bridge will be put into service for public use referred to herein as the in-service date. If these dates change by more than three (3) months as the project progresses, the PA must notify the DSME of the revised dates as soon as possible.

The amount of time that District Structures Maintenance Inspectors will need to perform a pre-acceptance inspection will vary based on the size and complexity of the structure. Consequently, the amount of advance notice needed to schedule the inspection will also vary. Because of this the PA must contact the DSME early on in the Project to determine the amount of advanced notice required by maintenance inspection staff to perform their

inspection. Accounting for the DSME's advanced notice duration, the PA must notify the DSME either the date the pre-acceptance inspection should begin or when the bridge is 90% complete, whichever comes first. When possible, the inspection by maintenance staff should coincide with the 90% inspection recommended by **CPAM Section 12.1** and in which the Construction Engineering and Inspection (CEI) staff and Contractor participate.

Prior to the start of inspection by maintenance inspection staff, the PA will confirm that the surfaces and components that will need to be inspected are fully accessible and visible for inspection. The PA will facilitate the need for access equipment with the Contractor. Maintenance inspection staff will provide a written report of findings to the PA that may require corrective action of defects or damage prior to final acceptance of the project or prior to the in-service date. Once the conditions reported by the DSME have been addressed by the Contractor, the results must be reported to the DSME who may choose to perform a follow-up inspection which may include the gathering of bridge data needed for the Bridge Management System (BMS).

One week prior to any bridge, temporary or permanent, being put into service for public use, the PA will notify the DSME of the final in-service date and time. This will allow the DSME to timely activate the bridge in the BMS to facilitate the issuance of permits to special vehicle operators requesting to use the bridge for an overweight and/or over-dimension load, as well as to inform the District Structures Maintenance Office (DSMO) of the existence of a temporary bridge.

The PA must notify the DSME of the final acceptance inspection, required by **CPAM Section 12.1**, at least 30 days in advance of performing the inspection when there is enough project time left to do so; otherwise, as much time in advance as possible. For bridges that the DSME has inspected prior to final acceptance and that have been in service, sometimes for an extended period of time, the CEI staff should pay particular attention to the final inspection of bridge elements that might have durability or performance problems within the first five years of service including: bearings, expansion joint seals and hardware, lighting and electrical systems, drainage systems, and coatings (paint systems for steel, etc.). Any problems with these elements must be reported to the DSME who may choose to perform a follow-up inspection of these elements.

10.11.4 Notification and Monitoring of Load Rating Requirements

The DSME is responsible for ensuring bridges in service have an accurate load rating including any bridge put into service before construction of the overall project is complete. The load rating must be performed in accordance with the applicable Office of Maintenance **Bridge Load Rating Manual, Topic Number 850-010-035**. For load ratings of temporary

bridges constructed using temporary bridging provided by the Department, contact the Office of Maintenance, Structures Operations Section.

Typically, bridge load rating information for new bridges is contained in the Bridge Load Rating sheet of the As-Bid Plans. However, if there are significant structural changes to the As-Bid Plans during construction then the load rating may change and an As-Built load rating will need to be determined prior to putting the bridge into service. To make certain that the DSME receives an accurate load rating before a bridge is put into service during construction, the PA must notify the Engineer of Record (EOR), enough time in advance of the anticipated in-service date to allow the EOR to assess whether or not the As-Bid load rating has changed. The PA will provide As-Built information as requested by the EOR which may include materials testing results, bridge member dimensions, differences from predicted prestressed concrete beam cambers and build-up adjustments, or other strength-related data that differs significantly from the As-Bid plans. If the EOR determines that the load rating has changed then the Bridge Load Rating sheet in the As-Bid plans must be revised to reflect the As-Built load rating and this sheet along with the As-Built load rating must be transmitted to the DSME prior to putting the bridge into service. For example, if the predicted prestress concrete beam cambers based on field measurements differ by more than $\pm \frac{1}{2}$ inches from the theoretical "Net Beam Camber @ 120 Days" shown in the As-Bid plans, the EOR will revise the As-Bid load ratings if warranted. If the EOR determines that a load rating has changed significantly, particularly if reduced, then the PA will coordinate discussions between the EOR, District Structures Design Engineer, and the District Structures Maintenance Engineer to decide on an appropriate course of action. The revised **Bridge Load Rating Sheet** must be signed and sealed by the EOR and the sheet title changed to **As-Built Bridge Load Rating** and be added to the final As-Built plans transmitted to the Final Estimates Office at the conclusion of the project.

If the EOR and Senior Project Engineer (consultant CEI projects) or Resident Engineer (In-house CEI projects) agree that the As-Bid load rating does not need to be changed because there were no significant modifications to the bridge during construction then the EOR is required to submit a letter affirming this and must be signed and sealed and sent to the Senior Project Engineer/Resident Engineer with a copy to the DSME. The letter should indicate the source of information, as explained below, on which the EOR's opinion is based. The letter must be stored in the Electronic Document Management System (EDMS) by the CEI and included in the documents transmitted to the Final Estimates Office at the conclusion of the project. The EOR's basis that the As-Bid load rating is not in need of revision will be based on the final As-Built plans that are signed and sealed by the Senior Project Engineer/Resident Engineer. If final As-Built plans are not available prior to the in-service date of the bridge then the Senior Project Engineer/Resident Engineer must submit a signed and sealed letter to the EOR stating that the Senior Project Engineer/Resident

Engineer has notified the EOR as the project has progressed of all changes to the bridge during construction which could impact the final load rating. In lieu of this statement, the letter may contain an attachment with preliminary As-Built plans showing all changes that could impact the final bridge load rating and state which information source is provided.

10.11.5 Electronic Filing of Bridge Construction Documents

The DSMO utilizes several documents in EDMS. To facilitate access of these documents, bridge construction document profiles must be attributed according to the table below. The following structure number types and format must be entered into the document profile for these records as indicated:

Bridge Number: 6 digits, all numbers, and if more than one bridge is represented by the document then each bridge number must be separated by a comma.

Overhead Sign Structure Number: 6 digits, 5 of which are numbers, and the third digit from the left, which with rare exception, is the letter S for "Sign"

Traffic Signal Mast Arm Structure Number: same as Overhead Sign except the alphabetic character is M for "Mast"

High Mast Light Pole Number: same as Overhead Sign except the alphabetic character is P for "pole"

If there is uncertainty about the structure's number, consult the DSMO for guidance.

BRIDGE CONSTRUCTION DOCUMENT PROFILE FIELDS			
DSMO Document Category	Construction Document Type	EDMS Group/ Type No.	EDMS Document Subject/Description
As-Built Load Rating Documents	Supporting Calculations, Input Files, Output Files, Load Rating Summary Sheets, EOR Letter stating As-Built Load Rating same as As-Bid Load Rating	15/141	As-Built Load Rating
Foundation Documents	Pile Driving Records	15/139	Pile Installation
	Drilled Shaft Records		Drilled Shaft Installation
	Geotechnical Reports & Related Docs.		General Geotechnical
Defect/Damage Records and Documents	Crack Maps, Crack Dimension Tables, Crack Growth Monitoring Logs	15/141	Crack Monitoring
	Request For Correction (RFC) Tracking Logs and Related Correspondence		Defect/Damage Resolution
Shop Drawings	Bridge Bearings	14/134	Bearings
	Electrical Components	14/134	Electrical
	Expansion Joints	14/134	Expansion Joints
	Mechanical Components	14/134	Mechanical
	Substructure Members/Components	14/134	Substructure
	Superstructure Members/Components	14/134	Superstructure
	High Mast Light Components	14/135	High Mast Lighting
	Miscellaneous	14/136	Miscellaneous
Overhead Sign/Traffic Signal Structure Members/Components		14/138	Overhead Sign/Traffic Signal Structure
Punch List Documents	Final Punch List, Explanation of how Punch List Items were Resolved	15/141	Punch List
Post-Tensioned (PT) Bridge Records	Stressing Record/Log, Grouting Record/Log, Casting Record/Log	15/141	PT Bridge Record

10.11.6 Contractor Applied Overloads on Department-Owned Temporary Bridges

The intent of **Standard Specification 7-7.2**, in part, is to prevent the overloading of Department-owned temporary bridge components that might be damaged by such loads. These temporary bridge components are generally designed to carry loads that do not exceed those allowed in the **Florida Highway Patrol, Commercial Motor Vehicle Manual (CMVM)** and; therefore, are not designed to carry overloaded construction vehicles or construction cranes along with the objects they are lifting. Overloading of temporary bridge components can cause serious damage or failure.

Exceptions to the overload policy above are permitted if provided for by the Engineer of Record in the **Contract Documents**. The decision to allow erection overloads will be made prior to bid and will not be permitted through the use of a Cost Savings Initiative Proposal after bid. If overloads are permitted in the **Contract Documents**, then cranes and other heavy loads may only be applied for the purpose of erecting the temporary bridge. Temporary bridges may not be used for the purpose of constructing the permanent bridge.

If the **Contract Documents** allow it, and the Contractor wishes to apply overloads to the temporary bridge for the purpose of erecting the temporary bridge, then prior to the start of work the Contractor must submit shop drawings to the Florida Department of Transportation for approval, the contents of which will be specified in the **Contract Documents**. Typically, the shop drawings must include calculations, layout drawings, and erection drawings showing how the equipment is to be used so that the temporary bridge structure will not be overloaded. The Contractor's Engineer of Record must sign and seal the shop drawings. The PA will verify that the submittal package is in full compliance with the plans prior to submitting them to the State Structures Maintenance Office for review and approval.

If the shop drawings are approved then the PA must confirm that the magnitude of the applied overloads (cranes, construction vehicles, etc.) which may require the use of distribution mats and their specific loading positions on the deck of the temporary bridge, are in full compliance with the shop drawings at all times during the progression of construction.

When the plans do not specifically allow the temporary bridge to be overloaded for erection purposes then the Contractor must comply fully with the CMVM and the PA must monitor the Contractor's compliance for the duration of the project.

10.11.7 Temporary Bridge Activities

10.11.7.1 Acquisition of Department-Owned Temporary Bridging

The acquisition of Department-owned temporary bridge components and hardware will be overseen by the PA using the process outlined in ***Standard Specification 102-6.2***. Upon receipt of the Contractor's letter and accompanying requested components list, confer with the State Aluminum Structures Shop (SASS) as necessary to finalize the components list within the timeframe given in ***Standard Specification 102-6.2***. Provide at least one inspector to attend the mandatory training described in ***Standard Specification 102-6.2*** along with the Contractor's representatives.

10.11.7.2 Erection Verification

During the erection of temporary bridging, periodically verify that proper erection procedures are being followed by the Contractor. When temporary bridge components are supplied by the Department, the CEI will consult with the FDOT State Bridge Maintenance and Repair Engineer (SBMRE) of the State Structures Maintenance Office, for instruction regarding how verification is to be performed. Erection procedure violations by the Contractor must be brought to the attention of the SBMRE immediately and the SBMRE will make recommendations about corrective actions required of the Contractor. The PA must verify that recommended actions are implemented properly and in a timely manner. When the entire temporary bridge is supplied by the Contractor, the CEI must verify that the Contractor is constructing the temporary bridge in accordance with the signed and sealed shop drawings and erection plan. If the Contractor does not construct in accordance with the shop drawings and erection plan, the PA will bring this to the attention of the Contractor and any required corrective actions are required to be completed prior to use of the bridge by the public.

The State Structures Maintenance Office will perform a courtesy inspection of Department-owned temporary bridges prior to their use by public traffic. The Project Administrator will notify the SBMRE at least 30 days in advance of opening to traffic to schedule the required inspection. The PA will coordinate with the Contractor to facilitate inspection of the bridge. Completion of corrective actions will be verified by the PA prior to opening any temporary bridge to the public.

10.11.7.3 Maintenance Monitoring

For Department-owned temporary bridges, CEI staff will monitor that the Contractor properly maintains the temporary bridge components once in service. CEI staff will consult with the SBMRE for instructions regarding what procedures to use for proper maintenance monitoring. Maintenance lapses by the Contractor must be brought to the attention of the SBMRE immediately and the SBMRE will make recommendations about corrective actions required of the Contractor. The PA will verify that recommended actions are implemented properly and in a timely manner. For Contractor supplied temporary bridges, the PA will verify that there is a Contractor-developed temporary bridge maintenance plan and that the Contractor is in compliance with the plan. The PA will discuss any maintenance plan noncompliance issues with the Contractor and corrective actions must be implemented in a timely manner.

10.11.7.4 Return of Department-Owned Temporary Bridging

The PA will verify that the Contractor has notified the Department at least 10 days prior to return of any bridge components and that all bridge components are listed on the Detour Bridge Issue and Credit Ticket and signed by the Contractor. Adjustments to payments due to the Contractor for bridge components that are missing or damaged by the Contractor, components that are not properly packed or for components that are not returned within the specified time will be made in accordance with ***Standard Specification 102-6.2***.

Section 10.12

FOUNDATIONS ON DESIGN-BUILD PROJECTS

10.12.1 Purpose

To establish a procedure for observing, reviewing, and accepting foundations installed by a Design Build Firm.

10.12.2 Authority

Sections 20.23(3)(a), and 334.048(3), Florida Statutes (F.S.)

10.12.3 References

Section 455, Standard Specifications for Road and Bridge Construction and Supplements thereto.

10.12.4 Scope

The principal users of this document include the State Construction Office District Materials and Research Offices (DMRO), District Construction Offices (DCO), District Operations Centers, the State Materials Office (SMO), and Construction Engineering and Inspection (CEI) firms working for the Department.

10.12.5 Definitions

District Construction Engineer (DCE): The authority on the entire construction activity in the District.

Construction Engineering and Inspection (CEI): In this procedure, it refers to the Consultant personnel performing CEI services or the Department personnel group performing CEI services.

Geotechnical Engineer: The Engineer engaged by the Department to review all foundation construction documents submitted by the Design-Build (DB) Firm and provide recommendations to the CEI on foundation issues. In this procedure, the

Geotechnical Engineer may be the District Geotechnical Engineer (DGE), any Department Engineer assigned for the project by the DGE, the Consultant Geotechnical Engineer working directly for the District Geotechnical Engineer, or the Geotechnical Engineer employed by the Department's Consultant CEI and performing under the direction of the DCE and the DGE. If the Geotechnical Engineer is engaged by the Consultant CEI, the District Level Responsibilities in this procedure will also be the Resident Level Responsibilities. The CEI Geotechnical Engineer shall coordinate with the DGE in performing his/her responsibilities.

Verification Testing Geotechnical Engineer (VTGE): The Engineer engaged by the Department to perform verification testing. Verification testing could be dynamic testing and integrity testing. It could be the same geotechnical firm working for the CEI, DGE, in-house Department personnel from the DGE, or a consultant working directly for the DGE.

Project Administrator (PA): The Administrator responsible for the everyday construction activity at the project under the direction of the Resident Engineer.

Resident Engineer (RE): The Engineer supervising the CEI and responsible for the construction activities in the residency. In this procedure, this could be the Senior Project Engineer responsible for the construction activities of the project.

10.12.6 Piles

10.12.6.1 General

The DB Firm is responsible for the determination of pile lengths and driving criteria, and inspecting and recording the pile installation using the proper FDOT forms. The CEI must perform a review and verification of the work performed by the DB Firm.

It will be the responsibility of the CEI to plan and coordinate with the DGE and other parties involved to make sure the deadlines specified in the contract documents are met, including reviewing, rejecting or accepting submittals, performing verification tests, and providing results to the DB Firm.

10.12.6.2 Acceptance of the Pile Installation Plan

(A) Resident Level Responsibilities

The RE (or PA) shall receive from the Contractor at the preconstruction conference or at least fifteen (15) days prior to driving the initial test pile a completed **Pile Installation Plan (PIP)**.

Within one (1) working day after receiving the PIP from the DB Firm, the RE (or PA) shall forward the document to the DGE and the Geotechnical Engineer for review and comments. The CEI shall perform a concurrent separate review of the PIP. For a revised PIP, the RE (or PA) shall forward the document to the DGE and the Geotechnical Engineer within the same day of receiving it.

Within one (1) working day of receipt of the Geotechnical Engineer's comments, the RE (or PA) shall incorporate the CEI's comments and notify the Contractor of the acceptance or rejection and request additional information and/or changes that may be necessary to satisfy the Contract Documents. The letter of rejection shall contain the comments and reasons for rejection of the PIP. For a revised PIP, provide similar notification to the Contractor within one (1) working day after receipt of the Geotechnical Engineer's comments. The RE (or PA) must ensure that the deadlines allowed by the Specifications are met.

(B) District Materials and Research Office (DMRO) Level Responsibilities

The Geotechnical Engineer shall make comments and/or recommendations to the RE (or PA) for the acceptance or rejection of the PIP within three (3) working days of receiving it. For a revised PIP, the Geotechnical Engineer shall make comments and/or recommendations within one (1) working day of receiving the PIP.

10.12.6.3. Test Pile and Production Pile Installation

(A) Resident Level Responsibilities

The CEI must perform an over-the-shoulder inspection of the activities performed by the DB Firm during pile testing and production pile driving and ensure that the DB Firm is following FDOT procedures and documenting the installation using the proper FDOT forms. As soon as the Contractor's schedule for driving test piles is known, the RE (or

PA) shall notify the DGE and the Geotechnical Engineer of the schedule so that they have the opportunity to observe the installation of the test piles.

The CEI must ensure the requirements in the Released for Construction (RFC) Plans, Specifications, accepted PIP, and other contract documents are followed throughout the installation of the test and production piles. In addition, the CEI personnel must observe over-the-shoulder and verify the driving criteria are followed during the installation of production piles.

The DB Firm is required to submit pile driving records within one (1) working day of driving piles. The CEI must forward this information to the DGE and the Geotechnical Engineer within one (1) working day.

(B) District Level Responsibilities

Since the deadline to review Foundation Certification Packages is only one (1) working day, the DGE and the Geotechnical Engineer should start reviewing the production pile driving records as soon as possible prior to receiving the Foundation Certification Packages.

10.12.6.4 Production Pile Lengths and Driving Criteria

Production pile lengths and driving criteria are established by the DB Firm utilizing the results of the test pile program and contract documents. Production lengths and driving criteria must be submitted by the DB Firm at least two (2) working days prior to the beginning of the production pile driving. The CEI is not required to submit a formal acceptance document on these submittals. However, if there are issues in the proposed lengths or driving criteria that are in conflict with the RFC Plans, accepted PIP, Specifications or other contract documents that may affect the integrity of the foundation, the RE (or PA) shall notify the DB firm upon receiving comments from the Geotechnical Engineer.

(A) Resident Level Responsibilities

Upon receipt of the production pile length and driving criteria letters from the DB Firm, the RE (or PA) shall forward the package to the DGE and the Geotechnical Engineer within one (1) working day. If comments are received from the Geotechnical Engineer (see item B below), forward them immediately to the DB Firm and request them to be addressed prior to driving piles.

(B) DMRO Level Responsibilities

Within one (1) working day of receiving the production pile length and driving criteria letters the Geotechnical Engineer shall perform a cursory review to check for problems in the letters such as whether the DB Firm used the correct nominal bearing resistance, that the lengths are determined based on dynamic test results and geotechnical conditions, that the blow count criteria were developed from analyses performed at the correct elevations, and whether there are stroke limitations in the letter to prevent pile overstress. Submit any concerns or comments to the RE (or PA).

10.12.6.5 Foundation Certification Packages

After completion of the piles driven in one foundation unit, the RE (or PA) will receive from the DB Firm a Foundation Certification Package.

(A) Resident Level Responsibilities

Upon receipt of the Foundation Certification Package from the DB Firm, the RE (or PA) shall forward the package to the DGE and the Geotechnical Engineer within the same working day and perform a concurrent review to verify that the package is complete. After the reviews are performed, the RE (or PA) shall notify the Contractor of the rejection or need for verification of the foundation unit within the same working day of receiving the notification from the Geotechnical Engineer.

(B) DMRO Level Responsibilities

The Geotechnical Engineer shall perform a review of the Foundation Certification Package to make sure it addresses all the requirements for acceptance (such as load capacity, integrity, settlements). Also, the Geotechnical Engineer shall verify that the language of the signed and sealed certification clearly certifies the foundation unit without disclaimers. Refer to **Guidance Documents 10-12-A**, for an **Example of Acceptable Language in Certification Letters**. The Geotechnical Engineer shall perform additional analyses to verify the accuracy of the driving criteria prior to receiving the packages. These analyses shall commence at the time the DB team submits the pile length and driving criteria letters. A careful review of the driving logs shall be performed to determine whether there is a need to perform verification testing.

Within one (1) working day of the receipt of the Foundation Certification Package, the Geotechnical Engineer shall submit a notification to the RE (or PA) recommending one of the following actions:

- Rejection of the Foundation Certification Package indicating the reasons for its rejection.
- Requesting a verification test and the verification test location.

If the Geotechnical Engineer has no comments on the foundation package, no notification is required.

10.12.6.6 Verification Testing and Acceptance

(A) Resident Level Responsibilities

If verification testing is required by the Geotechnical Engineer, the RE (or PA) shall request the DB firm perform a verification test on the pile selected by the Geotechnical Engineer. Once the Contractor indicates when the verification set-check test will be performed, the RE (or PA) shall schedule the VTGE to instrument the pile selected for verification.

After receiving a notification from the Geotechnical Engineer indicating that the verification testing is complete and no further action is required (see item (B) below), the RE (or PA) shall immediately forward the results of the verification testing to the DB Firm and notify it that no further action is required. If the Geotechnical Engineer finds the tested pile unacceptable, the RE (or PA) shall immediately notify the DB Firm, provide the DB Firm with the verification test results and request the DB Firm to follow the corrective procedures specified in the Specifications and other contract documents.

(B) DMRO Level Responsibilities

Within one (1) working day of testing, the Geotechnical Engineer shall provide the results of the verification testing to the RE (or PA). If the results are acceptable, the Geotechnical Engineer shall issue a notification to the RE (or PA) indicating that the verification testing is complete and no further action is required. If the verification test results are unacceptable, the Geotechnical Engineer shall issue a notification to the RE (or PA) recommending rejection of the foundation, provide the verification test results, and request the DB Firm to follow the corrective procedures specified in the Specifications and other contract documents.

10.12.7 Drilled Shafts

10.12.7.1 General

The DB Firm is responsible for the determination of drilled shaft lengths; tip elevations and rock socket lengths; inspection; and recording the drilled shaft installation using the proper FDOT forms. The CEI must perform a review and verification of the work performed by the DB Firm.

It will be the responsibility of the CEI to plan and coordinate with the DGE and other parties involved in this procedure to make sure the deadlines specified in the contract documents are met; including reviewing, rejecting or accepting submittals, performing verification tests, and providing results to the DB Firm.

10.12.7.2 Acceptance of the Drilled Shaft Installation Plan

(A) Resident Level Responsibilities

The RE (or PA) shall receive from the Contractor at the preconstruction conference or at least fifteen (15) days prior to installing the first shaft in the project a completed **Drilled Shaft Installation Plan (DSIP)**.

Within one (1) working day after receiving the DSIP from the DB Firm, the RE (or PA) shall forward the document to the DGE and the Geotechnical Engineer for review and recommendations. The RE (or PA) shall perform a concurrent separate review of the DSIP. For a revised DSIP, the RE (or PA) shall forward the document to the DGE and the Geotechnical Engineer within the same day of receiving it.

Within one (1) working day of receipt of the Geotechnical Engineer's comments, the RE (or PA) shall incorporate the CEI's comments and notify the Contractor of the acceptance or rejection and request additional information and/or changes that may be necessary. The letter of rejection shall contain the comments and reasons for rejection of the DSIP. For a revised DSIP, the RE (or PA) shall provide similar notification to the Contractor within the one (1) working day from receipt of the Geotechnical Engineer's comments. The RE (or PA) must ensure that the deadlines allowed by the Specifications are met.

(B) DMRO Level Responsibilities

The Geotechnical Engineer shall make comments and/or recommendations to the RE (or PA) of the acceptance or rejection of the DSIP within three (3) working days of receiving it. For a revised DSIP, the Geotechnical Engineer shall make comments and/or recommendations within one (1) working day of receiving the DSIP.

10.12.7.3 Test Shafts and Production Drilled Shafts Installation

(A) Resident Level Responsibilities

The CEI must perform an over-the-shoulder inspection of the activities performed by the DB Firm during installation of test shafts (test holes and load test shafts) and production drilled shafts and ensure that the DB Firm is following FDOT procedures and documenting the installation using the proper FDOT forms. As soon as the Contractor's schedule to construct the test holes and load test shafts is known, the RE (or PA) shall notify the DGE and the Geotechnical Engineer of the schedule so that they have the opportunity of observing the installation of the test shafts.

The CEI must ensure that the requirements in the RFC Plans, Specifications, approved DSIP, and other contract documents are followed throughout the installation of the test and production shafts. In addition, the CEI must observe over-the-shoulder and verify that the DB team is properly recording the drilled shaft construction.

The DB Firm is required to submit drilled shaft logs within 24 hours after concrete placement. The CEI must forward this information to the DGE and the Geotechnical Engineer within the same day. The Geotechnical Engineer may select a shaft for integrity testing after reviewing the drilled shaft logs. The RE (or PA) shall notify the DB Firm of any required integrity testing within one (1) working day of receiving this request from the Geotechnical Engineer, making sure the deadline allowed by the Specifications is met.

(B) DMRO Level Responsibilities

The Geotechnical Engineer shall review the production drilled shaft logs, determine if there are any potential quality problems, and decide if integrity testing is required. The Geotechnical Engineer shall submit the request to the RE (or PA) for integrity testing within one (1) working day after receiving the drilled shaft logs.

10.12.7.4 Pilot Holes, Production Drilled Shaft Tip Elevations and Minimum Rock Socket Lengths

Design production drilled shaft tip elevations, minimum rock socket lengths, and other criteria are established by the DB Firm utilizing the results of the geotechnical exploration, pilot holes, lab testing, and load testing results. Performance of pilot holes shall be witnessed by qualified geotechnical personnel supervised by the Geotechnical Engineer. The final design drilled shaft tip elevations and rock socket information may be presented in the RFC plans or may be submitted in a document package prepared by the DB Firm after the pilot holes and load tests are completed. The RE (or PA) shall forward this information to the DGE and the Geotechnical Engineer the same day this package is received.

(A) Resident Level Responsibilities

As soon as the Contractor's schedule to perform the pilot holes is known, the RE (or PA) shall notify the DGE and the Geotechnical Engineer of the pilot hole schedule so that the Geotechnical Engineer may schedule his/her personnel to witness the pilot hole operation.

The RE (or PA) shall forward the final design drilled shaft elevations and rock socket lengths package to the DGE and the Geotechnical Engineer within one (1) working day for review. Upon receiving the comments from the Geotechnical Engineer, the RE (or PA) shall forward them to the DB Firm on the same day.

(B) DMRO Level Responsibilities

The Geotechnical Engineer shall perform a review of the load test results, pilot hole, lab test information, calculations, and final drilled shaft tip elevations recommendations submitted by the DB Firm. Within three (3) working days after receiving the information, the Geotechnical Engineer shall make recommendations to the RE (or PA) of the acceptance or rejection of the proposed drilled shaft tip elevations. The letter of rejection shall contain the comments and reasons for rejection.

10.12.7.5 Foundation Certification Packages

After completion of the drilled shafts in one foundation unit, the RE (or PE) will receive from the DB Firm a Foundation Certification Package.

(A) Resident Level Responsibilities

The same day of the receipt of the Foundation Certification Package from the DB Firm, the RE (or PA) shall forward the package to the DGE and the Geotechnical Engineer. Perform a concurrent review to verify that the Foundation Certification Package is complete. After the reviews are performed, the RE (or PA) shall notify the Contractor of the rejection or need for verification of the foundation unit within the same working day of receiving the notification from the Geotechnical Engineer.

(B) DMRO Level Responsibilities

The Geotechnical Engineer shall review the Foundation Certification Package to make sure it addresses all the requirements needed for acceptance (such as load capacity, integrity, and settlements). Also, the Geotechnical Engineer must verify that the language of the signed and sealed certification clearly certifies the foundation unit without disclaimers. Refer to ***Guidance Documents 10-12-A***, for an ***Example of Minimum Language in Certification Letters***.

Within one (1) working day of the receipt of the Foundation Certification Package, the Geotechnical Engineer shall submit a notification to the RE (or PA) recommending one of the following actions:

- Rejection of the Foundation Certification Package indicating the reasons for its rejection.
- Requesting verification tests and the verification test locations.

If the Geotechnical Engineer has no comments on the foundation package, no notification is required.

10.12.7.6 Verification Testing

(A) Resident Level Responsibilities

If verification is required by the Geotechnical Engineer, the RE (or PA) shall coordinate with the VTGE. The results of the verification test shall be submitted to the DGE and the Geotechnical Engineer within two (2) working days after performing the test. After receiving a notification from the Geotechnical Engineer indicating that the verification testing is complete and no further action is required (see item (B) below), the RE (or PA) shall immediately forward the results of the verification testing to the DB Firm and notify

it that no further action is required. If the Geotechnical Engineer finds any tested shaft unacceptable, the RE (or PA) shall immediately notify the DB Firm, provide the DB Firm with the verification test results, and request the DB Firm to address any deficient drilled shaft in accordance with the Specifications and other contract documents and submit a solution to the Department for review.

(B) DMRO Level Responsibilities

After receipt of the verification test results from the RE (or PA), the Geotechnical Engineer shall review the results, determine the acceptability of the shaft or identify additional needs for verification testing, and provide recommendations to the RE (or PA) within two (2) working days.

If the verification testing is performed by the DGE (or a consultant working directly for the DGE), the Geotechnical Engineer shall coordinate with the DGE and shall submit the test results and recommendations to the RE (or PA) within two (2) working days of completing the test in the field.

If the results are acceptable, the Geotechnical Engineer shall issue a notification to the RE (or PA) indicating that the verification testing is complete and no further action is required. If the verification test results are unacceptable, the Geotechnical Engineer shall issue a notification to the RE (or PA) recommending rejection of the foundation, provide the verification test results, and request the DB Firm follow the corrective procedures specified in the Specifications and other contract documents.

10.12.8 Auger Cast Piles

10.12.8.1 General

The Design-Build (DB) Firm is responsible for the determination of auger cast pile lengths and inspecting and recording the pile installation using the proper FDOT forms. The CEI must perform a review and verification of the work performed by the DB Firm. Note that when the Department approves the use of ACP for bridges in the project, the DB team must prepare and submit a Modified Special Provision (MSP) for the Department's review and acceptance, to specify the requirements of the ACP installation.

10.12.8.2 Acceptance of the Auger Cast Pile Installation Plan

(A) Resident Level Responsibilities

The RE (or PA) shall receive from the Contractor at the preconstruction conference or at least fifteen (15) days prior to the installation of the demonstration pile a completed **Auger Cast Pile Installation Plan (ACPIP)**.

Within one (1) working day after receiving the ACPIP from the DB Firm, the RE (or PA) shall forward the document to the DGE and the Geotechnical Engineer for review and recommendations. The CEI shall perform a concurrent separate review of the ACPIP. For a revised ACPIP, the RE (or PA) shall forward the document to the DGE and the Geotechnical Engineer within the same day of receiving it. When the Department approves using ACP for bridges in the project, separate ACPIPs must be submitted by the DB team to address the installation of non-bridge ACP and to address the installation of bridge foundations.

Within one (1) working day of receipt of the Geotechnical Engineer's comments, the RE (or PA) shall incorporate the CEI's comments, notify the Contractor of the acceptance or rejection, and request additional information and/or changes that may be necessary. The letter of rejection shall contain the comments and reasons for rejection of the ACPIP. For a revised ACPIP, the RE (or PA) shall provide similar notification to the Contractor within one (1) working day after receipt of the Geotechnical Engineer's comments. The RE (or PA) must ensure that the deadlines allowed by the Specifications are met.

(B) DMRO Level Responsibilities

The Geotechnical Engineer shall make comments and/or recommendations to the RE (or PA) of the acceptance or rejection of the ACPIP within three (3) working days of receiving it. For a revised ACPIP, the Geotechnical Engineer shall make comments and/or recommendations within one (1) working day of receiving the ACPIP.

10.12.8.3. Demonstration Pile, Load Test Piles and Production Piles Installation

(A) Resident Level Responsibilities

The CEI shall perform an over-the-shoulder inspection of the activities performed by the DB Firm during installation of demonstration auger cast piles, load test auger cast piles and production auger cast piles and ensure that the DB Firm is following FDOT procedures and documenting the installation using the proper FDOT forms. As soon as the Contractor's schedule to construct the demonstration piles and load test piles is known, the RE (or PA) shall notify the DGE and the Geotechnical Engineer of the schedule so that they have the opportunity of observing the installation of these piles. During the installation of demonstration auger cast piles, load test auger cast piles and production auger cast piles ensure the DB team furnish the Automated Monitoring Equipment (AME), if required by the Specifications and submits the inspection installation records to the Geotechnical Engineer within 24 hours of the demonstration pile and load test pile installation. In addition, for bridge foundations, ensure the production logs are submitted within 24 hours.

The CEI must ensure the requirements in the RFC Plans, Specifications, accepted ACPIP, and other contract documents are followed throughout the installation of the demonstration, load test and production piles. In addition, the CEI must observe over-the-shoulder and verify that the required auger cast pile tip elevations and other design requirements established by the DB firm are followed during the installation of the demonstration pile and production piles.

(B) DMRO Level Responsibilities

The Geotechnical Engineer shall provide technical assistance as required by the CEI in resolving auger cast pile installation issues that may arise during construction. This assistance includes the observation of the demonstration piles, load test piles, field visits, reviewing Engineering Analysis Reports on piles that did not meet the Specifications requirements, and review of the Foundation Certification Packages.

10.12.8.4 ACP for Bridges- Pilot Holes, Production ACP Tip Elevations and Minimum Rock Socket Lengths

Design production ACP tip elevations, minimum rock socket lengths, and other criteria are established by the DB Firm utilizing the results of the geotechnical exploration, pilot holes, lab testing, and load testing results. Performance of pilot holes shall be witnessed by qualified geotechnical personnel supervised by the Geotechnical Engineer. The final design ACP tip elevations and rock socket information may be presented in the RFC plans or may be submitted in a document package prepared by the DB Firm after the pilot holes and load tests are completed. The RE (or PA) shall forward this information to the DGE and the Geotechnical Engineer the same day this package is received.

(A) Resident Level Responsibilities

As soon as the Contractor's schedule to perform the pilot holes is known, the RE (or PA) shall notify the DGE and the Geotechnical Engineer of the pilot hole schedule so that the Geotechnical Engineer may schedule his/her personnel to witness the pilot hole operation.

The RE (or PA) shall forward the final design ACP tip elevations and rock socket lengths package to the DGE and the Geotechnical Engineer within the same day is received for review. Upon receiving the comments from the Geotechnical Engineer, the RE (or PA) shall forward them to the DB Firm on the same day.

(B) DMRO Level Responsibilities

The Geotechnical Engineer shall perform a review of the load test results, pilot hole, lab test information, calculations, and final ACP tip elevations recommendations submitted by the DB Firm. Within three (3) working days after receiving the information, the Geotechnical Engineer shall make recommendations to the RE (or PA) of the acceptance or rejection of the proposed ACP tip elevations. The letter of rejection shall contain the comments and reasons for rejection.

10.12.8.5 Foundation Certification Packages

After completion of the auger cast piles in one foundation unit, the RE (or PA) will receive from the DB Firm a Certification Package. For bridges, a foundation unit is defined as a group of piles in a pier or bent that share a common cap. For noise walls, a

foundation unit is defined as a group of piles per wall segment or per full wall. For other miscellaneous structures, the contractor will submit a certification package per structure.

(A) Resident Level Responsibilities

Upon receipt of the Foundation Certification Package from the DB Firm, the RE (or PA) shall forward it to the DGE and the Geotechnical Engineer within the same working day and perform a concurrent review to verify that the package is complete. If after the reviews, verification testing is needed or the foundation package is considered deficient, the RE (or PA) shall notify the Contractor of the rejection of the foundation or the need for verification testing, within the same working day of receiving the notification from the Geotechnical Engineer.

(B) DMRO Level Responsibilities

The Geotechnical Engineer shall perform a review of the Foundation Certification Package to make sure it addresses all the requirements needed for acceptance (such as load capacity, integrity, and settlements). Also, the Geotechnical Engineer must verify that the language of the signed and sealed certification clearly certifies the foundation unit without disclaimers. Refer to ***Guidance Documents 10-12-A***, for an ***Example of Acceptable Language in Certification Letters***.

Within three (3) working days of the receipt of the Foundation Certification Package, the Geotechnical Engineer shall submit a notification to the RE (or PA) recommending one of the following actions:

- Rejection of the Foundation Certification Package indicating the reasons for its rejection.
- Requesting verification tests and the verification test locations.

10.12.8.6 Verification Testing

In bridges, the Department may require verification load tests on selected ACP to confirm load capacity. The RE (or PA) shall coordinate with the DB Team to perform the selected verification tests. The verification load test reports shall be submitted to the DGE and the Geotechnical Engineer as soon as they are received from the Contractor. After receiving a notification from the Geotechnical Engineer indicating that the verification testing is complete and no further action is required (see item (B) below), the RE (or PA) shall immediately forward the results of the verification testing to the DB

Firm and notify it that no further action is required. If the Geotechnical Engineer finds any tested ACP unacceptable, the RE (or PA) shall immediately notify the DB Firm and request the DB Firm to address any deficient ACP in accordance with the Specifications and other contract documents and submit a solution to the Department for review.

(A) Resident Level Responsibilities

If integrity verification is required by the Geotechnical Engineer, the RE (or PA) shall coordinate with the VTGE. The test shall be performed within one (1) working day after the DB Firm has been notified on the need of verification testing. The results of the verification test shall be submitted to the DGE and the Geotechnical Engineer within two (2) working days after performing the test.

When the Geotechnical Engineer selects piles for verification load testing, the RE (or PA) shall coordinate with the DB Team to perform the selected verification tests. The verification load test results shall be submitted to the DGE and the Geotechnical Engineer as soon as they are received from the DB team.

Once the Geotechnical Engineer finishes the review of the verification load tests and any integrity verification tests, the RE (or PA) shall notify immediately the DB team whether the foundation is unacceptable and that corrective procedures in accordance with the Specifications or the Contract Documents must be performed, or that no further action is required.

(B) DMRO Level Responsibilities

After receipt of the integrity verification test results from the RE (or PA), the Geotechnical Engineer shall review the results, determine the acceptability of the shaft or identify additional needs for verification testing, and provide recommendations to the RE (or PA) within three (3) working days.

If the integrity verification testing is performed by the DGE (or a consultant working directly for the DGE), the Geotechnical Engineer shall coordinate with the DGE and shall submit the test results and recommendations to the RE (or PA) within three (3) working days of completing the test in the field.

When verification load tests are performed, if the verification load results are acceptable the Geotechnical Engineer shall issue a notification to the RE (or PA) indicating that the verification testing is complete, and no further action is required. If the verification load or integrity verification test results are unacceptable, the Geotechnical Engineer shall

issue a notification to the RE (or PA) recommending rejection of the foundation and request the DB Firm follow the corrective procedures specified in the Specifications and other contract documents. The recommendation shall also include whether additional verification load testing is required.

10.12.9 Spread Footings

10.12.9.1 General

The Design-Build (DB) Firm is responsible for the determination of spread footing design, inspection and recording the footing construction. CEI must perform a review and verification of the work performed by the DB Firm.

10.12.9.2 Spread Footing Construction

(A) Resident Level Responsibilities

The CEI must perform an over-the-shoulder inspection of the activities performed by the DB Firm during spread footing construction to ensure the DB Firm is following FDOT procedures and meets the requirements indicated in the RFC Plans, Specifications, and other pertinent contract documents. The CEI must observe and verify that the required foundation depths, dewatering, excavations, support of excavations, foundation subgrade materials, foundation materials and details, and foundation seals are in accordance with the design requirements established by the RFC Plans and Specifications.

(B) DMRO Level Responsibilities

The Geotechnical Engineer shall provide technical assistance as required by the CEI in geotechnical construction issues that may arise during construction. This assistance includes field visits, records review, reviewing Engineering Analysis Reports on questionable footings, field testing, and technical recommendations.

10.12.9.3 Foundation Certification Packages

After completion of the spread footings in one foundation unit, the RE (or PA) will receive from the DB Firm a Foundation Certification Package. A foundation unit is defined as a spread footing.

(A) Resident Level Responsibilities

Upon receipt of the Foundation Certification Package from the DB Firm, the RE (or PA) shall forward it to the DGE and the Geotechnical Engineer within the same working day and perform a concurrent review to verify the package is complete. If after the reviews, the foundation package is considered deficient, the RE (or PA) shall notify the Contractor of the rejection of the foundation within the same working day of receiving the notification from the Geotechnical Engineer.

(B) DMRO Level Responsibilities

The Geotechnical Engineer shall perform a review of the Foundation Certification Package to make sure it addresses all the requirements needed for acceptance (such as load capacity, integrity, and settlements). Also, the Geotechnical Engineer must verify that the language used in the signed and sealed certification letter clearly certifies the foundation unit without disclaimers Refer to ***Guidance Documents 10-12-A***, for an ***Example of Acceptable Language in Certification Letters***.

Within one (1) working day of the receipt of the Foundation Certification Package, if the certification is not acceptable, the Geotechnical Engineer shall submit a notification to the RE (or PA) recommending its rejection, including the reasons for rejecting it. If the Geotechnical Engineer has no comments on the Foundation Certification Package, no notification is required.

10.12.10 Training

All personnel performing inspections or oversight of foundation installations must hold the Construction Training Qualification Program (CTQP) for the type of foundation being installed, Pile Driving Inspector, Drilled Shaft Inspector or Auger Cast Pile Inspector. For Auger Cast Piles for non-bridge installation inspection, either holding a CTQP for Auger Cast Piles or having passed the CBT class is required. There are no training requirements for Spread Footing Construction.

10.12.11 Forms

The following forms are available from the Policy & Process Management Forms Library at [Procedural Document Library \(fdot.gov\)](https://fdot.gov/procedural-document-library):

- 700-010-35 Pilot Hole Log
- 700-010-60 Pile Driving Log
- 700-010-84 Drilled Shaft for Miscellaneous Structures Forms Workbook
- 700-010-85 Drilled Shaft for Major Structures Forms Workbook
- 700-011-03 Auger Cast-in-Place Installation Record
- 700-020-01 Pile Driving Installation Plan Form

Guidance Document 10-12-A

Example of Acceptable Language in Certification Letters

(ADDRESSEE)

(DATE)

Financial Project ID:

FAP No.:

Contract No.:

County:

Subject: Foundation Certification Letter for Pier/Bent/structure
Project Name, Bridge/structure identification, Bridge #

Dear (_____):

Consultant Firm's Name has completed a review of the (list the documents that the consultant reviewed for this certification such as pile driving records/drilled shaft records/auger cast piles records, dynamic load test data, static, Statnamic, load test data, integrity test data, spread footing field inspection records, etc). All the production piles/shafts/auger cast piles (select one) were inspected by a CTQP certified pile driving/drilled shaft/auger cast pile (select one) inspector under our supervision and the final position and axial alignment were verified. (Note: in case of tolerances being exceeded, an evaluation must be included in the package).

Based on our review, we hereby certify that all these piles/drilled shafts/auger cast piles/spread footings meet the Design and Construction criteria established for this foundation which includes axial capacity including uplift, lateral stability, integrity, and foundation settlement.

Submitted by:

Firm's Name
FPBE CAT

Geotechnical Foundation Design Engineer of Record Name
FBPE license #

Section 11.1

ASPHALT LOT DOCUMENTATION

11.1.1 Purpose

This procedure establishes guidelines for asphalt LOT documentation related to the daily measurement and documentation of bituminous quantities.

11.1.2 Authority

Sections 20.23(3) (a) and 334.048(3), Florida Statutes (F.S.)

11.1.3 General

Specifications Section 320 includes the requirements for asphalt plant operations. All asphalt plants will have electronic weigh systems with automatic ticket printouts.

11.1.4 Asphalt LOT Submittal Package

The **LOT Submittal Package** consists of information provided by the Contractor's Plant and Roadway Technicians and/or the Department's Plant and Roadway Verification Technicians. It is compiled by Department personnel which could include the Plant and Roadway Verification Technicians and/or Resident Office. **LOT Submittal Packages** (see [Attachment 11-1.1](#)) will be assembled using a [PDF Package](#) and will be uploaded to the collaboration site. The Resident Office (RO) will ensure the PDF package is complete.

Each LOT is either 2,000 or 4,000 Tons and initial LOTs are always 2,000 Tons, per **Specifications Section 334-5.2**. The **LOT Submittal Packages** will be uploaded to the collaboration site when the LOT is paid and should include the following documentation:

(A) Asphalt Ticket Information

Paper or Electronic Ticketing (E-Ticketing) information will be submitted per **Specifications Section 320-3**. The ticket information will be available for review by the Plant Verification Technician one day after production and will become part of the **LOT Submittal Package**.

Note: Material of different types, pay items, waste, or private work for each day's production run will be identified on the **Quality Control Roadway Report (QCRR)**.

The following ticket information is required:

Required Information	e-Tickets	Printed Tickets
Sequential Load Number	✓	✓
Project Financial ID Number (FIN)	✓	✓
Date and *Time	✓	✓
Name and location of the plant	✓	✓
Mix Design Number	✓	✓
Place for recording mix temperature:		
By: Plant QC	✓	
By: Plant VT	✓	
By: Roadway QC	✓	
By: Roadway VT	✓	
By: Hand Recording		✓
Truck Number	✓	✓
Gross, Tare, and Net Tonnage	✓	✓
Daily cumulative tonnage of mix for the mix design	✓	✓

- (1) **Printed Tickets** - There must be an original and at least one (1) legible copy. The original is retained by the Plant Verification Technician and one copy goes to the Roadway Verification Technician. See [Attachment 11.1-2](#) for examples of printed asphalt tickets.

Tickets will be grouped by LOT in the daily order of production. The original weight tickets will be scanned into the **LOT Submittal Package** and the hard copies will be destroyed. It is also acceptable to receive scanned tickets from the Contractor. Scanned tickets must be checked and verified for accuracy and clarity by the RO before inclusion within the **Lot Submittal Package** and before destruction of tickets.

- (2) **Electronic Ticket Information** – After each truck is loaded, ticket information will be electronically recorded and uploaded to the e-ticketing software database. Each truckload’s ticket information will be provided to the users of the e-ticketing software database.

A comma separated value (.csv) file will be provided to the Roadway Verification Technician. The .csv file will be included in the **LOT Submittal Package**. It is not necessary to print tickets in the traditional format; the .csv file is sufficient. See [Attachment 11.1-2](#) for an example.

NOTE: Save a copy of the .csv file as an Excel (.xlsx) file prior to working in the report to have full Excel functionality. The .xlsx version can be included in the LOT package for additional information as needed.

(B) Asphalt Plant – Composite Pay Factor Sheet

The Contractor’s test results for each Sublot are entered into **Materials Acceptance and Certification (MAC)** at the asphalt plant. The gradation, asphalt content, air voids, and density together generate the **Composite Pay Factor (CPF) Sheet** for the LOT.

The **CPF Sheet** is generated in MAC and is part of the **Comparison Package Information Report** which also contains the LOT verification information. See [Attachment 11.1-3](#). The **CPF Sheet** is required for all **Lot Submittal Packages** regardless of testing. For non-tested lots, the **CPF Sheet** will show a CPF equal to 1.

(C) Asphalt Roadway – Verification Report

Form No. 675-030-21, Asphalt Roadway – Verification Report, is filled out by the Roadway Verification Technician. The technician enters and verifies the spread rate, the temperature, and bituminous materials used in each LOT. This will be submitted within the **LOT Submittal Package** in Excel Format. See [Attachment 11.1-4](#).

(D) Asphalt Roadway – Daily Report of Quality Control Report (QCRR)

The final portion of the **LOT Submittal Package** contains **Form 675-030-20A, Asphalt Roadway - Daily Report of Quality Control**, also known as the **Quality Control Roadway Report (QCRR)**. See [Attachment 11.1-5A](#). This form is furnished by the Department, completed by the Contractor, and is required to be submitted to the Project Administrator (PA) at the close of each lot or as requested by the PA. The **QCRR** calculates the spread rate and quantity adjustments automatically.

- (1) Each Contractor is required to record the placement of asphalt on the above form as the pavement operation progresses. The Contractor's Plant and Roadway Technicians are responsible for verifying the **QCRR** is filled out and correct. The Contractor is to ensure quality work. These reports are to be available for the Department's Plant and Roadway Verification Technicians at the place of production. The Roadway Verification Technician and the PA will work together to ensure that the Contractor's quantities are correct on the **QCRR** and the **LOT Submittal Package** is complete and ready for submission into the Collaboration Site. If corrections to the **QCRR** are required, the RO will send the form back to the Contractor for resubmittal.
- (2) The **QCRR** will be submitted in Excel format. Once the asphalt is completed and paid for, the final **QCRR** will be sent via email to the State Materials Office as a record of the as-built pavement data at the following email address: SM-MACQCRRUpload@dot.state.fl.us. The final **QCRR** submitted to the State Materials Office will be the final **QCRR** record in the Electronic Document Management System (**EDMS**). See **CPAM 11.4** for further information.
- (3) All projects let January 2018, and after, will **not** be required to submit **Form 700-050-72, Computer Summary of Quantities for Asphaltic Concrete**, also known as the daily asphalt ticket cover. However, the same daily tonnage information can be produced by the **QCRR** through the Reports function within the spreadsheet. The Report – **Daily Tons by Intended Use** should be used to compare the daily tonnage documented within the **QCRR** and the ticket information for accuracy. Since the **Daily Tons by Intended Use** Report is within the **QCRR**, it is not required to be submitted separately. See [Attachment 11.1-5B](#) for an example of this report.

11.1.5 Attachments

Attachment 11.1-1LOT Submittal Package and PDF Package
Attachment 11.1-2Asphalt Ticket Sheet Examples
Attachment 11.1-3 CPF Sheet Generated in MAC
Attachment 11.1-4Asphalt Roadway - Verification Report
Attachment 11.1-5A Asphalt Roadway – Daily Report of Quality Control
Attachment 11.1-5B Quality Control Roadway Report – Daily Tons by Intended Use

Attachment 11.1-1 Lot Submittal Package and PDF Package

Example A - *LOT Submittal Package* in PDF Package using printed tickets.

- (A) White: Asphalt tickets compiled by day.
- (B) Yellow: The CPF Sheet generated in MAC in PDF
- (C) Pink: The **QCRR** in Excel Format (.xlsm)
- (D) Orange: Verification Technician’s Reports in Excel Format (.xls) by day

Name	Description	Modified	Size
Delivery Tickets Lot 21 07-12-21.pdf		11/22/2021 12:51:37 PM	3.54 MB
Delivery Tickets Lot 21 07-13-21.pdf		11/22/2021 12:51:37 PM	8.95 MB
Delivery Tickets Lot 21 07-14-21.pdf		11/22/2021 12:51:37 PM	140.96 KB
LOT 21 CPF.pdf		11/22/2021 12:51:36 PM	174.39 KB
LOT 21 QCRR.xlsm		11/22/2021 12:51:36 PM	4.59 MB
VT Asphalt report 7-12-21.xls		11/22/2021 12:51:36 PM	453.00 KB
VT Asphalt report 7-13-21.xls		11/22/2021 12:51:36 PM	454.00 KB
VT Asphalt report 7-14-21.xls		11/22/2021 12:51:36 PM	399.50 KB

Example B - *LOT Submittal Package* in PDF Package using e-Ticketing information.

- (1) White: Electronic record of each truck load’s ticket information in .csv file
- (2) Yellow: The CPF Sheet generated in MAC in PDF
- (3) Pink: The **QCRR** in Excel Format (.xlsm)
- (4) Orange: Verification Technician’s Reports in Excel Format (.xls) by day

Name	Description	Modified	Size
e-Tickets Lot 21 07-12-21 to 07-14-21.csv		8/18/2021 3:31:00 PM	5.06 KB
LOT 21 CPF.pdf		11/22/2021 12:51:36 PM	174.39 KB
LOT 21 QCRR.xlsm		11/22/2021 12:51:36 PM	4.59 MB
VT Asphalt report 7-12-21.xls		11/22/2021 12:51:36 PM	453.00 KB
VT Asphalt report 7-13-21.xls		11/22/2021 12:51:36 PM	454.00 KB
VT Asphalt report 7-14-21.xls		11/22/2021 12:51:36 PM	399.50 KB

Attachment 11.1-2 Asphalt Ticket Sheet Examples

Example A: Printed tickets of the first and last truckload - 1st day's run

Page 3 of 3 300°

TICKET: 12412-1

DAB Constructors
1233 Commerce St.
Leesburg FL 34748

Loaded on 21 Jul 2017 @ 10:33 PM
CUSTOMER: 1 DAB CONSTRUCTORS INC
PLANT 1
D.O.T. #A0674

Loaded By: Jim
TRUCK: DT-40
MAX GROSS: 34.50 Tons

	GROSS*	TARE*	NET
Tons:	34.48	13.79	20.69

JOB: 631 LAKE COUNTY
PROJECT # 432333-1-52-01

US 441 THE VILLIAGES T5584
PO:

Product: 32 12.5 TLC SP15-14030A

Loads: 1 NET Tons: 20.69 Sold
JTD Tons: 20.69

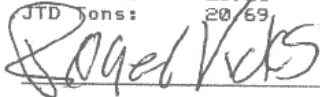
Signature:  Printed: 21 Jul 2017 @ 10:33 PM

TICKET: 12443-1

DAB Constructors
1233 Commerce St.
Leesburg FL 34748

Loaded on 22 Jul 2017 @ 4:10 AM
CUSTOMER: 1 DAB CONSTRUCTORS INC
PLANT 1
D.O.T. #A0674

Loaded By: Jim
TRUCK: DT-47
MAX GROSS: 34.31 Tons

	GROSS*	TARE*	NET
Tons:	18.53	13.45	5.08

JOB: 631 LAKE COUNTY
PROJECT # 432333-1-52-01

US 441 THE VILLIAGES T5584
PO:

Product: 32 12.5 TLC SP15-14030A

Loads: 32 NET Tons: 647.52 Sold
JTD Tons: 647.52

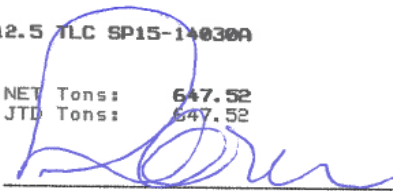
Signature:  Printed: 22 Jul 2017 @ 4:10 AM

Example B: Electronic ticket information in .csv file for the first and last truckload – 1st and 2nd day's run

Shift	Tkt#	Ticket Date	DOT #	Cust#	Customer MIX	Truck	Gross	Tare	Net	Total	Seq#	PlantNam	PlantLoca	QC Plant	QC Roadw	VT Plant	VT Roadw	Comment	Contract#	Plant ID
9/28/2020 4:13	371501	9/28/2020 8:14	4190131-5	32	Ranger Cc 12.5 C 40 S	36.3191	34.95	12.24	22.71	22.71	1	West Pair West Pair	300	295	0	0	0		T 4424	A0641
9/28/2020 4:13	371502	9/28/2020 8:17	4190131-5	32	Ranger Cc 12.5 C 40 S	36.3228	34.92	12.2	22.72	45.43	2	West Pair West Pair	300	290	0	0	0		T 4424	A0641
9/28/2020 4:13	371503	9/28/2020 8:22	4190131-5	32	Ranger Cc 12.5 C 40 S	36.3216	34.8	13.84	20.96	66.39	3	West Pair West Pair	300	290	0	0	0		T 4424	A0641
9/28/2020 4:13	371505	9/28/2020 8:27	4190131-5	32	Ranger Cc 12.5 C 40 S	36.3222	34.87	12	22.87	89.26	4	West Pair West Pair	305	290	0	0	0		T 4424	A0641
9/28/2020 4:13	371510	9/28/2020 8:41	4190131-5	32	Ranger Cc 12.5 C 40 S	36.319	34.79	13.68	21.11	110.37	5	West Pair West Pair	305	300	0	0	0		T 4424	A0641
9/28/2020 4:13	371525	9/28/2020 10:07	4190131-5	32	Ranger Cc 12.5 C 40 S	36.3191	34.79	12.27	22.52	132.89	6	West Pair West Pair	0	0	0	0	0		T 4424	A0641
9/28/2020 4:13	371536	9/28/2020 11:01	4190131-5	32	Ranger Cc 12.5 C 40 S	36.3228	34.83	12.3	22.53	155.42	7	West Pair West Pair	0	0	0	0	0		T 4424	A0641
9/28/2020 4:13	371538	9/28/2020 11:12	4190131-5	32	Ranger Cc 12.5 C 40 S	36.3216	34.75	13.84	20.91	176.33	8	West Pair West Pair	0	0	0	0	0		T 4424	A0641
9/28/2020 4:13	371542	9/28/2020 11:47	4190131-5	32	Ranger Cc 12.5 C 40 S	36.3222	34.76	11.97	22.79	199.12	9	West Pair West Pair	0	0	0	0	0		T 4424	A0641
9/28/2020 4:13	371543	9/28/2020 11:49	4190131-5	32	Ranger Cc 12.5 C 40 S	36.319	34.71	13.63	21.08	220.2	10	West Pair West Pair	300	295	0	0	0		T 4424	A0641
9/28/2020 4:13	371545	9/28/2020 12:06	4190131-5	32	Ranger Cc 12.5 C 40 S	36.3191	34.81	12.29	22.52	242.72	11	West Pair West Pair	0	0	0	0	0		T 4424	A0641
9/28/2020 4:13	371549	9/28/2020 12:53	4190131-5	32	Ranger Cc 12.5 C 40 S	36.3228	34.85	12.32	22.53	265.25	12	West Pair West Pair	0	0	0	0	0		T 4424	A0641
9/28/2020 4:13	371550	9/28/2020 12:55	4190131-5	32	Ranger Cc 12.5 C 40 S	36.3216	34.77	13.8	20.97	286.22	13	West Pair West Pair	0	0	0	0	0		T 4424	A0641
9/28/2020 4:13	371551	9/28/2020 13:01	4190131-5	32	Ranger Cc 12.5 C 40 S	36.3222	34.78	11.94	22.84	309.06	14	West Pair West Pair	0	0	0	0	0		T 4424	A0641
9/28/2020 4:13	371552	9/28/2020 13:03	4190131-5	32	Ranger Cc 12.5 C 40 S	36.319	34.8	13.61	21.19	330.25	15	West Pair West Pair	300	290	0	0	0		T 4424	A0641
9/28/2020 4:13	371557	9/28/2020 13:34	4190131-5	32	Ranger Cc 12.5 C 40 S	36.3191	34.79	12.27	22.52	352.77	16	West Pair West Pair	0	0	0	0	0		T 4424	A0641
9/28/2020 4:13	371559	9/28/2020 13:50	4190131-5	32	Ranger Cc 12.5 C 40 S	36.322	34.76	13.97	20.79	373.56	17	West Pair West Pair	0	0	0	0	0		T 4424	A0641
9/28/2020 4:13	371560	9/28/2020 13:56	4190131-5	32	Ranger Cc 12.5 C 40 S	36.3228	34.29	12.29	22	395.56	18	West Pair West Pair	0	0	0	0	0		T 4424	A0641
9/29/2020 4:28	371577	9/29/2020 7:40	4190131-5	32	Ranger Cc 12.5 C 40 S	36.3225	34.79	12.19	22.6	22.6	1	West Pair West Pair	310	295	0	0	0		T 4424	A0641
9/29/2020 4:28	371589	9/29/2020 8:14	4190131-5	32	Ranger Cc 12.5 C 40 S	36.3216	34.75	13.8	20.95	43.55	2	West Pair West Pair	310	295	0	0	0		T 4424	A0641
9/29/2020 4:28	371590	9/29/2020 8:18	4190131-5	32	Ranger Cc 12.5 C 40 S	36.3195	34.79	12.34	22.45	66	3	West Pair West Pair	310	295	0	0	0		T 4424	A0641
9/29/2020 4:28	371617	9/29/2020 11:06	4190131-5	32	Ranger Cc 12.5 C 40 S	36.3225	20.38	12.16	8.22	74.22	4	West Pair West Pair	0	0	0	0	0		T 4424	A0641
9/29/2020 4:28	371618	9/29/2020 11:09	4190131-5	32	Ranger Cc 9.5 C 40 SF	36.3216	34.81	13.74	21.07	21.07	1	West Pair West Pair	295	290	0	0	0		T 4424	A0641
9/29/2020 4:28	371633	9/29/2020 12:39	4190131-5	32	Ranger Cc 9.5 C 40 SF	36.3195	34.77	12.35	22.42	43.49	2	West Pair West Pair	305	290	0	0	0		T 4424	A0641
9/29/2020 4:28	371649	9/29/2020 13:54	4190131-5	32	Ranger Cc 9.5 C 40 SF	36.3225	15.25	12.12	3.13	46.62	3	West Pair West Pair	0	0	0	0	0		T 4424	A0641

Attachment 11.1-3 CPF Sheet Generated in MAC

Florida Department of Transportation Material Acceptance and Certification (MAC) Comparison Package Information [8/2/2017]						
Comparison Package 15539 [1700135985 QC-VT]						
Comparison Package ID	Comparison Definition		Comparison Type			Comparison Status
15539	QC-VT		Composite Pay Factor Comparison			Compares
Spec					Last Updated By	Last Updated On
334 - Superpave Asphalt Concrete, Supplemental Specification, 01/2016, v4.7					Karen Madrid	7/26/2017
Original Sample	Sample Level	FDOT Sample Number	LOT #	Sublot #	Project(s)	
1700135985	QC	2C004Q	1	4	432333-1-52-01	
Verification Sample	Sample Level	FDOT Sample Number	LOT #	Sublot #	Alternate Density Sublot Number	
1700137980	VT	2C004V	1	4	N/A	
Comparison Results						
	Comparison Name			Comparison Results		
1	APW: FM 5-563 (Percent Asphalt Content)			Compares		
2	APW: FM 1-T 030 Superpave Gradation (No. 8 Dense Graded)			Compares		
3	APW: FM 1-T 030 Superpave Gradation (No. 200 Dense Graded)			Compares		
4	APW: FM 1-T 166 Gmb - Plant (Average Gmb)			Compares		
5	APW: FM 1-T 166 Gmb - Roadway January 2016 (Gmb for each Core)			Compares		
6	APW: FM 1-T 209 Maximum Specific Gravity (Average Gmm)			Compares		
Associated Samples						
	Sublot #	Sample	Date Sample Taken	FDOT Sample Number	Mix Design	Sample Level
1	1	1700131854	7/13/2017	2C001Q	SP 15-14030A	QC
2	2	1700132331	7/14/2017	2C002Q	SP 15-14030A	QC
3	3	1700133537	7/16/2017	2C003Q	SP 15-14030A	QC
Composite Pay Factor						
		No. 8 Percent Passing	No. 200 Percent Passing	Percent Asphalt Content	Percent Air Voids	Density
Sublot 1		51.63	5.89	5.03	4.43	91.80
Sublot 2		49.51	5.90	4.88	4.34	91.33
Sublot 3		49.22	5.93	4.88	4.37	92.19
Sublot 4		48.81	5.79	4.99	3.64	91.50
Target		50.00	5.30	5.00	4.00	92.00
Pay Factor		1.05	1.05	1.05	1.05	1.05
Composite Pay Factor						1.05
* = Value is out of range [] = Replaced value						

Attachment 11.1-5A Asphalt Roadway – Daily Report of Quality Control

State of Florida Department of Transportation															Update Workbook		Clear EVERYTHING		675-030-20A CONSTRUCTION 04/09/2015											
Asphalt Roadway - Daily Report of Quality Control															Show Bit Cert Page		Import from file		Email Form Feedback to: DOT-AsphaltForms@dot.state.fl.us											
Lot # 23															View Plan Quantity Sheet		remove last lot		Show Reports											
Intended Lot Size 2000 tons															LIMS Import: Pay Item #'s		Assign Pay Item #'s		BASE ONLY											
Contractor: 431089-3-52-01															Mix Design # SPM13-11976A		Reload		Clear Data											
Gbr: 2.415															Quantity (TN)		Individual Lift Thickness (in)		Actual Spread Rate (LBS/SY)		Target Spread Rate (LBS/SY)		Total Thickness (in)		Prorated Base (SY)					
#	Day of Night	Sub Lot	Truck Load #'s	Intended Use	Density ?	Lan -	Desc.	Lift # of #	Start Paving at Station	End Paving at Station	Length (FT)	Width (FT)	Area Paved (SY)	Quantity (TN)	Individual Lift Thickness (in)	Actual Spread Rate (LBS/SY)	Target Spread Rate (LBS/SY)	Total Thickness (in)	Prorated Base (SY)											
6	Night: 1	1	3	FC-576-22	N	RT	R-1	1 1	135+25.00	137+40.00	215	13.10	312.94	12.40	0.75	79.25	73													
7	Night: 1	1	4-6	FC-576-22	N	RT	R-1	1 1	137+40.00	149+70.00	1130	13.30	1563.89	63.84	0.75	76.46	73													
8	Night: 1	1	7-10	FC-576-22	N	RT	R-1	1 1	148+70.00	163+60.00	1490	13.20	2185.33	85.80	0.75	78.52	73													
9	Night: 1	1	11-12	FC-576-22	N	RT	R-1	1 1	163+60.00	171+10.00	750	13.10	1091.67	42.95	0.75	78.69	73													
10	Night: 1	1	13	FC-576-22	N	RT	R-1	1 1	171+10.00	172+75.00	165	13.10	240.17	9.40	0.75	78.73	73													
11	Night: 1	1	13-15	FC-576-22	N	RT	R-1	1 1	174+05.00	183+90.00	985	13.30	1455.61	54.93	0.75	75.47	73													
12	Night: 1			Waste									0.00	0.00																
				DAILY TOTALS: 269.32 Total Tons 0.00 Tons Not in Lot 269.32 net tons 0.00 tons Require Density 269.32 tons Non-Density																										
															Intended Use		Pay Item #		Previous Total (Tons)		LOT Total (Tons)		Cumulative Total (Tons)		Previous Total (SY) w/OT for ATPB		LOT Total (SY) w/OT for ATPB		Cumulative Total (SY) w/OT for ATPB	
															SP TL-D		334 114		852.65		0.00		852.65		11,006.63		0.00		11,006.63	
															SP TL-D 76-22		334 124		27,559.87		0.00		27,559.87		345,214.43		0.00		345,214.43	
															SP TL-C		334 113		1,192.43		0.00		1,192.43		21,788.06		0.00		21,788.06	
															SP TL-C 76-22		334 123		6,432.89		0.00		6,432.89		99,120.44		0.00		99,120.44	
															FC-576-22		337 722		4,000.00		269.32		4,269.32		104,051.62		6,955.61		111,007.23	
															Straightedge Corrections				1,605.19		0.00		1,605.19		19,325.83		0.00		19,325.83	
															Waste				755.34		0.00		755.34		0.00		0.00		0.00	

Form 675-030-20A, Asphalt Roadway - Daily Report of Quality Control is used to calculate spread rates and record asphalt and tack quantities.

Attachment 11.1-5B Quality Control Roadway Report (QCRR): Daily Tons by Intended Use

	A	B	C	D	E	F	G
1							
2							
3	Sum of Quantity						
4		SP TL-C	Waste	(blank)	Grand Total		
5	(blank)						
6	7/11/2017	510.55	5.00		515.55		
7	7/13/2017	490.83	5.00		495.83		
8	7/14/2017	305.51	5.00		310.51		
9	7/16/2017	805.24	20.70		825.94		
10	7/17/2017	597.19			597.19		
11	7/18/2017	657.90	5.00		662.90		
12	7/21/2017	637.44	10.08		647.52		
13	7/23/2017	393.16			393.16		
14	7/24/2017	471.96	5.00		476.96		
15	7/25/2017	416.22	5.00		421.22		
16	7/26/2017	481.47	15.00		496.47		
17	7/27/2017	206.93			206.93		
18	7/31/2017						
19	Grand Total	5,974.40	75.78		6,050.18		
20							
21							

This report, produced by the **QCRR**, shows the daily tonnage by intended use. It should be used to verify the daily tonnage documented within the **QCRR** compared to the ticket information. This report is not required to be submitted separately and replaces the information previously provided by the daily asphalt ticket cover, **Form 700-050-72, Computer Summary of Quantities for Asphaltic Concrete**.

For example, on 7/21/2017, the report shows a Grand Total = 647.52 tons produced. However, only 637.44 tons were used and the remaining 10.08 tons were waste. [Attachment 11.1-2](#) shows first load ticket and last load ticket. The final load ticket is for Load 32 on 7/21/2017 for a net total of 647.52 tons.

Section 11.2

ASPHALT MIX TEMPERATURE CONTROL

11.2.1 Purpose

To provide a uniform procedure for acceptance of asphalt mix, based on temperature, for both the Asphalt Plant and Asphalt Paving Construction Training Qualification Program (CTQP) Qualified Technician on Contractor Quality Control (CQC) projects.

11.2.2 Authority

Section 334.048 and 20.23(4)(a), Florida Statutes (F.S.)

Section 320 and 330, Standard Specifications for Road and Bridge Construction

11.2.3 Temperature Measurement Procedures

(A) Resident Level Responsibilities

The Contractor's Technician, under the supervision of a CTQP Qualified Asphalt Plant Level II Technician, will take the temperature of the asphalt mix at the plant each day, for each design mix on the first five loads, and one every five loads thereafter. The Florida Department of Transportation's Qualified Asphalt Plant Level I or Level II Technician shall monitor and review the Contractor's plant temperature readings and take additional temperature measurements at a minimum frequency of two per day. Upon delivery of asphalt at the roadway, the Contractor's Technician under the supervision of a CTQP Qualified Asphalt Paving Level II Technician will take temperature readings at the roadway at the same frequency as at the plant. The following procedures should be followed:

- (1) The frequency of the measurement may be increased, as deemed necessary, by the Department's Technician.
- (2) The temperature measurements taken by the Contractor's Technician at the plant shall be compared to the mix design's mixing temperature. The temperature

measurements taken by the Contractor's Technician at the plant shall be recorded on the respective delivery tickets. The temperature measurements taken at the roadway shall be compared to the mix design's compaction temperature. The temperature measurements taken at the roadway shall be recorded on the front of the delivery ticket on the right hand side of the Contractor's Technician's temperature reading taken at the plant.

- (3) The Department's Qualified Plant Technician or Paving Technician will verify Contractor's measurements periodically at a minimum frequency of twice per day.
- (4) Rejection of the hot mix asphalt on the basis of the mix temperature shall be made in accordance with the **Standard Specifications** and necessary corrective action shall be made immediately.
- (5) The Contractor's Technician will record the temperature on the delivery tickets for the loads rejected and notify the Department's Technician of any such rejection. Department's Technician will report any rejected loads on [Form No. 675-030-21](#), **Asphalt Roadway – Verification Report**.

11.2.4 Corrective Action

(A) Resident Level Responsibilities

After corrective action is taken by the Contractor, the Contractor's Technician will monitor the next five loads produced to determine if the corrective action is effective. The Contractor and the Department will continue to monitor the loads until the average temperature of five successive loads is in compliance with Specification requirements at which time the Contractor's Technician can return to monitoring one out of every five loads.

Section 11.3

CATEGORIZING ASPHALT & OTHER BASE COURSES

11.3.1 Purpose

This procedure provides a means for categorizing the different asphalt courses and mix types and illustrates the units of measure.

11.3.2 Authority

Sections 20.23(3)(a) and 334.048(3), Florida Statutes (F.S.)

11.3.3 References

Standard Specifications for Road and Bridge Construction (Specifications)

11.3.4 The Different Courses

Asphalt and other base courses are discussed in this Section and include:

- Superpave Asphalt Concrete
 - Friction Course
 - Structural Course
 - Miscellaneous Asphalt
- Optional Base
 - Superpave Asphalt Concrete Base
 - Composite Base
 - Optional Base (excluding asphalt base)
 - Reclaimed Asphalt Pavement (RAP) Base
- Driveway Base
- Asphalt Treated Permeable Base (ATPB)
- Asphalt Membrane Interlayer
- Temporary Asphalt

11.3.5 Superpave Asphalt Concrete

Superpave Asphalt Concrete is fine graded and categorized into Friction Courses, Structural Courses, and Miscellaneous Asphalt. These categories are Tonnage pay items and are paid per **Specification Sections 286, 334, 337, and 339.**

Tonnage placed is reported by automatic printer tickets or electronic ticket (e-ticket) information showing weights. The paper tickets or e-tickets are included in the required **Lot Submittal Package**, and must be submitted with the Final Estimates Documentation for the Contract. Refer to **CPAM 11.1** for Asphalt LOT Documentation requirements and **CPAM 11.4** for explanation and examples of asphalt adjustments.

Friction Courses:

Friction course mixes provide good friction characteristics and skid resistance to the final pavement surface and are designated as FC-5, FC-9.5, and FC-12.5. These mixes have spread rate tolerances, cross slope tolerances, and straightedge tolerances and must meet the plant and equipment requirements of **Specifications Section 320**, the general construction requirements of **Specifications Section 330**, Superpave Asphalt Concrete general requirements of **Specifications Section 334**, and Asphalt Friction Course general requirements of **Specifications Section 337**.

Structural Courses:

Structural course mixes are the load carrying portion of pavement. These mixes are designated as SP-9.5, SP-12.5, and SP-19.0. Structural courses are used over travel lanes designed for Traffic Levels B, C, or E as indicated in the typical section of the contract plans, over Driveway Base per **Standard Plans Index 330-001**, as overbuild to correct cross slope issues as identified in the plans, and for other uses as identified by the Engineer. See **Specifications Section 334-3.2.1** for Mix Design Criteria and Traffic Level allowable substitutions.

These mixes have spread rate tolerances, cross slope tolerances, and straightedge tolerances and must meet the plant and equipment requirements of **Specifications Section 320**, and the general construction requirements of **Specifications Section 330 and 334**.

Miscellaneous Asphalt

Miscellaneous asphalt is used where vehicular traffic does not travel, such as median pavement, sidewalks, bicycle paths, and pavement under guardrail. The soil underneath these areas must be treated before asphalt is paved to prevent plant growth. In general, miscellaneous asphalt is visually inspected and accepted by the Department's Engineer with no density testing or other construction tolerances required. **Specification Section 339** provides the applicable construction requirements.

11.3.6 Base Courses

(A) Optional Base – General Description

Specifications Sections 234, 285, and 286 describe the optional base groups below and applicable construction requirements. When a base option is not indicated in the typical section of the plans, an allowable base group option is selected using **Specification Section 285-3** and **Table 285-1** and **285-2**.

Optional Base Courses are Square Yard pay items and are paid by plan quantity subject to provisions of **Specifications Section 9-3** and **Specifications Section 285**. Document changes only when a plan quantity error exceeds the limitations established in **Specifications Section 9-3**. Reference documentation of quantities in the **Final Estimate Documentation** per **CPAM 5.13**.

(1) Superpave Asphalt Base Courses

Asphalt Base course mixes are designated as “Type B-12.5” and are constructed in accordance with **Specification Section 234, 330, and 334**. When asphalt base is indicated on the typical section of the plans or when the Contractor selects “Type B-12.5” from **Table 285-1** or **Table 285-2**, the Contractor may use type SP-12.5 mixture (Traffic level B, C, or E) or Type SP-19.0 (Traffic Level B, C, or E) instead of type B-12.5, at no additional cost to the Department, per **Specifications 234-1**.

Superpave Asphalt Base is the only asphalt item paid by plan quantity in square yards as described in **Specifications 285-8** and **234-9**. Asphalt Base has a spread rate tolerance and must meet the thickness requirements specified in **Section 234-8**.

(2) Composite Base

Composite Base is a combination of Granular Subbase (White Base) as described in **Specification Section 290** and Superpave Asphalt Base. It is designated as “Type B-12.5 and 4” Granular Subbase, LBR 100” in Base Groups 9 thru 15 in **Table 285-1 or 285-2**, and like the other optional base groups, is paid by plan quantity in square yards.

The Granular Subbase portion is cored prior to placing the asphalt base layer. Areas of Granular Subbase thickness over 4 1/4” or under 3 1/2” must be corrected prior to placing asphalt per **Specification Section 290-4**.

The asphalt is placed as described in [Section 11.3.6\(A\)\(1\)](#) above.

(3) Optional Base (Excluding Asphalt)

Construction requirements for Optional base, such as Graded Aggregate, Limerock, Cemented Coquina, Shell Base, Shell-Rock, and Recycled Concrete Aggregate (RCA) are described in **Specification Section 285**. There is a thickness tolerance and areas which have a thickness deficiency in excess of ½ inch must be corrected per **Section 285-6**. If the Engineer approves the deficient area to stay in place with no pay, the deficient area is not included in the Calculated Average Thickness outlined in **Specification Section 285-7**.

(4) Reclaimed Asphalt Pavement (RAP) Base

RAP is used only on non-limited access paved shoulders, shared use paths, or other non-traffic bearing applications. It is paid by plan quantity in square yards per **Specifications 285** and is constructed per **Specifications 283** and **285**. RAP requires density testing and must meet the same thickness requirements as Optional Base per **Section 285-6**.

(B) Driveway Base

Driveway base for paved or graded driveways can be any optional base material as described in [Section 11.3.6\(A\)\(3\)](#) or any asphalt material described in [Section 11.3.5\(A\) and \(B\)](#) and approved by the Engineer, except for open-graded friction course (FC-5). Driveway base material must meet the minimum requirements provided in **Specification Section 286** and **Standard Plans Index 330-001**. In general, driveway base is visually inspected and accepted by the Department's Engineer with no testing required.

Driveway Base (Optional) is a square yard pay item paid by plan quantity.

Driveway Asphalt Base, previously known as Turnout Construction, is paid by weight in Tons and measured as described in **Specifications Sections 320-3**.

Asphalt Treated Permeable Base (ATPB)

ATPB is used under concrete pavement and placed around subdrainage pipe to support a subdrainage system as indicated in the contract plans and **Standard Plans Index 446-001**. It must meet the quality control requirements and production tolerances provided in **Standard Specification Section 287, 320, 330, and 334**. ATPB is the only Asphalt Cubic Yard pay item.

11.3.7 Asphalt Rubber Membrane Interlayer

Asphalt Rubber Membrane Interlayer (ARMI) is a layer of asphalt rubber binder covered in a single layer of aggregate which is rolled into the asphalt layer. It has been used on asphalt resurfacing projects to cover cracked or reseated concrete pavement. When used, ARMI must be constructed per **Specification 341** and is paid by plan quantity in square yards.

11.3.8 Temporary Asphalt

Temporary Asphalt is asphalt used to construct temporary facilities such as Limited Access Temporary Openings, Temporary Lane Separators, Temporary Detours, etc. The asphalt material is included and paid for within the quantity of the temporary pay item.

Section 11.4 ASPHALT ADJUSTMENTS

11.4.1 Purpose

This procedure provides guidance for determining the various adjustments associated with asphalt pay items (Pay Quantity Adjustments, Thickness Adjustments, Composite Pay Factor (CPF) Adjustments, Fuel Adjustments, and Bituminous Adjustments). Example calculations are provided in the Attachments at the end of this Chapter. Asphalt As-Built Data collection is also discussed.

11.4.2 Authority

Sections 20.23(3)(a), and 334.048(3), Florida Statutes (F.S.)

11.4.3 References

Standard Specifications for Road and Bridge Construction

11.4.4 Overview of Adjustment Types

Adjustments will be applied to applicable asphalt pay items as indicated in **Table 11.4-1**. Guidance is provided for each adjustment type within the body of this chapter.

On Lump Sum and Design Build Projects, adjustments are made per **Special Provisions, Section 9-2**. Refer to **CPAM 6.2** for information and examples.

Table 11.4-1						
Pay Item	Pay Quantity	Thickness	Deficient Asphalt	CPF	Fuel	Bituminous
Superpave Asphalt Base Courses	✓		✓	✓	✓	✓ ⁽¹⁾
Composite Base (Asphalt Portion Only)	✓		✓	✓	✓	✓
Superpave Asphalt Concrete Structural Courses	✓		✓	✓	✓	✓
Superpave Asphalt Concrete Friction Courses	✓		✓	✓	✓	✓
Miscellaneous Asphalt	✓			(2)	✓	✓
Optional Base Courses (White Base Only)		✓	✓		✓	
Asphalt Treated Permeable Base (ATPB)			✓	✓	✓	✓
Driveway Asphalt				(2)	✓	✓
Temporary Asphalt ⁽³⁾						

(1) Bituminous Adjustment is applied when “Asphalt Base Only” is specified in the typical section of the plans.
 (2) Miscellaneous Asphalt and Driveway Asphalt Base are not tested and are accepted on a visual basis. These pay items will have a CPF of 1 (i.e., no adjustment).
 (3) Temporary asphalt is always included in the quantity for another pay item (i.e., Special Detour 102-2) and does not get paid separately.

11.4.5 Pay Quantity Adjustments

The Department will pay for asphalt placed up to 105% (for projects let before July 2022) and 110% (for projects let July 2022 and after) of the Adjusted Plan Quantity for the square yard and tonnage pay items indicated in **Table 11.4-1**.

Form 675-030-20A, Asphalt Roadway – Daily Report of Quality Control-Automated Version (known as the **QCRR**) automatically calculates the pay quantity adjustments. It is the Contractor’s responsibility to coordinate with the Project Administrator (PA) (or designee) to verify the Plan Quantity Tonnage and any Engineer directed change(s) to be entered in the QCRR. Once the asphalt is complete, the final QCRR will calculate the Tonnage-Weighted Average G_{mm} (or G_{sb} for Open Graded Friction Course (FC-5)) for each pay item based on the tonnages and mix designs used on the project.

(A) Square Yard Pay Item Adjustments

(1) Superpave Asphalt Base

Superpave Asphalt Base Courses are the only asphalt square yard (SY) pay items. The pay area is adjusted not to exceed 105% (for projects let before July 2022) or 110% (for projects let July 2022 and after) of the designed surface area (SY) including engineer changes per **Specification Section 234-9**. Pay quantity adjustments can be positive, negative, or zero, and the adjustment will be automatically shown in the **QCRR**. The pay area (SY) is calculated using the following formulas:

$$\text{Adjusted PQ (TN)} = \frac{(\text{Plan Quantity (SY)}) (\text{Spread Rate (lbs/SY) per Spec. 234-8.1})}{2,000 \text{ Lbs/TN}}$$

$$\text{Pay Area (SY)} = [\text{Surface Area (SY)}] \left(\frac{\text{Actual Quantity Placed (TN)}}{\text{Adjusted Plan Quantity Tonnage}} \right)$$

$$\text{Maximum Pay Area (SY)} = 105\% \text{ or } 110\% \times (\text{Designed Surface Area (SY)})$$

Designed Surface Area (SY) = Plan Quantity + any engineer approved quantity changes.

NOTE: The Final Pay Area will be the Pay Area or the Maximum Pay Area, whichever is less. Use the formula below to determine the pay quantity adjustment.

$$\text{Pay Quantity Adjustment (SY)} = \text{Final Pay Area (SY)} - \text{Designed Surface Area (SY)}$$

See [Attachment 11-4-1](#) for examples of a negative adjustment, a positive adjustment, and an adjustment when the pay area exceeds the maximum pay quantity.

(2) Composite Base

Composite Base, as described in **CPAM 11.3**, is paid under pay item number 285-709 through 285-715 (see **Specification 285-3** and **Table 285-1**). Granular Subbase has a thickness tolerance and will be cored prior to placing the asphalt base layer per **Specification Sections, 285-3** and **290-4**. There is no pay quantity or thickness adjustment for the granular subbase layer.

Once the Asphalt Base layer is placed per **Specification Section 234**, payment will be adjusted per **Specification Section 234-9** as seen in [CPAM 11.4.5\(A\)](#) above. The adjustment will automatically be shown in the **QCRR**. See [Attachment 11-4-1](#) for examples of adjustments to the Superpave Asphalt Base portion.

(B) Tonnage Pay Item Adjustments

Superpave Asphalt Concrete Structural Courses and Miscellaneous Asphalt are the only tonnage pay items that receive pay quantity adjustments. They are final measure pay items, but the original plan quantity will be adjusted to account for the actual G_{mm} or G_{sb} used. Each of these pay items receive a pay quantity adjustment as shown in the **QCRR** and outlined below.

$$\text{Adjusted PQ} = \left(\frac{\text{PQ (TN)} \pm \text{Qty. Revisions}}{\text{Design } G_{mm} \text{ or } G_{sb}} \right) [\text{Tonnage-Weighted Average } G_{mm} \text{ or } G_{sb}]$$

$$\text{Tonnage-Weighted Average } G_{mm} = \frac{(\text{Tons}_{\text{Mix } 1})(G_{mm \text{ Mix } 1}) + (\text{Tons}_{\text{Mix } 2})(G_{mm \text{ Mix } 2}) + (\text{Tons}_{\text{Mix } n})(G_{mm \text{ Mix } n})}{(\text{Tons}_{\text{Mix } 1}) + (\text{Tons}_{\text{Mix } 2}) + (\text{Tons}_{\text{Mix } n})}$$

Maximum Pay Tonnage = 105% or 110%(Adjusted Plan Quantity)

NOTE: The Final Pay Tonnage will be the Tonnage Placed or the Maximum Pay Tonnage, whichever is less. If the Tonnage Placed exceeds the Maximum Pay Tonnage, use the formula below to determine the pay quantity adjustment.

Pay Quantity Adjustment (TN) = Maximum Pay Tonnage – Tonnage Placed

(1) Structural Courses

The plan quantity is determined using the design G_{mm} (2.540 per **Specification Section 334-1.4**). Excluding overbuild, the pay quantity will be based on the quantity placed on the project, limited to 105% (for projects let before July 2022) or 110% (for projects let July 2022 and after) of the adjusted plan quantity for each pay item. See **Specification Section 334-7**.

(2) Friction Courses

The plan quantity is determined using the design G_{mm} (2.540 per **Specification Section 334-1.4**), with exception to open graded friction course (FC-5) which is determined using the design G_{sb} (2.635 per **Specification Section 337-8.2**). The pay quantity for friction course will be based on the quantity placed on the project, limited to 105% (for projects let before July 2022) or 110% (for projects let July 2022 and after) of the adjusted plan quantity. **Specification Section 337-11**.

See [Attachment 11-4-2](#) for examples of adjustments to tonnage pay items.

(3) Miscellaneous Asphalt

The plan quantity is determined based on a spread rate of 100 Lbs/SY per inch of design thickness of asphalt placed over the area shown in the plans. The pay quantity will be based on the quantity placed on the project, limited to 105% (for projects let before July 2022) or 110% (for projects let July 2022 and after) of the adjusted plan quantity.

See [Attachment 11-4-2\(4\)](#) for an adjustment on Miscellaneous Asphalt.

(C) Cubic Yard Pay Item Adjustments

The only Asphalt Cubic Yard Pay Item is Asphalt Treated Permeable Base (ATPB). This pay item does not receive a pay quantity adjustment or thickness adjustment.

11.4.6 Thickness Adjustments

Non-asphalt Base Courses (white base) listed in **Specifications Section 285**, are square yard pay items. Thickness is calculated in accordance with **Specifications Section 285-7**. A thickness adjustment is applied to the Surface Area (Plan Quantity Area) minus any applicable deficient areas left in place at no pay. The Pay Area will not exceed 105% of the Surface Area (SY). There will be no adjustment for base courses that are constructed using mixed-in-place material.

$$\text{Pay Area (SY)} = [\text{Surface Area} - \text{Deficiency}] \left(\frac{\text{Calculated Avg. Thickness per 285-7}}{\text{Plan Thickness (in)}} \right)$$

$$\text{Maximum Pay Area (SY)} = 105\%(\text{Surface Area})$$

NOTE: The Final Pay Quantity will be the Pay Area or the Maximum Pay Area, whichever is less. Use the formula below to determine the thickness adjustment.

$$\text{Thickness Adjustment (SY)} = \text{Final Pay Quantity (SY)} - \text{Surface Area (SY)}$$

See [Attachment 11-4-3](#) for examples of thickness adjustments.

11.4.7 Adjusted Pay for Deficient Asphalt

Adjustments may be required when asphalt is deemed deficient due to poor workmanship. Deficiencies due to Segregation, Straightedge Testing, Cross Slope Deviations, or other workmanship issues can lead to asphalt being removed and replaced at no cost to the Department or asphalt being left in place. Refer to **CPAM 5.10**, **CPAM**

11.5 and the [QCRR Corrections](#) PowerPoint presentation on the State Construction Office Website for information and examples of adjustments for unacceptable pavement.

11.4.8 Composite Pay Factor Adjustments

Composite Pay Factor (CPF) adjustments are applied to Superpave Asphalt Base Course, Composite Base (Asphalt Portion Only), Structural Course, Friction Course and Asphalt Treated Permeable Base Courses. The CPF weighs pay factors for each of the quality characteristics for a LOT. Pay factors for dense-graded mixes are determined and weighted in the CPF for density, air voids, asphalt binder content, No. 8 sieve, and No. 200 sieve. Pay factors for open graded friction courses (FC-5) are determined and weighted in the CPF for asphalt binder content, 3/8" sieve, No. 4 sieve, and No. 8 sieve. The Materials Acceptance and Certification (MAC) database calculates these pay factors and the CPF.

CPF adjustments range from 0.75 to 1.05. The Contractor will receive a positive adjustment when the CPF is over 1.00 and a negative adjustment when the CPF is under 1.00. The Contractor will not receive a CPF adjustment when the CPF equals 1.00 or for Partial LOTs where no random sample is obtained. See **Specification Sections 334-8. and 337-12.**

(A) Low Composite Pay Factors in MAC

The Material's Acceptance and Certification (MAC) System flags a CPF less than 0.90 as a Materials Certification (MC) Review finding, and a Material Acceptance Resolution (MAR) will be processed.

A CPF less than 0.90 and greater than or equal to 0.80 is flagged as a Pay Reduction per **Specification** finding in **MAC**. It is not considered an Exception on the MC Review and the Project Materials Certification Letter.

If a CPF is less than 0.80, follow the requirements in **MAC** and in the **Standard Specifications**. Any actions taken per **Specification 334-5.9.3 – 334-5.9.5** are considered part of the Asphalt Producer QC Program and are not monitored or reported in **MAC**.

(B) Resident Level Responsibilities

The PA and the VT are responsible for verifying the accuracy of the Contractor's Quality Control (QC) Technician's test results entered in the **MAC** system.

Collect the CPF reports along with the asphalt ticket packets within two (2) working days after the closing of a LOT and submit the CPF reports electronically within the **LOT Submittal Package** described in **CPAM 11.1 Asphalt LOT Documentation**.

Once a LOT is closed, and it has been determined that a CPF adjustment must be made, make the adjustment during the month the LOT is closed and pay accordingly on the next progress estimate. Calculate the unit price adjustment and enter the revised unit price adjustment and quantity on the monthly estimate. The **QCRR** should accurately reflect the asphalt placed in each LOT.

In AASHTOware Project Construction (PrC), adjust the unit price by the appropriate CPF and enter only the difference in unit price, not the complete unit price. LOTs will be grouped together for each unit price adjustment as applicable. See [Attachment 11-4-4\(1\)](#). When the work is completed, use the average CPF of all the LOTs associated with the pay item to apply the final CPF adjustment to the final pay item quantity (calculated as the difference of the Final Pay Area and the plan quantity). Show the adjustments for each pay item in the **Final Estimates Documentation**.

NOTE: It is recommended to deduct asphalt left in place at no pay due to an Engineering Analysis Report (EAR) from the pay item quantity, rather than make a line item adjustment, to easily compare final quantities in PrC to the final quantities on the **QCRR**. See [QCRR Corrections](#) on the State Construction Office Website for an example.

See [Attachment 11-4-4](#) for CPF Calculations.

(1) CPF Adjustments for Square Yard (SY) Pay Items

The PA is responsible for ensuring the Contractor accurately reports the length and width of area being placed for square yard pay items. The PA is also responsible for comparing the plan quantity to the area placed and determining if plan quantity is in error and warrants an adjustment per **Specifications Section 9-3.2**.

The SY, as reported and verified in the QCRR, will be used to apply the CPF Adjustment when each lot closes. Use the average CPF of all the LOTs to apply the final CPF

adjustment to the final pay item quantity (calculated as the difference of the Final Pay Area and the plan quantity). See [Attachment 11-4-4\(3\)](#) for an example.

(2) Resolution Test Results - Materials Acceptance Resolution (MAR)

In some instances, the PA will require removal and replacement of tonnage within a LOT due to MAR – materials failure. This asphalt may be a partial subplot, an entire subplot, or an entire LOT. The QC Technician should identify the problem before an entire LOT is placed. The asphalt identified to be removed will be milled and replaced with asphalt either from the same LOT or from another LOT. If replaced with asphalt from a different LOT, the original **LOT Submittal Package** will be explained with remarks such as “No Pay” with reference to the new replacement **LOT Submittal Package**. The replacement material is to be paid in the **LOT Submittal Package** at the appropriate CPF for that lot’s production with references and remarks to the defective material **LOT Submittal Package**. Refer to [Bituminous Certifications & CPF Corrections – Due to Remove and Replace Asphalt](#) on the State Construction Office Website for examples on how to properly document MAR conditions.

See [Attachment 11-4-5](#) for an Example of (1) an e-mail from the District Materials’ Office to the PA with the number of tests and costs, an Example (2) of Resolution Testing Costs, and an Example (3) for reporting Cost Resolution Testing in PrC.

11.4.9 Fuel Adjustments

Fuel adjustments are applied to the pay items indicated in **Table 11.4-1**, per **Specifications Section 9-2.1.1**, when the original contract time is more than 120 calendar days.

Refer to **CPAM 5.14** for information and instructions on how to apply Fuel Adjustments to Asphalt pay items.

11.4.10 Bituminous Adjustments

Bituminous adjustments are applied to the pay items indicated in **Table 11.4-1**, per **Specifications Section 9-2.1.2**, when the original contract time is more than 365 calendar days, or the total bid quantity exceeds 5,000 Tons of asphalt.

Refer to **CPAM 5.14** for information and instructions on how to apply Bituminous Adjustments to Asphalt pay items. Also see [Bituminous Certifications & CPF Corrections – Due to Remove and Replace Asphalt](#) on the State Construction Office Website, and the [Attachments](#) within this Chapter.

11.4.11 As-Built Data Requirements

Asphalt As-Built Pavement Data will be collected on **Form 675-030-20A, Contractor's Quality Control Roadway Report (QCRR) - Automated Version**. Refer to **CPAM 5.12** for more information.

11.4.12 Attachments

<u>Attachment 11-4-1</u>	Adjustments on Square Yard Pay Items
<u>Attachment 11-4-2</u>	Adjustments on Tonnage Pay Items
<u>Attachment 11-4-3</u>	Thickness and Deficiency Adjustments for Optional Base
<u>Attachment 11-4-4</u>	CPF Calculations
<u>Attachment 11-4-5</u>	Resolution Test Results

Attachment 11-4-1 Adjustments on Square Yard Pay Items

(1) Negative Pay Quantity Adjustment with Bituminous, Fuel, and CPF Adjustments

Given:

A conventional project with Superpave Base Asphalt, Type B (12.5), Group 15 (Pay Item 285-715) contains the following criteria:

PQ Area = 46,800 SY

Unit Price = \$50.35 per SY

Design Thickness = 9"

G_{mm} used for PQ determination per **Specification 334-1.4** = 2.540 for Dense Graded Asphalt

The Contractor will lay the 9" in 3 courses: 3" each course

The Design Spread Rate = $G_{mm, design} \times 43.3 \text{ (Lbs/SY-in)} \times \text{thickness (in.)}$

= $2.540 \times 43.3 \text{ (Lbs/SY-in)} \times 9 \text{ (in)} = 989.84 = 990 \text{ Lbs/SY}$

The Target Spread Rate per lift =

$$\frac{990 \text{ Lbs/SY}}{(3)} = 330 \text{ Lbs/SY (based on the Specifications 334-1.4)}$$

From the Asphalt Roadway – Daily Report of Quality Control, three Design Mixes were used and their recorded tonnages:

Mix 1 with 17,451 Tons at G_{mm} of 2.561

Mix 2 with 3,780 Tons at G_{mm} of 2.599, and

Mix 3 with 1,659 Tons at G_{mm} of 2.488

Total Tons Placed on the Project (Tonnage from QCRR) = 22,890 Tons

No changes to PQ area.

What is the Final Pay?

NOTE 1: The QCRR will calculate the following. This is just an example. Outcome of quantities may be different than QCRR outcome due to rounding.

Solution:

1. The Tonnage-Weighted Average G_{mm} is calculated first.

$$\begin{aligned} \text{Tonnage-Weighted Average } G_{mm} &= G_{mm,avg} \\ &= \frac{(\text{Tons}_{\text{Mix } 1})(G_{mm \text{ Mix } 1}) + (\text{Tons}_{\text{Mix } 2})(G_{mm \text{ Mix } 2}) + (\text{Tons}_{\text{Mix } n})(G_{mm \text{ Mix } n})}{(\text{Tons}_{\text{Mix } 1}) + (\text{Tons}_{\text{Mix } 2}) + (\text{Tons}_{\text{Mix } n})} \\ G_{mm,avg} &= \\ &= \frac{[(17,451 \text{ Tons})(2.561) + (3,780 \text{ Tons})(2.599) + (1,659 \text{ Tons})(2.488)]}{(17,451 \text{ Tons} + 3,780 \text{ Tons} + 1,659 \text{ Tons})} \\ &= (44,692 \text{ Tons} + 9,824.2 \text{ Tons} + 4,127.5 \text{ Tons}) / 22,890 \text{ Tons} \\ &= 2.562 \end{aligned}$$

2. The Adjusted PQ Tonnage is calculated next using $G_{mm,avg}$.

$$\begin{aligned} \text{Adjusted PQ Tonnage} &= \frac{[(\text{PQ Area (SY)} \pm \text{Any Revisions})] \times [t \text{ (in)} \times G_{mm,avg} \times 43.3 \text{ (Lbs/SY-in)}]}{2,000 \text{ Lbs/Ton}} \\ &= \frac{46,800 \text{ SY} \times 9 \text{ in} \times 2.562 \times 43.3 \text{ Lbs/SY-in}}{2,000 \text{ Lbs/Ton}} \\ &= 23,362.8 \text{ Tons} \end{aligned}$$

3. The pay area is then calculated.

$$\begin{aligned} \text{Pay Area (per 234-9)} &= \text{Surface Area} \times \frac{\text{Actual Tonnage Placed}}{\text{Adjusted Plan Quantity}} \\ &= 46,800 \text{ SY} \times \frac{22,890 \text{ TN}}{23,362.8 \text{ TN}} \end{aligned}$$

= 45,853 SY This is the Final Pay Area since 105% Designed Surface Area was not exceeded:

105% Designed Surface Area = 46,800 SY x 1.05= **49,140 SY**

****110% Designed Surface Area on Projects let July 2022 and after.**

$$\text{Pay Adjustment} = \text{PQ Area (SY)} \times \left[\text{Ratio of } \frac{(\text{Tonnage Placed on Project})}{\text{Adjusted PQ Tons}} - 1 \right]$$

$$= 46,800 \text{ SY} \times \left[\frac{22,890 \text{ Tons}}{23,362.8 \text{ Tons}} - 1 \right]$$

$$= 46,800 \text{ SY} \times [- 0.0202]$$

= -947 SY (the QCRR will automatically calculate the - 947 SY (+ or – due to rounding), under the “Pay Quantity Sheet”).

NOTE 2: This is where the PA or Project Personnel will do the line item adjustments:

1. Since there were no Plan Errors or Field Revisions in this example, the Contractor will receive payment for the full PQ Area of 46,800 SY on the line item in PrC for pay item 285-715 (Asphalt Base is a PQ SY pay item).
2. However, due to less asphalt being placed than planned (per **Specifications Section 330-6.1.5**, (spread rate within plus or minus 5% of the target spread rate), there will be a pay adjustment. In this case, a minus 2% (the negative ratio of 0.0202) adjustment. This is within the 5% range, and since there were no other deficiencies, the Contractor will be deducted 947 SY: (– 947 SY x \$50.35/SY = – \$47,681.45). This will be entered in PrC manually as a negative Line Item Adjustment.

NOTE: As of January 2023, the spread rate must be within 10% of the target spread rate.

3. **Bituminous Adjustment:** The Contractor will receive a Bituminous Adjustment for all the asphalt produced and accepted, per **Specifications**, if the Typical Section shows Asphalt Black Base Only. Bituminous adjustments will be paid for the Final

Pay Area (in tonnage) for each pay item. If the Typical Section allows an Option for base (either white or black), a bituminous adjustment will not apply.

For black base only, a manual Correction Bituminous Adjustment will be made at the end of the contract to account for the difference between the tonnage placed and the final pay quantity (in tons).

Correction Bituminous Adjustment Calculation:

Step 1: Convert Final Pay Area (SY) to Tonnage using the tonnage-weighted average G_{mm}

$$\frac{45,853 \text{ SY} \times 9 \text{ in} \times 2.562 \times 43.3 \text{ Lbs/SY-in}}{2000 \text{ lb/TN}} = 22,890 \text{ TN}$$

Step 2: Subtract Final Pay Area in Tonnage from Total Tonnage from QCRR

$$22,890 \text{ TN} - 22,890 \text{ TN} = 0 \text{ TN}$$

(No adjustment is necessary since the contractor did not place all the necessary asphalt for this project)

4. **Fuel Adjustment:** Fuel adjustments will be paid for the Final Pay Area for each pay item. Since we paid the full PQ on the Line Item (46,800 SY), PrC made an automatic Fuel Adjustment for this quantity. Therefore, when the manual – 947 SY deduction is made in PrC, a corresponding manual fuel adjustment will also be made in PrC (to reconcile the Fuel adjustments to the Final Pay Area). The manual fuel adjustment can be calculated using Contractor’s Certification of Fuel Adjustment (DB/LS) Worksheet available on the State Construction Website. (Refer to **CPAM 5.14** for Fuel and Bituminous Adjustments.)
5. **CPF Adjustment:** CPF adjustments will be paid for the Pay Area for each pay item. As the project progresses, CPF adjustments will be made for each LOT with the appropriate CPF and corresponding SY (see calculations in [Attachment 11-4-4, \(3\)](#)). If the Contractor reports SY which exceeds the plan quantity, only the plan quantity (including approved Engineer changes) will be paid and used to calculate CPF adjustments. For this example, CPF adjustments will stop at 46,800 SY during construction.

Then a correction CPF adjustment will be made at the end of the project for the negative 947 SY to reconcile the CPF adjustments to the Final Pay Area. The

correction CPF adjustment will be made using the average CPF associated with this pay item. See below.

Example 1a: If **Average** CPF LOTs (for this pay item) = 1.02:

$$1.02 - 1 = 0.02$$

$$0.02 \times \$49.50/\text{SY} = \$0.99/\text{SY}$$

$$\$0.99/\text{SY} \times -947 \text{ SY} = - \$937.53 \text{ (to be deducted as a negative CPF line item adjustment)}$$

Example 2b: If **Average** CPF LOTs (for this pay item) = 0.99:

$$0.99 - 1 = - 0.01$$

$$- 0.01 \times \$49.50/\text{SY} = - \$0.50/\text{SY}$$

$$- \$0.50/\text{SY} \times 947 \text{ SY} = - \$473.50 \text{ (This will also be a negative line item adjustment)}$$

(2) Positive Pay Quantity Adjustment with Bituminous, Fuel, and CPF Adjustments

Given:

A project with Superpave Base Asphalt, Type B (12.5), Group 15 contains the following criteria:

PQ Area = 46,800 SY
Unit Price = \$49.50/SY
Contractor placed 24,340 Tons
No changes to PQ area.
Design Thickness = 9"

Three Design Mixes with recorded tonnages; they are:

Mix 1 with 18,451 Tons at G_{mm} of 2.561
Mix 2 with 4,780 Tons at G_{mm} of 2.599
Mix 3 with 1,109 Tons at G_{mm} of 2.488

What is the Final Pay?

NOTE 1: The QCRR will calculate the following. This is just an example. Outcome of quantities may be different than QCRR outcome due to rounding.

$$\begin{aligned} \text{Tonnage-Weighted Average } G_{mm} &= \\ &= \frac{[(18,451 \text{ Tons}) (2.561) + (4,780 \text{ Tons})(2.599) + (1,109 \text{ Tons})(2.488)]}{(18,451 \text{ Tons}) + (4,780 \text{ Tons}) + (1,109 \text{ Tons})} \\ &= \frac{(47,253 \text{ Tons} + 12,423.2 \text{ Tons} + 2,759.2 \text{ Tons})}{24,340 \text{ Tons}} \\ &= \frac{62,435.4 \text{ Tons}}{24,340 \text{ Tons}} \\ &= 2.565 \end{aligned}$$

$$\begin{aligned} \text{Adjusted PQ (TN)} &= \\ &= \frac{[(\text{PQ Area (SY)} \pm \text{Any Revisions})] \times [(t \text{ (in)} \times G_{mm,avg} \times 43.3 \text{ Lbs/SY-in})]}{2,000 \text{ Lbs/Ton}} \end{aligned}$$

$$= \frac{46,800 \text{ SY} \times (9 \text{ in} \times 2.565 \times 43.3 \text{ Lbs/SY-in})}{2,000 \text{ Lbs/Ton}}$$

$$= 23,390.1 \text{ Tons}$$

$$\text{Pay Area (per 234-9)} = \text{Surface Area} \times \frac{\text{Actual Tonnage Placed}}{\text{Adjusted Plan Quantity}}$$

$$= 46,800 \text{ SY} \times \frac{24,340 \text{ TN}}{23,390.1 \text{ TN}}$$

$$= \mathbf{48,700 \text{ SY}} \quad \mathbf{\text{This is the Final Pay Area since 105\% Designed Surface Area was not exceeded:}}$$

$$105\% \text{ Designed Surface Area} = 46,800 \text{ SY} \times 1.05 = 49,140 \text{ SY}$$

****110% Designed Surface Area on Projects let July 2022 and after.**

$$\text{Pay Adjustment} = \text{PQ Area (SY)} \times \left[\text{Ratio of } \frac{(\text{Tonnage Placed on Project})}{\text{Adjusted PQ Tons}} - 1 \right]$$

$$= 46,800 \text{ SY} \left[\frac{24,340 \text{ Tons}}{23,390.1 \text{ Tons}} - 1 \right]$$

$$= 46,800 \text{ SY} \times 0.0406$$

$$= 1,900 \text{ SY (This will be shown on the QCRR)}$$

NOTE 2: This is where the PA or Project Personnel will do the line item adjustments:

1. Since there were no Plan Errors or Field Revisions in this example, the Contractor will receive payment for the full PQ Area of 46,800 SY in PrC.
2. The Contractor placed more asphalt than planned (the 0.0406 is 104%), and since the placement is less than the 105% limit, there will be a pay adjustment. The Contractor will receive a positive Adjustment for the 1,900 SY in PrC as a manual line item adjustment.

3. **Bituminous Adjustment:** The Contractor will receive a Bituminous Adjustment for all the asphalt produced and accepted, per **Specifications**, if the Typical Section shows Asphalt Black Base Only. Bituminous adjustments will be paid for the Final Pay Area (in tonnage) for each pay item. If the Typical Section allows an Option for base (either white or black), a bituminous adjustment will not apply.

For black base only projects, a manual Correction Bituminous Adjustment will be made at the end of the contract to account for the difference between the tonnage placed and the final pay quantity (in tons).

Correction Bituminous Adjustment Calculation:

Step 1: Convert Final Pay Area (SY) to Tonnage using the tonnage-weighted average Gmm

$$\frac{48,700 \text{ SY} \times 9 \text{ in} \times 2.565 \times 43.3 \text{ Lbs/SY-in}}{2000 \text{ lb/TN}} = 24,340 \text{ TN}$$

Step 2: Subtract Final Pay Area in Tonnage from Total Tonnage from QCRR

$$24,340 \text{ TN} - 24,340 \text{ TN} = 0 \text{ TN}$$

(No adjustment is necessary since the contractor did not place all the necessary asphalt for this project)

4. **Fuel Adjustment:** Fuel adjustments will be paid for the Final Pay Area for each pay item. Since we paid the full PQ on the Line Item, PrC made an automatic Fuel Adjustment for this quantity. Therefore, when the + 1,900 SY addition is made in PrC, a corresponding manual fuel adjustment will also need to be made, in PrC (to reconcile the Fuel adjustments to the Final Pay Area). The manual fuel adjustment can be calculated using Contractor's Certification of Fuel Adjustment (DB/LS) Worksheet available on the State Construction Office Website. (Refer to **CPAM 5.14** for Fuel Adjustments.)

5. **CPF Adjustment:** CPF adjustments will be paid for the Pay Area for each pay item. The Contractor placed the plan quantity which was accepted on this project. As the project progresses, the CPF adjustments will be made for each LOT with the appropriate CPF and corresponding SY (see calculations in [Attachment 11-4-4\(3\)](#)). If the Contractor reports SY which exceeds the plan quantity shown in the plans, only the plan quantity (including approved Engineer changes) will be paid and used to calculate CPF adjustments. For this example, CPF adjustments will stop at 46,800 SY during construction.
6. A correction CPF adjustment will be made at the end of the project for the positive 1,900 SY to reconcile the CPF adjustments to the Final Pay Area. The correction CPF adjustment will be made using the average CPF associated with this pay item.

(3) Pay Quantity Adjustment when Pay Area Exceeds the Maximum Pay Quantity with Bituminous, Fuel, and CPF Adjustments

Given:

A project with Superpave Base Asphalt, Type B (12.5), Group 15 contains the following criteria:

PQ Area = 46,800 SY
Unit Price: \$ 49.50/SY
Contractor placed Tons = 24,950 Tons
No changes to PQ Area
Design Thickness = 9"

The three Design Mixes used and their recorded tonnages are:

Mix 1 with 18,451 Tons at G_{mm} of 2.561
Mix 2 with 4,780 Tons at G_{mm} of 2.599
Mix 3 with 1,719 Tons at G_{mm} of 2.488

What is the Final Pay?

NOTE 1: The QCRR will calculate the following. This is just an example. Outcome of quantities may be different than QCRR outcome due to rounding.

Solution:

1. Tonnage-Weighted Average G_{mm} =

$$\begin{aligned} &= \frac{(\text{Tons}_{\text{Mix } 1})(G_{mm \text{ Mix } 1}) + (\text{Tons}_{\text{Mix } 2})(G_{mm \text{ Mix } 2}) + (\text{Tons}_{\text{Mix } n})(G_{mm \text{ Mix } n})}{(\text{Tons}_{\text{Mix } 1}) + (\text{Tons}_{\text{Mix } 2}) + (\text{Tons}_{\text{Mix } n})} \\ &= \frac{[(18,451 \text{ Tons})(2.561) + (4,780 \text{ Tons})(2.599) + (1,719 \text{ Tons})(2.488)]}{(18,451 \text{ Tons}) + (4,780 \text{ Tons}) + (1,719 \text{ Tons})} \\ &= \frac{(47,253 \text{ Tons} + 12,423.2 \text{ Tons} + 4,276.9 \text{ Tons})}{24,950 \text{ Tons}} \\ &= \frac{64,253.1 \text{ Tons}}{24,950 \text{ Tons}} \\ &= 2.563 \end{aligned}$$

$$\begin{aligned} 2. \text{ Adjusted PQ Tons} &= \frac{(\text{PQ Area SY} \pm \text{Any Revisions}) \times [(t \text{ (in)} \times G_{mm, \text{ avg}} \times 43.3 \text{ Lbs/SY-in})]}{2,000 \text{ Lbs/Ton}} \\ &= \frac{(46,800 \text{ SY}) \times [(9 \text{ in} \times 2.563 \times 43.3 \text{ Lbs/SY-in})]}{2,000 \text{ Lbs/Ton}} \\ &= 23,371.9 \text{ Tons} \end{aligned}$$

$$\begin{aligned} 3. \text{ Pay Area (per 234-9)} &= \text{Surface Area} \times \frac{\text{Actual Tonnage Placed}}{\text{Adjusted Plan Quantity}} \\ &= 46,800 \text{ SY} \times \frac{24,950 \text{ TN}}{23,371.9 \text{ TN}} \\ &= 49,960 \text{ SY} \text{ (105\% Design Surface Area was exceeded, so the **Final Pay** } \\ &\quad \text{Quantity will be limited to **49,140 SY**)} \end{aligned}$$

105% Designed Surface Area = 46,800 SY x 1.05= 49,140 SY

****110% Designed Surface Area on Projects let July 2022 and after.**

$$\begin{aligned} 4. \text{ Pay Adjustment} &= \text{PQ Area} \times \left[\text{Ratio of } \frac{\text{Tons Placed}}{\text{Adjusted Quantity}} - 1 \right] \\ &= 46,800 \times \left[\frac{24,950}{23,371.9} - 1 \right] \\ &= 46,800 [0.06752] = 3,160 \text{ SY} \end{aligned}$$

Since the ratio of 0.0675 or 106% is greater than 105%, the Contractor can only receive up to 105% adjustment of the Design PQ Area per **Specifications**.

Therefore, the adjustment limited by the **Specifications** will be:

$$46,800 \times 0.05 = 2,340 \text{ SY (This will be shown on the QCRR)}$$

NOTE 2: This is where the PA or Project Personnel will do the line item adjustments:

1. Since there were no Plan Errors or Field Revisions in this example, the Contractor will receive payment for the full PQ Area of 46,800 SY in PrC.
2. The Contractor will receive a manual line Item Adjustment for the + 2,340 SY in PrC which is the 105% PQ adjustment.
3. For **Bituminous Adjustments**: For Bituminous Adjustments, the Contractor will get paid for all the asphalt produced and accepted, when applicable. Bituminous adjustments will be paid for the Final Pay Area (in tonnage) for each pay item.

For black base only projects, a manual Correction Bituminous Adjustment will be made at the end of the contract to account for the difference between the tonnage placed and the final pay quantity (in tons).

Correction Bituminous Adjustment Calculation:

Step 1: Convert Final Pay Area (SY) to Tonnage using the tonnage-weighted average Gmm

$$\frac{49,140 \text{ SY} \times 9 \text{ in} \times 2.563 \times 43.3 \text{ Lbs/SY-in}}{2000 \text{ lb/TN}} = 24,540.5 \text{ TN}$$

Step 2: Subtract Final Pay Area in Tonnage from Total Tonnage from QCRR

$$24,950 \text{ TN} - 24,540.5 \text{ TN} = 409.5 \text{ TN}$$

Step 3: Apply a manual line item adjustment in PrC to deduct the 409.5 TN using the index for the last month of paving.

Fuel Adjustments: Fuel adjustments will be paid for the Final Pay Area for each pay item. Since we paid the full PQ on the Line Item, PrC made an automatic Fuel Adjustment for this quantity. Therefore, when the 2,340 SY Line Item Adjustment is processed in PrC, a corresponding manual Fuel Adjustment will be made for the additional quantity in PrC (to reconcile the Fuel adjustments to the Final Pay Area). The manual fuel adjustment can be calculated using Contractor's Certification of Fuel Adjustment (DB/LS) Worksheet available on the State Construction Office Website. (Refer to **CPAM 5.14** for Fuel Adjustments.)

CPF Adjustment: CPF adjustments will be paid for the Pay Area for each pay item. As the project progresses, the CPF Adjustments will be made for each LOT with the appropriate CPF and corresponding SY (see [Attachment 11-4-4\(3\)](#) for SY pay Items). If the Contractor reports SY which exceeds the plan quantity shown in the plans, only the plan quantity (including approved Engineer changes) will be paid and used to calculate CPF adjustments. For this example, CPF adjustments will stop at 46,800 SY during construction.

A correction CPF adjustment will be made at the end of the project for the positive 2,340 SY to reconcile the CPF adjustments to the Final Pay Area. The correction CPF adjustment will be made using the average CPF associated with this pay item. See Attachment 11-4-1, Example (1)(2).

Attachment 11-4-2 Adjustments to Tonnage Pay Items

(1) No Pay Quantity Adjustment with Bituminous, Fuel, and CPF Adjustments

This example is for a Contract with two FPID's where the Contractor placed less Tonnage than planned. This example is rare but could happen.

Given:

A project with Superpave Asphalt, Traffic Level B, PG 76-22, (Pay Item 334-1-52) contains the following criteria. From the Contract and per **Specifications 334-1.4**, Dense Graded Structural or Friction Courses will use a $G_{mm} = 2.540$ to determine design quantities

Project "A" Plan Quantity Tons show 13,754.3 Tons
Project "B" Plan Quantity Tons show 91.1 Tons
Total PQ Tons from Contract and Plans = 13,845.3 Tons
Total PQ Area (SY) = 173,622 SY
No changes to PQ Area.

Project "A":

Total asphalt placed = 13,345.0 Tons
Three Design Mixes were used per the QCRR:
 Mix 1 with $G_{mm} = 2.599$ at 9,000.0 Tons
 Mix 2 with $G_{mm} = 2.615$ at 2,500.0 Tons
 Mix 3 with $G_{mm} = 2.578$ at 1,845.0 Tons

Project "B":

Total Asphalt placed = 89.2 Tons
One Design Mix was used per the QCRR:
 Mix 1 with $G_{mm} = 2.599$ at 89.2 Tons

Total Tonnage placed on this Contract = 13,345 Tons + 89.2 Tons = 13,434.2 Tons

What is the Final Pay for Project A and Project B?

NOTE 1: The QCRR will calculate the following. This is just an example. Outcome of quantities may be different than QCRR outcome due to rounding.

Solution:

$$\text{Adjusted PQ Tonnage} = \frac{(\text{Plan Area TN} \pm \text{Any Revisions}) \times (\text{Tonnage-Weighted Average } G_{mm})}{\text{Design } G_{mm}}$$

And the

Tonnage-Weighted Average G_{mm} =

$$\frac{(\text{Tons}_{\text{Mix 1}})(G_{mm \text{ Mix 1}}) + (\text{Tons}_{\text{Mix 2}})(G_{mm \text{ Mix 2}}) + (\text{Tons}_{\text{Mix n}})(G_{mm \text{ Mix n}})}{(\text{Tons}_{\text{Mix 1}}) + (\text{Tons}_{\text{Mix 2}}) + (\text{Tons}_{\text{Mix n}})}$$

On this Contract, Design Mix 1 for Projects A and B was the same, so they can be combined: Design Mix 1 Tonnage = 9,000.0 + 89.2 = 9,089.2 Tons

2. Tonnage-Weighted Average G_{mm} for the Total Contract

$$\begin{aligned} &= \frac{(\text{Tons}_{\text{Mix 1}})(G_{mm \text{ Mix 1}}) + (\text{Tons}_{\text{Mix 2}})(G_{mm \text{ Mix 2}}) + (\text{Tons}_{\text{Mix n}})(G_{mm \text{ Mix n}})}{(\text{Tons}_{\text{Mix 1}}) + (\text{Tons}_{\text{Mix 2}}) + (\text{Tons}_{\text{Mix n}})} \\ &= \frac{[(9,089.2 \text{ Tons})(2.599) + (2,500.0 \text{ Tons})(2.615) + (1,845 \text{ Tons})(2.578)]}{(9,089.2 \text{ Tons}) + (2,500.0 \text{ Tons}) + (1,845.0 \text{ Tons})} \\ &= \frac{(23,622.8 \text{ Tons} + 6,537.5 \text{ Tons} + 4,756.4 \text{ Tons})}{13,434.2 \text{ Tons}} \end{aligned}$$

= 2.599 (Tonnage-Weighted- G_{mm} for the Total Contract)

$$2. \text{ Adjusted Plan Quantity Tons} = 13,845.3 \text{ Tons} \times \frac{2.599}{2.540}$$

= 14,166.9 Tons

4. Maximum Pay Tonnage = 1.05 x Adjusted Plan Quantity Tons
****1.10 on projects let after July 2022**

= 1.05 x 14,166.9 Tons

= 14,875.2 Tons (*Maximum that will be paid*)

However, the Contractor only placed 13,434.2 Tons total for the Contract, which is less than the Adjusted PQ, and less than the max, so the Contractor will get paid what was placed.

Contractor will get paid for:

Project A = 13,345.0 Tons
Project B = 89.2 Tons

NOTE 2:

1. Since there were no Plan Errors or Field Revisions in this example, the Contractor will receive payment for the tonnage placed as the project progresses in PrC.
2. Since the contractor placed less than 105% there will be no PQ adjustment. If the Contractor placed asphalt that is excessively deficient, follow the necessary requirements under **Specifications Section 330**.
3. **Bituminous Adjustment:** Because Bituminous Adjustments will be made as the project progresses for the actual Tonnage placed, there will be no additional bituminous adjustments required at the end of the contract.
4. **Fuel Adjustments:** Since we paid for the actual tonnage placed, PrC made an automatic Fuel Adjustments for this quantity. Therefore, there will be no additional Fuel Adjustments required at the end of the contract.

CPF Adjustment: Because CPF Adjustments will be made as the project progresses for the actual Tonnage placed (see [Attachment 11-4-4\(2\)](#)), there will be no additional CPF Adjustments required at the end of the contract.

(2) Negative Pay Quantity Adjustment with Bituminous, Fuel, and CPF Adjustments

Given:

A project with Superpave Asphalt, Traffic Level B, PG 76-22, (Pay Item 334-1-52) contains the following criteria. From the Contract and per **Specifications 334-1.4**, Dense graded Structural or Friction Courses will use a $G_{mm} = 2.540$ for design quantities.

Plan Quantity Tons = 13,845.3 Tons
Total PQ Area (SY) = 173,622 SY

Three Design Mixes were used per the QCRR:

Mix 1 with $G_{mm} = 2.599$ at 9,000.0 Tons:

Mix 2 with $G_{mm} = 2.615$ at 2,500.0 Tons and

Mix 3 with $G_{mm} = 2.578$ at 3,450.0 Tons

Total Tons placed and accepted = 14,950.0 Tons

What is the Final Pay?

NOTE 1: The QCRR will calculate the following. This is just an example. Outcome of quantities may be different than QCRR outcome due to rounding.

Solution:

1. Tonnage-Weighted Average G_{mm}

$$\begin{aligned} &= \frac{(\text{Tons}_{\text{Mix 1}})(G_{mm \text{ Mix 1}}) + (\text{Tons}_{\text{Mix 2}})(G_{mm \text{ Mix 2}}) + (\text{Tons}_{\text{Mix n}})(G_{mm \text{ Mix n}})}{(\text{Tons}_{\text{Mix 1}}) + (\text{Tons}_{\text{Mix 2}}) + (\text{Tons}_{\text{Mix n}})} \\ &= \frac{[(9,000.0 \text{ Tons})(2.599) + (2,500.0 \text{ Tons})(2.615) + (3,450.0 \text{ Tons})(2.578)]}{(9,000.0 \text{ Tons}) + (2,500.0 \text{ Tons}) + (3,450.0 \text{ Tons})} \\ &= \frac{(23,391 \text{ Tons} + 6,537.5 \text{ Tons} + 8,894.1 \text{ Tons})}{(14,950 \text{ Tons})} \\ &= 2.597 \end{aligned}$$

$$\begin{aligned} 2. \text{ Adjusted PQ Tons} &= \frac{(\text{Plan Area TN} \pm \text{Any Revisions}) \times (\text{Tonnage-Weighted Average } G_{mm})}{\text{Design } G_{mm}} \\ &= \frac{(13,845.3 \text{ Tons} \times 2.597)}{2.540} \\ &= 14,156.0 \text{ Tons} \end{aligned}$$

$$5. \text{ Max Pay Tonnage} = 1.05 \times \text{Adjusted PQ Tons}$$

****1.10 on project let after July 2022**

$$= 1.05 \times 14,156.0 \text{ Tons}$$

$$= 14,863.8 \text{ Tons}$$

NOTE 2: This is where the PA or Project Personnel will do the line item adjustments:

1. Since the tonnage is paid as the project progresses, 14,950.0 Tons will be paid on the pay item.
2. Since the Contractor placed more than the maximum tonnage allowed per **Specifications** (pay up to 105% of the adjusted PQ Tonnage), there will be a negative line item adjustment of 86.2 Tons deducted for the excess tonnage placed. To calculate the extra tonnage placed:

$$\begin{aligned} \text{Deduction for extra tonnage placed} &= \text{Max Pay Tonnage} - \text{Tons Placed} \\ &= 14,863.8 - 14,950.0 = - 86.2 \text{ Tons} \end{aligned}$$

3. **Bituminous Adjustment:** Because Bituminous Adjustments will be made as the project progresses for the actual Tonnage placed, a manual deduction for the corresponding quantity (-86.2 Tons) will be made from the Last Bituminous Certification Sheet. Make a note indicating the reason.
4. **Fuel Adjustments:** Since we paid for the actual tonnage placed, PrC made an automatic Fuel Adjustments for this quantity. Therefore, when the extra tonnage was deducted in PrC, a corresponding manual Fuel Adjustment will be entered in PrC.

CPF Adjustment: Because CPF Adjustments will be made as the project progresses for the actual Tonnage placed (see [Attachment 11-4-4\(2\)](#)) the tonnage placed over the

105% will be deducted using the average CPF associated with this pay item. Also see [Attachment 11-4-1\(3\)](#).

(3) Pay Quantity Adjustment when Quantity Placed equals the Maximum Pay Quantity with Bituminous, Fuel, and CPF Adjustments (Open Graded FC-5)

Given:

A project with Open Graded Friction Course contains the following criteria. **Specifications Section 337-8.2** states that a $G_{sb} = 2.635$ shall be used. For all the equations previously shown for Tonnage pay items, the G_{mm} will be substituted for G_{sb} . For open graded FC, only one layer of asphalt is placed.

Total PQ Tons from Plans = 13,936.5 Tons

Total PQ Area = 173,622 SY

Three Design Mixes were used per the QCRR:

Mix 1 with $G_{sb} = 2.638$ at 9,000.0 Tons:

Mix 2 with $G_{sb} = 2.640$ at 2,500.0 Tons and

Mix 3 with $G_{sb} = 2.636$ at 3,150.0 Tons

Total Tons placed and accepted on project = 14,650 Tons

What is the Final Pay?

NOTE 1: The QCRR will calculate the following. This is just an example. Outcome of quantities may be different than QCRR outcome due to rounding.

Solution:

1. Tonnage-Weighted $G_{sb} =$

$$\begin{aligned} &= \frac{(\text{Tons}_{\text{Mix 1}})(G_{\text{mm Mix 1}}) + (\text{Tons}_{\text{Mix 2}})(G_{\text{mm Mix 2}}) + (\text{Tons}_{\text{Mix n}})(G_{\text{mm Mix n}})}{(\text{Tons}_{\text{Mix 1}}) + (\text{Tons}_{\text{Mix 2}}) + (\text{Tons}_{\text{Mix n}})} \\ &= \frac{[(9,000.0 \text{ Tons})(2.638) + (2,500.0 \text{ Tons})(2.640) + (3,150.0 \text{ Tons})(2.636)]}{(9,000.0 \text{ Tons}) + (2,500.0 \text{ Tons}) + (3,150.0 \text{ Tons})} \\ &= \frac{(23,742 \text{ Tons}) + (6,600 \text{ Tons}) + (8,303.4 \text{ Tons})}{(14,650 \text{ Tons})} \\ &= 2.638 \end{aligned}$$

2. Adjusted PQ Tons

$$\begin{aligned} &= \frac{(\text{Plan Area TN} \pm \text{Any Revisions}) \times (\text{Tonnage-Weighted Average } G_{mm})}{\text{Design } G_{mm}} \\ &= \frac{(13,936.5 \text{ Tons} \times 2.638)}{(2.635)} \\ &= 13,952.4 \text{ Tons} \end{aligned}$$

3. Max Pay Tonnage = 1.05 x Adjusted PQ Tons (****1.10 on project let after July 2022**)

$$\begin{aligned} &= 1.05 \times 13,952.4 \text{ Tons} \\ &= 14,650.0 \text{ Tons (Maximum that will be paid)} \end{aligned}$$

The Contractor placed the exact tonnage that we could pay up to. Therefore, Contractor will get paid the total tonnage placed which equals up to the 105% per **Specifications**.

The Contractor will receive Fuel and Bituminous adjustments for the total asphalt that was placed and accepted. Also, the CPF, if less than or greater than 1, will be adjusted in PrC manually.

(4) Negative Pay Quantity Adjustment on Miscellaneous Asphalt

Given:

A conventional project has miscellaneous asphalt around guardrail. The project area contains the following criteria. From the Contract and per **Specifications 334-1.4**, Dense graded Structural or Friction Courses will use a $G_{mm} = 2.540$ for design quantities.

Original Plan Area = 800 SY
Original PQ Tons = 80.00 Tons
Final Area = 800 SY
Final Tons = 90.5 Tons

Only one Mix was used per the QCRR with $G_{mm} = 2.544$

What is the Final Pay?

NOTE 1: The QCRR will calculate the following. This is just an example. Outcome of quantities may be different than QCRR outcome due to rounding.

1. Tonnage-Weighted Average G_{mm}

$$\begin{aligned} &= \frac{(\text{Tons}_{\text{Mix 1}})(G_{\text{mm Mix 1}})}{(\text{Tons}_{\text{Mix 1}})} \\ &= \frac{(90.5 \text{ Tons} \times 2.544)}{(90.5 \text{ Tons})} \\ &= 2.544 \end{aligned}$$

2. Adjusted PQ Tons =

$$\begin{aligned} &= \frac{(\text{Plan Area TN} \pm \text{Any Revisions}) \times (\text{Tonnage-Weighted Average } G_{\text{mm}})}{\text{Design } G_{\text{mm}}} \\ &= \frac{(80.0 \text{ Tons} \times 2.544)}{(2.540)} \\ &= 80.1 \text{ Tons} \end{aligned}$$

3. Max Pay Tonnage = 1.05 x Adjusted PQ Tons (**1.10 on project let after July 2022**)

$$\begin{aligned} &= 1.05 \times 80.1 \text{ Tons} \\ &= 84.1 \text{ Tons (Maximum that will be paid)} \end{aligned}$$

$$\begin{aligned} \text{Pay Adjustment} &= \text{Max Pay Tonnage} - \text{Tons Placed} \\ &= 84.1 \text{ Tons} - 90.5 \text{ Tons} \\ &= - 6.4 \text{ Tons (Deducted from the Bituminous and Fuel reports)} \end{aligned}$$

NOTE 2: There will be **no** CPF adjustment on Miscellaneous Asphalt.

Miscellaneous Asphalt does receive Fuel and Bituminous adjustments per ***Specifications***.

Attachment 11-4-3 Thickness and Deficiency Adjustments for Optional Base (White Base)

(1) Positive Core-Out Calculations

Given:

What is the final pay quantity for a limerock project given the following information? Is a line item adjustment needed?

Plan Thickness = 7.00"
Plan Quantity Area = 8,000 SY
Final Area = 8,000 SY
Actual Average Core-out Report Thickness = 7.50"

Specifications allow a maximum ½" tolerance per **Section 285-7**

Solution:

1. Determine if the thickness exceeds 5%

$$\begin{aligned}\text{Core Out Ratio} &= \frac{(\text{Core Out Thickness} - \text{Plan Thickness})}{\text{Plan Thickness}} \\ &= \frac{(7.50" - 7.00")}{7.00"} \\ &= 0.071428571 \times 100 = 7.1428571\% > 5\%^{**}\end{aligned}$$

**Make sure to use the floating decimal to calculate over or under the 105%.

Since 7.1428571% exceeds the 5% stated in the **Specifications Section 285-8**, the maximum pay area will govern the payment.

2. Determine the Maximum Pay Area

$$\begin{aligned}\text{Maximum Pay Area} &= 1.05 \times \text{PQ Area} \\ &= 1.05 \times 8,000 \text{ SY} \\ &= 8,400 \text{ SY}\end{aligned}$$

3. Thickness adjustment = Maximum Pay Area – PQ Area
= 8,400 SY – 8,000 SY = 400 SY

The Department will pay the Contractor the 8,000 SY area per the plans and can only pay an additional 400 SY for the maximum thickness adjustment per **Specifications**.

400 SY will need to be entered manually as a positive line item adjustment in PrC. Likewise, if the project is eligible for fuel adjustment, a line item adjustment will be entered manually for the fuel based on the price index at the final month of limerock installation.

(2) Negative Core-Out Calculations

Given:

What is the final pay quantity for a limerock project given the following information? Is a line item adjustment needed?

Plan Thickness = 8.00"

Plan Quantity Area = 10,500 SY

Final Area = 10,000 SY

Actual Average Core-out Report Thickness = 7.79" (See Note 1)

Specifications allow a maximum ½" tolerance per **Section 285-7**

Solution:

1. Determine the Core Out Ratio

$$\begin{aligned}\text{Core Out Ratio} &= \frac{(\text{Core Out Thickness} - \text{Plan Thickness})}{\text{Plan Thickness}} \\ &= \frac{(7.79" - 8.00")}{8.00"} = - 0.0262500*\end{aligned}$$

**Since the core out ratio is negative, the 105% does not control.*

2. Determine the Thickness Adjustment Area

Thickness Adjustment Area = Core Out Ratio x Plan Quantity Area

$$= - 0.026250 \times 10,500 \text{ SY}$$

$$= - 275.6 \text{ SY}$$

$$= - 276 \text{ SY (Negative Thickness Adjustment)}$$

The Department will pay the Contractor the 10,500 SY area per plan, and has to manually deduct 276 SY for the negative thickness adjustment.

276 SY will need to be shown as a negative line item adjustment.

A corresponding manual negative fuel adjustment for 276 SY will also need to be done based on the index of the last month of limerock installation.

*Make sure to use the floating decimal on your calculator to come up with either the negative or positive adjustment.

NOTE 1: Any Core-out average less than the plan specified thickness (in this example, anything less than 8") will be considered a negative adjustment.

NOTE 2: Any shy area on the Core-out report is excluded from the Core-out average calculation. Shy areas will need to be corrected by scarifying and adding additional base material. Or if authorized by the Engineer, it may be left in place without correction and at no pay (per **Specifications 285-6.2**). See [Example \(3\)](#) for a deficient area left in place with no pay calculation.

(3) Deficient Area Calculation (Area Left in Place with No Pay)

From the last page of the core out report seen below:

FDOT V4.2.2 6/2008 Updated Report and type selection									
CORE-OUT AVERAGES									
PAGE NO 6									
DATE PROC: 2/8/2016					DISTRICT 5				
PROJECT NO. 123456-1-52-01					Date 06/08/2015				
ROAD 40					MIN 12.00 MAX 13.00				
COUNTY MARION									
DATA IS IN ENGLISH					VALUES ARE IN INCHES				
STATION	WIDTH	ACTUAL THICKNESS				SPECIFICATION ALLOWANCE			
		LEFT	CENTER	RIGHT	AVERAGE	LEFT	CENTER	RIGHT	AVERAGE
615+02	24		12.20		12.20		12.20		12.20
543+50	24	12.80			12.80	12.80			12.80
542+42	24			12.80	12.80		12.80		12.80
541+20	24		12.50		12.50		12.50		12.50
537+12	24			12.40	12.40		12.40		12.40
537+83	24		12.10		12.10		12.10		12.10
538+38	24	11.90			11.90	*SHY*			
532+40	24	12.40			12.40	12.40			12.40
534+21	24			12.00	12.00		12.00		12.00
535+10	24		12.10		12.10		12.10		12.10
525+95	24			12.30	12.30		12.30		12.30
527+30	24	12.30			12.30	12.30			12.30
529+05	24		12.20		12.20		12.20		12.20
522+45	24			12.00	12.00		12.00		12.00
523+71	24	11.90			11.90	*SHY*			
524+80	24		12.30		12.30		12.30		12.30
519+85	24		12.10		12.10		12.10		12.10
518+70	24			12.00	12.00		12.00		12.00
517+80	24	12.70			12.70	12.70			12.70
JOB AVERAGE			3269.80/	259	12.6247	3242.50/	257		12.6167

On This project, the Plan thickness is 12.5 inches. This report shows two (2) shy areas that will need to be addressed. There are two options for resolution of these areas. The Contractor can choose to correct by scarifying and adding additional base material or, in this case, the Engineer authorized that the area be left in-place at no pay per **Specifications 285-6**.

1st shy core is at Station 538+38

2nd shy core is at Station 523+71

The Length of the deficiency is calculated from the closest non-deficient cores on each side of the deficient core.

In this example:

1st length is from Sta. 537+83 to Sta. 532+40 = 543 Ft.

2nd length is from Sta. 522+45 to Sta. 524+80 = 235 Ft.

Any shy area left in place at No Pay will be excluded from the core out average calculation and a deduction for the shy area will be made to the plan quantity.

NOTE: Preferably, the Contractor, to his advantage, should revisit the shy cores to take additional cores to isolate the area. If this does not occur, the length will be taken from the core out report from the nearest acceptable core of each side of the deficient core which will increase the deducted area.

Given:

What is the final pay quantity for a limerock project given the following information? Is a line item adjustment needed?

Plan Thickness = 12.5 Inches
Actual Average Core-out Report Thickness = 12.6167"
Plan Quantity Area = 30,000 SY
Total Length of Shy Area = 778 Ft.
Total Width of Shy Area = 24 Ft.

Solution:

1. Calculate the Shy Area Left in Place at NO PAY:

$$\text{Shy Area} = \frac{L \text{ (Ft.)} \times W \text{ (Ft.)}}{9 \left(\frac{\text{SF}}{\text{SY}} \right)}$$
$$\text{Shy Area} = \frac{(778 \text{ Ft})(24 \text{ Ft})}{9 \text{ SF/SY}} = 2,075 \text{ SY Deduction}$$

A negative line item adjustment will be applied in PrC for 2,075 SY for the deficient areas.

2. Determine if the thickness exceeds 5%

$$\text{Core Out Ratio} = \frac{(\text{Core Out Thickness} - \text{Plan Thickness})}{\text{Plan Thickness}}$$
$$= \frac{(12.62" - 12.50")}{12.50"}$$
$$= 0.0096 \times 100 = 0.96\% < 5\%^{**}$$

**Make sure to use the floating decimal to calculate over or under the 105%.

Since 0.96% is less than the 5% stated in the **Specifications Section 285-8**, the maximum pay area will not govern the payment.

3. Calculate the Thickness Adjustment Area

Since 2,075 SY was a negative adjustment due to area left in place at no pay, we must deduct this area from the PQ Area of 30,000 SY, per **Specifications**.

$$30,000 - 2,075 = 27,925 \text{ SY}$$

$$\begin{aligned} \text{Thickness Adjustment Area} &= \text{Core Out Ratio} \times \text{Plan Quantity Area (less any deducts)} \\ &= 0.0096 \times 27,925 \text{ SY} \\ &= 268 \text{ SY} \end{aligned}$$

Final Quantity:

The entire plan quantity of 30,000 SY will be paid and include 3 line item adjustments. First, a positive line item adjustment of 268 SY will be applied manually in PrC, this is the thickness adjustment. Second, a negative line item adjustment (from Step 1) of 2,075 SY will be applied in PrC manually for the deficient areas.

Third, if the project is eligible for fuel adjustment, a line item adjustment for the net amount (-1,807 SY = 268 SY - 2,075 SY) will be entered manually for the fuel based on the price index at the final month of limerock installation.

Attachment 11-4-4 CPF Calculations

(1) Plan Summary Box for Superpave Asphaltic Concrete (Traffic B)

SUMMARY OF PAVEMENT														
PAY ITEM NO.	PAY ITEM DESCRIPTION	LOCATION		SIDE	AREA ID	LENGTH	WIDTH	UNI T	QUANTITY		TOTAL		DESIGN NOTES	CONSTRUCTION REMARKS
		STA. TO STA.	DESCRIPTION						P	F	P	F		
285-707	OPTIONAL BASE GROUP 07	Sta. 0+00 to 110+25				11250.0	24.0	SY	30000.00	✓	30000.0	✓		No Plan Errors No Field Revisions
														5200 @ .96 CPF*
														12100 @ 0.98 CPF
														12300 @ 1.02 CPF
														400 @ 1.02 CPF
														* See asphalt folder for CPF adjustments
														Typical Section indicates black bas only

(2) CPF Calculation for Tonnage Pay Items

All Plan Summary Box references will be documented as shown in [Attachment 11-4-4\(1\)](#).

(a) If CPF is <0.80 or ≥0.75

Given:

A project with Superpave Asphalt, Traffic Level C, PG 76-22, (Pay Item 334-1-53) contains the following criteria. Calculate the line item adjustment that should be made for the LOT CPF.

LOT 2, CPF is 0.76.
LOT Tonnage = 4,000 Tons
Unit Price = \$50.05/Ton

Solution:

1. Calculate the CPF Difference

$$0.76 - 1.00 = -0.24$$

2. Calculate the CPF Adjustment for the Entire LOT
- 0.24 x \$50.05/Ton = - \$12.01/Ton
- \$12.01/Ton x 4,000 Tons = - \$48,040.00

A negative Line Item Adjustment of -\$48,000 will be applied manually in PrC for LOT 2.

(b) If CPF is > 0.80 and < 1.00

Given:

A project with Superpave Asphalt, Traffic Level C, PG 76-22, (Pay Item 334-1-53) contains the following criteria. Calculate the line item adjustment that should be made for the LOT CPF.

For LOT 3, CPF is 0.98
LOT Tonnage = 4,000 Tons
Unit Price = \$50.05/Ton

Solution:

1. Calculate the CPF Difference

$$0.98 - 1.00 = - 0.02$$

2. Calculate the CPF Adjustment for the Entire LOT

$$- 0.02 \times \$50.05/\text{Ton} = - \$1.00/\text{Ton}$$

$$4,000 \text{ Tons} \times - \$1.00/\text{Ton} = - \$4,000.00$$

A negative Line Item Adjustment of -\$4,000 will be made in PrC for LOT 3.

(c) **If CPF = 1.00**

Given:

A project with Superpave Asphalt, Traffic Level C, PG 76-22, (Pay Item 334-1-53) contains the following criteria. Calculate the line item adjustment that should be made for the LOT CPF.

For LOT 4, CPF is 1.00

LOT Tonnage = 4,000 Tons

Unit Price = \$50.05/Ton

Solution:

1. Calculate the CPF Difference

$$1.00 - 1.00 = 0$$

There is no CPF adjustment at 1.00.

(d) **If CPF is > 1.00 and up to 1.05**

Given:

A project with Superpave Asphalt, Traffic Level C, PG 76-22, (Pay Item 334-1-53) contains the following criteria. Calculate the line item adjustment that should be made for the LOT CPF.

LOT 5, CPF is 1.03

LOT Tonnage = 4,000 Tons

Unit price = \$50.05/Ton

Solution:

1. Calculate the CPF Difference

$$1.03 - 1.00 = 0.03$$

2. Calculate the CPF Adjustment for the Entire LOT

$$0.03 \times \$50.05/\text{Ton} = \$1.5015 = \$1.50/\text{Ton}$$

$$4,000 \text{ Tons} \times \$1.50/\text{Ton} = \$ 6,000.00$$

A positive Line Item Adjustment of \$6,000 will be made in PrC for LOT 5

(3) CPF for Square Yard Pay Items

Given:

A project with Superpave Asphalt Base contains the following criteria. Calculate the line item adjustment that should be made for the LOT CPF. The bid unit price is \$50.35/SY.

For Lot 4: CPF = 1.02

Actual LOT Tonnage per the QCRR = 2,000 Tons

$G_{mm,lot} = 2.562$

Design Area = 4,124 SY, based on G_{mm} of 2.54

Design Thickness = 9"

Solution:

Specification Section 234-9 states that the quantity will be paid as the plan quantity, however the pay area will be adjusted based on the following formula:

$$\text{Pay Area (SY)} = \frac{[\text{Actual Tonnage} \times 2,000 \text{ Lbs/Ton}]}{[t \text{ (in)} \times G_{mm,lot} \times 43.3 \text{ (Lbs/SY-in)}]}$$

$$\text{Pay Area (SY)} = \frac{[2,000 \text{ Tons} \times 2,000 \text{ Lbs/Ton}]}{[9 \text{ in} \times 2.562 \times 43.3 \text{ Lbs/Ton-in}]}$$

$$\text{Pay Area (SY)} = 4,006 \text{ SY}$$

Specification Section 234-9 also states that the maximum pay area shall not exceed 105% of the designed surface area (i.e. plan quantity).

$$\begin{aligned}\text{Max. Pay Area} &= 1.05 \times \text{Designed Surface Area} \\ &= 1.05 \times 4,124 \text{ SY} \\ &= 4,330 \text{ SY}\end{aligned}$$

For final payment purposes, we will use 4,006 SY instead of 4,124 SY for the CPF Adjustment, since it has been adjusted for the actual lot G_{mm} . Since the maximum pay area quantity was not exceeded, it will not need to be used.

$$\begin{aligned}\text{CPF Adjustment for this LOT} &= 1.02 - 1 = 0.02 \\ 0.02 \times \$50.35/\text{SY} &= \$1.01/\text{SY} \\ \$1.01/\text{SY} \times 4,006 \text{ SY} &= \$4,046.06.\end{aligned}$$

This will be a positive CPF Line Item Adjustment equal to \$4,046.06.

NOTE 1: Use [Attachment 11-4-1\(3\)](#) as a reference for deducting CPF's on the last LOT.

(4) CPF for Composite Base (Square Yard Pay Item)

Given:

A project with Composite Base, Pay Item 285-714, contains the following criteria. Calculate the line item adjustment that should be made for the LOT CPF.

Subbase is 4" Limerock and Superpave Asphalt Base SP12.5 of 6.5"

Design Area Paved = 11,191 SY (based on Gmm of 2.54)

CPF = 0.89

Information from the QC Roadway Report:

LOT 6 = 4,000 Tons

Lot Gmm = 2.562

Unit price = \$92.00/SY for pay item 285-714

Solution:

1. Calculate the CPF Difference

$$0.89 - 1.00 = -0.11$$

2. The unit price includes the 4" subbase plus the 6.5" of asphalt. In this case a unit price for the asphalt will need to be calculated. The Limerock Subbase does not receive an adjustment, (see **Specification 290**)

Total Thickness = 4" + 6.5" = 10.5"

$$\frac{\$92.00 \times 6.5"}{10.5"} = \$56.95 \quad \text{Unit Price for the asphalt portion of the pay item}$$

3. Calculate the Pay Area (SY)

$$\text{Pay Area (SY)} = \frac{[\text{Actual Tonnage} \times 2,000 \text{ Lbs/Ton}]}{[t \text{ (in)} \times G_{\text{mm,lot}} \times 43.3 \text{ (Lbs/SY-in)}]}$$

$$\text{Pay Area (SY)} = \frac{[4,000 \text{ Tons} \times 2,000 \text{ Lbs/Ton}]}{[6.5 \text{ in} \times 2.562 \times 43.3 \text{ Lbs/Ton-in}]}$$

$$\text{Pay Area (SY)} = \mathbf{11,095 \text{ SY}}$$

Specification Section 234-9 also states that the maximum pay area shall not exceed 105% (for projects let before July 2022) and 110% (for projects let July 2022 and after) of the designed surface area (i.e. plan quantity including engineer approved changes).

$$\begin{aligned}\text{Max. Pay Area} &= 1.05 \times \text{Designed Surface Area} \\ &= 1.05 \times 11,191 \text{ SY} \\ &= 11,751 \text{ SY}\end{aligned}$$

(For final payment purposes, we will use 11,095 SY instead of 11,191 SY for the CPF Adjustment, since it has been adjusted for the actual lot G_{mm}). The maximum pay area will not be used since it was not exceeded.

4. Calculate the CPF Adjustment for the Entire LOT

$$\begin{aligned}- 0.11 \times \$56.95/\text{SY} &= - \$6.26/\text{SY} \\ 11,095 \text{ SY} \times - \$6.26/\text{SY} &= - \$69,454.70\end{aligned}$$

A negative Line Item Adjustment of \$69,454.70 will be made in PrC for LOT 6.

NOTE: Use [Attachment 11-4-1\(3\)](#), as a reference for deducting the CPF at the end of the asphalt placement by using the average CPF for all the LOTs that included this pay item, to calculate the adjustment.

(5) Composite Base for Cubic Yard Pay Items

Asphalt treated permeable base is measured and paid for in cubic yards. Therefore, the quantity can be obtained from the Asphalt Roadway – Daily Report of Quality Control. Calculate the adjustment given the information below.

Given:

LOT 3, CPF of 1.05
Total Tonnage LOT 3 = 1,623.55 Tons
Total Square Yards LOT 3 = 9,494.13 SY
Volume = 1,055 CY
Unit Price is \$240.05/CY

Solution:

1. Calculate the CPF Difference

$$1.05 - 1.00 = 0.05$$

2. Calculate the CPF Adjustment for the Entire LOT

$$0.05 \times \$240.05/\text{CY} = \$12.00/\text{CY}$$

$$1,055 \text{ CY} \times \$12.00/\text{CY} = \$12,660.00$$

A positive Line Item Adjustment will be made for \$12,660 in PrC for LOT 3

(6) CPF Documentation for Multiple FIN Projects, Under One Contract

All CPF's for asphalt produced and accepted for a particular item shall be reported under the lead FIN (see exception below). The quantities for each FIN will be determined by the PA, as the prorated amount determined from the pay item breakout as provided in the plan set. This will be done by taking the total tons shown for each FIN and dividing it by the total tons for the Contract, then multiplying this amount by the total tons placed for each CPF. This shall be done during the month the LOT is closed out and paid accordingly on the monthly progress estimate.

Given:

Project "A" shows 10,385.5 tons
Project "B" shows 21,466.0 tons
Total for Contract = 31,851.5 tons
Tons placed = 32,561.0 tons

CPF @ 105% (Lots 1, 3, & 10) = 9,650.0 tons
CPF @ 102% (Lots 2, 5, 6, 7, 8, & 9) = 20,923.0 tons
CPF @ 98% (Lot 4) = 1,988.0 tons

Calculate the tonnage for each CPF in Project "A" and Project "B".

Solution:

Project "A":

The tonnage for each CPF is determined by dividing the total Project "A" tonnage by the total tonnage for the entire contract and multiplying by the total tons for each CPF.

$$\text{CPF @ 105\%: } \left(\frac{10,385.5 \text{ tons}}{31,851.5 \text{ tons}} \right) (9,650 \text{ tons}) = 3,146.5 \text{ tons}$$

$$\text{CPF @ 102\%: } \left(\frac{10,385.5 \text{ tons}}{31,851.5 \text{ tons}} \right) (20,923.0 \text{ tons}) = 6,822.2 \text{ tons}$$

$$\text{CPF @ 98\%: } \left(\frac{10,385.5 \text{ tons}}{31,851.5 \text{ tons}} \right) (1,988.0 \text{ tons}) = 648.2 \text{ tons}$$

Project "B":

Likewise, the tonnage for each CPF is determined by dividing the total Project “B” tonnage by the total tonnage for the entire contract and multiplying by the total tons for each CPF.

$$\text{CPF @ 105\%: } \left(\frac{21,466.0 \text{ tons}}{31,851.5 \text{ tons}} \right) (9,650 \text{ tons}) = 6,503.5 \text{ tons}$$

$$\text{CPF @ 105\%: } \left(\frac{21,466.0 \text{ tons}}{31,851.5 \text{ tons}} \right) (20,923 \text{ tons}) = 14,100.8 \text{ tons}$$

$$\text{CPF @ 105\%: } \left(\frac{21,466.0 \text{ tons}}{31,851.5 \text{ tons}} \right) (1,988 \text{ tons}) = 1,339.8 \text{ tons}$$

Contract Summary:

Verify the tonnages for each corresponding CPF for both Project “A” and Project “B” sum together to equal the contract tonnages used.

Total CPF @ 105% = 3,146.5 + 6,503.5 = 9,650.0 tons ✓

Total CPF @ 102% = 6,822.2 + 14,100.8 = 20,923.0 tons ✓

Total CPF @ 98% = 648.2 + 1339.8 = 1,988.0 tons ✓

NOTE 1: This may be done on Federal Aid participating and Non-Federal Aid participating projects. These pro-rated amounts shall be shown in a file attached electronically to the **Plan Summary Box** along with the calculations, or the calculation could be shown at the bottom of the **Plan Summary Box** for Construction Remarks and calculations.

NOTE 2: For this example: 32,561.0 tons placed by Contractor is within the 105% maximum of the adjusted plan quantity for the pay item, which is allowed per **Specifications** for conventional projects.

Exception: When an item is shown only on one FIN number, those tons will be reported on that FIN number. If the same pay item is shown on multiple FINs, but each has a different unit price, treat as different pay items.

Attachment 11-4-5 Resolution Test Results

(1) E-Mail from District Material's Office to the PA with No. of Tests and Costs

Daniel Day

From: Daniel Day
Sent: Thursday, May 21, 2015 @ 2:49 PM
To: Howard Jump (howard.jump@dot.state.fl.us)
Cc: J. Corley; Bill Blass; etc., etc.
Subject: FIN # 41109815201 LOT 6 Resolution Results

Howard,

Attached are the Resolution results for LOT 6 on the above-mentioned project. The Resolution results **DO NOT** compare with QC results. Therefore, acceptance and payment for the LOT with respect to density will be based on Resolution results.

Cost for the Resolution testing should be deducted from the monthly estimate (see below).

For each subplot, the Resolution results for average Roadway Gmb should replace the QC results for average Roadway Gmb, and most likely change the density value, Individual Pay Factor, and the Composite Pay Factor. Any new values should be compared to the Master Production Range as well as the criteria of 334-5.9.5 to determine acceptance.

- Please do not approve the QC or RT samples for this LOT. The resolution lab will approve these samples.
- Resolution cost (- \$31.60 per core x 9 cores = - \$ 84.40)

Thanks
Daniel Day
Assistant District Bituminous Manager
Florida Department of Transportation
100 N. Day Road (MS 20)
Deland, Florida 33333
380-555-5550 (office)

(2) Resolution Testing Costs on Website

The cost of resolution testing, if performed by the Department and favors the VT results, will be deducted from the Contractor's next progress estimate.

The resolution testing fees are based on the year the Contract was let. For example, if a Contract was let in January 2010 and a resolution test was done in January 2011, the January 2010 year pricing index would be used.

[Resolution Testing Costs](#) can be found on the State Materials Office Website under Documents and Publications.

[Resolution Testing Costs for Contracts Let Between 2023/2024 \(PDF-187KB\)](#)
 ... Previous Years: [22/23](#), [21/22](#), [20/21](#), [19/20](#), [18/19](#), [17/18](#), [16/17](#), [15/16](#), [14/15](#), [13/14](#)

(Note: Please use the resolution testing cost sheet for the Fiscal Year the Contract was let. If a specific test is not in the list on the subjected Fiscal Year cost sheet, then use the next FY list or until you see the test.)

Florida Department of Transportation Resolution Testing Costs Year 2023-2024 Rates		
Bituminous Lab		
Test Name	Quantity	Test Cost
Bulk specific gravity of Compacted Bituminous Mixtures (FM 1-T166)	Per roadway core or gyratory pill	\$57.37
Ignition Oven Method (FM5-563)	Per asphalt content	\$137.09
Max specific gravity (FM1-T209)	Per average of two flasks	\$139.19
Superpave Gyratory Compaction (AASHTO T312-04)	Per pair of gyratory pills	\$107.00
Ignition Oven (FM 5-563) and Mechanical Analysis (FM1-T030)	Per gradation	\$207.50
Soil Lab		
Test Name	Quantity	Test Cost
Consolidation (AASHTO T 216)	Per sample	\$353.90
Direct Shear (AASHTO T 236)	Per sample	\$301.11
Dry Gradation (AASHTO T 27)	Per sample	\$71.39
Hydrometer (AASHTO T 88)	Per sample	\$132.98
LBR (FM 5-515)	Per sample	\$349.84
Liquid Limit (AASHTO T 89)	Per sample	\$57.01
Modified Proctor (AASHTO T 180)	Per sample	\$132.70
Moisture Content (AASHTO T 265)	Per sample	\$16.37
Organic (AASHTO T267)	Per sample	\$42.95

(3) Reporting Cost of Resolution Testing in PrC

User-Generated Dollar-Based Item Adjustments

Advanced Showing 1 of 1

Select Project Items...
0 marked for deletion | 0 changed

Proj Item Num - Proj/Category	Item Description	Amount	
0085 - TR1E6915201/0200	ASPHALT CONCRETE FRICTION COURSE,TRAFFIC B, FC-9.5, PG	-284.40	▼
Adj ID	Type	Other Item Adjustment Type	Comments
0002	Other Item Adj	RTC - Resolution Testing Costs	Course aggregate gradation resolution test for

Type ▼
Other Item Adjustment

Other Item Adjustment Type * ▼
RTC - Resolution Testing Costs ▼

Amount ▼

Work Order Discovery Date ▼

Comments ▼

Function
Dollar-Based

Last Updated By
dotlcn982au

Last Updated Date
10/19/2022 10:39:58 AM

▼ **Additional Item Information**

Reference Item Code	Unit of Measure
0337 7 80	TN
Contract Item Line Number	Unit Price
0120	130.00000
Supplemental Description	
<input type="text"/>	

Within the Remarks window, specify what the test was for. In this case, it is 'Coarse Aggregate Gradation Resolution Test for Lot 6'. The cost of the Resolution Testing will be determined by the Materials Office as shown in the email in [Attachment 11-4-5, Example \(1\)](#).

Section 11.5

TESTING AND CORRECTING ASPHALT PAVEMENT SURFACE DEFICIENCIES

11.5.1 Purpose

To provide a uniform procedure for determining that the last structural layer meets the applicable straightedge requirements, before permitting the Contractor to place the friction course, and ensure the quality of smoothness of friction course meets **Florida Department of Transportation (FDOT) Specification** requirements. Examples of how to calculate pay deductions for surface deficiencies are also shown.

11.5.2 Authority

Sections 20.23(3)(a) and 334.048(3) Florida Statutes (F.S.)

11.5.3 References

Federal-Aid Policy Guide (FAPG), 23 CFR, Chapter I, Subchapter G – Engineering and Traffic Operations, Part 637 - Construction Inspection and Approval
Section 330, Standard Specifications for Road and Bridge Construction

11.5.4 General

The FDOT's intent is for the friction course to be uniform thickness and not rut, distort, or ravel. Therefore, it is necessary to determine the smoothness of the surface upon which the friction course will be placed, as well as, ensure the friction course meets the surface acceptance tolerances established in the **FDOT Specifications**. It is the Contractor's responsibility to perform the straightedge testing and take any action required to correct surface irregularities. For limited access or other high-speed roadways with a design speed of 55 miles per hour or greater, the Department will perform the smoothness acceptance testing on the friction course using a laser profiler and provide a test report to the Project Administrator (PA). Based on the laser profiler test report, and other related **Specification** requirements, the Contractor is responsible for correcting surface irregularities.

11.5.5 Verification

11.5.5.1 15 Foot Rolling Straightedge Testing

(A) Resident Level Responsibilities

Perform straightedge testing on the last structural layer and on the friction course in accordance with **Specification Article 330-9.4**. Straightedge testing may be performed either behind the final roller of the paving train or as a separate operation after completion of the last structural layer and after completion of the friction course. Straightedging will be performed by a Contractor's Paving Level 1 or Level 2 Technician, qualified under the Construction Training and Qualification Program (CTQP). The Contractor will notify the Department of the location and time of testing a minimum of 48 hours before beginning testing. A standard 15-foot rolling straightedge will be used. The procedures are as follows:

- (1) A CTQP Qualified Asphalt Paving Verification Technician Level 2 (VT-2) representing the Department will be present and accompany the Contractor's employee operating the rolling straightedge. Calibration of the 15-foot rolling straightedge shall be performed in accordance with **FM 5-509 Measurement of Pavement Smoothness with the 15-Foot Rolling and Manual Straightedges** and visually reviewed and verified before each testing day.
- (2) The VT-2 will continuously observe the indicator for highs and lows in excess of 3/16 inch and monitor the Contractor's Paving Level 1 or Level 2 Technician recording the locations and magnitude of each out-of-tolerance deficiency. The contractor's employee will mark the location on the pavement with spray paint or other marking method. The **Daily Report of Construction, Form No. 700-010-13**, will reflect this inspection.
- (3) After the straightedging operation, the Contractor shall enter the straightedge test results in the Department's **Materials Acceptance and Certification system (MAC)** database. The VT-2 will provide their Technician Identification Number (TIN) on the QC Sample in the Witnessed by TIN field to document the verification review of the QC data, and finalize the QC sample as the PA's designee.
- (4) Straightedge Deficiencies are automatic Materials Certification Review findings in **MAC**. They are promoted as a **Materials Acceptance Resolution (MAR)** in **MAC** by the Materials Certification Review Program Maintenance User. The PA will discuss Contractor's proposed correction method with the District Pavement Materials Engineer (DPME) and approve or disapprove the proposed method. If the

proposed method is not approved, the PA shall require the Contractor to resubmit their correction plan. The PA may propose waiving the corrections and pay deductions if the deficiencies are caused by manholes, valve boxes, intersections, etc. that are beyond control of the Contractor. If the District proposes leaving a deficiency in place at full pay, approval of the District Construction Engineer (DCE) must be obtained before notifying the contractor. Upon request of the DPME, the PA will provide a copy of the verified straightedging report for their use.

- (5) The VT-2 shall be present during the corrective work and will verify each surface deficiency was eliminated or brought within the allowable tolerance as established in the **FDOT Specifications**. The corrective work will be reported on the **Daily Report of Construction**.
- (6) Resolution of the deficient area(s) will be handled in accordance with **CPAM 11.5.6**.

11.5.5.2 Laser Profiler Testing

(A) Resident Level Responsibilities

In accordance with **CPAM 11.5.5.1**, the Contractor's CTQP Qualified Paving Level 1 or Level 2 Technician shall perform the 15-foot rolling straightedge testing on the last layer of structural course and on the friction course either behind the final roller of the paving train or as a separate operation. In accordance with **Specification Section 330-9.4.5**, after correction of all deficiencies on the last structure course and on the friction course, the procedures for the Laser Profiler testing on friction course specified in **330-9.4.6.2** are as follows:

- (1) The PA will request a pavement evaluation in MAC as a sample login to notify the Pavement Evaluation Section (PES) of State Materials Office (SMO) or the District Materials and Research Office (DMRO) responsible for the Laser Profiler testing a minimum of 14 calendar days before the estimated date for friction course smoothness acceptance testing. In the event the estimated date is revised, the PA will inform the SMO PES or the DMO about the updated information as soon as possible. Detailed instructions to submit a pavement evaluation request in MAC can be accessed through the following link:
<http://www.fdot.gov/materials/mac/training/>
- (2) The Laser Profiler test team will inform the PA about the date of their arrival to the project site and the PA will inform the Contractor to clean the pavement if it is needed and will provide necessary assistance to the test team in order to facilitate

the Laser Profiler testing on the project site. Guidelines for limitations on Laser Profiler testing are as follows: (a) Design speed is less than 55 miles per hour, (b) Bridges approaches and departures, project beginning and endings and segment less than 0.01 mile (52.8 feet), (c) Railroad crossings, (d) Ramps turn lanes, acceleration and deceleration lanes, (e) Areas where the design speed is greater than or equal to 55 miles per hour, that have signalized intersections which affect the consistent speed of the testing vehicle. Those intersections including areas before and after the signalized intersections are not considered suitable for Laser Profiler testing. The exact areas suitable for Laser Profile testing will be determined on the project by the Laser Profiler operator depending on the situations created by these intersections. There are some projects with design speed greater than or equal to 55 miles per hour that have signalized intersections, but the project site conditions allow Laser Profiler testing vehicle to operate at consistent speed. Under this situation, the project shall be tested by Laser Profiler.

- (3) Upon completion of the Laser Profiler testing, the Laser Profiler test team will furnish a copy of the **Laser Profiler Test Report** to the PA and DMRO within 7 calendar days.
- (4) Should the **Test Report** indicate any deficiencies, the PA will notify the Contractor and the Contractor shall perform corrections in accordance with **FDOT Specification Article 330-9**. Straightedge Deficiencies are automatic Materials Certification Review findings in **MAC**. They are promoted as a **MAR** in **MAC** by the Materials Certification Review Program Maintenance User. The PA will discuss Contractor's proposed correction method with the DPME and approve or disapprove the proposed method. If the proposed method is not approved, the PA shall require the Contractor to resubmit their correction plan. The PA may propose waiving the corrections and pay deductions if the deficiencies are caused by manholes, valve boxes, intersections, etc., if they are beyond control of the Contractor. However, if the District proposes leaving a deficiency in place at full pay, approval of the DCE must be obtained before notifying the contractor.
- (5) In consideration of the safety and traffic control operations, the PA may approve a Contractor's request to use the QC results of 15 foot rolling straightedge testing as a reference for correction actions after the completion of Laser Profiler testing. However, under this situation, the 15 foot rolling straightedge shall be performed in accordance with **CPAM 11.5.5.1(3)** in both wheel paths behind the final roller of the paving train and shall be verified by the VT-2.
- (6) The Department will monitor/ verify Contractor's corrective work in accordance with

CPAM 11.5.5.1(4) and document the results in accordance with **CPAM 11.5.5.1(4) and (6)**. The resolution of the deficient area(s) will be handled in accordance with **CPAM 11.5.6**.

A flow chart (titled, "Acceptance Testing Process for Pavement Smoothness by Laser Profiler") is attached to indicate the process of acceptance testing for pavement smoothness by Laser Profiler.

Note: Per the Specifications, on Laser Profiler projects (Design Speed 55 mph and greater) the contractor may elect to have Laser Profiler testing of the friction course performed before conducting straightedge testing. In such cases, they would only have to straightedge areas identified by the laser profiler data as having a ride number less than 3.5 and correction of the friction course would occur after Laser Profiler and straightedge testing is performed.

11.5.6 Resolution

Note: Straightedge deficiencies waived in accordance with **Specification 330-9.4.5** require DCE approval. The resolution of the material acceptance is documented in **MAC** as part of the Materials Certifications Review process.

(A) Resident Level Responsibilities

- (1) If the Contractor proposes to leave the deficient area(s) in place at No Pay, the PA must obtain the recommendation of the Resident Engineer (RE) and the DPME and approval of the DCE prior to notifying the Contractor of such approval. If the Contractor requests to leave the deficient area(s) in place at Full Pay, the PA must obtain the concurrence of the RE, DPME, and DCE before notifying the Contractor of the decision.
- (2) If the Contractor plans to use corrective methods other than method (a) Removing and Replacement or method (b) Milling, as specified in **FDOT Specifications Section 330**, a written request for approval of the proposed methods must be submitted to the PA. The PA will send the Contractor's request along with the list of surface irregularities to the DPME and DCE, requesting comments and recommendations.
- (3) The PA will approve or disapprove the Contractor's request for corrective action based on the DPME's and the DCE's comments and recommendations. The PA may rescind any approval if satisfactory acceptance test results are not being

achieved.

- (4) Regardless of the corrective method approved and used by the Contractor, the VT-2 shall be present during the corrective work and will verify that each surface irregularity was eliminated or brought within the allowable specification tolerance. The corrective work will be reported on **Form No. 700-010-13, Daily Report of Construction**. One or more follow-up QC samples Witnessed by the VT-2 must be entered into MAC to document that the original deficiencies have been addressed. The VT-2, as the PA's designee, shall include the MAC Sample Id(s) on the MAR finding.
- (5) Upon verifying all corrections have been made, the PA will notify the Contractor in writing about the Engineer's determination of pavement surface acceptance with copies to the DCE and the DPME.
- (6) The RE, or the RE's designee, will document their recommended resolution in **MAC** on the **MAR**.

(B) District Level Responsibilities

- (1) If the Contractor proposes to leave the deficient area(s) in place at Full Pay and states the reason for doing so, the DPME and the DCE shall provide their recommendations. **Note:** Straightedge deficiencies waived in accordance with **FDOT Specification 330-9.4.5** require DCE approval.
- (2) The DPME will document their recommended resolution on the **MAR**.
- (3) The DCE will document their recommended resolution on the **MAR**.

11.5.7 Straightedge Deficiencies Documentation and Adjustments

Straightedge deficiencies can occur in structural courses and friction courses.

Straightedge Deficiencies are either:

- (1) Corrected (removed and replaced) at no cost to the Department
- (2) Left in place at No Pay or Full Pay.

1. Straightedge Deficiencies that are corrected (Removed and Replaced)

The defective surface will be removed and replaced with an acceptable surface at no additional cost to the Department in accordance with ***FDOT Specifications Article 330-9***. The asphalt used for correcting straightedge deficiency will be shown as a “Straightedge Correction” on the ***Asphalt Roadway - Daily Report of Quality Control***.

(A) Deficiencies when LOT’s are still open:

Tests will be performed on the asphalt used for straightedge corrections when a random number occurs. The area(s) to be corrected will need to be shown on the ***Asphalt Roadway - Daily Report of Quality Control*** in the LOT the asphalt is produced in. The amount of material used to correct these deficiencies will be shown on the ***Asphalt Roadway - Daily Report of Quality Control*** as a “Straightedge Correction”.

(B) Deficiencies when LOT’s are closed:

If the Straightedge deficiencies are corrected after all LOT’s are closed, a new LOT will not be opened, and no QC material tests are required. The asphalt used for correcting the straightedge deficiency shall be reported on the last ***Asphalt Roadway - Daily Report of Quality Control*** for that mix type (structural or friction).

Note: Report the asphalt as a “Straightedge Correction” to ensure the asphalt is not paid for within the LOT. Straightedge corrections are shown on the ***Asphalt Roadway - Daily Report Of Quality Control*** in order to document that the straightedge corrections were made. The original ***Asphalt Roadway - Daily Report of Quality Control*** showing where the deficient areas were first paved do not need to be revised.

2. Straightedge Deficiencies that are Left in Place at No Pay or Full Pay

(A) Deficiencies Left in Place at No Pay

If the PA determines to leave the asphalt in place at No Pay, approvals from the RE, DPME, and DCE are needed before notifying the Contractor of the decision. The tonnage

to be deducted is calculated per **FDOT Specification 330-9.5** (examples shown below). The PA will complete the “Guidance Document” shown in **Attachment 11-5-A** and submit it with the **Final Estimates Documentation**.

(B) Deficiencies Left in Place at Full Pay

If the Contractor requests to leave the deficient area(s) in place at Full Pay, the PA must obtain approval from the RE, DPME, and DCE before notifying the Contractor of the decision. The PA will complete the “Guidance Document” shown in **Attachment 11-5-A** and submit it with the **Final Estimates Documentation**.

Note 1: For straightedge deficiencies left in place at Full Pay, no changes are required to the original asphalt’s Bituminous Adjustments or Fuel Adjustments.

Note 2: For straightedge deficiencies left in place at No Pay, no changes are required to the asphalt’s Bituminous Adjustments or Fuel Adjustments.

Note 3: The CPF will not be affected in any case.

Pay Item Reduction Calculations

The Department will calculate the pay item reduction in accordance with **FDOT Specifications Section 330-9.5.2**. The pay item reduction is based on the quantity of material the Contractor would have removed and replaced had the correction been made. The quantity is determined by the following equation:

$$\text{Quantity (tons)} = L \times W \times t \times G_{mm} \times 0.0024$$

Where:

L = Total Length (ft.)

The total length (L) is the deficient length that is extended 50 ft. on each side of the deficiency

W= Width (ft.)

t = Thickness (inches)

G_{mm} – Maximum Specific Gravity of the Asphalt Mix

The constant 0.0024 = 43.3 Lbs/SY divided by 9 SF/SY, divided by 2000 Lbs/Ton

For FC-5 only (Open-Graded Friction Course), a different equation is used. The length and width are multiplied by a constant equal to 0.0044. The constant of 0.0044 is based on an FC-5 spread rate of 80 Lbs/SY, divided by 9 SF/SY, divided by 2000 Lbs/Ton.

Quantity (Tons) = $L \times W \times 0.0044$ (equation for FC-5 only)

Where:

L= Total Length (ft.)

The total length (L) is the deficient length that is extended 50 ft. on each side of the deficiency, per Specifications.

W= Width in (ft.)

t = Thickness (inches)

The constant 0.0044= 80 Lbs/SY divided by 9 SF/SY, divided by 2000 Lbs/Ton

EXAMPLE 1:

Deficiency Length = 10 ft.

Width = 12 ft.

Thickness is 1.5 inches

$G_{mm} = 2.417$

Total Length = Deficiency Length plus 50 ft. on each side, therefore;

Total Length = 10 ft. + 50 ft. + 50 ft. = 110 ft.

Quantity (Tons) = $L \times W \times t \times G_{mm} \times 0.0024$

Quantity (Tons) = $110 \times 12 \times 1.5 \times 2.417 \times 0.0024 = 11.48$ Tons = 11.5 Ton deduction

Note: Situations can occur where the extension of the deficiency is less than 50 ft. This can occur at the beginning or ending of a project, beginning of a bridge approach slab, etc. For example: if the deficient length is 5 ft., and one side of the extension is 50 ft. and the other is 30 ft., the total deficient length is 85 ft. The equation to determine the quantity would be as follows:

Quantity (Tons) = $L \times W \times t \times G_{mm} \times 0.0024$

Quantity (Tons) = $85 \times 12 \times 1.5 \times 2.417 \times 0.0024 = 8.88$ Tons = 8.9 Ton deduction

EXAMPLE 2:

Deficient Length = 10 ft.

Width = 12 ft.

Total length = Deficiency length plus 50 ft. on each side, therefore;

Total deficient length = 10 ft. + 50 ft. + 50 ft. = 110 ft.

Quantity (Tons) = $L \times W \times 0.0044$ (equation for FC-5 only)

Quantity (Tons) = $110 \times 12 \times 0.0044 = 5.81$ Tons = 5.8 Ton deduction

FLOW CHART

Acceptance Testing Process for Pavement Smoothness by Laser Profiler

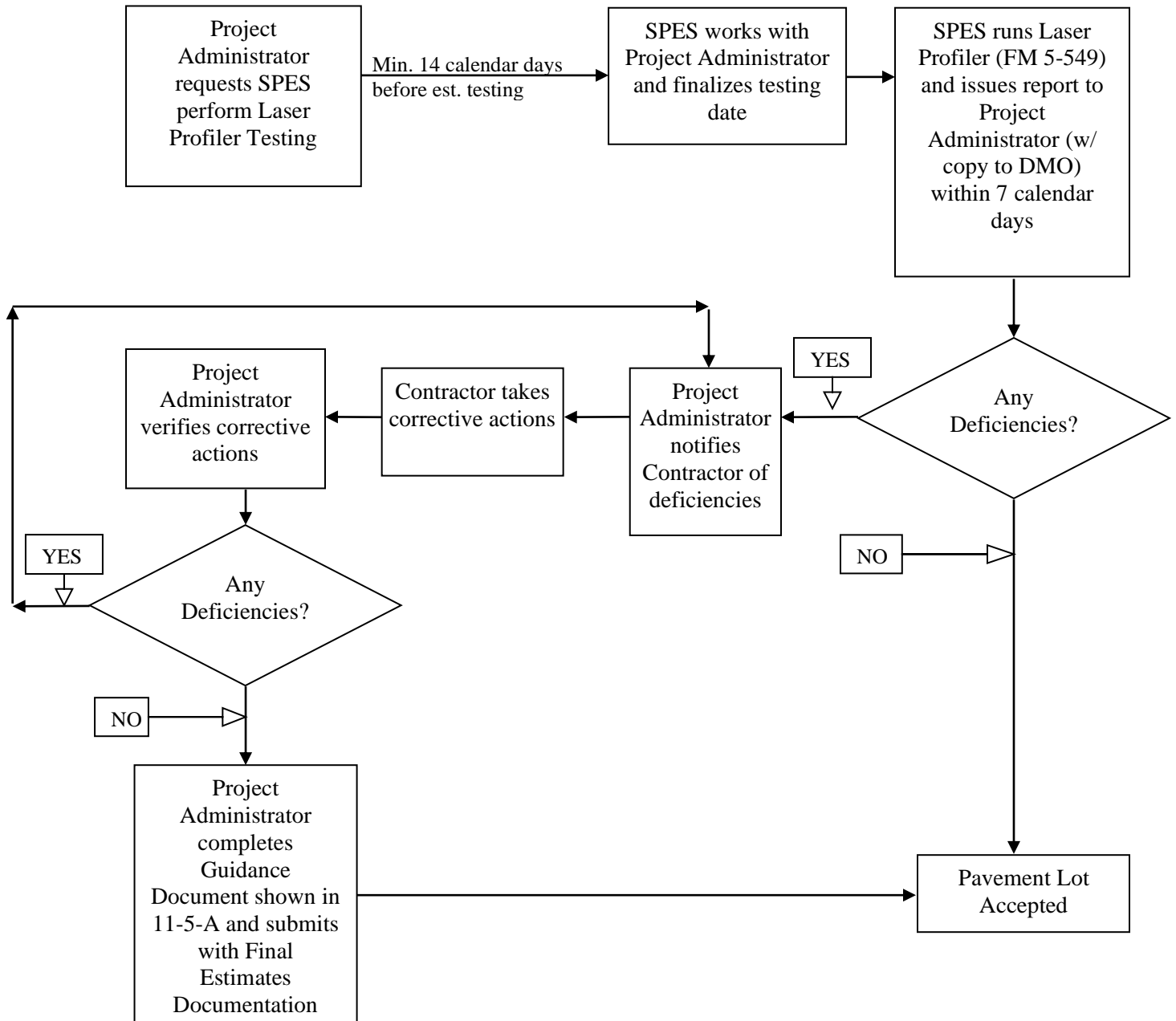

ATTACHMENT 11-5-A
Guidance Document 11-5-A

Recommended Format for Deficiencies				
LOT #	Sta. From (MP)	Sta. To (MP)	Deficiencies by Laser Profiler (RN) or Straightedge (inch)	Action Taken

1. Options for Action Taken entry:
 - a. Remove and Replace
 - b. Leave in place at No Pay
 - c. Leave in place at Full Pay

Section 11.6

DOCUMENTATION FOR MULTIPLE FINANCIAL IDENTIFICATION NUMBER (MULTI-FIN) PROJECTS UNDER ONE CONTRACT

11.6.1 Purpose

This procedure provides examples for calculating and documenting asphalt quantities of the same pay item, appearing on multiple financial projects under one Contract for Conventional, Lump Sum, and Design Build Projects.

11.6.2 Authority

Sections 20.23(3)(a) and 334.048(3), Florida Statutes (F.S.)

11.6.3 Multi-FIN Projects Under One Contract (Same Pay Item)

(A) Contractor Responsibilities

Report all asphalt produced and accepted on the lead FIN on **Form 675-030-20A, Asphalt Roadway – Daily Report of Quality Control-Automated Version** (known as the **QCRR**) and **Form 700-050-66 - Contractor’s Certification of Quantities Asphalt Mixes with Modified and Unmodified Binders**. When the same pay item appears on a multi-FIN contract with different unit prices assign an alternate pay item number on the QCRR to separate the quantity for each unit price.

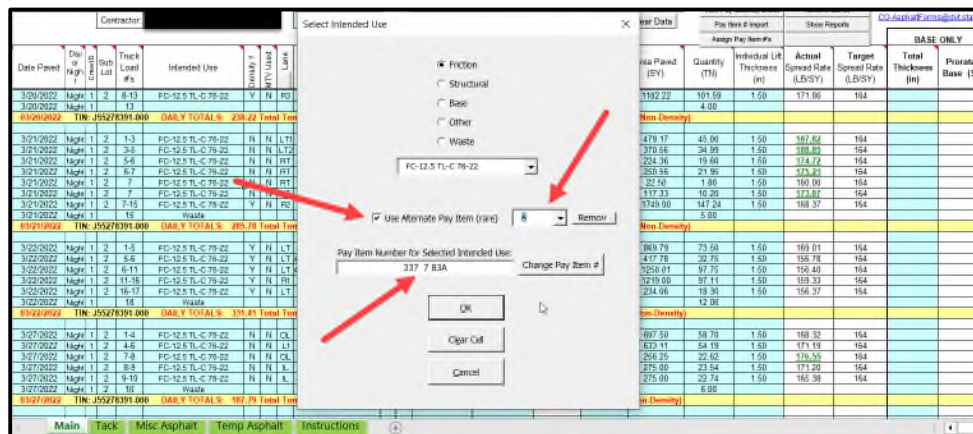

Place a note in the Comments Box to communicate the alternate pay item to the Project Administrator for calculating prorated quantities.

Comments Box: Note: The box below is now locked. To enter comments, click the cell in Column A next to the row that needs the comment.
1) 11/4/2022 Day Shift - Crew #1: Used SPM FC 12.5 TL-C PG76-22 in lieu of SP 12.5 TL-B PB76-22
2) 11/4/2022 Day Shift - Crew #1: These areas labeled as "No Pay Tonnage" are outside of the extended project limits and are to be paid for by Superior.
3) 11/4/2022 Day Shift - Crew #1: An alternate pay item was used to separate tonnage with a different unit price
4) 11/4/2022 Day Shift - Crew #1: Placed 2 lifts on 11-3-22 in lot 2
5) 11/5/2022 Day Shift - Crew #1: Two lifts were already placed on line 33 & 35 due to contractor undercutting the subgrade.
6) 11/5/2022 Day Shift - Crew #1: Wasted due to asphalt getting rained on and starting to clump.

(B) Resident Office Responsibilities

Prorate the pay item breakout using the quantities for each FIN shown in AASHTOware Project Construction (PrC). Divide each FIN's pay item quantity by the total contract pay item quantity, and multiply this amount by the total quantity placed and accepted during the month for each project (see [Example 1](#)). Report the prorated quantities in PrC monthly after the estimate cutoff based on the accepted Contractor's Certification of Quantities.

NOTE 1: Breakout the quantities for each FIN monthly to ensure the bituminous adjustments are proportionally distributed for each project during the period the asphalt was produced and accepted. Apply composite pay factor (CPF) adjustments during the month when the lot is closed out. See **CPAM 11.4.11, Attachment 11-4-4(6)**, for CPF calculations for multi-FINs under one Contract.

NOTE 2: Prorate deficiencies and deductions when you have multi-FINs under one Contract.

EXAMPLE 1:

What is the quantity of asphalt reported for Project A and Project B for the following pay items?

- Pay Item 334-1-12(Superpave Asphaltic Concrete, Traffic Level B, Tons)
- Pay Item 285-710 (Optional Base, Group 10, Square Yards (SY))
- Pay Item 337-7-88 (Asphaltic Concrete Friction Course, Traffic Level E, Tons)

For Project A:

Pay Item 334-1-12 Quantity = 10,550.5 Tons
Pay Item 285-710 Quantity = 17,754 SY
Pay Item 337-7-88 Quantity = 9,452.5 Tons

For Project B:

Pay Item 334-1-12 Quantity = 21,395.5 Tons
Pay Item 285-710 Quantity = 19,632 SY

CONTRACT QUANTITY:

Pay Item 334-1-12 Contract Quantity = 31,946.0 Tons
Pay Item 285-710 Contract Quantity = 37,386 SY
Pay Item 337-7-88 Contract Quantity = 9,452.5 Tons

Quantity Placed this Month:

Pay Item 334-1-12 = 4,359.6 Tons
Pay Item 285-710 = 23,434 SY
Pay Item 337-7-88 = 3,256.6 Tons

HINT: Pay Item 337-7-88 is only on project A.

Project A:

Pay Item 334-1-12:

The quantity is determined by dividing the total tonnage for Project A (10,550.5 Tons) by the total tonnage for the entire contract (31,946.0 Tons) and multiplying by the tonnage for the month (4,359.6 Tons).

$$\left(\frac{10,550.5 \text{ Tons}}{31,946.0 \text{ Tons}}\right) (4,359.6 \text{ Tons}) = 1,439.8 \text{ Tons}$$

Pay Item 285-710:

The quantity is determined by dividing the total Square Yards for Project A (17,754 SY) by the total SY for the entire contract (37,386 SY) and multiplying by the SY for the month (23,434 SY)

$$\left(\frac{17,754 \text{ SY}}{37,386 \text{ SY}}\right) (23,434 \text{ SY}) = 11,128 \text{ SY}$$

Pay Item 337-7-88:

Since this pay item is available only on Project A, the quantity of 3,256.6 Tons will be paid on Project A only.

Project B:

Pay item 334-1-12:

The quantity is determined by dividing 21,395.5 Tons by 31,946.0 and multiplying by 4,359.6.

$$\left(\frac{21,395.5 \text{ Tons}}{31,946.0 \text{ Tons}}\right) (4,359.6 \text{ Tons}) = 2,919.8 \text{ Tons}$$

Double check that the sum of the prorated quantities equals the total placed this month.

Total Tonnage for Pay Item 334-1-12 = 1,439.8 + 2,919.8 = 4,359.6 Tons

Pay Item 285-710:

The quantity is determined by dividing 19,632 SY by 37,386 SY and multiplying by 23,434 SY

$$\left(\frac{19,632 \text{ SY}}{37,386 \text{ SY}}\right) (23,434 \text{ SY}) = 12,306 \text{ SY}$$

Double check that the sum of the prorated quantities equals the total placed this month.

Total SY for Pay Item 285-710 = 11,128 + 12,306 = 23,434 SY

11.6.4 Multi-FIN Projects, Under One Contract, Including Federal Aid Participating (Participating) and Non-Federal Aid Participating (non-Participating)

(A) Contractor Responsibilities

Report all asphalt produced and accepted on the lead FIN on the *QCRR* and the *Certification of Quantities*, including asphalt on non-participating projects. When a pay item (or pay item with a different unit price) appears on only one FIN, assign it to an alternate pay item number on the *QCRR* to exclude it from the other pay items. Place a note in the Comments Box to communicate the alternate pay item to the Project Administrator for calculating prorated quantities as shown in [Section 11.6.3\(A\)](#).

(B) Resident Office Responsibilities

Prorate the pay item breakout by dividing each FIN's contract total pay item quantity by the total contract pay item quantity, and multiply this amount by the total pay item quantity placed (see [Example 2](#)). Report the prorated quantities in PrC monthly after the estimate cutoff based on the accepted *Contractor's Certification of Quantities*

The same prorating principle applies as explained in [Section 11.6.3\(B\)](#).

EXAMPLE 2:

What is the quantity of asphalt reported for Project A and Project B, for the Participating and non-Participating portions? This example has one pay item.

For Project A:

Federal Aid Participating quantity = 5,963.0 Tons
Federal Aid non-Participating quantity = 4,326.0 Tons

For Project B

Federal Aid participating quantity = 23,689.0 Tons
Contract Quantity = 33,978.0 Tons

Tons placed this month = 4,359.3 Tons

The Federal Aid Participating portion of Project A is determined by dividing the total tonnage for the Federal Aid Participating portion of Project A (5,963.0 Tons) by the total tonnage for the entire contract (33,978.0 Tons) and multiplying by the tonnage for the month (4,359.3 Tons).

$$\left(\frac{5,963.0 \text{ Tons}}{33,978.0 \text{ Tons}} \right) (4,359.3 \text{ Tons}) = 765.0 \text{ Tons}$$

The non-participating portion of Project A is determined by:

$$\left(\frac{4,326.0 \text{ Tons}}{33,978.0 \text{ Tons}} \right) (4,359.3 \text{ Tons}) = 555.0 \text{ Tons}$$

Project B is determined by:

$$\left(\frac{23,689.0 \text{ Tons}}{33,978.0 \text{ Tons}} \right) (4,359.3 \text{ Tons}) = 3,039.2 \text{ Tons}$$

Double check that the sum of the prorated quantities equals the total placed this month.

$$\text{Total Tonnage} = 765.0 + 555.0 + 3,039.2 = 4,359.2 \text{ Tons}$$

NOTE 3: The 0.1 Ton difference is due to rounding. The Project Administrator should agree to pay 3,039.3 Tons on project B.

Section 11.7

ASPHALT CONSTRUCTION INFORMATION FOR CONTRACTOR QUALITY CONTROL

11.7.1 Purpose

The purpose of this procedure is to describe the Department's role when reviewing and verifying Contractor Quality Control (QC) documentation, establishing waste asphalt quantities, and processing Resolution Reports for Asphalt Concrete (AC), Gradation, and Density Cores.

11.7.2 Authority

Sections 20.23(3)(a) and 334.048(3), Florida Statutes (F.S.)

11.7.3 Department's Verification of Quality Control Documentation

The Resident Office (RO) is responsible for ensuring the information submitted in the Asphalt Roadway – Daily Report of Quality Control (QCRR) is accurate. The Engineer is responsible for reviewing and randomly checking the quantities submitted by the QC Technician. The Engineer will receive Form 675-030-20A, the QCRR - Automated Version - from the Contractor. In addition, the Engineer will collect all asphalt tickets associated with the report. The Engineer is to ensure that the tickets for each day's production match the report.

Each Contractor is required to record the placement of asphalt on the Contractor's **Quality Control-Roadway Report (QCRR), Form 675-030-20A – Automated Version** as the pavement operation progresses.

Projects let July 2015 or after must use the latest version of **Form 675-030-20A - Automated Version**. Corrections will be made by the contractor's QC personnel within the spreadsheet once an error is detected. Make a notation of the correction in the "Comments" section in PrC. See [Attachment 11-7-3](#).

11.7.4 Contractor and Department – Waste Asphalt Quantity Determination

It is not necessary for the Contractor's truck driver to return to the plant to determine the quantity of "Waste" asphalt remaining in the truck. The Contractor's QC Technician and the Department's Verification Technician (VT) should concur on the estimated amount left in the truck based on one of the following methods:

(A) Spread Rate

Example:

Determine the waste tonnage with the following information:

- Last load of Asphalt = 21.35 Tons (from Ticket)
- Spread rate on the project = 75 Lbs/SY
- The paved area = 430 SY

$$\begin{aligned}\text{Tonnage Used} &= \frac{(\text{Spread Rate (Lbs/SY)}) (\text{Area Paved (SY)})}{2,000 \text{ Lbs/Ton}} \\ &= \frac{(75 \text{ Lbs/SY})(430 \text{ SY})}{2,000 \text{ Lbs/Ton}} \\ &= 16.125 \text{ Tons}\end{aligned}$$

$$\begin{aligned}\text{Waste Tonnage} &= \text{Original Quantity} - \text{Quantity Used} \\ &= 21.35 - 16.125 = 5.2 \text{ Tons}\end{aligned}$$

(B) Visual Inspection

A visual inspection of the remaining asphalt in the truck estimated to the nearest $\frac{1}{4}$ of a truck load.

Example:

$\frac{1}{4}$ of a truck load was remaining, which is approximately 5.3 Tons

$$\text{Waste Tonnage} = \frac{\text{Ticket Tonnage}}{4} = \frac{21.35}{4} = 5.3 \text{ Tons}$$

11.7.5 Resolution Reports for AC Content, Gradation, and Density Cores

When the QC Technician's test results and the Department's VT's test results do not compare for a specified test, the QC test results are not verified. Therefore, Resolution Tests (RT) for all sublots in the LOT must be run for each property that does not compare. These RT results are then compared to the QC test results.

If the RT results compare to the QC test results, accept and pay on QC Test results.

If the QC Test Results do not compare (even if only one subplot QC and RT do not compare), accept and pay on RT report results. The cost of the Resolution Testing performed by the Department, that do not favor the QC test results, will be deducted from the Contractor's next progress estimate. The District Materials Office will provide the resolution results to the Project Administrator (PA) via email. Submit this email as backup documentation to support the deduction. See [Attachment 11-7-1](#), for an example of an e-mail from the District Materials Office to the PA with the number of resolution tests and costs.

Note: For FC 5 (Open Graded Friction Course), only AC Content and Gradation tests are subject to resolution testing.

See the State Materials Office Website under ["Documents and Publications"](#) for the latest resolution testing costs. These testing costs can be found under "Resolution Testing Costs for Contracts Let..." See [Attachment 11-7-2](#), for an example of Resolution Testing Costs and [Attachment 11-7-3](#) for an example of reporting the cost of resolution testing in AASHTOWare Project Construction (PrC).

Attachment 11-7-1
E-Mail from District Material's Office to the PA with No. of Tests and Costs

Daniel Day

From: Daniel Day
Sent: Thursday, May 21, 2015 @ 2:49 PM
To: Howard Jump (howard.jump@dot.state.fl.us)
Cc: J. Corley; Bill Blass; etc., etc.
Subject: FIN # 41109815201 LOT 6 Resolution Results

Howard,

Attached are the Resolution results for LOT 6 on the above-mentioned project. The Resolution results **DO NOT** compare with QC results. Therefore, acceptance and payment for the LOT with respect to density will be based on Resolution results.

Cost for the Resolution testing should be deducted from the monthly estimate (see below).

For each subplot, the Resolution results for average Roadway Gmb should replace the QC results for average Roadway Gmb, and most likely change the density value, Individual Pay Factor, and the Composite Pay Factor. Any new values should be compared to the Master Production Range as well as the criteria of 334-5.9.5 to determine acceptance.

- Please do not approve the QC or RT samples for this LOT. The resolution lab will approve these samples.
- Resolution cost (- \$31.60 per core x 9 cores = - \$ 84.40)

Thanks
Daniel Day
Assistant District Bituminous Manager
Florida Department of Transportation
100 N. Day Road (MS 20)
Deland, Florida 33333
380-555-5550(fice)

Attachment 11-7-2 Resolution Testing Costs on Website

The cost of resolution testing, if performed by the Department and favors the VT results, will be deducted from the Contractor’s next progress estimate.

The resolution testing fees are based on the year the Contract was let. For example, if a Contract was let in January 2010 and a resolution test was done in January 2011, the January 2010 year pricing index would be used.

The cost of the testing can be found at the following URL within the ‘Resolution Testing Costs for Contracts Let Between...’ link.

<https://www.fdot.gov/materials/navigation/documents.shtm>

Florida Department of Transportation Resolution Testing Costs Year 2021-2022 Rates		
Bituminous Lab		
Test Name	Quantity	Test Cost
Bulk specific gravity of Compacted Bituminous Mixtures (FM 1-T166)	Per roadway core or gyratory pill	\$52.62
Ignition Oven Method (FM5-563)	Per asphalt content	\$137.09
Max specific gravity (FM1-T209)	Per average of two flasks	\$152.94
Superpave Gyratory Compaction (AASHTO T312-04)	Per pair of gyratory pills	\$170.47
Ignition Oven (FM 5-563) and Mechanical Analysis (FM1-T030)	Per gradation	\$206.00
Soil Lab		
Test Name	Quantity	Test Cost
Consolidation (AASHTO T 216)	Per sample	\$349.74
Direct Shear (AASHTO T 236)	Per sample	\$263.30
Dry Gradation (AASHTO T 27)	Per sample	\$65.50
Hydrometer (AASHTO T 88)	Per sample	\$133.97
LBR (FM 5-515)	Per sample	\$348.63
Liquid Limit (AASHTO T 89)	Per sample	\$55.47
Modified Proctor (AASHTO T 180)	Per sample	\$121.60
Moisture Content (AASHTO T 265)	Per sample	\$16.21
Organic (AASHTO T267)	Per sample	\$42.53
Permeability (AASHTO T 215, ASTM 5084, FM 5-513)	Per sample	\$292.22
Plastic Index (AASHTO T 90)	Per sample	\$52.77
Specific Gravity (AASHTO T 100)	Per sample	\$76.05
Split Tensile (ASTM D 3967)	Per sample	\$131.15
Standard Proctor (AASHTO T 99)	Per sample	\$115.12
Triaxial (AASHTO T 297)	Per sample	\$471.57

Attachment 11-7-3 Reporting Cost of Resolution Testing in PrC

▼ User-Generated Dollar-Based Item Adjustments

🔍 Type search criteria or press Enter Advanced Showing 1 of 1

Select Project Items... 0 marked for deletion | 0 changed

Proj Item Num - Proj/Category	Item Description	Amount	
0085 - TR1E6915201/0200	ASPHALT CONCRETE FRICTION COURSE, TRAFFIC B, FC-9.5, PG	-284.40	▼

Adj ID	Type	Other Item Adjustment Type	Comments	WO Disco...
0002	Other Item Adj	RTC - Resolution Testing Costs	Course aggregate gradation resolution test for	

Type ▼
Other Item Adjustment

Other Item Adjustment Type ▼
RTC - Resolution Testing Costs

Amount ▼

Work Order Discovery Date ▼

Comments ▼

Function
Dollar-Based

Last Updated By
dotlcn982au

Last Updated Date
10/19/2022 10:39:58 AM

▼ Additional Item Information

Reference Item Code	Unit of Measure
0337 7 80	TN
Contract Item Line Number	Unit Price
0120	130.00000
Supplemental Description	

Asphalt Construction Information for Contractor Quality Control

11-7-6

Section 11.8

SUBMITTALS

The information previously included in this Section has been incorporated into:

- ***CPAM 11.1 (Asphalt LOT Documentation)***
- ***CPAM 11.4 (Adjustments)***
- ***CPAM 5.14 (Field Records and Contractor's Certifications)***

Section 11.9

SALVAGE OF MATERIALS

11.9.1 Purpose

This procedure provides instruction for delivering excess or salvageable material to Department Maintenance Offices and the Final Estimates Documentation requirements.

11.9.2 Authority

Sections 20.23(3)(a) and 334.048(3), Florida Statutes (F.S.)

11.9.3 Excess Material

Excess material is when the Department has paid for new, unused material as part of a pay item, but it is not needed on the project in which it was paid (example: cutoff piling).

Contact the District Maintenance Office or District Operations Office to verify the need for excess material prior to delivery.

11.9.4 Salvageable Materials

Salvageable material is used material the Department has identified as reusable for future projects (examples: milled material or guardrail). When material has been identified by the Department as salvageable, the contract plans will provide the following:

- (A) Delivery Location
- (B) Contact Information for Delivery
- (C) Description of material
- (D) Quantity of material

Verify the need for salvageable material with the contact personnel identified in the plans prior to delivery.

11.9.5 Receipt of Goods from Vendor

When excess material is identified or material is salvaged from the project and material is approved for delivery to the specified Maintenance yard, a signed **Receipt of Goods from Vendor** must be submitted with the Final Estimates Documentation. This receipt is

generated by the Maintenance yard after receipt of materials. Construction Engineering Inspection (CEI) staff must provide the receiving Maintenance yard with the following information for input into the ***Materials and Supplies Inventory (MSI) Application***:

- (A) Contractor's Federal Employee Identification Number (FEIN) – This is a 13-digit number located on the progress estimate followed by the Contractor's Company Name
- (B) Salvageable Material Value for "New" materials not incorporated into the project due to a contract change. See [Attachment 11.9-1](#).

NOTE: For delivery to other yards (non-FDOT), check your contract or plans for requirements.

11.9.6 List of Attachments

[Attachment 11.9-1](#)Receipt of Excess or Salvaged Materials Delivered to Warehouse

Attachment 11.9-1 Receipt of Excess or Salvaged Materials Delivered to Warehouse

FLORIDA DEPARTMENT OF TRANSPORTATION				
RECEIPT OF GOODS FROM VENDOR				
MSIB034	:			5/1/17 10.55.24
TCKT	:	5/1/2/17	TYPE: REGULAR RECEIPT	5/1/17
WHSE	:			
VENDOR #	:			
NAME	:			
			TOTAL COST.....
				0.0000
COMM		DESCRIPTION	QTY RECVD	UM RE
				UNIT PRICE
RESERVED:	.000	AVAILABLE	.000	TOT ON HAND: .000
BACKORDER:	.000			WHSE ORDER: .000
RECEIVED BY:				VERIFIED BY:
PF1-Menu, PF2-Verify, PF5-Receive, Pf6-Another, PF8- Another (same vend # & PO#)				

NOTE: The *Materials and Supplies Inventory (MSI) Application* within the State Maintenance Office is responsible for this form. Once the information is entered into the system (mainframe), a form like page is created (as seen above) for the receiver to sign for goods that will be delivered to the warehouse.

Section 12.1

PROJECT ACCEPTANCE

12.1.1 Purpose

To provide a uniform basis for granting Partial and Final Acceptance of a project.

12.1.2 Authority

Sections 20.23(3)(a) and 334.048(3), Florida Statutes (F.S.)

12.1.3 Reference

Sections 5-10, 5-11, 8-6 and 8-7, Standard Specifications for Road and Bridge Construction

12.1.4 Partial Acceptance

Resident Level Responsibilities

The Florida Department of Transportation may accept a portion of a project as defined in **Section 5-10 of the Standard Specifications**. Once the Department has accepted the project or a portion of the project, the Department shall provide written notice of Partial Acceptance to the Contractor. Partial acceptance on Projects of Division Involvement (PoDI) may also be required by the FHWA Transportation Engineer (TE) and should be coordinated accordingly.

12.1.5 Final Inspection

Resident Level Responsibilities

Whenever all materials have been furnished, all work has been performed, and all the Construction contemplated by the contract has been completed the final inspection is to be done per **Section 5-10** of the **Standard Specifications**.

After the Contractor has submitted written notification to the Department that the project or portion of the project is complete, the Project Administrator, Resident Engineer and the Contractor will perform the final inspection within seven days of the Contractor's notice to the Department. A representative of the maintaining unit will be invited to attend. On projects which include bridge structures, coordination initiated by the Project

Administrator with the District Structures Maintenance Engineer as outlined in **CPAM 10.11** shall occur. On projects which include miscellaneous structures (i.e. cable signs, cantilever signs, truss signs, high mast light poles, Intelligent Transportation System signs, Dynamic Message signs, traffic signal mast arms, etc.) which have been completed and are scheduled for acceptance, the Project Administrator shall notify the District Structures Maintenance Office to schedule an inspection of said miscellaneous structures. If, at the final inspection, all construction provided for and contemplated by the contract is found complete to the Engineer's satisfaction, no further inspection is required. Proceed to **Section 12.1.6 of this Manual**.

If, however, at the final inspection any work is found unsatisfactory and incomplete, in whole or in part, the Engineer shall compile a list of remedial work to be done. A copy of the list of remedial work will be furnished to the Contractor, with the indication that the work so noted must be completed prior to Final Acceptance. Time shall continue to be charged on the project.

Any list(s) of remedial work furnished to the Contractor shall state that it is not to be construed as the "final" list. It shall also state that all items damaged after Final Inspection, including those damaged beyond the control of the contractor, must be corrected.

When the Contractor has completed the list of remedial work items, the Engineer shall make another inspection of the project.

(1) If items on the list of remedial work are incomplete since the last inspection, the Engineer shall continue to charge contract time.

(2) If all items on the list of remedial work are found complete, proceed to **Final Acceptance, Section 12.1.6**.

If damage occurs to a pay item between the time the Contractor provides written notification of Final Inspection and the time the Project Administrator conducts the inspection, a time extension may be granted according to **Section 8-7.3** of the **Standard Specifications** and **CPAM Section 7.2, Time Extensions**. The contract time extension for replacement or repair of the pay item, which has been damaged, may be granted provided the damaged pay item is the only pay item requiring additional work. If damaged pay items as well as incomplete pay items are listed on the list of remedial work, a time extension for the damaged or defective pay items shall not be granted until the other incomplete pay items are completed.

Should unique circumstances arise, the State Construction Office should be consulted for direction, as well as the FHWA for Projects of Division Involvement (PoDI).

Some projects may require representatives from the District Construction Office, the State Construction Office or another specific field of expertise to participate in the Final Inspection. Other interested governmental agencies will be invited to participate. The FHWA shall be notified and invited to attend the inspection of FHWA PoDI projects.

12.1.6 Final Acceptance

Resident Level Responsibilities

When the District Construction Engineer or Resident Engineer is satisfied that all items of work are completed as called for in the contract, the project will be accepted. No work is to be performed on the contract after Final Acceptance. The District Construction Engineer or Resident Engineer will notify the Contractor in writing that the Project has been final accepted. On Consultant CEI managed projects, the Consultant shall seek the Department's Construction Project Manager input prior to issuing Final Acceptance to the Contractor

A ***Final Inspection and Acceptance of Federal-Aid Project***, [Form No. 700-010-32.doc](#), is to be completed by the District Construction Engineer. Delegation of the District Construction Engineer signature authority for this form is not permitted.

For both In-house and Consultant designed projects, a written, post construction evaluation (***Constructability Grade Computation***) of the design effort is required in accordance with ***CPAM Chapter 13.2, Constructability Grades***. For Design-Build projects, both a Constructability and Quality evaluation are required in accordance with CPAM Chapter 13.2.

The Department's ***Materials Manual, Topic No. 675-000-000*** should be reviewed to ensure timely issuance of Materials Statements and all required materials documents.

12.1.7 Information Transmittal

Transmittal of the latest, accurate, contract condition data is essential to the management of the Department's resources. AASHTOware Project Construction (PrC) allows data entry for the following changes in contract conditions. These conditions are:

- (1) Letting;
- (2) Awarded;

- (3) Execution;
- (4) Notice to Proceed;
- (5) Work Begin;
- (6) Time Begin
- (7) Final Acceptance;
- (8) Warranty Begin;
- (9) Material Certification;
- (10) Offer of Final Payment;
- (11) Receipt of Offer of Final Payment;
- (12) Passed to Comptroller; and
- (13) Paid Off

To ensure that data about the Final Acceptance is properly transmitted, a copy of the Final Acceptance letter should be sent to the FHWA (TE) (PoDI projects only) and the proper maintaining authority. Also, additional coordination will be required with the FHWA (TE) following FDOT's acceptance. The exact date of Final Acceptance should be noted.

District Level Responsibilities

The District Construction Engineer, or delegate, shall ensure the dates associated with each condition are entered in PrC as the condition occurs but no later than fourteen (14) days after the condition occurs.

Section 13.1

CONTRACTOR'S PAST PERFORMANCE RATING

13.1.1 Purpose

To set forth an internal procedure for preparing and processing a **Contractor's Past Performance Report (CPPR)** and for establishing a **Final Rating Score** for the performance demonstrated by the Prime Contractor on construction contracts, including Design-Build contracts.

13.1.2 Authority

Sections 20.23(3)(a), 334.048(3)

13.1.3 References

Sections 337.14(1) and 337.16(2)(c), Florida Statutes

Rule 14-22.003, 14-22.012 and 14.0141, Florida Administrative Code (F.A.C.)

13.1.4 General

The Department considers Contractor performance on construction contracts when qualifying or re-qualifying a firm. Specifically, the final scores established by the **Contractor's Past Performance Report** for performance demonstrated in completing Department contracts are used in the standard rule formula (**Rule 14-22, F.A.C.**) to determine a firm's **Maximum Capacity Rating** (The aggregate dollar volume of uncompleted work a firm is allowed by the Department to have under contract at one time regardless of with whom contracted).

The **CPPR** is used to evaluate the construction performance demonstrated by the Prime Contractor on construction contracts (Emergency, Fast Response, Pushbutton and Traffic Operations contracts are excluded from the CPPR process).

The final **CPPR** must be originated no later than forty-five (45) calendar days after the date of final acceptance of the work by the engineer.

The **CPPR** shall be completed even if there are pending Claims or Time Extension Requests. The **CPPR** can be revised pending the outcome of the Claim/Time Extension Requests.

For the purpose of this procedure all references to the Project Administrator, the Resident Engineer or the Project/Program Manager who oversees Consultant C.E.I.s shall be either Department or Consultant personnel, whichever is applicable.

13.1.5 Definitions

Refer to the Introduction section of this *Manual*.

13.1.6 Preconstruction Conference

Resident Level Responsibilities

The Project Administrator shall provide the Contractor a copy of the **CPPR** criteria at the Pre-construction Conference and explain that the Contractor's demonstrated performance in completing the contract work will be rated using these criteria.

13.1.7 Interim Performance Ratings

Interim Performance Ratings that reflect construction performance demonstrated by the Contractor to date shall be provided on at least a monthly basis.

The Contractor may appeal the interim score shown in Categories 1, 4 or 8, within ten (10) calendar days from receipt of the interim report. The appeal shall be in writing to the Resident Engineer requesting a meeting with the District Construction Engineer (See Sample Letter 13-1-C).

Resident Level Responsibilities

Interim Performance Ratings shall be originated by the Project Administrator. **Interim Performance Ratings** may be completed at the discretion of the Project Administrator at any time (milestones, phase change, etc.) on any project regardless of size or duration, but shall be completed at a minimum on a monthly basis. The original copy of the entire report shall be emailed to the Contractor and a copy shall be imported into the Department's approved Electronic Document Management System.

13.1.8 Rating the Contractor on construction projects

The CPPR, Form No. 700-010-25, contains the following sections:

1. Pursuit of the Work
2. Proper MOT and Minimize Impacts to Traveling Public
3. Timely and Complete Submittal of Documents
4. Timely Completion of Project
5. Coordination/Cooperation with CEI Personnel, Property Owners and Utilities Company
6. Mitigate Cost and Time Overruns
7. Environmental Compliance
8. Conformance With Contract Documents
9. DBE Utilization.

Rating the Contractor's demonstrated performance shall begin at the time the contract has been awarded to the Contractor and continue throughout the duration of the contract. The Project Administrator should use those personnel who actively participated in the inspection of the work and/or the administration of the contract to assist in rating the Contractor's performance.

For Design-Build contracts, contract time periods (i.e., design phase) can be tracked in Category 1 and 8, with issues related to the submittal of plan documents being scored in Category 3. Once actual work begins, scoring in all 9 categories would be performed as normal.

13.1.9 Preparing the Report

(A) Resident Level Responsibilities

- (1) The Project Administrator shall provide a copy of the **CPPR** at the Pre-construction Conference and explain the criteria for which the performance of the Contractor will be evaluated. The following are some of the criteria that need to be discussed at the Pre-construction Conference. [Additional guidance on Construction website.](#)
 - (A) Where percentages are used, the standard rules of rounding are to apply to calculate the nearest whole number.
 - (B) Documentation (or document) unless otherwise noted is defined as **Daily Report of Construction, Form No. 700-010-13**, Stop Work Orders,

electronic mail, or other such notes or communication in the project files or to the Contractor from the Project Administrator/Project Manager or other Department staff or representatives. Proper documentation on a daily basis is essential in providing an accurate, well-established grade. Use of the Department's Contract Information & Monitoring (CIM) application for completion of the CPPR is mandatory on all construction projects. The CIM CPPR module can be accessed from the [FDOT Employee Portal](#) by selecting Enterprise Applications.

- (C) Communication will be the key for both the Contractor and the Project Administrator/Project Manager. This will require both sides to deal with the issues of the contract. The performance of the work should be discussed with the Contractor on a periodic basis or at a minimum, on a monthly basis (including an updated interim CPPR Report). This can be done by reviewing the Department's **Daily Report of Construction** (daily diaries) as well as discussing Contractor performance at the weekly progress meetings.
- (D) The Prime Contractor is responsible for the performance of all subcontractors and suppliers, which includes the quality of the workmanship, materials, timely submittal of documentation and timely completion of the work.
- (E) For Performance categories # 4, 7 and 9 bonus points are available for the Contractor. For category #4, there are six (6) bonus points available if the Contractor finished the project within the original contract time (no adjustments for weather). Category #7 has two (2) bonus points available, these points are only available on projects with 300 or more days of allowable contract time, the 2 points will be applied if the Contractor did not receive any deficiency letters in this category. Category #9 has four (4) bonus points available if the Contractor has achieved or exceeded the DBE availability percentage shown in the bid proposal. If no DBE availability percentage is shown in the bid proposal, the Contractor will receive the bonus points for achieving 8% or more DBE utilization. In order for the Contractor to get the credit for DBE utilization, the Contractor must put this information in the Department's Equal Opportunity Reporting tracking system.
- (F) Communication regarding performance concerns or non-compliance generally start with Verbal Warnings (VW). If the Contractor does not correct the issue, we expect our personnel to next issue a Deficiency

Warning Letter (DWL) for the same issue. If after this DWL the Contractor has still not corrected the problem, our personnel are expected to issue a Deficiency Letter (DL). That is the typical process, however there are times in which the VW and DWL will be omitted and an issue goes directly to DL (e.g., a serious concern over safety or environmental violations). VW, DWL, and DL should all be documented in the CIM CPPR Module in the category for which they were issued.

- (2) **Deficiency Warning Letter (DWL):** The Project Administrator will issue the **DWL** letter (Refer to the Guidance Documents for this section), under normal circumstances, to notify the Contractor of shortcomings/non-compliances with the contract. Prior to issuing a **DWL**, the Project Administrator should discuss the performance concerns with the Resident Engineer. A single **DWL** can be used to address concerns in more than one performance category. However, blatant violations or non-compliances may result in a **Deficiency Letter** being issued without a warning. The **DWL** shall be sent via email, return receipt requested to the Project Superintendent.
- (3) **Deficiency Letter (DL):** The Resident Engineer will issue a **DL** to the Contractor for the sole purpose of addressing continual performance concerns and issues that were previously documented by a **DWL** or blatant violations or non-compliances. A single **DL** can be used to address concerns in more than one performance category. The **DL** shall be sent via email, return receipt requested (or using other similar services) to the Project Superintendent, giving the Contractor ten (10) days from the date of receipt of this letter to appeal. This appeal shall be in writing to the Resident Engineer requesting a meeting with the DCE. If no meeting has been requested or the Contractor fails to attend a requested scheduled meeting, then the **DL(s)** shall become final.
- (4) For contracts that are over 365 days, a **Deficiency Letter** factor will apply to categories that have the **Deficiency Letter** as part of the performance. For an example on how to calculate the **Deficiency Letter** Factor, see Page 2 of 9 of the **CPPR (Form # 700-010-25)**.
- (5) If the Contractor has requested a meeting to appeal the issuance of a **Deficiency Letter** at the DCE level, then the Resident Engineer shall inform the Contractor in writing of the date, time and location of the meeting. If the Contractor appeal is successful, then the DCE will issue a letter to the Resident Engineer, (copy the Contractor) rescinding the particular **Deficiency Letter**.

- (6) For those performance categories (categories 1, 4 & 8) that do not include the use of **Deficiency Letters**, the Contractor will use the appeals process. The Resident Engineer shall inform the Contractor of the CPPR score on a monthly basis (usually via weather letter or similar notification), giving the Contractor ten (10) days from the date of receipt of this letter to appeal. This appeal shall be in writing to the Resident Engineer requesting a meeting with the DCE, if no meeting has been requested or the Contractor fails to attend a requested scheduled meeting, then the score for that month shall become final.
- (7) The CPPR Final Report shall be originated and signed by the Project Administrator upon final acceptance of the contract work by the Engineer. The original of this report shall be provided to the Resident Engineer for his or her review. All correspondence, Performance Deficiency Letters, Contract Records, Schedules and supporting data used in preparing the Report shall be identified for future reference.
- (8) The Resident Engineer shall sign the final report after the report has been reviewed and forward it to the Contractor, via Email, Return Receipt Requested (or using other similar services), no later than ten (10) calendar days after receiving the final CPPR report of the contract work by the Project Administrator. The Resident Engineer shall include a cover letter with the report that explains the following options available to the Contractor and the Department's subsequent actions:
 - (A) The Resident Engineer shall inform the Contractor that if a meeting is desired to appeal the results of the **CPPR** with the DCE, the meeting request shall be in writing to the Resident Engineer within ten (10) days from the Contractor's receipt of the **CPPR**.
 - (B) The Resident Engineer shall inform the Contractor that failure to request a meeting within ten (10) calendar days from the Contractor's receipt of the **CPPR**, or failure to attend a requested scheduled meeting, will result in the rating indicated in the **Contractor's Past Performance Report** becoming final.
- (9) Once the appeal process has been completed the **CPPR** shall become final. The **Final CPPR Report** shall be scanned into the Department's **Electronic Document Management System (EDMS)** and the results sent electronically to the District Construction Engineer, the Office of Construction ([Prequalification Specialist](#)), and a copy sent to the Contractor.

(B) District Level Responsibilities

- 1) In the event that the Contractor has requested a meeting to appeal the issuance of a Deficiency Letter and the Contractor's appeal is successful, then the DCE will issue a letter to the Resident Engineer with a copy to the Contractor rescinding the particular **Deficiency Letter**. The DCE's letter should include the reason for rescinding the particular **Deficiency Letter**.
- 2) If the Contractor requested a meeting with the DCE to appeal the results of the **Contractor's Past Performance Report** and the Contractor's appeal is successful, then the DCE will issue a letter to the Resident Engineer with a copy to the Contractor directing the Resident Engineer to make the necessary changes to the Contractor's Past Performance Report. The DCE's letter should include the reason for making such changes.

**GUIDANCE DOCUMENT 13-1-A
(SAMPLE LETTER)**

(Date)

Contractor Superintendent
Name and Address

Financial Project ID: 123456-1-52-01
FAP No.: 1234-000-C
Contract No.: 12345
County: Leon

RE: Performance Deficiency Warning Letter

This is to advise you that a performance deficiency warning is hereby issued on the above referenced project on:

Performance Category Number 2, Proper MOT and Minimize Impacts to Traveling Public, of the Contractor's Past Performance Rating.

The performance deficiency warning hereby issued is as follows:

The project superintendent (**NAME**) has been advised on several occasions (see Daily Report of Construction dated (**DATE**), (**DATE**), (**DATE**) of MOT warning devices (barricades) that have been repeatedly moved out of the way of the paving operations and are not placed back to the proper location to protect the traveling public and workers.

This performance deficiency warning is to let you know that your company is out of compliance on the above Performance Category(s). If your company continues to work out of compliance, a Performance Deficiency Letter will be issued and your Contractor's Past Performance Rating will be adversely impacted. Your company needs to make all necessary corrections to ensure that all work is being performed in accordance with the contract.

Sincerely,

Project Administrator Name
Engineer Title

cc: Resident Engineer
District Construction Engineer
Corporate Office

**GUIDANCE DOCUMENT 13-1-B
(SAMPLE LETTER)**

(Date)

Contractor Superintendent
Name and Address

Financial Project ID: 123456-1-52-01
FAP No.: 1234-000-C
Contract No.: 12345
County: Leon

RE: Performance Deficiency Letter

This is to advise you that a performance deficiency is hereby issued on the above referenced project on:

Performance Category Number 2, Proper MOT and Minimize Impacts to Traveling Public, of the Contractor's Past Performance Rating criteria.

The deficiency that has been issued is as follows:

The project superintendent (**NAME**) has been advised on several occasions (see Daily Report of Construction dated (**DATE**), (**DATE**) and (**DATE**) and you were issued a Deficiency Warning Letter on (**DATE**). Additional MOT performance concerns have been documented on (**DATE**), which have warranted this deficiency letter.

This is to advise you that this Performance Deficiency has impacted your final grade on your Contractor's Past Performance Rating. If you wish to contest the Department's action in issuing this Performance Deficiency, you may request a meeting with me within ten (10) days of receipt of this Performance Deficiency Letter. Additional performance problems may result in additional deficiency letter as well.

Sincerely,

Resident Engineer (Name)
Engineer Title

cc: Project Administrator
District Construction Engineer
Corporate Office

**GUIDANCE DOCUMENT 13-1-C
(SAMPLE LETTER)**

(Date)

Contractor Superintendent
Name and Address

SUBJECT: **CPPR REPORT - March 2019**
Job Description: Add Turn Lane at SR-11 and 1st Avenue
Financial Project Number: 123456-1-52-01
Federal Aid Project Number: 1234-000-C
Contract Number: 12345
County - Section Number: Leon

The daily reports of construction documenting the Contractor's Past Performance have been evaluated for the period beginning (enter date) through (enter date). The attached Contractor Past Performance Report summarizes the cumulative rating to date.

If you disagree with the score shown in Categories 1, 4 or 8, you may appeal the decision within ten (10) calendar days from receipt of this notice. The appeal shall be in writing to the Resident Engineer requesting a meeting with the District Construction Engineer.

Any such appeal must be accompanied by all available specific facts that support your position.

If you fail make an appeal or to provide specific facts supporting your position within ten (10) days from receipt of this notice, the grade shall become final. If you fail to attend a requested appeal meeting, the grade shall become final.

Sincerely,

Project Admin. Name
Title

cc:Resident Engineer
District Construction Engineer
Corporate Office

Section 13.2

CONSTRUCTABILITY GRADES

13.2.1 Purpose

To establish a uniform procedure for Construction Project Managers (CPM) to evaluate the quality of the design for a completed project.

13.2.2 Authority

Sections 20.23(3)(a) and 334.048(3), Florida Statutes (F.S.)

13.2.3 References

[Procedure No. 375-030-007, Professional Services Consultant Work Performance Evaluation](#)

[Procedure No. 625-020-010, Design-Build Procurement and Administration](#)

13.2.4 Constructability Grades

13.2.4.1 Resident Level Responsibilities

The CPM shall assign a Constructability Grade within 30 calendar days after final acceptance of the construction project.

For projects designed by Consultants, the CPM shall follow [Professional Services Consultant Work Performance Evaluation, Procedure No. 375-030-007](#) to complete the Constructability Evaluation and record the constructability grade in the **Professional Services Information System (PSIS)** using the [Consultant Evaluation \(PSI-CE\)](#) tool of the **Project Managers Grades System (PMGS)**.

For in-house designs, the CPM shall complete the [Constructability Evaluation, Form No. 375-030-08Z](#), sign it, and then send it to the Design Project Manager (DPM). The DPM shall coordinate with the Department's Engineer of Record (EOR) to review the results of the constructability evaluation. After the DPM signs the form, the DPM shall send it to the District Design Engineer for concurrence and filing.

For Design Build Projects, the CPM shall conduct performance evaluations of the Design Professional in accordance with [Procedure No. 375-030-007, Professional Services Consultant Work Performance Evaluation](#) and [Procedure No. 625-020-010, Design-Build Procurement and Administration](#) to complete the Constructability Evaluation and record the constructability grade in the **Professional Services Information System (PSIS)** using the [Consultant Evaluation \(PSI-CE\)](#) tool of the **Project Managers Grades System (PMGS)**. Only the evaluation areas of Quality and Constructability (Post-Construction) are to be evaluated. This evaluation is to be performed after Final Acceptance of the project. The DPM should be consulted when completing this evaluation. Final evaluations shall be submitted to the District Design Engineer and the Alternative Contracting Specialist in the State Construction Office.

Section 13.3

CONTRACTOR SURVEY

13.3.1 Purpose

The purpose of this procedure is to ascertain from the Contractor the quality of the plans, specifications, and administration of the Contract.

13.3.2 Process

Resident Level Responsibilities

The Project Engineer will send a copy of the Contractor Survey, available on the Office of Construction website, to the Contractor along with the Offer Letter. The letter provides instructions on filling out the survey and where to return the survey. A sample letter and the survey are available at the hyperlink below.

<http://www.fdot.gov/construction/download/ContractorLetterwithSurvey.pdf>

13.3.3 Analysis

District Level Responsibilities

The District Construction Engineer (DCE) will use the information provided in the completed survey to evaluate the operations of the District Construction and Resident Construction Office. Based on the analysis of the surveys, the DCE may re-allocate resources to various tasks, identify the need for individual direction, identify needed training, and identify areas where new skills need to be developed.

The DCE should share the survey results with the District Director of Production to identify areas where there could be improvement made in the plans development process.