

State of Florida
Department of Transportation



CADD Manual

In reference to the FDOT Design Manual (FDM)

TOPIC NUMBER: 625-050-001

Publish Date: February 4, 2019

PRODUCTION SUPPORT CADD OFFICE

TALLAHASSEE, FLORIDA

<http://www.fdot.gov/cadd/>

[THIS PAGE INTENTIONALLY LEFT BLANK]

Contents

TOPIC NUMBER: 625-050-001	1-1
CHAPTER 1.....	1-1
INTRODUCTION	1-1
1.1 PURPOSE.....	1-1
1.2 AUTHORITY	1-1
1.3 REFERENCES	1-1
1.4 DEFINITIONS	1-2
1.5 SCOPE	1-7
1.6 ORGANIZATION	1-7
1.7 ROLES AND RESPONSIBILITIES	1-7
1.7.1 CADD Office.....	1-7
1.7.2 CADD Managers.....	1-8
1.7.3 CADD Technical Advisory Committees (TACs)	1-8
1.8 DISTRIBUTION.....	1-8
1.9 TRAINING.....	1-8
1.10 LINKS AND FORMS.....	1-8
1.10.1 CADD Quick Links	1-8
1.10.2 Forms	1-10
1.10.2.1 Suggestions, Comments, or Questions for the CADD Manual	1-10
1.10.2.2 Compliance Certification Checklist	1-13
CHAPTER 2.....	2-1
CADD COMPUTER SYSTEMS.....	2-1
2.1 PURPOSE.....	2-1
2.2 SCOPE	2-1
2.3 PROCUREMENT OF CADD HARDWARE AND SOFTWARE	2-1
2.4 MINIMUM SYSTEM REQUIREMENTS	2-1
2.4.1 Optimal CADD Hardware/Software Requirements	2-1
CHAPTER 3.....	3-1
CADD SOFTWARE, DEVELOPMENT AND DISTRIBUTION	3-1
3.1 PURPOSE.....	3-1
3.2 SCOPE	3-1
3.3 SUPPORTED CADD PLATFORMS.....	3-1
3.4 CADD SOFTWARE DEVELOPMENT	3-1
3.5 CADD SOFTWARE UPDATES.....	3-2
3.5.1 CADD Software Testing	3-2
3.5.2 CADD Software Release Notifications	3-2
3.5.3 CADD Software Release Distribution.....	3-2
CHAPTER 4.....	4-1
CADD SUPPORT	4-1
4.1 PURPOSE.....	4-1
4.2 SCOPE	4-1
4.3 OVERVIEW	4-1
4.4 SYSTEM SUPPORT	4-2
4.5 OPERATIONAL SUPPORT.....	4-2
4.6 TRAINING SUPPORT	4-3
4.7 REPORTING OF CADD ISSUES.....	4-4

CHAPTER 5.....	5-1
CADD STANDARDS.....	5-1
5.1 PURPOSE.....	5-1
5.2 SCOPE	5-1
5.3 GENERAL.....	5-1
5.4 DATABASE (DDB) RESOURCES.....	5-2
5.4.1 MicroStation	5-2
5.4.2 AutoCAD.....	5-2
5.5 SEED/SHEET TEMPLATE FILES	5-3
5.5.1 MicroStation Seed Files.....	5-3
5.5.2 AutoCAD Sheet Template Files.....	5-4
5.6 DESIGN LIBRARIES/TEMPLATES	5-5
5.6.1 MicroStation Design Libraries	5-5
5.6.2 AutoCAD Design Template Files.....	5-6
5.7 DESIGN FILENAMES	5-6
5.7.1 Design File Naming Convention	5-7
5.7.1.1 Structures Design File Naming Convention	5-8
5.7.1.2 Architectural Design File Naming Convention	5-9
5.7.1.3 Architectural Sheet Naming Convention	5-11
5.7.2 Critical or Non-Critical Percentage of Compliance	5-12
5.7.3 Reference Files	5-12
5.7.3.1 MicroStation Referencing.....	5-13
5.7.3.2 AutoCAD Referencing	5-13
5.7.3.3 Sharing of CADD Files	5-13
5.8 CADD RULES.....	5-14
5.8.1 Exceptions to the CADD Rules	5-14
5.9 LEVELS/LAYERS AND SYMBOLOGY.....	5-15
5.9.1 Levels/Layers Naming Convention	5-15
5.9.1.1 Architectural Levels/Layers and Symbolology	5-16
5.9.1.2 Structures Levels/Layers and Symbolology	5-17
5.9.1.3 Survey Levels/Layers and Symbolology	5-17
5.9.2 Color Symbolology	5-18
5.9.3 Line Style/Linetype Symbology (Standard Symbols).....	5-18
5.9.3.1 Custom Line Styles/Linetypes	5-18
5.9.3.2 Non-standard Custom Line Styles/Linetypes	5-19
5.9.4 Line Weight Symbology.....	5-19
5.10 TEXT.....	5-20
5.10.1 Special Symbols.....	5-20
5.10.2 Text Size and Spacing.....	5-20
5.10.2.1 Architectural Text Sizes and Weights	5-21
5.10.2.2 Structures Text Sizes and Weights.....	5-22
5.10.3 FDOT Standard Abbreviations.....	5-22
5.11 CELL LIBRARIES/BLOCK DRAWINGS	5-22
5.12 PROFESSIONAL OF RECORD NOTE	5-24
5.12.1 Professional of Record Seals Cell Library.....	5-24
CHAPTER 6.....	6-1
CADD PRODUCTION PREREQUISITES.....	6-1
6.1 PURPOSE.....	6-1
6.2 SCOPE	6-1
6.3 PROJECT DEVELOPMENT & ENVIRONMENT	6-1
6.3.1 PD&E CADD Deliverables	6-1
6.4 RIGHT OF WAY MAPPING	6-2
6.4.1 Right of Way CADD Deliverables.....	6-2
6.5 SURVEY	6-3

6.5.1 Survey CADD Deliverables	6-3
6.5.2 Survey Data File	6-3
6.5.3 County Mapping.....	6-4
6.5.4 Utility Quality Levels	6-4
6.6 GEOTECHNICAL.....	6-4
6.7 TRAFFIC DATA.....	6-6
6.8 TYPICAL SECTIONS PACKAGE	6-6
6.9 DRAINAGE.....	6-6
6.10 PAVEMENT	6-6
6.11 UTILITIES.....	6-6
6.12 STRUCTURES.....	6-10
6.12.1 Existing Bridge Plans.....	6-10
CHAPTER 7.....	7-1
CADD PRODUCTION SUPPORT	7-1
7.1 PURPOSE.....	7-1
7.2 SCOPE	7-1
7.3 PROFESSIONAL ACCOUNTABILITY	7-1
7.4 PROJECT SETUP.....	7-1
7.4.1 Project Folder Structure	7-2
7.5 PRODUCTION WORKFLOW	7-4
7.6 SUPPORTED CADD SOFTWARE BY COMPONENT/DISCIPLINE.....	7-5
7.6.1 Roadway	7-5
7.6.1.1 GEOPAK, OPENROADS, CIVIL3D.....	7-5
7.6.2 Signing and Pavement Marking	7-5
7.6.2.1 Sign Design.....	7-6
7.6.2.2 Turn Radius Design	7-6
7.6.3 Signalization.....	7-6
7.6.4 Intelligent Transportation Systems	7-6
7.6.5 Lighting	7-7
7.6.5.1 Lighting Design Software	7-7
7.6.6 Landscape	7-7
7.6.7 Architectural	7-8
7.6.8 Structures.....	7-11
7.6.8.1 Structures Borders and Scales	7-11
7.6.8.2 Structures Dimension Settings.....	7-12
7.6.9 Toll Facilities.....	7-12
7.7 PROJECT JOURNAL.....	7-13
7.8 EXISTING AS BUILT PLAN SHEETS	7-13
7.9 SHEET NUMBERS	7-13
7.9.1 Structural Sheet Numbers	7-14
7.10 PRINTS	7-15
7.10.1 Print Drivers	7-15
7.10.1.1 MicroStation Half-Toning	7-15
7.10.1.2 Quality and Reproduction	7-15
7.10.2 Print Resource Files.....	7-16
7.10.2.1 MicroStation.....	7-16
7.10.2.2 AutoCAD Civil 3D	7-17
7.10.3 Print Borders	7-17
7.10.4 Print Image Files	7-17
7.10.4.1 Print Image File Naming Convention	7-17
7.10.4.2 Print Image File Naming Format.....	7-18

CHAPTER 8.....	8-1
CADD DELIVERY	8-1
8.1 PURPOSE.....	8-1
8.2 SCOPE	8-1
8.3 RECEIPT AND ACCEPTANCE OF ELECTRONIC DATA	8-1
8.4 PRODUCTION DELIVERABLE FILES.....	8-2
8.4.1 Plans Component PDF Files.....	8-2
8.4.1.1 Early Work Sheets of Plan Sets	8-3
8.4.1.2 Plans Component PDF Deviation	8-3
8.4.2 3D Model PDF Files	8-4
8.4.3 Specifications PDF Files	8-4
8.4.4 CADD ZIP Files	8-4
8.4.4.1 Engineering Data	8-5
8.4.5 Calculations Folder - Plan Summary Boxes and Quantity Files	8-5
8.4.6 3D Deliverables Folder - Automated Machine Guidance in Construction	8-7
8.4.7 Merging External Project Files	8-0
8.4.8 Reviewing the Project	8-1
8.4.9 Sign and Seal Project Files.....	8-2
8.4.10 Legacy Electronic Signature Projects	8-2
8.4.11 Media Requirements for Delivery	8-2
8.4.12 Compliance Certification Checklist.....	8-3
8.5 SPECIFICATIONS.....	8-3
8.6 FINAL PLANS OFFICE	8-5
8.7 REVISIONS.....	8-6
8.8 RE-LET PROJECTS AND ROLL BACK REVISIONS	8-6
8.9 STRUNG PROJECTS.....	8-6
8.10 AS-BUILT PROJECTS	8-7
8.11 DESIGN BUILD PROJECTS	8-7
8.12 PROJECT STORAGE AND ARCHIVAL.....	8-7
CHAPTER 9.....	9-1
QUALITY ASSURANCE AND QUALITY CONTROL.....	9-1
9.1 PURPOSE.....	9-1
9.2 AUTHORITY	9-1
9.3 PRODUCTION ACCOUNTABILITY	9-1
9.3.1 Quality Control.....	9-1
9.3.1.1 Quality Control of Corridor Models and Extracted Surface	9-2
9.4 QUALITY ASSURANCE PLAN	9-3
9.5 QUALITY ASSURANCE REVIEWS (QARs)	9-3

Chapter 1

INTRODUCTION

1.1 PURPOSE

The *CADD Manual* addresses the requirements to utilize Computer Aided Design and Drafting (CADD) for production and delivery of digital project data for the Florida Department of Transportation (Department). In addition to software and configuration requirements, it identifies tools, techniques, applications, standards and procedures that are used to produce a consistent and quality CADD product for the Department.

The *CADD Manual* establishes *minimum* CADD standards to ensure a consistent, predictable and repeatable CADD data set for Department's projects. The *CADD Manual* also serves to provide professional services administrators, project managers, consultants, in-house designers, and others a procedure to be incorporated by reference into scopes and other contract documents for services.

Note Following the requirements within this manual does not guarantee an acceptable work product, as this procedure does not address the quality of the engineering or survey work performed.

1.2 AUTHORITY

[Florida Statutes \(F.S.\), Title IV, Chapter 20, Section 20.23\(3\) \(a\)](#)

[Florida Statutes \(F.S.\), Title XXVI, Chapter 334, Section 334.048\(3\)](#)

1.3 REFERENCES

[Construction Project Administration Manual \(CPAM\) Topic No. 700-000-000](#)

[FDOT Design Manual, Topic No. 625-000-002](#)

[Federal Highway Administration - 3D Modeling](#)

[Florida Administrative Code, Chapter 1B-26.003\(10\) Electronic Storage Media](#)

[Florida Permanent Reference Network \(FPRN\)](#)

[Florida Statutes](#)

[General Tolling Requirements \(GTR\)](#)

[IdenTrust](#)

[Information Technology Resource User's Manual, Topic No. 325-000-002](#)

[LandXML](#)

[MicroStation Basics for Construction](#)

[Project Development and Environment Manual \(PD&E Manual\), Topic No. 650-000-001](#)

[Quality Management, Topic No. 001-260-001](#)

[Standard Plans](#)

[Standard Operating System, Topic No. 025-020-002](#)

[Structures Manual, Topic No. 625-020-018](#)

[Surveying and Mapping Procedure, Topic 550-030-101](#)

[Surveying and Mapping Handbook](#)

1.4 DEFINITIONS

The following definitions used in the *CADD Manual* relate to electronically generated project data and deliverables for consistency of understanding and interpretation of processes and criteria contained within.

3D Design: The process of creating 3D Models for a project.

3D Engineered Model Quality Control Checklist: A draft document that contains the data producer's written assurances that the 3D deliverable items required by the Department's *CADD Manual* are included in the delivered project data and that certain Quality Control functions were performed.

3D Model: A 3D model is a digital graphical representation of proposed facility/site data consisting of X, Y, and Z coordinates for producing objects in three dimensions to convey design intent useful for visualization, analysis, animation, simulation, plans, specifications, estimates production, and life-cycle asset management. An accurately designed 3D model will be tied to a defined coordinate system.

Alpha Testing: Initial testing of CADD Software products or enhancements by the development staff and testing by the support staff outside of the development environment.

Authentication: For Digital Signature, Authentication is the process where Digital Signatures are compared with identity data held by the issuer of a Digital Certificate (the Certificate Authority) to validate the identity of a Signatory; and that a document that has been signed with a Digital Signature has not been modified since signing. This is an automated process of the document software (such as with Adobe Reader or Acrobat) that provides feedback to the user that the file being examined is signed, the signatures are valid, and the document is unmodified since the Signatory signed it.

Automated Machine Guidance (AMG): Automated machine guidance is a process in which construction equipment is linked directly to the operation of machinery with a high level of precision, improving the speed and accuracy of construction processes. The AMG can utilize the GPS or robotic total stations for positioning information.

Beta Testing Coordinator: An individual responsible for facilitating the beta testing of CADD software.

Beta Testing: Secondary testing of CADD Software products performed in a production-like environment by end-users.

Bid Set: A sub-set of files consisting of data derived from the overall Project Data Set containing only those files needed for the advertisement and letting of a project. The files needed for the Bid Set remain in their source folder structure derived from the Project Data set. For Digital Delivery projects, the data in the Bid Set is usually compiled manually and put in a ZIP file with a naming convention defined later in this chapter.

ByLayer (AutoCAD)– A property that, when turned on, causes the object on a specific layer to retrieve its definition from the Layer Properties of that layer, such as Color, Linetype, and Line weight.

ByLevel (MicroStation)– A setting that, when turned on, causes the element on a specific level to retrieve its definition from the Level Symbolology of that layer, such as Color, Line Style, and Line Weight defined by the Level Symbolology.

CADD - (Acronym for: *Computer Aided Design and Drafting*) Software and methods used to design and represent objects graphically on the computer. CADD facilitates the visual presentation of Engineering Data.

CADD Community: The CADD Community encompasses all CADD users, (i.e. Department, consultants, contractors, and other agencies) utilizing Department supported CADD platforms and custom software.

CADD Hardware: The workstations, servers, printers and all other computer equipment used in the Department's design production effort.

CADD Manager - The CADD Manager is responsible for (1) support of the core CADD Software products in the work units and (2) a variety of Final Plans functions including but not limited to the receipt, acceptance, and management of digital deliveries of project data.

CADD Production: The development of projects utilizing CADD applications, software and discipline-based processes.

CADD TAC - (Acronym for: *Computer Aided Design and Drafting Technical Advisory Committee*) A discipline-based group sanctioned by the Statewide CADD Coordinator consisting of District and Central Office representatives charged to meet and work on statewide technical issues dealing with CADD applications, procedures, testing, training, and implementation.

CADD Software: Any software procured, developed, distributed and supported by CADD.

CADD Support - The technical and operational activity necessary to ensure that a production environment is maintained, which includes:

- a) Selection, development and distribution of production CADD software, related procedures, criteria and standard operating instructions,
- b) Provision of training opportunities for CADD users,
- c) Management of design data produced with the CADD software,
- d) Statewide procurement of: CADD software, training services, and software development assistance.

Calculations Folder: Excel files, Portable Document Format (PDF) files and any associated quantity backup data for the plan summary boxes.

Certificate Authority: The 3rd party entity that issues the Digital Certificate to the professional signatory and validates the identity of the signatory.

Compliance Certification Checklist: A draft document that contains the data producer's written assurances that items required by the Department's CADD Manual are included in the delivered project data and that certain Quality Control functions were performed.

Compliance Indicator: Evidence that the critical requirements which are being applied are producing the desired result.

Component – A categorization of design plans as defined in the FDOT Design Manual (FDM) 302.5. The list of plans components for Digital Delivery is comprised of the following:

1. Roadway
2. Signing and Pavement Marking
3. Signalization
4. Intelligent Transportation System (ITS)
5. Lighting
6. Landscape
7. Architectural
8. Structures
9. Toll Facilities

The plans components do not directly correspond to the project's folder structure. For example, drainage files have a \drainage\ folder below the root level project folder, but it may be included as part of the Roadway Plans Component.

Composite PDF: A document containing the plan sheet images composing the plans set in their index order. This document must be in Adobe Portable Document Format (PDF) format and reside in the project's root folder.

Design File – An electronic CADD file that conforms to MicroStation® (DGN) or AutoCAD® (DWG) graphics formats.

Design Quantities and Estimates System (DQE). An application for FDOT Estimators used to produce Construction Cost Estimates. It is also used to maintain pay items and the Basis of Estimates.

Digital Certificate: In cryptography, a digital certificate uses a digital signature to bind together a public key with an identity — information such as the name of a person or an organization, their address, and so forth. The certificate can be used to verify that a public key belongs to an individual. The signatures on a certificate are attestations by the certificate signer that the identity information and the public key belong together. The type of Digital Certificates used for the Department's design work must meet the Federal Government's Access Certificates for Electronic Services (ACES) program. The Department currently uses IdenTrust to provide those digital certificates: <http://www.identrust.com/fdot/index.html>.

Digital Delivery: A method to deliver project data which relies upon creating a compressed archive (ZIP file) of project data, PDF files of Plans and Specifications documents. Plans and Specifications are signed and sealed with a Digital Signature.

Digital Signature Appearance: A graphical representation that appears on an electronic document indicating that a digital signature has been applied. As a minimum, the appearance must contain the name of the signatory and a date-time stamp at the instant of signature. When a digital signature is used as an application of a professional's signature and seal, specific language must accompany the digital signature appearance. See the Department's *FDM 303* Exhibits for further explanation and examples. When the digital signature is an application of a professional engineer's signature and seal, The Signature Appearance is not proof of authenticity, only that a signature was applied. Authenticity is proven through the Validation process (see Validation definition).

Digital Signature: Cryptographic data applied to an electronic file which is unique to the signatory and is very difficult to forge. In addition, the digital signature assures that any changes made to the data or electronic file that has been signed cannot go undetected. A Digital Signature is much the same as a conventional handwritten signature that identifies a person signing the document. While traditional signatures are on paper, every digital signature will store information that will identify the person signing. There can also be information about changes made to a digitally signed document since the first signature was applied. In Digital Delivery, Digital Signatures are applied to Signature Sheet(s) in the plans or may be applied to documents that Professional(s) of Records are taking responsibility for.

Digital Signature Root Certificate: Cryptographic information installed on a computer that identifies the Certificate Authority and allows the identity of the Signatory to be validated against the identity records held by the Certificate Authority. This process usually requires a connection to the Internet.

Digital Terrain Model (DTM): A DTM is a digital topographic model of the earth's surface minus objects such as trees, vegetation, and structures that can be manipulated through computer-aided design programs. All elements of the DTM are spatially related to one another in three dimensions.

Digitally Created Seal: An image of a seal created by electronic means and placed in an electronically produced document. In the CADD environment digitally created seals are usually placed by inserting a block/cell resembling an embossed seal. These may also be produced by means of a "stamp tool" in PDF editing software. The digitally created seal is an image to further communicate the idea that the adjoining digital signature appearance is the application of professional license. The digitally created seal is only an image and has no means of validation whatsoever. A digitally created seal is not to be confused with a digital certificate or digital signature. (For engineering seals, see Florida Administrative Code (F.A.C.) 61G15-23.002 Seals Acceptable to the Board).

Drawing Units (AutoCAD) – The real-world units used in an AutoCAD drawing that represents the measurement system used to construct the real-world design, such as US Survey Feet.

Early Works: Sheets inserted into the plan set that were prepared early in or prior to the design process. See section 8.10.1 of this document. **Project CD:** Media (CD, DVD, USB, etcetera) containing all data associated with a project. The contents must include the entirety of the Project Folder/Project Data Set.

Engineering Data: Those electronic files that represent the critical geometric and quantitative controls or other data supporting the graphical representation (design) of a project.

File Checker: An application to assist with the verification of Quality Control (QC) compliance to Delivery standards, such as folder structure, file naming, etcetera.

Font Library – A file in which text characters styles, symbols, or patterns are stored.

Global Origin (MicroStation) – Origin location of the Cartesian coordinate system in the design plane coordinates (UORs) for MicroStation files. When design plane positions are specified or reported in working units, they are relative to the global origin.

Journal: Electronic file(s) that document development, correspondence, decisions made, methodology used, exceptions to standards, or other descriptive information about the project. The Electronic Journal includes details that must give future users insight about the project data.

Layer Symbology (AutoCAD) – The definition of the properties an object inherits when placed on a layer using the "ByLayer" property. The layer definition contains properties such as Color, Linetype, and Line weight.

Letting: The process of advertising, selection, and award of a contract for the construction of a project.

Level/Layer – Data in the design file segregated into drawing levels or layers.

Level Symbology (MicroStation) – The definition of the symbology an element inherits when placed on a level using the "ByLevel" setting. The level definition contains symbology such as Color, Line Style, and Line Weight

Line Style (MicroStation) – Part of the symbology of an element: for example, whether a line is represented a solid, composed of dashes, dots and dashes, and so on. Each element has its own line style.

Line weight (AutoCAD) – The thickness of a line used for display or print purposes defined in millimeters.

Line Weight (MicroStation) – An index that designates the thickness of the lines used to draw or print a graphic element. Each element has its own line weight.

Linetype (AutoCAD) – Part of the property of an object: for example, whether a line is represented by a continuous line or a series of dots and/or dashes and spaces.

Master Units (MicroStation) – The largest unit in common use in a design file, usually represented in US Survey Feet for most of the Department's seed files.

OIT Personnel Supporting CADD: Office of Information Technology (OIT) personnel assigned to support the CADD program to perform the role of management and related tasks of the Department's IT infrastructure.

Plans Change: FDM 131.2 definition) Modifications to the plans, specifications or quantities after District Estimates Office changes the Project Preconstruction (PrP) Workflow/Phase and before the Plans are sent to Tallahassee are referred to as Plan Changes. Plan Changes include revision, deletion, or addition of data on individual sheets, or adding and deleting entire sheets. Changes are not noted in the Revision Block on the sheets.

Project: Projects are identified by the Department through the Financial Project Identification Number (FPID) which becomes the name of the project's root folder. Note that multiple deliveries can occur for a single project, each representing the status of the project at the time of delivery.

Project Component/Discipline: All electronic files that represent and support a delivery by a discipline as part of a project.

Project Data Set: All of the files used or produced during the development of the project and placed in the Project Folder structure.

Project Component/Discipline Folder: The data structure and organization of electronic files on the storage media, as a sub-folder of the project's root folder.

Project Folder: The parent folder of a project containing all project component Folders and data (see Project Root Folder).

Project Manager: The person responsible for ensuring that the scope of work is accomplished for a project and the receipt, acknowledgment, validation and acceptance of the project data.

Project Root Folder: The file system folder that contains all projects' files and folders. The project root folder should not contain files that do not pertain to the project, nor should files that are part of the project reside outside of the project root folder, or one of its sub-folders.

Properties (AutoCAD) – The settings applied to an element for visualization/printing purposes, such as Color, Linetype, Line weight, Transparency, etcetera.

Quality Assurance (QA): The planned, coordinated and continued activities performed to measure processes against predetermined critical requirements.

Quality Assurance (QA) Monitoring Plan: A QA work plan for CADD developed with District input that identifies what, where, when and how monitoring, reporting, tracking and follow up are to be performed.

Quality Control (QC) Reports: Reports that must be included with the final project delivery, including the Compliance Certification Checklist Report and all reports listed therein. Some reports are produced by software within the Department's CADD Software.

Quality Control (QC): The planned, integrated activities performed during work processes to ensure completeness, accuracy, proper decision making, and conformance with all other valid requirements.

Reference File: A design file or other file type that is attached to and viewed simultaneously with the active design file.

Resolution: The number of addressable points across a given area. For example, printer resolution is measured in lines or dots per inch, while screen resolution is usually given indicating the number of pixels across the width and height of the largest image that can be displayed. MicroStation design files have a user-definable resolution, called Units of Resolution (UORs).

Revision Set: The set of files that includes only the changed files from one revision to the next.

Revision: FDM 131.2.2 defines a design revision as a modification to the *Plans, Specifications & Estimates* (PS&E) Submittal after it has been accepted by Final Plans.

Seed File: A predefined settings file used to create a new design files or cell libraries.

Seed Project: A predefined folder structure that contains all folders listed further in this chapter, as well as other project configuration files. The "seed" is the beginning structure of a project which gets populated with data as the project development occurs.

Sheet Navigator: An application which runs within MicroStation, allowing users to browse and open MicroStation files containing sheets for verification or editing. Its purpose is to 'tag' sheets with data that supports later processes for both Indexing and Printing. It is a foundation utility for delivery processes and should be run against every MicroStation design file containing sheets.

Sheet: A single page in a multipage PDF.

Sheet Set Organizer (SSO): An application which runs in conjunction with AutoCAD's Sheet Set Manager. Its purpose is to combine and organize FDOT Sheet Set (.dst) files created by Sheet Set Manager. It updates fields in DWG files with data that supports later indexing and printing. It is a foundation utility for subsequent delivery processes using AutoCAD Civil 3D, ensuring sheet data can be extracted properly.

Signatory: The person or professional who secures files in a delivery using electronic cryptographic means such as Digital Signature. If the signatory is a professional, signatures will be governed by the rules defined by the Florida Boards of Professional Regulation. A professional may have multiple signatories for a project as needed by the revision process.

Signature Sheet(s): The Digital Delivery process uses a Signature Sheet to define a professional's area of responsibility for portions of the document being digitally signed. Signature Sheet(s), in the case of a plans set, is one or more sheets following a Key sheet which bears the digital signatures of the Professional(s) of Records. The Signature Sheet is a convenient location for placing a digital signature appearance when there are multiple individuals signing a plan set. By placing a digital signature on the signature sheet of a plans set, the Professional(s) of Record associates his/her professional signature with the entire plan set (for example: 61G15-23.004); therefore, notation must be provided on the signature sheet for a scope delineating the extent of the Professional's responsibility and an index of the specific sheets in the plan set for which the Professional is accepting responsibility (also 61G15-30.003 Minimum Requirements for Engineering Documents). (See the Department's FDM 302 with Exhibits 302-1 & 302-2 and Chapter 303 with Exhibits 303-1 & 303-2, for further explanation and examples.)

Signing and Sealing: Digital Signature relies upon Public Key Infrastructure to embed secure data into a file the Signatory signs or signs and seals. Any restriction upon the scope of responsibility, usability, or reliability of the file being signed must show with the appearance of the digital signature in that document.

Standard Operating Instructions: Instructions for operating CADD applications intended to help guide the user in CADD production activities.

Statewide CADD Coordinator – Individual in the Central Office responsible for coordinating amongst the Districts to implement a uniform policy and standards for CADD operations for the Department.

Strung Project: Two or more projects let in the same contract.

Sub-Consultant: A consultant, separate from the primary consultant, who performs work for a project under the hire of a prime consultant.

Sub-Delivery: A delivery of files made by a sub consultant to a consultant, prime consultant or project manager, where that delivery is only a portion of the overall project.

Supporting CADD Files – Any file, including Resource Files (such as fonts, line styles, pen tables, cell/block libraries, etcetera.) required to produce the printable sheet images of a plan set.

Surface: A surface, in the context of 3D engineered models, represents an element of design such as existing ground, final grading, or pavement in three-dimensional workspace. All elements of the surface are spatially oriented to one another.

Symbol – A character placed from a TrueType font, MicroStation font library, or AutoCAD font file.

Symbology (MicroStation) – The settings applied to an element for visualization/printing purposes, such as Color, Line Style, Line Weight, Transparency, etcetera.

Text Attributes/Properties – The color, weight, font, height and width of text.

Text Element/Objects – Text in (MicroStation/AutoCAD) design files as a distinct type of element.

Units of Resolution (UORs) (MicroStation) – The distance between adjacent points in a MicroStation design plane. There are a very large number of fixed discrete positions or UORs along each coordinate axis that are defined as real world coordinates by master units and sub-units (collectively, working units).

Validation: Validation is done in Digital Signature; however, the validating application will compare hashes embedded cryptically within the file against ones calculated "on the fly" to see if a document has changed. The Validation extends to the hosting application verifying the identity of Signatory by using the Root Certificate to contact the Certificate Authority over the internet and checking identity records to ascertain the authenticity of the Signatory.

Working Area (MicroStation) – Size, in working units square, of design plane.

Working Units (MicroStation) – The real-world units in MicroStation that the design plane is configured to, such as US Survey Feet.

1.5 SCOPE

The *CADD Manual* is to be used by all personnel producing projects utilizing CADD for the Department. It is to be referenced in contracts requiring engineering plans and 3D Models preparation utilizing CADD. This manual affects all offices of the Department and all consultants, contractors and others who utilize CADD applications. The Districts are monitored for critical requirements to meet the Department's CADD Quality Assurance objectives.

1.6 ORGANIZATION

The Department's Production Support CADD Office, with input from the districts and industry, will develop and maintain procedures and standards for the Department's CADD production and related activities.

The following chapters are included:

- Chapter 1 INTRODUCTION:** Describes and implements the *CADD Manual*.
- Chapter 2 CADD COMPUTER SYSTEMS:** Establishes the minimum requirements for procurement, maintenance and technical support of the Department's CADD systems.
- Chapter 3 CADD SOFTWARE, DEVELOPMENT AND DISTRIBUTION:** Establishes how the Department's CADD Software is developed, tested, approved and distributed.
- Chapter 4 CADD SUPPORT:** Establishes the Department's CADD support structure and services, including the statewide training.
- Chapter 5 CADD STANDARDS:** Establishes the Department's critical CADD Standards to be used in the production of the Department's CADD projects.
- Chapter 6 CADD PRODUCTION PREREQUISITES:** Establishes the initial steps and processes for preparing the final Computer Aided Design and Drafting (CADD) Projects for the Department.
- Chapter 7 CADD PRODUCTION SUPPORT:** Establishes the minimum CADD project production requirements for the Department's CADD projects.
- Chapter 8 CADD DELIVERY:** Establishes the minimum requirements and functions necessary for Department's CADD project delivery process.
- Chapter 9 CADD QUALITY ASSURANCE AND QUALITY CONTROL:** Establishes the minimum requirements and functions necessary for Department's CADD project review process.

1.7 ROLES AND RESPONSIBILITIES

1.7.1 CADD Office

The CADD Office establishes policies, procedures, and standards to provide automation and quality assurance for the production requirements of CADD projects.

The CADD Office is responsible for the publication of the Department's CADD Manual.

The CADD Office provides software customization, training and support for CADD applications and recommended application workflows to the Department's CADD community.

The CADD Office coordinates with CADD Managers and CADD Technical Advisory Committees (TACs) on revisions, additions, issues, etc. to the CADD Manual and CADD Software.

1.7.2 CADD Managers

CADD Managers in Department offices ensure adherence of the policies, procedures, and standards of the CADD Manual.

The CADD Manager is responsible for communicating needs regarding application development, customization, support, training, quality control, document management, etc. to the CADD Office. This includes identified application issues reported by the CADD Community.

CADD Managers assists the CADD Office in developing CADD policies, procedures, and standards and provide reviews to the CADD Manual.

CADD Managers help develop CADD users in specialized application areas and identify members for consideration for the various CADD Technical Advisory Committees (TACs).

1.7.3 CADD Technical Advisory Committees (TACs)

CADD TACs are organized by CADD application Components/Disciplines; i.e. roadway, drainage, traffic, structures, construction, etc. TACs meet on a regular basis, usually quarterly, to discuss CADD topics related to their Component/Discipline. General guidelines for Department TACs are accessible by FDOT staff from the Production Support CADD Office SharePoint website link:

<https://fdot.sharepoint.com/sites/FDOT-Design/CADD/TACS/TacPages/Guidelines.aspx>

The District and Central Office are both represented on the TACs by knowledgeable and proficient CADD users. TACs are empowered to advance and improve the CADD policies, procedures, and standards and to identify application issues and needs for their specific Component/Discipline. All recommendations for change are processed through the applicable TACs and provided to the CADD Managers and the CADD Office to implement.

1.8 DISTRIBUTION

The *CADD Manual* is distributed in electronic form and may be downloaded from the Production Support CADD Office website: <http://www.fdot.gov/cadd/downloads/publications/publications.shtm>

1.9 TRAINING

Training issues and opportunities are identified within Chapter 4 of this document.

1.10 LINKS AND FORMS

1.10.1 CADD Quick Links

[CADD Conferences, Events, & Presentations CADD Links](#)

[CADD Software Currently Supported](#)

[CADD Software Downloads](#)

[CADD Support Community](#)

[CADD Support Email](#)

[CADD Technical Advisory Committees \(TACs\) \(FDOT Staff Only\)](#)

[CADD Training Course Guides](#)

[FDOT Roadway Design and 3D Modeling Training Guide](#)

[CADD Training Webinars - Live](#)

[CADD Training Webinars - Posted](#)

[CADD Website](#)

[FDOT 3D Deliverables Support Resource](#)

[FDOT Automated Quantities Training Guide](#)

[FDOT CADD Rule Tables](#)

[FDOT Approved Digital Certificate Authorities](#)

[FDOT Construction Publications](#)

[FDOT Contact Management Alert System](#)

[How to use FDOT Contact Management](#)

[Custom Line Styles/Linetypes Table \(Standard Symbols\)](#)

[Standard Plans FY 2018-19 Revisions Log \(Standard Symbols\)](#)

[FDOT Plans, Specifications & Estimates \(PS&E\)](#)

[FDOT Standard Abbreviations - FY 2018-19 Standard Plans](#)

[FDOT Structures Manual](#)

[FDOT Survey & Mapping Office Documents and Publications](#)

[FDOT Survey Feature Codes Table](#)

[FDOT Training YouTube Channel](#)

[Geospatial County Maps](#)

[GoToMeeting](#)

[Hardware Minimum Configuration Standards \(FDOT Staff Only\)](#)

[National CAD Standard](#)

[QC Review for 3D Engineering Models Webinar & QC Checklist](#)

[Request CADD Support](#)

[Roadway Design Memorandum 18-02 - Project Documentation](#)

[Unicode Mapping Standard](#)

[Uniform Drawing System \(UDS\)](#)

[U.S. CADD/GIS Technology Center](#)

1.10.2 Forms

1.10.2.1 Suggestions, Comments, or Questions for the CADD Manual

Chapter 1 of this document authorizes the development and implementation of the *CADD Manual* and is the only chapter subject to the Executive Review Process. Substantive revisions to this chapter that result in policy change must be coordinated with the Executive Committee *in* accordance with *Procedure No. 025-020-002, Standard Operating System*.

The remaining chapters of this document will be updated and approved by the Statewide CADD Coordinator with input from the Districts and offices within the Central Office that may be affected. All updates must be coordinated with the Forms and Procedures Office prior to distribution to ensure conformance with and incorporation into the Department's Standard Operating System.

The Suggestion and Comment sheet displayed below provide an opportunity for feedback regarding the CADD Manual. All proposed changes, either in draft or final form, will be reviewed for implementation.

[THIS PAGE INTENTIONALLY LEFT BLANK]

1.10.2.2 Compliance Certification Checklist

All Department Project deliveries must be provided to the Department's Project Manager, unless an alternate agreement is reached, along with a Compliance Certification Checklist (or similar document). This basic checklist may be employed to help the data producer consider critical items in their QC review for delivery. For more details see Section 8.4.6 of this document.

Note The Department's Districts may use a more comprehensive Compliance Certification Checklist in their QA process than the example in this document. The Department recommends this type of QC compliance documentation be submitted digitally inclusive within the \admin\ or \data\ project sub-folders.

[THIS PAGE INTENTIONALLY LEFT BLANK]

State of Florida Department of Transportation
COMPLIANCE CERTIFICATION CHECKLIST

- 1. Have Project Journal(s) been created containing all necessary project information?
- 2. Are the CADD/Design software packages and versions used to create all delivered files documented in the Project Journal?
- 3. Are all the native files generated by the CADD/Design software documented in item 2 above included in the delivery package?
- 4. Are all user-created CADD System resource files (line styles/linetypes, fonts, etcetera), that may have been used with the project, included in the delivery package?
- 5. Has the Department's QC software been run against the design files for compliancy with the Department's CADD Standards for folder structure, file naming, and element symbology with the resultant QC Compliance Reports included in the delivery submittal?
- 6. Has the Department's FileChecker been run to verify folder structure, file naming standard, etcetera?
- 7. Have the prescribed Project Documentation been delivered in accordance with [FDM 111.7](#) as directed by the [Roadway Design Memorandum 18-02](#)?
(see Sections 7.4.1 Project Folder Structure and 8.4.4.1 Engineering Data of this document)
- 8. Have the 3D deliverable files been created in accordance with the CADD Delivery chapter of the CADD Manual?
- 9. Have images for all sheets in the plan set been checked for sheet size, scale, and rotation/orientation, stored in PDF format and included in the delivery package?
- 10. Has the Electronic Plan Note been placed on each sheet in the plan files, as referenced by the Department's FDM 130, and then signed and sealed?
- 11. Has a Digital Signature been applied to the correct files signed with the appropriate Digital Certificate and independently validated in accordance with the Delivery chapter of the CADD Manual?
- 12. Has the final media for submission been properly labeled and authenticated in accordance with the Delivery chapter of the CADD Manual?

FPID: _____

Date of Scope: _____

Certified by EOR: _____

[THIS PAGE INTENTIONALLY LEFT BLANK]

Chapter 2

CADD COMPUTER SYSTEMS

2.1 PURPOSE

This chapter establishes the minimum requirements for procurement, maintenance and technical support of the Florida Department of Transportation (Department's) Computer Aided Design and Drafting (CADD) systems.

2.2 SCOPE

These requirements apply to all computer technology and services within the responsibility of the Production Support CADD Office (CADD), the CADD Managers of each District, Office of Information Technology (OIT), and Information Technology (IT) personnel assigned to support the CADD program.

2.3 PROCUREMENT OF CADD HARDWARE AND SOFTWARE

The CADD Managers and OIT personnel review the statewide CADD computer hardware needs to provide recommendations for procurement of any of the Department's CADD hardware where appropriate and do so in accordance with *Information Technology Resource User's Manual, Topic No. 325-000-002*.

The Production Support CADD Office participates with OIT in the development of the Information Technology Resource Standards and evaluation of the Department's computer hardware to be procured for use in CADD.

The Production Support CADD Office, in conjunction with the Technical Advisory Committees (TACs) and CADD Managers, reviews the statewide CADD Software needs to support the Department's production efforts.

2.4 MINIMUM SYSTEM REQUIREMENTS

The Department's CADD Software is developed, tested and configured on the Department's Minimum Hardware Configurations. The Hardware Minimum Configuration Standards can be access by FDOT staff from the Department's Office of Information Technology (OIT) intranet SharePoint website:

<https://fdot.sharepoint.com/sites/FDOT-OIS/Internal/OpGov/SitePages/HwMinConfig.aspx>

Other software configurations may operate with the Department's CADD Software. Use and support of the Department's CADD Software on other configurations are the sole responsibility of the user.

CADD Workstations should operate with the most currently supported versions of the Department's CADD Software for the Department's projects, unless otherwise exempted by either the project's Scope of Services or a written exemption by the Department's Project Manager.

2.4.1 Optimal CADD Hardware/Software Requirements

[Optimal CADD Requirements / Current Versions](#)

[THIS PAGE INTENTIONALLY LEFT BLANK]

Chapter 3

CADD SOFTWARE, DEVELOPMENT AND DISTRIBUTION

3.1 PURPOSE

This chapter establishes how the Florida Department of Transportation (Department's) Computer Aided Design and Drafting (CADD) software is developed, tested, approved and distributed by the Production Support (CADD Office).

3.2 SCOPE

This chapter applies to the Department's supported CADD Software products procured or developed to produce the Department's projects and covers the steps used to develop, test, approve and distribute these CADD Software products. The Department's CADD Software is the responsibility of the Production Support CADD Office (CADD) and other designated offices.

3.3 SUPPORTED CADD PLATFORMS

The Department supports both Autodesk's AutoCAD and Bentley's MicroStation CADD platforms. Civil Design software applications for both Autodesk and Bentley; e.g. Civil 3D, PowerGEOPAK, OpenRoads, etc. are supported by the CADD Office for the CADD Community. All efforts are made to support development and training of CADD Software whether Autodesk or Bentley software is used so the resulting contract deliverable products are transparent for the end users of CADD projects. Other CADD related software for specific applications are used and supported by the Department for component/discipline specific needs. Current software supported by the CADD office can be found at the following website:

[CADD Software Currently Supported](#)

3.4 CADD SOFTWARE DEVELOPMENT

Development by the CADD Office encompasses Department specific CADD Software applications, enhancements to existing CADD Software (added features), and maintenance releases of CADD software. Development is based upon needs identification and may include the purchase of commercial software when appropriate.

CADD Software needs are communicated to the CADD Office by the District CADD Managers, CADD Technical Advisory Committees (TACs) or the CADD Community. The CADD Office also identifies needs based upon experiences with CADD support activities and the evolution of trends in the CADD Software industry.

Development requests are managed by the CADD Office and coordinated through TACs, CADD Managers and OIT personnel assigned to support CADD.

The CADD Office will decide whether to develop CADD Software in-house, contract for development services, or purchase a CADD Software commodity. The CADD Office will keep the user community informed as to procurement status (including training and implementation schedules) of major CADD development projects of statewide interest.

3.5 CADD SOFTWARE UPDATES

The CADD Office, with input from Central Office Design, Districts Design and the CADD community, develops and maintains the Department's CADD Standards for CADD production and related activities. The CADD Office delivers the Department's CADD Software to reflect those standards and maintains the *CADD Manual* in coordination with the CADD Software to document those standards.

The Department's CADD Software is upgraded quarterly including file changes, new files and application enhancements that have occurred since the last upgrade. The quarterly CADD Software upgrades along with the updates to the *CADD Manual* are approved for release by the CADD Office.

3.5.1 CADD Software Testing

The CADD Office performs alpha testing of new CADD Software products during software development prior to the scheduled quarterly releases. At times beta testing is performed prior to major releases of CADD software. The beta testing by the CADD Community will be managed by the CADD Office and specific users will be identified and approved by the CADD Office, CADD Manager or CADD IT Services. The request for approval to proceed with beta testing, based on the appropriate recommendation, will be initialized by the CADD Office.

3.5.2 CADD Software Release Notifications

The CADD Office sends notification of the *CADD Manual* updates and CADD Software releases to the CADD community via the [Production Support CADD Office website](#), the Department's [FDOT Contact Management Alert System](#) (See [FDOT Contact Manager](#) for how to register for alerts), announcements during training sessions, emails, phone support, and other venues as appropriate.

3.5.3 CADD Software Release Distribution

The CADD Office is responsible for the distribution of the quarterly CADD Software releases and CADD Maintenance Releases (MRs) using Service Requests opened with the FDOT Service Desk to notify IT Services and CADD Managers when new releases are posted for internal FDOT CADD users. The District IT Services, in coordination with the CADD Managers, are responsible for distributing the approved software for production use to the end users.

The CADD Software is accessed through the CADD Office Download website: [CADD Software Downloads](#).

Chapter 4

CADD SUPPORT

(CUSTOMER SUPPORT GUIDE)

4.1 PURPOSE

This chapter establishes the primary components of the Florida Department of Transportation (Department's) Computer Aided Design and Drafting (CADD) support structure and services, including the statewide training, and defines the applications and tools supported by the Production Support (CADD Office).

4.2 SCOPE

This chapter applies to the CADD Community to establish the hierarchy of CADD-related support roles and responsibilities from the peer level to the statewide level of the CADD Office, the District CADD support function, and the CADD Technical Advisory Committees (TACs).

4.3 OVERVIEW

The Department supports a core group of CADD Software products for in-house production as specified herein. The CADD Community support is generally limited to the Department developed CADD Software modules, interfaces, and configurations. The statewide CADD support is coordinated through the CADD Office. Currently supported versions of CADD Software products can be found on the CADD websites:

[CADD Software Currently Supported](#)

[CADD Software Downloads & Installation Requirements](#)

Note Most of the core CADD Software products are commercial programs that the Department has purchased a license to use. The Department makes no warranty, expressed or implied, as to the documentation, functionality or performance of these or other Department developed programs described herein.

The primary components of the CADD Support structure include:

- ✓ Systems Support
- ✓ Operational Support
- ✓ Training Support
- ✓ Reporting of CADD Issues (online)

The Department maintains a self-serve [FDOT Contact Management Alert System](#) for email notifications on specific Departmental topics of interest. Users can Register and Sign up for notices sent out for CADD Software releases, CADD Training, CADD Notifications, etc. by selecting the options for "CADD". For "How to..." assistance select [How to Sign Up for FDOT Contact Manager Alerts](#) help document or [FDOT Contact Manager Alerts](#) webinar.

4.4 SYSTEM SUPPORT

The CADD Office manages and coordinates the testing, selection, procurement, and maintenance of the supported CADD systems used by the engineering community to perform the Department's CADD production with assistance from the district CADD Managers and/or OIT personnel assigned to support CADD.

The hierarchy of Systems Support is as follows:

- ❖ **First Level:** The First Level of Systems Support is the District staff. The CADD Manager and/or District CADD IT contacts are the primary liaisons with the CADD Office for addressing CADD systems issues. District CADD Manager and/or OIT personnel support responsibilities include the following:
 - ✓ Identify the users' hardware and software needs.
 - ✓ Distribute and setup of equipment and CADD software.
 - ✓ Provide input for the statewide procurement.
 - ✓ Provide day-to-day technical support of the computer hardware and CADD Software systems used in the District.
- ❖ **Second Level:** The Second Level of Systems Support is the OIT staff. The OIT support responsibilities include the following:
 - ✓ Manage the budget for procurement of CADD hardware.
 - ✓ Procure CADD hardware and maintenance.
 - ✓ Provide inventory management associated with the statewide CADD hardware.
 - ✓ Provide as-needed technical support of the hardware.

4.5 OPERATIONAL SUPPORT

The CADD Office manages and coordinates the development, enhancement and support of the CADD Software applications used by the engineering community to perform the Department's CADD production with assistance from the district CADD Managers and/or OIT personnel assigned to support CADD.

The hierarchy of Operational Support is as follows:

- ❖ **First Level:** The First Level of Operational Support is through local Peer Support.
- ❖ **Second Level:** The Second Level of Operational Support is through the Technical Advisory Committee (TAC) Members Support, who represent the Districts and Component/Disciplines on task teams to communicate and resolve support issues of statewide interest. Contact information can be found on the CADD Office website: [CADD Technical Advisory Committees \(TACs\)](#) (*FDOT Staff Only*)
- ❖ **Third Level:** The Third Level of Operational Support is District Support Staff, including, but not limited to your: CADD Managers, CADD IT contacts, and engineering services personnel. These support personnel, collectively, are responsible for supporting the core CADD Software products for each respective district.
- ❖ **Fourth Level:** The Fourth Level of Operational Support is the CADD Office support staff. The CADD Office is responsible for the Department's CADD application development, enhancements, and support to provide or procure required vendor services, as necessary, for user assistance.

4.6 TRAINING SUPPORT

The Department through the CADD Office manages and coordinates the provision of CADD technical materials and training to assist in maintaining user proficiency with assistance from the district CADD Managers and/or OIT personnel assigned to support CADD.

The CADD Training Plan will encompass the core CADD Software and CADD production procedures. The District CADD Managers, District and Unit Training Coordinators, and/or OIT personnel assigned to support CADD are responsible for respective District CADD training coordination.

Training instructors will be pulled from the Department's Central Office experts or from the augmented Training Support Contracts specifically setup for this training. The CADD Training Plan will cover all software platforms and will offer three (3) areas of training format opportunities:

- ❖ **CADD Regional Training** – Full scheduled workflow instructor-led curriculum covering the standard CADD production workflow topics scheduled within the Districts. Participation is credited to each Departmental staff training records upon completion of courses.
- ❖ **CADD Academy Training** – Full scheduled workflow web-based curriculum set in the Department's statewide Learning Curve system. Participation is credited to each Departmental staff training records upon completion of course modules.
- ❖ **District Project Based Training** – One (1) Week per district of Project based hands-on training coordinated by each district with the Production Support CADD Office to schedule as needed.

The CADD Office offers other opportunities and resources for training users in the Department's CADD Software including, but not limited to:

[CADD Support Community](#) – Online discussion of ongoing MicroStation issues monitored and used by the CADD office. Autodesk Discussion Groups access is provided on the software Help ribbon.

[CADD Training Course Guides](#) - Full line of training for the Department's CADD Software used within the course or self-help for the individual user and complete with data sets.

[CADD Training Webinars - Live](#) – Online registration for GOTO Webinars addressing the hottest topics and most frequently asked questions.

[CADD Training Webinars - Posted](#) - List of FDOT CADD Webinar, also found on FDOT Training YouTube Channel.

[FDOT Training YouTube Channel](#) – **The CADD Office offers all the current recorded webinars and training for all users to access via YouTube. These match what is available from the CADD Office website.**

[GoToMeeting](#) - Daily one-on-one support, utilizing the GoToMeeting software to connect with any user computer for instant assistance. GoTo Meeting can also be access from the FDOT Menu within a design software session.

[CADD Links](#) - List of the on-line resources used when researching CADD issues.

[CADD Conferences, Events, & Presentations](#) - The CADD Office offers seminars at various Conferences and events throughout the state, such as, the FDOT Transportation Symposium, etc.

4.7 REPORTING OF CADD ISSUES

When reporting CADD issues, requests or comments the following information (*where applicable*) is needed for CADD Support staff to assist:

- ✓ User Contact information (include both phone and e-mail)
- ✓ CADD Software platform and version, configuration and/or related applications used
- ✓ Description of issue & how to reproduce (attach applicable files, screen shots, etc.)
- ✓ Impact to user workflow
- ✓ Best time to contact user

The Department offers the following venues, managed and coordinated by the CADD Office, to report CADD issues, requests or comments:

[Request CADD Support](#) - The CADD Office facilitates a user Support portal to directly input an issue ticket into the Department's service desk. This requires a one-time request to create a user login account. Your ticket will be routed to the next available CADD Support staff who will contact you for assistance. Once entered the user may login at any time to check the status of their open issues.

Note The Request CADD Support option is also available within both Bentley and Autodesk software platforms.

[FDOT CADD Bentley \(BE\) Support Community](#) - The CADD Office facilitates an online MicroStation discussion group accessing the CADD community resources for solutions to issues. Along with the CADD Community, the CADD Support staff monitors and utilizes this site through an automated alert system to respond to incoming issues.

[FDOT CADD Autodesk Discussion Forum](#) - The CADD Office facilitates an online Autodesk discussion group accessing the CADD community resources for solutions to issues. Along with the CADD Community, the CADD Support staff also monitors and utilizes this site to respond to incoming issues.

[CADD Support Email](#) - The CADD Office facilitates a CADD Support email address that routes all incoming email to the whole CADD Support staff to ensure that the first available staff can address CADD issues on a timely basis. This email should always be used in lieu of any direct email request, comment or suggestion in the case the individual CADD Support staff is out of the office or unavailable.

[CADD Technical Advisory Committees \(TACs\)](#) - The CADD Office facilitates statewide self-directed work teams representing all CADD users of CADD systems and programs in a functional area or Component/Discipline for issues that involve requests for changes in the way of doing business or enhancements. This is a link to the CADD Office – TAC website reflecting contact information for all CADD TACs.

[By Phone – \(850\) 414-4380 \(Main\)](#) - There is main reception line for the Production Support Office with someone to route your call to the first available CADD Support staff.

Chapter 5

CADD STANDARDS

5.1 PURPOSE

This chapter defines the Florida Department of Transportation (Department's) critical Computer Aided Design & Drafting (CADD) Standards to be used in the production of the Department's CADD projects.

5.2 SCOPE

These CADD Standards apply to all projects produced by and for the Department using CADD in addition to the Department's custom criteria, standards and procedures of the various Components/Disciplines within the Department.

5.3 GENERAL

The Department develops CADD Standards through the Production Support (CADD Office) for production of Florida transportation plans to be delivered with the aid of the CADD Software. The CADD Office manages and coordinates these CADD Standards through customizations within the Department's approved CADD Software platforms and the tools contained in the CADD Software.

The CADD Software includes standard design libraries/templates to propagate the CADD Standards definitions of levels/layers and symbology (color, line styles/linetypes, weights), multi-line styles, text styles, dimension styles, cells, element templates, menu customizations, customized tools, tool boxes, and tasks for two platforms: MicroStation and AutoCAD. The Department's custom CADD resource definitions for CADD drawings are generally consistent between the MicroStation and AutoCAD platforms. The following are examples of platform conventions:

<u>MicroStation</u>	<u>AutoCAD</u>
Database file	Database file
Seed file	Drawing Template
Design Library	Drawing Template
Cell Library	Block Drawing
Cell Name	Block Name
Print Configuration	Print Configuration
File Name	File Name
Level Name	Layer Name
Color	Color
Line Style	Linetype
Line Weight	Line Weight

Projects will be maintained and updated with the most currently available versions of CADD Software published and downloadable from the CADD Office website: [CADD Software Currently Supported](#). Exceptions must be approved by the Department's Project Manager, documented and delivered as part of the Department's project.

5.4 DATABASE (DDB) RESOURCES

5.4.1 MicroStation

For MicroStation projects the Department's CADD Software includes a GEOPAK Design and Computation (D&C) Manager (*DDB*) database file set up specifically to create drawing elements and attach pay item data according to the Department's CADD Standards.

The GEOPAK D&C Manager (*DDB*) database may need to be modified for project specific items or to comply with District standards. If the database is customized, a copy of this project specific custom database must be saved into the project folder in the *\symb* sub-folder to ensure the modified database will be delivered with the project.

When modifying project specific database resource, the following naming convention must be used:

Project Financial Project Identification Number[Component/Discipline Designation].ddb

Where *[Component/Discipline Designation]* would be one from the following:

dr	(drainage)
it	(intelligent transportation system)
ld	(landscape)
lt	(lighting)
rd	(roadway)
sg	(signalization)
sp	(signing and pavement markings)
ut	(utilities)

Example: Modified Signalization DDB: **19728125201sg.ddb** stored in **19728125201\symb** subfolder.

5.4.2 AutoCAD

For Autodesk projects the Department's CADD Software includes an Entity Manager Pay Item Database (*Payitemdb*) file set up specifically to create drawing entities and attach pay item data according to the Department's CADD Standards.

The *Payitemdb* may need to be modified for project specific items or to comply with District standards. If the *Payitemdb* database is customized, a copy of this custom database must be saved into the project folder in the *\symb* project sub-folder to ensure the modified database will be delivered with the project. When modifying project specific database resources, the following naming convention must be used:

Project Financial Project Identification Number[Component/Discipline Designation].xml

Where *Component/Discipline Designation* would be one from the following:

dr	(drainage)
it	(intelligent transportation system)
ld	(landscape)
lt	(lighting)
rd	(roadway)
sg	(signalization)
sp	(signing and pavement markings)
u	(utilities)

Example: Modified Signalization XML: **19728125201sg.xml** stored in **19728125201\symb** project subfolder.

5.5 SEED/SHEET TEMPLATE FILES

5.5.1 MicroStation Seed Files

MicroStation uses “seed” files to create all design files. Working units and global origin are two of the most important settings in the seed file. Working units are expressed as master units and sub-units. All standard seed files for MicroStation have been defined based on a master unit of “Survey Feet” with a sub unit of “Survey Inches.” The global origin is located at the center of the design plane for all seed files.

Component/Discipline	Seed Filename	Description
Right of Way	rwseed2d.dgn	Right of Way Seed File
Roadway	fdotseed2d.dgn	Roadway 2D Seed File
Roadway	fdotseed3d.dgn	Roadway 3D Seed File
Roadway	fdotseedkeymap.dgn	Roadway Key Map Seed File
Roadway	fdotseedxs.dgn	Roadway Cross Section Seed File
Structures	structuresseed.dgn	Structures Seed File
Structures	structuresseed3d.dgn	Structures 3D Seed File
	fdotmaster.dwt	FDOT Master

The resolution in MicroStation files is defined per the master unit and determines the size (working area) of the design plane, which must encompass an area large enough for any State Plane coordinate zone in Florida. The resolution is set to 304800 units of resolution (UORs) per Survey Foot.

The geographic coordinate system must be set to the appropriate Florida State Plane Zone in production drawings derived from the seed files.

5.5.2 AutoCAD Sheet Template Files

The FDOT Standard Sheet Borders, used for AutoCAD plan production for all Components/Disciplines, are listed below. The user accesses these files when using any of the AutoCAD Create Sheets wizard. Upon selection of the appropriate sheet template, a drawing scale is selected. Each Sheet Template file contains sheet layouts at designated scales along with fields in the border that can be automatically updated with project information, such as Sheet Title, Sheet Number, County, etc. The Cross Section sheet templates update with the appropriate material volume when sections sheets are created based on the material list selected in AutoCAD.

Component/ Discipline	Template Filename	Description
Right of Way	CSCOVER.dwt	Control Survey Cover Sheet
Right of Way	CSDETL.dwt	Control Survey Detail Sheet
Right of Way	MMCOVER.dwt	Maintenance Map Cover Sheet
Right of Way	MMDETL.dwt	Maintenance Map Detail Sheet
Right of Way	RWCOVER.dwt	Right of Way Cover Sheet
Right of Way	RWDETL.dwt	Right of Way Detail Sheet
Right of Way	RWPS.dwt	Right of Way Parcel Sketch Sheet
Right of Way	RWSHT.dwt	Right of Way Sheet
Right of Way	RWSPS.dwt	Right of Way Specific Purpose Survey Sheet
Right of Way	RWTAB.dwt	Right of Way Tabulation Sheet
Roadway	CTLSRD.dwt	Reference Points Horizontal Vertical Control Sheet Border
Roadway	SHDrainMap.dwt	FDOT Drainage Map Sheet Border
Roadway	SHPLAN.dwt	FDOT Sheet Border
Roadway	SHPlanDual.dwt	FDOT Dual Plan View Sheet Border
Roadway	SHPlanDual-Top.dwt	FDOT Dual Plan View Sheet Border
Roadway	SHPlanProfOpt.dwt	FDOT Plan Profile Optional Sheet Border
Roadway	SHPlanProfOpt-Intersection.dwt	FDOT Plan Profile Optional Intersection Sheet Border
Roadway	SHPlanProfStd.dwt	FDOT Plan Profile Standard Sheet Border
Roadway	SHProfDual.dwt	FDOT Dual Profile Sheet Border
Roadway	SHProfDualOpt.dwt	FDOT Dual Profile Optional Sheet Border
Roadway	SHProfile.dwt	FDOT Profile Sheet Border
Roadway	SHProfOpt.dwt	FDOT Profile Optional Sheet Border
Roadway	SHXSC.dwt	FDOT Cross Section 2' Grid Sheet Border
Roadway	SHXSC1EW2.dwt	FDOT Cross Section 2 Material Sheet Border
Roadway	SHXSC1EW3.dwt	FDOT Cross Section 3 Material Sheet Border
Roadway	SHXSC1EW3-Overbuild.dwt	FDOT Cross Section 2 Material with Overbuild Sheet Border
Roadway	SHXSC2EW2.dwt	FDOT Dual Vertical Cross Section 2 Material Sheet Border
Roadway	SHXSG.dwt	FDOT Cross Section 1' Grid Sheet Border
Roadway	SHXSG1EW2.dwt	FDOT Cross Section 1' Grid 2 Material Sheet Border
Roadway	SHXSG1EW3.dwt	FDOT Cross Section 1' Grid 3 Material Sheet Border
Roadway	SHXSG2EW2.dwt	FDOT Dual Vertical Cross Section 1' Grid 2 Material Sheet Border
Structures	StructuresKeySheetTemplate.dwt	Structures Key Sheet
Structures	StructuresPlanProfile.dwt	Structures Plan & Profile

5.6 DESIGN LIBRARIES/TEMPLATES

CADD Standard Design Library (dgnlib)/Design Template (dwt) files have been customized containing data that is shared throughout the Department's standard files and among users. These shared resources consist of, but not limited to, the Department's standard Cells, Levels, Styles, and Features.

5.6.1 MicroStation Design Libraries

Type	Design Library Name (DGNLIB)	Description
Civil_Cells	FDOT_Approach.dgnlib	FDOT Approaches
Civil_Cells	FDOT_BusTurnOut.dgnlib	FDOT Bus Turn Outs
Civil_Cells	FDOT_Circulatory.dgnlib	FDOT Circulatory
Civil_Cells	FDOT_CurbGutterMaker.dgnlib	FDOT Curb & Gutter Maker
Civil_Cells	FDOT_CurbTransitions.dgnlib	FDOT Curb Transitions
Civil_Cells	FDOT_DirectionalMedianOpenings.dgnlib	FDOT Directional Median Openings
Civil_Cells	FDOT_Driveways.dgnlib	FDOT Driveways
Civil_Cells	FDOT_FDM_Exhibits.dgnlib	FDOT Design Manual Exhibits
Civil_Cells	FDOT_Intersections.dgnlib	FDOT Intersections
Civil_Cells	FDOT_Ponds.dgnlib	FDOT Ponds
Civil_Cells	FDOT_RampTerminals.dgnlib	FDOT Ramp Terminals
Civil_Cells	FDOT_SidewalkCurbRamps.dgnlib	FDOT Sidewalks, Curbs, & Ramps
Civil_Cells	FDOT_Templates.dgnlib	FDOT Templates
Features	FDOT_CivilFeatures_RD.dgnlib	FDOT Civil Features for Roadway
Features	FDOT_CivilFeatures_RW.dgnlib	FDOT Civil Features for Right of Way
Features	FDOT_CivilFeatures_TC.dgnlib	FDOT Civil Features for Traffic Control
Features	FDOT_CivilFeatures_TP.dgnlib	FDOT Civil Features for Traffic Plans
Features	FDOT_CivilFeatures_UT.dgnlib	FDOT Civil Features for Utilities
Features	FDOT_ElementTemplates.dgnlib	FDOT Element Templates
Features	FDOT_SUE_Drainage.dgnlib	FDOT Subsurface Utility Engineering for Drainage
Features	FDOT_SUE_Uilities.dgnlib	FDOT Subsurface Utility Engineering for Utilities
Features	FDOT_SurveyFeatures_RD.dgnlib	FDOT Survey Features for Roadway
Features	FDOT_SurveyFeatures_RW.dgnlib	FDOT Survey Features for Right of Way
General	CivilCommands.dgnlib	Civil Commands
General	FDOT_DesignGeometricsCriteria.dgnlib	FDOT Design Geometrics Criteria
General	FDOTToolboxes.dgnlib	FDOT Toolboxes
General	GeoTech.dgnlib	Geotechnical
Levels	countymappinglevels.dgnlib	County Mapping Levels with Symbology
Levels	fdot_common_levels.dgnlib	FDOT Common Levels with Symbology
Levels	fdot_v8_levels.dgnlib	FDOT V8 Levels with Symbology
Levels	photogrammetry_levels.dgnlib	Photogrammetry with Symbology
Levels	rwlevels.dgnlib	Right of Way Levels with Symbology
Levels	strlevels.dgnlib	Structurres Levels with Symbology
Levels	survey_levels.dgnlib	Survey Levels with Symbology
Levels	v7_levels.dgnlib	v7 Levels with Symbology
Styles	FDOT_PrintStyles.dgnlib	FDOT Print Styles
Styles	FDOT_Styles.dgnlib	FDOT Styles
Styles	rwstyles.dgnlib	Right of Way Styles

5.6.2 AutoCAD Design Template Files

AutoCAD uses “template” files to create design files. Drawing units are US Survey Feet and the geographic coordinate system for production drawings derived from templates must be set for the project’s State Plane Zone. Templates are style-based AutoCAD drawings.

Template	Description
digitalsignature.dwt	Digital Signature
fdotmaster.dwt	Master Template
keysht.dwt	Key Sheets
planrd.dwt	Sheet Border for Details, Typical Sections & Summary Boxes
rwdtrd.dwt	Right of Way Detail for Roadway
rweng10.dwt	Right of Way
spst10.dwt	Structures
StructuresTemplateDetail.dwt	Structural Details
StructuresTemplatePlan.dwt	Structural Plans
survey.dwt	Survey Development Model
toporw.dwt	Existing Topography for Right of Way
TypSectionPkg.dwt	Typical Section Package
utadrd.dwt	Utilities Adjustment
utprrd.dwt	Utilities Proposed

5.7 DESIGN FILENAMES

The Department has defined a standard file naming convention for use in the production of the Department’s CADD projects. Specific standard design Filenames are defined within each Component/Discipline and associated with the Department’s standard CADD Rules (*Section 5.8 of this document*). Standard model names are also provided. These standard Filenames are stored within the specified Component/Discipline folders of the Department’s Project folder structure.

Standard Filename tables are provided and accessible from the links below. They are complete listings of applicable standard Filenames by Component/Discipline including Descriptions, associated CADD Rules and standard Model names.

FDOT Standard Filenames by Component Tables	
Component # per the FDM	Standard Filenames by Component/Discipline
	Master Filename Table
01	Roadway Filenames
02	Signing & Pavement Marking Filenames
03	Signalization Filenames
04	Intelligent Transportation Systems (ITS) Filenames
05	Lighting Filenames
06	Landscape Filenames
07	Architectural (<i>See Section 5.7.1.2 and 5.7.1.3 of this document.</i>)
08	Structures Filenames (<i>See Section 5.7.1.1 of this document.</i>)
09	Toll Facilities (<i>See Section 7.6.9 of this document.</i>)
10	Utilities Filenames
	Right of Way (ROW) Filenames
	Survey Filenames
	Drainage Filenames
	Environmental Management (EMO) Filenames
	Geotechnical Filenames
	Construction Filenames

5.7.1 Design File Naming Convention

The Department utilizes standard naming conventions for design files and provides applications that depend on these naming conventions being met. The naming convention also confers information to downstream users about the data contained within the design file. The Department delivers a *CreateFiles* application to assist in producing Design files with the standard naming convention.

There must not be duplicate CADD (DGN, DWG, etcetera) design filenames within a project folder structure. This is necessary to ensure proper reference attachments in CADD files. The Department delivers a *FileChecker* application to help find duplicate filenames within the project folder structure. MicroStation and AutoCAD, as part of their search sequence, will use the first occurrence of a filename found as they traverse a folder structure looking for reference attachments with no paths. Duplicate filenames for source attachments can “corrupt” data references. Always use the “relative path” option, but never “full” or “no path” when attaching references.

Note In the event a non-standard file name is required for the project, either the Project Manager or the District CADD Manager will be consulted to determine and approve of a proper filename to utilize.

➤ **Standard design filename format: AAAABB##.ext**

AAAA = Abbreviated File Description, specific for each Component/Discipline.

BB = Component/Discipline Designation,

= A file Sequence Number (*a padded integer, i.e. “00”, “01”, “02” ... “99”, used to sequence additional files of the same Description + Denotation*),

.ext = File Extension indicating the type of file.

For Example: The first proposed Roadway cross section file would be named: *rdxsrd01.dgn*

The first *six (6) characters* (AAAABB) of the standard design file naming convention described above are also critical triggers for QC software and symbology filters. If additional identifying information is necessary in the design filename, this descriptive information should be inserted after the Component/Discipline denotation “BB” and preceding the sequence number “##”. Letters (A-Z, a-z), numbers (0-9), dashes (-), and underscores (_) characters are the only legal characters in filenames. Characters and spaces that interfere with operating system path specifications or XML interpretation such as: (/ \ . : ; , < & # >”) must be avoided.

For Example: *rdxsrd-rampA-01.dgn*, might indicate this proposed cross section file includes Ramp A.

The *Sequence Number* (##) should be limited to two digits, but very large projects might necessitate the need to exceed two-digit sequence numbers (100+).

The typical *File Extension* types listed in the following tables may be used by other Components/Disciplines.

Extension	File Description	Saved-in Folder
.3pc	3 Port Criteria Files	Most appropriate component/discipline
.pdf	Files for the PLANS	Root project folder for <i>fpid</i> -PLANS.pdf for Digital Delivery.
.pdf	Files for the SPECS	\specs\ sub-folder for <i>fpid</i> -SPECS.pdf
.dxf	AutoCAD ASCII Drawing Interchange File	Most appropriate component/discipline
.dwg	AutoCAD Design Files	Most appropriate component/discipline
.dst	AutoCAD Drawing Sheet Set	\eng_data\ sub-folder for the
.dwt	AutoCAD Drawing Template	\seed\ sub-folder of the project
.lin	AutoCAD Linetype	\symb\ sub-folder of the project
.pc3	AutoCAD Printer Configuration	Most appropriate component/discipline folder or \symb\ sub-folder of the project
.shx	AutoCAD Shape Compiled	\symb\ sub-folder of the project
.shp	AutoCAD Shape Files are ASCII Files	\symb\ sub-folder of the project
.stb	AutoCAD Plot Style Tables	Most appropriate component/discipline folder or \symb\ sub-folder of the project
.csv	Comma Separated Values	Most appropriate component/discipline
.gpk	Coordinate Geometry Database Files	Most appropriate component/discipline
.alg	Corridor Modeling Alignment Database	Most appropriate component/discipline
.xlp	Corridor Modeling Cross Section Labeling Preference File	Most appropriate component/discipline
.xin	Corridor Modeling Drafting Standards	Most appropriate component/discipline

Extension	File Description	Saved-in Folder
.rdp	Corridor Modeling Roadway Design Preference File	Most appropriate component/discipline
.ird	Corridor Modeling Roadway Designer Database	Most appropriate component/discipline
.dtm	Corridor Modeling Surface Database	Most appropriate component/discipline
.itl	Corridor Modeling Template Library	Most appropriate component/discipline
.hmr	Descartes Raster Image Files	Most appropriate component/discipline
.gpk	GEOPAK COGO Database	Most appropriate component/discipline
.x	GEOPAK Criteria Files	Most appropriate component/discipline
.ddb	GEOPAK D&C Manager Database Files	Most appropriate component/discipline
.gdf	GEOPAK Drainage File	Most appropriate component/discipline
.dlb	GEOPAK Drainage Library	Most appropriate component/discipline
.inp	GEOPAK Input Files	Most appropriate component/discipline
.prj	GEOPAK Project Manager Project File	Most appropriate component/discipline
.tin	GEOPAK Surface Database	Most appropriate component/discipline
.gif	Graphics Interchange Format	Most appropriate component/discipline
.jpeg,/.jpg	Joint Photographic Experts Group	Most appropriate component/discipline
.log	Log File	Most appropriate component/discipline
.xls(x)	Microsoft Excel Spreadsheets	Most appropriate component/discipline
.doc(x)	Microsoft Word Documents	Most appropriate component/discipline
.rsc	MicroStation & GEOPAK Resource Files	\\eng_data\ sub-folder for
.cel	MicroStation Cell Libraries	\\cell\ sub-folder of the project folder
.dgn	MicroStation Design Files	Most appropriate component/discipline
.tbl	MicroStation Pen Tables	\\eng_data\ sub-folder for
.plt	MicroStation Print Drivers	\\eng_data\ sub-folder for
.pset	MicroStation Print Organizer Print Set	Most appropriate component/discipline
.pcf	MicroStation Project Configuration	Project Root folder
.dgnlib	MicroStation Standards Database	\\sybm\ if copied to local project
.sid	Multi-resolution Seamless Image Database	Most appropriate component/discipline
.ps	Postscript Sheet Image Files	\\eng_data\ sub-folder for
.xcp	QC Exception Files	\\eng_data\ sub-folder for
.txt	QC Reports, QC "Folder Name"	\\eng_data\ sub-folder for
.tif	Tagged Image File	Most appropriate component/discipline
.htm/.html	Web Pages	Project Root folder and \data\ sub-folder
.xml	XML Files	Most appropriate component/discipline

5.7.1.1 Structures Design File Naming Convention

The Department identifies Structural project design files with additional File Naming attributes to address and document specific bridge information. Structural Files must be created using the supplied Structures Seed/Template resource files included with the Department's CADD Software package. The Structures Seed/Template files for the FDOT Structures Workspace differs from other Seed files in both working units and unit labeling.

The Department delivers the **Create File** application within the CADD Software to ensure files are named, created and stored to Department CADD Standards in the \\struct\ component/discipline folder of the Project folder structure.

Note The Department's Structures Standard Filenames are defined in the **FDOT Standard Filenames by Component** tables found in Section 5.7.

➤ **Standard Filenames for Bridges format: B#AAAA...##.[ext]**

- B#** = Bridge Plans Sequence Number,
- AAAA** = Abbreviated File Description, specific for each component/discipline,
- ##** = A file Sequence Number (*a padded integer, i.e. "00", "01", "02" ... "99", used to sequence additional files of the same Description + Denotation*),
- .ext** = File Extension indicating the type of file.

For Example: First EndBent sheet of Bridge 1 in a plan set would be named *B1EndBent01.dgn*

Files containing Data Table cells should be named *B#DataTable##.dgn* and should be placed in the plans with the corresponding component detail sheet. Geotech files are listed in the Structures Filenames table to show the order of placement within the Structures plans component only. They should be stored in the \Geotech\ Project component/discipline folder and should follow Geotechnical Standards listed in this document.

➤ **Non-Bridge Related Filenames:**

Non-bridge related files are created in the Structures workspace using Structures seed files. Mast Arm and Overhead Sign Structure sheets are included in the Roadway plans. All other non-bridge related sheets are included in the Roadway plans when no Structures plans are present.

5.7.1.2 Architectural Design File Naming Convention

AutoCAD Architectural Standard Files are 3D for large plans, elevations or sections that contain the physical building components (walls, doors, water piping, beams...). These files are drawn in Model Space at full scale. These files are referenced in whole or part into sheet files where text and dimensions are added, then printed.

➤ **Architectural Naming Components:**

- ✓ Architectural Projects Identifier
- ✓ Discipline Codes
- ✓ Drawing Type Codes (General and Discipline related)
- ✓ File Sequence Number

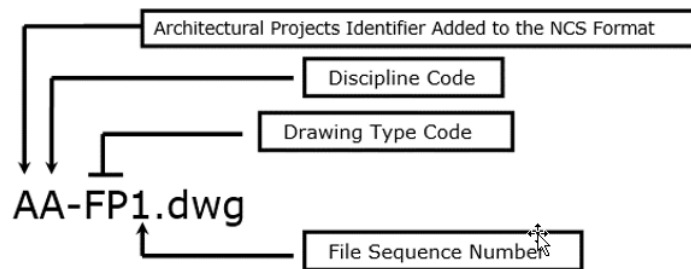

Note Architectural Projects Identifier: A _ _ _ .dwg
Add "A" before Discipline Code as published in National CAD Standards. This distinguishes Building drawings from Roadway and Structures Plans.

Examples: Project Identifiers, Codes and File Sequence Numbers. For more detailed information refer to National CAD Standards.

➤ **Architectural Project Identifier**

A_ _ _ _ .dwg Architectural, this differentiates architectural building projects from bridges and roadway projects.

➤ **Discipline Code**

_A- _ _ .dwg Architectural
_C- _ _ .dwg Civil
_Z- _ _ .dwg Contractor/Shop Drawings
_Q- _ _ .dwg Equipment
_E- _ _ .dwg Electrical
_M- _ _ .dwg Mechanical
_X- _ _ .dwg Other Disciplines
_P- _ _ .dwg Plumbing
_D- _ _ .dwg Process
_R- _ _ .dwg Resources
_S- _ _ .dwg Structural
_T- _ _ .dwg Telecommunications

➤ **Drawing Type Code (general and discipline related)**

_ _ -FP _ .dwg Floor Plan
_ _ -SP _ .dwg Site Plan
_ _ -DP _ .dwg Dimension Plan
_ _ -XP _ .dwg Existing Plan
_ _ -EL _ .dwg Elevation
_ _ -SC _ .dwg Section
_ _ -DT _ .dwg Detail
_ _ -CP _ .dwg Ceiling Plan
_ _ -EP _ .dwg Enlarged Plan
_ _ -NP _ .dwg Finish Plan
_ _ -RP _ .dwg Furniture Plan
_ _ -SH _ .dwg Schedules
_ _ -3D _ .dwg Isometric/3D
_ _ -DG _ .dwg Diagrams

➤ **File Sequence Number**

_ _ - _ 1.dwg 1st drawing file in sequence
_ _ - _ 2.dwg 2nd drawing file in sequence
_ _ - _ 3.dwg 3rd drawing file in sequence

5.7.1.3 Architectural Sheet Naming Convention

An Architectural Sheet File is a border sheet with dimensions and/or text added to a portion of a referenced model space file. Plotted sheet files make up the plans set.

➤ **Naming Components**

- ✓ Architectural Projects Identifier
- ✓ Discipline Code
- ✓ Sheet Type Code
- ✓ Sheet Sequence Number

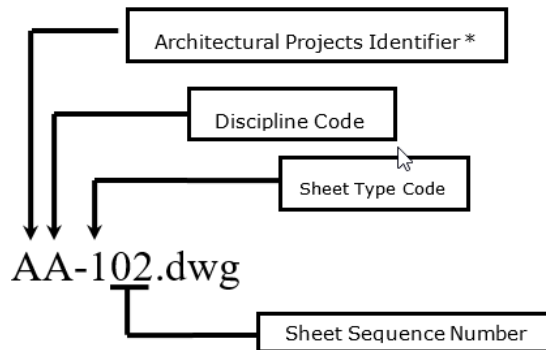

Examples: Project Identifiers, Codes and Sheet File Sequence Numbers. For more detailed information refer to National CAD Standards.

➤ **Architectural Project Identifier**

A _ _ _ .dwg.. Architectural, this differentiates Architectural building projects from bridges and Roadway projects.

➤ **Discipline Code**

_A- _ _ .dwg	Architectural
_C- _ _ .dwg	Civil
_Z- _ _ .dwg	Contractor/Shop Drawings
_Q- _ _ .dwg	Equipment
_E- _ _ .dwg	Electrical
_F- _ _ .dwg	Fire Protection
_G- _ _ .dwg	General
_B- _ _ .dwg	Geotechnical
_H- _ _ .dwg	Hazardous Materials
_I- _ _ .dwg	Interiors
_M- _ _ .dwg	Mechanical
_X- _ _ .dwg	Other Disciplines
_P- _ _ .dwg	Plumbing
_D- _ _ .dwg	Process
_R- _ _ .dwg	Resources
_S- _ _ .dwg	Structural
_T- _ _ .dwg	Telecommunications

➤ **Drawing Type Code (general and discipline related)**

--0	.dwg	General (symbols, legend, notes...)
--1	.dwg	Floor Plan
--2	.dwg	Elevation
--3	.dwg	Sections
--4	.dwg	Large Scale
--5	.dwg	Details
--6	.dwg	Schedules and Diagrams
--7	.dwg	User Defined
--8	.dwg	User Defined
--9	.dwg	3D Views (isometrics, perspectives...)

➤ **File Sequence Number**

--	01.dwg	1st sheet in sequence
--	02.dwg	2nd sheet in sequence
--	03.dwg	3rd sheet in sequence

➤ **Detail File Name Format**

The Detail File Name includes the sheet identifier and the detail identification number. Sheet Identifier is the sheet file that the detail is placed in. The detail identification number represents the location of the detail within the sheet file border.

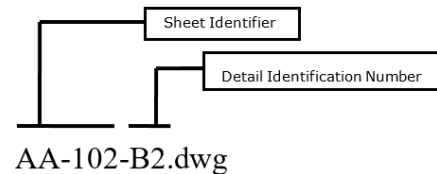

➤ **Schedule File Name Format**

The Schedule File Name includes the sheet identifier and the schedule identification number. Sheet Identifier is the sheet file that the detail is placed in. The detail identification number represents the location of the schedule within the sheet file border.

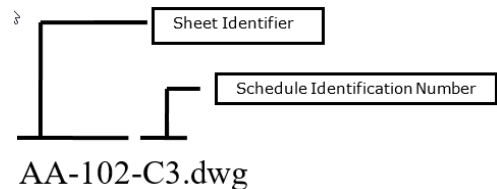

5.7.2 Critical or Non-Critical Percentage of Compliance

The Department’s Standard Design Files are classified as either *Critical* or *Non-Critical* to verify CADD compliance threshold. *Non-critical* Design Files must meet a minimum 80% compliance threshold for CADD Standard Levels/Layers. *Critical* Design Files must meet a minimum 95% compliance threshold for CADD Standard Levels/Layers. If critical files do not meet threshold requirements, a written variance from the Department’s Project Manager with supporting documentation must be included within the Project Journal.

Note The threshold percentage is calculated as the number of graphical elements in the design file on the prescribed level symbology divided by the total number of elements in that design file.

5.7.3 Reference Files

A reference file can be many file types, such as a MicroStation design file, an AutoCAD drawing file, a raster image file (such as a SID, TIF, or HMR), or a PDF. A reference file is attached as a “background file” to an active design file being edited, thus allowing multiple users to share the information in the reference file without the need to copy the reference file(s) into the active design file folder (creating unnecessary and prohibited duplicates).

Important Under no circumstances should the “absolute” or “full path” be used when attaching a reference file. Use relative referencing - always! All reference files for the project must reside within the project folder structure.

5.7.3.1 MicroStation Referencing

In MicroStation, reference paths are managed by an application setting (*FDOTConfig*) that is run at startup of any MicroStation file opened in the FDOT Workspace. This application looks for the `_meta_info\` folder, moves up one folder to set the root folder for the project and then dynamically sets the MicroStation configuration variable, `MS_RFDIR`, to search downward from the root folder through all found sub-folders to identify any reference files. All design files for a project must reside within the Department's standard Project Folder Structure or its sub-folders to be located as a reference file.

Note If duplicate filenames exist in the sub-folders of the project, MicroStation will attach the first matching filename it finds in the path. Therefore, duplicate filenames are prohibited!

5.7.3.2 AutoCAD Referencing

In AutoCAD Civil 3D, there are two types of reference files used:

- X-references (X-Ref) (Design files)
- Data References (D-Ref) (Data shortcut files located in the `_shortcuts` folder within a project)

If the `_meta_info\` subfolder does not exist, when a file is opened in MicroStation in an FDOT Workspace, the user will be prompted to define the parent folder of the project to enable the application to set the search path for reference files. See the following screenshot:

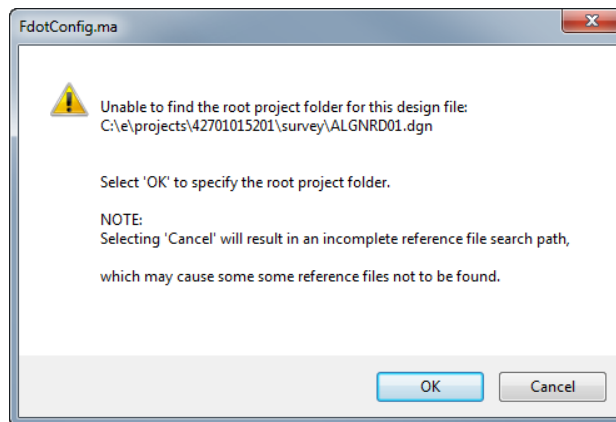

- If Cancel is selected, any reference to the models of files located in different sub-folders will not be displayed because the `MS_RFDIR` variable could not be populated automatically.
- If OK is selected, the user will be given the opportunity to define the root of the project. The user navigates to the root of the project, named for the Financial Project Identification Number.

5.7.3.3 Sharing of CADD Files

Every project utilizes the standard folder structure regardless of the project requirements. Data for each component/discipline is maintained in their respective sub-folder. If a component/discipline requires information from another component/discipline, the needed file(s) must be referenced from the original folder, not copied. Shared files between two component/discipline groups must have the creation and ownership of these files coordinated between these groups.

For example, the Signing and Pavement Marking design file (*DSGNSP*) references the Roadway design file (*DSGNRD*) and the Topography file (*TOPORD*). These files should not be copied into the Signing and Pavement Marking component/discipline sub-folder.

5.8 CADD RULES

The Department provides standard CADD Rules defining a prescribed group of Levels/Symbology related to a given component/discipline, or design purpose and used for compliancy validation of CADD design through the Department’s Quality Control (QC) process. Specific CADD Rules are automatically associated with each of the Department’s CADD standard design filenames within the CADD applications.

➤ **FDOT Standard CADD Rules & Descriptions**

CADD Rule tables are provided and accessible from the link below. They include comprehensive listings of the Department’s CADD Rules with the associated CADD Levels/Layers and Symbology information.

[**FDOT CADD Rule Tables**](#)

Note For more detail on CADD Levels/Layers and Symbology, see Section 5.9 of this document.

Rule Name	Description
algnrd	Alignment Design
autosp	AutoTURN
cliprd	Clip Border/View Frames
drdtrd	Drainage Detail
drexrd	Drainage Existing
drmprd	Drainage Map
drprrd	Drainage Proposed
drxsrd	Drainage Cross Section
dsgnld	Landscaping Design
dsgnlt	Lighting Design
dsgnrd	Roadway Design
dsgnsg	Signalization Design
dsgnsp	Signing & Pavement Marking Design
dtmrd	Digital Terrain (Proposed)
gdtmrd	Digital Terrain (Existing)
geotech	Geotechnical
gisalgn	Geographical Information System Alignment
gispar	Geographical Information System Parcels
gisrwdt	Geographical Information System Right of Way Lines
gswksp	GuidSIGN
irrgld	Irrigation

Rule Name	Description
itssp	Intelligent Transportation System
keysht	Key Sheets
msarsp	Mast Arm Details
open	All Levels and Symbology Accepted
pdxsrd	Pond Cross Section
planrd	Roadway Plan Sheet
plprrd	Roadway Plan/Profile Sheet
qtdsrd	Quantity Computation
rdxsrd	Roadway Cross Section
rdxssp	Signing & Pavement Cross Section
rwdtrd	Right of Way Detail for Roadway
RightOfWay	Right of Way
Structures	Structural
survrd	Survey Development Model
tedsrd	Traffic Control
topord	Existing Topography for Roadway
typdrd	Typical Section Data
utadrd	Utilities Adjustment
utexrd	Utilities Existing
utprrd	Utilities Proposed

5.8.1 Exceptions to the CADD Rules

Exceptions are deviations from the standard CADD Rules for any given project folder. For example, if a municipality required a special symbology for an element not covered in a CADD Rule, that element could be drawn with the special symbology and all occurrences of that symbology would be counted as one exception. The Department allows up to 10 exceptions per standard design file name before the compliance threshold begins to diminish.

5.9 LEVELS/LAYERS AND SYMBOLOGY

The Department’s CADD Software includes standard design libraries/templates to propagate the CADD standards definitions of (MicroStation) Levels/(AutoCAD) Layers. The MicroStation libraries are delivered under the \FDOTXXX\RESOURCES\dgnlibs\ folder and the AutoCAD templates are delivered under the FDOTXXX.C3D\Data\Templates\ folder.

CADD Rule Tables are provided and accessible from the link below. They include comprehensive listings of the Department’s CADD Rules with the associated CADD Levels/Layers and Symbology information.

[FDOT CADD Rule Tables](#)

The Department’s Level/Layer standards for projects define specific “ByLevel” Color, Style/Linetype and Weight Symbology for graphic elements for both the Bentley and Autodesk platforms. In nearly every instance, the Level/Layers and Symbology are the same between the platforms for consistency.

The Department’s CADD Software also includes a resource file documenting these CADD Standards used by the productivity tools for both MicroStation and AutoCAD platforms, such as *the Quality Control software* that checks design files for CADD compliancy during the Department’s plans preparation process.

5.9.1 Levels/Layers Naming Convention

The Department’s standard design libraries/templates define standard (MicroStation) Level/(AutoCAD) Layer Names. Designers must use these standard Level/Layer Names in the Department’s plans production of all CADD standard design files.

- **CADD Level/Layer Name convention format: *object_sv* (maximum of 18 characters)**

Where: (<i>object</i>) = Element Type	(s) = State Designations	(v) = View Designations
	p (Proposed)	p (Plan)
	d (Drafting element)	r (Profile)
	e (Existing)	x (Cross Section)
		m (Model)

Note Level/Layer Names with no “_sv” suffix added are assumed to be “_pp” (Proposed state & Plan view).

Example: With this one can determine the following about the example Level/Layer names below:

gas	- Proposed state & Plan view elements for “gas” related items
gas_ep	- Existing state & Plan view elements for “gas” related items
gas_px	- Proposed state & Cross Section view elements for “gas” related items

The Department’s standard CADD Levels/Layers are also classified as either *Critical* or *Non-Critical* for purposes of the QC processes to verify compliancy of design files.

- *Non-Critical* Levels/Layers are only checked in the QC process for compliancy with valid standard Level/Layer names only.
- *Critical* Levels/Layers are relied upon and used by downstream applications (or other component/disciplines) and are checked in the QC process for compliancy with both valid standard level names along with “ByLevel”/“ByLayer” settings for symbology (*Color, Line Style/Linetype, and Weight*).

The standard CADD Rules, documented in the resource file and in the *FDOT CADD Rule Tables*, contain a *Critical Level* column that defines each level with the following designations:

[blank]	Denotes <i>Non-Critical</i> Levels where ONLY valid standard CADD Level/Layer Name is checked in the QC process.
X	Denotes <i>Critical</i> Levels where valid standard CADD Level/Layer Names and ByLevel setting for Symbology (color, line style, and weight) are checked in the QC process.
3 Digit String	Denotes <i>Critical</i> Levels with partial checking in the QC process on whether to check (1= true) or not to check (0=false) specific symbology components: (Color, Line Style/Linetype, Weight) (1st digit = Color, 2nd digit = Line Style/Linetype, 3rd digit = Weight) Example: 100 – Denotes to check only Color (common for structures files) 010 – Denotes to check only Line Style/Linetype 101 – Denotes check both Color & Weight, but not Line Style/Linetype

5.9.1.1 Architectural Levels/Layers and Symbology

For Architectural Levels/Layers and Symbology, refer to the National CADD Standards and Layer Symbology produced by the U.S. CADD/GIS Technology Center, US Army Engineer Research and Development Center. These standards include space filenames, sheet filenames, detail filenames, schedule filenames, abbreviations, symbols, layers, linetypes, and text styles.

All drawings must be drawn at Full Scale 1:1 in Model space using Architectural Units. Text and dimensions should be added in Model space. The Title block Sheet should be in Paper space and viewport scaled for scalable printing.

All Level/Layer Names must follow the format detailed in the National CAD Standards. Below is a brief description of the layer naming convention.

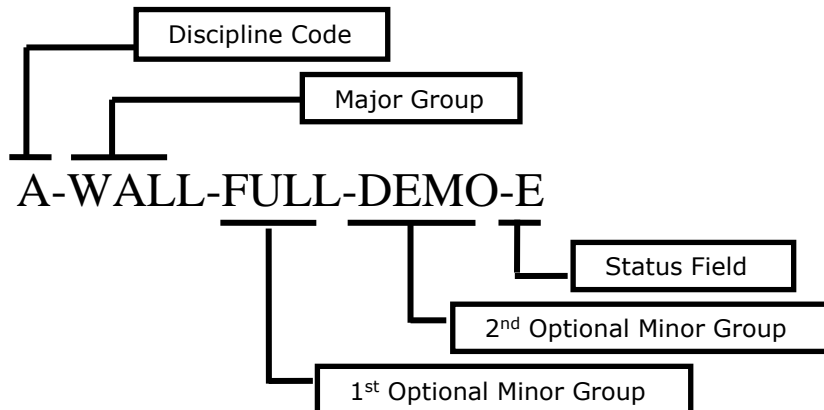

➤ **Examples: Codes, Groups and Fields**

• **Discipline Code**

A-_____ Architectural
 E-_____ Electrical
 F-_____ Fire Protection
 M-_____ Mechanical
 ETC.

• **Major Group**

__WALL-_____ Walls
 __DOOR-_____ Doors
 __LITE-_____ Lighting fixtures
 __COLS-_____ Columns
 ETC.

• **1st Optional Minor Group**

_____-FULL- Full height
 _____-DIMS- Dimension
 ETC.

• **2nd Optional Minor Group**

_____-IDEN- Identification
 _____-PATT- Pattern
 ETC.

• **Status Field**

_____-N New work
 _____-D Demolition
 _____-T Temporary work
 _____-F Future work
 ETC.

5.9.1.2 Structures Levels/Layers and Symbology

For the MicroStation FDOT Structures Workspace, standard element Level/Symbology are defined in the *StrLevels.dgnlib* Structures Level Library and must be selected from the MicroStation level manager. Each level contains a defined “ByLevel” color, line weight, line style, and print property.

Note For a complete listing of Structures Levels/Layers and Symbology, see Section 5.8 in the [FDOT CADD Rule Tables](#) under the STRUCTURES Rule.

For AutoCAD, FDOT Structures object Layer Property Standards are defined in the *StructuresTemplateDetail.dwt* and *StructuresTemplatePlan.dwt* template files and must be selected from the AutoCAD layer selector. Each layer contains a defined color, line weight, linetype, and print property. Color must remain set to ByLayer and line weight & line style may be modified as needed.

User created Levels ARE NOT acceptable. If additional Levels/Layers are needed, contact the Structures Design Office. The Level named “Default” (in MicroStation) or Layer 0 (in AutoCAD) is not QC compliant and is not to be used for drawing elements. If a discrepancy occurs, the *StrLevels.dgnlib* Structures Level Library or StructuresTemplate file supersedes the FDOT CADD Rule Tables found in Section 5.8 of this document.

5.9.1.3 Survey Levels/Layers and Symbology

For Survey Levels/Layers and symbology refer to the standard CADD Rule Tables for the listing of the Right of Way (RIGHTOFWAY) Rule. The list of elements shown may not contain all elements that appear within a Right of Way map, as this list would be extensive. The elements shown are those that are required for specific types of Right of Way maps.

All Right of Way Levels/Layers are ‘Critical’ levels, meaning that the attributes: Level, Color, Line Style/Linetype and Weight will all be checked for QC compliancy. The exception is for Text levels, where the Style attribute will be set as Non-Critical and excluded from compliance checking.

Right of Way elements must match the standard symbology for the Right of Way file they reside in. Non-Right of Way elements will be drawn in the symbology of their intended file type. For example: Edge of Pavement drawn in RWDETL01.DGN would be given the symbology as if drawn for DSGNRD01.DGN. All Right of Way Level/Layer Symbology must use ByLevel settings

5.9.2 Color Symbology

The Department uses a standard color table (*FDOTColor.tbl*) in MicroStation to visually recognize elements in files and for consistency in color printing. The standard color table is a modified version of the default MicroStation color table (*color.tbl*) which defines 256 colors for CADD elements. The Department’s standard color table customizes colors by remapping the RGB values for various MicroStation color index numbers.

In MicroStation, the standard color table (*FDOTColor.tbl*) is preset in the FDOT Workspace variable MS_DEFCTBL and is attached in the standard seed files. AutoCAD uses RGB values shown in the color tables.

Note Structure design files now use the same MicroStation Color Table (*FDOTColor.tbl*).

5.9.3 Line Style/Linetype Symbology (Standard Symbols)

MicroStation Line Style (or AutoCAD Linetype) is part of the symbology of graphic elements, which defines a line’s appearance. Each element has its own Line Style/Linetype which can be set to a standard Line Style/Linetype or to a Custom Line Style/Linetype.

Note As referenced in the [Standard Plans FY 2018-19 Revisions Log \(Standard Symbols\)](#), Design Standard Index 002 was removed from the new Standard Plans, referencing the **CADD Manual** for users to find Line Types, Cells, and Symbols used in a set of plans

Standard MicroStation Line Styles are based on output device coordinates, therefore are not truly “what you see is what you get”. Custom Line Styles should be used instead of MicroStation line patterning.

———— 0	style(0) = continuous
----- 1	style(1) = (0.02, 0.04), for ACAD - DGN1
----- 2	style(2) = (0.08, 0.04), for ACAD - DGN2
----- 3	style(3) = (0.15, 0.05), for ACAD - DGN3
----- 4	style(4) = (0.200, 0.053, 0.03, 0.053), for ACAD - DGN4
----- 5	style(5) = (0.056, 0.056), for ACAD - DGN5
----- 6	style(6) = (0.32, 0.056, 0.048, 0.056, 0.048, 0.056), for ACAD - DGN6
----- 7	style(7) = (0.59, 0.053, 0.03, 0.053), for ACAD - DGN7

5.9.3.1 Custom Line Styles/Linetypes

The CADD Office creates, maintains and provides standard Custom Line Style/Linetype resource (.rsc) files, listed below, in the CADD Software for both platforms: Bentley and AutoCAD for use in the design process of the Department’s CADD projects. A Custom Line Style/Linetype Table is provided inclusive of a complete listing with sample images and can be accessed from the following link:

[Custom Line Styles/Linetypes Table \(Standard Symbols\)](#)

FDOT Custom Line Style Resource Files for MicroStation	FDOT Custom Linetype Resource Files for AutoCAD
FDOT_3D.rsc	FDOT.LIN
FDOT_MOT.rsc	
FDOT_Rdwy.rsc	
FDOT_Road.rsc	
FDOT_ROW.rsc	
FDOT_Striping.rsc	

Some MicroStation Line Styles containing leaders, complex markings and striping to be place to scale are not created as AutoCAD Linetypes. AutoCAD tools such as Entity Manager, Place Block Group and the Pavement Marking tool can create these types of additional striping. In most instances, the MicroStation Custom Line Style name will match the AutoCAD Linetypes. The following are some exceptions:

MicroStation Line Style	AutoCAD Linetype
0	Continuous
1	DGN1
2	DGN2
3	DGN3
4	DGN4
5	DGN5
6	DGN6
7	DGN7

5.9.3.2 Non-standard Custom Line Styles/Linetypes

The Department's standard Custom Line Style/Linetypes can be complex and contain arrangements of line segments and/or symbols. Users must not modify these Custom Line Style/Linetypes resource files, nor create conflicting custom line styles/linetypes with the same Line Style/Linetype names. User created resource files must be unique in both name and appearance.

If Non-Standard Custom Line Style/Linetypes are required for a design, other user-defined resource files are allowed. These user-defined resource files must be delivered in the \symb\ sub-folder of the FDOT Project folder structure. <OR> The Non-Standard Custom Line Style/Linetype definitions must be embedded in the design file.

5.9.4 Line Weight Symbology

Line weight for MicroStation is defined by index value in the range of 0 to 31 that selects the stroke width (thickness) of the line used to draw and print a graphic element. Each element has its own line weight. The standard line width (thickness) of an element is usually in inches on the paper defined by a print driver file.

Printed output from the design file must be of a quality legible on 2nd generation copies. Line weights/thicknesses in the following table are default settings (also set in Department delivered print drivers). These may need to be user-adjusted depending on hardware to produce the required quality of printed documents.

MicroStation/AutoCAD Line Weight Mapping			
MS Weight	MS Plot(inches)	AutoCAD (inches)	AutoCAD (mm)
0	0.003	0.004	0.09
1	0.006	0.006	0.15
2	0.009	0.008	0.20
3	0.012	0.012	0.30
4	0.015	0.014	0.35
5	0.018	0.016	0.40
6	0.021	0.021	0.53
7	0.024	0.024	0.60
8	0.027	0.028	0.70
9	0.030	0.031	0.80
10	0.033	0.035	0.90
11	0.036	0.035	0.90
12	0.039	0.039	1.00
13	0.042	0.042	1.06
14	0.045	0.047	1.20
15	0.048	0.047	1.20
16	0.051	0.055	1.40
17	0.054	0.055	1.40
18	0.057	0.055	1.40
19	0.106	0.083	2.11
20	0.105	0.083	2.11
21	0.110	0.083	2.11
22	0.115	0.083	2.11
23	0.120	0.083	2.11
24	0.125	0.083	2.11
25	0.130	0.083	2.11
26	0.135	0.083	2.11
27	0.140	0.083	2.11
28	0.145	0.083	2.11
29	0.150	0.083	2.11
30	0.155	0.083	2.11

Available AutoCAD Line Weights	
inches	mm
0	0.000
0.002	0.050
0.004	0.090
0.005	0.130
0.006	0.150
0.007	0.180
0.008	0.200
0.01	0.250
0.012	0.300
0.014	0.350
0.016	0.400
0.02	0.500
0.021	0.530
0.024	0.600
0.028	0.700
0.031	0.800
0.035	0.900
0.039	1.000
0.042	1.060
0.047	1.200
0.055	1.400
0.062	1.580
0.079	2.000
0.083	2.110

5.10 TEXT

The Department delivers a set of True Type Font (TTF) files to ensure text uniformity between applications supporting TTF fonts and legibility of CADD drawings. The Department’s CADD Software delivers a set of proportional and uniformed spaced True Type Font files using vertical and slanted characters, the detail of which is reflected in the table below. These font files have additional characters added into the gaps of the Unicode definition, so engineering symbols like: \overline{C} , \overline{L} , \overline{B} , Δ and fraction combinations are supported in the FDOT fonts directly. The MicroStation based *zdotfont.rsc* and *structuresfont.rsc* resource files are also delivered with the CADD Software to maintain legacy compatibility for older CADD files predating the use of True Type fonts.

Note If the FDOT TTF files are registered with the Windows operating system, the fonts may be used in any standard Windows program like Word, Excel, or any other applications supporting TTF.

Font	Description
FDOT	Standard slanted proportional spaced font used for most annotations
FDOT Bold	Bold version of the FDOT font
FDOT Heavy	Heavier Bold version of the FDOT font
FDOT Imprint	Chiseled font (<i>Used mainly within the FDOT sheet border</i>)
FDOT Imprint Bold	Bold version of FDOTImprint font (<i>Used mainly within the FDOT sheet border</i>)
FDOT Mono	Standard mono-spaced font (<i>Used mainly in tables to keep characters aligned vertically</i>)
FDOT Mono Bold	Bold version of FDOTMono font
FDOT Mono Heavy	Heavier Bold version of FDOTMono font
FDOT Vert	Non-slanted proportional spaced version of FDOT font (<i>Used mainly by Right of Way discipline</i>)
FDOT Vert Bold	Bold version of FDOTVert font (<i>Used mainly by ROW</i>)
FDOT Vert Heavy	Heavier Bold version of FDOTVert font (<i>Used mainly by ROW</i>)
FDOT Vert Mono	Mono-spaced version for FDOTVert font (<i>Used mainly in tables used mainly by ROW</i>)
FDOT Vert Mono Bold	Bold version of FDOTVertMono font (<i>Used mainly by ROW</i>)
FDOT Vert Mono Heavy	Heavier Bold version of FDOTVertMono font (<i>Used mainly by ROW</i>)

5.10.1 Special Symbols

The Department’s TTF files contain special characters used by designers that are not normally found in standard publishing fonts. (*See the Unicode Mapping Standard: <http://www.unicode.org/charts/>*). These characters include, but are not limited to: fractions, mathematical symbols, survey symbols, boring symbols, Greek letters, Super/Sub Scripts. These characters may be accessed via the Insert Symbol tool provided in the MicroStation Text Editor/Word Processor or AutoCAD MText editor dialog.

5.10.2 Text Size and Spacing

The Department employs standard text sizes to ensure uniformity and legibility on CADD drawings and for printed output. The appropriate text size is dependent on the plot scale selected. Since the most important issue with text is legibility, the font, weight and text size may vary when necessary. Text line spacing should be, on average, three-fourths of the text height.

The Department’s CADD Software provides several Text Levels and Text Styles for designers to choose as a starting point to create text to fit their needs.

The following table should be used as a *guideline* for standard text size definitions for plans at given scales.

➤ **Text for B-Size Plans (11" x 17" paper)**

Scale	1"=1'	1"=20'	1"=40'	1"=50'	1"=100'	1"=200'	1"=400'	1"=500'
Minimum	0.06	1.2	2.4	3	6	12	24	30
Desired	0.07	1.4	2.8	3.5	7	14	28	35
Maximum	0.125	2	4	5	10	20	40	50

➤ **Text for D-Size Maps (24" x 36" paper)**

Scale	1"=1'	1"=20'	1"=40'	1"=50'	1"=100'	1"=200'	1"=400'	1"=500'
Minimum	0.08	1.6	3.2	4	8	16	32	40
Desired	0.10	2	4	5	10	20	40	50

5.10.2.1 Architectural Text Sizes and Weights

For Architectural design the following table is used to determine the appropriate line weight for each text height. Text line weights are applicable for text places in model and sheet files. Text heights in this chart are used for text in sheet files that are places in paper space.

Note Sizes shown are a 1:1 ratio.

Text Type	Line Weight (In) All Scales	Height (In) 1:1 Scale
Special Small/Revisions	0.007 in	3/32"
Annotation	0.010 in	1/8"
View/Sheet/Sect Titles	0.014 in	5/32"
Large	0.020 in	3/16"

The following charts are intended to aid the user in determining the appropriate text size when placing common text. Scale for placing the border and text on a drawing based on the actual size of the drawing. Calculations are based on a 9 1/2" x 15 1/2" drawing area inside the border.

Note For text placed in model files, text in paper space at 1:1

Text Size for Sheets Using Architectural Scales				
Drawing Scale	Text Size			
	3/32"	1/8"	5/32"	3/16"
Full size	3/32"	1/8"	5/32"	3/16"
6" = 1'-0"	3/16"	1/4"	5/16"	3/8"
3" = 1'-0"	3/8"	1/2"	5/8"	3/4"
1 1/2" = 1'-0"	3/4"	1"	1 1/4"	1 1/2"
1" = 1'-0"	1 1/8"	1 1/2"	1 7/8"	2 1/4"
3/4" = 1'-0"	1 1/2"	2"	2 1/2"	3"
1/2" = 1'-0"	2 1/4"	3"	3 3/4"	4 1/2"
3/8" = 1'-0"	3"	4"	5"	6"
1/4" = 1'-0"	4 1/2"	6"	7 1/2"	9"
3/16" = 1'-0"	6"	8"	10"	1'
1/8" = 1'-0"	9"	1'-0"	1'-3"	1'-6"
3/32" = 1'-0"	1"	1'-4"	1'-8"	2'
1/16" = 1'-0"	1'-6"	2'	2'-6"	3'

Text Size for Sheets Using Engineering Scales				
Drawing Scale	Text Size			
	3/32"	1/8"	5/32"	3/16"
1" = 5'	5 5/8"	7 1/2"	9 3/8"	11 1/4"
1" = 10'	11 1/4"	1'-3"	1'-6 3/4"	1'-10 1/2"
1" = 20'	1'-10 1/2"	2'-6"	3'-1 1/2"	3'-9"
1" = 30'	2'-9 3/4"	3'-9"	4'-8 1/4"	5'-7 1/2"
1" = 40'	3'-9 1/2"	5'	6'-3"	7'-6"
1" = 50'	4'-8 1/4"	6'-3"	7'-9 3/4"	9'-4 1/2"
1" = 100'	9'-4 1/2"	12'-6"	15'-7 1/2"	18'-9"
1" = 200'	18'-9"	25'	31'3"	37'-6"
1" = 500'	46'-10 1/2"	62'-6"	78'-1 1/2"	93'-9"
1" = 1000'	93'-9"	125'	156'-3"	187'-6"
1" = 1250'	117'-2 1/4"	156'-3"	195'-3 3/4"	234'-4 1/2"
1" = 2500'	234'-4 1/2"	306'-6"	390'-7 1/2"	468'-9"
1" = 5000'	468'-9"	625'	781'-3"	937'-6"

5.10.2.2 Structures Text Sizes and Weights

For Structural drawings the standard annotation text size is .0063' on a printed sheet. Standard text sizes are provided as custom text styles delivered either via the *strlevels.dgnlib* (MicroStation) or Structures Template (AutoCAD) files.

TITLE	FONT	SIZE (Ft)
Revisions	FDOT	.0050
Initials	FDOT	.0058
Annotation/Table Data	FDOT	.0063
View/Sheet/Sect Titles	FDOTBold	.0080
Large	FDOTBold	.0084
Larger	FDOTBold	.0100

The automatic Annotation Scaling service provided by both CADD platforms should be used for all annotations where possible. The Structures Design Office (SDO) uses special, custom fonts in its drawings and CADD programs; specifically, the FDOT and FDOTMono true type fonts (ttf). These fonts are stored in the *FDOT.ttf* and *FDOTMono.ttf* files supplied with the Department's CADD Software.

The *zDOTFont.rsc* and *StructuresFont.rsc* resource files are delivered in the MicroStation CADD Software providing support for legacy MicroStation fonts 168, 169, 68, and 69. Legacy MicroStation fonts should not be used for new production work.

5.10.3 FDOT Standard Abbreviations

The FDOT Standard Abbreviations can be accessed from the new Standard Plans at the following link:

[FDOT Standard Abbreviations - FY 2018-19 Standard Plans](#)

Note As referenced in the [Standard Plans FY 2018-19 Revisions Log](#), Design Standard Index 001 was removed from the new Standard Plans, referencing the abbreviations changed to a Cover Document of the new Standard Plans

5.11 CELL LIBRARIES/BLOCK DRAWINGS

MicroStation Cells/AutoCAD Blocks are frequently used as repeated components of drawings made up of complex symbols, notations, details, or parts of drawings that can be inserted into one or many other drawings. Cells are defined and stored in MicroStation design files called a Cell Libraries (.cel) and in AutoCAD are called Blocks Drawings (.dwg). Each Cell/Block library group common cells/blocks as indicated by the libraries name. Users may create a Project Cell/Block library and store under the Project\Cell folder.

Cells/Blocks have been grouped by disciplinary usage into the Department's Standard Cell Libraries/Block Drawings and are delivered with the CADD Software.

➤ Standard Cell Libraries/Block Drawings

(Select links to open complete cell listings for each Cell Library.)

MicroStation CELL LIBRARIES	AutoCAD BLOCK DRAWINGS	DESCRIPTION
FDOT Cell Libraries - Master		Master listing of all FDOT Cells
alphabet.cel		Alphabet & Numbers
arrows.cel	arrows.dwg	Distance & GuidSIGN Arrows
Drain_Bottom3D.cel	<i>(AutoCAD Drainage Parts)</i>	Drainage Bottom <i>(3 Dimensional used for SUDA)</i>
Drain_Curbs3D.cel	<i>(AutoCAD Drainage Parts)</i>	Drainage Curbs <i>(3 Dimensional used for SUDA)</i>
Drain_Grate3D.cel	<i>(AutoCAD Drainage Parts)</i>	Drainage Grate <i>(3 Dimensional used for SUDA)</i>
Drain_Junction3D.cel	<i>(AutoCAD Drainage Parts)</i>	Drainage Junction <i>(3 Dimensional used for SUDA)</i>
Drain_Nodes3D_EX.cel	<i>(AutoCAD Drainage Parts)</i>	Drainage Nodes <i>(3 Dimensional used for SUDA)</i>

MicroStation CELL LIBRARIES	AutoCAD BLOCK DRAWINGS	DESCRIPTION
Drain_Outlet3D.cel	(AutoCAD Drainage Parts)	Drainage Outlet (3 Dimensional used for SUDA)
DrainXS.cel	DrainXS.dwg	Drainage Structure Cross Sections
drplan.cel	drplan.dwg	Drainage Proposed
drplan_ex.cel	drplan_ex.dwg	Drainage Existing
ftpsigns.cel	ftpsigns.dwg	Florida Traffic Plans Signs
geotech.cel	geotech.dwg	Geotechnical
its.cel	its.dwg	Intelligent Transportation Systems Signs
Landscape.cel	landscape.dwg	Landscape
Lighting.cel	lighting.dwg	Lighting
Mutcd.cel	mutcd.dwg	Manual on Uniform Traffic Control Devices
PavementMarkings.cel	pavementmarkings.dwg	Pavement Markings
Photogrammetry.cel	Photo.dwg	Photogrammetry
Roadway.cel	Roadway.dwg	Roadway
row.cel	ROW.dwg	Right of Way
rweng.cel	rweng.dwg	Survey Symbols for Right of Way
Seals.cel	Seals.dwg	Professional Seals for Digital Signatories
Signalization.cel	signalization.dwg	Signalization
SignalPoles.cel	signalpoles.dwg	Signal Poles
syeng.cel	syeng.dwg	Survey Symbols for Roadway
TollPlaza.cel	TollPlaza.dwg	Toll Plaza Signs
tplabels.cel	tplabels.dwg	Traffic Plans Labels
TrafficControlPlans.cel	TrafficControlPlans.dwg	Traffic Control Plans
TrafficControlTypicals.cel	TrafficControlTypicals.dwg	Traffic Control Typical
transit.cel		Bus Lane Stops and Crossings
TTF_StdDataTables.cel	TTF_StdDataTables.dwg	Structures Standard Data Tables
TTF_v8structures.cel	TTF_v8Structures.dwg	Structures
TypicalSection.cel	TypicalSections.dwg	Typical Sections
utilities.cel	utilities.dwg	Utilities
Utilities3D.cel	(AutoCAD Parts)	Utilities (3 Dimensional)
v8structurespatterns.cel		Patterns for Structures
XMSuperSection.cel		Structures for Super sections
xsections.cel		Cross Sections

➤ *Standard Dynamic Cell Libraries/Block Drawings*

MicroStation DYNAMIC CELL LIBRARIES	AutoCAD DYNAMIC BLOCKS	DESCRIPTION
	BoreHOLE.dwg	Bore Holes
	Master Table Drawing.dwg	Master of All Summary Tables
	Sheet Border.dwg	Sheet Borders
	SheetPOR-Consultant.dwg	Professional of Record for Consultants

➤ *Standard Civil Cell Libraries/Block Drawings*

MicroStation CIVIL CELL LIBRARIES	AutoCAD CIVIL BLOCKS	DESCRIPTION
	Bus Bay with Type F Curb.dwg	Bus Bay with Type F Curb
	CurbGutter.dwg	Curb & Gutter
	Driveway.dwg	Driveway
	Mast Arm Assemblies.dwg	Mast Arm Assemblies
	Tapered Turn Lane with Type F Curb.dwg	Tapered Turn Lane with Type F Curb
	Traffic Separator with Tapered Median.dwg	Traffic Separator with Tapered Median

5.12 PROFESSIONAL OF RECORD NOTE

For those sheets that are digitally signed and sealed by a Professional Engineer, place the following note along the right edge of plan sheets that are digitally signed and sealed:

“THE OFFICIAL RECORD OF THIS SHEET IS THE ELECTRONIC FILE DIGITALLY SIGNED AND SEALED UNDER RULE 61G15-23.004, F.A.C.”

Note See the [FDOT Design Manual \(FDM\) 130](#), 302 & 303 for further information about Professional of Record Note and Signature Sheets.

The rule number referenced in the note above applies to the engineering professional that is signing and sealing the sheet. A non-engineering licensed professional should use the rule number that applies to their profession:

- Surveyors, Rule 5J-17.062, F.A.C.
- Geologists, Rule 61G16-2.005, F.A.C.
- Landscape Architects, Rule 61G10-11.011, F.A.C.
- Architects, Rule 61G1-16.005, F.A.C.

Sheets that are signed by multiple Signatories of different professional types (such as an Architect and an Engineer) will not bear the note unless it can be combined and fit legibly on the border. In such a case, the note might read:

“THE OFFICIAL RECORD OF THIS SHEET IS THE ELECTRONIC FILE DIGITALLY SIGNED AND SEALED UNDER RULE 61G15-23.004, F.A.C., AND RULE 61G1-16.005, F.A.C.”

Note Signatory Sheets have similar notes placed in the body of the sheet within the section for each Signatory and will not have the note placed along the sheet border. See examples in the FDM 303.

5.12.1 Professional of Record Seals Cell Library

The Professional of Record Note may be placed on the sheet at any time during the plans production process; however, the note has no force or effect until the actual sheet signing and sealing. FDOT has provided a *Seals.cel* cell library to assist with this process:

MicroStation CELL LIBRARIES	AutoCAD BLOCK DRAWINGS	DESCRIPTION
Seals.cel	Seals.dwg	Professional Seals for Digital Signatories

Chapter 6

CADD PRODUCTION PREREQUISITES

6.1 PURPOSE

This chapter defines the initial steps and processes for preparing the final Computer Aided Design and Drafting (CADD) projects in reflection of the [FDOT Design Manual \(FDM\)](#) for the Florida Department of Transportation (Department).

6.2 SCOPE

These processes impact anyone preparing contract deliverables for Department projects.

6.3 PROJECT DEVELOPMENT & ENVIRONMENT

Project Development and Environment (PD&E) study is the process for considering and evaluating environmental impacts as required by the National Environmental Policy Act (NEPA) and applicable laws and regulations for federal projects and other regulations for state funded projects. PD&E study is used to find the most appropriate design concept that meets the purpose and need for the project. Project alternatives are developed during the PD&E study to a level of engineering sufficient to address the purpose and need for the project and evaluate environmental impacts.

PD&E study involves production of design concepts to depict the extent of the proposed improvements and potential impacts, and present complex technical information in a comprehensible and visual manner to the public. Project alternatives and design concepts are developed using CADD Standards, where appropriate, to facilitate a seamless transfer of PD&E CADD files to the final design phase. The objective of using CADD Standards in PD&E is to minimize duplicative work and rework of concept plans in the design phase.

The PD&E process is documented in the PD&E Manual at:

[Project Development and Environment \(PD&E\) Manual](#)

6.3.1 PD&E CADD Deliverables

Preliminary design performed during PD&E study may include preparation of:

- Base map
- Digital terrain model or 3D surface
- Alternative alignments
- Alternative concept layouts/plans
- Intersection/Interchange concepts
- Profiles
- Typical Sections
- Drainage maps
- Conceptual drainage and storm water pond plans
- Preliminary structure plans for bridges, wall, and noise barriers
- Utilities
- GIS-kmz files
- Visualization files

Design files shall be created to the Department's CADD Standards.

Concept plans, calculations, data and files that are used to develop project alternatives should be placed under the \pde\ component/discipline folder, which is the Department's standard folder for concept plans and files created during PD&E. Additional sub-folders may be created under the \pde\ component/discipline folder to segregate and further organize data.

Data and files used to prepare preliminary design of the preferred alternative for a PD&E project with concurrent Design phase should be included in the respective component/disciplines folders such as roadway, survey, drainage, utility, and structure.

6.4 RIGHT OF WAY MAPPING

The Surveying and Mapping Office through spatial technology expertise supports surveying and mapping activities statewide for Florida's transportation system by providing policies, procedures, guidelines, and training. This office provides expertise in Aerial Surveying and Mapping, Location Surveying, Right of Way Mapping, and Mobile Mapping.

The Department's *Surveying and Mapping Procedure*, Topic 550-030-101 and the *Surveying and Mapping Handbook* governs the requirements for Right of Way Mapping procedure for the Department's projects.

The following is a link to the Surveying & Mapping Office Documents and Publications:

http://www.dot.state.fl.us/surveyingandmapping/doc_pubs.shtm

6.4.1 Right of Way CADD Deliverables

Right of Way Mapping may have multiple component sets for a specific project as defined in chapter/activity 29 of the FDOT General Scope of Services. These components may include control survey maps, right of way maps, maintenance maps, sketches, other miscellaneous survey maps, and legal descriptions as required for this project in accordance with all applicable DEPARTMENT Manuals, Procedures, Handbooks, District specific requirements, and Florida Statutes. All data delivered to the Department should be placed under the \rwmap\ component/discipline folder, which the Department's standard folder structure is included for this purpose. Additional sub-folders may be created under the \rwmap\ component/discipline folder to segregate and further organize data.

A complete set of Right of Way Maps may include the following:

1. R/W Map Master Design File
2. Cover Sheet
3. Key Map Sheet
4. Detail Sheet
5. Project Network Control Tabulation Sheet
6. R/W Tabulation Sheet

6.5 SURVEY

The Surveying and Mapping Office through spatial technology expertise supports surveying and mapping activities statewide for Florida's transportation system by providing policies, procedures, guidelines, and training. This office provides expertise in Aerial Surveying and Mapping, Location Surveying, Right of Way Mapping, and Mobile Mapping.

The Department's *Surveying and Mapping Procedure*, Topic 550-030-101 and the *Surveying and Mapping Handbook* governs the requirements for surveying procedure for the Department's projects.

The following is a link to the Surveying & Mapping Office Documents and Publications:

http://www.dot.state.fl.us/surveyingandmapping/doc_pubs.shtm.

6.5.1 Survey CADD Deliverables

A Survey may have multiple component sets for a specific project as defined in chapter/activity 27 of the FDOT General Scope of Services. These components support a digital survey/document as defined by chapter 5J-17, F.A.C. and as required for this project in accordance with all applicable DEPARTMENT Manuals, Procedures, Handbooks, District specific requirements, and Florida Statutes.

The digital survey/document CADD file(s) may consist of a Control Survey; supporting Right of Way Mapping, a single file for Design Survey purposes or multiple component/discipline specific files also for Design Survey purposes. Due to the transition of Roadway Design from Criteria-based to 3D Modeling Surveying is required to support both legacy survey deliverables and a single digital Design Survey file when applicable.

Note All "Signed and Sealed" digital surveys must be accompanied by a Survey Report as per Rule Chapter 5J-17, F.A.C.

A Design Survey CADD deliverable may include the following files;

1. Existing Drainage file (DREXRD)
2. Existing Surface/Terrain Model (GDTMRD)
3. Existing Topography (TOPORD, TREERD)
4. Existing Utilities (UTEXRD, UTVHRD)
5. Project Control (CTLSRD)
6. Survey Development Model (SURVRD)

The SURVRD (Survey Development Model) when created as a Design Survey for a MicroStation SS4 Corridor Modeling (3D) project can serve as a complete survey database.

Note The SURVRD file is a critical file for MicroStation SS4 Corridor Modeling (3D) projects only.

6.5.2 Survey Data File

Additional geometry input files are also created for delivery to design. For example: files of existing points, profiles, survey chains, alignments, surfaces, etcetera, should be created in LandXML 1.2 format. For information about LandXML (see: <http://www.LandXML.org>).

All data delivered to the Department should be placed under the \survey\ component/discipline folder, which the Department's standard folder structure is included for this purpose. Additional sub-folders may be created under the \survey\ component/discipline folder to segregate and further organize data. For example: the case where a CAiCE project is placed within the project folder structure under the \survey\ component/discipline folder for delivery.

6.5.3 County Mapping

The production of County Maps is an internal function of the Department's Geographic Information Systems Office. For information regarding file naming conventions and other standards in use during the production of the Department's County Maps, contact Geographic Mapping in the Department's Geographic Information Systems Office at (850) 414-4111.

<http://www.fdot.gov/geospatial/countymap.shtm>

6.5.4 Utility Quality Levels

Chapter 556, F.S. incorporate locates as described in the 1999 Utility Accommodation Manual (UAM), Section 11.3 Locates. These are no longer described in the UAM. Quality Levels for existing utilities are defined in the *Surveying and Mapping Handbook* at the link below:

<http://www.fdot.gov/geospatial/documentsandpubs/SurveyandMappingHandbook.pdf>

FDOT has provided for the identification of these Utility Quality Levels within the design process through the creation and association of specific CADD Standard Levels for each Utility Quality Level where applicable.

6.6 GEOTECHNICAL

Projects are evaluated to determine likely subsurface conditions and foundation alternatives in sufficient detail to estimate the total number, type and depth of exploratory borings for Roadways and Structures. Projects could include evaluation of roadway subgrade or embankment stability/settlement related to sinkholes, soft clays, organic soils and/or high groundwater. Projects could require geotechnical guidance for normal cut and fill, recommendations for realignment, surcharge, excavation and replacement, subgrade reinforcement using geosynthetics and/or underdrains, design recommendations for soil improvement by lime/cement subgrade stabilization, deep dynamic compaction, vibroflotation, compaction grouting, pile reinforced embankments, etc.

➤ ***Geotechnical Plans that may be submitted for Roadway Plans Set are:***

- Boring Location Plan
- Delineation Limits of Unsuitable Material Plan
- Soil Profile Sheet
- Report of Core Boring Sheet

➤ ***Geotechnical Plans that may be submitted for Structures Plans Set are:***

- Detailed Boring Location Plan
- Report of Core Boring Sheet (SPT and Auger)
- Location Map
- SCS Soil Survey Map
- USGS Terrain Map

➤ **Geotechnical Data that may be delivered for Design includes:**

- Design LBR
- Parameters for Water Retention Areas
- Monitor Existing Bridge Data
- Treatment of Problematic Soils
- Pavement Condition/Evaluation
- Roadway Recommendations
- Bridge and Associated Wall Design Recommendations
- Sign, Signal, Box Culverts, High Mast Lighting

Geotechnical information shall be delivered in Comma Separated Values (CSV) format as shown in the examples below. The Department has adopted the following standard file naming convention for CSV file imports for the Geotechnical Data:

➤ **Borehole**

- *Boreholetpk.brh* - Borehole location data, seasonal high water & design high water data.

➤ **Material**

- *Material.mtl* - Strata Data and Core data.

Standard Penetration Test (SPT) boring information may be drawn using the Department's Report a Core Boring tool.

➤ **Example: Boreholetpk.brh**

Format:

borehole_name,alignment_name,station,offset,water_elev_type,water_elev_0,water_elev_0_date,water_elev_24,water_elev_24_date

File Data Example:

Borehole-01,CLCON,78+00.00,15,0,3,8/9/2007,5,8/10/2007

Borehole-02,CLCON,80+00.00,3,0,2,8/20/2007,4,8/21/2007

Borehole-03,CLCON,83+00.00,3,0,3,8/23/2007,5,8/24/2007

Borehole-04,CLCON,85+00.00,4,0,2,8/24/2007,4,8/25/2007

➤ **Example: Material.mtl**

Format: *borehole_name,material_name,doc_or_se,type_of_elev*

File Data Example:

Borehole-01,1,10,DOC Borehole-03,2,6,DOC

Borehole-02,1,5,DOC Borehole-04,1,2,DOC

Borehole-02,2,7,DOC Borehole-04,2,5,DOC

Borehole-02,3,9,DOC Borehole-04,3,7,DOC

Borehole-03,1,3,DOC Borehole-04,4,10,DOC

➤ **Soil Survey**

The plans must include the information about the soil classification on the soil survey sheet and by showing the boring data soil boxes on the cross section sheets.

➤ **Soil Boring Data**

The soil boring data must be provided to the Roadway designer in a format to facilitate the drawing of the data on the cross section sheets.

6.7 TRAFFIC DATA

The traffic analysis report and its supporting documentations, such as technical memorandums and data submitted in the appendices as prepared by transportation practitioners during Project Development & Environment (PD&E), should be made available for Design purposes. This data can be presented in the following three formats:

- Tabular format
- Graphical format
- Animation (microsimulation analysis only)

The report should contain traffic projections, observed traffic and historical trends, proposed roadway and transit network improvements, and land use projections. Traffic Data used in design is defined in FDM 120.2.2

6.8 TYPICAL SECTIONS PACKAGE

The typical section package will be approved as part of the Project Development & Environment (PD&E) process. Requirements for the Typical Section Package are defined in FDM 120.3.

6.9 DRAINAGE

The Drainage Manual sets forth drainage design standards for Florida Department of Transportation (FDOT) projects. This Manual is available for downloading from the website below:

<http://www.fdot.gov/roadway/Drainage/ManualsandHandbooks.shtm>

CADD provides software resources for Drainage plans preparation using GEOPAK Drainage, OpenRoads Subsurface Utility Engineering(SUE) and Civil 3D Storm and Sewer Design. Some Districts utilize other Drainage analysis and design applications, such as Automated Storm Sewer Analysis and Design (ASAD). The Drainage databases produced by drainage design applications must be delivered with the CADD project.

6.10 PAVEMENT

The pavement selection and design should be completed as early in the design process as possible. The Rigid and Flexible Pavement Design Manuals are available through Pavement Management Publications. The pavement design data report is used to support CADD design.

<http://www.fdot.gov/roadway/PM/publicationS.shtm>

6.11 UTILITIES

The Utility Accommodation Manual (*UAM*) <http://www.fdot.gov/programmanagement/utilities/Default.shtm> is used to establish the utility installation or adjustment requirements for utilities within the Florida Department of Transportation's (FDOT) right of way (R/W).

There are three Utility file coordination options available for the Utility Agency/Owner (UAO), i.e. the entity that owns the utility, to share files with the Department:

- Exchange of design files (DGN or DWG) – the preferred option
- Create American Standard Code for Information Interchange (ASCII) files
- Import of Geographic Information System (GIS) data

➤ *Sharing of Design Files*

Design files are created to the Department’s CADD Standards and returned to the District for review. The UAO will use these files as references to create the existing or proposed utility files. These files (existing or proposed) would also be submitted back to the District. It is the District’s responsibility to coordinate with the UAO for delivery of design files. For AutoCAD DWG files, all line work for utilities should be preferably in 3D and saved as polylines or feature line objects.

➤ *ASCII Input File*

The second option is the ASCII file that can be created from existing or proposed utilities. The ASCII file format will be either LandXML or GEOPAK input format for Station/Offset/Elevation or Northing/Easting/Elevation (State Plane coordinates). These files must contain information pertinent to the location of the utility, as well as the type of utility and where it is located referenced to the (survey baseline) alignment or state plane coordinates.

➤ *Geographic Information System (GIS) File*

When UAO maintains a GIS database of utility data, that data may be exchanged in GIS shape files.

➤ *Utility Coordination*

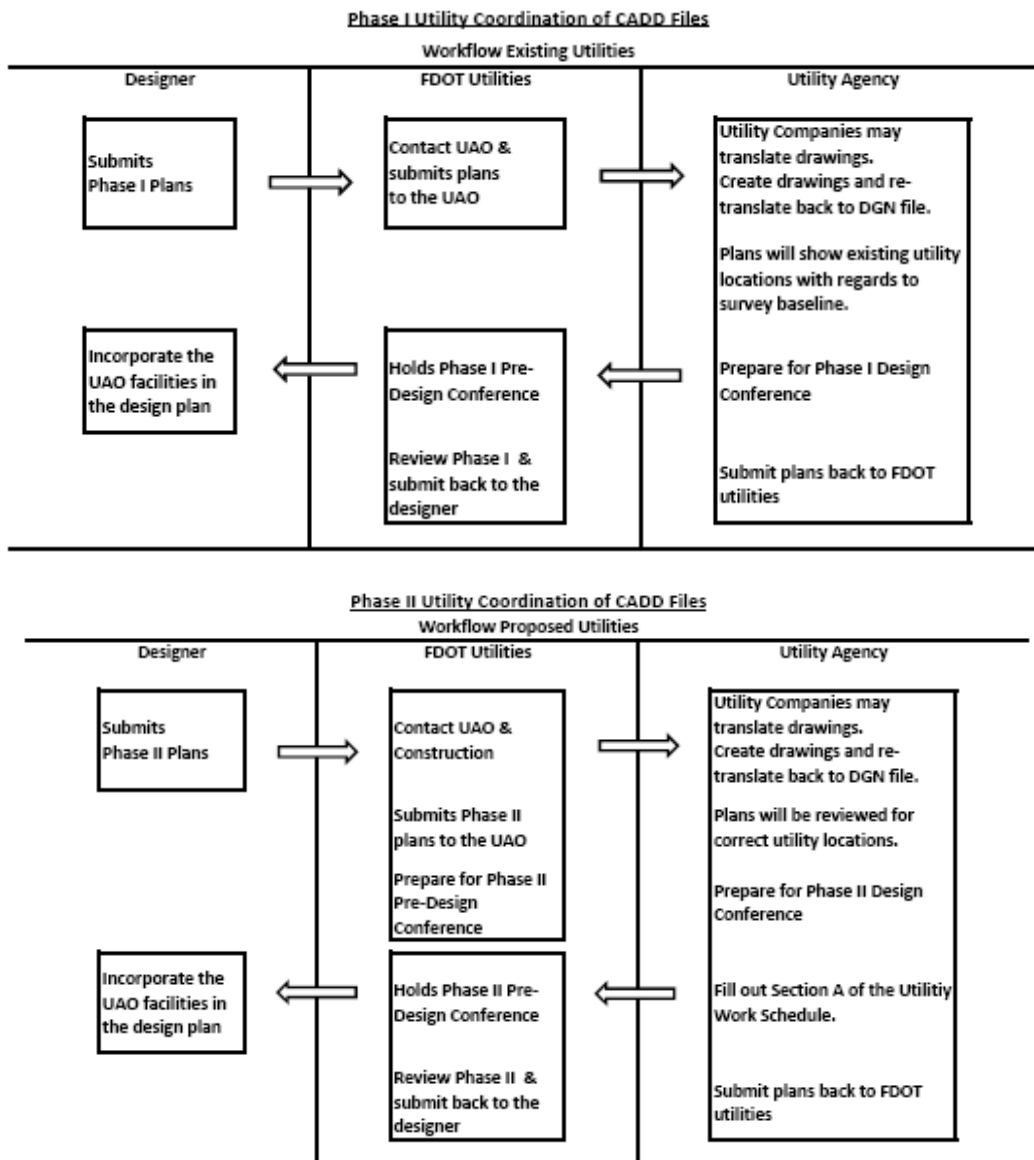

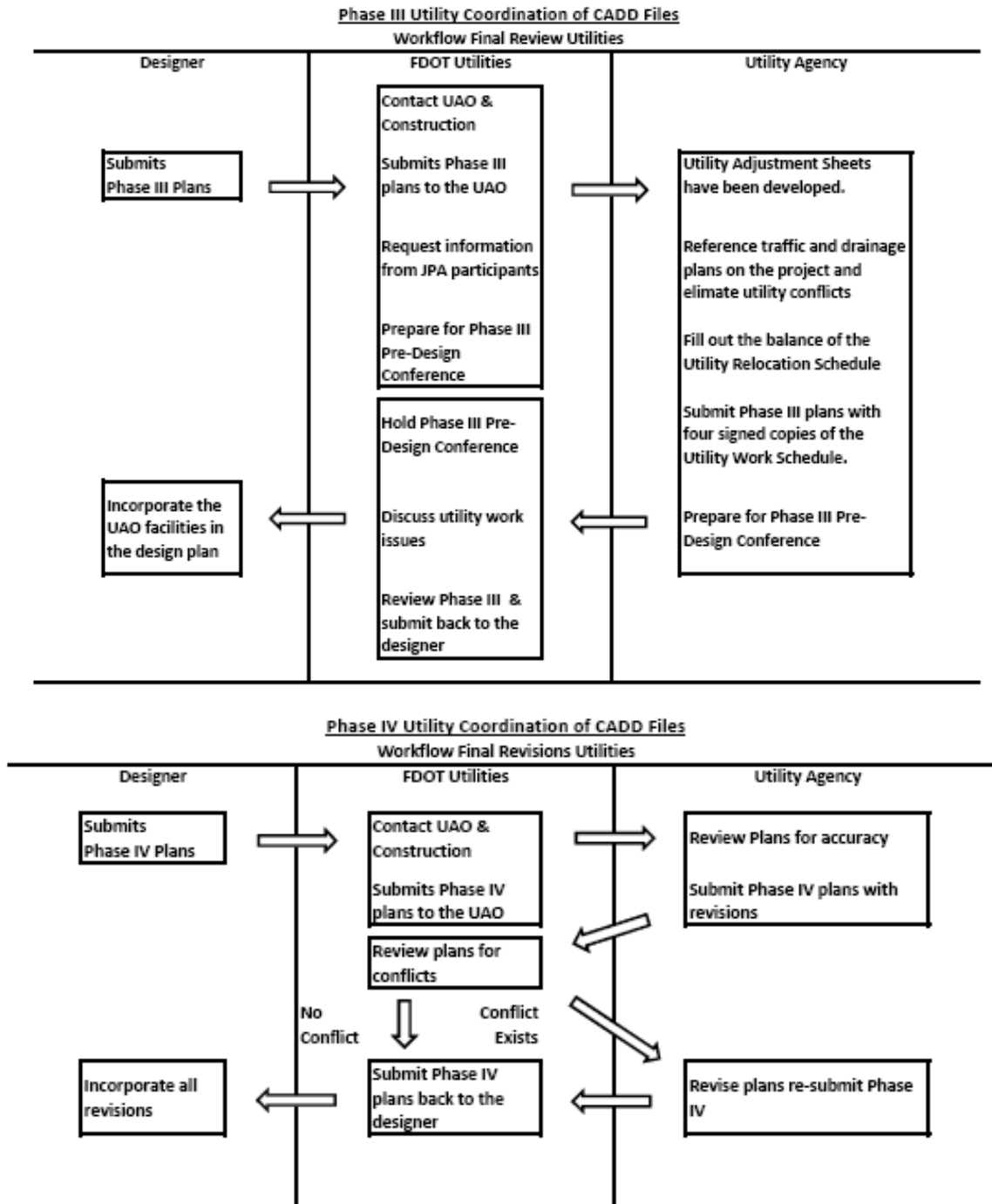

➤ **Exchange of Design Files**

After the Department’s District Utilities Office (via Utility Coordinator) has received the current phase submittal from the Designer, they must contact the involved utilities and notify them of the phase submittal. The UAO will then receive the phase documents from the Department that must contain the Roadway Plans, the necessary CADD files and any Utility Relocation Agreements and Schedules. The required electronic files include the proposed roadway design; the existing topography, the existing and proposed R/W and the existing utilities gathered from the survey and previously supplied data.

No editing of any files provided by the Department will be accepted. The UAO will be placing data into newly created files. File naming standards must always be current.

➤ **Utility Work by Highway Contractor Agreement Plans**

Major highway construction elements such as pavement areas, bridges, drainage structures, right of way, lane widths, control of access limits and highway-straight-line numbers should appear in the Utility Work by Highway Contractor Agreement Plans.

The Department's plans marked by the UAO will use the following color code:

- **Red:** Existing utilities either (a) To be removed or relocated horizontally or (b) to be placed out-of-service (deactivated) but left in place.
- **Green:** Existing utilities to remain in place with no adjustment.
- **Brown:** Either (a) Existing utilities to be adjusted vertically but to remain in the same horizontal alignment, or (b) Completely new utilities to be installed.

One set of the plans should be returned to the Department with each copy of the Utility Agreement.

➤ **ASCII Files of Utility Data**

ASCII Files of utility data are to be exchanged in the LandXML format which is ubiquitous with most civil design and GIS software. Information about LandXML can be found at: <http://www.LandXML.org>.

➤ **The File Naming Convention for this ASCII files must be:**

utilx##.xml for Existing Utilities

utilpr##.xml for Proposed Utilities

➤ **Alternately, ASCII files of Utility Data File Naming Convention must be:**

utilx##.inp for Existing Utilities. Note the *inp* extension for GEOPAK input

utilpr##.inp for Proposed Utilities. Note the *inp* extension for GEOPAK input

Where ## will be a sequencing number (01, 02, 03, etcetera).

Each electronic ASCII report file must be stored on media according to the Department's CADD Deliverable Standards. If the provider does not have capability to deliver in LandXML format, a GEOPAK Input format file will also be an acceptable substitute. When delivery is made in GEOPAK Input format, the ASCII report must be accompanied by a printed hardcopy.

➤ **Utility Scanned Images**

If the Utilities are handled through a Joint Utility Agreement and electronic files are not provided to the District for the Utility plans, the paper plans must be scanned. The format must be a published format with a minimum resolution of 300DPI. The required formats are PDF or Group 4 TIFF.

6.12 STRUCTURES

Preliminary design performed may include preparation of:

- Base map
- Digital terrain model or 3D surface
- Coordinate Roadway Alignments
- Coordinate Roadway Profiles
- Typical Sections
- Drainage maps
- Conceptual drainage
- Preliminary structure plans for bridges, wall, and noise barriers
- Utilities
- GIS-kmz files
- Visualization files
- Refer to Geotechnical Section 6.6

6.12.1 Existing Bridge Plans

Existing Bridge plan sheets must be submitted in PDF format, not DGN, and manually inserted into the plans using sheet numbers. The January 2017 [FDOT Structures Manual](#) Section 3.1 B states the following:

"....At the end of the plan set, place all existing bridge sheets for each bridge in one PDF file named "B1ExistingPlans.pdf" for the first bridge (number sheets sequentially "BX1-1", "BX1-2", etc.) and "B2ExistingPlans.pdf" for the second bridge, etc."

Traditionally existing Bridge Plans have been made as a part of the contract documents and therefore should be made part of the plans set; likewise, the PDF file(s) representing the existing Bridge Plans would reside in the \struct\ project folder.

Note The person responsible for assembling the plan set including existing bridge plans may wish to apply a stamp on each existing bridge plan sheet that indicates "FOR INFORMATION ONLY" and the current contract FPID being designed.

Chapter 7

CADD PRODUCTION SUPPORT

7.1 PURPOSE

This chapter establishes the minimum CADD project production requirements for the Florida Department of Transportation (Department's) Computer Aided Design and Drafting (CADD) projects in accordance with the Department's plans preparation procedures and practices set out in the FDOT Design Manual (FDM).

7.2 SCOPE

These procedures are applicable to the CADD applications utilized by and for the Department in the production process. They are intended to complement and support the policies, procedures and standards of the Department in accordance with *Procedure No. 025-020-002, Standard Operating System*.

7.3 PROFESSIONAL ACCOUNTABILITY

These procedures do not exempt the professional from performing responsible engineering, surveying and mapping or architecture. The policies and procedures of the Department and appropriate professional practice take precedence when providing professional services for the Department. The professional must have the final responsibility for the accuracy of all input and output of CADD applications.

7.4 PROJECT SETUP

Project setup activities involve the creation of a framework for meeting the Department's CADD Standards and delivery requirements. Activities include the creation of the Project folder structure. The Department's CADD Software contains a tool to help create a Project folder structure with the appropriate project information. The newly generated Project folder structure and its content are referred to as the "seed project".

For creating the "seed project" the Department provides a *Create Project* application to create the Project folder structure and prompts the user for additional project specific information, such as, key financial, administrative and location data into the project as project identification information.

The Project folder contains standard sub-folder names for defined component/disciplines along with support and resource files specific to the project. The project identification information is contained in an XML file format (*ProjectID.xml*) and stored in the `_meta_info\` sub-folder of the project. The `_meta_info\` sub-folder is used by the FDOT Workspace to establish the top level of the project folder structure and for other purposes.

The `_meta_info\` sub-folder is required and must not be removed for delivery.

Note An exception - Specifications Only Projects do not have a `_meta_info\` sub-folder.

7.4.1 Project Folder Structure

The data for each of the Department’s projects is organized and delivered using a standard Project folder structure. The Project Folder (Project Root Folder) must be named the Department’s Florida Project Identification Number (FPID), using all eleven digits. The Department’s standard project folder structure and file naming conventions are based on the anticipated workflow of the Department’s projects and the usual separation of work. Sub-folders have a purpose for the file content they will receive. For example, a cell library developed for a specific project has a dedicated holding sub-folder named \Cell\ in the standard project folder structure.

The Department also provides an application *FileChecker* to assist in the confirmation of the Project folder structure during the Quality Control (QC) processes.

The following table displays the Department’s standard Project folder structure with a descriptive purpose.

Folder Names	Purpose
Project Name (FPID)	Root Project Folder: contains fpid-PLANS.PDF
_meta_info	Files used by the FDOT Workspace Reference file tools (Do Not Remove. Required sub-folder.)
_Shortcuts	Data shortcuts (data for AutoCAD projects only - not used by MicroStation)
3DDeliverables	Copies of specific Design Files for Contractor convenience for 3D models, includes LandXML files of critical geometrics and surfaces
admin	Administrative documents (email, correspondence, etcetera)
eng_data	** Typically contain QC reports
arch	Architectural design files
eng_data	** Typically contain QC reports
brinspect	Bridge Inspection files
eng_data	** Typically contain QC reports
calculations	Excel files, PDF files and any associated quantity backup data for the Plan Summary Boxes for Roadway and Structures
Cell (or Block)	Project specific cell libraries (or project block libraries created for AutoCAD)
concepts	Various preliminary concepts
eng_data	** Typically contain QC reports
const	Construction files (i.e.: "As-Builts")
eng_data	** Typically contain QC reports
data	Project data files (i.e. journals, material backgrounds for rendering, pen tables, print configuration files, etcetera)
drainage	Drainage design files
eng_data	** Typically contain QC reports and calculations
emo	Environmental Management files
eng_data	** Typically contain QC reports
estimates	Estimates files
eng_data	** Typically contain QC reports
geotech	Geotechnical data files
eng_data	** Typically contain QC reports
GIS	Geographic Information System Deliverables
ITS	Intelligent Transportation Systems design files
eng_data	** Typically contain QC reports
landscp	Landscape design files
eng_data	** Typically contain QC reports
lighting	Lighting design files
eng_data	** Typically contain QC reports
maint	Maintenance department (This is not Maintenance of Traffic).
eng_data	** Typically contain QC reports
material	Other Materials data files
eng_data	** Typically contain QC reports
out	Other miscellaneous Output files
permits	Permits for various items (i.e.: ponds, driveways, mailboxes, etcetera)
eng_data	** Typically contain QC reports
planning	Planning files
eng_data	** Typically contain QC reports

Folder Names	Purpose
preestim	Preliminary estimates files
eng_data	** Typically contain QC reports
roadway	Roadway design files
eng_data	** Typically contain QC reports
rormap	Right of Way Mapping files
eng_data	** Typically contain QC reports
seed	Project specific seed files
signals	Signalization design files
eng_data	** Typically contain QC reports
signing	Signing and Pavement Marking design files
eng_data	** Typically contain QC reports
specs	Source files used to create the Specifications Package*
eng_data	** Typically contain QC reports
struct	Structure design files
eng_data	** Typically contain QC reports
survey	Survey database and surveying design files
eng_data	** Typically contain QC reports
symb	Project specific resource files for fonts and custom line styles
trafops	Traffic Operations data files
eng_data	** Typically contain QC reports
utils	Utility data and design files
eng_data	** Typically contain QC reports

Note ** The Engineering Data, /eng_data/, folder in the Project Folder Structure is a working sub-directory during the design process of an FDOT Project. Final Project design documentation (like pavement design report, typical section package, exceptions, variations, architectural calculations, drainage calculations, lighting design analysis report, permits, geotechnical reports, structural calculations, toll facility calculations, utility schedules, etcetera) will be delivered per [FDM 111.7](#) as directed by the [Roadway Design Memorandum 18-02 - Project Documentation](#).

➤ **Calculations Project Folder**

The \calculations\ Project sub-folder contains the Excel summary box templates and custom spreadsheets, PDF or TIFF files of hand drawn sketches and calculations, PDF files generated from other programs (i.e. Mathcad), and any associated *quantity backup data* for the Plan Summary Boxes for Roadway and Structures.

Subfolders specific for Roadway and Structures may be created under the \calculations\ sub-folder to aid in organization of documentation. Under the Project \calculations\ Structures\ sub-folder, separate sub-folders may be created for each bridge and/or structure in the project.

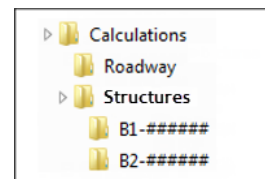

➤ **Component/Discipline Sub-Folders**

Component/Discipline sub-folders of a project are generally defined for the division of work and the files they typically would contain. Roadway designers would typically place files they create and “own” under the \Roadway\ sub-folder of the project, Surveyors under the \Survey\ sub-folder, and so forth. In some cases, component/disciplines may have work that overlaps with other areas of a design. For example, if a Roadway designer develops the drainage sheets, the files produced would, by the above convention, go in the \Roadway\ folder rather than the \Drainage\ folder as the “Roadway” designer is the owner of the work. However, if so desired, those files could have been put in the \Drainage\ sub-folder instead, but file management permissions (for access control systems such as Vault, ProjectWise, Falcon/DMS, and etcetera) must be taken into consideration.

➤ **Custom Sub-Folders:**

In some cases, it is desirable to create “non-standard” or custom sub-folders for additional segregation of work management. This is common when multiple parties work in a single component/discipline. These additional sub-folders can be created under the component/discipline standard project sub-folders; but **must not** be created under the root folder for the project.

These custom sub-folders must adhere to the restrictions for sub-folder names as defined below:

- Certain special characters are not recognized by some programs for sub-folder names and must be avoided (even if they are valid characters for Windows folder names). Characters that interfere with operating system path specifications or XML interpretation such as: (`/ \ . : ; , < & # > ' " & # > "`) must be avoided.

Note Examples of characters that should NEVER be used in sub-folder (or file) names include: `&, %, |, $, ?, <, >, !`, (even if permissible by the Windows Operating System). Some characters represent escape sequences to certain programs and will cause problems.

- Letters (**A-Z, a-z**), numbers (0-9), dashes (-), and underscores (`_`) characters are the only legal characters for sub-folder names.
- Spaces must not be used in any folder or file name for the Department projects.
- Sub-folder names must not exceed 16 characters. Filenames may exceed 16 characters; but should be kept as concise as possible to help meet full path length restrictions.
- Full path lengths are also generally limited to 1024 characters (or less) total by some software. Path length (path plus filename) must be considered When creating folder (and file) names and may limit the number of sub-folder levels below the project level folder.

7.5 PRODUCTION WORKFLOW

During the production phase, tasks are performed prior to the creation of the media for delivery of the data meeting the Department's delivery requirements.

General tasks performed during the production phase include (but not limited to):

- Follow the Project folder structure and file naming requirements for Delivery.
- Produce CADD design files to the Department's CADD Standards, using the Department's workspaces and resources provided in the CADD Software.
- Assemble any non-standard user created CADD resource files, such as custom created cell libraries, in appropriate folders and document their use in the Project Journal file(s).
- Document all approved deviations from the Department's CADD Standards in the Project Journal file(s), including important applications, methods and decisions made during design. This is important for downstream users of data to follow in the designer's footsteps.
- Create required Engineering Data and output files.
- Generate Quality Control (QC) Reports for all design files using the CADD QC tool provided. These reports indicate compliance to the Department's CADD Standards.
- Merge any external project files into the Project folder structure, including all files from sub-consultants, external reference files, scanned images for sheets (if any) and specifications documents.
- Bundle any non-standard graphics dependent resource files into the Project sub-folders:
 - **\symb** - to include user created fonts, shape files and/or line styles/linetypes
 - **\cell** - to include project specific/user created cell or block libraries
- Check for any duplication of files and resolve. Remove non-essential file duplication. Remove non-essential "junk" files. Remove empty Project folders.
- Review the Project for completeness, accuracy, and compliance with the Department's CADD Delivery standards. The application *FileChecker* is provided to help assist with this task.
- Create any files needed to support 3D Modeling as required by the scope and to communicate design intention to the contractor.

7.6 SUPPORTED CADD SOFTWARE BY COMPONENT/DISCIPLINE

The Department supports several applications and resources to aid the user to meet the Department's specific requirements. The Production Support (CADD) Office website has links to supported software:

<http://www.fdot.gov/cadd/default.shtm>

7.6.1 Roadway

Roadway Plans are usually the lead component of the Department's CADD projects with all other components as subset components. However other components may hold the lead.

7.6.1.1 GEOPAK, OPENROADS, CIVIL3D

The Production Support (CADD) provides custom resource files for both MicroStation and AutoCAD civil engineering platforms. These are delivered with our FDOT workspace and State Kits, respectively. The Department also provides custom configuration files to support GEOPAK, OpenRoads and Civil3D. The Production Support (CADD) Office provides these workspace and state kit to correspond with specific releases of GEOPAK, OpenRoads and Civil3D, staying current with contemporary versions as soon as all resources have been adequately configured. Specific features of the software can be found at the following links:

<https://www.bentley.com/en/products/brands/openroads>

<https://www.bentley.com/en/products/product-line/civil-design-software>

<https://www.autodesk.com/products/civil-3d/overview>

7.6.2 Signing and Pavement Marking

Signing and Pavement Marking Plans are usually a component set of Roadway Plans. However, if the Signing and Pavement Marking Plans are the lead plan set, then the standards set in the Roadway Standards, pertaining to elements that are specific to the lead plan set, will apply to the Signing and Pavement Marking plan set (i.e., Traffic Control files and elements, preliminary estimate sheets, etcetera).

The Department's projects requiring minor Signing and Pavement Marking construction work may include these features detailed on sheets in the Roadway Plans. If this is the case, the Signing and Pavement Markings element symbology standards apply. However, an exception to the Standard Rules must be created and documented in the Roadway component/discipline journal file.

When prepared as component plans, Signing and Pavement Parking plans will be assembled as a separate plan set complete with a key sheet, tabulation of quantities and all other relevant Signing and Pavement Marking sheets. The sheets must be numbered consecutively, with sheet numbers prefixed by the letter "S".

7.6.2.1 Sign Design

The Draw Sign program is a MicroStation application that draws sign panels and posts and determines the corresponding pay item of the assembly based on the wind load and post properties. The Draw Sign program requires use of the GEOPAK and GEOPAK Design and Computation (D&C) Manager database (*FDOTXXX.ddb*) to provide automated pay item association. (XXX reflects the current version of database.)

The Department's Signs application (FDOT Signs) included in the State Kit for AutoCAD, provides similar functionality. It requires the project's pay item database (*payitemdb.xml*), also used by Entity Manager, to provide automated pay item associations.

GuidSIGN is the standard sign design software used by the Department. However, using GuidSIGN is not required and other sign design programs available in the industry may be used. The Department's Level/Symbology Standards must still be met regardless of the software used.

GuidSIGN is a tool to create sign panels. Sign panel design and creation require two (2) separate files: *GSKWSP##.dgn (DWG)* for sign panel design and the worksheet and the *DSGNP##.dgn (DWG)* file for sign panel placement on the project. There is no limit in the number of sign panels that can be placed in a file.

7.6.2.2 Turn Radius Design

Transoft AutoTURN and Autodesk Vehicle Tracking are the standard turn radius design software used by the Department. However, using AutoTURN or Vehicle Tracking is not required. Other vehicle wheel path design software available in the industry may be used for designing the turning movements of roadway intersections. The Department's Level/Symbology Standards must still be met regardless of the software used.

7.6.3 Signalization

Signalization Plans are usually a component set of Roadway Plans. However, if the Signalization Plans are the lead plan set, then the standards set in Roadway Standards, pertaining to elements that are specific to the lead plan set will apply to the Signalization plan set (i.e., Traffic Control files and elements, preliminary estimate sheets, etcetera)

The Department's projects requiring minor signalization construction work may include these features detailed on sheets in the Roadway Plans. If this is the case, the Signalization Element Level/Symbology Standards within this Section will still apply. However, an exception to the Standard Rules must be created and documented in the Roadway component/discipline journal file.

When prepared as component plans, Signalization Plans will be assembled as a separate plan set complete with a key sheet, tabulation of quantities and all other relevant signalization sheets. The sheets must be numbered consecutively, with sheet numbers prefixed by the letter "T". The Signalization Plans show the construction details, signal phasing and other relevant data.

7.6.4 Intelligent Transportation Systems

Intelligent Transportation Systems (ITS) Plans are usually a component set of Roadway Plans. The Department's Projects with minor ITS involvement may include these features on various applicable sheets in the Roadway plans set. They can also be shown in the Signalization plans set or on applicable Signalization sheets.

7.6.5 Lighting

Highway Lighting Plans are usually a component set of Roadway Plans. However, if the Highway Lighting Plans are the lead plan set, then the standards set in, Roadway Standards, pertaining to elements that are specific to the lead plan set will apply to the Highway Lighting plan set (i.e., Traffic Control files and elements, preliminary estimate sheets, etcetera).

When prepared as component plans, Highway Lighting Plans will be assembled as a separate plan set complete with a key sheet, tabulation of quantities and all other relevant lighting sheets. The sheets must be numbered consecutively, with sheet numbers prefixed by the letter “L”.

7.6.5.1 Lighting Design Software

AGI32 Lighting Software is the standard Lighting Design software used by the Department. However, using AGI32 is not required. Other Lighting design software available in the industry may be used for the Lighting Design. If AGI32 is not used, the Department’s Level/Symbology Standards must still be met to be compliant with CADD Standard Rules and Digital Delivery.

7.6.6 Landscape

Landscape means any vegetation, mulches, irrigation systems and any site amenities, such as, street furniture, decorative paving, fences and lighting (excluding public utility streets and area lighting). Landscape plans may be a component set of the Roadway Plans or be prepared independently.

The Department’s Projects with minor Landscaping may include landscaping features on separate sheets in the Roadway Plans set or landscaping features may be detailed on the Roadway plans sheets.

When prepared as component plans, Landscape Plans will be assembled as a separate plan set complete with a key sheet, tabulation of quantities and all other relevant Landscape sheets. The sheets must be numbered consecutively with the sheet numbers prefixed by the letters “LD”.

A complete set of Landscape plans may include the following:

1. Key Sheet
2. Tabulation of Quantities
3. Planting Sheets
4. Irrigation Layout
5. Details Sheet
6. Other relevant plan sheets as required Pay Items Notes, General Notes or Maintenance Notes and Schedules.

These sub-components should be listed on the Landscape Plans Key Sheet under the “Components of Contract Plan Sets” heading.

Note Hardscape Design files must use the same symbology standards as the Landscape Design file.

7.6.7 Architectural

Architectural plans consist of all sheets pertaining to Architectural (Building) design, and their component plans. These plans may be comprised of any of:

- General Plans
- Hazardous Materials Plans
- Survey Plans (Following the Survey CADD Standards)
- Geotechnical Plans (Following the Geotechnical CADD Standards)
- Civil Plans (Following the Roadway CADD Standards)
- Landscape Plans (Following the Landscape CADD Standards)
- Structural Plans
- Architectural Plans
- Interior Plans
- Fire Protection Plans
- Plumbing Plans
- Mechanical Plans
- Electrical Plans

The bullets above represent an Architectural plan set on a Department Project where the building is the focal point of the project. Architectural (often referred to as “Building”) projects within the Right of Way typically do not include Survey, Civil, Geotechnical, or Landscape plans. These component/disciplines are normally included in the Roadway Plans. However, when present in the Architectural plans, the Department’s CADD Standards of the appropriate component/discipline must be used.

Bascule Bridge Control House Architectural plans are to be prepared using the Department’s Structures CADD Standards.

➤ *Architectural Adopted CADD File Format*

The Department has adopted AutoCAD as the Standard platform format for Architectural projects. All CADD files for Architectural plan sets, including those component/disciplines within the building (i.e. plumbing, mechanical, electrical and structural) will be submitted in AutoCAD (.dwg) format. Plans outside the building envelope must follow the Department’s CADD Standard format for the component/discipline.

➤ *Architectural Adopted CADD Standards*

The Department has adopted the US National CAD Standards as the standard format for Building Projects. This Section is a synopsis of the US National CAD Standards. More information can be found at:

- ✓ National CAD Standard
- ✓ National Institute of Building Sciences
- ✓ 1090 Vermont Ave., NW, Suite 700
- ✓ Washington, D.C. 20005-4905
- ✓ (202) 289-7800
- ✓ Website: <http://www.nationalcadstandard.org/ncs/>

National CAD Standard also includes chapters from the following organizations:

- ✓ U.S.CADD/GIS Technology Center
- ✓ US Army Engineer Research and Development Center
- ✓ Attn: CEERD-ID (S. Spangler)
- ✓ 3909 Halls Ferry Road
- ✓ Vicksburg, MS 39180-6199
- ✓ Website: <http://www.erd.c.usace.army.mil/>
- ✓ CAD Layer Guidelines
- ✓ American Institute of Architects (AIA)
- ✓ 1735 New York Ave, NW
- ✓ Washington, D.C. 20006
- ✓ Website: www.aia.org
- ✓
- ✓ Uniform Drawing System (UDS)
- ✓ Construction Specifications Institute
- ✓ 601 Madison Street
- ✓ Alexandria, Va. 22314-1791
- ✓ 800-689-2900
- ✓ Website: <http://www.csinet.org>

➤ **Architectural Projects**

Architectural standards apply to the building and building related component/disciplines outlined in the following list of project types.

➤ **Building Projects:**

- Work Program Projects
 - Rest Areas
 - Weigh Stations
- Fixed-Capital Outlay (FCO) Projects
 - Office Buildings
 - Construction & Maintenance Facilities
 - Other 'Off Right of Way (ROW)' Facilities

➤ **Delineation between Architectural & Engineering Plans**

Delineation Line at 'foot print' of Building:

- Face of Exterior Wall
- Area enclosed by buildings Columns and/or Walls; i.e. Porticos, Carports, covered Walkways and Covered Patios
- Roof and Building Overhangs

Use AutoCAD *inside* the Delineation Line. Items inside the Delineation Line Includes ‘Building-Oriented’ Facilities & Equipment that are typically designed by an Architect, including but not limited to, picnic shelters, planters which are part of the building and site furniture in covered areas.

CADD Delineation Example

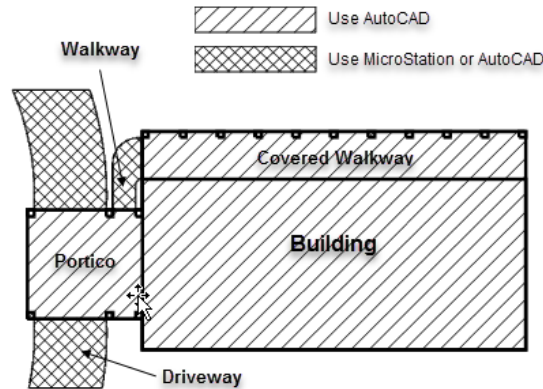

Items outside the delineation or “foot print” of Building must be produced and submitted following the CADD standards for their component/discipline as defined in their respective chapters, including but not limited to:

- Pavement
 - Driveways, Parking, Sidewalks
- Landscape Plans
- Site Utilities
 - Electrical, Water, Sanitary Sewer, Storm Sewer, Drainage
- Site Fencing and Walls

➤ **Architectural Scale Chart**

The following chart is intended to aid the user in determining the appropriate scale for placing the border and text on a drawing based on the actual size of the drawing. Calculations are based on a 9 1/2" x 15 1/2" drawing area inside the border.

Note Sheet files must be assembled in paper space & printed at 1:1

Drawing Scales for Sheets			
Architectural Scales		Engineering Scales	
Drawing Scale	Plot Scale	Drawing Scale	Plot Scale
Full size	1	1" = 5'	60
6" = 1'-0"	2	1" = 10'	120
3" = 1'-0"	4	1" = 20'	240
1 1/2" = 1'-0"	8	1" = 30'	360
1" = 1'-0"	12	1" = 40'	480
3/4" = 1'-0"	16	1" = 50'	600
1/2" = 1'-0"	24	1" = 100'	1200
3/8" = 1'-0"	32	1" = 200'	2400
1/4" = 1'-0"	48	1" = 500'	6000
3/16" = 1'-0"	64	1" = 1000'	12000
1/8" = 1'-0"	96	1" = 1250'	15000
3/32" = 1'-0"	128	1" = 2500'	30000
1/16" = 1'-0"	192	1" = 5000'	60000

➤ **Formulas:**

AS = 12 x Drawing Scale, Ex. 1" = 10', then 12 x 10 = 120, Therefore AS = 120

7.6.8 Structures

The use and generation of CADD files by Structures for the Department's Projects must be in accordance with the general standards for all component/disciplines, unless superseded by instructions contained within this section.

[FDOT Structures Manual](#)

The following table defines the resource files and features used for the FDOT Structures Workspace.

Note In MicroStation, the standard color table (*FDOTColor.tbl*) is preset in the FDOT Workspace variable MS_DEFCTBL and is attached in the standard seed files. AutoCAD uses RGB values shown in the color tables.

Feature	Bentley	Autodesk
Color Table	FDOTColor.tbl	<i>Not Applicable</i>
Font Files	FDOT*.ttf	FDOT*.ttf
Level Definitions	Strlevels.dgnlib	StructuresTemplateDetail.dwt StructuresTemplatePlan.dwt
Main Cell/Block Library	TTF_V8Structures.cel	Structures.dwg
Models Allowed	Yes	<i>Not Applicable</i>
QC Rule	STRUCTURES	STRUCTURES
Seed/Template Files	StructuresSeed.dgn StructuresSeed3d.dgn	StructuresTemplateDetail.dwt StructuresTemplatePlan.dwt
Text/Dimension Styles Definitions	Strlevels.dgnlib	StructuresTemplateDetail.dwt StructuresTemplatePlan.dwt

7.6.8.1 Structures Borders and Scales

➤ **Borders:**

Draw all elements at "Full Size" completely before placing text or dimensions. Sheets that reside in the Structures Component of the plan set must use the Structures Border cell "Sheet-Border". Sheets requiring Structures design that reside within other components/disciplines of the plan set (Roadway, Lighting, etcetera) must use the Border Roadway w/Initials cell "Sheet-Rdwy".

Show the scale of the drawing and related details inside the display area of the file, but outside of the Sheet Border area. This is helpful to all users who work on the file.

➤ **Scales:**

The following chart is intended to aid the user in determining the appropriate scale for placing the border and text on a drawing based on the actual size of the drawing. Calculations are based on a 9.60" x 15.40" drawing area inside the border.

- Architect's Scales

Drawing Scale	Active Scale (AS)	Height (FT.)	Width (FT.)
1/16" = 1'	192	153.59	246.39
3/32" = 1'	128	102.40	164.26
1/8" = 1'	96	76.80	123.20
3/16" = 1'	64	51.20	82.13
1/4" = 1'	48	38.40	61.60
3/8" = 1'	32	25.60	41.07
1/2" = 1'	24	19.20	30.80
3/4" = 1'	16	12.80	20.53
1" = 1'	12	9.60	15.40
1 1/2" = 1'	8	6.40	10.27
3" = 1'	4	3.20	5.13
6" = 1'	2	1.60	2.57
1 = 1	1	.80	1.28

- FORMULAS: Architect's Scale:

AS = 12/Drawing Scale *(Ex. 1/4" = .25in., then 12/.25 = 48, Therefore AS = 48)*

W = Sheet Width (in.)/Drawing Scale *(Ex. 1/4" = .25in., then 15.36/.25 = 61.44, Therefore W = 61.44)*

H = Sheet Height (in.)/Drawing Scale *(Ex. 1/4" = .25in., then 9.72/.25 = 38.88, Therefore H = 38.88)*

- Engineer's Scales

Drawing Scale	Active Scale (AS)	Height (FT.)	Width (FT.)
1" = 500'	6000	4799.81	7699.69
1" = 400'	4800	3839.85	6159.75
1" = 300'	3600	2879.88	4619.82
1" = 250'	3000	2399.90	3849.85
1" = 200'	2400	1919.92	3079.88
1" = 150'	1800	1439.94	2309.91
1" = 120'	1440	1161.95	1847.93
1" = 100'	1200	959.96	1539.94
1" = 80'	960	767.97	1231.95
1" = 60'	720	575.98	923.96
1" = 50'	600	479.98	769.97
1" = 40'	480	383.98	615.98
1" = 30'	360	287.99	461.98
1" = 20'	240	191.99	307.99
1" = 15'	180	143.99	230.99
1" = 10'	120	96.00	153.99

- FORMULAS: Engineer's Scale:

AS = 12 x Drawing Scale *(Ex. 1"=500', then 12 x 500 = 6000, Therefore AS = 6000)*

W = Sheet Width (in.) x Drawing Scale *(Ex. 1"=500', then 15.36 x 500 = 7680, Therefore W = 7680)*

H = Sheet Height (in.) x Drawing Scale *(Ex. 1"=500', then 9.72 x 500 = 4860, Therefore H = 4860)*

7.6.8.2 Structures Dimension Settings

Dimension styles are defined in the strlevels.dgnlib (MicroStation) or Structures Template files (AutoCAD). Styles are provided for Dimensioning and Notes for various terminators and leaders. Make every effort to use automatic dimensioning with element association enabled.

7.6.9 Toll Facilities

As per the *FDM 301*, Toll Facility Plans should be prepared in accordance with the Florida's Turnpike Enterprise current **General Tolling Requirements (GTR)** found at the following link:

<http://www.floridasturnpike.com/design/gtr.html>

7.7 PROJECT JOURNAL

A Project Journal must be produced for all projects to document details on project data, design aspects, processes and decisions made during the development that would communicate important information to a down-stream user of the project data. The Journal must be delivered with the Project in either MS Word (.doc or .docx), text (.txt), or Acrobat (.pdf) formats.

The Project Journal file(s) may be delivered to document the activities for a given component/discipline (i.e. a Surveyor's Journal) or may be created to document specific production activity (i.e. creating cross sections). Journal file entries should document alternate methods employed, variant decisions made, problems encountered, setting selected, included fixes or other issues encountered during the production process outside the normal course of operations.

For example: If custom line styles were created, the justification for the custom line style and the resource file name containing the custom line style should be documented in the Journal. Any information that would help in the regeneration of CADD files and/or prints should be recorded. The critical geometry information, database, controlling alignment(s) and profile names, relevant survey and cross section information and the methodology used to obtain the final geometric controls in the CADD product should be recorded.

7.8 EXISTING AS BUILT PLAN SHEETS

In some cases, designers have no choice but to scan pre-existing hardcopy sheets to create digital sheet files. For example, some plan sheets may already exist as hardcopies and were signed & sealed conventionally by wet ink signature and impression seal at some time in the past. This might occur when either pre-existing plans are incorporated into the current delivery, or some professional component/discipline does not have legal authority to sign and seal their plans digitally. In such cases, those plan sheets should be scanned to an acceptable PDF format according to FDM 130.

7.9 SHEET NUMBERS

Roadway plans are typically the primary component of the Department's Project plans set containing multiple plan components/disciplines and can have non-prefixed sheet numbers (1, 2, 3, etcetera). Other component/disciplines can also be the primary plans component/discipline - only in the absence of a Roadway plan component/discipline. For example: A Lighting only project may omit the plans component prefix and use the numbering format of 1, 2, 3, etcetera.

The Department provides the *Sheet Navigator* application that uses sheet number prefixes to determine the plans component/discipline to which each sheet belongs.

Sheet numbers used in title blocks of plan sheets are composed using the format: **AAA-####Z**, where:

- **AAA** - Represents the sheet number prefix, using multiple alpha characters.

(Refer to the [FDOT Design Manual \(FDM\)](#) and [FDOT Structures Manual](#).)

Prefix	Component
CTL	Roadway Plans – Early Works - Project Control Sheets
GR	Roadway Plans – Early Works - Soil Survey and Report of Core Borings normally associated with the roadway plans set (<i>including miscellaneous structures but excluding bridges and walls</i>)
TR	Roadway Plans – Early Works - Tree Survey Sheets
UTV	Roadway Plans – Early Works - Verified Utility Locate Sheets
[No prefix]	Roadway Plans – (<i>Typical - only an integer is used for most of these sheet numbers</i>)
SQ	Roadway Plans – Summary of Quantities (Tabulation of Quantities)
TD	Roadway Plans – Tree Disposal Plans
S	Signing and Pavement Marking Plans
T	Signalization Plans
IT	Intelligent Transportation System (ITS) Plans
L	Lighting Plans
LD	Landscape Plans
A	Architectural Plans
B	Structures – Common Sheets
BQ	Structures – Bridge Quantity Sheets
B1, B2, B3...	Structures – 1 st , 2 nd , 3 rd ... Bridge sheets
BW	Structures – Bridge Walls
BX1, BX2, BX3...	Structures – Existing Bridge Plans
BP	Structures – Pedestrian Bridge Data Sheets
	Toll Facilities
U	Utility Work by Highway Contractor Agreement Plans

- **####** - Defines the numeric order of the sheets within the Plans Component.
- **(Z)** - The optional (Z) suffix allows for the insertion of appended sheets after the project has started, such as the case during revisions. A single alpha character suffix, A-Z, is added for each subsequent sheet inserted for a revised sheet.

Example Sheet Numbers: S-001A, S-001B, PNC-01, A-15, A-16, T-1, T-2, and 1, 2, 3, etcetera.

7.9.1 Structural Sheet Numbers

The Structural sheet numbers must be prefixed with the target component/discipline's sheet prefixes. Sheet Order reflects placement within the Structures Component of the Contract Plan Set. See [Structures Manual](#) for complete details on sheet numbering instructions.

7.10 PRINTS

All printing will be generated from the native design files. All print images (PDFs) are produced to scale to match the native application.

Note Not all printer hardware will print paper sheets exactly to scale, even if the source design file, or a resulting print image file (PDF) is to scale.

The Department's standard sheet borders are defined for the component/disciplines. Sample print drivers are also provided to generate "drawn to scale" print images for the printer hardware supported. Standard sheet borders delivered with the CADD Software comply with the Department's sheet appearance formats, as defined in the FDM and other controlling procedures.

7.10.1 Print Drivers

The sample print driver files and the sheet settings provided with the CADD Software are used to generate prints to scale. These driver files are considered "examples," due to the various site-specific configurations and types of printers that may be encountered. The print driver files were tested and work with the printers for which they were developed, so adjustments may be required if their equipment varies.

Each printer has its own "printable" area defined for a paper size which may differ slightly from printer model to printer model. It is the sole responsibility of the person performing the prints to ensure hardcopy printing is operating acceptably for their hardware. All MicroStation print driver files supplied by the Department have raster printing enabled. AutoCAD uses Page Setups and Plot Style tables.

Note See Section 6.11.2 of this document for a list of MicroStation print driver files delivered by the Department.

7.10.1.1 MicroStation Half-Toning

The color 20 is used to define half-toning in the Department's MicroStation printer driver files. Half-toning of the minor grid lines on the cross section sheets, the profile portion of the plan/profile sheet and the profile sheet is shown in the *FDM, Part 3 Exhibits*. The Department's Project Manager must approve half-toning of any other graphical elements in the design files.

Some Districts have specified half-toning of certain reference files from one component/discipline to another. For example, the topography file could be half-toned when referenced to the proposed design. This must be approved on a per District basis. A pen table can be set up to equate any referenced file to color 20, thus half-toning the entire reference file at print time.

7.10.1.2 Quality and Reproduction

Printed output from the design files or plan sheet image file PDF's must be legible and of a quality to be reproducible on 2nd generation copies. Line weights as defined in Chapter 3 are default settings, but may need to be adjusted, depending on printer hardware, to produce the required quality of hard-copy printed documents.

7.10.2 Print Resource Files

7.10.2.1 *MicroStation*

The Department's CADD Software supplies several MicroStation print configuration example files to generate prints to scale using the sheet cells (also provided with the CADD Software) on those specific printers. All print configuration files supplied have raster printing enabled. These print configuration files are examples due to various site-specific configurations and the types of printers that might be encountered.

The table below lists the print configuration filenames and the type of printer on which it was developed/tested. Each printer has its own printable area on the paper for which it can print. For this reason, if a specific printer is not listed below, the print configuration file may require modification by the user to be used for another printer.

PRINT RESOURCE FILES	PRINTER	DESCRIPTION
36x24.pro	N/A	Controls postscript image/print output for 36" x 24" prints
Color.pltcfg	N/A	Color 11x17 (Raster Capable) Uses FDOT.TBL pen table and PSCRIPT.PRO prolog file.
Color_FDOTPDF.pltcfg	N/A	Creates a color Portable Document Format (PDF) file. (Raster Capable) Uses FDOT.TBL pen table.
Color_Keysheet.pltcfg	N/A	To be used when printing key sheets containing maps with filled shapes.
FDOT.tbl	N/A	Pen table that also enters username, date time, and sheet border path.
FDOT_GrayExisting.tbl	N/A	Pen table that enters username, date time, sheet border path, and applies gray scale to files named like: TOPO*, UTEX*, and DREX*
FDOT_Keysheet.tbl	N/A	Pen table that enters username, date time, sheet border path, and applies settings for printing PDF key maps on key sheets.
FDOT_Letter.pltcfg	Windows Printer	Copy of Bentley's PRINTER.PLT with weights and styles set to CADD standards. Uses FDOT.TBL pen table. Specifically, for printing 8.5" x 11" letter-sized prints.
FDOT_Letter.pro	N/A	Controls postscript image/print output for 8.5" x 11" letter-sized prints
FDOTPDF.pltcfg	N/A	Creates a .PDF file. (Raster Capable) Uses FDOT.TBL pen table.
FDOTprinter.pltcfg	Windows Printer	Copy of Bentley's PRINTER.PLT with weights and styles set to CADD standards. Uses FDOT.TBL pen table.
HP1055.pltcfg	HP 1055 CM	Monochrome 36x24 (Raster Capable) Uses 36x24.PRO prolog file.
HP1055C.pltcfg	HP 1055 CM	Color 36x24 (Raster Capable) Uses 36x24.PRO prolog file.
HP5000.pltcfg	HP 5000 GN	Monochrome 11x17 (Raster Capable) Uses FDOT.TBL pen table and HPTTBL1.PRO prolog file.
HP5000Legal.pltcfg	HP 5000 GN	Monochrome 8.5x14 (Raster Capable) Uses FDOT.TBL pen table and HPTLEGAL.PRO prolog file.
HP5000Letter.pltcfg	HP 5000 GN	Monochrome 8.5x11 (Raster Capable) Uses FDOT.TBL pen table and HPTLETTER.PRO prolog file.
hpglrtl.pltcfg	Large Format	Intended for use when printing large format monochrome sheets. (Raster Capable)
hpglrtl_c.pltcfg	Large Format	Intended for use when printing large format color sheets. (Raster Capable)
hpta3.pro	N/A	Controls postscript image/print output
Hpta4.pro	N/A	Controls postscript image/print output
hptlegal.pro	N/A	Controls postscript image/print output for 8.5" x 14" legal-sized prints
hptleter.pro	N/A	Controls postscript image/print output
hpttbl1.pro	N/A	Controls postscript image/print output for 11" x 17" tabloid-sized prints
Hpttbl2.pro	N/A	Controls postscript image/print output for 11" x 17" tabloid-sized prints
jpeg.pltcfg	N/A	Copy of Bentley's PRINTER.PLT with weights and styles set to CADD standards. Uses FDOT.TBL pen table. Prints output to JPEG file.
postscript.pltcfg	N/A	Creates postscript image file. (Raster Capable) Uses FDOT.TBL pen table and HPTTBL1.PRO prolog file.
postscript36x24.plt	N/A	Creates postscript image file. (Raster Capable) Uses FDOT.TBL pen table and 36x24.PRO prolog file.
pscript.pro	N/A	Controls postscript image/print output
XS.tbl	N/A	Pen table that also enters username, date time, and sheet border path. Used for Cross Section sheets

7.10.2.2 AutoCAD Civil 3D

The Department’s CADD Software supplies several AutoCAD print configuration files to generate prints to the Department’s print standards.

PRINT RESOURCE FILES	DESCRIPTION
FDOT.stb	Controls the color mapping of display objects when printing. Uses black and grey scales when printing.
FDOT-Color.stb	Controls the color mapping of displayed objects when printing. Uses objects color when printing.
FDOT-Page setups.dwt	Contains the named page setups and layout templates commonly used to print/publish or plot FDOT standard size drawings.

7.10.3 Print Borders

For MicroStation printing, the Department’s standard sheet files have a print border embedded for each sheet. The defined search criteria for constituting a print area on a sheet is illustrated in the table below.

Note *PlotBorder_dp* and *ShtPlotBorder_c* levels are the current print border level symbology used in the CADD Software. Typical print border dimension for 11x17 plan sheet prints: 16.5” x 10.6”.

	Border 1	Border 2	Border 3	Border 4	Border 5
Type	Shape	Shape			Shape
Level	PlotBorder_dp	PlotBorderSht	PlotShape	ShtPlotBorder_c	51
Color	BYLEVEL	BYLEVEL	BYLEVEL	BYLEVEL	3

For AutoCAD printing, the Department prints sheets defined in Layout tabs, require no search criteria.

7.10.4 Print Image Files

The PDF print capability provided by both Bentley and Autodesk is the required print format for plans. When PDF files are produced, the user must ensure that no encryption or other PDF security is embedded in the PDF to ensure those print files may be subsequently manipulated (such as rotation to proper viewing orientation, combining into larger multi-page PDF documents, or digitally signing and sealing later in the production process). Note that once a file is digitally signed and sealed, it cannot be manipulated later without invalidating the signatures already applied.

7.10.4.1 Print Image File Naming Convention

MicroStation projects use the application *Sheet Navigator* to extract the sheet and title block data from design files containing sheets. The source design file name and data extracted from those files yields resulting PDF print filenames (and defines the sheet’s relationship to the plans component of the project). Sheet Navigator uses the *SheetInfo.xml* control file to determine the component order for sheets in the plans set, mining their location in the project folder structure and the sheet number prefix. The *Sheetinfo.xml* control file defines the standard search criteria to identify sheets in a project and is stored in the CADD Software \mdlapps\ sub-folder.

AutoCAD Civil 3D projects use a similar tool called *Sheet Set Organizer (SSO)*. SSO also uses the source design file name and data extracted from the sheet layouts in drawings assigned to AutoCAD’s Sheet Set Manager (.dst) files for names and organizes plans components of the project.

PDF files are the required format for producing an electronic image of Plans for Digital Delivery. Multi-sheet PDF files representing Plans and/or Specifications have been ruled acceptable to the Boards of Professional Regulation and may be signed and sealed with single or multiple digital signatures. Provisions were made to resolve any potential ambiguity regarding who is responsible for content by using a Signature Sheet (see the Department’s FDM 303) for each file signed with a Digital Signature. If more than one professional must sign any given file, a Signature Sheet must appear in that Plans Set (or Component Set) to bear the appearance of each Signatory and include a definition of the portions of that Set each Signatory is taking responsibility for. Data producers are no longer required to retain or sign single files representing each individual sheet of a Plans set.

7.10.4.2 Print Image File Naming Format

Applications that support printing, such as *Sheet Set Organizer* implement a file naming scheme for PDF files it manages that removes ambiguity about which sheet the file represents (regardless of the sheet-numbering scheme used in the design file) and supports more complex sheet numbering being expected by some component/disciplines. Digital Delivery does not require individual sheet image files to be delivered, however.

If individual sheets are printed to PDF and retained, they must follow the naming convention shown below:

EX: 01_BB1-1A_keysrc01.extension

 ↓ ↓ ↓

Plans Component Code Sheet # Parent Drawing File Name

Note Image file extension must be Portable Document files (PDF) and Tagged Image Format files (TIF).

- Plans Component Code - [01] The first two numbers represent the Plans Component with zero (0) padding (for file name sorting purposes). The Department's Standard Plans Component codes (as corresponding to the FDM 302.5) are as follows:
 - 01 – Roadway
 - 02 – Signing and Pavement Marking
 - 03 – Signalization
 - 04 – Intelligent Transportation Systems (ITS)
 - 05 – Lighting
 - 06 – Landscape
 - 07 – Architectural
 - 08 – Structures
 - 09 – Toll Facilities
 - 10 – Utility Work by Highway Contractor Agreement Plans
 - 99 – Unknown (used by *Sheet Navigator* if it cannot determine the Plans Component)
- Sheet # - After the Plans Component Code, an underscore (_) is inserted as a separator, followed by the actual sheet number (BB1-1A) appearing in the title block of the sheet.
- Parent Drawing File Name - After the Sheet #, an underscore (_) is inserted as a separator followed by the name of the source design file (keysrc01).

Chapter 8

CADD DELIVERY

8.1 PURPOSE

This chapter establishes the minimum requirements and functions necessary for Florida Department of Transportation (Department's) Computer Aided Design and Drafting (CADD) project review, packaging and delivery process of electronic files included in a CADD project for the Department.

8.2 SCOPE

These CADD Delivery process applies to all projects produced by and for the Department using CADD in addition to the Department's custom criteria, standards and procedures of the various Components/Disciplines within the Department.

8.3 RECEIPT AND ACCEPTANCE OF ELECTRONIC DATA

The Project Manager is responsible for ensuring that the terms of the scope of services of a project for the Department have been met, including the assurance that the Department's Quality Control (QC) requirements were fulfilled during the production process of the electronic data.

➤ *Translation of Files*

The Department requires MicroStation DGN format or AutoCAD DWG format compatible with the Department's currently supported CADD software (see section 7.6 of this document) Exceptions subject to approval by the CADD Office.

The data producer is solely responsible for any translation required for delivery to the Department, including the accuracy of translation of the design files and adherence to the standards and specifications, and the validity of the geometric elements contained in the *CADD Manual*.

➤ *Receipt of Data*

The Project Manager must receive electronic data under a Letter of Transmittal.

➤ *Acceptance*

The Project Manager ensures that the delivery is checked for completeness and meets the terms, conditions and requirements outlined herein. Once the delivery has been determined to be compliant, a Record of Acceptance must be made.

➤ *Validation*

Upon receipt of the delivery media, the Department will validate all digitally signed files.

8.4 PRODUCTION DELIVERABLE FILES

Plans will be divided by plans components. The Department’s Standard Plans Component codes (corresponding to the component order defined in the [FDOT Design Manual \(FDM\)](#) 301 are as follows:

- 01 – Roadway Plans
- 02 – Signing and Pavement Marking Plans
- 03 – Signalization Plans
- 04 – Intelligent Transportation System Plans
- 05 – Lighting Plans
- 06 – Landscaping Plans
- 07 – Architectural Plans
- 08 – Structures Plans
- 09 – Toll Facilities
- 10 – Utility Work by Highway Contractor Agreement Plans

8.4.1 Plans Component PDF Files

Each plan component will be delivered as a separate PDF file. Component file PDFs will have one of the applicable filenames from the table below.

<i>fpid</i> -PLANS-01-ROADWAY.PDF	<i>fpid</i> -PLANS-06-LANDSCAPE.PDF
<i>fpid</i> -PLANS-02-SIGNINGMARKING.PDF	<i>fpid</i> -PLANS-07-ARCHITECTURAL.PDF
<i>fpid</i> -PLANS-03-SIGNALIZATION.PDF	<i>fpid</i> -PLANS-08-STRUCTURES.PDF
<i>fpid</i> -PLANS-04-ITS.PDF	<i>fpid</i> -PLANS-09-TOLLFACILITIES.PDF
<i>fpid</i> -PLANS-05-LIGHTING.PDF	<i>fpid</i> -PLANS-10-UTILITYWORK.PDF

Each Plans Component PDF will contain all sheets in that component set in consecutive order and suitable for inclusion in the plan set. The only exception to this requirement is **Early Work** sheets discussed in Section 8.10.1 of this document.

Each Plans Component PDF will have its own key sheet. If there is more than one professional of record signing a plan component, a signature sheet(s) will be inserted directly behind the key sheet to contain the digital signatures. If a plan component or an early work sheet has only one professional of record signing, then NO signature sheet will accompany that component or Early Work sheet. In the instance of a single signer the digital signature appearance will be placed on the lead sheet in the set in the same location as a physical wet-ink signature and seal would appear; on the key sheet for a component set or the first sheet for an Early Work sheet set.

Produce Plan Component PDF’s and Early Works Sheets in Black and White or Grayscale, unless color PDFs are required. Production of the PDF in color enlarges the file size considerably. All plans sheets must be produced in the PDF in the same reading orientation, preferably Landscape, with the title block displaying at the bottom of the sheet.

Note For strung projects, each “Lead” and “Goes-with” Project dataset and Bid Set data is delivered separately. Each “lead” and “Goes-with” will have its own set of PDFs, *fpid*-CADD.ZIP, etcetera.

8.4.1.1 Early Work Sheets of Plan Sets

Portions, certain Early Works sheets, of a plan set that are delivered early in the project development cycle as per the FDM 130.2.1 and FDM 302.6.1 may be digitally signed at the time of sheet development. In so doing, the professional of record signs said Early Works sheets only once when those sheets are completed, unless subsequent changes are made to the sheets.

Early Works may only be provided in one of four instances; Project Control, Geotechnical Core Borings, Verification of Underground Utilities Survey, or a Tree Survey. Each Early Work set is provided as a separate multi-sheet PDF file. Those PDF files will be named accordingly using the following file naming convention:

Project Control:	<fpid>-PLANS-<component code>-<component>- PC .PDF
Geotechnical Core Borings:	<fpid>-PLANS-<component code>-<component>- COREBORINGS .PDF
Underground Utilities:	<fpid>-PLANS-<component code>-<component>- VERIFIEDUTILITIES .PDF
Tree Survey:	<fpid>-PLANS-<component code>-<component>- TREESURVEY .PDF

Typically, these are delivered with the roadway component. An example where the primary plans component is roadway (01-ROADWAY), early works are delivered is shown in the following table:

<i>fpid</i> -PLANS-01-ROADWAY- PC .PDF
<i>fpid</i> -PLANS-01-ROADWAY- COREBORINGS .PDF
<i>fpid</i> -PLANS-01-ROADWAY- VERIFIEDUTILITIES .PDF
<i>fpid</i> -PLANS-01-ROADWAY- TREESURVEY .PDF

As another example, if the primary plans component is structures (08-STRUCTURES), then the early work sheets will be named as shown in the following table:

<i>fpid</i> -PLANS-08-STRUCTURES- PC .PDF
<i>fpid</i> -PLANS-08-STRUCTURES- COREBORINGS .PDF
<i>fpid</i> -PLANS-08-STRUCTURES- VERIFIEDUTILITIES .PDF
<i>fpid</i> -PLANS-08-STRUCTURES- TREESURVEY .PDF

Likewise, with other plans components.

8.4.1.2 Plans Component PDF Deviation

In the rare event that the complexity and sheer size of a project dictates that the project be further subdivided than by the means provided by the above filenames, an approval may be granted as follows:

- A request to deviate from the required process must be made in writing by the District Plans, Specification & Estimates Engineer to the Central Office, Program Management Office.
- The request must be specific regarding the proposed file structure and delivery method that will be used for the project in question.
- The request should be made as early in the design phase as practical, but no later than Phase III Plans Submittal.
- Central Office, Program Management Office will grant approval if the need for deviation is demonstrated and the proposed process is acceptable.

Note An approval granted on one project may not be construed as to extend to other projects regardless of similar circumstances. Approvals are granted on a project by project basis.

8.4.2 3D Model PDF Files

All projects modeled in 3D will deliver a separate 3D PDF file. Project file PDFs will have the file name as shown below.

- *fpid-3DMODEL.PDF*

8.4.3 Specifications PDF Files

- *fpid-SPECS.PDF* – Specifications PDF format file delivered separate from the project folder structure. This file is signed and sealed with Digital Signature.
- *fpid-SPECS-SUPP##.PDF* – Supplemental Specifications file signed and sealed with Digital Signature.

Note Refer to Chapter 5.7.1.3, Specifications Standards - Technical Special Provisions (TSPs) in the Bid Set.

8.4.4 CADD ZIP Files

An archive of the Project folder structure containing the CADD files (Native DGN's/DWG's of the platform used to design the project) and supporting data files from which the final plans were developed will be delivered in the format of a ZIP file (*fpid-CADD.ZIP*). This ZIP file is not signed and sealed and is delivered as a separate file outside of the project folder structure.

The designer must determine which files should be included inside the *fpid-CADD.ZIP* file to support the plans and facilitate the contractor constructing the project. The folder structure inside *fpid-CADD.ZIP* closely resembles the Project Folder structure (as a sub-set), where files found in *fpid-CADD.ZIP* would be found at the same path as in the project Folder structure.

As a minimum, the *fpid-CADD.ZIP* should include:

- Native CADD Files (2D and 3D) (*DGNs, DWGs, etcetera*)
- Engineering Data Files (*described later in this chapter and prior chapters*)
- Summary of Quantity Sheet Backup Drawings (*includes data such as, shapes and area identifications*)
- 3D Deliverable Files (*an exported selection of files from the Project specifically for the contractor*)

DO NOT include the following files (and their variants) in the *fpid-CADD.ZIP*:

- *fpid-PLANS-<component code>-<component>.PDF*
- *fpid-PLANS-<component code>-<component>-REV##.PDF*
- *fpid-SPECS[-].PDF*
- *fpid-SPECS-SUPP##.PDF*

Note Because *fpid-CADD.ZIP* does not represent the entire Digital Delivery, certain tools, such as *FileChecker*, should not be run against only the contents within *fpid-CADD.ZIP*. *FileChecker* should only be run against the full Project folder structure containing all Digital Delivery.

8.4.4.1 Engineering Data

Final Project design documentation (like pavement design report, typical section package, exceptions, variations, architectural calculations, drainage calculations, lighting design analysis report, permits, geotechnical reports, structural calculations, toll facility calculations, utility schedules, etcetera) will be delivered per FDM 111.7 as directed by the [Roadway Design Memorandum 18-02 - Project Documentation](#).

➤ Structures Engineering Data

Under the project \struct\ folder, create separate sub-folders for each bridge and/or structure in the project. Name these sub-folders using the sheet prefix and bridge numbers (when applicable) and locate the design files for each bridge under these sub-folders. (e.g...\struct\B\; \struct\B1-#####)

Under each bridge and/or structure sub-folder, create an \eng_data\ sub-folder for the Engineering Data related to the design of the project. (e.g...\struct\B\eng_data\; \struct\B1-#####\eng_data\). Computer input and output files include files used for all aspects of bridge, retaining wall, and/or miscellaneous structures design. These include, but are not limited to, files generated from the following computer programs:

- FDOT Structural Software
- GTStrudl
- STADD
- RISA
- Mathcad Spreadsheets
- Excel Spreadsheets
- FBPIer
- LEAP Software
- BD2
- MDX
- BC
- Adapt

Under each of the \eng_data\ sub-folders for each bridge and/or structure in the project, create subfolders for the applicable programs with two sub-folders: \PDF\ and \Native\. Place the appropriate input and output files in each sub-folder. Only sign and seal these PDF files when required by Contract.

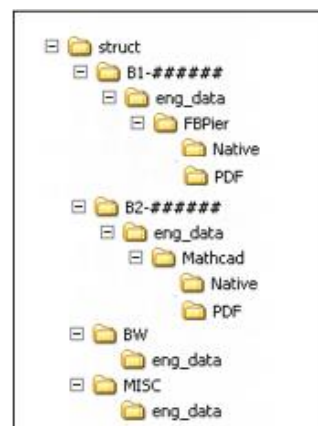

8.4.5 Calculations Folder - Plan Summary Boxes and Quantity Files

FDOT requires that all quantities be documented in Plan Summary Boxes located on the Summary of Quantity sheets (SUMQRD## or B#SumofQuantities##). Computation Books are no longer required. Do NOT mix and match the old summary boxes with the new ones in the same plan set. The Plan Summary Boxes and supporting quantity calculations files must be delivered according to the guidelines and formats defined by [Florida Design Manual](#), [Basis of Estimates Manual](#), and the [Structures Manual](#), along with verbiage stated herein of this document.

Documentation posted defines the following:

➤ Plan Set Location

- Roadway – Summary of Quantities sheets are to be placed after the numbered Plan Sheets.
- Structures – Directly after the Index/Key Sheet (or after the Summary of Pay Items if the Structures Plans are stand-alone with no Roadway component.)

➤ File Name

- Roadway – SUMQRD
- Structures – B#SumofQuantities*

➤ Sheet Prefix

FDOT uses Sheet Prefixes to keep separate for re-numbering.

- Roadway – SQ-
- Structures – BQ#-

Note Each Bridge will have a separate Summary of Structure Quantities sheet(s) numbered as: BQ#-#. For Example, if there are general bridge Pay Items (Mobilization MOT, etc.), the sheet will be the first Summary of Structure Quantities sheet numbered BQ-1. The Summary of Structure Quantities for Bridge 1 will follow with sheet numbers BQ1-1, BQ1-2, etc.; followed by Bridge 2 with sheet numbers BQ2-1, BQ2-2, etc.

The QTDSRD is the file used to create the shapes required to calculate area quantities. FDOT recommends the use of models within this file instead of creating a separate DGN file for each pay item and its shapes. Each model is named using the pay item number, TRNS*port format or with the use of dashes. Each model should have the Alignment, Design, and TOPO files referenced. These references assist with the creation of the shapes needed as well as to provide helpful information for Construction personnel who need to access this file.

FDOT controls Summary Box formatting through Excel spreadsheet files and managed within the Project through the Linked Data Manager (LDM) application. All Summary Box Excel files and any other quantity related files (*PDF or output from other programs*) are stored in the Project Directory in the \calculations\ sub-folder.

Note Roadway and Structures subdirectories within the calculations folder may be used to help organize this directory. This is optional.

➤ ***FDOT-delivered Summary Box templates for use with LDM in both automated and manual formats:***

Barrier Walls	Pedestrian Longitudinal Channeling Devices
Curb and Traffic Separators	Permanent Crash Cushions
Ditch Pavement	Permanent Crash Cushions 2019
Driveways	Railing
Edgedrain	Sidewalk
Erosion Control	Temporary Crash Cushions
Fencing	Temporary Driveways
French Drain	Trench Drain
Guardrail	Turf and Prepared Soil
Mailboxes	Turnouts
Miscellaneous Asphalt	Underdrain
Pavement	Utility Adjustments

➤ ***FDOT-delivered Summary Box templates for use with LDM in manual format only:***

- Box Culverts
- Clearing and Grubbing and Removal Items
- Earthwork
- General Items
- Geotechnical Items
- Litter Removal and Mowing
- Lump Sum Items
- Miscellaneous Drainage
- Monitor Existing Structures
- Pedestrian Special Detours
- Side Drain and Mitered End Sections
- Side Drains and Mitered End Section with Flowlines
- Structures Quantities
- Temporary Traffic Control Plan Items
- Temporary Highway Lighting
- Temporary Signalization and Detection
- Traffic Monitoring Site Items
- Walls

See the [FDOT Automated Quantities Training Guide](#) for more instructional information.

8.4.6 3D Deliverables Folder - Automated Machine Guidance in Construction

The project CADD.zip file includes a 3DDeliverables folder. This folder includes files provided to the contractor for Automated Machine Guidance (AMG) in Construction. The Department has adopted basic CADD and LandXML formats as the standard for delivery. These are typically not application files, e.g. GEOPAK, OpenRoads or Civil3D. Contractors have requested the Department isolate the CADD and LandXML files they would typically need with a consistent name scheme.

Note All 3D Deliverable files should be set to 'READ ONLY'. For more information on creating these files see Chapter 10 of *FDOT Roadway Design and 3D Modeling* training guide:

[FDOT Roadway Design and 3D Modeling Training Guide](#)

For the supporting documentation on 3D Deliverable files for Automated Machine Guidance see

[FDOT 3D Deliverables Support Resource](#)

➤ **3D Deliverables Supporting AMG for 3D Projects**

The following table describes 3D deliverable file(s) provided for Construction. Each file should have the entire Project in one contiguous surface/design, with the exception of the alignment files and files too large to export.

3D DELIVERABLES SUPPORTING AMG for 3D PROJECTS (Store in project folder: 3DDeliverables)		
Category	File Name	Description
Design Alignments and Profiles	AMG-ALGN##.xml	All Alignments and Profiles exported from the \Roadway\ALGNRD, PROF or model files and \Roadway\DSGNRD or CORRRD files in LandXML format.
2D Proposed Planimetrics Design	AMG-2DSGN##.dwg/dgn	2D proposed Roadway design exported from the \Roadway\DSGNRD file. (Production of this file for construction is at the designer's discretion.)
	AMG-2DRPR##.dwg/dgn	2D proposed Drainage design exported from the \Roadway\DRPRRD file. (Production of this file for construction is at the designer's discretion.)
	AMG-2PDPL##.dwg/dgn	2D proposed Pond design exported from the \Roadway\PDPLRD file. (Production of this file for construction is at the designer's discretion.)
2D Existing Survey <i>Note: These are being considered to merge into a single survey Planimetrics file.</i>	AMG-2TOPO##.dwg/dgn	2D existing Topography exported from the \Survey\TOPORD file. (Production of this file for construction is at the designer's discretion.)
	AMG-2DREX##.dwg/dgn	2D existing Drainage exported from the \Survey\DREXRD file. (Production of this file for construction is at the designer's discretion.)
	AMG-2UTEX##.dwg/dgn	2D existing Utilities exported from the \Survey\UTEXRD file. (Production of this file for construction is at the designer's discretion.)
3D Existing Survey <i>Note: Single survey Planimetrics file.</i>	AMG-3SURFACEEX##.xml	3D existing terrain surface to be exported from the \Survey\GDTMRD file as LandXML format. (Production of this file for construction is at the designer's discretion. This file will be produced if the 3D Existing Surface dwg/dgn file(s) are not produced.)
3D Proposed Surfaces	AMG-3SURFACEPR##.xml	3D proposed finished (top) surface to be exported as LandXML format from the \Roadway\MODLRD file.
	AMG-3SURFACEEW##.xml	3D proposed finished (bottom) surface to be exported as LandXML format from the \Roadway\MODLRD file. This file will be used to generate surface to surface earthwork volumes.
3D Proposed Break Lines	AMG-3DSGN##.dwg/dgn	3D proposed Roadway break lines exported from the 3D model.

➤ **Corridor Frequency Interval Spacing for 3D Design**

Design software used by the Department samples the 3D corridor models at user defined intervals to create surfaces. To ensure reasonable fidelity in surface models for AMG operations, maximum sampling intervals are described below:

Note The designer may choose to sample more frequently to more accurately represent his design model, although, there is a limiting return (larger files and poorer computer performance) if sampling too frequently. Designers must balance these competing consequences when deciding appropriate sampling frequency for their projects.

Maximum Corridor Frequency Interval Spacing (Feet)			
Context Classification	Tangent	Curve	Intersection
C1	20	10	5
C2	20	10	5
C2T	10	5	2
C3R	15	5	2
C3C	20	10	5
C4	15	5	2
C5	10	5	2
C6	10	5	2
Shared Use Path	10	5	1
Interstate	25	15	n/a
Ramps	20	10	5
Gore	5	2	n/a

The above maximum spacings would also apply to 3D elements built without corridors; such as, detail modeling for radius returns. Additional sampling intervals will normally be needed at critical regions in horizontal geometry stations (i.e. PC’s, PT’s), superelevation transition locations, and at profile geometry critical locations (i.e. PVC’s, PVT’s, and profile high/low points). The designer must also add sampling at other critical regions along the corridor, such as changes of typical section, critical drainage locations, approach and interior to intersections, and median crossovers.

The corridor models used in design are to be submitted intact in the native CADD file format (MODLRD##.dwg/dgn) as part of the CADD.zip file to ensure that reviewers can verify the correct interval spacing was used on the project.

8.4.7 Merging External Project Files

Files must be merged into the main Project folder structure prior to the project delivery. These include CADD system dependency files, and files provided from outside sources, such as those produced by sub-consultants.

➤ **CADD System Dependency Files:**

Certain CADD references might reside external to the project folder during the production phase. Before delivery to the Department, these files must be placed in the appropriate locations within the Project folder structure. It is strongly recommended that these files be included in the Project folder structure early on in project development and verified that referencing functions work properly.

Note Reference files must also be attached without the “save full path” option checked and should be located by their relative paths from the root of the Project folder.

For printing purposes, any user created custom line style/linetype, font resource, and cell/block library files used for the project must be included with the project in the sub-folder \symb\). In addition, any external design files that are referenced, such as sheet border files, must be copied to the project folder. This allows the view or recreation of prints matching the original delivery for future customers of the data.

Note The designer does not need to include the Department’s standard CADD resources delivered in the Department’s CADD Software (either MicroStation or AutoCAD resources). However, the Department’s CADD Software version information must be provided in the Project Journal.

➤ **Files from Outside Sources:**

Files that come from an outside source include files produced by a sub-consultant. Files from sub-consultants must be delivered to the primary consultant, or the Department's designer, following the same requirements for Delivery.

➤ **Merging Previously Digitally Signed Documents:**

Once a document is signed using a digital certificate, the document is valid when it is completely unaltered. Merging two or more documents together, even if those documents are signed and completely valid independently, produce a completely new document - thus an altered document. When merging previously signed documents, the PDF editing software will strip off all digital signatures that have been applied.

In situations where it is necessary to merge previously digitally signed documents, retain the original signed documents from which the merged document is produced. If it is necessary for the merged document to be signed, then it must be signed by the original signatories or their successors.

8.4.8 Reviewing the Project

All Department Project deliveries must be provided to the Department's Project Manager, unless an alternate agreement is reached, along with a Compliance Certification Checklist (or similar document). A basic [Compliance Certification Checklist](#), sample found in Section 1.10.2 of this document, may be employed to help the data producer consider critical items in their QC review for delivery.

Note Department's Districts may use a more comprehensive Compliance Certification Checklist in their QA process than the example in this document. The Department prefers this, or similar documentation of QC compliance be submitted digitally and included in the \admin\ or \data\ project sub-folders.

The Department's CADD Software provides tools (including *QC Inspector* and *FileChecker*) to help ensure quality control which helps enable a successful review. One must use due diligence to make sure all delivery requirements are met. It is the responsibility of the producer to perform a thorough review. This procedure does not prescribe every potential item that might need to be checked.

➤ **Example: Some items to review would include:**

- Take care to look for missing sheets, gaps in the sheet numbering, duplicate sheet numbering, etcetera. Check for misspellings in sheet borders and other grammatical errors.
- Take care to find multiple files in the Project folder structure with the same file name, but different content, which must be resolved. Likewise, find files with the same content, but different filenames (which could occur as with the case of the files beginning with "AMG..." as described previously).
- Make certain the Professional of Record Note appears on plan sheets indicating the source of the official record.
- Ascertain whether the Component PDF's and Early Works Sheets contains all sheets, in a properly indexed order, and is scaled and rotated properly.
- Validate the digital signatures of signed files.
- Confirm that the Project Journal(s) are complete and accurate.

8.4.9 Sign and Seal Project Files

The Department supports the use of digital signature certificates for the signing and sealing of documents for digital delivery. Use of digital certificates for this purpose is in accordance with [Florida Statute \(F.S.\) 668.003](#) and [Florida Administrative Code \(F.A.C.\)](#) as it applies to various professionals.

Please see [FDOT Design Manual \(FDM\) 130.2.1](#) for a list of professionals and corresponding F.A.C. Codes, as well as further guidelines for signing and sealing documents using digital signature certificates.

The Department's Office of Information Systems maintains a list of third-party Department-approved digital certificate authorities from which certificates may be acquired. Certificates must adhere to the National Institute of Standards and Technology Level of Assurance 3 (LOA3) according to Department policy. This list is available at this link: <https://www.fdot.gov/it/approveddigitalcertificateauthorities.shtm>

Digital certificates can be used to sign files in PDF, DGN, DWG, DOCX, and XLSX format in their native applications. The Department has also created an FDOT XML Signing Tool for signing XML documents (such as LandXML) using digital certificates.

8.4.10 Legacy Electronic Signature Projects

Provenance and uninterrupted legal record of the project data must occur, whether it be by product or management practice. Therefore, it is important that both the data producer and the Department make a sensible effort to ensure the documents supporting the digital signing and sealing of files by a professional signatory and the securing of the delivery be preserved in a manner consistent with those responsibilities under the rules of the Boards of Professional Regulation in Florida.

For projects that were once performed under the old Electronic Delivery process, the Department will maintain the paper copies of retention Signature and Manifest documents until it is determined how these records may be preserved in other media that meets the requirements of the Florida Department of Business and Professional Regulation.

8.4.11 Media Requirements for Delivery

All electronic projects submitted to the Department must be on write protected physical media (CD-ROM or DVD-ROM) unless otherwise approved by the Department's District *Plans, Specifications & Estimates* (PS&E) Manager or Program Management Administrator. Use only 1st Class archival quality writable media.

If the project is too large to fit on one CD/DVD, then the process for delivery to the Department's must be reviewed with the Department's Project Manager before splitting the project on multiple CD/DVDs or choosing an alternate media. If approved by the appropriate authority other means of transmission of data, such as File Transfer Protocol (ftp) or File Transfer Appliance (FTA) may be used.

➤ **All Physical Project Media Must have a Project Identification Label with the Following:**

- Financial Project ID Number of Project
- Project Description (including County and State Road numbers, local road designation)
- Firm or District Performing the Work
- Name of the Department and Consultant Project Manager(s)
- Creation Date of the Media
- Disk (#) of (Total #) (if multiple ROMs are needed)
- Delivery Type Label (Project CD, Bid CD, etcetera)
- Anticipated Letting Date for the Project

With the increase of storage capacity and more cost efficiency of USB removable memory drives (thumb drives), use of this media will grow in popularity for the Department’s Deliveries.

➤ ***If memory drives are used:***

- The physical drive must be labeled with the Project Identification (fpid) number and District as a minimum.
- A text file must be included on the media’s root folder (not Project folder) containing the Project Identification label information and Transmittal Letter containing the same.

8.4.12 Compliance Certification Checklist

All Department Project deliveries must be provided to the Department’s Project Manager, unless an alternate agreement is reached, along with a Compliance Certification Checklist (or similar document).

Note Department’s Districts may use a more comprehensive form in their QA process than the following example. The Department prefers this, or similar documentation of QC compliance be submitted digitally and included in the \admin\ or \data\ project sub-folders.

All electronic data submittals are to be transmitted to the Department’s Project Manager. At a minimum, the questions provided in the [sample form found in Section 1.10](#) of this document must be addressed before submittal, and this (or a similar checklist) will be given to the Project Manager along with the submittal.

8.5 SPECIFICATIONS

Specifications must be prepared in accordance with the Program Management policies and procedures. Statewide implemented specifications files are distributed by the State Specifications Office through the District Specifications Offices.

For Digital Delivery Bid Sets, the Specification files are copied from the \specs\ sub-folder structure for delivery. Specification file naming convention for Digital Delivery submittals is: *fpid-SPECS[-].pdf*:

- ❖ ***fpid*** = full (11 digit) Financial Project Identification Number without dashes.
 - ❖ ***SPECS*** = item description
 - ❖ ***[-]*** = any additional naming specific to the project (optional)
- Supplement file naming convention for submittals is: *fpid-SPECS-SUPP##[-].pdf*, where:
- ❖ ***fpid*** = full (11 digit) Financial Project Identification Number without dashes,
 - ❖ ***SPECS*** = item description
 - ❖ ***SUPP*** = Identifier
 - ❖ ***##*** = sequential numbering of the supplements: 01, 02, 03, etcetera
 - ❖ ***[-]*** = any additional naming specific to the project (optional)
 - ❖ ***BOE#*** = Bases of Estimates – Pay Item number
 - ❖ ***TSP*** = Technical Special Provision

<i>Original Delivery</i>	<i>Supplement1</i>	<i>Supplement2</i>
<i>fpid-SPECS[-].PDF</i>	<i>fpid-SPECS-SUPP01[-].PDF</i>	<i>fpid-SPECS-SUPP02[-].PDF</i>
<i>fpid-SPECS-TSP[BOE#]([-)].PDF</i>	<i>fpid-SPECS-TSP[BOE#]-SUPP01[-].PDF</i>	<i>fpid-SPECS-TSP[BOE#]-SUPP02[-].PDF</i>

For Example: Begin with the *FPID* number, then the item description (*SPECS*), then supplement number (*SUPP##*), and finally any naming *[-]* specific to the project (optional).

This file naming convention allows project files to collate as sorted and combined in a single folder. Text, numbers and dashes are allowed. Characters that interfere with operating system path specifications or XML paths must be excluded, such as underline and spaces and (/ \ . : , < & # >).

➤ **Technical Special Provisions**

When the use of a Technical Special Provision (TSP) is authorized by the District Specifications Office, the PDF of the TSP file(s) is individually signed and sealed and becomes part of the overall project's Specifications package.

For Digital Delivery, certificate based Digital Signature must be used.

The TSP must include the electronic statement incorporated on the TSP cover page. When a TSP is manually signed and sealed, it must be scanned in grey scale for seal visibility and no electronic statement is needed.

When TSPs are combined into the overall Specification package, the Signatory(s) of the TSPs do not have to re-sign the combined documents. Add the image of the seal to the cover page of each TSP. The individual files for each TSP must be digitally signed and sealed.

➤ **File Structure (Specs Only Projects)**

- Specifications Folder Structure
- Supplemental Specifications Folder Structure
- Technical Special Provisions (TSP)

Note If a TSP is applicable to the project, then the folder for TSP(s) would apply to both the Project CD and Bid CD data set. Multiple TSP files may exist in the delivery.

The Specification Package is delivered as fpid-SPECS.pdf. Subsequent TSPs are delivered as fpid-SPECS-TSP[BOE#].pdf as shown in Chapter 5.8.

1. Create the project folder using all eleven digits of *fpid* Number. (i.e., 12345678900).
2. Inside the created (project) \FPID\ folder. This is where the Specifications package file (*fpid-SPECS[-].pdf*) is placed.
3. For Supplements, continue to use the ORIGINAL \FPID\ folder created in Step 1.
4. For Supplements. This is where the Supplement package file (*fpid-SPECS-SUPP##[-].pdf*) is placed.
5. Use digital signature to sign and seal the Supplement package file (*fpid-SPECS-SUPP##[-].pdf*).

Note **DO NOT** re-submit the entire Specification package for a Supplemental.

Example of a Specifications Only Package Folder Structure

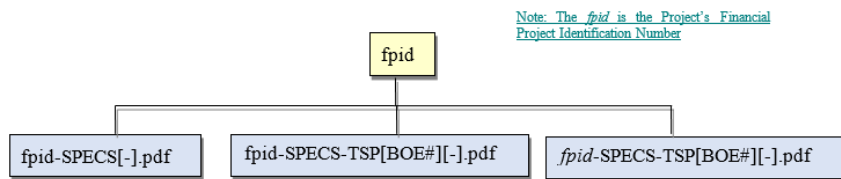

Example of a Supplemental Specifications Only Package Folder Structure

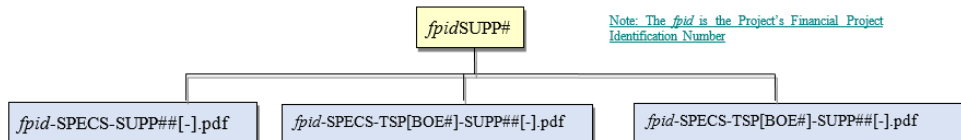

8.6 FINAL PLANS OFFICE

Final Plans is a division of the Program Management Office responsible within the Department for preparing and posting project deliverables for contract letting documents. This includes the packaging of all CADD data for the **Plans, Specifications and Estimates (PS&E) Submittal** contained in a project.

Final Plans involves the review and acceptance of a Delivery and making that Delivery available to the Department's internal services for posting. Functions include: receipt and authentication of delivery media and placement of project data into systems for general use.

Upon receipt of the secured Delivery package and the accompanying documents, the Compliance Certification Checklist(s) must also be reviewed for completion and the signed files must be opened and authenticated.

Note Following the requirements within this manual does not guarantee an acceptable work product, as this procedure does not address the quality of the engineering or survey work performed.

Once the Delivery is accepted, the electronic project will be imported into the Department's file management systems for subsequent use. (*See FDM 133 Retention of Electronic Documents*). Various stakeholders such as Construction and Maintenance have access to submittals via the Department's file management system

➤ **Contract Packaging**

Final Plans must coordinate regarding contract packaging requirements for a delivery for a letting found in the [FDOT Design Manual](#).

The Contract Package is made available to contractors for bidding during the advertisement period and generally includes:

- Plans Component PDF file(s) representing the Plans Set
- Specifications PDF file(s)
- Archival native CADD ZIP file (including Automated Machine Guidance files)

➤ **Publication and Distribution**

Final Plans is responsible for publication and distribution of electronic data in accordance with procedures or requests, including but not limited to publishing electronic data to different media.

➤ **Archive and Security of Data**

Final Plans must insure that prescribed safeguards for the data have been met and the archival package for data includes all electronic data available for a project. The data must be preserved where it can be retrieved at future dates, meeting records retention standards set for such data.

Please use the hyperlink below for additional information regarding the Department's Plans, Specifications and Estimates (PS&E).

[FDOT Plans, Specifications and Estimates \(PS&E\)](#)

8.7 REVISIONS

Revisions to the Department's projects require the files that have changed since the previous delivery. Revision files use the original file name with a "-REV##" suffix after the file type; CADD, PLANS, SPECS.

As an example, the first revision to a Roadway Component will be named as follows:

fpid-PLANS -01-ROADWAY-REV01.PDF

The first revision to Project Control, Early Work sheets as part of a Roadway Component, for example, will be named as follows:

fpid-PLANS -01-ROADWAY-PNC-REV01.PDF

A second revision will have a "REV02" suffix, third revision will have a "REV03" suffix, and so forth.

The designer must deliver:

- ❖ Ensure the Department has a complete copy of the original Delivery:
 - *The native CADD files delivery fpid-CADD.ZIP*
 - *The plan component PDF files fpid-PLANS-[component code-component].PDF*
 - *The initial specifications document fpid-SPECS.PDF*
 - *The initial Technical Special Provisions fpid-SPECS-TSP[BOE#].PDF*
- ❖ The Revision: (The Bid Set must only contain the changed files in the revision/supplement.)
 - *fpid-CADD-REV01.ZIP*
 - *fpid-PLANS-[component code-component]REV01.PDF*
 - *fpid-SPECS-SUPP01.PDF*
 - *fpid-SPECS-TSP[BOE#]-SUPP01.PDF.*
- ❖ The complete Project folder structure with all contemporary files included.

8.8 RE-LET PROJECTS AND ROLL BACK REVISIONS

In rare cases, the Department must Re-Let a project. If no revisions have occurred to the project set for Re-Letting, the Department will simply re-advertise and Let the project with the submitted Project CD or Bid Set CD data. However, if a revision has been applied to the project set for Re-Letting, then the revision is no longer relevant. The Re-Let project is essentially an original letting all over again. In this case, the data producer may be asked to Roll Back the revision indexing as if the Delivery were an original Delivery. This could involve updating the plan sheets to remove the revision enumerations. The changes to plans that were once identified as a revision are now considered simply a plan change.

8.9 STRUNG PROJECTS

Digital Delivery requires that each "Lead" and "Goes-with" project to be delivered as separate datasets under their own *fpid*, and never combined or intermingled in their respective project folder structures. Strung projects are delivered in separate folders just as individual projects in the above procedure. These ARE NOT combined under a folder with an ETC suffix.

8.10 AS-BUILT PROJECTS

As-Built Project CD shall include all files in the latest native version of CADD software the drawings were produced in along with a PDF set of prints and a complete set in AutoCAD DWG files.

Example: If the project CD was produced using Revit, the submittal will include all files in Revit RVT, AutoCAD DWG and a complete set of PDF files.

8.11 DESIGN BUILD PROJECTS

The Scope of Services between the designer and contractor defines the deliverables to one another. If either party is bound by agreement to make a delivery of data to the Department, then the guidance for Digital Delivery should be applied.

8.12 PROJECT STORAGE AND ARCHIVAL

FDOT uses Autodesk Vault software to manage and store files used for the design of transportation projects. All CADD drawing files and related engineering documentation for each project are stored within the Vault system organized by folders named to match the Financial Project Number. Each district maintains a “production” Vault for active projects where different design component/disciplines have corresponding read/write permissions for component/discipline folders. Each district also maintains a “archive” Vault to store projects once they have been completed and delivered, this Vault is “read only” for all users.

Construction has many Publications that are utilized by both Department staff and external customers. These include manuals, forms, procedures, and reports. Please use the hyperlink below to view the most recent versions of these resources.

<http://www.fdot.gov/construction/PublicationsMain.shtm>

Chapter 9

QUALITY ASSURANCE AND QUALITY CONTROL

9.1 PURPOSE

This section establishes the basis for Quality Assurance (QA) monitoring of the Florida Department of Transportation (Department) District Computer Aided Design and Drafting (CADD) functions, including the areas of responsibility, frequency of monitoring and reporting methods.

Offices under the direction of the Department's Chief Engineer are responsible for determining the critical QA requirements for their functional areas and develop plans to monitor those requirements. The Production Support CADD Office defines the critical Quality requirements for deliverables in this manual. These include standard file formats and components for data delivery, adherence to a standard Project folder structure, file naming conventions and CADD Standards for electronic files. CADD also establishes a QA monitoring plan for CADD to facilitate compliance with these deliverable requirements.

Each District office function has the responsibility of monitoring the implementation of policies, procedures and standards established for their respective processes. This manual applies to all CADD functions and will be monitored.

9.2 AUTHORITY

Florida Statutes (F.S.), Title IV, Chapter 20, Section 20.23(3)(a) states that the Department must ensure quality and monitor implementation of policies and procedures.

Quality Assurance and Quality Control Policy, Topic No. 001-260-001 states that it is the policy of the Department to use a systematic but flexible approach to QA and Quality Control (QC) to monitor work processes to implement laws, rules, procedures, policies and standards. This is intended to ensure compliance and quality performance by the Central Office and District units responsible for the delivery of transportation products, services and information.

9.3 PRODUCTION ACCOUNTABILITY

Production units must follow the procedures for preparing plans, maps and models. Each district must establish quality compliance indicators for all projects and monitor performance and compliance using those indicators. Consultants are agents of the Department and are responsible for the quality of projects they prepare. They must comply with the Department's *CADD Manual* and must perform QC activities to ensure the completeness and accuracy of services performed for the Department.

9.3.1 Quality Control

Each district must maintain an established review process to determine and report the quality and compliance levels of project data. Each district is also responsible for having a management plan for quality control of the Delivery with the expectation that quality control plans comply with this manual.

The Department provides tools to help ensure the creation of a standard Project folder structure, standard filenames and the standard level symbology for all design files. The Department provides QC software to check a design file's adherence to the Department's level-symbology standards at any time during the production phase of the project. Tools are listed below:

FileChecker – Provides reporting for certain portions of the Delivery compliance with standards and business rules.

QC Software – The *QC Inspector* contains tools used to check, correct and report the compliancy of elements within any design file against the Department's CADD Standards. All checking and reporting is performed in real time and the results recorded into reporting documents that are saved to the current active project.

9.3.1.1 Quality Control of Corridor Models and Extracted Surface

3D Design for roadways is intended to produce output of a corridor model from which surfaces may be derived. It is incumbent upon the designer to verify these corridor and surface models representing their design intent, so the resulting models and data derived from them can be relied upon. The previous Section describes maximum sampling intervals for developing corridor models based upon facility and design speed; however more frequent sampling may be required to achieve the desired accuracy or resolution of the 3D model. There are several methods that can be used to check the "quality" of the proposed models and surfaces, and many checks rely upon visualization techniques on the data. These can include:

- Visual inspection through examining the models/surfaces using 3D perspective views and orbits. The Z (elevation) can sometimes be exaggerated during these operations to show discontinuity in the surfaces where problems might lie.
- Visual inspection through examining the models/surfaces using drive through and fly through view manipulations and animations. Other simulation techniques can be employed also.
- Visual inspection of the model using Virtual Reality or Augmented Reality to fly through and view the model in a simulated reality.
- Contouring the surface models and examining the resulting contours.
- Surface display by means of rendered/stylized surfaces (and solids). In some software these views can be thematically colored and or shaded, indicating slope or elevation change.
- Cross Section and Profile extraction – Do these extractions corroborate the contract plans? Equally, are plan sections and profiles contemporary with the model?
- "Rain Drop" analysis to see where water distributed over a surface would flow or accumulate if the surface were treated as if it were impervious and perfectly smooth.
- Representing elements in either wire-frame or as solid bodies, where they can be examined for conflict or "interference" relative to neighboring or crossing elements.
- Use of temporary dimensioning and labels to test the model's elements for appropriate length, elevation, slope, etcetera.
- Design geometrics can also be checked against the defined tables found in the *FDOT Design Manual (FDM)* for sight distance, K-value, rate of curvature, cross slope, curve widening, etc.
- Visualization can be embellished with applications of various rendering materials, lighting, and shading.
- Visual inspection of the XML 3D Deliverables using the LandXMLVisualizer provided with the FDOT software.
- Visual inspection and earthwork quantity corroboration using Trimble Business Center or equivalent construction software.
- [QC Review for 3D Engineering Models Webinar](#)

9.4 QUALITY ASSURANCE PLAN

The QA Plan identifies the critical areas of CADD to be monitored, critical requirements and the criteria to measure process compliance. Compliance indicators will be used by the CADD Office to determine how well the process is performing.

The monitoring plan provides the method for monitoring CADD processes, the frequency of team visits, the method for reporting and sharing monitored results with the districts, and the method for tracking and eliminating non-compliance issues.

The plan covers the major delivery requirements in this manual, but users are reminded that quality CADD production is the result of performing many individual CADD activities correctly and in accordance with the current criteria and standards.

Note The *CADD Quality Assurance Monitoring Plan* is published on the Department's SharePoint or available on request per Department policy for internal use only.

9.5 QUALITY ASSURANCE REVIEWS (QARs)

CADD QARs will be conducted per Department requirements. The CADD Office will report the results of these reviews to the District Secretary and to FHWA. Measuring compliance with the critical requirements as outlined in the *CADD Quality Assurance* will be the purpose of these reviews.

The CADD QARs are to monitor the districts' individual QC Plans. QA also encourages continuous improvement through sharing both ideas and improved technology advances.

Districts will be expected to ensure that their own Process Management Plan is in place for Delivery and that projects comply with that process.

The QAR of the Districts' will be conducted periodically following the CADD QA monitoring plan. Reports are distributed to the District Secretaries and other affected offices.